

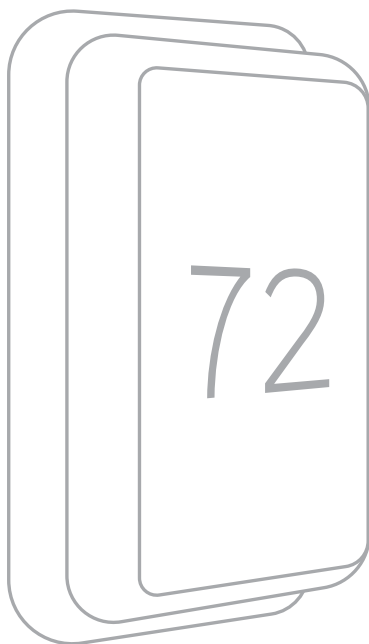

T9 THERMOSTAT

Installation Guide



Included in your box:

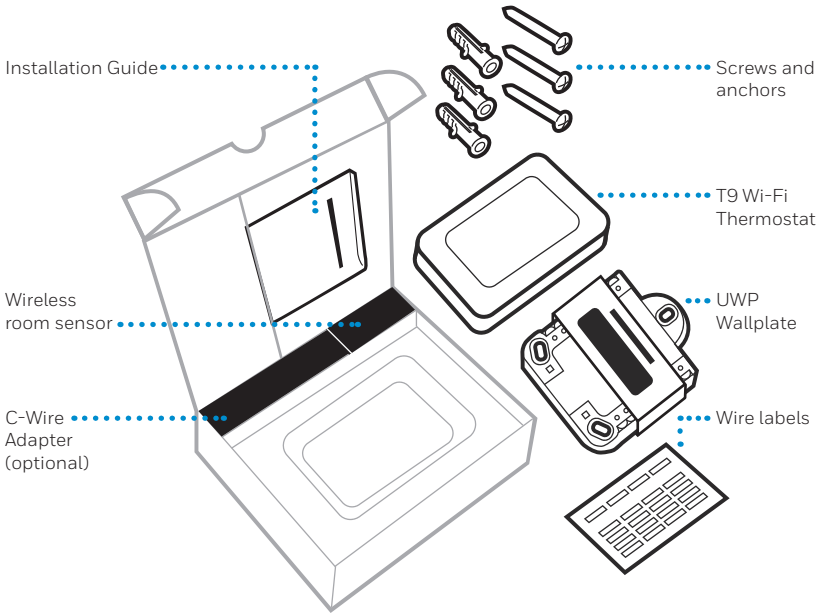

Tools you will need:



Phillips screwdriver



Small flat head screwdriver



Pencil

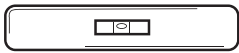

Level



Home Wi-Fi Password

You may need:

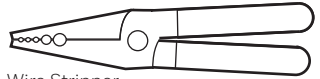

Wire Stripper

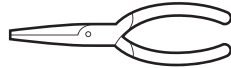

Needle-nose pliers

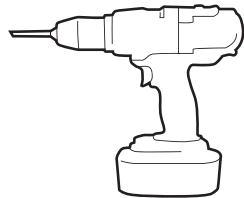

Drill and drill bit (7/32in)



Flashlight

Compatibility Section

- **REQUIRED: A C-Wire (common wire) is needed for 24 VAC power. If you do not have a C-Wire, then a C-Wire Adapter is provided.**

This guide will help you determine if you have a C-Wire or will need to use the included C-Wire Adapter (Step 10). The C-Wire is a wire that originates from your heating and cooling system and needs to be connected to the C terminal on your thermostat. There is no universal color used to designate this type of wire.



C-Wire

OR

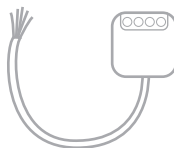

C-Wire Adapter

- Compatible with most heating, cooling, and heat pump systems
- Does not work with electric baseboard heat (120-240V)
- Does not work with millivolt systems
- Does not support S terminals for indoor and outdoor sensors
- Android or iOS smartphone, tablet, or device



CAUTION: ELECTRICAL HAZARD

Can cause electrical shock or equipment damage. Disconnect power before beginning installation.



CAUTION: EQUIPMENT DAMAGE HAZARD

Compressor protection is bypassed during testing. To prevent equipment damage, avoid cycling the compressor quickly.



CAUTION: MERCURY NOTICE

If this product is replacing a control that contains mercury in a sealed tube, do not place the old control in the trash. Contact your local waste management authority for instructions regarding recycling and proper disposal.

For help, see:

ONLINE GUIDES AND SUPPORT VIDEOS AT: yourhome.honeywell.com/support

SOCIAL Twitter: @Honeywell_Home, Facebook: Honeywell Home

Or contact:

EMAIL honeywellhomessupport@honeywell.com

PHONE 1-800-633-3991

Removing your old thermostat

You will need: Screwdriver, needle-nose pliers

1 Turn off power

⚠ To protect your equipment, turn off the power at the breaker box or switch that controls your heating and cooling equipment.

Note: The thermostat off switch will not turn off the power to the equipment.

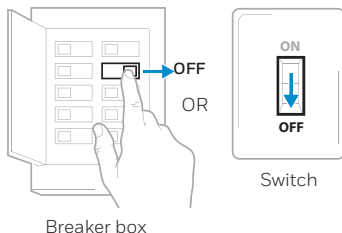

2 Check that your system is off

Change the temperature on your old thermostat so that your system starts heating or cooling.

If you don't hear or feel the system turn on within 5 minutes, the power is off.

Note: If you have a digital thermostat that has a blank display, skip this step.

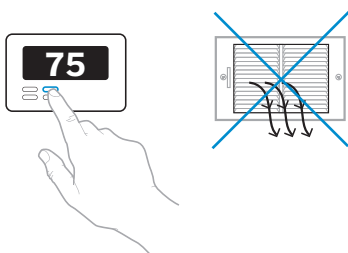

3 Remove your existing thermostat from the wall plate

On most thermostats, you can take off the thermostat by grasping and gently pulling. Some thermostats may have screws, buttons, or clasps.

⚠ Do not remove any wires from your thermostat at this time!

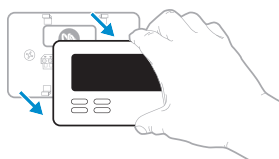

Compatibility Check

4 Do you have a line voltage system?

Line voltage systems have thick black wires with wire nuts or are labeled high voltage (120V or higher).

YES

Your system is not compatible. Call 1-855-733-5465 to find a pro-installer in your area.

NO

Continue to the next step.

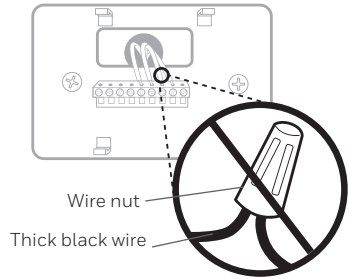

5 Take a picture of your existing wall plate's wiring

In order to capture all of the letters next to the terminals, be sure to take multiple pictures from different angles.

You may need to reference this image later.



6 Remove any jumpers

A jumper is used to connect two terminals. It may look like a small staple or a colored wire.

Do not discard.
Keep jumpers with your old wallplate.

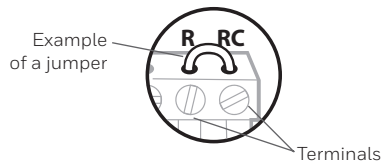

7 Label the wires

Use the stickers provided with your new thermostat to label each wire on your existing wall plate.

Do not label jumpers. Your new thermostat does not need jumpers.

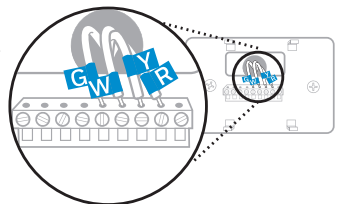

8 Write down the colors of the wires

Check the boxes and write down the color of the wires connected to terminals that are coming from the wall. Check all that apply (not all will apply).

Terminal	Wire Color	Terminal	Wire Color
<input type="checkbox"/> A or L/A	_____	<input type="checkbox"/> R	_____
<input type="checkbox"/> C	_____ Required*	<input type="checkbox"/> Rc	_____
<input type="checkbox"/> E	_____	<input type="checkbox"/> Rh	_____
<input type="checkbox"/> G	_____	<input type="checkbox"/> W	_____
<input type="checkbox"/> K	_____	<input type="checkbox"/> W2 or Aux	_____
<input type="checkbox"/> O/B	_____	<input type="checkbox"/> Y	_____
<input type="checkbox"/> U (1 or 2)	_____	<input type="checkbox"/> Y2	_____

***A C-wire or C-Wire Power Adapter (included) is required.**

If there are wires in terminals that are not listed, you will need additional wiring support. Visit yourhome.honeywell.com/support to find out more.

9 Disconnect the wires and remove the old wall plate

You may need a screwdriver to release wires from terminals.

Tip: Wrap the wires around a pencil to prevent them from falling in the wall.

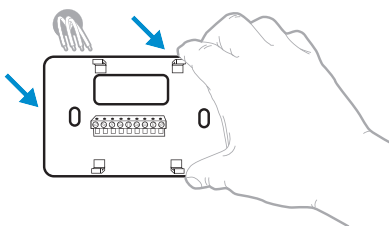

⚠ Compatibility Check

10 Do you have a C-Wire?

Look at the thermostat wiring checklist from **Step 8**, or the photo you took. Is the C-Terminal checked?

YES

This means you will not need to install the included C-Wire Adapter. Skip to **Installing Your New Thermostat (page 9)**.

NO

This means you don't have a C-wire connected to your thermostat. Continue to next step.

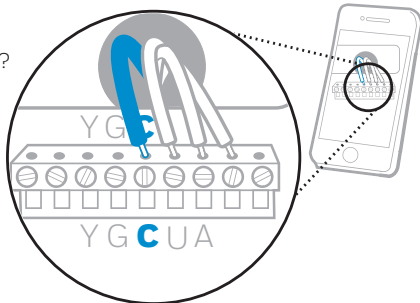



Only complete this section if you answered **No** to **Step 10**

Connecting Your Unused C-Wire

You will need: Screwdriver, flashlight, wire strippers

⚠ Compatibility Check

11 Do you have a zoning panel?

You have a zoning panel if you have multiple thermostats and one furnace or heating system.

YES

C-Wire Adapter installation is more complicated on zoned systems. Call 1-855-733-5465 to find a pro-installer.

NO

Proceed to the next step.

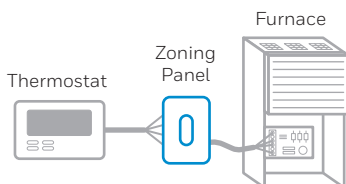

12 Do you have an unused wire?

Look at the bundle of wires coming from the wall.

Note: You may have to pull the bundle of wires out from the wall find the unused wire.

YES

Continue to **Step 13**.

NO

Open the included **C-Wire Adapter** box and follow the instruction guide.

Example of unused C-wire

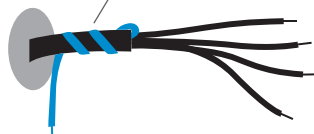

13 Label unused wire

Label your unused wire with the provided "C" sticker label. You may need to use a wire stripper to expose at least 1/4 inch of the wire.

Note: If you have multiple unused wires, then label only one wire and make note of the color here:

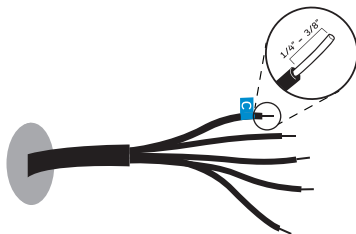

Go to your furnace or heating system

This system is often located in your basement, attic or garage. Bring a flashlight and screwdriver.

14 Remove cover from furnace or heating system

Open the heating and cooling system's cover to find the control board. You should see the same terminal labels that are on your thermostat.

Note: You may need to unscrew the cover. The control board may be at the top or bottom.

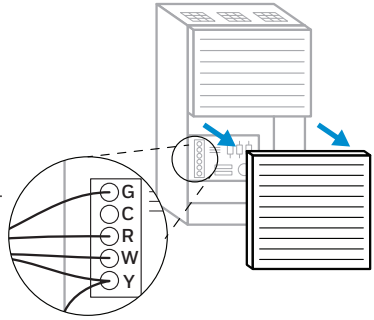

15 Find the other end of the unused wire

Locate the bundle of wires that are the same as the ones at your thermostat.

The unused wire should be the same color as the one near your existing thermostat. See **Step 13** for the color you wrote down.

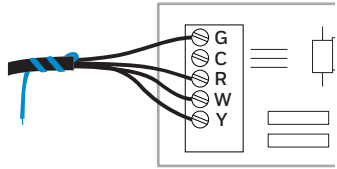

16 Connect the unused wire to the C-terminal

Note: If there are existing wires in the C-terminal, make sure they are still connected to the C-terminal after connecting this wire.

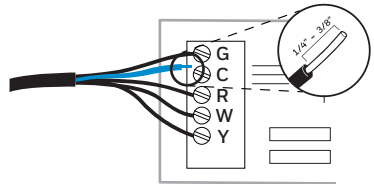

17 Close the cover to the furnace or heating system

Be sure the cover is completely closed. Some systems will not power up if the cover isn't fully closed.

You've connected the C-wire. You will NOT need to use the included C-Wire Adapter.

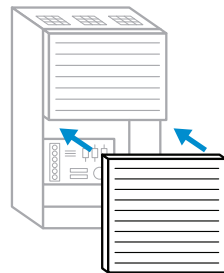

 Go back to the wall where you are installing your thermostat and continue to **"Installing Your New Thermostat"** on the next page.

Installing Your New Thermostat

You will need: Level, pencil, drill and a 7/32in drill bit

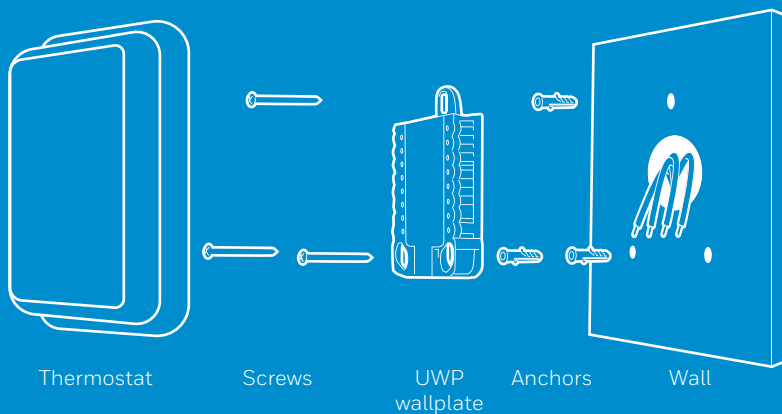

18 Position wall plate

Pull open the wall plate that was included with your new thermostat. Insert the bundle of wires through the back of the wall plate.

Make sure at least 1/4-inch of each wire is exposed for easy insertion into the wire terminals.

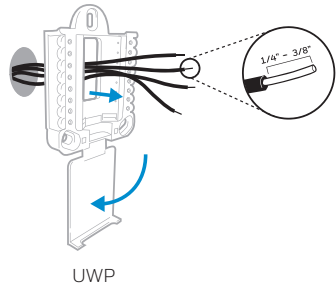

19 Insert recommended wall anchors

It is recommended that you use the wall anchors included in the box to mount your thermostat.

You can use the wall plate to mark where you want to place the wall anchors.

- Level the wall plate
- Mark the location of the wall anchors using a pencil
- Remove the wall plate
- Drill the holes using a 7/32" drill bit
- Insert the wall anchors
- Make sure the anchors are flush with the wall
- Reposition the wall plate on wall

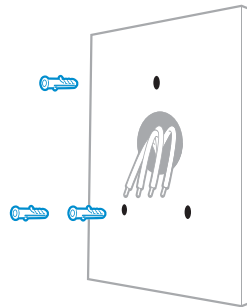
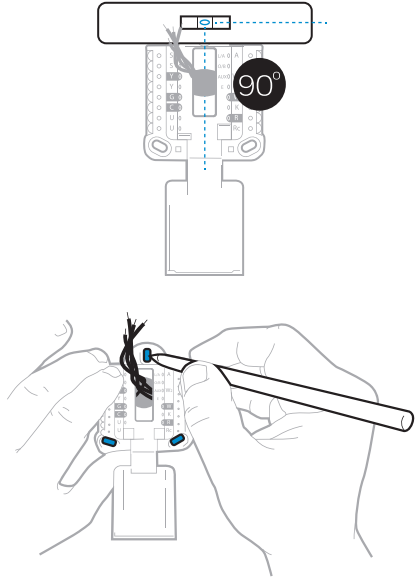

Anchors

Wall

20 Determine Correct R-Switch Position and Insert R-wire or wires

Set the R-switch up or down based on your wiring notes in **Step 8**. Insert wires into the inner holes of the terminals on the wall plate. The tabs will stay down once the wire is inserted.

If you have **1 R-Wire** (R, RC, RH):

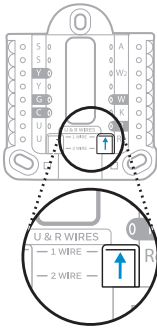

1. Ensure the right R-switch is in the **up** position.

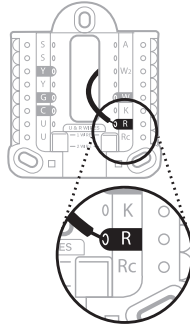

2. Insert your **R-wire** (R, Rh or Rc) into R-terminal.

OR

If you have **2 R-Wires** (R, RC, RH):

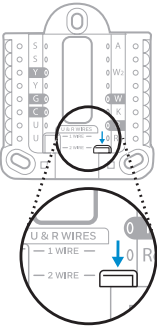

1. Set right R-switch to the **down** position.

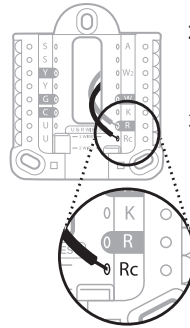

2. Insert your **Rc wire** into Rc-terminal.
3. Insert your **R or Rh wire** into R-terminal.

21 Connect remaining wires from Step 8

Push down on the tabs to put the wires into the inner holes of their corresponding terminals on the wall plate (one wire per terminal) until it is firmly in place.

Gently tug on the wires to verify they are secure.

Tip: If you need to release the wires again, push down the terminal tabs on the sides of the wall plate.

This wiring is just an example, actual wiring may vary.

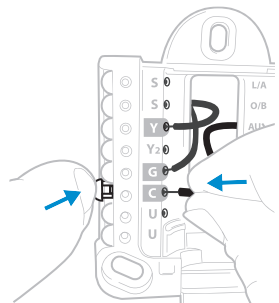

22 Close the door and mount the wall plate

Mount the wall plate using the provided screws. Install all three screws for a secure fit on your wall.

Tip: Prior to tightening the screws, use a level to ensure the wall plate is level.

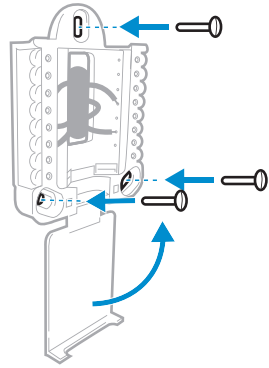

23 Attach your thermostat

Align the thermostat on the wall plate and firmly snap into place.

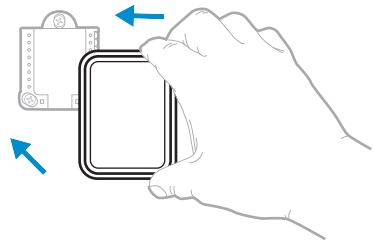

 Go back to your circuit breaker box.

24 Turn power back on

Turn on the switch that controls your heating and cooling system.

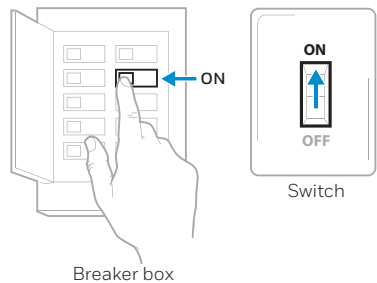

 Go back to your thermostat.

25 Complete setup on the thermostat

Remove the protective film and confirm that your thermostat reads "Welcome."

If you do not see this, visit yourhome.honeywell.com/support or call 1-855-733-5465 for more help.

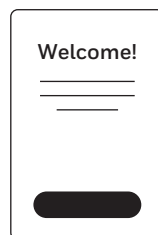

Getting the most from the T9 Wi-Fi Thermostat

Prioritize Rooms

Prioritize a specific room or multiple rooms, or let comfort follow your move using built-in motion detection.

Control on the Go

Adjust your thermostat from anywhere using your tablet or smartphone.

Save Energy

With geofencing, you can save money on the most expensive part of your energy bill while you're away.

Simple Installation

The thermostat automatically programs itself. Just answer a few simple questions and you'll be up and running in no time.

Whole-Home Range

With up to a 200-foot* range, 20 sensors with temperature, humidity, and occupancy detection can connect to your thermostat from throughout your home.

*Range can vary based on home construction, wireless interference, and other factors.

Know Your Home Is Safe

Get customizable alerts on your mobile device such as when the basement is so cold a pipe could burst, or if the baby's room is getting too hot.

Using your thermostat

The screen will wake up by pressing the center area of the displayed temperature.

Indoor Temperature

Displays the current indoor temperature.

Current Priority

Displays the type of priority and number of rooms being prioritized. Extend your thermostat's reach with additional Wireless Room Sensors.

Indoor Humidity

Displays the current indoor humidity.

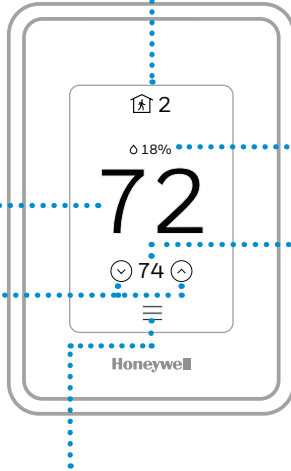

Adjust Temperature

Touch the up and down arrows to set your desired temperature.

Menu

Contains features such as mode, fan, schedule, priority, and other thermostat settings.

Desired Temperature

Displays the desired temperature.

Using Priority

Priority creates an average temperature in your home based on specific rooms. This allows you to prioritize comfort where you want it.

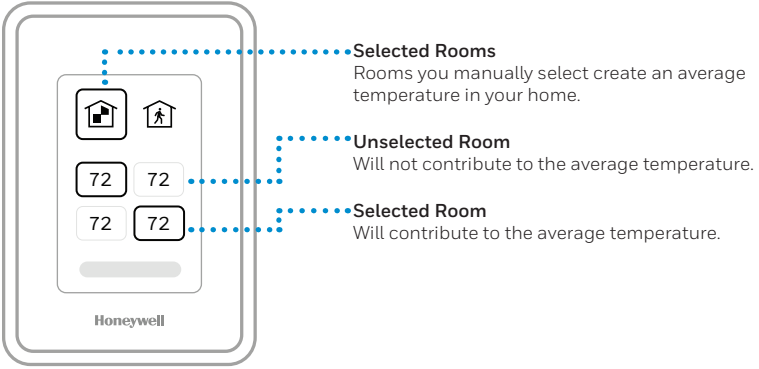

Active Rooms
Rooms with detected motion are automatically selected to create an average temperature in your home..

Room without Activity
No motion is detected. Will not contribute to the average temperature.

Room with Activity
Motion is detected. Will contribute to the average temperature.

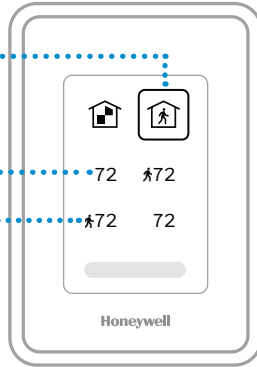

Troubleshooting

If you have difficulty with your thermostat, please try the following suggestions. Most problems can be corrected quickly and easily.

- Display is blank**
- Check circuit breaker and reset if necessary.
 - Make sure power switch for heating & cooling system is on.
 - Make sure furnace door is closed securely.
 - Make sure the C wire is connected.
- Heating or cooling system does not respond**
- Press **Menu > System Mode > Heat > Done** to set the system to Heat mode. Make sure the desired temperature is higher than the indoor temperature.
 - Press **Menu > System Mode > Cool > Done** to set the system to Cool mode. Make sure the desired temperature is lower than the indoor temperature.
 - Check circuit breaker and reset if necessary.
 - Make sure power switch for heating & cooling system is on.
 - Make sure furnace door is closed securely.
 - Wait 5 minutes for the system to respond.
- Temperature settings do not change**
- Make sure desired temperature is within acceptable ranges:
- Heat: 40 °F to 90 °F (4.5 °C to 32.0 °C)
 - Cool: 50 °F to 99 °F (10.0 °C to 37.0 °C)
- Aux heat runs in cooling**
- For heat pump systems, verify there is not a wire attached to W on the UWP.
- Cool runs with a call for heat**
- For heat pump systems, verify there is not a wire attached to W the UWP.

The product should not be disposed of with other household waste. Check for the nearest authorized collection centers or authorized recyclers. The correct disposal of end-of-life equipment will help prevent potential negative consequences for the environment and human health.



resideo

Resideo Inc., 1985 Douglas Drive North
Golden Valley, MN 55422

www.resideo.com

©2018 Resideo Technologies, Inc.
All rights reserved. The Honeywell Home trademark is used under license from Honeywell International Inc.
Tous droits réservés. La marque de commerce Honeywell Home est utilisée sous licence avec l'autorisation d'Honeywell International Inc.
Todos los derechos reservados. La marca comercial Honeywell Home se utiliza en virtud de la licencia emitida por Honeywell International Inc.
33-00421-03 M.S. Rev. 10-18
Printed in U.S.A.



33-00421-03