

Honeywell

**Tema-Voyager™ Compact
User Guide**

Release 1.0

Honeywell

Document	Release	Issue	Date
800-07036	1.0	A	June 2011

Notice

This document contains Honeywell proprietary information. Information contained herein is to be used solely for the purpose submitted, and no part of this document or its contents shall be reproduced, published, or disclosed to a third party without the express permission of Honeywell Europe.

While this information is presented in good faith and believed to be accurate, Honeywell disclaims the implied warranties of merchantability and fitness for a purpose and makes no express warranties except as may be stated in its written agreement with and for its customer.

In no event is Honeywell liable to anyone for any direct, special, or consequential damages. The information and specifications in this document are subject to change without notice.

Copyright 2011 – Honeywell International Inc.

Honeywell trademarks

Tema-Voyager[™] is a trademark of Honeywell International Inc.

Honeywell Enterprise Buildings Integrator[™] is a trademark of Honeywell International Inc, and SafeBrowse[®] is a U.S. registered trademark of Honeywell International Inc.

Other trademarks

Microsoft, Windows, Windows NT and XP, SQL Server, Office, Word, Excel and PowerPoint are either registered trademarks or trademarks of Microsoft Corporation in the United States and/or other countries.

SAP R/3 and HR-PDC are registered trademarks of SAP AG in Germany.

Trademarks that appear in this document are used only to the benefit of the trademark owner, with no intention of trademark infringement.

Compliance

To obtain applicable EU compliance Declaration of Conformities for this product, please refer to our website, <https://extranet.honeywell.com>. For any additional information regarding the compliance of this product to any EU-specific requirements, please send email to temaline.orders@honeywell.com.

Support and other contacts

For technical assistance, call your nearest Honeywell office.

Training classes

Honeywell holds technical training classes on Temaline. These classes are taught by experts in the field of building control systems. For more information about these classes, contact your Honeywell representative.

Related documentation

For a complete list of publications and documents for Temaline, see the *Temaline Overview*.

FCC Notice

FCC ID: HS9VCU-01;HS9VCU-02;HS9VCU-03

This device complies with FCC rules Part 15. Operation is subject to the following two conditions:

- (1) This device may not cause harmful interference and
- (2) This device must accept any interference received, including interference that may cause undesired operation

This equipment has been tested and found to comply with the limits for class B digital devices, pursuant to part 15 of the FCC Rules. These limits are designed to provide reasonable protection against harmful interference in a residential installation.

This equipment generates, uses, and can radiate radio frequency energy and if not installed and used in accordance with the instructions, may cause harmful interference to radio communications. However, there is no guarantee that interference will not occur in a particular installation. If this equipment does cause harmful interference to radio or television reception, which can be determined by turning the equipment on and off, the user is encouraged to try to correct the interference by one or more of the following measures:

- Reorient or relocate the receiving antenna
- Increase the separation between the equipment and the receiver
- Connect the equipment to an outlet on a circuit different from that to which the receiver is connected
- Consult the dealer or an experienced radio/TV technician for help

The user is cautioned that changes and modification made to the equipment without the approval of the manufacturer could void the user's authority to operate this equipment.

IC RSS 210 Notice

This device complies with Industry Canada licence-exempt RSS standard(s). Operation is subject to the following two conditions: (1) this device may not cause Interference, and (2) this device must accept any interference, including interference that may cause undesired operation of the device.

Le présent appareil est conforme aux CNR d'Industrie Canada applicables aux appareils radio exempts de licence. L'exploitation est autorisée aux deux conditions suivantes : (1) l'appareil ne doit pas produire de brouillage, et (2) l'utilisateur de l'appareil doit accepter tout brouillage radioélectrique subi, même si le brouillage est susceptible d'en compromettre le fonctionnement.

ICES-003

This Class B digital apparatus complies with Canadian Standard ICES-003.
Cet appareil numérique de la classe B est conforme à la norme NMB-003 du Canada.

Contents

1	Introduction	1
	Purpose and audience for the Guide	2
	Structure of the guide	3
	Related documentation	4
2	Getting started	5
	Layout of the device	6
	General layout of the display	7
	Interactive function icons	8
3	Understanding device statuses	11
4	Managing transit operations	13
	Performing a transit operation with a card	14
	Performing a transit with card and PIN code	17
	Signalling a transit under duress	18
	Clocking in and clocking out	19
5	Interactive features	21
	Changing the language of the device	22
	Associating a reason with a transit	25
	Associating Additional Data Lists with a transit	28
	Performing enquiries	33
	Local transit enquiries	34
	Remote transit enquiries	34
	Local generic enquiries	35
	Remote generic enquiries	35
	Reading spontaneous messages	36
	Working with transit categories	38
6	Other types of transit operations	39
	Performing a transit in semiautomatic mode	40
	Performing a transit with PIN code only	41
	Performing a boarding operation	43
7	Ethernet connecting and how to configure into EBsystem	44
8	Device Connector	49
9	Setting inputs, outputs, and jumpers	50

CONTENTS

Setting inputs, outputs, and jumpers	50
Digital inputs	50
Supervised inputs	51
Outputs	52
External relays powered by the reader	52
Connecting the door lock directly using an external power supply	53
Jumpers	54
10 Error messages	55
11 Recycling	59

Introduction

1

The Voyager Compact is an IP reader device with a local database that can communicate on a peer-to-peer basis with other Voyager devices to manage a facility. You can configure Voyager devices to support up to four languages.

Voyager devices are completely autonomous. They do not need a host system to manage a facility.

Purpose and audience for the Guide

This guide describes procedures for performing transit operations with the device. It is written for cardholders who will be using the device to:

- transit from a controlled door
- perform Time&Attendance clock-in and clock-out operations
- perform interactive functions such as changing the language of the device, performing enquiries, and reading spontaneous messages.

Structure of the guide

In addition to the Introduction (this chapter), the guide comprises the following topics.

To learn about	Go to
Getting started	page 5
Understanding device statuses	page 11
Managing transit operations	page 13
Interactive features	page 19
Other types of transit operations	page 39
Error messages	page 45

Related documentation

For further information on the EBI Tema system, consult the EBI Temaline Interface *Temaline Access Control Configuration Guide*, which is provided with the Temaline Interface kit. This document is in Acrobat™ and compiled HTML Help format.

Getting started

2

This chapter describes basic mechanical and design features of the Voyager Device:

To learn about	Go to
The layout of the device	page 6
The layout of the display	page 7

Layout of the device

The Voyager device is an interactive terminal with a graphic display and a reader. You can use the device for T&A, SAP, canteen management, and access control.

Figure 1 Voyager Compact Device



To perform these functions, the device comprises the following features:

- A color graphic display
- A 10-digit keypad with backlighting
- Backlit navigational arrows and **Enter** and **Cancel** buttons
- A speaker

General layout of the display

Figure 2 illustrates the general layout of the Voyager Compact Device display in idle mode.

Figure 2 Voyager Compact Device display











Field	Description
Transit direction	Specifies the direction assigned to the transit performed. Transit direction is present only for T&A devices if the Change Transit Direction feature is configured for the device.
Date/Time	Current date/time
Logo	Customer logo
Message	Configurable text
Information	The meaning of the current icon selected, or other informational messages
Icon bar	Icons representing configurable functions available on the device. You can configure the functions needed from the available features.

Device displays all follow this basic design. Depending on the context, the device may also display device status information or interactive features.

Interactive function icons

Table 1 lists the standard interactive function icons you may see on the icon bar of your Voyager device. Icons on the display represent the features enabled for the device.

Table 1 Voyager system icons

Icon	Description
	Change Direction—Default icon for the device change direction function
	Message—Provides access to the spontaneous message template
	Reason—Provides access to the reason template
	Enquiry—Provides access to the enquiry template
	Transit Category—Provides access to the transit category template
	ADL—Default icon to access the ADL template
	Set language—Default icon for the device set language function
	Chinese flag—Indicates Chinese language setting
	British flag—Indicates English language setting
	French flag—Indicates French language setting
	Italian flag—Indicates Italian language setting
	German flag—Indicates German language setting

The currently selected function icon is highlighted with a red square. To implement a function, use the arrow keys to select an icon and then press **Enter**. The new selected icon is then highlighted in a red square.

Figure 3 Voyager Device navigational arrows



To enter a value, such as a PIN, use the numeric keypad.

Figure 4 Voyager Device keypad

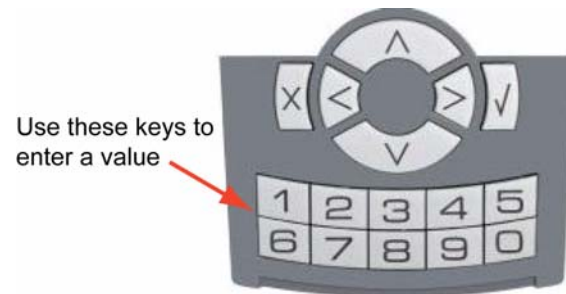

For further information on these features, see “Interactive features” on page 19.

Understanding device statuses

3

The Voyager device can generate several device status messages. Status messages report system modes and unusual occurrences relating to:

- The device
- The door controlled by the device
- Transits











Figure 5 illustrates a generic status display on the device.

Figure 5 Status display



Field	Description
Caption	Name of status
Message	Text associated with caption

Table 2 Device status messages

Event	Symbol	Caption	Description
Terminal statuses			
Terminal not configured		OUT OF ORDER	The reader has not yet been configured. You may not use the device at this time.
Terminal/Door out of order		OUT OF ORDER	The reader or the door controlled is experiencing technical difficulties. You may not use the device at this time.
Terminal in overdrive mode		DEVICE IN OVERDRIVEN MODALITY	This device is set in overdrive mode. You do not need this device to authorize the transit.
DB Download in progress		DB DOWNLOAD IN PROGRESS	The DB download is in progress. You may use the device but you may experience some delay in response time.
Transit Buffer full		TRANSIT BUFFER FULL	There is no more space available on the device to store transits. To prevent further loss of transits, this device has been blocked.
Door statuses			
Door locked		DOOR LOCKED	This door is locked; do not attempt to transit through this door.
Door unlocked		PLEASE ENTER	The door is unlocked; proceed with the transit.
Door busy		PLEASE WAIT THE DOOR IS BUSY	A transit is in progress through this door. You may be unable to transit at this time.
Door forced		DOOR FORCED	The door managed by this reader has been forced. Please notify security, then close the door to reset it.
Door not shut after crossing		DOOR NOT SHUT AFTER CROSSING	The door should be closed. Close the door to reset it and notify security.
Transit not happened		TRANSIT NOT HAPPENED	The door has not opened for the transit requested.

For information on transit error messages, see “Error messages” on page 45.

Managing transit operations

4

You can configure your device to perform four types of authentication:

- Card number
- Card number and PIN
- PIN only
- Airport boarding procedure

This chapter describes typical transit operations that use these authentication methods.

To learn about	Go to
Performing a basic transit operation	page 14
Performing a transit with a card number and PIN	page 17
Clocking in and clocking out	page 19

For information about PIN only transits and airport boarding, see “Other types of transit operations” on page 39.

Performing a transit operation with a card

When you present your card to a device for a transit, the device checks the information stored on your card and then searches in the cardholder archive to determine your access rights.

To complete a transit using only a card:

Hold the card a few centimeters from the reader in the highlighted area in Figure 6. The reader verifies the permissions configured for the card.

Figure 6 Voyager Compact Device



When access is granted, the device emits an Access Granted sound (a gentle chime), displays the Access Granted message, and unlocks the door.

Figure 7 Sample Access Granted display

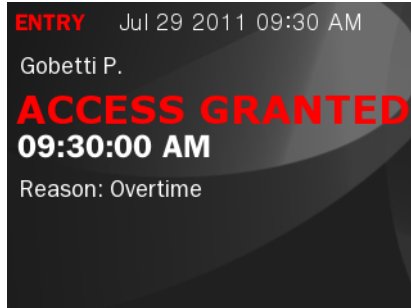

Field	Description	
Date	Current date	
Time	Current time	
Cardholder info	Cardholder peripheral description. cardholder information is shown only if the device is configured to show it.	
Photo	Cardholder photo; this option is available only when multimedia option is installed.	
Transit information	Transit direction	For AC and CA terminals: ACCESS GRANTED For T&A or SAP terminal: CLOCK IN for a transit in Entry direction; CLOCK OUT for a transit in Exit direction. For devices that are configured simultaneously as T&A and AC, the T&A behavior shall apply.
	Time	Time of the transit
	Reason	Reason used for the transit (if any)
Information	Indicates the presence of spontaneous messages for the cardholder. Spontaneous messages are then accessed using the related function icon/menu and shown using the related template. Fore more information, see “Reading spontaneous messages” on page 36.	

Field	Description
Toolbar	Displays icons representing functions configured for the cardholder who performed the transit.

Once you receive this message, open the controlled door, pass through it, and close it.

If the transit is denied, the device emits an Access Denied sound and displays an Access Denied message; the door remains locked.

For more information on error messages, see “Error messages” on page 45.

Performing a transit with card and PIN code

A card provides identification for the cardholder; a PIN provides authentication. When a device is configured for both card and PIN verification, it can identify and authenticate a cardholder.

To perform a transit with card and PIN code:

- 1 Present your card to the reader. The device identifies your card and performs the controls on the cardholder archive; if the controls are passed, the device displays a request for a PIN.

Figure 8 PIN Code request

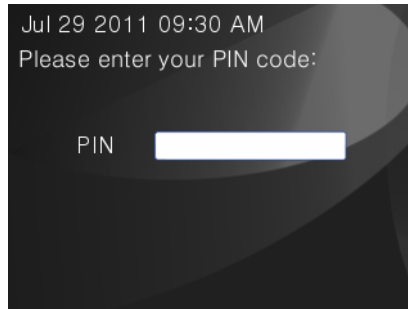

- 2 Enter the PIN. The device checks the PIN entered against the value stored for you for the number of retries configured.

Note: You do not need to press **Enter** to confirm the PIN entered; once the configured number of digits configured for the PIN is reached, the device automatically processes it.

When the device verifies that the PIN is correct, access is granted. The device emits the access granted sound (a gentle chime) and displays the Access Granted message.

Once you receive this message, open the controlled door, pass through it, and close it.

If the device doesn't recognize the PIN value:

- The transit is denied.
- The device emits an access denied sound.
- The device displays an Access Denied message.
- The door remains locked.

If the device is configured for a specific number of retries and that number is exceeded, the device may also block further use by the cardholder for a specific length of time.

Signalling a transit under duress

To protect against improper entry, the system includes a way to modify a PIN to signal a transit under duress.

To signal a transit under duress:

- 1 Present your card to the reader. The device authenticates your card and then displays a request for a PIN.
- 2 **FOR ODD NUMBERS:** Enter your designated PIN but modify the final digit to be one LESS than the actual PIN. For example, if the PIN is 5437, enter 5436.
FOR EVEN NUMBERS: Enter your designated PIN but modify the final digit to be one MORE than the actual PIN. For example, if the PIN is 7938, enter 7939.
- 3 Wait for confirmation and when you receive it, proceed with the transit.

When the system detects such a signal, the device:

- Grants the transit at the terminal level
- Generates a “Transit under duress” alarm to the Supervision Center

The device does NOT display “Access denied”.

Clocking in and clocking out

In the T&A application, “Clock in” and “clock out” are terms that refer to the direction of a transit.

Clock in indicates the time you enter the office (the clock starts counting the time the cardholder is in the office).

Clock out indicates the time you leave the office (the clock stops counting the time).

A Voyager device can be configured for one direction (clock-in OR clock-out), or for both directions (clock-in AND clock-out).

In this case, to set a specific direction for the device you must use the “Change direction” function. 

To change the transit direction and perform the transit:

- 1 Check the current direction set for the terminal that is shown on the right side of the header of the display.

Figure 9 Change Transit Direction display

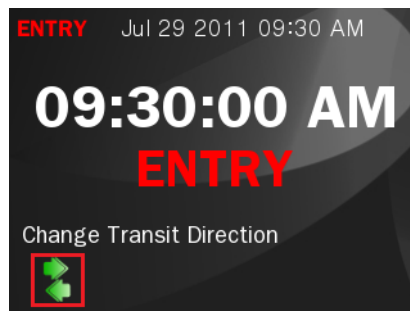

- 2 Select the Change direction icon on the toolbar and click **Enter**. The direction of the terminal in the header line of the display will change.
- 3 Present your card to the device.

If the transit is valid, the device emits the access granted sound (a gentle chime), displays the clock-in/clock-out page, and (if so configured) unlocks the door.

Figure 10 Clock In display

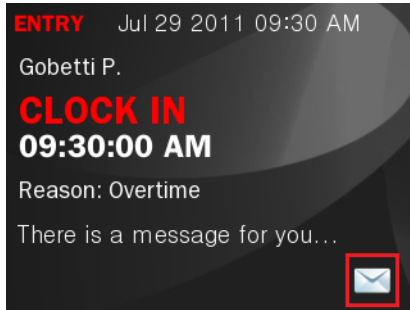

Interactive features

5

Interactive features are system functions that you can request and display on your Voyager Device.

To learn about	Go to
Changing the display language of the device	page 22
Associating a reason to a transit	page 25
Associating an Additional Data List (ADL) to a transit	page 28
Performing enquiries	page 32
Reading spontaneous messages	page 35
Working with transit categories	page 37

By default you may configure a Voyager door to manage automatically a predefined type of function without the need for a cardholder to select the relative key(s). You may specify:

- a transit category
- a reason (simple or enhanced)
- a enquiry request

In these cases, the device shows, instead of the idle page, the related feature pages.

Changing the language of the device

At startup, the device displays information in the language that has been set for it—that is, the default language. The "Set language" function enables you to change the current language to another of the available languages.

To change the language of the device from the language function key:

- 1 On the device display, select the set language function flag you need from the toolbar.

Figure 11 Change language display



- 2 Press **Enter**. The device displays the Change Language display for a few seconds and then returns to the idle page with the new language set.

Figure 12 Selected language display

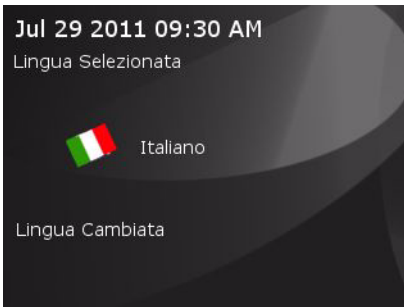

To change the language of the device from a language menu:

- 1 On the device display, select the language menu icon.

Figure 13 Change Language Menu icon

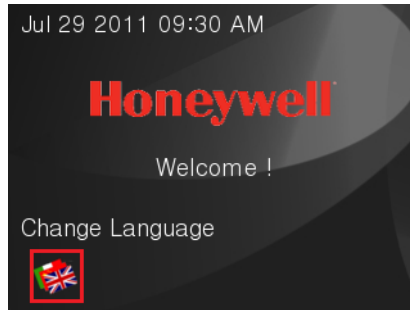

- 2 Press **Enter** to display the language menu.

Figure 14 Language menu

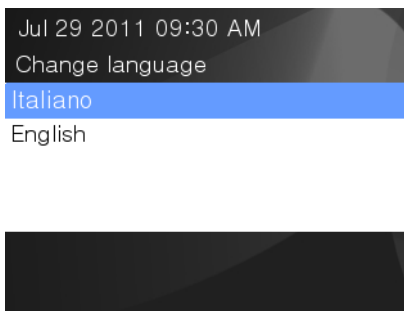

- 3 Select the language you need and press **Enter** to view the Language selection display.

Figure 15 Language selection display



After a few seconds, the device returns to the idle page display showing the new language that you have set.



Associating a reason with a transit

A reason provides an explanation of a transit that is beyond normal operations.

There are two types of reasons:

- Simple - Characterized by a reason code added to the transit
- Enhanced - Characterized by required parameters and entered using an Additional Data List

To associate a simple reason with a transit:

- 1 Use the arrow keys to select the desired reason icon from the toolbar or description in the menu.

Figure 16 Reason selection display

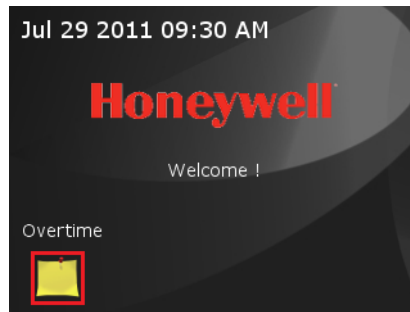

- 2 Click **Enter** to confirm the selection and display the Reason template.

Figure 17 Reason display

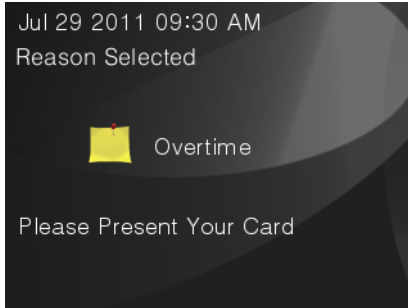

If you select the wrong reason, click **Cancel** to cancel the operation.

- 3 Present your card to authenticate the transit.

The device checks your rights to use the reason; if the reason is not usable the device displays “Feature not available”. If the function is usable, the device checks the validity of the reason; if the reason is not usable, the device displays “Feature expired”. The device then checks your rights for the transit and displays the Transit page, including the reason you selected. The device also inserts the reason code into the transit record.

Figure 18 Transit display

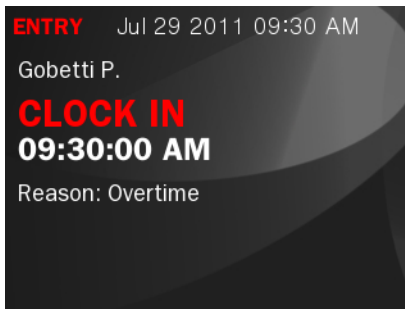

To associate an enhanced reason with a transit:

- 1 Use the arrow keys to select the desired enhanced reason icon from the toolbar or description from the menu and click **Enter** to confirm the selection and display the Reason template.

The device then displays the Additional Data List template associated with the reason.

If you select the wrong reason, click **Cancel** to cancel the operation.

- 2 Fill in the ADL fields and present your card to authenticate the transit. (See “Associating Additional Data Lists with a transit” on page 28 for further information.)

The device checks your rights to use the reason; if the reason is not usable the device displays “Feature not available”. If the function is usable, the device checks the validity of the reason; if the reason is not usable, the device displays “Feature expired”. The device then checks your rights for the transit and inserts the reason code and the ADL parameters into the transit record.



Associating Additional Data Lists with a transit

Additional Data Lists (ADLs) are groups of parameters you can enter that will be associated to your transit.

To associate an ADL with a transit:

- 1 Use the arrow keys to select the desired ADL icon in the toolbar.

Figure 19 Additional Data List template

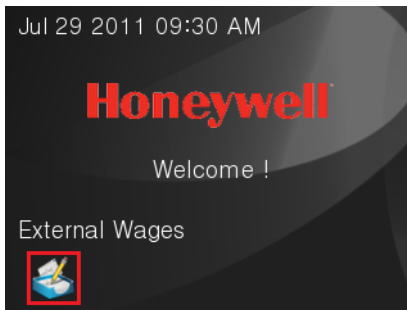

- 2 Click **Enter** to confirm the selection and display the Additional Data List template.

Figure 20 Example: ADL for External Wages

The screenshot shows the 'External Wages' form. At the top, it says 'Jul 29 2011 09:30 AM' and 'External Wages'. Below this, there are three input fields: 'Amount:' with the value '250.00', 'Currency:' with a dropdown menu showing 'Euro', and 'Date:' with the value '07/29/2011'. The entire form area is enclosed in a blue border, and the 'Amount' field is highlighted with a red box.

If you select the wrong ADL, press **Cancel** to cancel the operation.

- 3 The template presents a list of fields to be filled out. (Mandatory fields are identified with an asterisk and must be filled in so that the data can be entered.) Once an ADL is displayed, the cursor is positioned on its first field. Use the up and down arrows to move across fields; the selected field is highlighted with a red border.

Table 3 lists each type of field and describes how to use it.

Table 3 ADL configuration fields



Field type	Field name display	Procedure
Alphanumeric	<p>Label: <input style="border: 2px solid red;" type="text"/></p>	<p>When you select an alphanumeric field, the device displays a virtual alphanumeric keyboard. Press Enter to open the virtual keyboard on the screen.</p>  <p>Use the arrows to select a key, then press Enter to confirm the selection. Proceed in this way for every character you need to enter. When you have finished composing the entry, press Update on the virtual alphanumeric keyboard, then press Enter to insert the value into the ADL.</p> <p>Press Cancel to exit from the virtual keyboard without saving the input.</p> <p>To delete a character to the left of the cursor, press <- and then press Enter.</p>
Numeric	<p>Label: <input style="border: 2px solid red;" type="text"/></p>	<p>For numeric fields, use the keys of the device numeric keypad on the device (see Figure 1) to fill the field, then press Enter to confirm.</p>

Table 3 ADL configuration fields

Field type	Field name display	Procedure
Date		<p>Press Enter to open the calendar display.</p>  <p>Use the arrows to select a day and press Enter to confirm the selection.</p>
Time		<p>There are two options for entering a time:</p> <ul style="list-style-type: none"> • Type the desired time (hours and minutes) and press Enter to confirm, OR • a) Press Enter to select the hour subfield and use the up/down arrows to increase/decrease the value, or directly type the desired hour. b) Use the right arrow to select the minute subfield and use the up/down arrows to increase/decrease the value, or directly type the desired minutes. c) Press Enter to confirm the value.
List		<p>Press Enter to open the list:</p>  <p>Use the up/down arrows to select the item you need and press Enter to confirm.</p>

- 4 When you have completed the required fields, present your card to submit the data and to authenticate the transit.

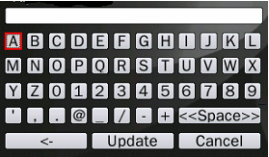
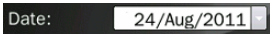
In case of errors in the data entered (validation or mandatory field missed), the device displays a specific message and highlights the error field with a red border.

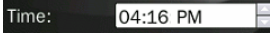
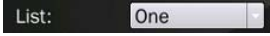
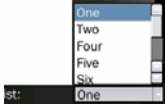
The device checks your rights to use the ADL; if the function is not usable it displays “Feature not available”. If the function is usable, the device checks your rights for the transit and inserts the ADL data into the transit record.



Performing enquiries

Enquiries are requests for cardholder information stored in the system that can be shown on the device display.

The following types of enquiries are available:

- Local and remote transit enquiries
- Local and remote generic enquiries

The procedure for making an enquiry is basically the same for both local and remote enquiries.

To make an enquiry:

- 1 Use the arrow keys of the navigator to select the desired Enquiry icon and click **Enter** to confirm the selection.

Figure 21 Enquiry display

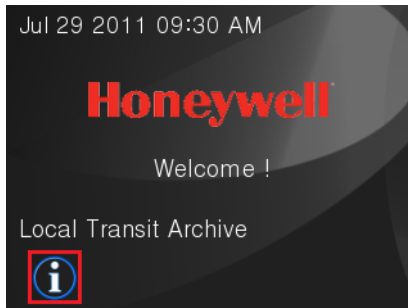

- 2 Submit your card to the reader to authenticate the request.

The device checks your permission to make the enquiry. If the function is not usable, the device displays "Feature not available".

When the request is authenticated, the device displays the information requested. Scroll between the enquiry lines using the up and down arrows; for Enquiries with multiple pages, navigate across pages using the left and right arrows. Click **Cancel** to exit from the enquiry.

Local transit enquiries

Local transit information is stored on the device itself. You cannot specify the number of transits that will be shown in the history; that number depends on the transit activity performed by cardholders who use the device.

Figure 22 Local transit information



Jul 29 2011 09:30 AM

Local Transit Archive

Date	Time	Dir	Reason
28/07/2011	08:30:32	IN	
28/07/2011	12:30:12	OUT	
28/07/2011	13:29:34	IN	
28/07/2011	18:30:21	OUT	OVERTIME
29/07/2011	05:30:11	IN	
29/07/2011	07:30:11	OUT	

Page Number : 2

Remote transit enquiries

Remote transit enquiries generate a list of all the transits performed by the cardholder on all the Temaline devices in the system (History of transits). The information is stored at the Supervision Center.

When you generate a remote transit enquiry, the device submits the request to the Supervision Center and displays "Waiting for supervision reply" until a reply is received.

Figure 23 Remote transit information

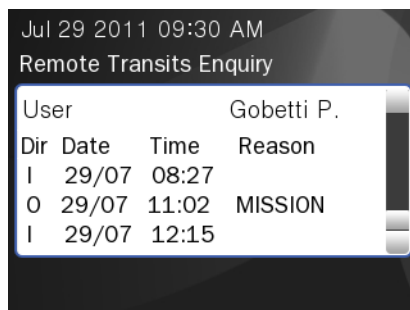

Jul 29 2011 09:30 AM

Remote Transits Enquiry

User	Dir	Date	Time	Reason
Gobetti P.	I	29/07	08:27	
	O	29/07	11:02	MISSION
	I	29/07	12:15	

If your request times out before the device receives the information, the device displays "Supervision reply not received" and terminates the operation.

Local generic enquiries

Local generic information is imported from the Supervision Center and sent to the peripheral device that stores it.

Figure 24 Generic enquiry display



Remote generic enquiries

Remote generic information is imported from external data sources and is stored at the Supervision Center. See Figure 24.

When you generate a remote generic enquiry, the device submits the request to the Supervision Center and displays "Waiting for supervision reply" until a reply is received. Upon authentication, the Supervision Center sends the data to the device and the device displays it. If your request times out before the device receives the information, the device displays "Supervision reply not received" and terminates the operation.



Reading spontaneous messages

A spontaneous message is a short message that is personalized and displayed whenever a transit occurs—for example, “Please get in touch with Human Resources office.” When you present your card, the device authenticates you and if your card is configured for a spontaneous message or if the terminal is configured to show a spontaneous message, it appears on your device transit display.

To read a spontaneous message, click on the related icon shown on the transit page when a transit is performed.

Figure 25 Spontaneous message display

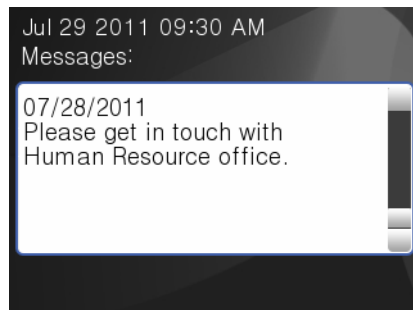

Spontaneous messages can be associated with:

- A specific employee (or to a set of employees) and so addressed exclusively to the person in question (or the set of people)
- A primary object and so they can be viewed by all authorized users who transit at the device.

Each Spontaneous Message may include some parameters that put some condition on the presentation of the spontaneous message, for example:

- A commencement date and an expiry date (message is shown only between these two dates)
- A direction of the transit (message is shown only for the transit directions specified)
- A type of transit (message shown only during specific transits, for example only when a transit is granted)

Spontaneous messages may also be displayed in different languages. If the device language is set to Italian, the message is in Italian; if the device language is set to French, the message is in French.

Working with transit categories

Transit categories are groupings of functions for specific purposes. For example, a "canteen management" category might group together reasons and ADLs that relate to canteen management, or an "intrusion" category, allowing the use of transit reasons with specific feedback, and so forth.

A Transit Category can be associated directly to an icon of the toolbar or to a menu item.

A Transit Category can be segregated using Authorized Functions.

To use the Transit Category feature:

- 1 Use the arrow keys to select the desired Transit Category icon and click **Enter** to confirm the selection and display the Transit Category template with the related features.

Figure 26 Transit Category display

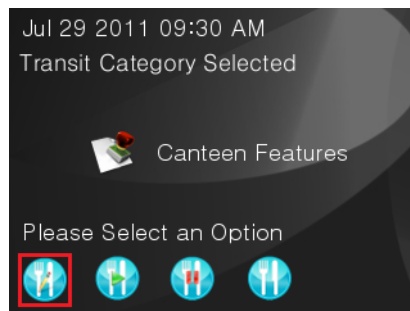

If you select the wrong Transit Category, click **Cancel** or use a specific icon or menu item to cancel the operation.

- 2 Use the features available on the transit category display and then present your card to authenticate the request.

The device checks your right to use the Transit Category; if the function is not usable, the device refuses the transit and displays "Feature not available". If the function is usable, the device checks the validity of the category. If the category is not usable, the device displays "Feature expired". The device then checks your rights to the transit and inserts the generic category label into the transit record. Finally, the device displays appropriate feedback.

Other types of transit operations

6

This chapter describes some specific transit operations.

To learn about	Go to
Performing a transit in semiautomatic mode	page 40
Performing a transit with PIN code only	page 41
Performing a boarding operation	page 43

Performing a transit in semiautomatic mode

The terminal may be configured to perform a transit in semiautomatic mode. When you present your card with this configuration prior to the transit, the device performs all configured controls and sends a transit request to the Supervision Center. The Supervision Center can grant or deny the transit request.

No range control is performed when the device is in semiautomatic control mode.

To perform a transit in semiautomatic mode:

Present your card to the device. The device checks all the controls; when all the controls are passed, the device sends a request to the Supervision Center, then displays the message “Waiting for supervision reply” until you get an answer from the Supervision Center.

The Supervision Center can accept or deny the transit. If the transit is denied, the device:

- Refuses the card.
- Displays "Access denied".

If after a certain time there is no reply from the Supervision Center, the device:

- Refuses the card.
- Displays "Supervision reply not received".

Performing a transit with PIN code only

If the device is set to work in Personal Identification Number (PIN) code only transit, it authenticates the cardholders using only the PIN code entered on the display. To use this transit type, every cardholder must be assigned a unique PIN number.

In this transit mode, the device shows the following display:

Figure 27 PIN code prompt

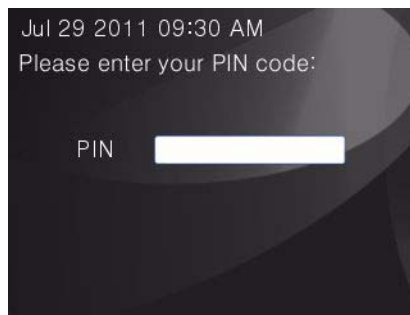

To perform a transit with PIN code only:

- 1 Type your PIN code using the keyboard (PIN is always a numeric value).

When you have entered the PIN code, the device use this number to identify the cardholder and to verify the cardholder's authorization to transit from the door.

Note: You do not need to press **Enter** to confirm the PIN entered; once the configured number of digits configured for the PIN is reached, the device automatically processes it.

If access is granted, the device emits the Access Granted sound (a gentle chime), displays the Access Granted page, and unlocks the door controlled by the device.

If the transit is denied, the device emits an access denied sound, displays a wrong access event, and doesn't unlock the door.

If you enter a wrong PIN code the device shows the following alert message:

Figure 28 Wrong PIN code display

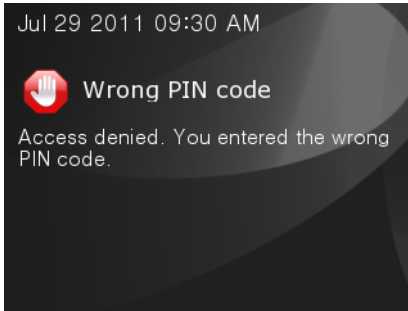

Note that if the device has been configured for a specific number of retries and a block time-out, and you exceed the number of attempts, the device will be blocked and shows the following display:

Figure 29 Door Locked display

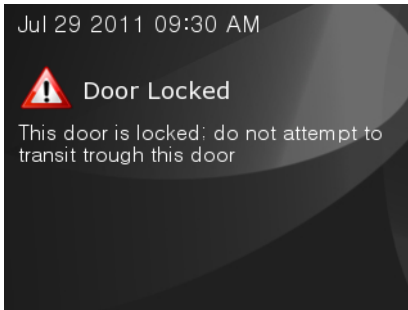

Performing a boarding operation

A device in Airport Boarding mode maintains the door open for a configured period of time once a cardholder executes the specific boarding procedure.

Figure 30 PIN code prompt

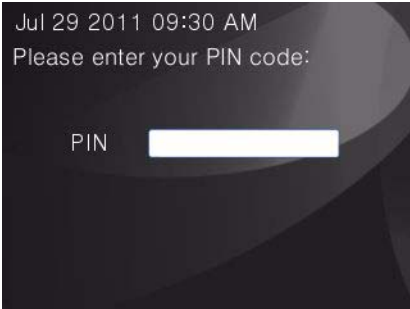

To initiate a boarding operation:

- 1 On the keyboard, enter the device keyboard code (keyboard code is a numeric code).
- 2 Once the code is entered, the device prompts you to present your card.

If the card is authorized, the device unlocks the door for the configured period of time and shows the following display.

Figure 31 Authorized Boarding display

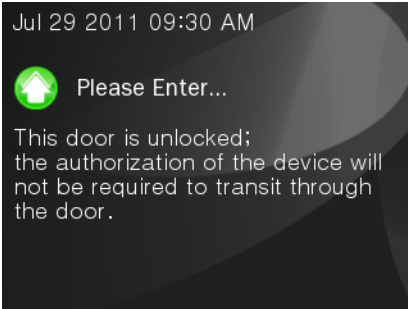

To terminate a boarding operation:

- 1 The same cardholder who initiated the procedure must present his/her card again or (if this option has been configured) another cardholder may present his/ her card to the device.

The device returns to its Idle display.

Note: When the airport boarding procedure is not in progress, the device accepts normal transit operations. (See “Performing a transit in semiautomatic mode” on page 40 for more details.)

7. Ethernet connecting and how to configure into EBI system

1. Connect EBI system using Ethernet port.

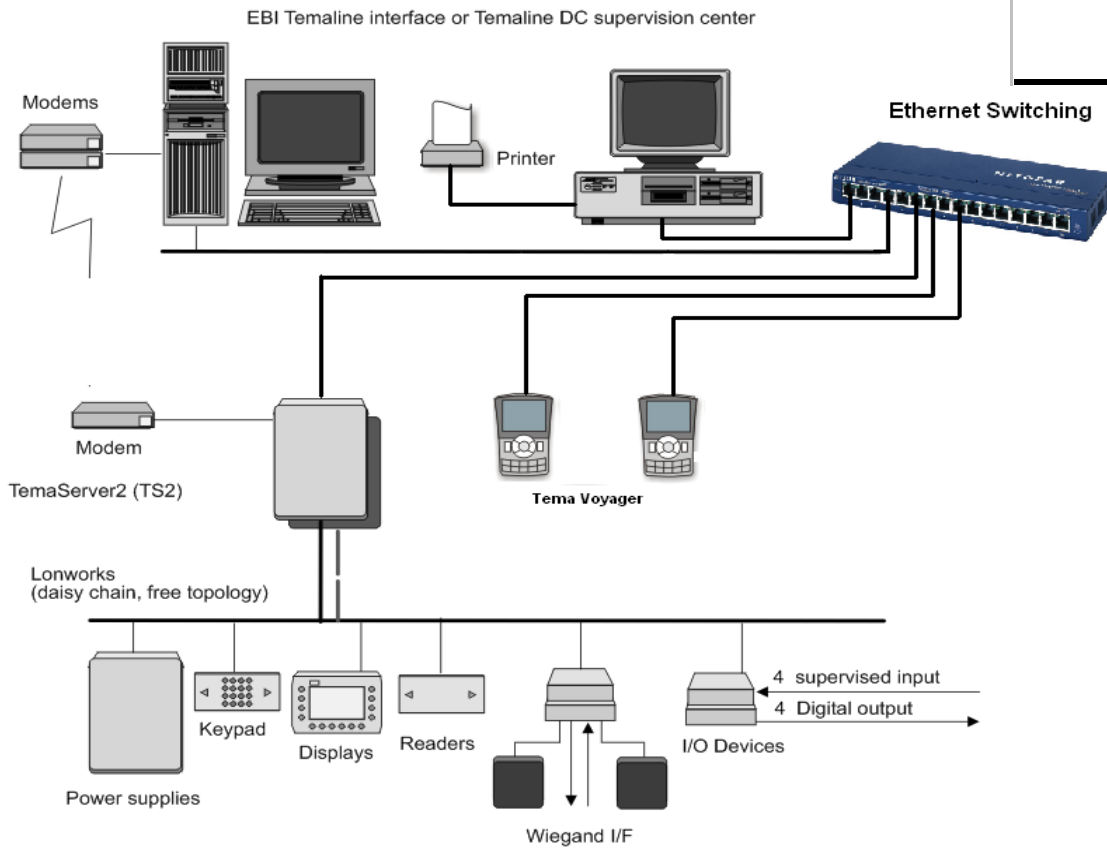

2. Steps to configure Team Voyager

Pre-requisite:

- Confirm is the MAC address of the devices are unique.

Configure Tema Voyager:

- Using EBI server Telnet tools to telnet Team Voyager device.
C:/telnet IP
- Provide below command to set the device IP and host IP
- Vts setip – to configure the Sesamo device IP
- Vts sethost – to configure EBI PC IP in the device.

```
Hon-SH-iMX27 login: root  
login[602]: root login on 'tymxc0'
```

```
root@i.MX27# telnet 127.0.0.1  
Entering character mode  
Escape character is '^]'.  
TEMA Virtual Monitor, V2.0 ready (127.0.0.1)
```

```
127.0.0.1 >> user Super Visor
Welcome Super (supervisor)

127.0.0.1 >> vts setip 159.99.252.199

VTS - Done

127.0.0.1 >> vts sethost 159.99.252.240

VTS - Done

127.0.0.1 >> vts reboot

VTS Request sent

127.0.0.1 >> Calling System reboot
```

- Before providing “>> vts reboot”, set the Jumper #3 to OFF position to avoid system restore to factory defaults again.

3. Configure Tema Voyager in EBI server:

- Connect the Tema Voyager and EBI PC in the network.
- Create a new Tema Voyager and configure the device IP in EBI page.

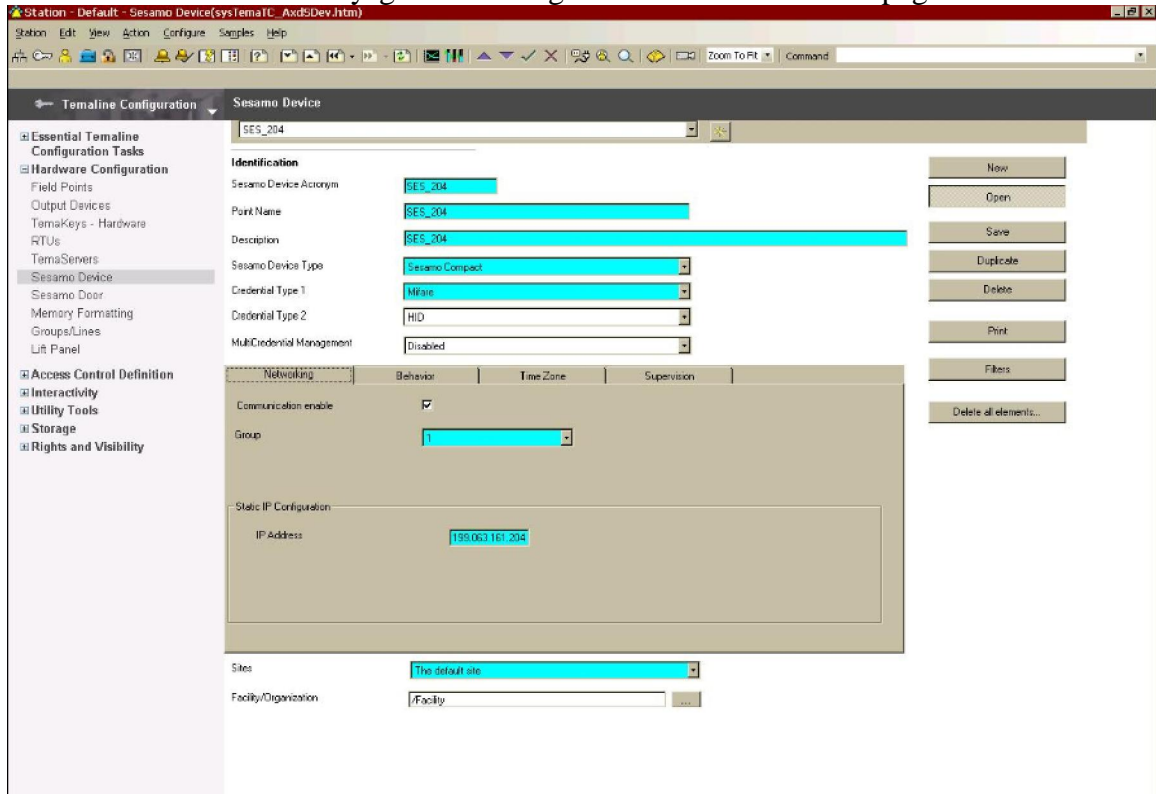

- Create a new Sesamo door and assign the device. Configure the Gate as displayed in the attachment.

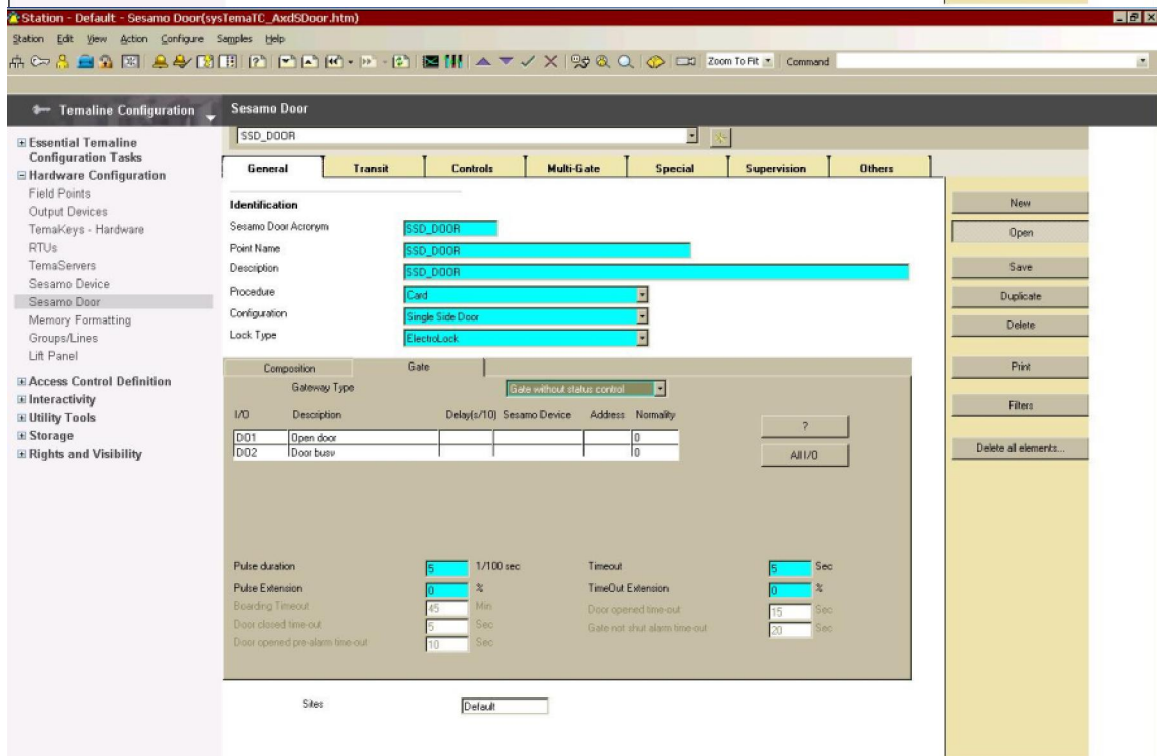
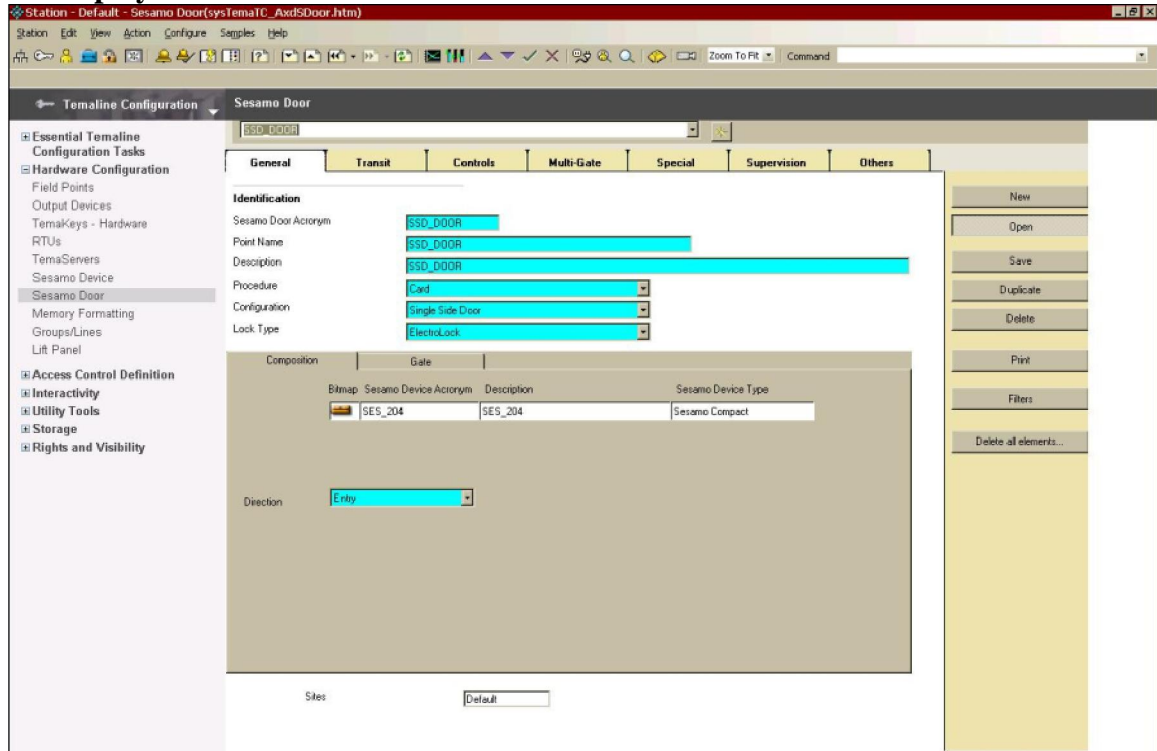

Ethernet Connecting and how to configure into EBI system

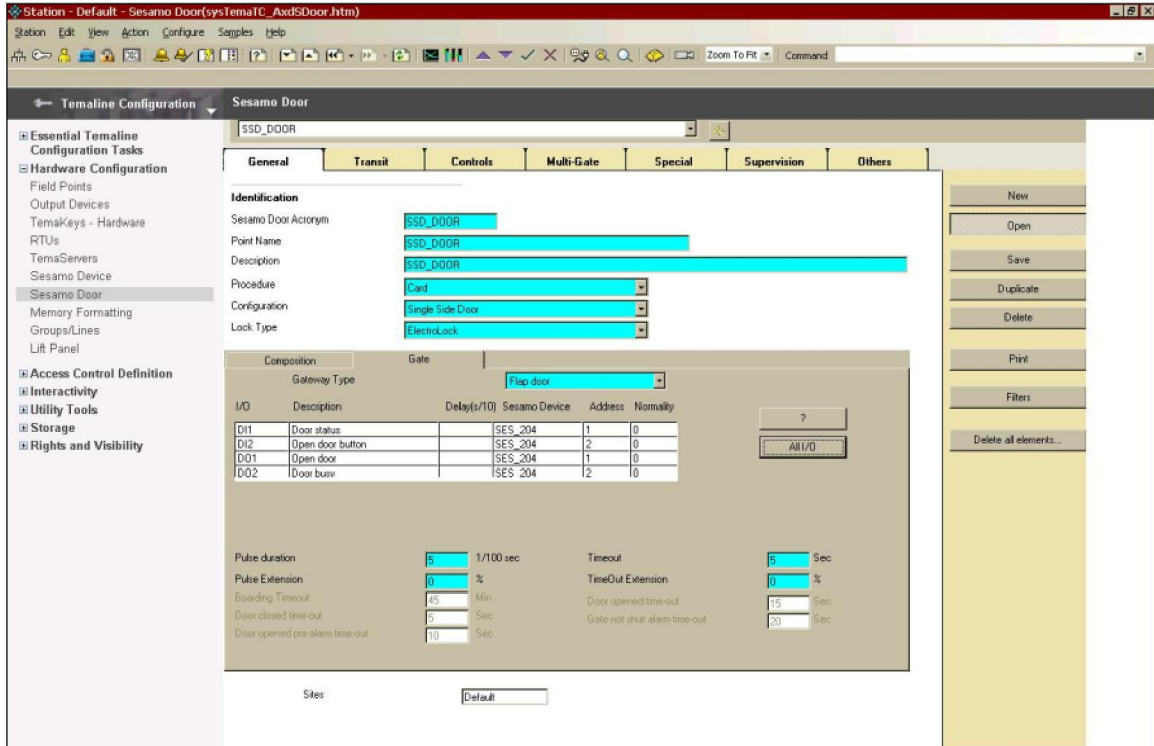

- Go to Behavior model page and check the newly created door and save.

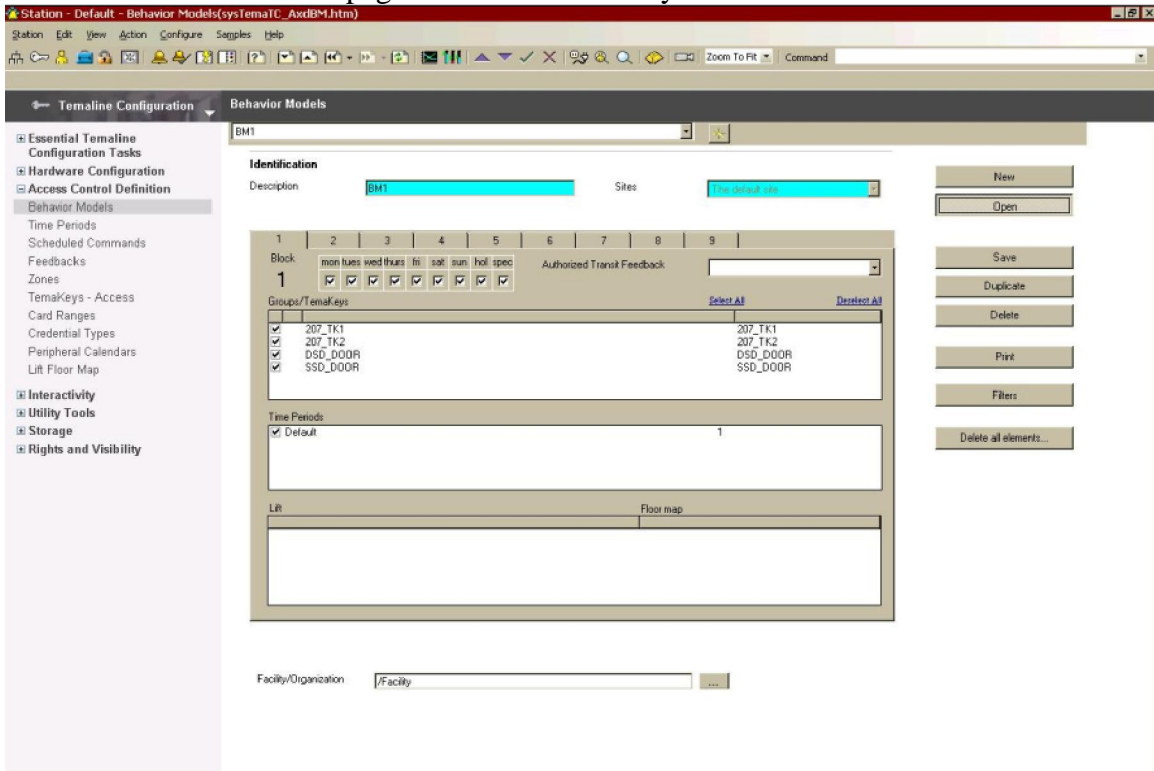

- Once details are downloaded to device verify by showing cards. Note: Detail information please reference EBI Configure Manual.

8 Device connectors

8

All the connections are on the back of the reader inside the round area.

Figure 1 Connectors layout

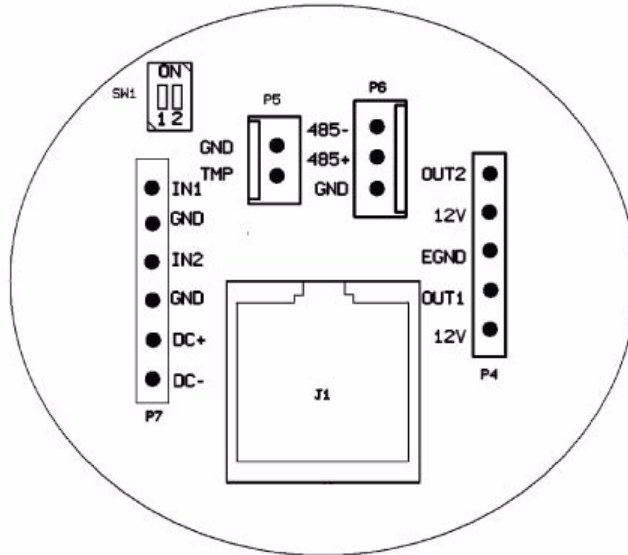

Connector	Function	Specification
J1	Ethernet interface	RJ45 Female Connector
P4	Output interface	5Pin,--3.5MM pitch, Header connector
P5	TAMPER Switch interface	2Pin,--2.5MM Pitch, Header connector

Connector	Function	Specification
P6	RS-485 communication interface	3Pin,--2.5MM Pitch, Header connector
P7	Inputs and DC power interface	6Pin,--3.5MM Pitch, Header connector
SW1	RS-485 length settings	2Pin,--1.27MM DIP switches

9 Setting inputs, outputs, and jumpers

9

Digital inputs

The device has 2 inputs and 2 outputs. The 2 inputs can be used either as digital dry contacts or supervised contacts.

Usually the IN1 is dedicated to the door contact.

Usually the IN2 is dedicated to the push button (request to exit).

However, the inputs can also be used as general purpose inputs.

The typical connection for digital dry contacts is shown in [Figure 22](#).

Figure 22 Dry contacts connections

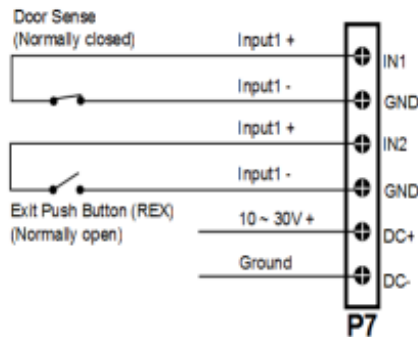

Temaline recommends that you establish an electrical environment where the cables are well separated, even at short runs, especially to the power cables or external cables which can be essentially subjected to interference or lightning.

Use a twisted-pair cable for the contact cables. Make sure that the cables correspond in size to the norms indicated in “Wire characteristics” on page 7.

Max contact resistance = 25 Ohm

Supervised inputs

The typical connection for supervised inputs is shown in [Figure 23](#). Put the resistors close to the contact.

Figure 23 Supervised input connection

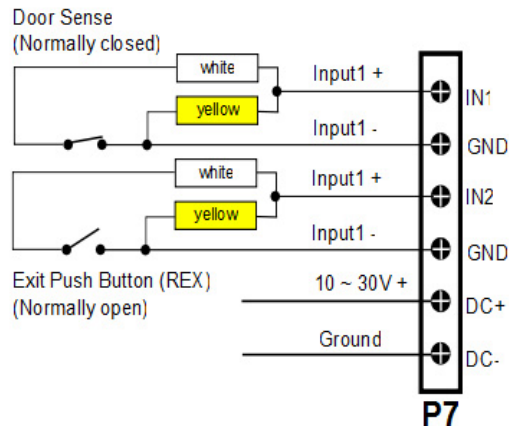

Yellow resistor: 1210 Ohm 1%

White resistor: 392 Ohm 1%

Close contact resistance: 296 Ohm

Open contact resistance: 1210 Ohm

Temaline recommends that you establish an electrical environment where the cables are well separated, even at short runs, especially to the power cables or external cables which can be essentially subjected to interference or lightning.

Use a twisted-pair cable for the contact cables. Make sure that the cables correspond in size to the norms indicated in section INPUT WIRES...

Max contact resistance = 25 Ohm

Outputs

Internally, the output lines are provided with Power Mosfet. Using an external power supply, the output current must not exceed 1.2A/30V continuous or 5A/30V (0.5 sec) peak current for inductive loads. Using the internal power supply, the output current must not exceed 30mA.

Usually the OUT1 is dedicated to the Door Electro lock.

Usually the OUT2 is dedicated to the busy lamp.

Outputs can be also used as general purpose outputs.

Temaline recommends that you establish an electrical environment where the cables are well separated, even at short runs, especially to the power cables or external cables which can be essentially subjected to interference or lightning.

External relays powered by the reader

When the load exceeds the max internal current of 30 mA you must use an external relay.

Figure 24 Relays OUT

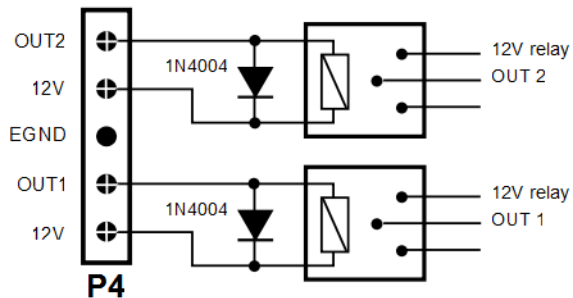



Note: Use 12VDC relay - max coil current = 30mA each. In this case you must use the 1N4004 diodes shown in [Figure 24](#).

Connecting the door lock directly using an external power supply

You can connect the door lock directly to the reader using an external power supply. The current shall not exceed 1,2A or a peak of 5A for a period of 0,5 sec max.

Figure 25 Connecting loads using an external isolated power supply

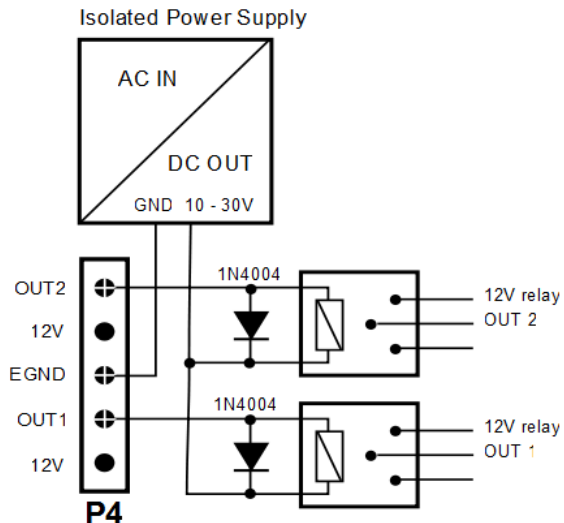

Notes: For not-resistive loads:

- You must use the 1N4004 diodes as shown in [Figure 25](#). Two diodes are included in the package.
- The external power supply must be isolated.

Jumpers

There is a DIP switch (include two bits) in the circle. It is used for selecting RS-485 matched distance mode.

The Voyager equipment supports biasing and end-of-line termination for the RS-485 network.

- a. RS-485 allows the wiring of a multidrop communication network of up to 1200 m in length. SW1 DIP switches Pin1, Pin2 set in ON position.
- b. RS-485 Port communication network should not exceed 15 m in length. SW1 DIP switches PIN1, PIN2 set in OFF position.

Figure 26 Jumpers



Jumper	ON/OFF	Function
SW1.1&2	ON	Long distance - up to 1200m
	OFF	Short distance - up to 15m

Error messages

10

This chapter presents tables of possible maintenance, mode, door, and transit error messages.

Table 4 Maintenance error messages





Status	Icon	Caption	Meaning and Action
Database download in progress		DB DOWNLOAD IN PROGRESS	The DB download is in progress. You may use the device but you may experience some delay in response time.
Terminal/door out of order		OUT OF ORDER	The reader or the door controlled is experiencing technical difficulties. You may not use the device at this time.
Terminal not configured		OUT OF ORDER	The reader has not yet been configured. You may not use the device at this time.
Transit buffer full		TRANSIT BUFFER FULL	There is no more space available on the device to store transits. To prevent further loss of transits, this device has been blocked.

Table 5 Mode error messages



Status	Icon	Caption	Meaning and Action
Overdriven modality		DEVICE IN OVERDRIVEN MODALITY	This device is set in overdrive mode. You do not need this device to authorize the transit.
Reply not received		REPLY NOT RECEIVED	Due to lack of response from the Supervision Center, the desired operation is cancelled. Retry the operation, and if the problem persists contact your system administrator.
Waiting for reply		WAITING FOR REPLY	The desired operation requires data from the Supervision Center. Please wait for approval before you continue. For more information on your site operations, contact your system administrator.

Table 6 Door error messages



Status	Icon	Caption	Meaning and Action
Door forced		DOOR FORCED	The door managed by this reader has been forced. Please notify security, then close the door to reset it.
Door locked		DOOR LOCKED	This door is locked; do not attempt to transit through this door.
Door not shut after crossing		DOOR NOT SHUT AFTER CROSSING	This door should be closed. Close the door to reset it and notify security.

Table 7 Transit error messages





















Status	Icon	Caption	Meaning and Action
Access Denied		ACCESS DENIED	Access denied. You have violated the access rules for your site. Contact your system administrator for further information and assistance.
Card Disabled		CARD DISABLED	Access denied. Your card is disabled. Contact your system administrator for further assistance.
Card outside validity limits		CARD OUTSIDE VALIDITY LIMITS	Access denied. Your card is not yet valid or has expired. Contact your system administrator for further assistance.
Door busy		PLEASE WAIT WHILE THE DOOR IS BUSY	A transit is in progress through this door. You may be unable to transit at this time.
Double transit request		PLEASE ENTER ASSOCIATED CARD	This transit requires an additional card reading to authorize the access. Enter an associated card with appropriate rights. Contact your system administrator for further information and assistance.
Feature expired		FEATURE EXPIRED	The feature you selected is not yet valid or has already expired. Contact your system administrator for further information and assistance.
Feature not available		FEATURE NOT AVAILABLE	You are not authorized to use the feature you selected. Contact your system administrator for further information and assistance.
Guard Tour		GUARD TOUR POINT ACTIVATION	This guard tour point has been activated. You can now proceed to the next step of the guard tour.
Incorrect Card Reading		INCORRECT CARD READING	The device has detected errors while reading your card. Retry, and if the problem persists contact your system administrator.
Invalid additional data		INVALID ADDITIONAL DATA	The additional data you have entered is invalid. Contact your system administrator for further information and assistance.
Invalid card		INVALID CARD	Access denied. Your card is not configured for this facility; contact your system administrator for further assistance.
Maximum number of cardholders		MAX NUMBER OF CARDHOLDER IN THE ZONE	Access denied. The maximum number of cardholders has been reached in the zone you have requested access to. Contact your system administrator for further assistance.

Table 7 Transit error messages

Status	Icon	Caption	Meaning and Action
Out of time period		INCOMPATIBLE TIME PERIOD	Access denied. You are not authorized to transit through this door on this day at this time. Contact your system administrator for further assistance.
Passback violation		PASSBACK VIOLATION	Access Contact. You have violated the passback rules. Contact your system administrator for further information and assistance.
Path control violation		PATH VIOLATION	Access denied. You have violated the path rules. Contact your system administrator for further information and assistance.
Security block		SECURITY BLOCK	Access denied. Contact your system administrator for further assistance
Selected for Security Inspection		SELECTED FOR SECURITY INSPECTION	Access denied. You have been selected for security inspection. Follow instructions from security personnel.
Threat level		RESTRICTED ACCESS	Access denied. Access to this zone is temporarily restricted due to an increase in security threat level.
Transit not happened		TRANSIT NOT HAPPENED	The door has not opened for the transit requested.
Wrong Access level		WRONG ACCESS LEVEL	Access denied. You are not authorized to transit through this door. Contact your system administrator for further assistance.
Wrong Facility Code		DOOR LOCKED	Access denied. Your card is not configured for this facility; contact your system administrator for further assistance.
Wrong PIN Code		WRONG PIN CODE	Access denied. You entered the wrong PIN code. Contact your system administrator for further assistance.

Recycling

In accordance with directive 2002/96/EC regarding waste electrical and electronic apparatus, effective August 13 2005, Honeywell commits, when requested by the customer, to the collection, treatment, recovery, and disposal of the apparatus produced.

Customers in the European Union are advised to dispose of this product at the end of its useful life in accordance with the applicable local laws, regulations, and procedures.

