

**Light Efficiency:**

**31 Lumen/Watt**

**Light Quality:**

**CRI: 95.8**

**Color Temperature:**

**3062 K**

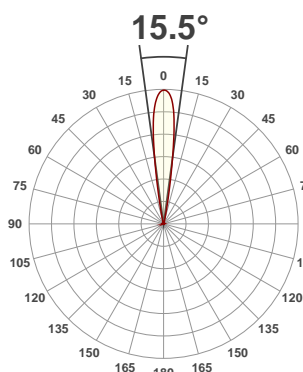

**Product Name:  
KL Fresnel 6**

**Test:  
Zoom In**

**Date:  
12/14/2017**

**Output: 5212 lm Power Consumption: 171 W Peak: 71331 Cd**

**Spectral Distribution**

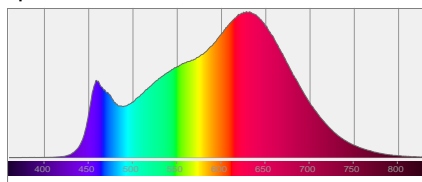

**Color Coordinates**

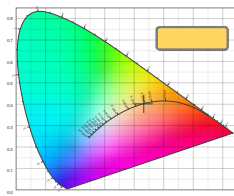

**Zoom Color Point**

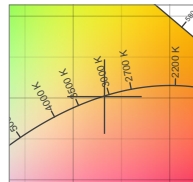

**CRI R Values**

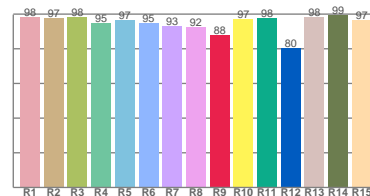

Color Temperature	Color Rendering Index	Red Component	Color Fidelity	Color Gamut	Color Quality Scale	Color Coordinate Cie 1931	Color coordinate Cie 1931	Color Coordinate	Color Coordinate	Color Divition From Black Body
CCT	CRI	CRI R9	TM30 Rf	TM30 Rg	CQS	x	y	u	v	Δuv
3062 K	95.8	87.7	88.3	96.2	92.5	0.432	0.402	0.249	0.347	0.0004

**Beam Details**

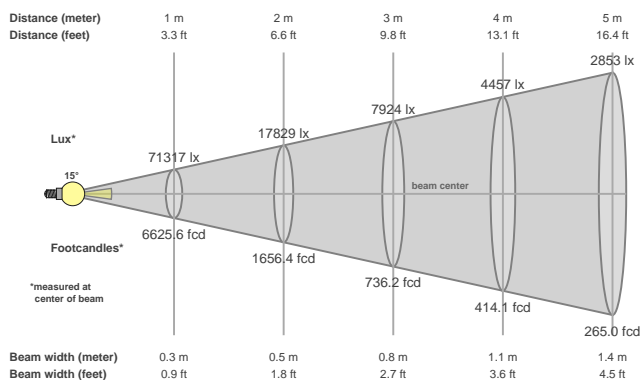

**Beam Angles**

Beam Angle 50%	Field Angle 10%	Cutoff Angle 2,5%
15.5°	23.4°	31.6°

**Beam Intensities**

Peak Intensity	Int. Ratio In 120° Cone	Int. Ratio In 90° Cone
71331 cd	98.8%	98.3%

**Power**

Power	Power Factor	Power Frequency
171 W	1.0	60 Hz

Nominal Voltage	Voltage	Current
230 V	115 V	1.49 A

**Beam Intensities from 1-20m**

1m	2m	3m	4m	5m	6m	7m	8m	9m	10m	11m	12m	13m	14m	15m	16m	17m	18m	19m	20m
3.3ft	6.6ft	9.8ft	13.1ft	16.4ft	19.7ft	23ft	26.2ft	29.5ft	32.8ft	36.1ft	39.4ft	42.7ft	45.9ft	49.2ft	52.5ft	55.8ft	59.1ft	62.3ft	65.6ft
71317lx	17829lx	7924lx	4457lx	2853lx	1981lx	1455lx	1114lx	880lx	713lx	589lx	495lx	422lx	364lx	317lx	279lx	247lx	220lx	198lx	178lx
6625.6fcd	1656.4fcd	736.2fcd	414.1fcd	265fcd	184fcd	135.2fcd	103.5fcd	81.8fcd	66.3fcd	54.8fcd	46fcd	39.2fcd	33.8fcd	29.4fcd	25.9fcd	22.9fcd	20.4fcd	18.4fcd	16.6fcd

**Light Efficiency:**

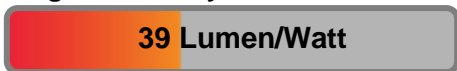

**Light Quality:**



**Color Temperature:**

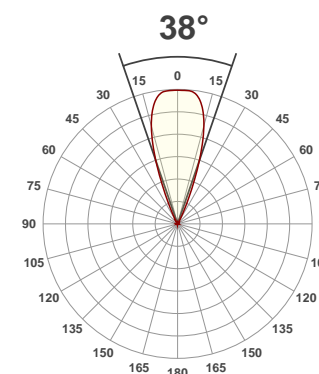
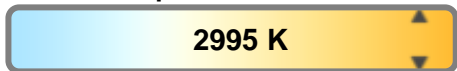

**Product Name:**  
**KL Fresnel 6**

**Test:**  
**Zoom Out**

**Date:**  
**12/14/2017**

**Output: 6597 lm Power Consumption: 170 W Peak: 17650 Cd**

**Spectral Distribution**

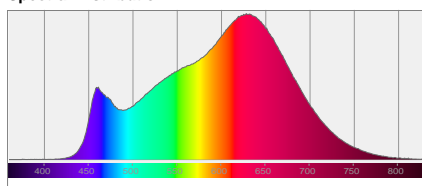

**Color Coordinates**

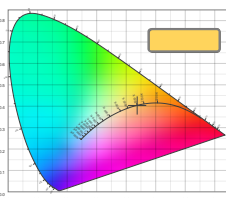

**Zoom Color Point**

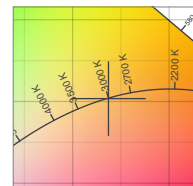

**CRI R Values**

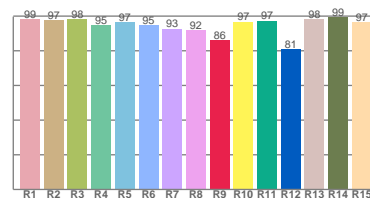

Color Temperature	Color Rendering Index	Red Component	Color Fidelity	Color Gamut	Color Quality Scale	Color Coordinate Cie 1931	Color coordinate Cie 1931	Color Coordinate	Color Coordinate	Color Division From Black Body
CCT	CRI	CRI R9	TM30 Rf	TM30 Rg	CQS	x	y	u	v	Δuv
2995 K	95.6	86.3	88.1	96.0	92.3	0.437	0.404	0.251	0.347	0.0003

**Beam Details**

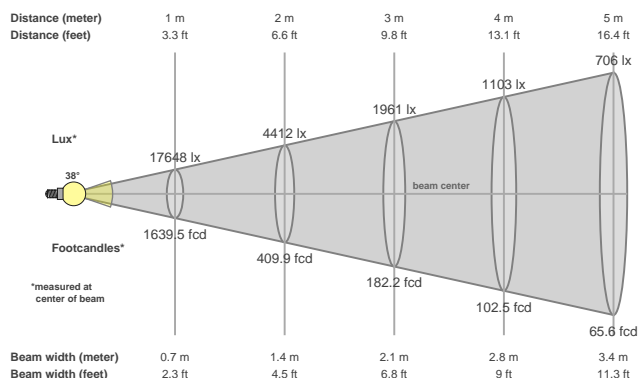

**Beam Angles**

Beam Angle 50%	Field Angle 10%	Cutoff Angle 2,5%
38°	51.8°	60.5°

**Beam Intensities**

Peak Intensity	Int. Ratio In 120° Cone	Int. Ratio In 90° Cone
17650 cd	98.7%	98.5%

**Power**

Power	Power Factor	Power Frequency
170 W	1.0	60 Hz

Nominal Voltage	Voltage	Current
230 V	115 V	1.48 A

**Beam Intensities from 1-20m**

1m	2m	3m	4m	5m	6m	7m	8m	9m	10m	11m	12m	13m	14m	15m	16m	17m	18m	19m	20m
3.3ft	6.6ft	9.8ft	13.1ft	16.4ft	19.7ft	23ft	26.2ft	29.5ft	32.8ft	36.1ft	39.4ft	42.7ft	45.9ft	49.2ft	52.5ft	55.8ft	59.1ft	62.3ft	65.6ft
17648lx	4412lx	1961lx	1103lx	706lx	490lx	360lx	276lx	218lx	176lx	146lx	123lx	104lx	90lx	78lx	69lx	61lx	54lx	49lx	44lx
1639.5fcd	409.9fcd	182.2fcd	102.5fcd	65.6fcd	45.5fcd	33.5fcd	25.6fcd	20.2fcd	16.4fcd	13.5fcd	11.4fcd	9.7fcd	8.4fcd	7.3fcd	6.4fcd	5.7fcd	5.1fcd	4.5fcd	4.1fcd