



User Manual

**CDW571AM-002
WiFi Broadband Router**

Copyright

The contents of this publication may not be reproduced in any part or as a whole, stored, transcribed in an information retrieval system, translated into any language, or transmitted in any form or by any means, mechanical, magnetic, electronic, optical, photocopying, manual, or otherwise, without the prior written permission.

Trademarks

All products, company, brand names are trademarks or registered trademarks of their respective companies. They are used for identification purpose only. Specifications are subject to be changed without prior notice.

FCC Interference Statement

This equipment has been tested and found to comply with the limits for a Class B digital device pursuant to Part 15 of the FCC Rules. These limits are designed to provide reasonable protection against radio interference in a commercial environment. This equipment can generate, use and radiate radio frequency energy and, if not installed and used in accordance with the instructions in this manual, may cause harmful interference to radio communications. Operation of this equipment in a residential area is likely to cause interference, in which case the user, at his own expense, will be required to take whatever measures are necessary to correct the interference.

CE Declaration of Conformity

This equipment complies with the requirements relating to electromagnetic compatibility, EN 55022/A1 Class B.



Table of contents

COPYRIGHT	2
FCC INTERFERENCE STATEMENT	2
CHAPTER 1 INTRODUCTION	4
1.1 PACKAGE LIST	4
1.2 HARDWARE INSTALLATION	5
CHAPTER 2 GETTING STARTED WITH EASY SETUP UTILITY	7
2.1 EASY SETUP BY WINDOWS UTILITY	7
2.2 EASY SETUP BY CONFIGURING WEB PAGES	12
CHAPTER 3 MAKING CONFIGURATION	16
3.1 BASIC SETTING	16
3.2 FORWARDING RULES	33
3.2.1 VIRTUAL SERVER	33
3.2.2 SPECIAL AP	34
3.2.3 MISCELLANEOUS	35
3.3 SECURITY SETTING	36
3.4 ADVANCED SETTING	42
3.5 TOOL BOX	54
CHAPTER 4 TROUBLESHOOTING	57
APPENDIX A. SPEC SUMMARY TABLE	61
APPENDIX B. LICENSING INFORMATION	62

Chapter 1 Introduction

The Wi-Fi Combo Router is a high-performance tool that supports wireless networking at home, work, or in a public place. The Wi-Fi Combo Router supports a USB 3G modem card, either WCDMA or EVDO and even HSDPA as well, and supports wireless data transfers up to 300M bps, and wired data transfers up to 1Gbps. The WiFi Combo Router is compatible with industry security features.

1.1 Package List

Items	Description	Contents	Quantity
1	Wi-Fi Combo Router		1
2	Power adapter		1
3	CD		1

1.2 Hardware Installation

A. Hardware configuration

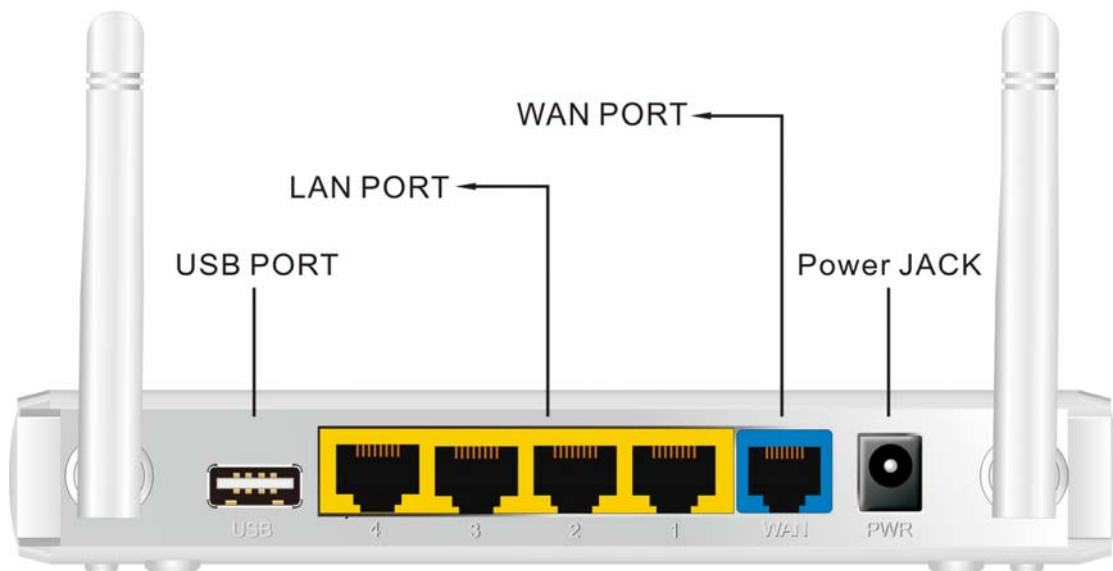
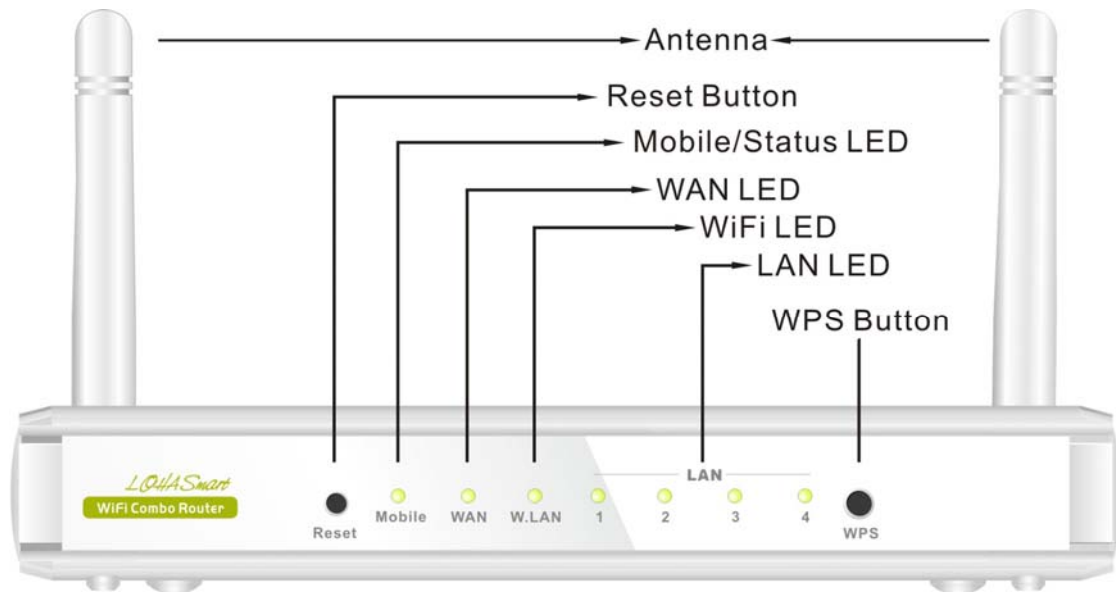

B. Installation Steps



Note: ***DO NOT*** connect the router to power before performing the installation steps below.

Step 1.

Plug a USB modem into USB port.



Step 2.

Insert RJ45 cable into LAN Port on the back panel of the router. Then plug the other end of into computer.



Step 3.

Plug the power jack into the receptor on the back panel of the router. Then plug the other end into a wall outlet or power strip.

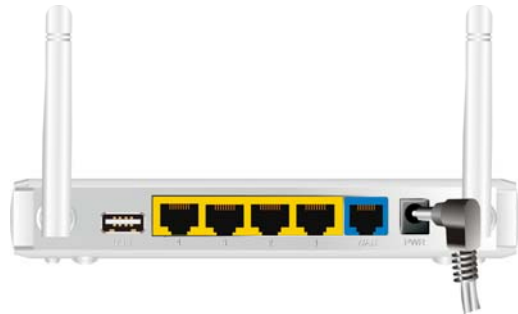

Chapter 2 Getting Started with Easy Setup Utility

There are two approaches for you to set up the Wi-Fi Combo Router quickly and easily. One is through executing the provided Windows Easy Setup Utility on your PC, and the other is through browsing the device web pages and configuration.

2.1 Easy Setup by Windows Utility

Step 1 :

Install the Easy Setup Utility from the provided CD then follow the steps to configure the device.

Step 2 :

Select Language then click "Next" to continue.



Step 3 :

Then click the "Wizard" to continue.

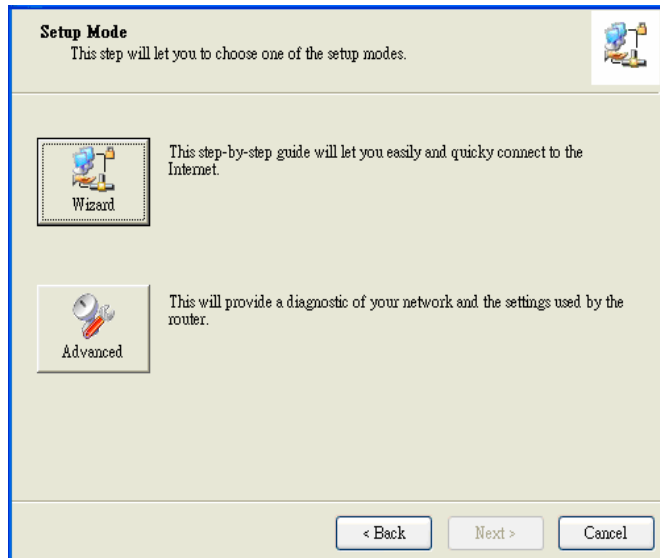

Step 4 :

Click "Next" to continue.

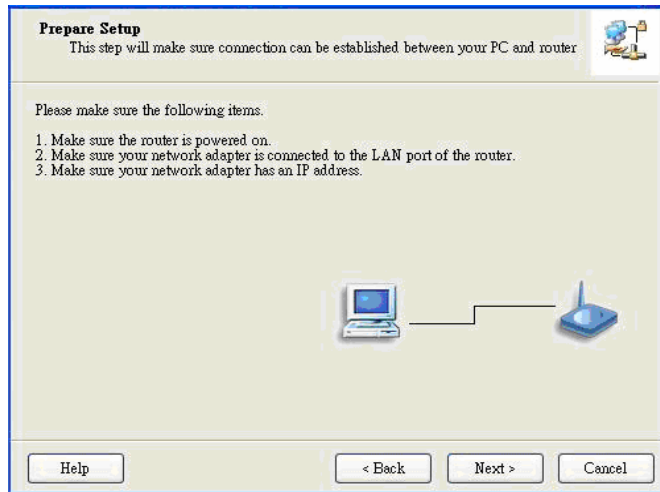

Step 5 :

Select Wireless Enable, and then click "Next" to continue.

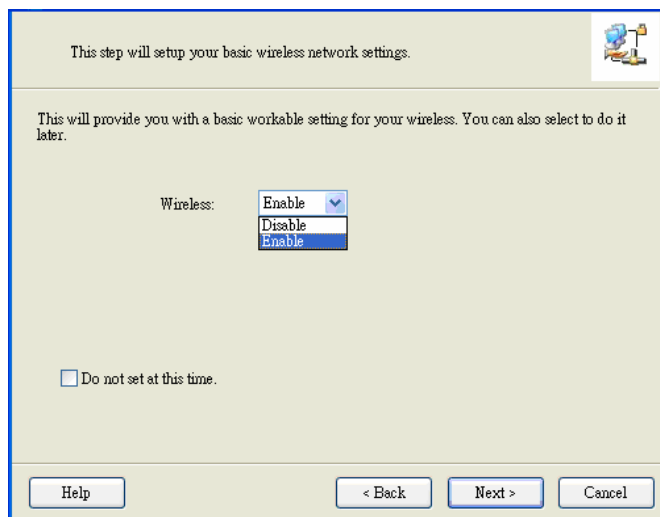

Step 6 :

Enter SSID, Channel and Security options, and then click "Next" to continue.

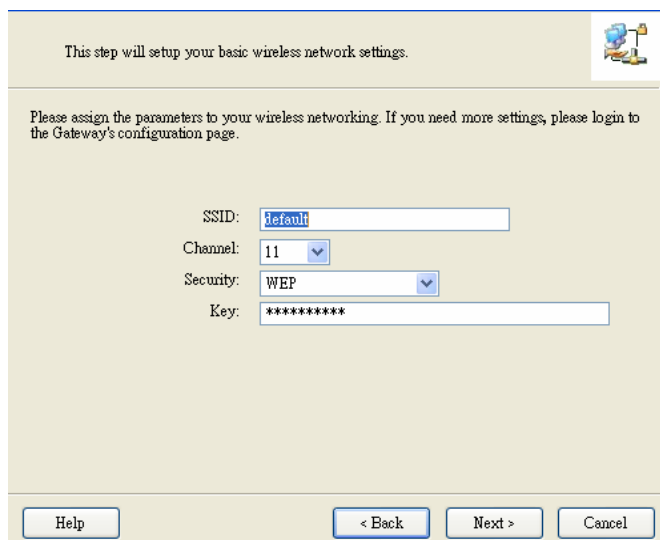

Step 7 :

Click "Let me select WAN service by myself" to select WAN service manually.

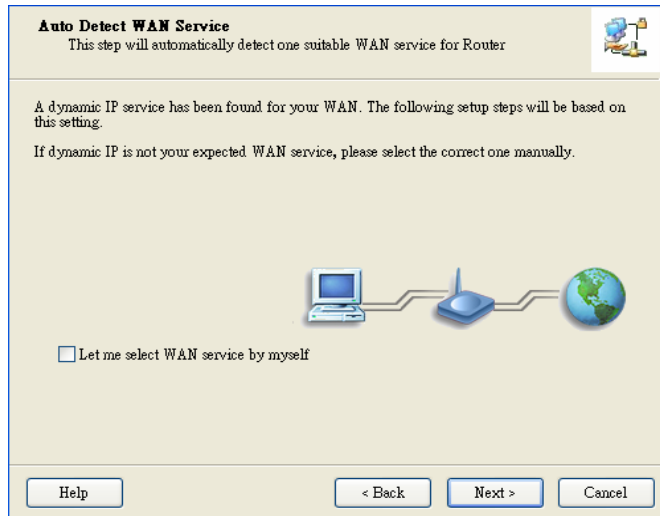

Step 8 :

Select 3G Service by clicking 3G icon to continue.



Step 9-1 :

Select "Auto-Detection" and the Utility will try to detect and configure the required 3G service settings automatically. Click "Next" to continue.

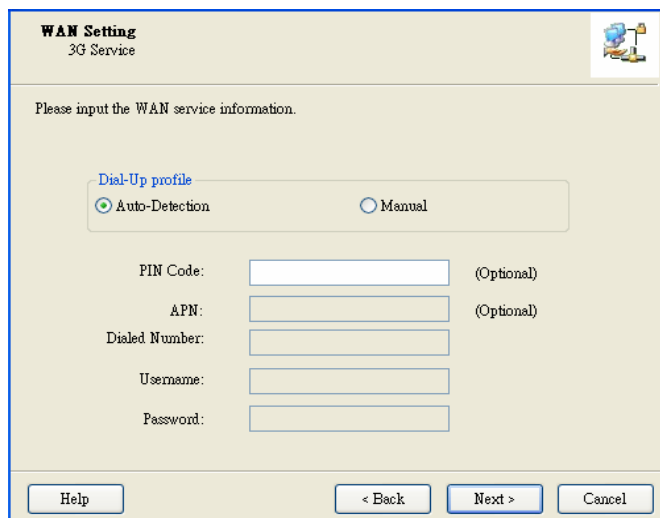

Step 9-2 :

Or you can select "Manual" and manually fill in the required 3G service settings provided by your ISP. Click "Next" to continue.

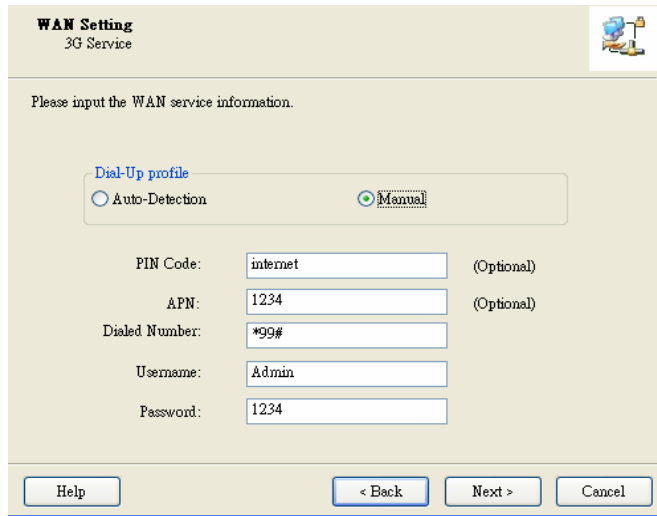

WAN Setting
3G Service

Please input the WAN service information.

Dial-Up profile
 Auto-Detection Manual

PIN Code: (Optional)
APN: (Optional)
Dialed Number:
Username:
Password:

Help < Back Next > Cancel

Step 10:

Click "Next" to save your setting.

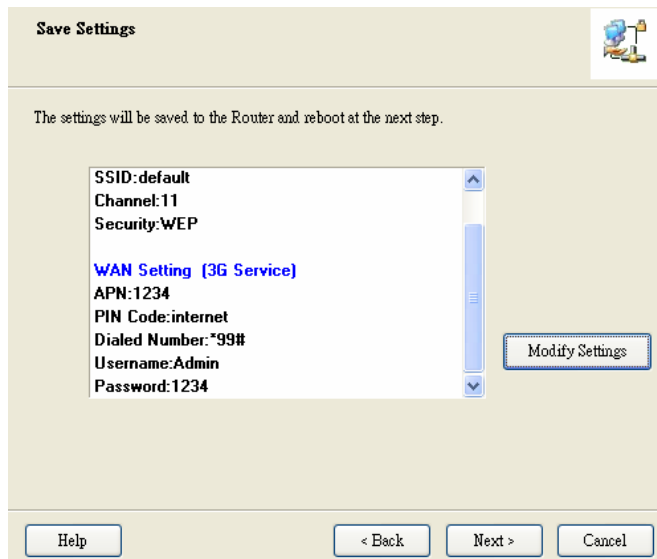

Save Settings

The settings will be saved to the Router and reboot at the next step.

SSID:default
Channel:11
Security:WEP

WAN Setting (3G Service)
APN:1234
PIN Code:internet
Dialed Number:*99#
Username:Admin
Password:1234

Modify Settings

Help < Back Next > Cancel

Step 11 :

The Wi-Fi Combo Router is rebooted to make your entire configuration take effect.

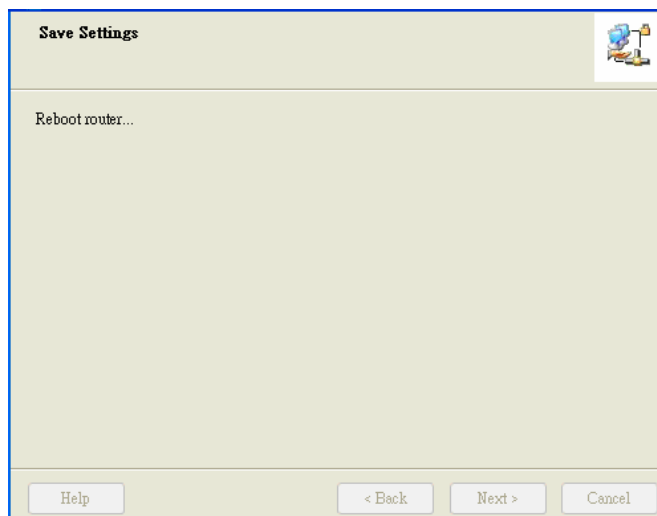

Save Settings

Reboot router...

Help < Back Next > Cancel

Step 12 :

Click "Next" to test the Internet connection or you can ignore test.

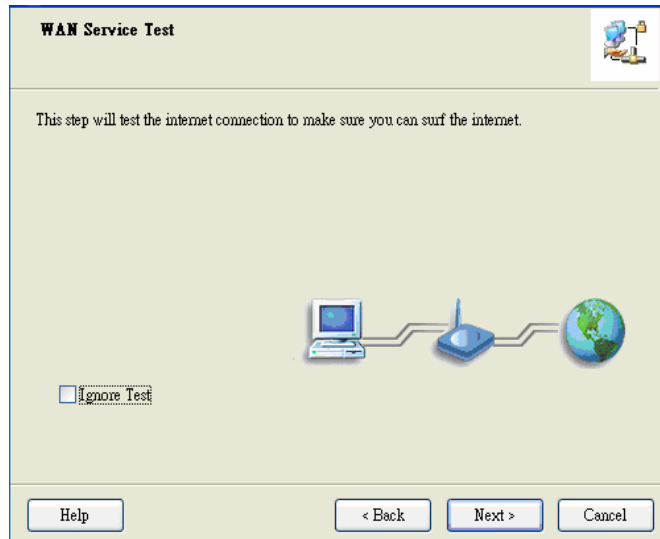

Step 13 :

Click "Next" to test WAN Networking service.

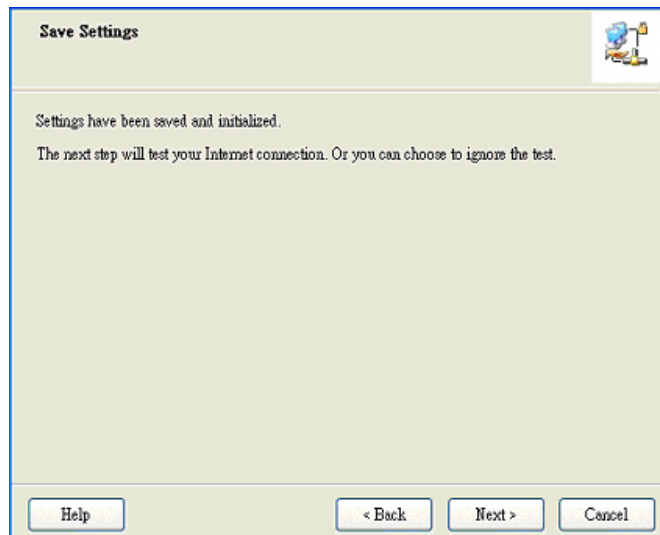

Step 14 :

Setup is completed.

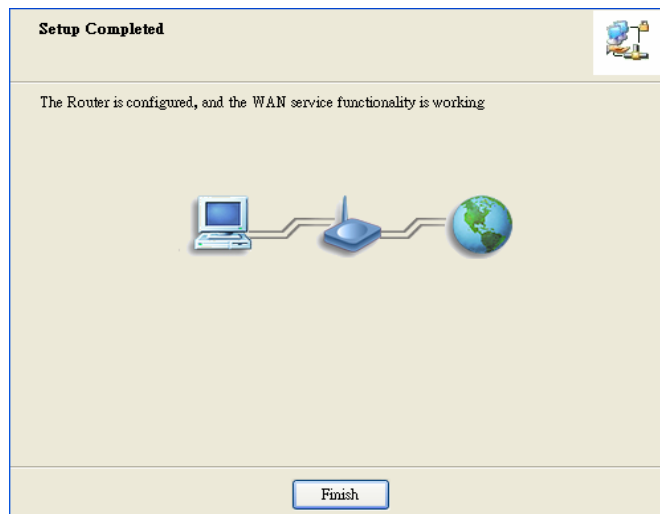

2.2 Easy Setup by Configuring Web Pages

You can also browse web UI to configure the device.

Browse to Activate the Setup Wizard

Type in the IP Address
(<http://192.168.123.254>)

Type in the default password
“admin” in the System
Password and then click
‘login’ button.

Select your language.

Select “Wizard” for basic
settings with simple way.

Press “Next” to start the Setup
Wizard.

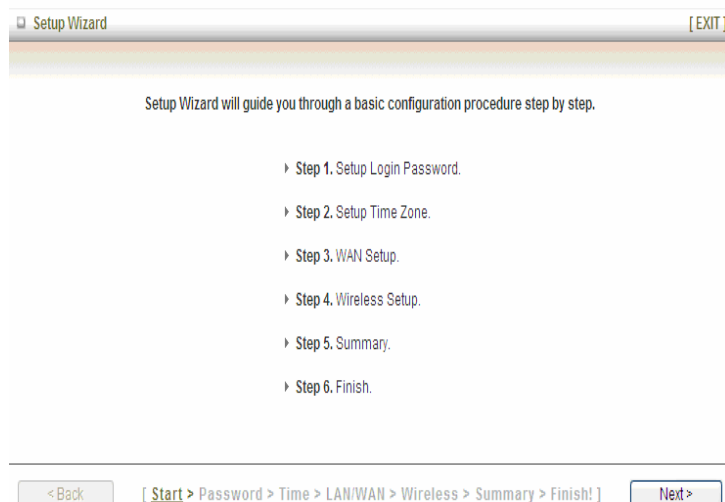
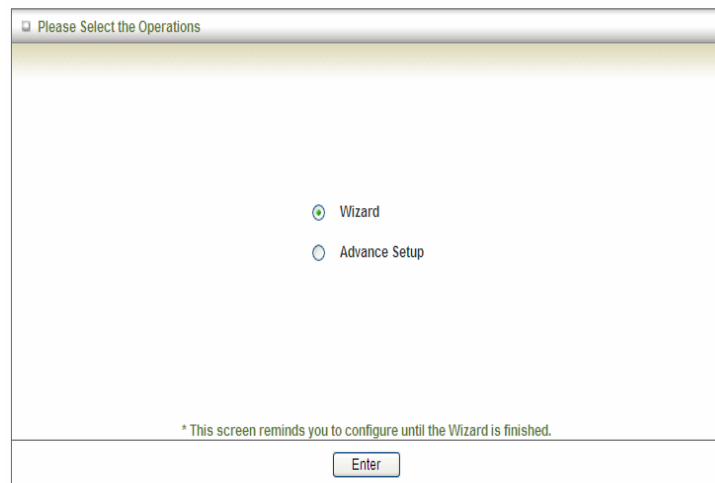
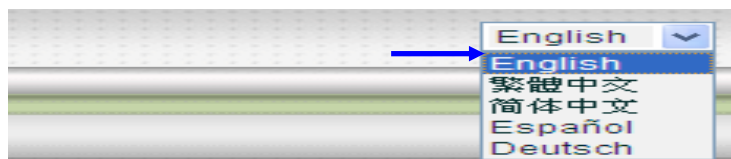
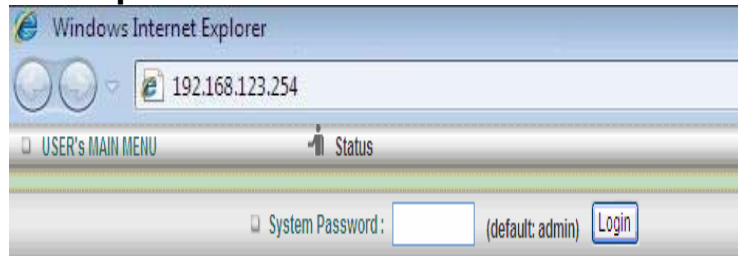

Configure with the Setup Wizard

Step 1: Change System

Password.

Set up your system password.

(Default : admin)

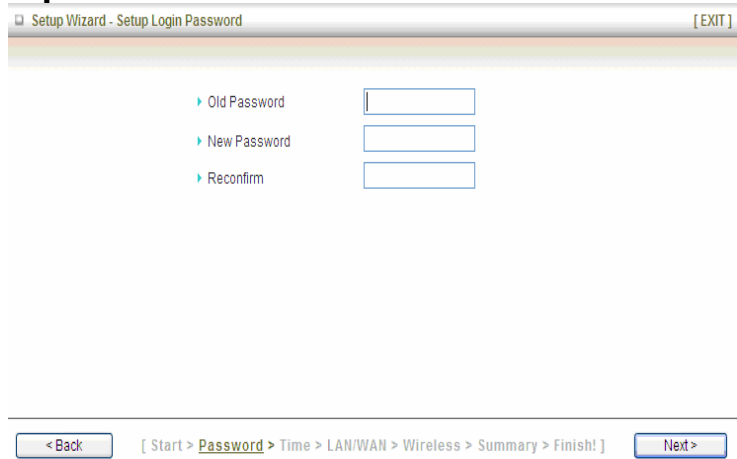

Setup Wizard - Setup Login Password [EXIT]

Old Password

New Password

Reconfirm

< Back [Start > Password > Time > LAN/WAN > Wireless > Summary > Finish!] Next >

Step 2: Select Time Zone.

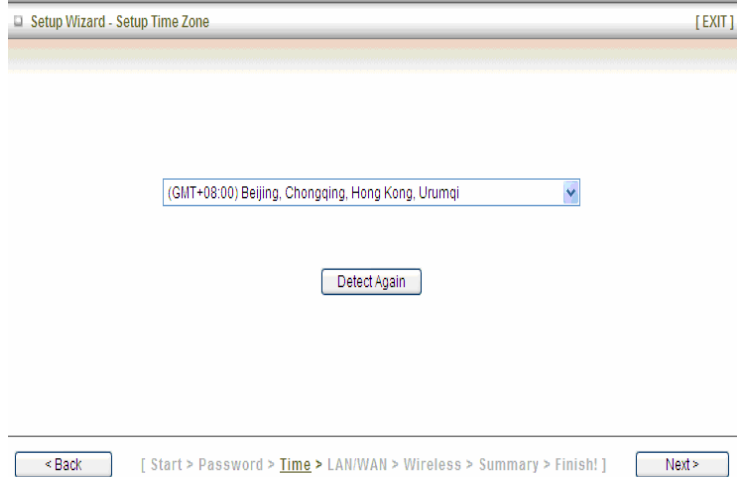

Setup Wizard - Setup Time Zone [EXIT]

(GMT+08:00) Beijing, Chongqing, Hong Kong, Urumqi

Detect Again

< Back [Start > Password > Time > LAN/WAN > Wireless > Summary > Finish!] Next >

Step 3: Select WAN Type. Choose Auto-Detecting or Manually to set WAN Type.

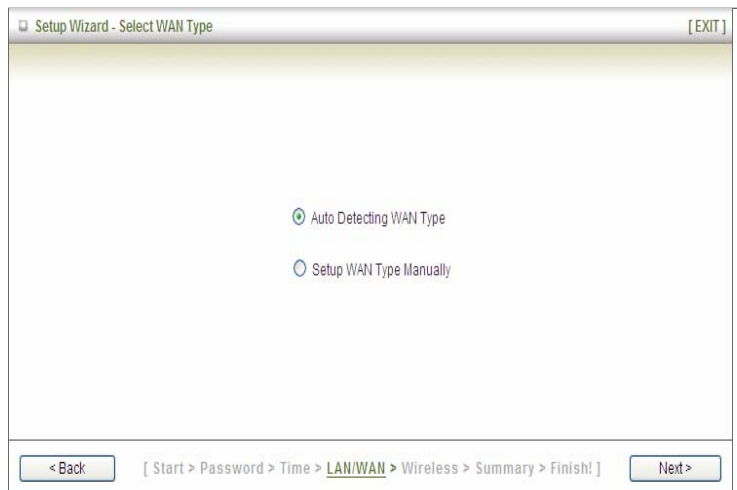

Setup Wizard - Select WAN Type [EXIT]

Auto Detecting WAN Type

Setup WAN Type Manually

< Back [Start > Password > Time > LAN/WAN > Wireless > Summary > Finish!] Next >

Step 4: Select Wan Type.
If you want to use 3G service as the main internet access, please set the WAN interface as "Wireless WAN" and the WAN type as "3G".



Setup Wizard - Select WAN Type [EXIT]

LAN IP Address: 192.168.1.1

WAN Interface: Wireless WAN

WAN Type: 3G

< Back [Start > Password > Time > LAN/WAN > Wireless > Summary > Finish!] Next >

Step 5: 3G Mode.
Select Auto-Detection then click "Next" to continue.

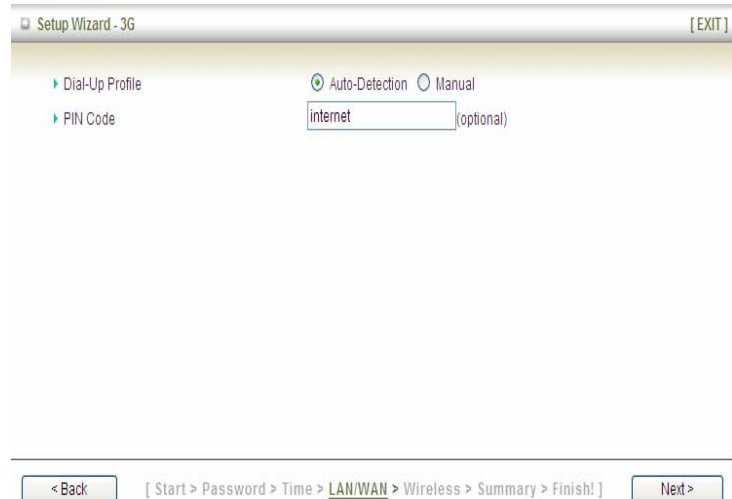

Setup Wizard - 3G [EXIT]

Dial-Up Profile: Auto-Detection Manual

PIN Code: internet (optional)

< Back [Start > Password > Time > LAN/WAN > Wireless > Summary > Finish!] Next >

Step 6: Set up your Wireless Network.
Set up your SSID.

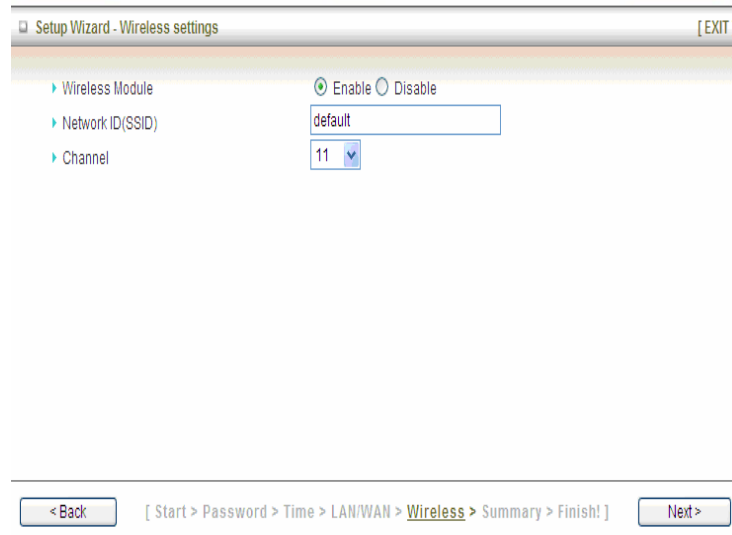

Setup Wizard - Wireless settings [EXIT]

Wireless Module: Enable Disable

Network ID(SSID): default

Channel: 11

< Back [Start > Password > Time > LAN/WAN > Wireless > Summary > Finish!] Next >

Step 7: Setup your Encryption Key here, then click "Next" to continue.

Setup Wizard - Wireless settings [EXIT]

Authentication: Auto

Encryption: WEP

WEP Key 1: HEX 1234567890

WEP Key 2: HEX 1234567890

WEP Key 3: HEX 1234567890

WEP Key 4: HEX 1234567890

< Back [Start > Password > Time > LAN/WAN > **Wireless** > Summary > Finish!] Next >

Step 8: Apply your Setting. Then click Apply Setting.

Setup Wizard - Summary [EXIT]

Please confirm the information below

[WAN Setting]	
WAN Type	3G
APN	1234
PIN Code	internet
Dialed Number	*99#
Username	Admin
Password	*****

[Wireless Setting]	
Wireless	Enable
SSID	default
Channel	11
Authentication	Auto (Open/Shared)
Encryption	WEP
WEP Key	1234567890

Do you want to proceed the network testing?

< Back [Start > Password > Time > LAN/WAN > Wireless > **Summary** > Finish!] Apply Settings

Step 9: Click Finish to complete it.

Setup Wizard - Apply settings [EXIT]

Configuration is Completed.

Please click "Finish" to back to Status page.

< Back [Start > Password > Time > LAN/WAN > Wireless > Summary > **Finish!**] Finish

Chapter 3 Making Configuration

Whenever you want to configure your network or this device, you can access the Configuration Menu by opening the web-browser and typing in the IP Address of the device. The default IP Address is: 192.168.123.254

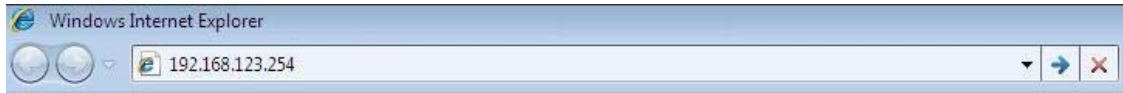

Enter the default password "admin" in the System Password and then click 'login' button.

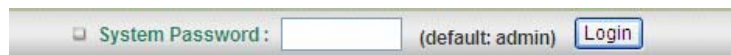
A screenshot of a login form. It features a label "System Password:" followed by a text input field. To the right of the input field is the text "(default: admin)". Further right is a blue button labeled "Login".

Then, you can browse the "Advanced" configuration pages for configuring this device.

3.1 Basic Setting

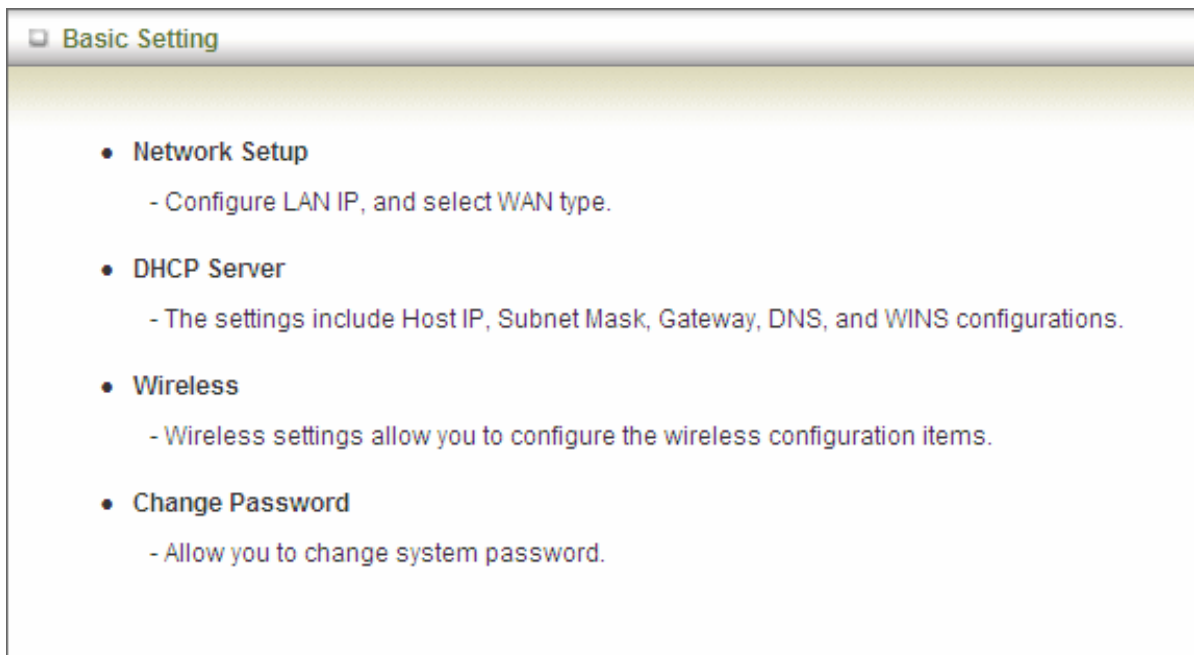

3.1.1. Network Setup

LAN Setup	
Item	Setting
▶ LAN IP Address	<input type="text" value="192.168.1.1"/>
▶ Subnet Mask	<input type="text" value="255.255.255.0"/>
Internet Setup [HELP]	
▶ WAN Interface	<input type="text" value="Ethernet WAN"/>

1. **LAN IP Address:** The local IP address of this device. The computers on your network must use the LAN IP address of this device as their Default Gateway. You can change it if necessary.
2. **Subnet Mask:** Input your Subnet mask. (All devices in the network must have the same subnet mask.) The default subnet mask is 255.255.255.0.
3. **WAN Interface:** Select Ethernet WAN or Wireless WAN to continue.
4. **WAN Type:** WAN connection type of your ISP. You can click WAN Type combo button to choose a correct one from the following options:

▶ WAN Type	<input type="text" value="Dynamic IP Address"/>
▶ Activate WWAN for Auto-Failover	<input type="text" value="Dynamic IP Address"/> <input checked="" type="text" value="Static IP Address"/> <input type="text" value="PPP over Ethernet"/> <input type="text" value="PPTP"/> <input type="text" value="L2TP"/>
▶ Host Name	<input type="text" value=""/> (optional)

A. 3G

LAN Setup	
Item	Setting
▶ LAN IP Address	<input type="text" value="192.168.1.1"/>
▶ Subnet Mask	<input type="text" value="255.255.255.0"/>
Internet Setup [HELP]	
▶ WAN Interface	Wireless WAN <input type="button" value="v"/>
▶ WAN Type	3G <input type="button" value="v"/>
▶ Dial-Up Profile	<input type="radio"/> Auto-Detection <input checked="" type="radio"/> Manual
▶ Country	Albania <input type="button" value="v"/>
▶ Telecom	Vodafone <input type="button" value="v"/>
▶ 3G Network	WCDMA/HSPA <input type="button" value="v"/>
▶ APN	<input type="text" value="1234"/> (optional)
▶ PIN Code	<input type="text" value="internet"/> (optional)
▶ Dialed Number	<input type="text" value="*99#"/>
▶ Account	<input type="text" value="Admin"/> (optional)
▶ Password	<input type="text" value="•••••"/> (optional)
▶ Authentication	<input checked="" type="radio"/> Auto <input type="radio"/> PAP <input type="radio"/> CHAP
▶ Primary DNS	<input type="text"/> (optional)
▶ Secondary DNS	<input type="text"/> (optional)
▶ Connection Control	Auto Reconnect (always-on) <input type="button" value="v"/>
▶ Allowed Connection Time	<input checked="" type="radio"/> Always <input type="radio"/> By Schedule
▶ Keep Alive	<input checked="" type="radio"/> Disable <input type="radio"/> LCP Echo Request ▶ Interval <input type="text" value="10"/> seconds ▶ Max. Failure Time <input type="text" value="3"/> times <input type="radio"/> Ping Remote Host ▶ Host IP <input type="text"/> ▶ Interval <input type="text" value="60"/> seconds
<input type="button" value="Save"/> <input type="button" value="Undo"/>	

For 3G WAN Networking. The WAN fields may not be necessary for your connection. The information on this page will only be used when your service provider requires you to enter a User Name and Password to connect with the 3G network.

Please refer to your documentation or service provider for additional information.

1. **Dial-Up Profile:** Select "Auto-Detection" or "Manual" to continue. If "Auto-Detection" is selected, the device will try to configure some ISP specific dial-up parameters automatically according to the **Country**, **Telecom**, and **3G Network** information you entered..
2. **Country:** Select your country.
3. **Telecom:** Select your telecom.
4. **3G Network:** Select the 3G Network
5. **APN:** Enter the APN for your PC card here.(Optional)
6. **Pin Code:** Enter the Pin Code for your SIM card. (Optional)
7. **Dial-Number:** This field should not be altered except when required by your service provider.
8. **Account:** Enter the new User Name for your PC card here, you can contact to your ISP to get it. (Optional)
9. **Password:** Enter the new Password for your PC card here, you can contact to your ISP to get it. (Optional)
10. **Authentication:** Choose your authentication.
11. **Primary DNS:** This feature allows you to assign a Primary DNS Server, contact to your ISP to get it. (Optional)
12. **Secondary DNS:** This feature allows you to assign a Secondary DNS Server, you can contact to your ISP to get it. (Optional)
13. **Connection Control:** Select your connection control. There are 3 modes to select:
 - Connect-on-demand: The device will link up with ISP when the clients send outgoing packets.
 - Auto Reconnect (Always-on): The device will link with ISP until the connection is established.
 - Manually: The device will not make the link until someone clicks the connect-button in the Status-page.
14. **Keep Alive:** This feature must collocate with the function "Auto" of "Auto Connect". Enable it to keep the connection always be established.
15. **LCP Echo Request:** Enter the time interval and the maximum failure count. The device will constantly send out the LCP packets for keeping the connection alive.
16. **Ping Remote Host:** Enter the Remote host IP and the time interval to send the ping packets for keeping the connection alive.

B. Static IP Address:

LAN Setup	
Item	Setting
▶ LAN IP Address	<input type="text" value="192.168.1.1"/>
▶ Subnet Mask	<input type="text" value="255.255.255.0"/>
Internet Setup [HELP]	
▶ WAN Interface	Ethernet WAN <input type="button" value="v"/>
▶ WAN Type	Static IP Address <input type="button" value="v"/>
▶ Activate WWAN for Auto-Failover	<input type="checkbox"/> Enable Remote Host for keep alive: <input type="text"/>
▶ WAN IP Address	<input type="text"/>
▶ WAN Subnet Mask	<input type="text"/>
▶ WAN Gateway	<input type="text"/>
▶ Primary DNS	<input type="text"/>
▶ Secondary DNS	<input type="text"/>
▶ NAT disable	<input type="checkbox"/> Enable
<input type="button" value="Save"/> <input type="button" value="Undo"/>	

1. **Activate WWAN for Auto-Failover:** With this function enabled, when the Ethernet WAN connection is broken, the device will automatically activate the WWAN connection and keep you connected to internet with the alternative WWAN broadband service. Meanwhile, if the device detected that the Ethernet WAN connection is recovered, your broadband connection will be switched to use the Ethernet WAN service.
2. **WAN IP Address, Subnet Mask, Gateway, Primary and Secondary DNS:** Enter the proper settings provided by your ISP.

C. Dynamic IP Address:

LAN Setup	
Item	Setting
▶ LAN IP Address	<input type="text" value="192.168.1.1"/>
▶ Subnet Mask	<input type="text" value="255.255.255.0"/>
Internet Setup [HELP]	
▶ WAN Interface	Ethernet WAN ▼
▶ WAN Type	Dynamic IP Address ▼
▶ Activate WWAN for Auto-Failover	<input type="checkbox"/> Enable Remote Host for keep alive: <input type="text"/>
▶ Host Name	<input type="text"/> (optional)
▶ ISP registered MAC Address	<input type="text" value="00:0B:6A:F4:40:D6"/> <input type="button" value="Clear"/>
▶ Connection Control	Connect-on-Demand ▼
▶ NAT disable	<input type="checkbox"/> Enable
<input type="button" value="Save"/> <input type="button" value="Undo"/>	

1. **Activate WWAN for Auto-Failover:** With this function enabled, when the Ethernet WAN connection is broken, the device will automatically activate the WWAN connection and keep you connected to internet with the alternative WWAN broadband service. Meanwhile, if the device detected that the Ethernet WAN connection is recovered, your broadband connection will be switched to use the Ethernet WAN service
2. **Host Name:** Optional, required by some ISPs, for example, @Home.
3. **Connection Control:** There are 3 modes to select:
 - Connect-on-demand:** The device will link up with ISP when the clients send outgoing packets.
 - Auto Reconnect (Always-on):** The device will link with ISP until the connection is established.
 - Manually:** The device will not make the link until someone clicks the connect-button in the Status-page.

D. PPP over Ethernet

LAN Setup	
Item	Setting
▶ LAN IP Address	<input type="text" value="192.168.1.1"/>
▶ Subnet Mask	<input type="text" value="255.255.255.0"/>
Internet Setup [HELP]	
▶ WAN Interface	Ethernet WAN <input type="button" value="v"/>
▶ WAN Type	PPP over Ethernet <input type="button" value="v"/>
▶ Activate WWAN for Auto-Failover	<input type="checkbox"/> Enable Remote Host for keep alive: <input type="text"/>
▶ PPPoE Account	<input type="text"/>
▶ PPPoE Password	<input type="password" value="•••••"/>
▶ Primary DNS	<input type="text"/>
▶ Secondary DNS	<input type="text"/>
▶ Connection Control	Connect-on-Demand <input type="button" value="v"/>
▶ Maximum Idle Time	<input type="text" value="600"/> seconds
▶ PPPoE Service Name	<input type="text"/> (optional)
▶ Assigned IP Address	<input type="text"/> (optional)
▶ MTU	<input type="text" value="0"/> (0 is auto)
▶ NAT disable	<input type="checkbox"/> Enable
<input type="button" value="Save"/> <input type="button" value="Undo"/>	

1. **Activate WWAN for Auto-Failover:** With this function enabled, when the Ethernet WAN connection is broken, the device will automatically activate the WWAN connection and keep you connected to internet with the alternative WWAN broadband service. Meanwhile, if the device detected that the Ethernet WAN connection is recovered, your broadband connection will be switched to use the Ethernet WAN service
2. **PPPoE Account and Password:** The account and password your ISP assigned to you. For security, this field appears blank. If you don't want to change the password, leave it blank.

3. **Connection Control:** There are 3 modes to select:
 - Connect-on-demand:** The device will link up with ISP when the clients send outgoing packets.
 - Auto Reconnect (Always-on):** The device will link with ISP until the connection is established.
 - Manually:** The device will not make the link until someone clicks the connect-button in the Status-page.
4. **Maximum Idle Time:** the amount of time of inactivity before disconnecting your PPPoE session. Set it to zero or enable "Auto-reconnect" to disable this feature.
5. **PPPoE Service Name:** Optional. Input the service name if your ISP requires it. Otherwise, leave it blank.
6. **Maximum Transmission Unit (MTU):** Most ISP offers MTU value to users. The default MTU value is 0 (auto).

E. PPTP

LAN Setup	
Item	Setting
▶ LAN IP Address	<input type="text" value="192.168.1.1"/>
▶ Subnet Mask	<input type="text" value="255.255.255.0"/>
Internet Setup [HELP]	
▶ WAN Interface	Ethernet WAN ▾
▶ WAN Type	PPTP ▾
▶ Activate WWAN for Auto-Failover	<input type="checkbox"/> Enable Remote Host for keep alive: <input type="text"/>
▶ IP Mode	Dynamic IP Address ▾
▶ My IP Address	<input type="text"/>
▶ My Subnet Mask	<input type="text"/>
▶ Gateway IP	<input type="text"/>
▶ Server IP Address/Name	<input type="text"/>
▶ PPTP Account	<input type="text"/>
▶ PPTP Password	<input type="password" value="••••"/>
▶ Connection ID	<input type="text"/> (optional)
▶ Maximum Idle Time	<input type="text" value="600"/> seconds
▶ Connection Control	Connect-on-Demand ▾
▶ MTU	<input type="text" value="0"/> (0 is auto)
<input type="button" value="Save"/> <input type="button" value="Undo"/>	

1. **Activate WWAN for Auto-Failover:** With this function enabled, when the Ethernet WAN connection is broken, the device will automatically activate the WWAN connection and keep you connected to internet with the alternative WWAN broadband service. Meanwhile, if the device detected that the Ethernet WAN connection is recovered, your broadband connection will be switched to use the Ethernet WAN service
2. **IP Mode:** Please check the IP mode your ISP assigned, and select “Static IP Address” or “Dynamic IP Address”.
3. **My IP Address and My Subnet Mask:** The private IP address and subnet mask your ISP assigned to you.

4. **Gateway IP** and **Server IP Address/Name**: The IP address of the PPTP server and designated Gateway provided by your ISP.
5. **PPTP Account** and **Password**: The account and password your ISP assigned to you. If you don't want to change the password, keep it blank.
6. **Connection ID**: Optional. Input the connection ID if your ISP requires it.
7. **Maximum Idle Time**: the time of no activity to disconnect your PPTP session. Set it to zero or enable "Auto-reconnect" to disable this feature. If Auto-reconnect is enabled, this device will connect with ISP automatically after system is restarted or connection is dropped.
8. **Connection Control**: There are 3 modes to select:
 - Connect-on-demand**: The device will link up with ISP when the clients send outgoing packets.
 - Auto Reconnect (Always-on)**: The device will link with ISP until the connection is established.
 - Manually**: The device will not make the link until someone clicks the connect-button in the Status-page.
9. **Maximum Transmission Unit (MTU)**: Most ISP offers MTU value to users. The default MTU value is 0 (auto).

F. L2TP

LAN Setup	
Item	Setting
▶ LAN IP Address	<input type="text" value="192.168.1.1"/>
▶ Subnet Mask	<input type="text" value="255.255.255.0"/>
Internet Setup [HELP]	
▶ WAN Interface	Ethernet WAN ▼
▶ WAN Type	L2TP ▼
▶ Activate WWAN for Auto-Failover	<input type="checkbox"/> Enable Remote Host for keep alive: <input type="text"/>
▶ IP Mode	Dynamic IP Address ▼
▶ IP Address	<input type="text"/>
▶ Subnet Mask	<input type="text"/>
▶ WAN Gateway IP	<input type="text"/>
▶ Server IP Address/Name	<input type="text"/>
▶ L2TP Account	<input type="text"/>
▶ L2TP Password	<input type="password" value="•••••"/>
▶ Maximum Idle Time	<input type="text" value="600"/> seconds
▶ Connection Control	Connect-on-Demand ▼
▶ MTU	<input type="text" value="0"/> (0 is auto)
<input type="button" value="Save"/> <input type="button" value="Undo"/>	

1. **Activate WWAN for Auto-Failover:** With this function enabled, when the Ethernet WAN connection is broken, the device will automatically activate the WWAN connection and keep you connected to internet with the alternative WWAN broadband service. Meanwhile, if the device detected that the Ethernet WAN connection is recovered, your broadband connection will be switched to use the Ethernet WAN service
2. **IP Mode:** Please check the IP mode your ISP assigned, and select “Static IP Address” or “Dynamic IP Address”.
3. **My IP Address** and **My Subnet Mask:** The private IP address and subnet mask your ISP assigned to you.
4. **Gateway IP** and **Server IP Address/Name:** The IP address of the L2TP server and designated Gateway provided by your ISP.

5. **L2TP Account and Password:** The account and password your ISP assigned to you. If you don't want to change the password, keep it blank.
6. **Connection ID:** Optional. Input the connection ID if your ISP requires it.
7. **Maximum Idle Time:** The time of no activity to disconnect your L2TP session. Set it to zero or enable "Auto-reconnect" to disable this feature. If Auto-reconnect is enabled, this device will connect with ISP automatically, after system is restarted or connection is dropped.
8. **Connection Control:** There are 3 modes to select:
 - Connect-on-demand:** The device will link up with ISP when the clients send outgoing packets.
 - Auto Reconnect (Always-on):** The device will link with ISP until the connection is established.
 - Manually:** The device will not make the link until someone clicks the connect-button in the Status-page.
9. **Maximum Transmission Unit (MTU):** Most ISP offers MTU value to users. The default MTU value is 0 (auto).

3.1.2. DHCP Server

DHCP Server [HELP]	
Item	Setting
DHCP Server	<input type="radio"/> Disable <input checked="" type="radio"/> Enable
IP Pool Starting Address	<input type="text" value="100"/>
IP Pool Ending Address	<input type="text" value="200"/>
Lease Time	<input type="text" value="86400"/> Seconds
Domain Name	<input type="text"/>
<input type="button" value="Save"/> <input type="button" value="Undo"/> <input type="button" value="More>>"/> <input type="button" value="Clients List..."/> <input type="button" value="Fixed Mapping..."/>	

1. **DHCP Server:** Choose either **Disable** or **Enable**. If you enable the DHCP Server function, the following settings will be effective.
2. **IP Pool Starting/Ending Address:** Whenever there is a request, the DHCP server will automatically allocate an unused IP address from the IP address pool to the requesting computer. You must specify the starting / ending address of the IP address pool.
3. **Lease Time:** DHCP lease time to the DHCP client.
4. **Domain Name:** Optional, this information will be passed to the clients.
Press "**More>>**" and you can find more settings
5. **Primary DNS/Secondary DNS:** Optional. This feature allows you to assign a DNS Servers

6. **Primary WINS/Secondary WINS:** Optional. This feature allows you to assign a WINS Servers
7. **Gateway:** Optional. Gateway Address would be the IP address of an alternate Gateway. This function enables you to assign another gateway to your PC, when DHCP server offers an IP to your PC.

Click on “Save” to store your settings or click “Undo” to give up the changes.

Press “Clients List” and the list of DHCP clients will be shown consequently.

DHCP Clients List					
IP Address	Host Name	MAC Address	Type	Lease Time	Select
192.168.123.100	Joseph	00-0B-6A-F4-40-D6	Wired	23:59:34	<input type="checkbox"/>
<input type="button" value="Delete"/> <input type="button" value="Back"/> <input type="button" value="Refresh"/> <input type="button" value="Fixed Mapping"/>					

Press “Fixed Mapping” and the DHCP Server will reserve the special IP for designated MAC address.

Fixed Mapping [HELP]			
DHCP clients <input type="text" value="-- select one --"/> <input type="button" value="Copy to"/> <input type="text" value="--"/>			
ID	MAC Address	IP Address	Enable
1	<input type="text" value="00:0B:6A:F4:40:D6"/>	<input type="text" value="192.168.123.100"/>	<input checked="" type="checkbox"/>
2	<input type="text"/>	<input type="text"/>	<input type="checkbox"/>
3	<input type="text"/>	<input type="text"/>	<input type="checkbox"/>
4	<input type="text"/>	<input type="text"/>	<input type="checkbox"/>
5	<input type="text"/>	<input type="text"/>	<input type="checkbox"/>
6	<input type="text"/>	<input type="text"/>	<input type="checkbox"/>
7	<input type="text"/>	<input type="text"/>	<input type="checkbox"/>
8	<input type="text"/>	<input type="text"/>	<input type="checkbox"/>
9	<input type="text"/>	<input type="text"/>	<input type="checkbox"/>
10	<input type="text"/>	<input type="text"/>	<input type="checkbox"/>
<input type="button" value=" << Previous"/> <input type="button" value=" Next >>"/> <input type="button" value=" Save"/> <input type="button" value=" Undo"/> <input type="button" value=" Back"/>			

3.1.3. Wireless Settings

Wireless Setting [HELP]	
Item	Setting
Wireless Module	<input checked="" type="radio"/> Enable <input type="radio"/> Disable
Network ID(SSID)	default
SSID Broadcast	<input checked="" type="radio"/> Enable <input type="radio"/> Disable
Channel	11
Wireless Mode	B/G/N mixed
Authentication	Auto
Encryption	WEP
<input checked="" type="radio"/> WEP Key 1	HEX 1234567890
<input type="radio"/> WEP Key 2	HEX 1234567890
<input type="radio"/> WEP Key 3	HEX 1234567890
<input type="radio"/> WEP Key 4	HEX 1234567890
<input type="button" value="Save"/> <input type="button" value="Undo"/> <input type="button" value="WDS Setting..."/> <input type="button" value="WPS Setup..."/> <input type="button" value="Wireless Client List..."/>	

Wireless settings allow you to set the wireless configuration items.

- Wireless Module:** You can enable or disable wireless function.
- Network ID (SSID):** Network ID is used for identifying the Wireless LAN (WLAN). Client stations can roam freely over this device and other Access Points that have the same Network ID. (The factory default setting is "default")
- SSID Broadcast:** The router will broadcast beacons that have some information, including SSID so that wireless clients can know how many AP devices by scanning the network. Therefore, if this setting is configured as "Disable", the wireless clients can not find the device from beacons.
- Channel:** The radio channel number. The permissible channels depend on the Regulatory Domain. The factory default setting is as follow: channel 1~11 for North America. (Channel 1~13 for European (ETSI); channel1~ 14 for Japan).
- Wireless Mode:** Choose "B/G mixed", "B only", "G only", "N only", "G/N mixed" or "B/G/N mixed". The factory default setting is "B/G/N mixed".
- Authentication mode:** You may select one of authentication to secure your wireless network: Open Shared, Auto, WPA-PSK, WPA, WPA2-PSK, WPA2, WPA-PSK/WPA2-PSK, or WPA /WPA2.

Open

Open system authentication simply consists of two communications. The first is an authentication request by the client that contains the station ID (typically the MAC address). This is followed by an authentication response from the AP/router containing a success or failure message. An example of when a failure may occur is if the client's MAC address is explicitly excluded in the AP/router configuration.

Shared

Shared key authentication relies on the fact that both stations taking part in the authentication process have the same "shared" key or passphrase. The shared key is manually set on both the client station and the AP/router. Three types of shared key authentication are available today for home or small office WLAN environments.

Auto

The AP will Select the Open or Shared by the client's request automatically.

WPA-PSK

Select Encryption and Pre-share Key Mode

If you select HEX, you have to fill in 64 hexadecimal (0, 1, 2...8, 9, A, B...F) digits.

If you select ASCII, the length of pre-share key is from 8 to 63.

Fill in the key, Ex 12345678

WPA

Check Box was used to switch the function of the WPA. When the WPA function is enabled, the Wireless user must **authenticate** to this router first to use the Network service. RADIUS Server IP address or the 802.1X server's domain-name.

Select Encryption and RADIUS Shared Key

If you select HEX, you have to fill in 64 hexadecimal (0, 1, 2...8, 9, A, B...F) digits

If you select ASCII, the length of pre-share key is from 8 to 63.

Key value shared by the RADIUS server and this router. This key value is consistent with the key value in the RADIUS server.

WPA-PSK2

WPA-PSK2 user AES and TKIP for Same the encryption, the others are same the WPA-PSK.

WPA2

WPA2 add uses AES and TKIP for encryption, the others are same the WPA.

WPA-PSK/WPA-PSK2

Another encryption options for WPA-PSK-TKIP and WPA-PSK2-AES, the others are same the WPA-PSK.

WPA/WPA2

Another encryption options for WPA-TKIP and WPA2-AES, the others are same the WPA.

By pressing “**WPS Setup**”, you can configure and enable the easy setup feature WPS (Wi-Fi Protection Setup) for your wireless network.

Wi-Fi Protected Setup	
Item	Setting
▶ WPS	<input checked="" type="radio"/> Enable <input type="radio"/> Disable
▶ AP PIN	61830998 <input type="button" value="Generate New PIN"/>
▶ Config Mode	Enrollee ▼
▶ Config Status	UNCONFIGURED <input type="button" value="Set"/>
▶ Config Method	Push Button ▼
▶ WPS status	NOUSED

1. **WPS:** You can enable this function by selecting “Enable”. WPS offers a safe and easy way to allow the wireless clients connected to your wireless network.
2. **AP PIN:** You can press Generate New Pin to get an AP PIN.
3. **Config Mode:** Select your config Mode from “Registrar” or “Enrollee”.
4. **Config Status:** It shows the status of your configuration.
5. **Config Method:** You can select the Config Method here from “Pin Code” or “Push Button”.
6. **WPS status:** According to your setting, the status will show “Start Process” or “No used”

Press “Wireless Clients List” and the list of wireless clients will be shown consequently.

Wireless Clients List	
ID	MAC Address
<input type="button" value="Back"/> <input type="button" value="Refresh"/>	

3.1.4. Change Password

Change Password	
Item	Setting
▶ Old Password	<input type="text"/>
▶ New Password	<input type="text"/>
▶ Reconfirm	<input type="text"/>
<input type="button" value="Save"/> <input type="button" value="Undo"/>	

You can change the System Password here. We **strongly** recommend you to change the system password for security reason.

Click on “Save” to store your settings or click “Undo” to give up the changes.

3.2 Forwarding Rules

Forwarding Rules

- **Virtual Server**
 - Allows others to access WWW, FTP, and other services on your LAN.
- **Special Application**
 - This configuration allows some applications to connect, and work with the NAT router.
- **Miscellaneous**
 - IP Address of DMZ Host: Allows a computer to be exposed to unrestricted 2-way communication. Note that, this feature should be used only when needed.
 - UPnP Setting: If you enable UPnP function, the router will work with UPnP devices/software.

3.2.1 Virtual Server

This product's NAT firewall filters out unrecognized packets to protect your Intranet, so all hosts behind this product are invisible to the outside world. If you wish, you can make some of them accessible by enabling the Virtual Server Mapping.

A virtual server is defined as a **Service Port**, and all requests to this port will be redirected to the computer specified by the **Server IP**. **Virtual Server** can work with **Scheduling Rules**, and give user more flexibility on Access control. For the details, please refer to **Scheduling Rule**.

Virtual Server [HELP]

Well known services: -- select one -- Copy to ID --

ID	Service Ports	Server IP	Enable	Use Rule#
1	<input type="text"/>	<input type="text"/>	<input type="checkbox"/>	(0) Always ▼
2	<input type="text"/>	<input type="text"/>	<input type="checkbox"/>	(0) Always ▼
3	<input type="text"/>	<input type="text"/>	<input type="checkbox"/>	(0) Always ▼
4	<input type="text"/>	<input type="text"/>	<input type="checkbox"/>	(0) Always ▼
5	<input type="text"/>	<input type="text"/>	<input type="checkbox"/>	(0) Always ▼
6	<input type="text"/>	<input type="text"/>	<input type="checkbox"/>	(0) Always ▼
7	<input type="text"/>	<input type="text"/>	<input type="checkbox"/>	(0) Always ▼
8	<input type="text"/>	<input type="text"/>	<input type="checkbox"/>	(0) Always ▼
9	<input type="text"/>	<input type="text"/>	<input type="checkbox"/>	(0) Always ▼
10	<input type="text"/>	<input type="text"/>	<input type="checkbox"/>	(0) Always ▼
11	<input type="text"/>	<input type="text"/>	<input type="checkbox"/>	(0) Always ▼
12	<input type="text"/>	<input type="text"/>	<input type="checkbox"/>	(0) Always ▼
13	<input type="text"/>	<input type="text"/>	<input type="checkbox"/>	(0) Always ▼
14	<input type="text"/>	<input type="text"/>	<input type="checkbox"/>	(0) Always ▼

For example, if you have an FTP server (port 21) at 192.168.123.1, a Web server (port 80) at 192.168.123.2, and a VPN server at 192.168.123.6, then you need to specify the following virtual server mapping table:

Service Port	Server IP	Enable
21	192.168.123.1	V
80	192.168.123.2	V
1723	192.168.123.6	V

Click on “Save” to store your settings or click “Undo” to give up the changes.

3.2.2 Special AP

Some applications require multiple connections, like Internet games, Video conferencing, Internet telephony, etc. Because of the firewall function, these applications cannot work with a pure NAT router. **The Special Applications** feature allows some of these applications to work with this product. If the mechanism of Special Applications fails to make an application work, try setting your computer as the DMZ host instead.

Special Applications
[HELP]

Popular applications -- select one -- Copy to ID --

ID	Trigger	Incoming Ports	Enable
1	<input type="text"/>	<input type="text"/>	<input type="checkbox"/>
2	<input type="text"/>	<input type="text"/>	<input type="checkbox"/>
3	<input type="text"/>	<input type="text"/>	<input type="checkbox"/>
4	<input type="text"/>	<input type="text"/>	<input type="checkbox"/>
5	<input type="text"/>	<input type="text"/>	<input type="checkbox"/>
6	<input type="text"/>	<input type="text"/>	<input type="checkbox"/>
7	<input type="text"/>	<input type="text"/>	<input type="checkbox"/>
8	<input type="text"/>	<input type="text"/>	<input type="checkbox"/>

Save Undo

1. **Trigger:** The outbound port number issued by the application.
2. **Incoming Ports:** When the trigger packet is detected, the inbound packets sent to the specified port numbers are allowed to pass through the firewall.

This device provides some predefined settings. Select your application and click “Copy to” to add the predefined setting to your list.

Click on “Save” to store your settings or click “Undo” to give up the changes.

3.2.3 Miscellaneous

Miscellaneous Items		[HELP]
Item	Setting	Enable
▶ IP Address of DMZ Host	<input type="text"/>	<input type="checkbox"/>
▶ UPnP setting		<input checked="" type="checkbox"/>

1. IP Address of DMZ Host

DMZ (Demilitarized Zone) Host is a host without the protection of firewall. It allows a computer to be exposed to unrestricted 2-way communication for Internet games, Video conferencing, Internet telephony and other special applications.

2. UPnP Setting

The device supports the UPnP function. If the OS of your client computer supports this function, and you enabled it, like Windows XP, you can see the following icon when the client computer gets IP from the device.



Click on “Save” to store your settings or click “Undo” to give up the changes.

3.3 Security Setting

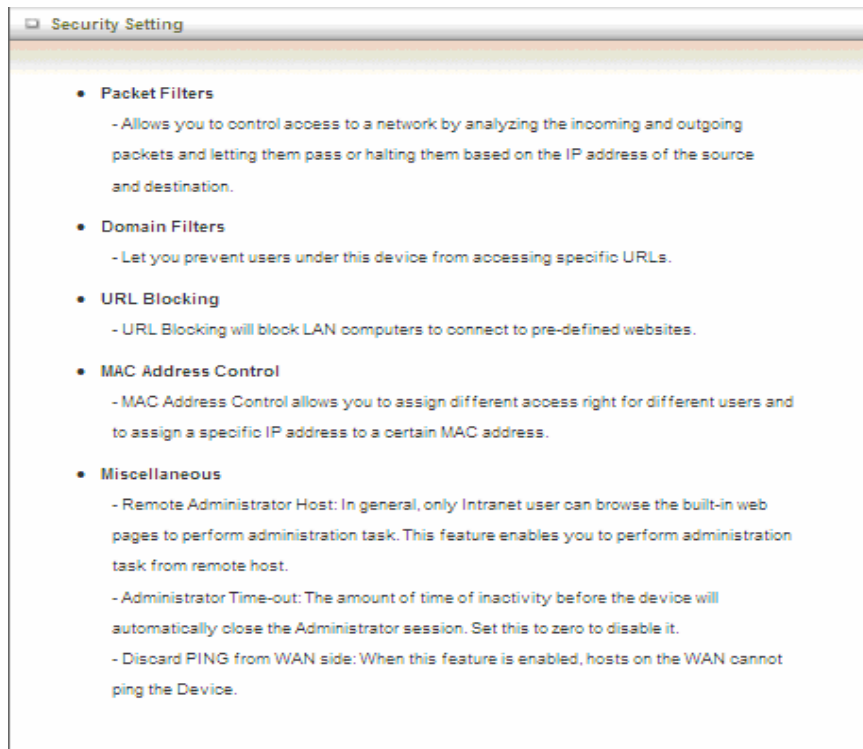

3.3.1 Packet Filters

Packet Filter includes both outbound filter and inbound filter. And they have same way to setting.

Packet Filter enables you to control what packets are allowed to pass the router. Outbound filter applies on all outbound packets. However, inbound filter applies on packets that destined to Virtual Servers or DMZ host only. You can select one of the two filtering policies:

1. Allow all to pass except those match the specified rules
2. Deny all to pass except those match the specified rules

Outbound Packet Filter [HELP]				
Item		Setting		
▶ OutboundPacket Filter		<input type="checkbox"/> Enable		
<input checked="" type="radio"/> Allow all to pass except those match the following rules. <input type="radio"/> Deny all to pass except those match the following rules.				
ID	Source IP	Destination IP : Ports	Enable	Use rule#
1	<input type="text"/>	<input type="text"/> : <input type="text"/>	<input type="checkbox"/>	(0) Always ▼
2	<input type="text"/>	<input type="text"/> : <input type="text"/>	<input type="checkbox"/>	(0) Always ▼
3	<input type="text"/>	<input type="text"/> : <input type="text"/>	<input type="checkbox"/>	(0) Always ▼
4	<input type="text"/>	<input type="text"/> : <input type="text"/>	<input type="checkbox"/>	(0) Always ▼
5	<input type="text"/>	<input type="text"/> : <input type="text"/>	<input type="checkbox"/>	(0) Always ▼
6	<input type="text"/>	<input type="text"/> : <input type="text"/>	<input type="checkbox"/>	(0) Always ▼
7	<input type="text"/>	<input type="text"/> : <input type="text"/>	<input type="checkbox"/>	(0) Always ▼
8	<input type="text"/>	<input type="text"/> : <input type="text"/>	<input type="checkbox"/>	(0) Always ▼
<input type="button" value="Save"/> <input type="button" value="Undo"/> <input type="button" value="Inbound Filter..."/> <input type="button" value="MAC Level..."/>				

You can specify 8 rules for each direction: inbound or outbound. For each rule, you can define the following:

- Source IP address
- Source port
- Destination IP address
- Destination port
- Protocol: TCP or UDP or both.
- Use Rule#

For source or destination IP address, you can define a single IP address (4.3.2.1) or a range of IP addresses (4.3.2.1-4.3.2.254). An empty implies all IP addresses.

For source or destination port, you can define a single port (80) or a range of ports (1000-1999). Add prefix "T" or "U" to specify TCP or UDP protocol. For example, T80, U53, U2000-2999, No prefix indicates both TCP and UDP are defined. An empty implies all port addresses. Packet Filter can work with **Scheduling Rules**, and give user more flexibility on Access control. For Detail, please refer to **Scheduling Rule**.

Each rule can be enabled or disabled individually.

Click on "Save" to store your settings or click "Undo" to give up the changes.

3.3.2 Domain Filters

Domain Filter		[HELP]	
Item	Setting		
▶ Domain Filter	<input type="checkbox"/> Enable		
▶ Log DNS Query	<input type="checkbox"/> Enable		
▶ Privilege IP Addresses Range	From <input type="text"/> To <input type="text"/>		
ID	Domain Suffix	Action	Enable
1	<input type="text"/>	<input type="checkbox"/> Drop <input type="checkbox"/> Log	<input type="checkbox"/>
2	<input type="text"/>	<input type="checkbox"/> Drop <input type="checkbox"/> Log	<input type="checkbox"/>
3	<input type="text"/>	<input type="checkbox"/> Drop <input type="checkbox"/> Log	<input type="checkbox"/>
4	<input type="text"/>	<input type="checkbox"/> Drop <input type="checkbox"/> Log	<input type="checkbox"/>
5	<input type="text"/>	<input type="checkbox"/> Drop <input type="checkbox"/> Log	<input type="checkbox"/>
6	<input type="text"/>	<input type="checkbox"/> Drop <input type="checkbox"/> Log	<input type="checkbox"/>
7	<input type="text"/>	<input type="checkbox"/> Drop <input type="checkbox"/> Log	<input type="checkbox"/>
8	<input type="text"/>	<input type="checkbox"/> Drop <input type="checkbox"/> Log	<input type="checkbox"/>
9	<input type="text"/>	<input type="checkbox"/> Drop <input type="checkbox"/> Log	<input type="checkbox"/>
10	* (all others)	<input type="checkbox"/> Drop <input type="checkbox"/> Log	-

Domain Filter prevents users under this device from accessing specific URLs.

1. **Domain Filter:** Check if you want to enable Domain Filter.
2. **Log DNS Query:** Check if you want to log the action when someone accesses the specific URLs.
3. **Privilege IP Address Range:** Setting a group of hosts and privilege these hosts to access network without restriction.
4. **Domain Suffix:** A suffix of URL can be restricted, for example, ".com", "xxx.com".
5. **Action:** When someone is accessing the URL met the domain-suffix, what kind of action you want.
Check "Drop" to block the access. Check "Log" to log this access.
6. **Enable:** Check to enable each rule.

Click on "Save" to store your settings or click "Undo" to give up the changes.

3.3.3 URL Blocking

URL Blocking will block LAN computers to connect with pre-define Websites. The major difference between “Domain filter” and “URL Blocking” is Domain filter require user to input suffix (like .com or .org, etc), while URL Blocking require user to input a keyword only. In other words, Domain filter can block specific website, while URL Blocking can block hundreds of websites by simply a **keyword**.

URL Blocking [HELP]		
Item	Setting	
▶ URL Blocking	<input type="checkbox"/> Enable	
ID	URL	Enable
1	<input type="text"/>	<input type="checkbox"/>
2	<input type="text"/>	<input type="checkbox"/>
3	<input type="text"/>	<input type="checkbox"/>
4	<input type="text"/>	<input type="checkbox"/>
5	<input type="text"/>	<input type="checkbox"/>
6	<input type="text"/>	<input type="checkbox"/>
7	<input type="text"/>	<input type="checkbox"/>
8	<input type="text"/>	<input type="checkbox"/>
9	<input type="text"/>	<input type="checkbox"/>
10	<input type="text"/>	<input type="checkbox"/>
<input type="button" value="Save"/> <input type="button" value="Undo"/>		

1. **URL Blocking:** Check if you want to enable URL Blocking.
2. **URL:** If any part of the Website's URL matches the pre-defined word, the connection will be blocked.
For example, you can use pre-defined word "sex" to block all websites if their URLs contain pre-defined word "sex".
3. **Enable:** Check to enable each rule.

Click on “Save” to store your settings or click “Undo” to give up the changes.

3.3.4 MAC Control

MAC Address Control allows you to assign different access right for different users and to assign a specific IP address to a certain MAC address.

MAC Address Control [HELP]				
Item	Setting			
▶ MAC Address Control	<input type="checkbox"/> Enable			
<input type="checkbox"/> Connection control	Wireless and wired clients with C checked can connect to this device; and <input type="button" value="allow"/> unspecified MAC addresses to connect.			
<input type="checkbox"/> Association control	Wireless clients with A checked can associate to the wireless LAN; and <input type="button" value="allow"/> unspecified MAC addresses to associate.			
DHCP clients <input type="button" value="-- select one --"/> <input type="button" value="Copy to"/> ID <input type="button" value="--"/>				
ID	MAC Address	IP Address	C	A
1	<input type="text"/>	<input type="text"/>	<input type="checkbox"/>	<input type="checkbox"/>
2	<input type="text"/>	<input type="text"/>	<input type="checkbox"/>	<input type="checkbox"/>
3	<input type="text"/>	<input type="text"/>	<input type="checkbox"/>	<input type="checkbox"/>
4	<input type="text"/>	<input type="text"/>	<input type="checkbox"/>	<input type="checkbox"/>
5	<input type="text"/>	<input type="text"/>	<input type="checkbox"/>	<input type="checkbox"/>
<input type="button" value="<< Previous"/> <input type="button" value="Next >>"/> <input type="button" value="Save"/> <input type="button" value="Undo"/>				

1. **MAC Address Control:** Check "Enable" to enable the "MAC Address Control". All of the settings in this page will take effect only when "Enable" is checked.
2. **Connection control:** Check "Connection control" to enable the controlling of which wired and wireless clients can connect with this device. If a client is denied to connect with this device, it means the client can't access to the Internet either. Choose "allow" or "deny" to allow or deny the clients, whose MAC addresses are not in the "Control table" (please see below), to connect with this device.
3. **Association control:** Check "Association control" to enable the controlling of which wireless client can associate to the wireless LAN. If a client is denied to associate to the wireless LAN, it means the client can't send or receive any data via this device. Choose "allow" or "deny" to allow or deny the clients, whose MAC addresses are not in the "Control table", to associate to the wireless LAN.

Click on "Save" to store your settings or click "Undo" to give up the changes.

3.3.5 Miscellaneous

Miscellaneous Items		[HELP]
Item	Setting	Enable
▶ Administrator Time-out	<input type="text" value="300"/> seconds (0 to disable)	
▶ Remote Administrator Host : Port	<input type="text"/> / <input type="text"/> : <input type="text"/>	<input type="checkbox"/>
▶ Discard PING from WAN side		<input type="checkbox"/>
▶ DoS Attack Detection		<input type="checkbox"/>
<input type="button" value="Save"/> <input type="button" value="Undo"/>		

1. **Administrator Time-out:** The time of no activity to logout automatically, you may set it to zero to disable this feature.
2. **Remote Administrator Host/Port**

In general, only Intranet user can browse the built-in web pages to perform administration task. This feature enables you to perform administration task from remote host. If this feature is enabled, only the specified IP address can perform remote administration. If the specified IP address is 0.0.0.0, any host can connect with this product to perform administration task. You can use subnet mask bits "/nn" notation to specified a group of trusted IP addresses for example, "10.1.2.0/24".

NOTE: When Remote Administration is enabled, the web server port will be shifted to 80. You can change web server port to other port, too.
3. **Discard PING from WAN side:** When this feature is enabled, any host on the WAN cannot ping this product.
4. **DoS Attack Detection:** When this feature is enabled, the router will detect and log the DoS attack comes from the Internet. Currently, the router can detect the following DoS attack: SYN Attack, WinNuke, Port Scan, Ping of Death, Land Attack etc.

Click on “Save” to store your settings or click “Undo” to give up the changes.

3.4 Advanced Setting

Advanced Setting

- **System Log**
- Send system log to a dedicated host or email to specific receipts.
- **Dynamic DNS**
- To host your server on a changing IP address, you have to use dynamic domain name service (DDNS).
- **QoS Rule**
- Quality of Service can provide different priority to different users or data flows, or guarantee a certain level of performance.
- **SNMP**
- Gives a user the capability to remotely manage a computer network by polling and setting terminal values and monitoring network events.
- **Routing**
- If you have more than one routers and subnets, you may want to enable routing table to allow packets to find proper routing path and allow different subnets to communicate with each other.
- **System Time**
- Allow you to set device time manually or consult network time from NTP server.
- **Schedule Rule**
- Apply schedule rules to Packet Filters and Virtual Server.

3.4.1 System Log

System Log [HELP]

Item	Setting	Enable
▶ IP address for syslogd	<input type="text"/>	<input type="checkbox"/>
▶ Setting of Email alert		<input type="checkbox"/>
• SMTP Server : port	<input type="text"/> : <input type="text"/>	
• SMTP Username	<input type="text"/>	
• SMTP Password	<input type="text"/>	
• E-mail addresses	<input style="width: 100%;" type="text"/>	
• E-mail subject	<input type="text"/>	

This page support two methods to export system logs to specific destination by means of syslog (UDP) and SMTP(TCP). The items you have to setup including:

1. **IP Address for Sys log:** Host IP of destination where sys log will be sent to. Check **Enable** to enable this function.
2. **E-mail Alert Enable:** Check if you want to enable Email alert (send syslog via email).
3. **SMTP Server IP and Port:** Input the SMTP server IP and port, which are connected with ':'. If you do not specify port number, the default value is 25.
For example, "mail.your_url.com" or "192.168.1.100:26".
4. **Send E-mail alert to:** The recipients who will receive these logs, you can assign more than 1 recipient, using ';' or ',' to separate these email addresses.
5. **E-mail Subject:** The subject of email alert, this setting is optional.

Click on “Save” to store your settings or click “Undo” to give up the changes.

3.4.2 Dynamic DNS

To host your server on a changing IP address, you have to use dynamic domain name service (DDNS). So that anyone wishing to reach your host only needs to know the name of it. Dynamic DNS will map the name of your host to your current IP address, which changes each time you connect your Internet service provider.

Before you enable **Dynamic DNS**, you need to register an account on one of these Dynamic DNS servers that we list in **Provider** field.

Dynamic DNS [HELP]	
Item	Setting
▶ DDNS	<input checked="" type="radio"/> Disable <input type="radio"/> Enable
▶ Provider	DynDNS.org(Dynamic) ▼
▶ Host Name	<input type="text"/>
▶ Username / E-mail	<input type="text"/>
▶ Password / Key	<input type="text"/>
<input type="button" value="Save"/> <input type="button" value="Undo"/>	

To enable **Dynamic DNS** click the check box next to **Enable** in the **DDNS** field. Next you have to enter the appropriate information about your Dynamic DNS Serve .**Provider**, **Host Name**, **Username/E-mail**, and **Password/Key**. You can get this information when you register an account on a Dynamic DNS server.

Click on “Save” to store your settings or click “Undo” to give up the changes.

3.4.3 QOS

QoS Rule					
Item			Setting		
▶ QoS Control			<input type="checkbox"/> Enable		
▶ Bandwidth of Upstream			<input type="text"/> kbps (Kilobits per second)		
ID	Local IP : Ports	Remote IP : Ports	QoS Priority	Enable	Use Rule#
1	<input type="text"/> : <input type="text"/>	<input type="text"/> : <input type="text"/>	High <input type="button" value="v"/>	<input type="checkbox"/>	(0) Always <input type="button" value="v"/>
2	<input type="text"/> : <input type="text"/>	<input type="text"/> : <input type="text"/>	High <input type="button" value="v"/>	<input type="checkbox"/>	(0) Always <input type="button" value="v"/>
3	<input type="text"/> : <input type="text"/>	<input type="text"/> : <input type="text"/>	High <input type="button" value="v"/>	<input type="checkbox"/>	(0) Always <input type="button" value="v"/>
4	<input type="text"/> : <input type="text"/>	<input type="text"/> : <input type="text"/>	High <input type="button" value="v"/>	<input type="checkbox"/>	(0) Always <input type="button" value="v"/>
5	<input type="text"/> : <input type="text"/>	<input type="text"/> : <input type="text"/>	High <input type="button" value="v"/>	<input type="checkbox"/>	(0) Always <input type="button" value="v"/>
6	<input type="text"/> : <input type="text"/>	<input type="text"/> : <input type="text"/>	High <input type="button" value="v"/>	<input type="checkbox"/>	(0) Always <input type="button" value="v"/>
7	<input type="text"/> : <input type="text"/>	<input type="text"/> : <input type="text"/>	High <input type="button" value="v"/>	<input type="checkbox"/>	(0) Always <input type="button" value="v"/>
8	<input type="text"/> : <input type="text"/>	<input type="text"/> : <input type="text"/>	High <input type="button" value="v"/>	<input type="checkbox"/>	(0) Always <input type="button" value="v"/>
<input type="button" value="Save"/> <input type="button" value="Undo"/>					

Provide different priority to different users or data flows, or guarantee a certain level of performance.

1. **QOS Control:** Check **Enable** to enable this function.
2. **Bandwidth of Upstream:** Set the limitation of upstream bandwidth
3. **Local IP : Ports:** Define the Local IP address and ports of packets
4. **Remote IP : Ports:** Define the Remote IP address and ports of packets
5. **QoS Priority:** This defines the priority level of the current Policy Configuration. Packets associated with this policy will be serviced based upon the priority level set. For critical applications High or Normal level is recommended. For non-critical applications select a Low level.
6. **Enable:** Check to enable the corresponding QOS rule.
7. **User Rule#:** The QoS rule can work with Scheduling Rule number#. Please refer to the Section 3.1.4.7 Schedule Rule.

Click on “Save” to store your settings or click “Undo” to give up the changes.

3.4.4 SNMP

In brief, SNMP, the Simple Network Management Protocol, is a protocol designed to give a user the capability to remotely manage a computer network by polling and setting terminal values and monitoring network events.

SNMP Setting [HELP]	
Item	Setting
▶ Enable SNMP	<input type="checkbox"/> Local <input type="checkbox"/> Remote
▶ Get Community	<input type="text"/>
▶ Set Community	<input type="text"/>
▶ IP 1	<input type="text"/>
▶ IP 2	<input type="text"/>
▶ IP 3	<input type="text"/>
▶ IP 4	<input type="text"/>
▶ SNMP Version	<input checked="" type="radio"/> V1 <input type="radio"/> V2c
▶ WAN Access IP Address	<input type="text"/>

1. **Enable SNMP:** You must check “Local”, “Remote” or both to enable SNMP function. If “Local” is checked, this device will response request from LAN. If “Remote” is checked, this device will response request from WAN.
2. **Get Community:** The community of GetRequest that this device will respond.
3. **Set Community:** The community of SetRequest that this device will accept.
4. **IP 1, IP 2, IP 3, IP 4:** Enter the IP addresses of your SNMP Management PCs. User has to configure to where this device should send SNMP Trap message.
5. **SNMP Version:** Select proper SNMP Version that your SNMP Management software supports.
6. **WAN Access IP Address:** If you want to limit the remote SNMP access to specific computer, please enter the PC’s IP address. The default value is 0.0.0.0, and it means that any internet connected computer can get some information of the device with SNMP protocol.

Click on “Save” to store your settings or click “Undo” to give up the changes.

3.4.5 Routing

If you have more than one routers and subnets, you will need to enable routing table to allow packets to find proper routing path and allow different subnets to communicate with each other. The routing table allows you to determine which physical interface address to use for outgoing IP data grams.

Routing Table [HELP]					
Item		Setting			
▶ Dynamic Routing		<input checked="" type="radio"/> Disable <input type="radio"/> RIPv1 <input type="radio"/> RIPv2			
▶ Static Routing		<input checked="" type="radio"/> Disable <input type="radio"/> Enable			
ID	Destination	Subnet Mask	Gateway	Hop	Enable
1	<input type="text"/>	<input type="text"/>	<input type="text"/>	<input type="text"/>	<input type="checkbox"/>
2	<input type="text"/>	<input type="text"/>	<input type="text"/>	<input type="text"/>	<input type="checkbox"/>
3	<input type="text"/>	<input type="text"/>	<input type="text"/>	<input type="text"/>	<input type="checkbox"/>
4	<input type="text"/>	<input type="text"/>	<input type="text"/>	<input type="text"/>	<input type="checkbox"/>
5	<input type="text"/>	<input type="text"/>	<input type="text"/>	<input type="text"/>	<input type="checkbox"/>
6	<input type="text"/>	<input type="text"/>	<input type="text"/>	<input type="text"/>	<input type="checkbox"/>
7	<input type="text"/>	<input type="text"/>	<input type="text"/>	<input type="text"/>	<input type="checkbox"/>
8	<input type="text"/>	<input type="text"/>	<input type="text"/>	<input type="text"/>	<input type="checkbox"/>
<input type="button" value="Save"/> <input type="button" value="Undo"/>					

1. **Dynamic Routing:** Routing Information Protocol (RIP) will exchange information about destinations for computing routes throughout the network. Please select RIPv2 only if you have different subnet in your network. Otherwise, please select RIPv1 if you need this protocol.
2. **Static Routing:** For static routing, you can specify up to 8 routing rules. You can enter the **destination IP address, subnet mask, gateway, and hop** for each routing rule, and then enable or disable the rule by checking or un-checking the Enable checkbox.

Click on “Save” to store your settings or click “Undo” to give up the changes.

3.4.6 System Time

System Time [HELP]	
Item	Setting
▶ Time Zone	(GMT+08:00) Beijing, Chongqing, Hong Kong, Urumqi
▶ Auto-Synchronization	<input checked="" type="checkbox"/> Enable Time Server (RFC-868): Auto

Sync Result

Sync with my PC (undefined October 27, 2009 17:53:17)

1. **Time Zone:** Select a time zone where this device locates.
2. **Auto-Synchronization:** Check the “Enable” checkbox to enable this function. Besides, you can select a NTP time server to consult UTC time.
3. **Sync with Time Server:** Click on the button if you want to set Date and Time by NTP Protocol manually.
4. **Sync with my PC:** Click on the button if you want to set Date and Time using PC’s Date and Time manually.

Click on “Save” to store your settings or click “Undo” to give up the changes.

3.4.7 Scheduling

You can set the schedule time to decide which service will be turned on or off.

Schedule Rule		[HELP]
Item	Setting	
▶ Schedule	<input type="checkbox"/> Enable	
Rule#	Rule Name	Action
1		<input type="button" value="New Add"/>
2		<input type="button" value="New Add"/>
3		<input type="button" value="New Add"/>
4		<input type="button" value="New Add"/>
5		<input type="button" value="New Add"/>
6		<input type="button" value="New Add"/>
7		<input type="button" value="New Add"/>
8		<input type="button" value="New Add"/>
9		<input type="button" value="New Add"/>
10		<input type="button" value="New Add"/>
<input type="button" value=" << Previous"/> <input type="button" value=" Next >>"/> <input type="button" value=" Save"/> <input type="button" value=" Add New Rule..."/>		

1. **Schedule:** Check to enable the schedule rule settings.
2. **Add New Rule:** To create a schedule rule, click the “Add New Rule” button. You can edit the **Name of Rule**, **Policy**, and set the schedule time (**Week day**, **Start Time**, and **End Time**). The following example configures “ftp time” as everyday 14:10 to 16:20.

Edit Schedule Rule				[HELP]
Item	Setting			
▶ Name of Rule 1	<input type="text" value="ftp time"/>			
▶ Policy	<input type="button" value="Inactivate"/> except the selected days and hours below.			
ID	Week Day	Start Time (hh:mm)	End Time (hh:mm)	
1	<input type="button" value="--everyday --"/>	<input type="text" value="14:10"/>	<input type="text" value="16:20"/>	
2	<input type="button" value="-- choose one --"/>	<input type="text"/>	<input type="text"/>	
3	<input type="button" value="-- choose one --"/>	<input type="text"/>	<input type="text"/>	
4	<input type="button" value="-- choose one --"/>	<input type="text"/>	<input type="text"/>	
5	<input type="button" value="-- choose one --"/>	<input type="text"/>	<input type="text"/>	
6	<input type="button" value="-- choose one --"/>	<input type="text"/>	<input type="text"/>	
7	<input type="button" value="-- choose one --"/>	<input type="text"/>	<input type="text"/>	
8	<input type="button" value="-- choose one --"/>	<input type="text"/>	<input type="text"/>	
<input type="button" value=" Save"/> <input type="button" value=" Undo"/> <input type="button" value=" Back"/>				

Click on “Save” to store your settings or click “Undo” to give up the changes.

3.4.8 IPv6

This device supports several IPv6 applications. You can choose Static IPv6, DHCPv6, PPPoEv6, 6to4, and IPv6 in IPv4 tunnel according to your requirements.

3.4.8.1 Static IPv6

IPv6 Setting	
Item	Setting
▶ IPv6	<input checked="" type="radio"/> Disable <input type="radio"/> Enable
▶ IPv6 Connection	Static IPv6 ▼
WAN IPv6 Address Settings	
▶ IPv6 Address	<input type="text"/>
▶ Subnet Prefix Length	<input type="text"/>
▶ Default Gateway	<input type="text"/>
▶ Primary DNS Address	<input type="text"/>
▶ Secondary DNS Address	<input type="text"/>
LAN IPv6 Address Settings	
▶ LAN IPv6 Address	<input type="text"/> /64
▶ LAN IPv6 Link-Local Address	<input type="text"/>
Address Autoconfiguration Settings	
▶ Autoconfiguration	<input type="radio"/> Disable <input checked="" type="radio"/> Enable
▶ Autoconfiguration Type	Stateless ▼
▶ Router Advertisement Lifetime	<input type="text" value="300"/> Seconds

1. **IPv6:** Disable or enable the IPv6 functions.
2. **IPv6 Connection:** you can choose Static IPv6 from the list.
3. **WAN IPv6 address settings:** you can add IPv6 address / subnet prefix length / default Gateway / Primary DNS address and secondary DNS address.
4. **LAN IPv6 address settings:** you can add LAN IPv6 address, and IPv6 Link-Local address will be showed automatically.
5. **Address auto configuration setting:** Disable or enable this auto configuration setting. You may set stateless or stateful(Dynamic IPv6), and also check if need to send Router advertisement messages periodically.

3.4.8.2 DHCPv6

IPv6 Setting	
Item	Setting
▶ IPv6	<input checked="" type="radio"/> Disable <input type="radio"/> Enable
▶ IPv6 Connection	DHCPv6
IPv6 DNS Settings	
▶ DNS Setting	<input checked="" type="radio"/> Obtain DNS Server address Automatically <input type="radio"/> Use the following DNS address
▶ Primary DNS Address	<input type="text"/>
▶ Secondary DNS Address	<input type="text"/>
LAN IPv6 Address Settings	
▶ LAN IPv6 Address	<input type="text"/> /64
▶ LAN IPv6 Link-Local Address	<input type="text"/>
Address Autoconfiguration Settings	
▶ Autoconfiguration	<input type="radio"/> Disable <input checked="" type="radio"/> Enable
▶ Autoconfiguration Type	Stateless
▶ Router Advertisement Lifetime	300 Seconds
<input type="button" value="Save"/> <input type="button" value="Undo"/>	

1. **IPv6 DNS settings:** you may obtain IPv6 DNS automatically or set DNS address manually for Primary DNS address and secondary DNS address.
2. **LAN IPv6 address settings:** you can add LAN IPv6 address, and IPv6 Link-Local address will be showed automatically.
3. **Address auto configuration setting:** Disable or enable this auto configuration setting. You may set stateless or stateful(Dynamic IPv6), and also check if need to send Router advertisement messages periodically.

3.4.8.3 PPPoEv6

IPv6 Setting	
Item	Setting
▶ IPv6	<input checked="" type="radio"/> Disable <input type="radio"/> Enable
▶ IPv6 Connection	PPPoE ▼
PPPoE Settings	
▶ Username	test
▶ Password	
▶ Service Name	
▶ MTU	1492
LAN IPv6 Address Settings	
▶ LAN IPv6 Address	
▶ LAN IPv6 Link-Local Address	
Address Autoconfiguration Settings	
▶ Autoconfiguration	<input type="radio"/> Disable <input checked="" type="radio"/> Enable
▶ Autoconfiguration Type	Stateless ▼
▶ Router Advertisement Lifetime	300 Seconds
<input type="button" value="Save"/> <input type="button" value="Undo"/>	

1. **PPPoE settings:** you need to type username and password of PPPoE connection. The service name is only required when ISP asks you to input it. MTU is 1492 by default.
2. **LAN IPv6 address settings:** you can add LAN IPv6 address, and IPv6 Link-Local address will be showed automatically.
3. **Address auto configuration setting:** Disable or enable this auto configuration setting. You may set stateless or stateful(Dynamic IPv6), and also check if need to send Router advertisement messages periodically.

3.4.8.4 6 to 4

IPv6 Setting	
Item	Setting
▶ IPv6	<input checked="" type="radio"/> Disable <input type="radio"/> Enable
▶ IPv6 Connection	6 to 4 ▾
6 to 4 Settings	
▶ 6 to 4 Address	
▶ Primary DNS Address	<input type="text"/>
▶ Secondary DNS Address	<input type="text"/>
LAN IPv6 Address Settings	
▶ LAN IPv6 Address	<input type="text"/> /64
▶ LAN IPv6 Link-Local Address	
Address Autoconfiguration Settings	
▶ Autoconfiguration	<input type="radio"/> Disable <input checked="" type="radio"/> Enable
▶ Autoconfiguration Type	Stateless ▾
▶ Router Advertisement Lifetime	300 Seconds
<input type="button" value="Save"/> <input type="button" value="Undo"/>	

1. **IPv6 DNS settings:** The 6 to 4 address will be showed automatically when WAN gets a public IPv4 address. You may set DNS address manually for Primary DNS address and secondary DNS address.
2. **LAN IPv6 address settings:** you can add LAN IPv6 address, and IPv6 Link-Local address will be showed automatically.
3. **Address auto configuration setting:** Disable or enable this auto configuration setting. You may set stateless or stateful(Dynamic IPv6), and also check if need to send Router advertisement messages periodically.

3.4.8.5 IPv6 in IPv4 Tunnel

IPv6 Setting	
Item	Setting
▶ IPv6	<input checked="" type="radio"/> Disable <input type="radio"/> Enable
▶ IPv6 Connection	IPv6 in IPv4 Tunnel ▼
IPv6 in IPv4 Tunnel Settings	
▶ Remote IPv4 Address	<input type="text"/>
▶ Local IPv4 Address	<input type="text"/>
▶ Local IPv6 Address	<input type="text"/> /64
▶ Primary DNS Address	<input type="text"/>
▶ Secondary DNS Address	<input type="text"/>
LAN IPv6 Address Settings	
▶ LAN IPv6 Address	<input type="text"/> /64
▶ LAN IPv6 Link-Local Address	<input type="text"/>
Address Autoconfiguration Settings	
▶ Autoconfiguration	<input type="radio"/> Disable <input checked="" type="radio"/> Enable
▶ Autoconfiguration Type	Stateless ▼
▶ Router Advertisement Lifetime	300 Seconds
<input type="button" value="Save"/> <input type="button" value="Undo"/>	

1. **IPv6 address in IPv4 Tunnel settings:** you may add remote / local IPv4 address and local IPv6 address, and then set DNS address manually for Primary DNS address and secondary DNS address.
2. **LAN IPv6 address settings:** you can add LAN IPv6 address, and IPv6 Link-Local address will be showed automatically.
3. **Address auto configuration setting:** Disable or enable this auto configuration setting. You may set stateless or stateful(Dynamic IPv6), and also check if need to send Router advertisement messages periodically.

3.5 Tool Box

Toolbox

- **View Log**
- View the system logs.
- **Firmware Upgrade**
- Prompt the administrator for a file and upgrade it to this device.
- **Backup Setting**
- Save the settings of this device to a file.
- **Reset to Default**
- Reset the settings of this device to the default values.
- **Reboot**
- Reboot this device.
- **Miscellaneous**
- Domain Name or IP address for Ping Test: Allow you to configure an IP, and ping the device. You can ping a specific IP to test whether it is alive.

3.5.1 System Info

You can view the System Information and System log, and download/clear the System log, in this page.

System Information

Item	Setting
▶ WAN Type	Dynamic IP Address
▶ Display time	Wed, 27 Jan 2010 16:47:57 +0800

System Log

Time	Log
Jan 26 14:30:46	kernel: klogd started: BusyBox v1.3.2 (2009-12-23 15:33:29 CST)
Jan 26 14:30:54	udhcpd[1422]: udhcpd (v0.9.9-pre) started
Jan 26 14:30:54	udhcpd[1422]: Unable to open /var/run/udhcpd.leases for reading
Jan 26 14:30:55	init: Starting pid 1463, console /dev/ttyS1: '/bin/ash'
Jan 26 14:30:56	commander: STOP WANTYPE Dynamic IP Address
Jan 26 14:30:56	commander: START WANTYPE Dynamic IP Address
Jan 26 14:30:57	udhcpd[1525]: udhcpd (v0.9.9-pre) started
Jan 26 14:30:58	commander: STOP WANTYPE Dynamic IP Address
Jan 26 14:30:58	udhcpd[1769]: Received SIGTERM
Jan 26 14:31:01	udhcpd[1828]: udhcpd (v0.9.9-pre) started
Jan 26 14:31:02	udhcpd[2069]: Sending discover...
Jan 26 14:31:02	udhcpd[2069]: Sending select for 192.168.122.158...
Jan 26 14:31:02	udhcpd[2069]: Lease of 192.168.122.158 obtained, lease time 600
Jan 26 14:31:08	commander: Synchronization Time Success.
Jan 26 14:31:22	udhcpd[1424]: sending OFFER of 192.168.1.100

Page: 1/54 (Log Number: 807)

<< Previous
Next >>
First Page
Last Page

Refresh
Download
Clear logs

3.5.2 Firmware Upgrade

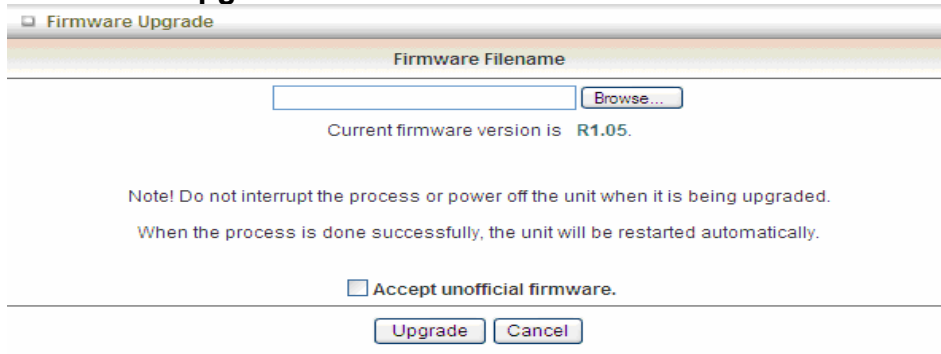

You can upgrade firmware by clicking "Upgrade" button.

3.5.3 Backup Setting

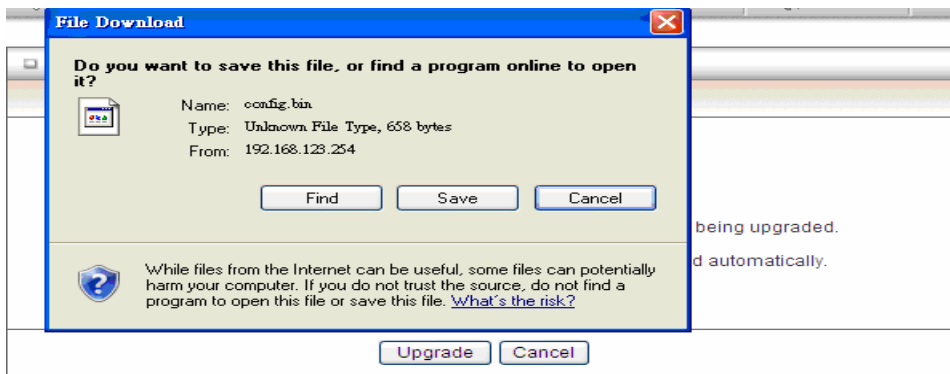

You can backup your settings by clicking the "Backup Setting" function item and save it as a bin file. Once you want to restore these settings, please click Firmware Upgrade button and use the bin file you saved.

3.5.4 Reset to Default



You can also reset this device to factory default settings by clicking the **Reset to default** function item.

3.5.5 Reboot

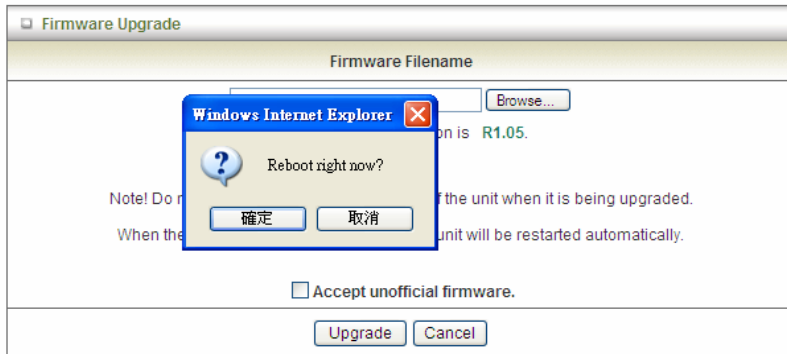

You can also reboot this device by clicking the **Reboot** function item.

3.5.6 Miscellaneous

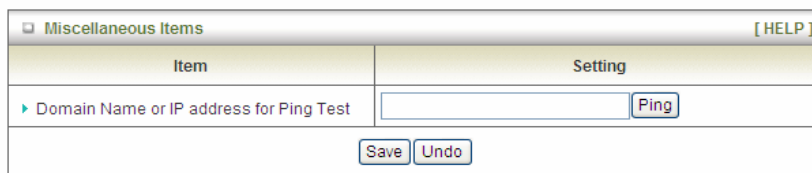

1. **Domain Name or IP address for Ping Test:** Allow you to configure an IP, and ping the device. You can ping a specific IP to test whether it is alive.

Click on “Save” to store your settings or click “Undo” to give up the changes.

Chapter 4 . Troubleshooting

This Chapter provides solutions to problems for the installation and operation of the WiFi Combo Router. You can refer to the following if you are having problems.

1 Why can't I configure the router even the cable is plugged and the LED is lit?

Do a **Ping test** to make sure that the WiFi Combo Router is responding.

Note: It is recommended that you use an Ethernet connection to configure it.

Go to **Start > Run**.

1. Type **cmd**.

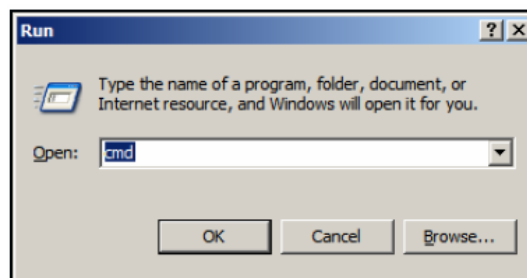

2. Press **OK**.
3. Type **ipconfig** to get the IP of default gateway.
4. Type **ping 192.168.123.254**". Assure that you ping the correct IP Address assigned to the WiFi Combo Router. It will show four replies if you ping correctly.

```
Pinging 192.168.123.254 with 32 bytes of data:  
Reply from 192.168.123.254: bytes=32 time<1ms TTL=64  
Reply from 192.168.123.254: bytes=32 time<1ms TTL=64  
Reply from 192.168.123.254: bytes=32 time<1ms TTL=64  
Reply from 192.168.123.254: bytes=32 time<1ms TTL=64
```

Ensure that your Ethernet Adapter is working, and that all network drivers are installed properly. Network adapter names will vary depending on your specific adapter. The installation steps listed below are applicable for all network adapters.

1. Go to **Start > Right click on "My Computer" > Properties**.
2. **Select the Hardware Tab**.
3. Click **Device Manager**.
4. Double-click on **"Network Adapters"**.
5. Right-click on **Wireless Card bus Adapter** or **your specific network adapter**.

6. Select **Properties** to ensure that all drivers are installed properly.
7. Look under **Device Status** to see if the device is working properly.
8. Click **“OK”**.
- 9.

2 What can I do if my Ethernet connection does not work properly?

- A. Make sure the RJ45 cable connect with the router.
- B. Ensure that the setting on your Network Interface Card adapter is “Enabled”.
- C. If settings are correct, ensure that you are not using a crossover Ethernet cable, not all Network Interface Cards are MDI/MDIX compatible, and use a patch cable is recommended.
- D. If the connection still doesn’t work properly, then you can reset it to default.

3 Problems with 3G connection?

A. What can I do if the 3G connection is failed by Auto detection?

Maybe the device can’t recognize your ISP automatically. Please select “Manual” mode, and filling in dial-up settings manually.

B. What can I do if my country and ISP are not in the list?

Please choose “Others” item from the list, and filling in dial-up settings manually.

C. What can I do if my 3G connection is failed even the dongle is plugged?

Please check the following items:

- I. Make sure you have inserted a validated SIM card in the 3G data card, and the subscription from ISP is still available
- II. If you activate PIN code check feature in SIM card, making sure the PIN code you fill in dial-up page is correct
- III. Checking with your ISP to see all dial-up settings are correct
- IV. Make sure 3G signal from your ISP is available in your environment

D. What can I do if my router can’t recognize my 3G data card even it is plugged?

There might be compatibility issue with some certain 3G cards. Please check the latest compatibility list to see if your 3G card is already supported.

E. What should I insert in APN, PIN Code, Account, Password, Primary DNS, and Secondary DNS?

The device will show this information after you choose country and Telcom. You can also check these values with your ISP.

F. Which 3G network should I select?

It depends on what service your ISP provide. Please check your ISP to know this information.

G. Why my 3G connection is keep dropping?

Please check 3G signal strength from your ISP in your environment is above middle level.

4 Something wrong with the wireless connection?

A. Can't setup a wireless connection?

- I. Ensure that the SSID and the encryption settings are exactly the same to the Clients.
- II. Move the WiFi Combo Router and the wireless client into the same room, and then test the wireless connection.
- III. Disable all security settings such as **WEP**, and **MAC Address Control**.
- IV. Turn off the WiFi Combo Router and the client, then restart it and then turn on the client again.
- V. Ensure that the LEDs are indicating normally. If no, make sure that the AC power and Ethernet cables are firmly connected.
- VI. Ensure that the IP Address, subnet mask, gateway and DNS settings are correctly entered for the network.
- VII. If you are using other wireless device, home security systems or ceiling fans, lights in your home, your wireless connection may degrade dramatically. Keep your product away from electrical devices that generate RF noise such as microwaves, monitors, electric motors...

B. What can I do if my wireless client can not access the Internet?

- I. Out of range: Put the router closer to your client.
- II. Wrong SSID or Encryption Key: Check the SSID or Encryption setting.
- III. Connect with wrong AP: Ensure that the client is connected with the correct Access Point.
 - i. **Right-click** on the **Local Area Connection icon** in the taskbar.
 - ii. Select **View Available Wireless Networks in Wireless Configure**. Ensure you have selected the correct available network.
 - iii. Reset the WiFi Combo Router to default setting

C. Why does my wireless connection keep dropping?

- I. Antenna Orientation.
 - i. Try different antenna orientations for the WiFi Combo Router.
 - ii. Try to keep the antenna at least 6 inches away from the wall or other objects.
- II. Try changing the channel on the WiFi Combo Router, and your Access Point and Wireless adapter to a different channel to avoid interference.
- III. Keep your product away from electrical devices that generate RF noise, like microwaves, monitors, electric motors, etc.

5 What to do if I forgot my encryption key?

1. Go back to advanced setting to set up your Encryption key again.
2. Reset the WiFi Combo Router to default setting

6 How to reset to default?

1. Ensure the WiFi Combo Router is powered on
2. Find the **Reset** button on the right side
3. Press the **Reset** button for 8 seconds and then release.
4. After the WiFi Combo Router reboots, it has back to the factory **default** settings.

Appendix A. Spec Summary Table

Hardware & Port Configuration		CDW571AM-002
Wireless WAN	USB 2.0 for external 3G/4G modem	1
Ethernet WAN	RJ-45 port, 10/100/1000Mbps, auto-MDI/MDIX	1
Ethernet LAN	RJ-45 port, 10/100/1000Mbps, auto-MDI/MDIX	4
Antenna	1.8 dBi fixed antenna	2
WPS/ WiFi On-Off	For WPS connection or WiFi On/Off	1
Reset Button	Reset router setting to factory default	1
LED Indication	Mobile/ WAN/ WLAN/ LAN1~4	•
Power Jack	DC 5V/2A switching power	1
Wireless LAN (WiFi)		
Standard	IEEE 802.11b/g/n compliance	•
SSID	SSID broadcast or in stealth mode	•
Channel	Auto-selection, manually	•
Security	WEP, WPA, WPA2, WPA-PSK, WPA2-PSK	•
WPS/ Wifi On-Off	WPS / Wifi On-Off	•
WMM	WMM (Wi-Fi Multimedia)	•
Functionality		
Wireless WAN	PPP (for WCDMA/HSPA)	•
	PPPoE (for iBurst)	•
Ethernet WAN	PPPoE, DHCP client, Static IP, PPTP, L2TP	•
WAN Connection	Auto-reconnect, dial-on-demand, manually	•
One-to-Many NAT	Virtual server, special application, DMZ	•
IPv6 Supported		•
SPI Firewall	IP/Service filter, URL blocking, MAC control	•
DoS Protection	DoS (Deny of Service) detection and protection	•
Routing Protocol	Static route, dynamic route (RIP v1/v2)	•
Management	SNMP, UPnP IGD, syslog	•
Administration	Web-based UI, remote login, backup/restore setting	•
Environment & Certification		
Operation Temp.	Temp.: 0~40°C, Humidity 10%~90% non-condensing	•
Storage Temp.	Temp.: -10~70°C, Humidity: 0~95% non-condensing	•
RoHS	RoHS compliance	•

Appendix B. Licensing information

This product includes copyrighted third-party software licensed under the terms of the GNU General Public License. Please refer to the GNU General Public License below to check the detailed terms of this license.

The following parts of this product are subject to the GNU GPL, and those software packages are copyright by their respective authors.

- Linux-2.4.28 system kernel
- busybox_1_00_rc2
- bridge-utils 0.9.5
- dhcpcd-1.3
- ISC DHCP V2 P5
- util-linux 2.12b for fdisk application
- e2fsprogs 1.27
- mini-lpd
- samba 2.2.7a
- syslogd spread from busybox
- wireless tools
- ntpclient of NTP client implementation
- RT61apd for 802.1X application
- vsftpd-2.0.3
- quota-tools 3.13
- GNU Wget

Availability of source code

Please visit our web site or contact us to obtain more information.

GNU GENERAL PUBLIC LICENSE

Version 2, June 1991

Copyright (C) 1989, 1991 Free Software Foundation, Inc.
59 Temple Place, Suite 330, Boston, MA 02111-1307 USA

Everyone is permitted to copy and distribute verbatim copies
of this license document, but changing it is not allowed.

Preamble

The licenses for most software are designed to take away your freedom to share and change it. By contrast, the GNU General Public License is intended to guarantee your freedom to share and change free software--to make sure the software is free for all its users. This General Public License applies to most of the Free Software Foundation's software and to any other program whose authors commit to using it. (Some other Free Software Foundation software is covered by the GNU Library General Public License instead.) You can apply it to your programs, too.

When we speak of free software, we are referring to freedom, not price. Our General Public Licenses are designed to make sure that you have the freedom to distribute copies of free software (and charge for this service if you wish), that you receive source code or can get it if you want it, that you can change the software or use pieces of it in new free programs; and that you know you can do these things.

To protect your rights, we need to make restrictions that forbid anyone to deny you these rights or to ask you to surrender the rights. These restrictions translate to certain responsibilities for you if you distribute copies of the software, or if you modify it.

For example, if you distribute copies of such a program, whether gratis or for a fee, you must give the recipients all the rights that you have. You must make sure that they, too, receive or can get the source code. And you must show them these terms so they know their rights.

We protect your rights with two steps: (1) copyright the software, and (2) offer you this license which gives you legal permission to copy, distribute and/or modify the software.

Also, for each author's protection and ours, we want to make certain that everyone understands that there is no warranty for this free software. If the software is modified by someone else and passed on, we want its recipients to know that what they have is not the original, so that any problems introduced by others will not reflect on the original authors' reputations.

Finally, any free program is threatened constantly by software patents. We wish to avoid the danger that redistributors of a free program will individually obtain patent licenses, in effect making the program proprietary. To prevent this, we have made it clear that any patent must be licensed for everyone's free use or not licensed at all.

The precise terms and conditions for copying, distribution and modification follow.

GNU GENERAL PUBLIC LICENSE

TERMS AND CONDITIONS FOR COPYING, DISTRIBUTION AND MODIFICATION

0. This License applies to any program or other work which contains a notice placed by the copyright holder saying it may be distributed under the terms of this General Public License. The "Program", below, refers to any such program or work, and a "work based on the Program" means either the Program or any derivative work under copyright law: that is to say, a work containing the Program or a portion of it, either verbatim or with modifications and/or translated into another language. (Hereinafter, translation is included without limitation in the term "modification".) Each licensee is addressed as "you".

Activities other than copying, distribution and modification are not covered by this License; they are outside its scope. The act of running the Program is not restricted, and the output from the Program is covered only if its contents constitute a work based on the Program (independent of having been made by running the Program). Whether that is true depends on what the Program does.

1. You may copy and distribute verbatim copies of the Program's source code as you receive it, in any medium, provided that you conspicuously and appropriately publish on each copy an appropriate copyright notice and disclaimer of warranty; keep intact all the notices that refer to this License and to the absence of any warranty; and give any other recipients of the Program a copy of this License along with the Program.

You may charge a fee for the physical act of transferring a copy, and you may at your option offer warranty protection in exchange for a fee.

2. You may modify your copy or copies of the Program or any portion of it, thus forming a work based on the Program, and copy and distribute such modifications or work under the terms of Section 1 above, provided that you also meet all of these conditions:

- a) You must cause the modified files to carry prominent notices stating that you changed the files and the date of any change.
- b) You must cause any work that you distribute or publish, that in whole or in part contains or is derived from the Program or any part thereof, to be licensed as a whole at no charge to all third parties under the terms of this License.
- c) If the modified program normally reads commands interactively when run, you must cause it, when started running for such interactive use in the most ordinary way, to print or display an announcement including an appropriate copyright notice and a notice that there is no warranty (or else, saying that you provide a warranty) and that users may redistribute the program under these conditions, and telling the user how to view a copy of this License. (Exception: if the Program itself is interactive but does not normally print such an announcement, your work based on the Program is not required to print an announcement.)

These requirements apply to the modified work as a whole. If identifiable sections of that work are not derived from the Program, and can be reasonably considered independent and separate works in themselves, then this License, and its terms, do not apply to those sections when you distribute them as separate works. But when you distribute the same sections as part of a whole which is a work based on the Program, the distribution of the whole must be on the terms of this License, whose permissions for other licensees extend to the entire whole, and thus to each and every part regardless of who wrote it.

Thus, it is not the intent of this section to claim rights or contest your rights to work written entirely by you; rather, the intent is to exercise the right to control the distribution of derivative or collective works based on the Program.

In addition, mere aggregation of another work not based on the Program with the Program (or with a work based on the Program) on a volume of a storage or distribution medium does not bring the other work under the scope of this License.

3. You may copy and distribute the Program (or a work based on it, under Section 2) in object code or executable form under the terms of Sections 1 and 2 above provided that you also do one of the following:

- a) Accompany it with the complete corresponding machine-readable source code, which must be distributed under the terms of Sections 1 and 2 above on a medium customarily used for software interchange; or,
- b) Accompany it with a written offer, valid for at least three years, to give any third party, for a charge no more than your cost of physically performing source distribution, a complete machine-readable copy of the corresponding source code, to be distributed under the terms of Sections 1 and 2 above on a medium customarily used for software interchange; or,
- c) Accompany it with the information you received as to the offer to distribute corresponding source code. (This alternative is allowed only for noncommercial distribution and only if you received the program in object code or executable form with such an offer, in accord with Subsection b above.)

The source code for a work means the preferred form of the work for making modifications to it. For an executable work, complete source code means all the source code for all modules it contains, plus any associated interface definition files, plus the scripts used to control compilation and installation of the executable. However, as a special exception, the source code distributed need not include anything that is normally distributed (in either source or binary form) with the major components (compiler, kernel, and so on) of the operating system on which the executable runs, unless that component itself accompanies the executable.

If distribution of executable or object code is made by offering access to copy from a designated place, then offering equivalent access to copy the source code from the same place counts as distribution of the source code, even though third parties are not compelled to copy the source along with the object code.

4. You may not copy, modify, sublicense, or distribute the Program except as expressly provided under this License. Any attempt otherwise to copy, modify, sublicense or distribute the Program is void, and will automatically terminate your rights under this License. However, parties who have received copies, or rights, from you under this License will not have their licenses terminated so long as such parties remain in full compliance.

5. You are not required to accept this License, since you have not signed it. However, nothing else grants you permission to modify or distribute the Program or its derivative works. These actions are prohibited by law if you do not accept this License. Therefore, by modifying or distributing the Program (or any work based on the Program), you indicate your acceptance of this License to do so, and all its terms and conditions for copying, distributing or modifying the Program or works based on it.

6. Each time you redistribute the Program (or any work based on the Program), the recipient automatically receives a license from the original licensor to copy, distribute or modify the Program subject to these terms and conditions. You may not impose any further restrictions on the recipients' exercise of the rights granted herein. You are not responsible for enforcing compliance by third parties to this License.

7. If, as a consequence of a court judgment or allegation of patent infringement or for any other reason (not limited to patent issues), conditions are imposed on you (whether by court order, agreement or otherwise) that contradict the conditions of this License, they do not excuse you from the conditions of this License. If you cannot distribute so as to satisfy simultaneously your obligations under this License and any other pertinent obligations, then as a consequence you may not distribute the Program at all. For example, if a patent license would not permit royalty-free redistribution of the Program by all those who receive copies directly or indirectly through you, then the only way you could satisfy both it and this License would be to refrain entirely from distribution of the Program.

If any portion of this section is held invalid or unenforceable under any particular circumstance, the balance of the section is intended to apply and the section as a whole is intended to apply in other circumstances.

It is not the purpose of this section to induce you to infringe any patents or other property right claims or to contest validity of any such claims; this section has the sole purpose of protecting the

integrity of the free software distribution system, which is implemented by public license practices. Many people have made generous contributions to the wide range of software distributed through that system in reliance on consistent application of that system; it is up to the author/donor to decide if he or she is willing to distribute software through any other system and a licensee cannot impose that choice.

This section is intended to make thoroughly clear what is believed to be a consequence of the rest of this License.

8. If the distribution and/or use of the Program is restricted in certain countries either by patents or by copyrighted interfaces, the original copyright holder who places the Program under this License may add an explicit geographical distribution limitation excluding those countries, so that distribution is permitted only in or among countries not thus excluded. In such case, this License incorporates the limitation as if written in the body of this License.

9. The Free Software Foundation may publish revised and/or new versions of the General Public License from time to time. Such new versions will be similar in spirit to the present version, but may differ in detail to address new problems or concerns.

Each version is given a distinguishing version number. If the Program specifies a version number of this License which applies to it and "any later version", you have the option of following the terms and conditions either of that version or of any later version published by the Free Software Foundation. If the Program does not specify a version number of this License, you may choose any version ever published by the Free Software Foundation.

10. If you wish to incorporate parts of the Program into other free programs whose distribution conditions are different, write to the author to ask for permission. For software which is copyrighted by the Free Software Foundation, write to the Free Software Foundation; we sometimes make exceptions for this. Our decision will be guided by the two goals of preserving the free status of all derivatives of our free software and of promoting the sharing and reuse of software generally.

NO WARRANTY

11. BECAUSE THE PROGRAM IS LICENSED FREE OF CHARGE, THERE IS NO WARRANTY FOR THE PROGRAM, TO THE EXTENT PERMITTED BY APPLICABLE LAW. EXCEPT WHEN OTHERWISE STATED IN WRITING THE COPYRIGHT HOLDERS AND/OR OTHER PARTIES PROVIDE THE PROGRAM "AS IS" WITHOUT WARRANTY OF ANY KIND, EITHER EXPRESSED OR IMPLIED, INCLUDING, BUT NOT LIMITED TO, THE IMPLIED WARRANTIES OF MERCHANTABILITY AND FITNESS FOR A PARTICULAR PURPOSE. THE ENTIRE RISK AS TO THE QUALITY AND PERFORMANCE OF THE PROGRAM IS WITH YOU. SHOULD THE PROGRAM PROVE DEFECTIVE, YOU ASSUME THE COST OF ALL NECESSARY SERVICING, REPAIR OR CORRECTION.

12. IN NO EVENT UNLESS REQUIRED BY APPLICABLE LAW OR AGREED TO IN WRITING WILL ANY COPYRIGHT HOLDER, OR ANY OTHER PARTY WHO MAY MODIFY AND/OR REDISTRIBUTE THE PROGRAM AS PERMITTED ABOVE, BE LIABLE TO YOU FOR DAMAGES, INCLUDING ANY GENERAL, SPECIAL, INCIDENTAL OR CONSEQUENTIAL DAMAGES ARISING OUT OF THE USE OR INABILITY TO USE THE PROGRAM (INCLUDING BUT NOT LIMITED TO LOSS OF DATA OR DATA BEING RENDERED INACCURATE OR LOSSES SUSTAINED BY YOU OR THIRD PARTIES OR A FAILURE OF THE PROGRAM TO OPERATE WITH ANY OTHER PROGRAMS), EVEN IF SUCH HOLDER OR OTHER PARTY HAS BEEN ADVISED OF THE POSSIBILITY OF SUCH DAMAGES.

END OF TERMS AND CONDITIONS