

INSTALLATION INSTRUCTIONS

Model: 7921P

Step 1: 10-Pin Main Harness Installation

The main wire harness contains 8 wires which all have a specific purpose. Follow the wiring recommendations enclosed for each wire. Wires not used should be released from the harness connector or taped off to prevent accidental shorting.

Gray Wire: The gray wire is a pulsed ground output designed to activate the vehicle's existing car horn system in place of or in addition to a siren sounding device. Connect the gray wire to the negative trigger wire on the vehicle's horn relay.

WARNING! Maximum output of this wire is 300mA. Horn systems requiring positive voltage or more than 300mA to trigger the horn relay will require an additional relay to increase current capabilities.

Blue Wire with White Stripe: This wire provides a single pulsed ground when the 7921P is disarmed so that it will disarm a factory installed alarm system.

Note: Some factory alarms systems may require a double pulse signal to disarm the factory alarm system. In this case, you will need to add Silencer adapter model #5902DP to the blue wire with white stripe.

Brown Wire: The brown wire is the positive siren output wire. Connect the brown wire from the harness to the brown wire on the siren supplied. Ground the remaining black wire from the siren.

Blue Wire: The blue wire is a negative trigger input that can be used for existing or newly installed grounding type hood/trunk/ hatch pin switches. The blue wire can also be used as an input for additional ground output electronic sensors.

Green Wire: The green wire is the negative (-) door trigger input. If the vehicle you are working on has a negative (-) triggered dome light system, connect the green wire to the common dome light trigger wire. This wire is usually located at the driver's side door jamb switch.

Violet Wire: The violet wire is the positive (+) door trigger input. If the vehicle you are working on has a positive (+) triggered dome light system, connect the violet wire to the common dome light trigger wire. This wire is usually located at the driver's side door jamb switch.

Red Wire with White Stripe: The red/white wire is the output of the parking light relay. Connect the red/white wire to the parking light trigger wire coming from the headlight switch. Do not connect the red/white wire to a dashboard lighting wire. Connecting the red/white into dashboard lighting can damage the dashboard lighting dimmer switch.

Pink Wire: The pink wire is the input wire to the parking light relay. The connection of the pink wire determines the output polarity of the parking light relay. If the parking light system you are connecting to is positive activation, connect the pink wire to battery +12vdc. If the parking light system you are connecting to is negative activation, connect the pink wire to the frame of the vehicle.

Note: (Applies to All Models) The main 10 pin harness contains two vacant sockets. These vacant sockets are for channel #2 output. All the alarm modules require an 5912 for channel #2 operation. Follow the wiring instructions supplied with 5912. If a 5912 relay is not available, a standard Bosch 5 pin relay can be used.

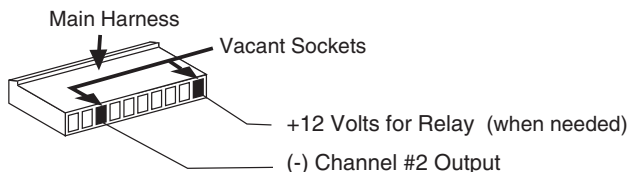

Step 2: Arm / Disarm Harness Wiring (3-Pin White Socket)

Follow wiring diagram enclosed for proper connection to the factory installed power door locking system to arm and disarm the 7921P security system.

Step 3: 5-Pin Power Harness Installation

The power harness contains 3 wires and two vacant sockets, this power harness does not come packaged with the alarm module but in 5901H1, 5901H2, 5901H3 harness kits or custom starter disable/power interface harnesses. Packaged with the 10-pin main harness are two loose wires (an Orange wire and a White wire with a Black stripe). Follow the wiring recommendations enclosed for each wire.

Power Harness

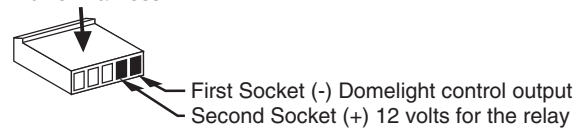

Orange Wire: Insert the orange wire into the first socket of the power harness. The orange wire is the dome light supervision control output. Connect the orange wire to the required control relay.

White Wire with Black Stripe: Insert the white/black wire into the third socket of the power harness. (As shown) The white/black wire is the (-) Channel #2 output wire and should be connected to an existing (-) activated trunk release switch or an additional relay will have to be added to control the trunk release mechanism.

Step 4: Door Lock/Unlock Socket (3- Pin Black Socket)

For remote controlled door lock/unlock operation, follow the wiring diagram enclosed (page 2). The harness is an optional part not supplied with 7921P. Order part # 5902 or 5903 for one-wire multiplexing door locking systems.

Step 5: Auxiliary Interrupt Wiring (2-Pin Orange Socket)

To interrupt an additional circuit(s), all alarm modules require either the ALA-RPS, ALA-RPS2 or ALA-RPS3 relay pack. Follow the wiring instructions supplied with the relay packs.

Step 6: Dip Switch Feature Programming

Dip Switch #1: Ignition Key Controlled Lock/Unlock (Door lock control function must be connected and the door lock output feature must be "On" in the dealer mode)

Note: This feature can be programmed using the #1 Dip Switch in both the dealer and consumer modes.

Place Dip Switch #1 to the "On" position to activate this feature.
Place Dip Switch #1 in the "Off" position to deactivate this feature.

Dip Switch #2: Current Sensing

Note: This feature can be programmed using the #2 Dip Switch in both the dealer and consumer modes.

Place Dip Switch #2 to the "On" position to have the current sensing feature on.
Place Dip Switch #2 in the "Off" position to have the current sensing feature off.

Dip Switch #3: Door Entry Delay

Note: This feature can be pre-programmed in dealer mode using the #3 Dip Switch. The feature will not be functional in the dealer mode but will become functional when the unit is converted to customer mode.

Place the dip switch in the "On" position. During customer mode operation, the (+) or (-) door input trigger wires will have a 20 second entry delay. This is primarily used for Ford vehicles that have keyless entry and use a door mounted keypad.

Place the dip switch in the "Off" position (Factory Default) and the 20 second door entry delay will be off (Instant Activation).

Step 7: Additional Menu Programming

The Silencer model 7921P control module offers additional menu programmable features. Follow the dealer or consumer remote feature programming sheets to adjust the 7921P features.

INSTALLATION INSTRUCTIONS

Model: 7921P

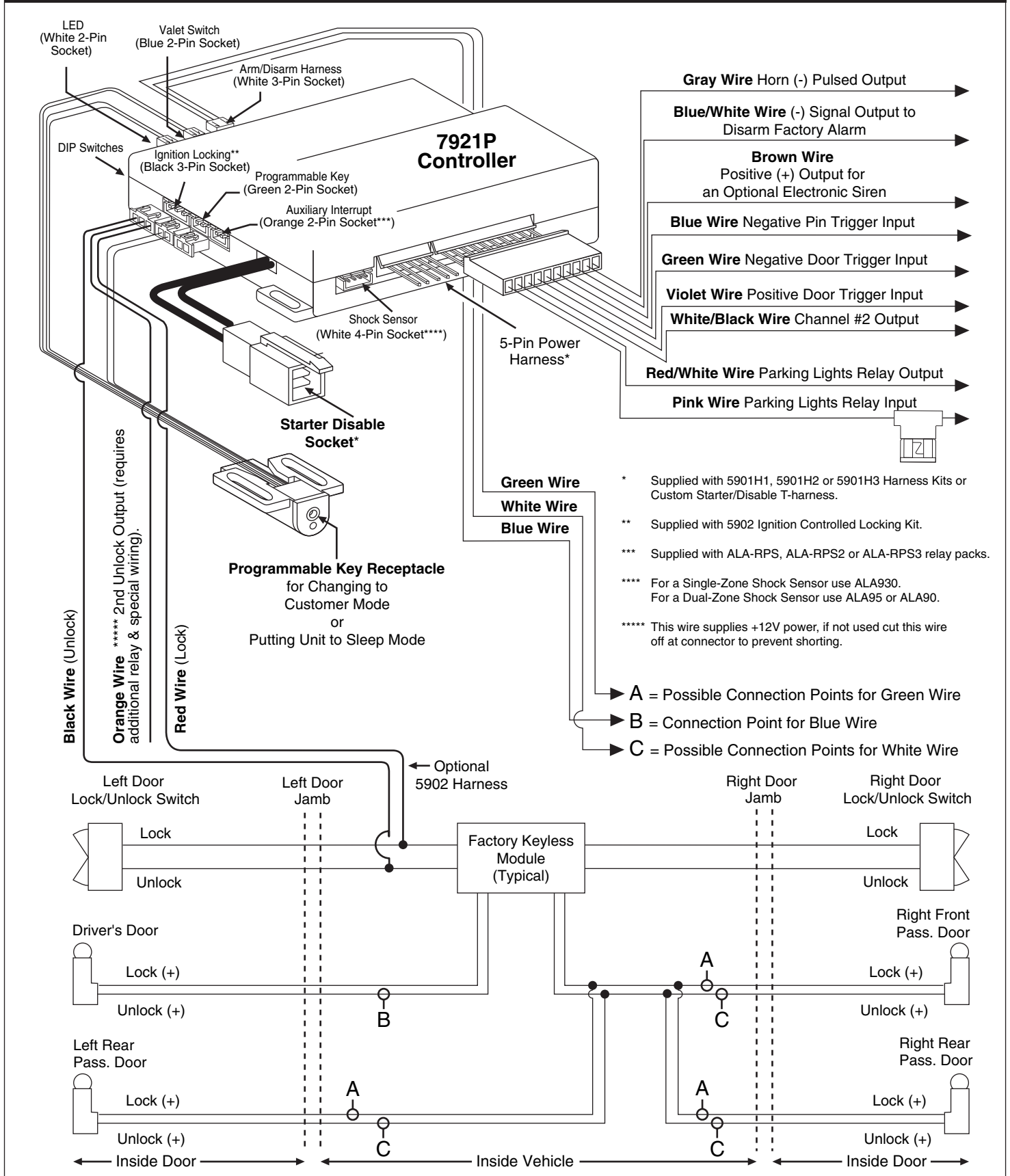

CONSUMER REMOTE FEATURE PROGRAMMING

NOTE: The alarm must be in "consumer mode" before you can program consumer mode features. See additional instruction sheets on performing this function. When the alarm is programmed to consumer mode, a specific group of operating features are reset to their default settings. These default settings can be changed by following the enclosed procedures and using the special 7910P programming transmitter.

NOTE: In the event that the 7910P transmitter is unavailable, the programming can also be performed by the consumer transmitter once all buttons have been programmed into the control module memory. (See "Consumer Remote Feature Programming from the Consumer's Transmitter.") To get into the "Consumer Remote Feature Programming" mode follow the procedures below.

#	Programmable Alarm Feature (Consumer Transmitter Mode)	Default Setting (Consumer Transmitter Mode)
1	Chirp Status Indicator	Chirps On
2A	*Mode "P"	Automatic Arming of Alarm "On", Automatic Arming of Starter Disable "On"
2B	*Mode "S"	Automatic Arming of Alarm "Off", Automatic Arming of Starter Disable "On" Starter Disable will Arm 70 Seconds After Last Door is Closed
3	Remote Panic from Factory Keyless Entry Transmitter	On
4	Safety Illumination Sentinel System	Off

* During Dealer Remote Feature Programming either the "P" or "S" mode was selected. In the Consumer Remote Feature Programming mode you cannot change the mode (either "S" or "P") that was selected in the Dealer Feature Programming. You can change the features of the mode that was selected in the Dealer Mode. (See Step 5 for more details.) To change mode "S" or "P" operation you have to recode a dealer transmitter to the unit and change the operation in the "Dealer Remote Programmable Feature" Mode.

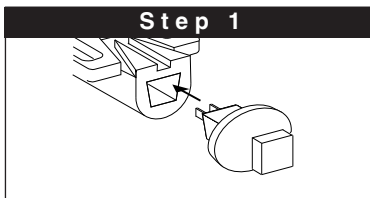

Insert the Valet Switch

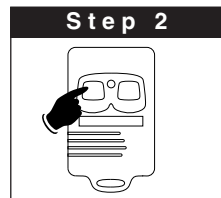
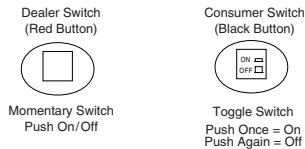

Disarm Security System

The LED will be off and the horn/siren will emit 2 chirps.

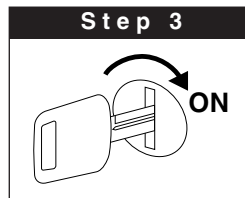

Turn On Ignition

The LED will remain off.

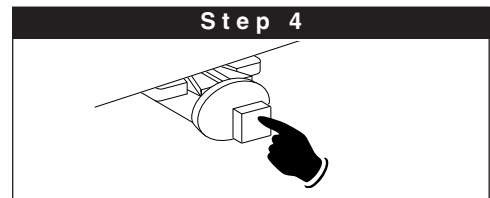

Push the Valet Switch:

6 Times if Using a Red Button Switch
12 Times if Using a Black Button Switch
(Represents 6 Times On/Off)

The LED will be on solid and the horn/siren will emit 1 long then 1 short chirp. You are now in the "Consumer Remote Feature Programming" mode.

Step 5

5910P Programming Transmitter

Use the 5910P transmitter and the chart below to change the features as required. Press and hold the button that controls the function you want to change and listen for the chirp confirmation. You can repeatedly press the same colored button and turn the same function on and off as many times as required until the operation is correct. After all functions have been re-programmed to operate as required go to step 6.

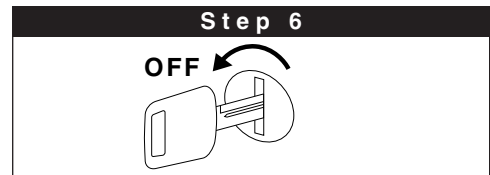

Turn Off the Ignition

The horn/siren will emit 1 short chirp and 1 long chirp. You are now out of the "Consumer Remote Feature Programming" mode.

#	Button Color	Function	Confirmation = Change Function
1	Black	Chirp Status Indication	1 Beep = Chirp Status Indication "On" 2 Beeps = Chirp Status Indication "Off"
2A	Blue	Mode "P" Note: The auto arm door locking feature has a default setting of "off" in customer mode. To turn on or off the auto arm door locking feature in customer mode, repeat the steps for the "Blue" button and hold the transmitter button down for more than 3 seconds to get a second confirmation chirp. For example: (1 chirp = 10 sec auto arm on, auto door lock off.) (1 chirp + 1 chirp = 10 sec auto arm on, auto door lock on.)	1 Beep = Automatic Arming of Alarm "On", Automatic Arming of Starter Disable "On" Both will arm 10 seconds after last door is closed or rearm 10 seconds after remote disarm.
			2 Beeps = Automatic Arming of Alarm "On", Automatic Arming of Starter Disable "On" Both will arm 20 seconds after last door is closed or rearm 20 seconds after remote disarm.
			3 Beeps = Automatic Arming of Alarm "On", Automatic Arming of Starter Disable "On" Both will arm 45 seconds after last door is closed or rearm 60 seconds after remote disarm.
			4 Beeps = Automatic Arming of Alarm "Off", Automatic Arming of Starter Disable "On" The starter will disable 70 seconds after last door is closed.
2B	Blue	Mode "S"	1 Beep = Automatic Arming of Alarm "On", Automatic Arming of Starter Disable "On" Both will arm 45 seconds after last door is closed.
			2 Beeps = Automatic Arming of Alarm "Off", Automatic Arming of Starter Disable "On" The starter will disable 70 seconds after last door is closed.
3	Red	Remote Panic from Factory Keyless Entry Transmitter	1 Beep = Panic "On" 2 Beeps = Panic "Off"
4	Black + Blue	Safety Illumination Sentinel System	3 Beeps = Safety Illumination Sentinel System "On"
			4 Beeps = Safety Illumination Sentinel System "Off"

Consumer Remote Feature Programming (7921P, 7920P, 7919P Rev. C)

REMOTE FEATURE PROGRAMMING USING THE CONSUMER'S TRANSMITTER

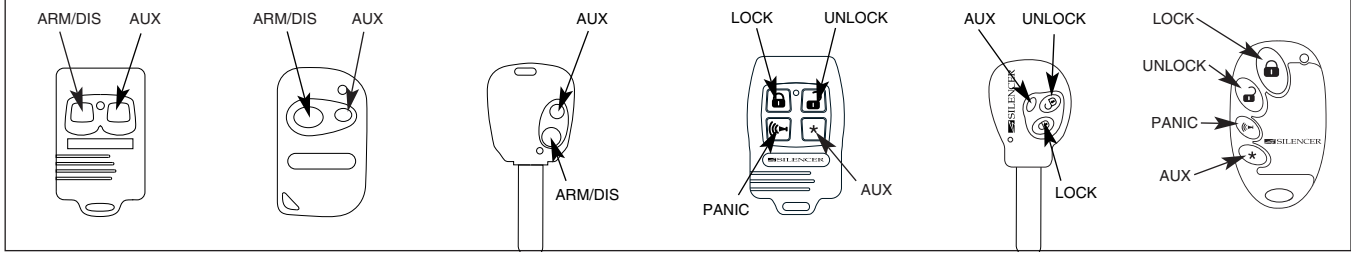

#	Button	Function	Confirmation = Change Function
1	ARM/DIS or LOCK	Chirp Status Indication and Single/Dual Unlock Outputs	1 Beep = Chirp Status Indication "On" 2 Beeps = Chirp Status Indication "Off"
2A	AUX (2-Button) or TRUNK (3-Button) or UNLOCK	Mode "P" Note: The auto arm door locking feature has a default setting of "off" in customer mode. To turn on or off the auto arm door locking feature in customer mode, repeat the steps for the "Blue" button and hold the transmitter button down for more than 3 seconds to get a second confirmation chirp. For example: (1 chirp = 10 sec auto arm on, auto door lock off.) (1 chirp + 1 chirp = 10 sec auto arm on, auto door lock on.)	1 Beep = Automatic Arming of Alarm "On", Automatic Arming of Starter Disable "On" Both will arm 10 seconds after last door is closed or rear 10 seconds after remote disarm. 2 Beeps = Automatic Arming of Alarm "On", Automatic Arming of Starter Disable "On" Both will arm 20 seconds after last door is closed or rear 20 seconds after remote disarm. 3 Beeps = Automatic Arming of Alarm "On", Automatic Arming of Starter Disable "On" Both will arm 45 seconds after last door is closed or rear 60 seconds after remote disarm. 4 Beeps = Automatic Arming of Alarm "Off", Automatic Arming of Starter Disable "On" The starter will disable 70 seconds after last door is closed. 5 Beeps = Automatic Arming of Alarm "Off", Automatic Arming of Starter Disable "Off"
2B	AUX (2-Button) or UNLOCK	Mode "S"	1 Beep = Automatic Arming of Alarm "On", Automatic Arming of Starter Disable "On" Both will arm 30 seconds after last door is closed. 2 Beeps = Automatic Arming of Alarm "Off", Automatic Arming of Starter Disable "On" The starter will disable 70 seconds after last door is closed.
3	Red Button on 5910P Only	Remote Panic from Factory Keyless Keyless Transmitter	1 Beep = Panic "On" 2 Beeps = Panic "Off"
4	ARM/DIS (2-Button)+ AUX (2 Button) or LOCK + UNLOCK	Safety Illumination Sentinel System	3 Beeps = Safety Illumination Sentinel System "On" 4 Beeps = Safety Illumination Sentinel System "Off"

FEATURE PROGRAMMING USING THE CONTROL MODULE'S DIP SWITCHES

The Silencer® model 7921P control module offers 3 programmable features. Follow the instructions enclosed to program these features using the Dip switches in the control module.

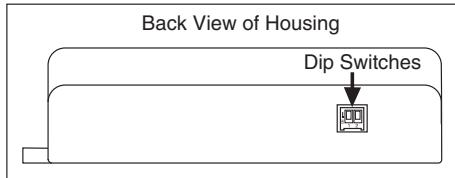

Difference Between if a Dip Switch in Off or On

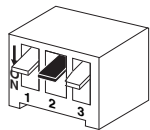

#2 Dip Switch in the "Off" Position

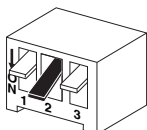

#2 Dip Switch in the "On" Position

Dip Switch #1: Ignition Key Controlled Lock/Unlock (Door lock control function must be connected and the door lock output feature must be "on" in the dealer mode)

Note: This feature can be programmed using the #1 Dip switch in both the dealer and consumer modes.

Place Dip switch #1 to the "On" position to activate this feature.

Place Dip switch #1 in the "Off" position to deactivate this feature.

Dip Switch #2: Current Sensing

Note: This feature can be programmed using the #2 Dip switch in both the dealer and consumer modes.

Place Dip switch #2 to the "On" position to have the current sensing feature on.

Place Dip switch #2 in the "Off" position to have the current sensing feature off.

Dip Switch #3: Door Entry Delay (Applies to 7921P only)

Note: This feature can be pre-programmed in dealer mode using the #3 dip switch. The feature will not be functional in the dealer mode but will become functional when the unit is converted to customer mode.

Place Dip switch #3 in the "on" position. During customer mode operation, the (+) or (-) door input trigger wires will have a 20 second entry delay. This is primarily used for Ford vehicles that have keyless entry and use a door mounted keypad.

Place Dip switch #3 in the "off" position (Factory default) and the 20 second door entry delay will be off (Instant Activation).

DEALER REMOTE FEATURE PROGRAMMING

When the Silencer® security system control module learns the dealer transmitter operating code, a specific group of features are automatically programmed to their default settings. Enclosed, is a chart of the default settings for dealer transmitter operation.

These default setting can only be changed by following the enclosed procedures and using the special 5910P programming transmitter (Shown Below).

To get into the "Dealer Remote Feature Programming" mode repeat the following procedures:

#	Programmable Feature	Default Setting
1	Single/Dual Unlock Pulses	Single
2	Automatic Arm Door Locking (See Note 1)	On
3	Chirp Status Indicator (See Note 2)	On
4	Consumer Remote Feature Programming Modes for Automatic Arming of Alarm and Automatic Arming of Starter Disable. (See Step 5 and Note 3 for Full Details)	Mode "P"

Note: Pre-programming the "P and S" type auto arming modes is for use when the system is put into consumer mode only. In dealer mode, auto arming is on without On/Off programming and auto arm locking is on but can be programmed off as explained below.

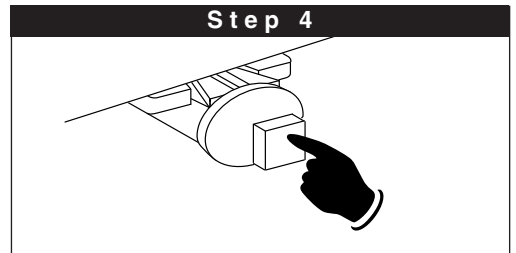
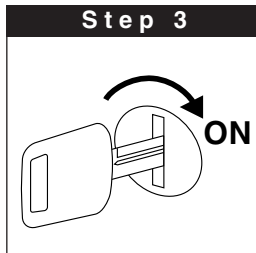
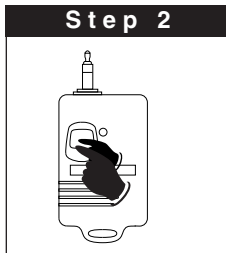
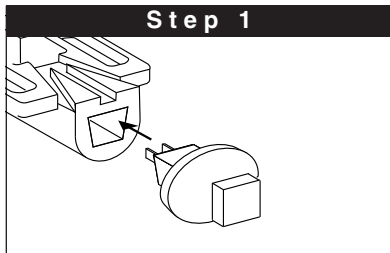

Insert the Valet Switch

Dealer Switch (Red Button) Consumer Switch (Black Button)

Momentary Switch Toggle Switch

Push On/Off Push it On then Push it again for Off

Disarm Security System

The LED will be off and the horn/ siren will emit 2 short beeps.

Turn On Ignition

Push the Valet Switch:
4 Times if Using a Red Button Switch
8 Times if Using a Black Button Switch
 (Represents 4 Times On/Off)

The LED will be on solid. The horn/ siren will emit 1 long then 1 short beep) You are now in the "Dealer Remote Feature Programming" mode.

Step 5

5910P Programming Transmitter

Use the 5910P transmitter and the chart below to adjust the features as required. Press the button that controls the function you want to change and listen for the chirp confirmation. You can repeatedly press the same colored button and turn the same function on and off as many times as required until the operation is correct. After all functions have been re-programmed to operate as required go to step 6.

Step 6

#	Button Color	Changed Function	Confirmation
1	Black	Single or Dual Unlock Outputs	1 Beep = Single Unlock Pulse 2 Beeps = Dual Unlock Pulses
2	Blue	Dealer Mode Auto Arm Door Locking Pre-Programmed Consumer Mode Auto Arm	1 Beep = Automatic Arm Door Locking On, Consumer Auto Arm is ON 2 Beeps = Automatic Arm Door Locking OFF, Consumer Auto Arm is ON 3 Beeps = Automatic Arm Door Locking On, Consumer Auto Arm is OFF 4 Beeps = Automatic Arm Door Locking OFF, Consumer Auto Arm is OFF
3	Red	Chirp Status Indicator On/Off	1 Beep = On, 2 Beeps = Off
4	** Black + Blue	Selects "P" or "S" Mode Operation	4 Beeps = Mode "P" (See 2A Consumer Programming) Automatic Arming of Alarm is "Programmable" and Automatic Arming of Starter Disable is "Programmable" in Consumer Mode Only. 3 Beeps = Mode "S" (See 2B Consumer Programming) Automatic Arming of Alarm is "Programmable" in Consumer Mode. Automatic Arming of Starter Disable is Always "On" and is "Not Programmable" in Dealer or Consumer Mode.

**** Note: The Black +Blue Buttons Change Automatic Alarm Arming of Alarm and Automatic Arming of Starter Disable in the Consumer Mode Only!**

Default Dealer Mode Operation is Always: Automatic Arming of Alarm "On", Automatic Arming of Starter Disable "On" and Automatic Door Locking "On".

Turn Off the Ignition

The LED will be off and the horn/siren will emit 1 short beep and 1 long beep. You are now out of the feature programming mode.

Note 1: When transmitter operation is changed from a dealer transmitter to a consumer transmitter the automatic arm locking feature will default to "OFF". This feature can be programmed on in the customer mode by following the consumer feature programming chart.

Note 2: When transmitter operation is changed from a dealer transmitter to a consumer transmitter the horn/siren and chirp indicator will return to an "on" condition.

Note 3: When transmitter operation is changed from a dealer transmitter to a consumer transmitter, the automatic arming of alarm and automatic arming of starter disable (Mode "S" or "P") will remain as programmed in the dealer transmitter mode. In order to change Mode "S" or Mode "P" operation, you have to re-code a dealer transmitter to the unit and change the operation in the dealer remote programmable feature mode.

WAKING UP A UNIT FROM THE "SLEEP MODE"

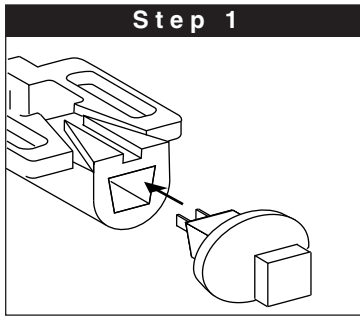

Step 1

Insert the Valet Switch

Dealer Switch (Red Button) Consumer Switch (Black Button)

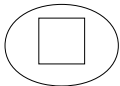

Momentary Switch (Push On/Off)

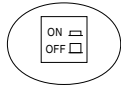

Toggle Switch (Push On then push it again for off)

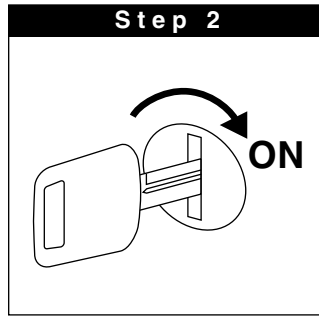

Step 2

Turn On Ignition

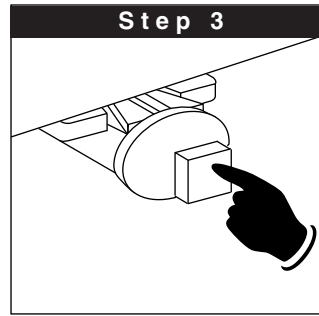

Step 3

Push the Valet Switch 3 Times for Red Button 6 Times for Black Button (Represents 3 Times On/Off)

- A. Long horn chirp indicates the unit is in code learning mode.
- B. LED comes on indicating the unit is in code learning mode.

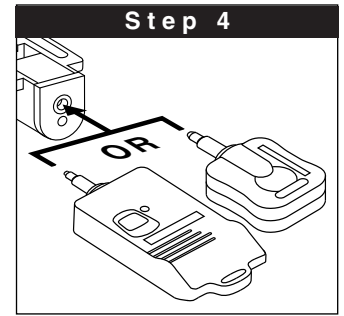

Step 4

Insert a Dealer or Customer Key

- A. Horn chirps once to indicate the code has been learned.
- B. LED starts flashing slowly to indicate the code has been learned.

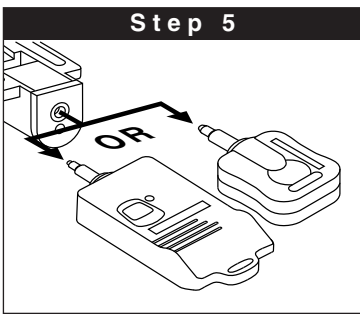

Step 5

Remove the Dealer or Customer Key

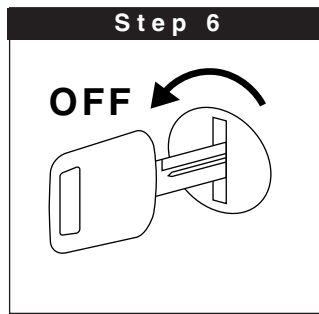

Step 6

Turn Off Ignition

- A. Horn chirps 1 short then 1 long to indicate you have exited code learning.
- B. LED starts flashing slowly.

PROGRAMMING THE UNIT TO "SLEEP MODE"

In the event the customer declines to purchase the Silencer security system and the system is not going to be removed from the vehicle, it must be put into "Sleep" mode to prevent automatic arming.

The white sleep key can also be used to delete a dealer code and to reset the security system to it's original state as it was received from the factory.

Note: The system must be in dealer mode to use the white key. If the system is armed, you should disarm it with the dealer key to prevent triggering.

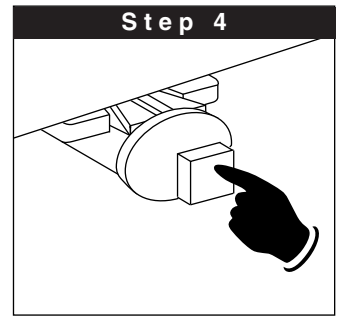
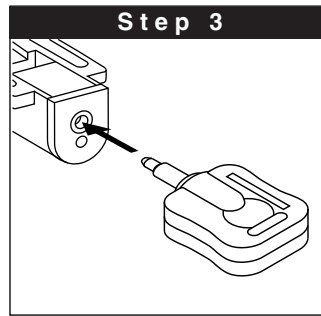
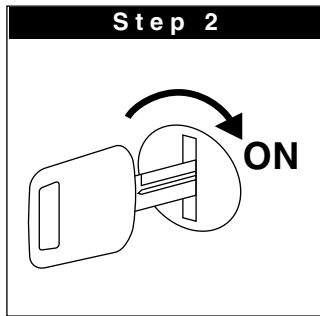
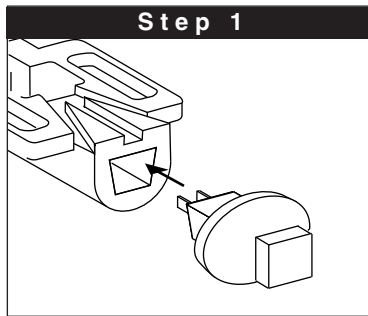

Insert the Valet Switch

Dealer Switch (Red Button) Consumer Switch (Black Button)

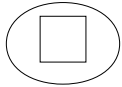

Momentary Switch (Push On/Off)

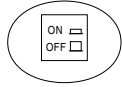

Toggle Switch (Push On then push it again for off)

Turn On Ignition

Insert the White "Sleep" Key into the Receptacle

Push the Valet Switch 6 Times for Red Button 12 Times for Black Button (Represents 6 Times On/Off)

A. The LED will flash 6 times.

B. 6900P, 6900P-2 or 6905P: If the 5911 buzzer is installed, it will emit 6 beeps.

6909P: The horn/siren will emit 6 beeps. Also the parking lights will flash 6 times.

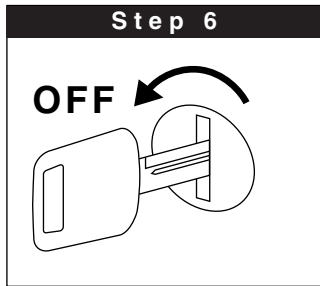
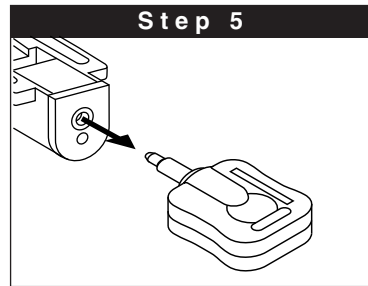

Remove the White "Sleep" Key

Turn Off Ignition

A. The LED will be off. You are now in the "Sleep" mode.

DELETING THE DEALER OR CONSUMER KEY

Upon the customer purchasing the 6905P or 6909P, it will arm/disarm from the factory keyless remotes. He/she also has the option of purchasing a customer key pack (5900PKP) to disarm the security system.

In the event the customer declines to purchase the customer Key Pack (5900PKP) the dealer key code "must" be deleted. This is done by programming in the bright orange "dealer delete key".

If the customer declines to purchase the customer key pack for the 6909P, but still wants the unit to automatically arm; see 6909P Feature Programming to activate this feature.

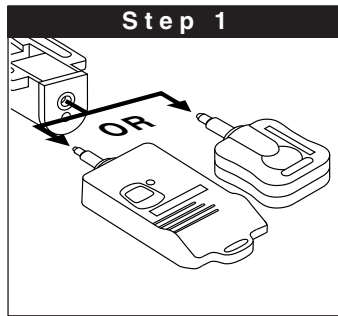

Disarm the Security System

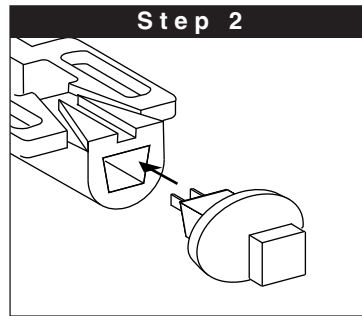

Insert the Valet Switch

Dealer Switch (Red Button) Consumer Switch (Black Button)

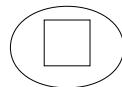

Momentary Switch (Push on/off)

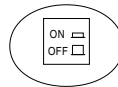

Toggle Switch (Push on then push it again for off)

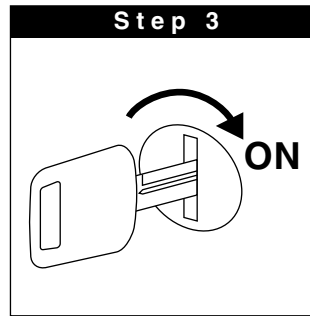

Turn On Ignition

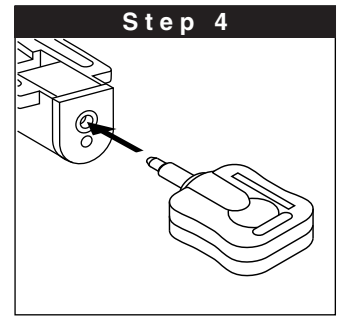

Insert the Orange "Delete Code" Key into the Receptacle

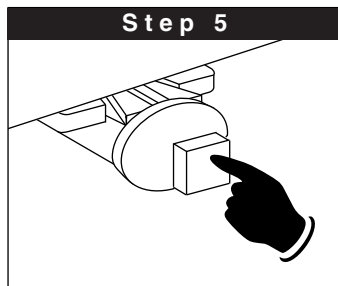

Push the Valet Switch 6 Times for Red Button 12 Times for Black Button (Represents 6 Times On/Off)

A. The LED will flash 6 times. (6905P and 6909P)

B. 6905P: If the 5911 buzzer is installed, it will emit 6 beeps.

6909P: The horn/siren will emit 6 beeps. Also the parking lights will flash 6 times.

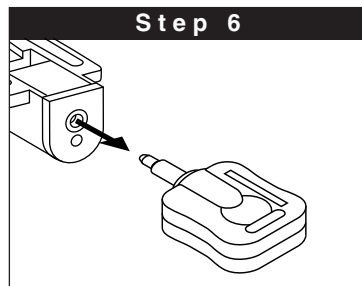

Remove the Orange "Delete Code" Key

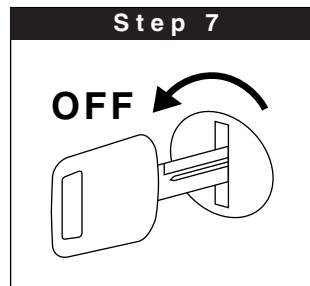

Turn Off Ignition

A. The LED will be off. (6905P and 6909P) You have now deleted all key codes.

B. The horn/siren/chirper will emit 1 short and 1 long chirp.

Note: When dealer or consumer key code is deleted the security system will be in the consumer mode..

CONSUMER KEY CODING

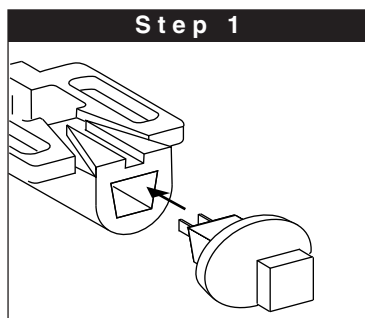

Insert the Valet Switch

Dealer Switch (Red Button) Consumer Switch (Black Button)

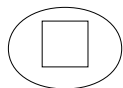

Momentary Switch (Push On/Off)

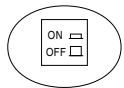

Toggle Switch (Push On then push it again for off)

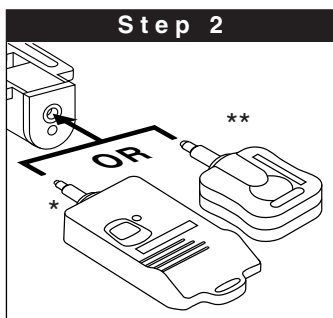

Insert the Dealer Key

* Model: 5910K
** Model: 5900-DB (Blue Key)
5900-DG (Green Key)
5900-DR (Red Key)
5900-DY (Yellow Key)

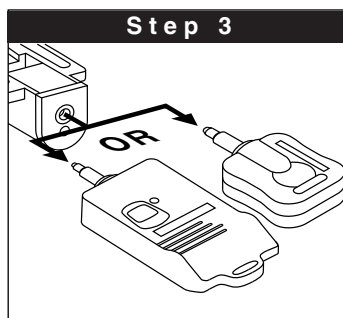

Remove the Dealer Key

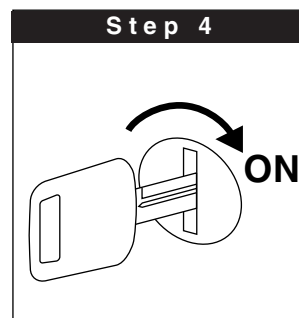

Turn On Ignition

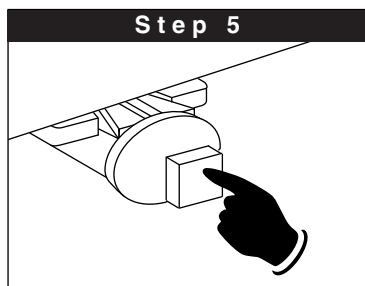

**Push the Valet Switch
3 Times for Red Button
6 Times for Black Button
(Represents 3 Times On/Off)**

A. Long horn chirp indicates the unit is in code learning mode.

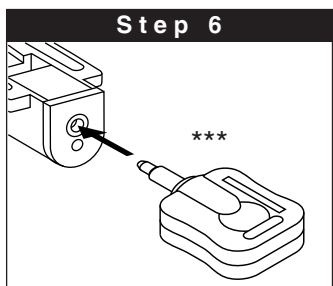

Insert the Customer Key

A. Another short horn chirp indicates the key code was learned.
Note: The system will automatically exit code learning if a key is not inserted within 15 seconds.

*** Model: 5900PKP

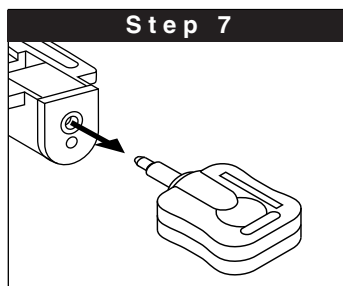

Remove the Customer Key

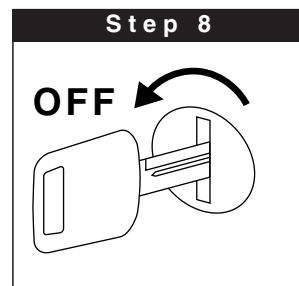

Turn Off Ignition

A. A short and long horn chirp indicates you have exited code learning.

Note: The dealer key will be erased when programmed to the customer key.

This device complies with part 15 of the FCC rules. Operation is subject to the following two conditions. □

- 1)•This device may not cause harmful interference, and □
- 2)•This device must accept any interference received, including interference that may cause undesired operation. □

Per FCC 15.21, you are cautioned that changes or modifications not expressly approved by the part responsible for compliance □ could void the user's authority to operate the equipment. □