

MODEL ALA225 REMOTE CONTROL AUTO ALARM SYSTEM INSTALLATION & OPERATION INSTRUCTIONS

WIRING DIAGRAM

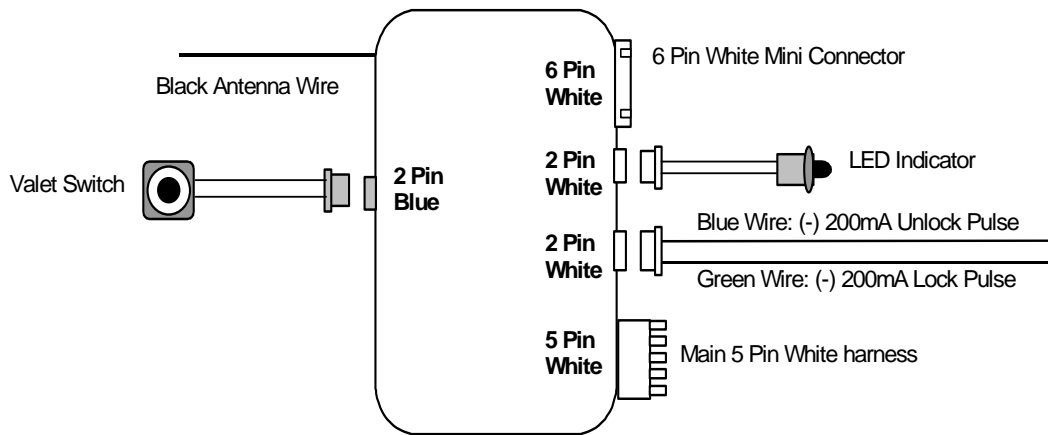

MAIN 5 PIN WIRE HARNESS:

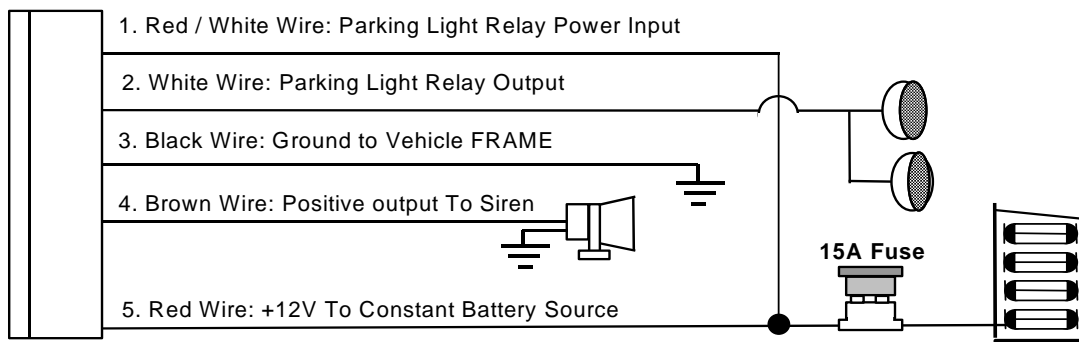

6 PIN MINI CONNECTOR WIRE HARNESS:

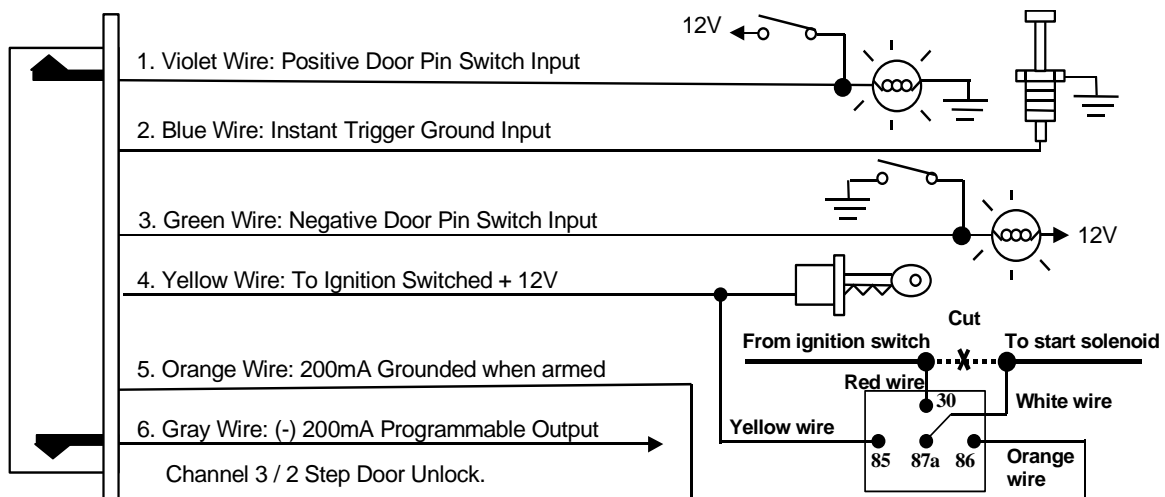

A. PROGRAMMING TRANSMITTER:

Note: This mode will only retain the last 4 remote transmitters programmed. If the transmitter memory is exceeded, the security system will start deleting transmitters from memory in chronological order.

1. Turn the Ignition 'switch 'OFF/ON' 3 TIMES and stay in ON position. Within 15 seconds.

2. Push the Valet switch **3** times and holding in on **3rd** push until a long chirp is hearing then release the valet switch. You are now in the Transmitter programming mode.
3. Press and hold any button of the transmitter until the siren responds with a confirming chirp, indicating the signal has been stored into memory.
4. If you have additional transmitters (up to 4) that need to be programmed, repeat step 3 for each transmitter.

Exit: Turn Ignition to 'OFF' position, or leave it for 15 seconds. Three long chirps & Three parking light flashes to confirm exit.

B. ALARM FEATURES PROGRAMMING:

ALARM FEATURE “I” PRORAMMING:

1. Turn the Ignition 'switch 'ON/OFF' 3 TIMES and stay in OFF position.
2. Push the Valet switch **2** times and holding in on **2nd** push until **one** chirp with a long chirp is hearing then release the valet switch. You are now in the Alarm feature 'I' programming mode.
3. Press and release the transmitter button 'A' corresponding to the feature 'A' you want to change.
 - a. The siren chirps and LED pause will indicate newly setting.
 - b. The system would advance to [2] LED flash, [2] chirp. (The factory default setting is always [1] LED flash, [1] chirp.)
4. Depress the transmitter button 'A' again to change the feature again. Simple keep re-depressing the transmitter button 'A' again until the module advances to your desired setting.
5. Depress the transmitter button 'B' corresponding to the feature 'B' you want to program.

Press Transmitter Button	One Chirp / LED one pulse Factory Default Setting	Two Chirps / LED two pulse
1	Chirps on	Chirps off
2	Automatic Rearm On	Automatic Rearm Off
3 +	Instantly Door Ajar Warning.	45 seconds Delay Door Ajar error chirp.

Exit: Turn Ignition to 'ON' position, or leave it for 15 seconds. Three long chirps to confirm exit.

ALARM FEATURE “II” PRORAMMING:

1. Turn the Ignition 'switch 'ON/OFF' 3 TIMES and stay in OFF position.
2. Push the Valet switch **4** times and holding in on the **4th** push until **two** chirps with a long chirp is hearing then release the valet switch. You are now in the Alarm feature 'II' programming mode.
3. Press and release the transmitter button 'A' corresponding to the feature 'A' you want to program.

Press Transmitter Button	One Chirp / LED one pulse Factory Default Setting	Two Chirps / LED two pulse	Three Chirps / LED three pulse
1	0.9-second Door lock pulses.	3.0-second Door lock pulse.	Double pulse unlock
2	Active arming	Passive arming without passive door locking	Passive arming with passive door locking.
3 +	Ignition controlled door locks & unlocks	Without ignition controlled door locks & unlocks	

Exit: Turn Ignition to 'ON' position, or leave it for 15 seconds. Three long chirps to confirm exit.





ALARM FEATURE “III” PRORAMMING:

1. Turn the Ignition 'switch 'ON/OFF' 3 TIMES and stay in OFF position.
2. Push the Valet switch **6** times and holding in on the **6th** push until three chirps with a long chirp is hearing then release the valet switch. You are now in the Alarm feature 'III' programming mode.
3. Press and release the transmitter button 'A' corresponding to the feature 'A' you want to program.

Press Transmitter Button	One Chirp / LED one pulse Factory Default Setting	Two Chirps / LED two pulse
1		Shock Sensor Program Mode
2	Gray Wire = Trunk (Channel 3) Output	Gray Wire = Two Step Door Unlock Output
3 +	Car Jacking Off	Car Jacking On













Exit: Turn Ignition to 'ON' position, or leave it for 15 seconds. Three long chirps to confirm exit.

ADJUST AND TEST THE SENSITIVITY LEVEL OF THE SHOCK SENSOR

1. Turn the Ignition 'switch 'ON/OFF' 3 TIMES and stay in OFF position.
 2. Push the Valet switch 6 times and holding in on the 6th push until three chirps with a long chirp is hearing then release the valet switch. You are now in the Alarm feature 'Shock Sensor' programming mode.
 3. Press and hold  button for 2 seconds. One long siren chirp to indicates the unit is ready to accept adjustments of the shock sensor.
 4. Press  button on the transmitter once will decrease sensitivity level by one, each time an decrease is made the siren chirp will respond with [1] chirp, while 2 chirp indicates the minimum of sensitivity.
 5. Press  button on the transmitter once will increase sensitivity level by one, each time an increase is made the siren/horn chirp will respond with [1] chirp, while 2 chirp indicates the maximum of sensitivity.
 6. Hit the bumper or strong metal part of the vehicle to test the threshold level of the sensor.
 - a). Activate the warn-away (first stage the shock sensor), the siren will emit a short chirp.
 - b). Activate the full alarm (second stage the shock sensor), the siren will emit a long chirp.
 7. When you are satisfied with the setting, press  and  buttons at the same time. One long siren chirp to indicates the unit is lock in the adjustment.
- Note: If 20 seconds of inactivity expire, or turn on the ignition during of above steps, the unit will exit the program mode and return to the disarmed mode. Three long chirps to confirm exit.

OPERATION MANUAL

TRANSMITTER OPERATION:

Transmitter Button	System Function	Remark
	Arm & Lock door	
 - 	Arm & Delete The Shock Sensor	Press twice within 3 seconds.
	Car Locator	Upon Armed.
 (3 seconds)	Panic function	Press and hold for 3 seconds
	Disarm & Unlock Door	
 - 	Disarm & Two Steps Door Unlock	Press twice within 3 seconds.
 (2 seconds)	Disarm & Pop Trunk Release	Press and Hold for 2 seconds
 + 	Silent Arm / Disarm	Upon Ignition off
 +  (2 seconds)	Activate Car-Jacking	Upon Ignition on

LED INDICATORS:

LED	Function
Off	Disarmed
Slow flash	Armed
Fast flash	Passive arming
On (solid)	Valet mode

LED	Function
2 flashes... pause	Trigger on trunk/hood
3 flashes... pause	Trigger on door switch
4 flashes... pause	Trigger on Dual Zone Shock Sensor
5 flashes... pause	Trigger on Ignition switch

CHIRP INDICATORS:

Chirp	Function
1 chirp	Arm
2 chirps	Disarm
3 chirps	Ajar Warning
4 chirps	Disarm / Intrusion
6 chirps	Car Locator



PARKING LIGHT:

Parking light	Function
1 flash	Arm
2 flashes	Disarm
3 flashes	Disarm / Intrusion
12 flashes	Car Locator

ACTIVE ARMING – LOCK & ARM:

1. Press  button on transmitter.
2. The siren will chirp once and parking light will flash once indicating that the system is now armed. The vehicle doors will lock upon arming when interfaced with the security system.

Ajar Warning: If the siren sounds 3 chirps, then you have left a door, trunk, or hood lid ajar.

Silent Arming / Disarming: Press the  and  buttons at same time will arm or disarm your security system, No chirp sound will be heard, arm / disarm confirmation will be through the vehicles parking lights only.

Shock Sensor By-Pass: Press the  button twice within 3 seconds will arm the security system, by-pass the shock sensor. The system will chirp one additional time to confirm the sensor bypass mode was activated. The sensor bypass feature is programmed to activate for one arming cycle only. The security system will return to normal operation during the next arming cycle.

PASSIVE ARMING:

Active arming / disarming is controlling your security system via the remote transmitter. This security system is equipped with an optional Passive Arming feature, which allows the security system to arm 30 seconds after the last door is closed. Operation is as follows.

1. Turn the ignition to the "OFF" position and exit the vehicle.
2. After all entrances are closed, the security system LED will flash fast for 30 seconds. If you reopen any door / hood / trunk, the security system LED will stop flashing. It will begin flashing again once the vehicle all entrances are closed.
3. After 30-second timer has elapsed, the security system will automatically "ARM". The siren will chirp [1] time and the parking lights will flash [1] time.

PASSIVE DOOR LOCKING:

The vehicle doors will automatically lock after passive arming cycle has been completed.

ACTIVE DISARMING – UNLOCK & DISARM:

1. Press  button on the transmitter.
2. The siren will chirp twice and parking light will flash twice to indicating that the security system is now disarmed. The vehicle doors will unlock disarming when interfaced with the security system.

Tamper Disarm: If alarm triggered, upon disarm the system, siren chirp 4 times, parking light flash 3 times.

Two Step Door Unlock: This feature will independently unlock the drives door only when disarming the security system. Pushing the  button on the transmitter a second time within 3 seconds will unlock the entire vehicle.

Automatic Re-Arm: If this feature is selected, the security system will automatically re-arm itself 60 seconds after disarming with remote transmitter. Automatic rearm will cancel if any door is opened before the 60 seconds timer has elapsed.

DISARMING WITHOUT A TRANSMITTER

The Override function may be used if the remote transmitter is lost or inoperative.

1. Enter the vehicle and turn the ignition switch to 'ON' position. (Alarm will sound.)
2. Within 10 seconds push and release the valet switch

The alarm will stop sounding and enter the disarm mode. You can now start and operate the vehicle normally.

VALET MODE:



The valet switch allows you to temporarily bypass all alarm function, eliminating the need to hand your transmitter to parking attendants or garage mechanics. When the system is in valet mode, all alarm function is bypassed, however the remote panic feature and remote door locks will remain operational.

- Enter Valet Mode:**
1. Turn the ignition to "ON" position.
 2. Push and hold valet switch for 2 seconds until the LED turns on. The LED will remain on as long as the system is in 'valet mode'.

- Exit Valet Mode:**
1. Return to normal operation, turn ignition 'ON'.
 2. Push and hold valet switch for 2 seconds, The LED will turn off indicate the system are exiting the valet mode.

PANIC FUNCTION:

The transmitter can be used as a remote panic switch to manually trigger the alarm in case emergency.

1. Press and hold  button on the transmitter for 3 seconds. The alarm will immediately sound.
2. To stop the alarming press and hold  button on the transmitter for 3 seconds.
3. If the button is not pressed, the alarm will automatically stop after 30 seconds.

TRIGGER THE SYSTEM

When armed, your vehicle is protected as follows:



1. Light impacts will trigger the warn-away signal. A long chirp from siren/horn.
2. Heavy impacts / Doors open / Hood open / Trunk open / Turns on the ignition switch will trigger the programmed sequence.

The starter disable relay (if installed) prevents the vehicle's starter from cranking. The siren and parking lights will turn on to alerting of an intrusion for 30 seconds. Then it will stop and automatic reset and re-arm. If the one of sensors or detectors still active, the alarm system will sound a maximum of 6 times of 30 seconds cycles.

ANTI CAR - JACKING

Warning: If you don't need the car jacking function in this alarm system, be sure to set car jacking feature "OFF". This system is default setting car jacking "OFF".

Active Anti Car Jacking:

1. Upon ignition is "On", press and hold the transmitter  and  buttons at the same time for 2 seconds. The parking lights will turn on for 1.5 seconds to indicate the system enters the car-jacking mode.
2. Once the system in car-jacking mode, If you are forced from the vehicle, the system will be trigger when the door is opened and closed while the ignition is "ON".

Trigger The Car Jack Mode:

- a). 50 seconds after the system has been triggered. The siren will start chirping for 15 seconds.
- b). During this 15 seconds period of chirping, you will be alerting to push the valet switch once to turn off the car-jacking feature. If not, it will enter second timer car jacking.
- c). 65 seconds after the system has been triggered. The siren starts alarming and the parking light starts flashing.
- d). 90 seconds after the system has been triggered
 - 1. The siren still alarming and the parking light flashing, and
 - 2. The starter disable will activate to prevent the vehicle from starting.
 - 3. It will remain active until the vehicle's battery power exhausted.

Override The System To Turn Off Car Jacking: Turn the ignition switch from OFF to ON, and within 10 seconds push valet switch, the siren will stop and the system disarmed

CAR LOCATOR:

Upon armed, press  button on the transmitter to active car locator function. The siren will chirp 6 times. The parking light will flash 12 times, for you to easily locate your car.

TRUNK RELEASE..

Press and hold  button on transmitter for two seconds to remote control the trunk release or other electric devices.

This device complies with part 15 of the FCC rules. Operation is subject to the following two conditions.

(1)This device may not cause harmful interference, and

(2)This device must accept any interference received, including interference that may cause undesired operation.

Per FCC 15.21, you are cautioned that changes or modifications not expressly approved by the part responsible for compliance could void the user's authority to operate the equipment.