

MODEL RST871A
REMOTE ENGINE STARTER
WITH ALARM SYSTEM
OWNER'S MANUAL

TABLE OF CONTENTS:

A. REMOTE TRANSMITTER OPERATION	4
B. BUTTON LOCK	4
C. LED DISPLAY	5
D. CHIRP INDICATOR	5
E. PARKING LIGHT	5
F. ALARM OPERATION CONDITION	5
G. ACTIVE ARMING – ARM & LOCK	5
Defective Sensor Reminder	
Silent Arming / Disarming	
Shock Sensor By-Pass	
H. PASSIVE ARMING	6
Passive Arming with Passive Door Locking	
Passive Arming By-Pass	
I. ACTIVE DISARMING – UNLOCK & DISARM	6
Tamper Disarming	
Pathway Illumination	
Two Steps Door Unlock	
Automatic Re-Arm	
J. DISARMING WITHOUT A TRANSMITTER	6
Overrides the Alarm without Password Pin Code	
Overrides the Alarm With Password Pin Code	
K. VALET MODE	7
Enter Valet Mode	
Exit Valet Mode	
L. CAR LOCATOR	7
M. PANIC FUNCTION	7
N. TRIGGER THE SYSTEM	8
Clear The Trigger Icons and Melody Sound	
Stop The Melody Sound Only	
Noise Abatement Circuit	
O. ANTI CAR- JACKING	8
Active Anti Car Jacking	
Passive Anti Car Jacking	
Trigger The Anti Car Jacking Mode	
Override The System To Turn Off Anti Car Jacking	
P. SYSTEM' S TRIGGER CHECK	9
Q. SYSTEM' S STATUS CHECK	9
R. DRIVER PAGING (OPTIONAL)	9
S. DOME LIGHT CONVENIENCE DELAY & SUPERVISION	9
T. IGNITION CONTROL THE DOOR LOCK/UNLOCK.	9
U. TRUNK RELEASE (CHANNEL 3) OUTPUT	10
V. CHANNEL 4 TIMER CONTROL OUTPUT	10
W. CHANNEL 5 TIMER CONTROL OUTPUT	10
X. CHANNEL 6 TIMER CONTROL OUTPUT	10
Y. POWER ON MEMONRY:	10

REMOTE START OPERATION:

A. TO REMOTE START THE VEHICLE	10
Safe Start (Child safety mode)	
B. TO OPERATE THE VEHICLE WHILE RUNNING ON THE REMOTE START	10
C. TEMPORARY STOP FEATURE	11
D. TIMER / TEMPERATURE START	11
3 Hours Timer Start With Temperature-Control Off	
3 Hours Timer Start With Temperature-Control	
Daily Timer Start	
Exit the Timer Start	

E. TEMPERATURE CHECK 11
F. TO TURN OFF THE REMOTE START12
G. SHUT-DOWN INPUT FOR REMOTE STARTER 12
H. DISABLING THE REMOTE START SYSTEM 12

LCD REMOTE TRANSMITTER:

A. BATTERY REPLACEMENT 13
B. THE REMOTE LCD ICONS WITH FUNCTION 13
C. PROGRAMMING OF THE LCD REMOTE TRANSMITTER 14
 1. Screen Lamp ON
 2. Power Save Mode
 3. Clear The Flash Icon and Melody Sound
 4. Stop The Melody Sound.
 5. Button Lock
 6. Vibration / Melody Mode
 7. Enable / Disable Bi Sound While Pressing Button:
 8. Low Battery Indication.
 9. Set Up Fixed Count Down Timer
 10. Out Of The Range Check
D. TIMER SETTING 15
 1. Timer Setting.
 2. Alert Alarm Timer Setting
 3. Count Down Timer Setting
 4. Time Set-Up For "Daily Timer Start"



























WARNINGS:

As with any product that performs automatic functions, there are certain safety precautions that you must practice and be aware of.







1. Keep the transmitter out of children's reach.
2. Do not leave anyone in the vehicle while running on remote control.
3. Alert servicing personnel that the vehicle can be started automatically.
4. Do not start the vehicle by remote while it's in an enclosed area or garage.
5. Always apply the parking brake and lock the vehicle as you exit the vehicle.
6. The vehicle windows must be rolled up.
7. Should the unit malfunction, disconnect the fuse until the problem is corrected.
8. The use and operations of this system is the sole responsibility of the operator.
9. Some areas may have local ordinances that prohibit leaving a vehicle running on public streets.
10. Do not start the vehicle by remote while the standard transmission vehicle is parked at a steep place.

OPERATION:

A. REMOTE TRANSMITTER OPERATION:

Transmitter Button	System Function	Remark
	Lock Doors & Arm System	
	Panic function	Press and Hold for 3 seconds.
	Car Locator	Under armed mode
 - 	Arm and Delete The 2 Stage Shock Sensor.	Press twice within 3 seconds
 + 	Silent Arming / Disarming	Ignition in "off" position.
 + 	Active Anti Car-Jacking Mode	Ignition in "on" position press and hold for 2 seconds
 + 	Channel # 4 Timer Output (4)	
 + 	Channel # 5 Timer Output (5)	
 + 	Channel # 6 Timer Output (6)	
	Unlock Doors & Disarm System	
 - 	Two Steps Door Unlock & Disarm System	Press twice within 3 seconds.
	Trunk Release (Channel 3)	Press and Hold for 2 seconds
 - 	Passive Arming By-pass	While the system Disarmed.
 -  (🔑)	Button Lock	Press within 3 seconds and Hold  button for 2 seconds
 - 	Activate or Turn Off The Remote Start	Press twice within 3 seconds.



LCD DISPLAY TRANSMITTER OPERATION ONLY:

Transmitter Button	System Function	Remark
SET -  (C)	System's Trigger Record Check	Press within 3 seconds
SET - SET -  (C)	System's Status Check	Press within 3 seconds
SET -  (🔑)	Button Lock	Press within 3 seconds and Hold  button for 2 seconds
SET -  (🔔)	Optional Driving Pager	Press within 3 seconds
SET -  (🔑)	Monitor Indoor Temperature	Press within 3 seconds
SET -  (🕒)	Daily Timer Start	Press within 3 seconds
SET	LCD screen lamp turns on for 5 seconds.	Press and hold for 1 second
SET - SET - SET	Clear the Flash Icon and Melody Sound on the LCD Screen Transmitter	Press within 3 seconds



B. BUTTON LOCK:

It is useful if you want to disable the transmission function of the remote control temporarily to prevent from any inadvertent pressing of buttons by others.

1. The regular remote control transmitter:

Press the  button first, within 3 seconds press and hold the  () button for 2 seconds to activate or cancel the button lock function. The "Red LED" will pause flash for few seconds to indicate the remote control transmitter is on "Button Lock" mode while press the transmitter button.

2. The 2-way remote control transmitter:

Press the **SET** button first, within 3 seconds press and hold the  () button for 2 seconds to activate or cancel the button lock function.

The  icon will displayed on the LCD screen to show the LCD remote transmitter is on "Button Lock".



C. LED display:

LED	Function
Off	Disarmed
Slow Flash	Armed
Flash	Passive Starter Disable
Fast Flash	Passive Arming
On (Solid)	Valet Mode

LED	Function
	Zone 1 / Warn-Away Trigger
2 flashes... pause	Zone 2 / Trigger on Trunk/Hood
3 flashes... pause	Zone 3 / Trigger on Door Switch
4 flashes... pause	Zone 4 / Trigger on Shock Sensor
5 flashes... pause	Zone 5 / Trigger on Ignition Switch

D. CHIRP INDICATORS:

Chirp	Function
1 chirp	Arm
2 chirps	Disarm
3 chirps	Defective Reminder
4 chirps	Disarm / Triggered
6 chirps	Car Locator

E. PARKING LIGHT:

Parking light	Function
1 flash	Arm
2 flashes	Disarm
3 flashes	Disarm / Triggered
12 flashes	Car Locator
Constant On	Under Remote Start

F. ALARM OPERATING CONDITION:

	Siren / Horn	Parking Light	LED	Doors	Starter	Dome Light
1. Arming	1 or 3 Chirps	1 Flash	Slow Flash	Locking	Disable	
2. Disarming	2 or 4 Chirps	2 or 3 Flashes		Unlocking		Turns on for 30 -second
3. Trigger	Alarming	Flashes	Slow Flash		Disable	Flashes
4. Passive Starter Disable			Fast Flash		Disable	
5. Panic	Alarming	Flashes				Flashes
6. Car-Jacking	Alarming	Flashes			Disable	Flashes
7. Car Locator	6 Chirps	12 Flashes		Locking		

G. ACTIVE ARMING – LOCK & ARM:

1. Press  button on the transmitter.
2. The siren will chirp once and parking light will flash once indicating that the system is now armed. The vehicle door will lock upon arming when interfaced with the security system.

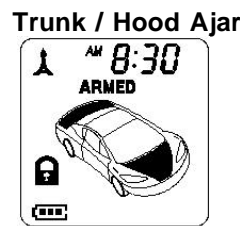
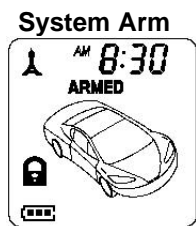

Clear The Flash Icon:

Press the **SET** button 3 times within 3 seconds will clear the flash icon on the LCD screen transmitter.

DEFECTIVE SENSOR REMINDER: If the siren sounds 3 chirps, then you have left a door, trunk, or hood lid ajar. (See Alarm Feature "I - 4 Programming)

SILENT ARMING / DISARMING: Press the transmitter  and  button at the same time will arm or

disarm your security system, No chirp sound will be heard, arm / disarm confirmation will be through the vehicles parking lights only.

SHOCK SENSOR BY-PASS: Press the  button on the transmitter two times within 3 seconds will arm the security system and by-pass the shock sensor. The system will chirp one additional time to confirm the sensor bypass mode was activated. The sensor bypass feature is programmed to activate for one arming cycle only. The security system will return to normal operation during the next arming cycle.



H. PASSIVE ARMING

Active arming / disarming is controlling your security system via the remote transmitter. This security system is equipped with an optional Passive Arming feature, which allows the security system to arm 30 seconds after the last door is closed. Operation is as follows.

1. Turn the ignition to the “OFF” position and exit the vehicle.
2. After all entrances are closed, the security system LED will flash fast for 30 seconds. If you reopen any door / hood / trunk, the security system LED will stop flashing. It will begin flashing again once the vehicle all entrances are closed.
3. After 30-second timer has elapsed, the security system will automatically “ARM”. The siren will chirp [1] time and the parking lights will flash [1] time.

PASSIVE ARMING WITH PASSIVE DOOR LOCKING (See Alarm Feature “I - 2” Programming):

The vehicle doors will automatically lock after passive arming cycle has been completed.

PASSIVE ARMING BY-PASS: While the system disarmed, Press the  buttons twice, the security will respond with [1] chirp and LED will turn “ON”. The security system will remain in this temporally state for as long as you wish. To exit passive by-pass, press the transmitter  or  button and the system will return to normal status.

I. ACTIVE DISARMING – UNLOCK & DISARM:

1. Press  button on the transmitter.
2. The siren will chirp twice and parking light flash twice to indicating that the security system is now disarmed. The vehicle’s door will unlock and dome light turns on for 30 seconds upon disarming when interfaced with the security system.

System Disarm



Doors Trigger



Trunk/Hood Trigger



Warn away Trigger



Shock Sensor Trigger



Ignition Trigger



Clear The Flash Icon:

Press the **SET** button 3 times within 3 seconds will clear the flash icon on the LCD screen transmitter.

TAMPER DISARMING: If alarm triggered, upon disarm the system, siren chirp 4 times, parking light flash 3 times.

PATHWAY ILLUMINATION (See Alarm Feature “II - 3” Programming): This feature turns the parking light “ON” for 30 seconds upon a unlock signal and for 10 seconds upon the lock signal.

TWO STEPS DOOR UNLOCK (See Alarm Feature “III - 2” Programming): This feature will independently unlock the driver’s door only when disarming the security system. Pushing the  button a second time within 3 seconds will unlock the other doors.

AUTOMATIC RE-ARM (See Alarm Feature “I - 3” Programming): If this feature is selected, the security system will automatically re-arm itself in 60 seconds after disarming with remote transmitter. Automatic rearm will cancel if any door is opened before the 60 seconds timer has elapsed.

J. DISARMING WITHOUT A TRANSMITTER (Alarm Feature III - 1 Programming)

OVERRIDES THE ALARM WITHOUT PASSWORD PIN CODE: (Factory Default Setting)

The Override function may be used if the remote transmitter is lost or inoperative.

1. Enter the vehicle and turn the ignition switch to 'ON' position. (Alarm will sound.)
2. Within 10 seconds push and release the valet switch

The alarm will stop sounding and enter the disarm mode. You can now start and operate the vehicle normally.

OVERRIDE THE ALARM WITH PASSWORD PIN CODE: (Alarm Feature III - 1 Programming)

Unlike valet switch easily found, and defeated, this security system allows the consumer to program a password pin code. Offering a higher level of security.

1. Enter the vehicle and turn the ignition switch to 'ON' position. (Alarm will sound.)
2. Within 5 seconds, enter your chosen the first digit code by press and release the Valet Switch.
(When finished above procedures, system's siren stop alarming, parking light stop flashing, but the vehicle can not be start and drive away.)
3. Within 15 seconds of the last digit code enter (the 1st code), turn the Ignition Switch “OFF” and then “ON”.
4. Within 15 seconds, enter your chosen of the second digit code by press and release the Valet Switch.
5. Turn the ignition switch “OFF” position.

[4] Chirps form siren/horn, [3] flash from parking light to indicate the system was disarmed.

Note 1: You must override the alarm within 60 seconds. If not, the system will automatically re-arm.

EXAMPLE: To Override The System With The Password Code 83, you would;

1. Enter the vehicle and turn the ignition switch to 'ON' position. (Alarm will sound.)
2. Within 5 seconds, Press and Release the Valet Switch 8 times
(When finished above procedures, system's siren stops alarming, parking light stop flashing, other sensor stop trigger, but the vehicle can not be start and drive away.)
3. Within 15 seconds of the last digit code enter (the 1st code), turn the Ignition Switch “Off” and then “ON”.
4. Within 15 seconds, Press and Release the Valet Switch 3 times
5. Turn the Ignition Switch to “Off” position.
[4] Chirps form siren/horn, [3] flash from parking light to indicate the system was disarmed.

K. VALET MODE: (System in Disarm or Valet mode)

The valet switch allows you to temporarily bypass all alarm function, eliminating the need to hand your transmitter to parking attendants or garage mechanics. When the system is in valet mode, all alarm function and remote start function are bypassed, however the remote panic feature and remote door locks will remain operational. To use the valet mode, the system must first be disarmed either by using you remote transmitter, or by operating the Manual override sequence.

Enter Valet Mode:

1. From the disarmed condition, turn the ignition to “ON” position.
2. Push and hold valet switch for 2 seconds until the LED turns on. The LED will remain on as long as the system is in 'valet mode'.

Remote Door Lock



Remote Door Unlock

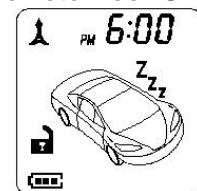

Exit Valet Mode:









1. Return to normal operation, turn ignition 'on'.
2. Push and hold valet switch for 2 seconds, The LED will turn off indicate the system are exiting the valet mode.

L. CAR LOCATOR

Under armed mode, press the  button to active car locator function. The siren will chirp 6 times. The parking light will flash 12 times, for you to easily locate your car.

M. PANIC FUNCTION: (See Alarm Feature I - 7 Programming.)

The transmitter can be used as a remote panic switch to manually trigger the alarm in case emergency.

1. Press and hold the  button for 3 second. The alarm will immediately sound.
2. During panic mode, the normal function of this transmitter button will be suspended. The transmitter  and  buttons can be used to lock and unlock the door (if the option is installed), however once the  button is pressed, the vehicle's starter disable device, (where installed) will be enable allowing the vehicle to start.
3. To stop the alarm, press and hold the transmitter  or  button on the transmitter again for 3 seconds. Also if any transmitter button other than  or  button is pressed and released, the panic mode will be turned off immediately.
4. If the button is not pressed, the alarm will automatically stop after 60 seconds.

N. TRIGGER THE SYSTEM

When armed, your vehicle is protected as follows:

1. Light impact will trigger the warn-away signal.
2. Heavy impacts / Doors open / Hood open / Trunk open / Turn on the ignition key will trigger the programmed sequence.

The starter disable relay (if installed) prevents the vehicle's starter from cranking. The siren, horn, parking lights, and dome light will turn on to alerting of an intrusion for 60 seconds. Then it will stop and automatic reset and re-arm. If the one of sensors or detectors still active, the alarm system will sound a maximum of 3 times of 60 seconds cycles.

Doors Trigger



Trunk/Hood Trigger



Warn-away Trigger



Shock Sensor Trigger



Ignition Trigger



CLEAR THE FLASH ICON AND MELODY SOUND: While triggering the alarm the LCD screen will alert user through melody sound and flashing trigger icon, press the **SET** button 3 times within 3 seconds will clear the flash icon and stop melody sound on the LCD screen transmitter.

STOP THE MELODY SOUND ONLY: While triggering the alarm the LCD screen will alert user through melody sound and flashing trigger icon, press any button on the LCD remote transmitter to stop melody sound only

NOISE ABATEMENT CIRCUIT: You system has "Noise Abatement Circuit". It prevents annoying repetitive trigger sequences due to faulty door pin switches or environmental condition such as thunder, jackhammers airport noise, etc.



Here's how "Noise Abatement Circuit" works: The alarm triggers five times. Each time, the same sensor or switch is triggering the alarm. "Noise Abatement Circuit" will interpret this pattern of triggers as false alarm. After the fifth trigger, "Noise Abatement Circuit" ignores, or bypasses, that sensor or switch until the other sensor or switch is trigger.

"Noise Abatement Circuit" covers doors (Hood/Trunk) differently: If the alarm is triggered by an open door for three full cycles, the doors will be bypassed until the trigger ceases.

O. ANTI CAR- JACKING

Warning: If you don't need the car jacking function in this alarm system, be sure to set car jacking feature "OFF". This system is default setting all car-jacking "OFF". (See Alarm Feature **I - 6** Programming.)

ACTIVE ANTI CAR JACKING:

1. Press and hold the transmitter  and  button at the same time for 2 seconds while the vehicle's ignition is ON. The parking lights will turns on for 1.5 seconds to indicate this enter.
2. Once the system is armed, If you are forced from the vehicle, the system will trigger when the door is opened and closed while the ignition is "ON".

PASSIVE ANTI CAR- JACKING:

It operate as below:

1. Turn the ignition switch to "ON" position, the system will arm.
2. Once the system is armed, If you are forced from the vehicle, the system will trigger when the door is opened and closed while the ignition is "ON".

TRIGGER THE ANTI CAR -JACKING MODE:

3-timer circuits will function as follows:

First timer:

- a. 50 seconds after the system has been triggered. The siren will start chirping for 15 seconds.
- b. During this 15 seconds period of chirping, you will be alerting to push the valet switch once to turn off the car-jacking feature.
- c. If not, it will enter second timer car jacking.

Second timer:

65 seconds after the system has been triggered. The siren starts alarming and the parking light starts flashing.

Third timer:

90 seconds after the system has been triggered

- a. The siren still alarming and the parking light flashing, and
- b. The starter disable will activate to prevent the vehicle from starting.
- c. It will remain active until the vehicle's battery power exhausted.

OVERRIDE THE SYSTEM TO TURN OFF ANTI CAR- JACKING:

Turn the ignition switch from OFF to ON, and within 10 seconds push valet switch, the siren will stop and the system disarmed

Note: If you use password pin code to double protect the vehicle security, you will need to use it to completely disarm the system.

P. SYSTEM'S TRIGGER CHECK

Press the transmitter **SET** first, within 3 seconds press  (**C**) button. It responds with one melody sound and all trigger's records will immediately displayed on the LCD screen.



Q. SYSTEM' S STATUS CHECK

When you want to check the system's present status through the LCD screen, Press the transmitter **SET** button twice, within 3 seconds press  (**C**) button. It responds with one melody sound, the LCD screen should be illuminated.



R. DRIVER PAGING

It is useful the event that someone wants to page the driver of the parked vehicle.



Indoor Driving Paging

Under the ignition switch "off" condition, press and hold the valet switch for 2 seconds to page the driver, one chirp sound shall be emitted from the vehicle and the paging melody sound continues sounding from you

Remote LCD Transmitter and "



Outdoor Driving Paging

If someone tries to page you by tapping the paging (knock) sensor (optional) which is usually mounted on the bottom part of front window, the paging melody sound continues sounding from you Remote LCD Transmitter and "

1. Press the transmitter **SET** button first, within 3 seconds press  (**C**) button to activate outdoor driver paging function, It responds with chirps of the vehicle, a melody sound and "
2. When tapping the paging (knock) sensor, one chirp sound shall be emitted from the vehicle and the paging melody sound continues sounding from you Remote

LCD Transmitter and "



3. Turn on the ignition switch; OR press the  button to arm the system; OR press the  button to disarm the system, this outdoor driver paging function will exit.

S. DOME LIGHT CONVENIENCE DELAY & SUPERVISION

The alarm with a unique feature which will turn on your vehicle dome light as following:

1. Upon disarming, the interior light will remain on for 30 seconds.
2. If the vehicle is intruded, the interior light will flash for the same duration as the siren.

Note: Turn on the ignition switch or arm the alarm will turn off the dome light.

T. IGNITION CONTROL DOOR LOCK/UNLOCK. (See Alarm Feature II – 2 Programming).



If the vehicles door locks have been interfaced to the security system, the system will automatically lock the vehicle's doors when the ignition is turned "ON" and /or unlock the vehicle's doors when the ignition is turned "OFF".

U. TRUNK RELEASE (CHANNEL 3) OUTPUT.



Press and hold  button on the transmitter for two seconds to remote control the trunk release or other electric devices.





V. CHANNEL 4 TIMER CONTROL OUTPUT (See Alarm Feature III – 5 Programming.)

Press the transmitter  (4) and  (4) button at the same time to active Channel 4 function. Channel 4 is user-programmable timer output. You may program the built-in timer to send a ground signal for any time duration from 1 second to 120 seconds. For instance, this timer output may be used to turn on the headlight, power window or sunroof. (Factory defaults setting at momentary output.)

W. CHANNEL 5 TIMER CONTROL OUTPUT (See Alarm Feature III – 6 Programming.)

Press the transmitter  (5) and  (5) buttons at the same time to active Channel 5 function. Channel 5 is user-programmable timer output. You may program the built-in timer to send a ground signal for any time duration from 1 second to 120 seconds. For instance, this timer output may be used to turn on the headlight, power window or sunroof. (Factory defaults setting at momentary output.)

X. CHANNEL 6 TIMER CONTROL OUTPUT (See Alarm Feature III – 7 Programming.)

Press the transmitter  (6) and  (6) buttons at the same time to active Channel 6 function. Channel 6 is user-programmable timer output. You may program the built-in timer to send a ground signal for any time duration from 1 second to 120 seconds. For instance, this timer output may be used to turn on the headlight, power window or sunroof. (Factory defaults setting at momentary output.)

Y. POWER ON MEMONRY:

This security system is equipped with circuitry that will allow the unit to remember its alarm state if the power is lost and then reconnected.

REMOTE START OPERATION:

A. TO REMOTE START THE VEHICLE:

When you want to start your vehicle,

1. Press  button twice on the transmitter.
2. The parking light will activate to indicate the remote start received the signal.
3. The engine will start approximately 5 seconds.
4. Once the engine is running, after couple seconds the parking light will turn on again and climate controls will activate and adjust the vehicles interior temperature to your preset setting.
5. The vehicle will run for 5 to 30 minute cycle and automatically shut down.

NOTE: The Remote Start Unit will not start the vehicle if any one of the following conditions exists:

1. The hood is opened.

Activate Remote Start

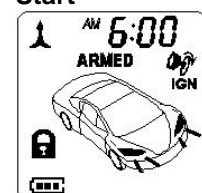

Engine Running

2. The brake pedal is pressed.
3. Move the optional remote start enable toggle switch to OFF position. (If installed)
4. The gear selector is in any gear other than "PARK" or "NEUTRAL"



SAFE START (Child safety mode) (See Start Feature I – 5 Programming.)

Factory defaults setting to press the * button twice on the transmitter to start the vehicle. Programming this feature to eliminate an accidental remote start, when kids enter this transmitter, it requires:

The user press the transmitter  and * buttons at the same time to start the vehicle.

B. TO OPERATE THE VEHICLE WHILE RUNNING ON THE REMOTE START:

To operate the vehicle while engine running on the remote start.

1. Insert the ignition key and turn it to "ON" (not the start) position.
2. Press the brake pedal.

Note: If the brake pedal is pressed before the key is in the ON position, the engine will shut down.

C. TEMPORARY STOP FEATURE:

This feature allows the vehicle to remain running after the key has been removed from the ignition. This feature is useful for occasions when you wish to exit and lock the vehicle for short periods of time, but would like to leave the motor running and the climate control on.

1. Before turning off the engine, press the * button twice on the transmitter and the LED indicator will flash 3 times to confirm enter.
2. Turn the ignition key to OFF position. (The engine will stay running.)
3. The engine will run until the pre-programmed time elapsed or shutdown input is received.

D. TIMER / TEMPERATURE START:

This unit can be programmed to start and run the engine every 3 hours or punctually at the same time next morning, The engine will run for the programmed running time and then shut down.

IMPORTANT: Timer Start should be used only in open areas, Never start and run the vehicle in an enclosed space as a garage or carport.



3 hours timer start with Temperature-control OFF: This feature is design for an extreme cold climate usage. The system will auto start the vehicle every 3 hours, to prevent engine freezing and hard to start. A MAXIMUM OF SIX CYCLES CAN OCCUR.

3 hours timer start with Temperature-control: (See Start Feature I – 7 Programming.)

If you installed the optional Temperature Sensor and programmed the temperature ON to operate. The system can be programmed to automatically start the vehicle engine whenever the temperature inside the vehicle reaches or drops below the preprogrammed temperature level. The system will monitor the air temperature every 3 hour and will only start the engine during extreme cold temperatures. There are three temperature level to choose from.

Daily Timer Start: The feature is very useful for the driver who wants to run the vehicle punctually at the same time next morning. Before set-up of the "Daily Timer Start", you should set you time for engine start. (see Timer Setting / Timer set-up for "Daily Timer Start, page 16)

ENTER:

1. Press the * button twice to remote start the vehicle. As soon as the vehicle is running and the parking light have turned on or flashing.
2. Immediately depress the  button once, within 2 seconds
- 3-a. **3 Hours Timer Start:** Rapidly depresses the * button. The parking light will flash (3) times. The siren or horn chirps (3) times. The vehicle is now programmed to start every (3) hours.
- 3-b. **Daily Timer Start:** Depress the transmitter SET button first, within 3 seconds press *  button. The parking light will flash (6) times. The siren chirps (6) times. The vehicle is now programmed to start at the real time of the next day.
Your set time for the next day engine start flashes for approx. 3 seconds on the LCD screen. After 3 seconds the  icon stays displayed on the LCD screen.
4. Press the brake pedal to stop the vehicle running.



Exit the timer start:

Timer start can be exited manually as follows:



1. Make sure the remote start system is not operating the engine.
2. Turn the ignition on. The LED and parking light will flash (4) times. The horn chirps (4) times.

Or

1. Press the * button twice to remote start the vehicle. As soon as the vehicle is running and the parking light have turned on or flashing.
2. Immediately depress the  button then press and hold the * button for 2 seconds. The parking light will flash (4) times. The siren or horn chirps (4) times. The vehicle is no longer programmed to start automatically.

E. TEMPERATURE CHECK (OPTIONAL)

If you installed the optional temperature sensor, you can monitor, Through the LCD screen, the present indoor temperature of the passenger compartment before cooling or heating your vehicle.

Press the transmitter **SET** buttons first, within 3 seconds press the  () buttons, the in-door temperature will be shown on the LCD screen.



F. TO TURN OFF THE REMOTE START:

When the engine is running (by remote start), if you want to stop it,

1. Press * button twice on the remote transmitter under remote start mode.
2. Move the optional remote start enable toggle switch to OFF position. (If installed)
3. Press the brake pedal

The vehicle will shut down and turn off the parking light to indicate engine stopped.



G. SHUT-DOWN INPUT FOR REMOTE STARTER:

If any of the following conditions exist while the system is operating, the engine will not start or will shut down immediately:

1. The hood is opened.
2. The brake pedal is pressed.
3. Engine is over-revved. {"Tachometer checking type" only}
4. The pre-programmed run time (5 /10 / 20 / 30 minutes) has elapsed.
5. Press * button twice on the remote transmitter under remote start mode .
6. Move the optional remote start enable toggle switch to OFF position. (If installed)
7. The vehicle refused to start running after {3} unsuccessful attempts.

H. DISABLING THE REMOTE START SYSTEM: (If installed)

This feature allows your system's remote start unit to be temporarily disabled to prevent the vehicle from being remote started accidentally. This feature is useful if the vehicle is being serviced or stored in an enclosed area. To disable the remote start, move the optional remote start enable toggle switch to the OFF position.

LCD REMOTE CONTROL TRANSMITTER:

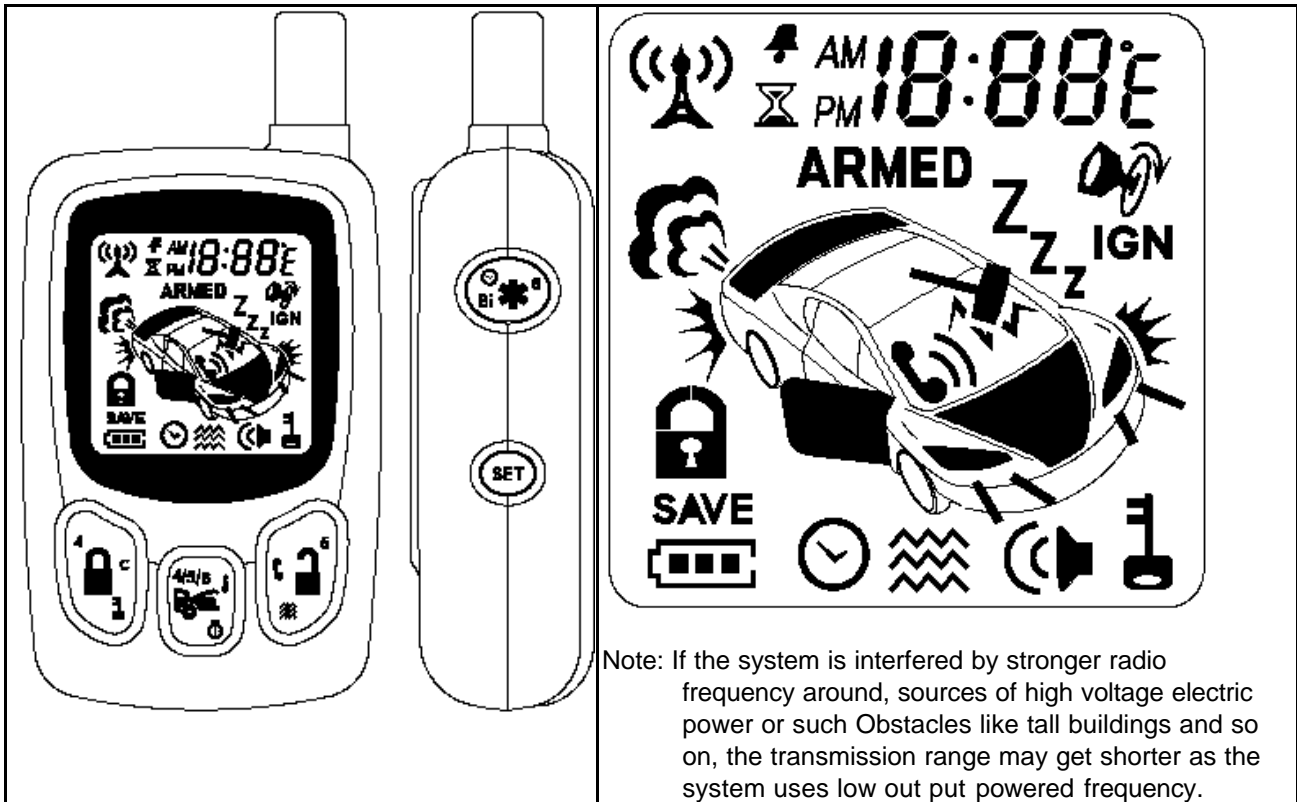

Note: If the system is interfered by stronger radio frequency around, sources of high voltage electric power or such Obstacles like tall buildings and so on, the transmission range may get shorter as the system uses low out put powered frequency.







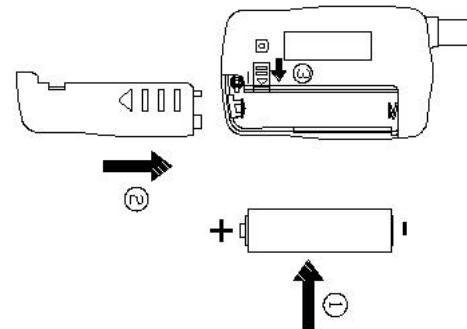





A. BATTERY REPLACEMENT:

A 1.5V type AAA Alkaline battery powers the Remote Transmitter. When the power of the battery weakens a  icon shall be displayed on the LCD screen. When the old battery is replaced to new one, there will be beep sounds indicate the power is up and the clock on the LCD screen returns to **AM12:00** after displaying all the icons.

Correct the time by pressing **SET** for 3 seconds before using (See Timer Setting).



B. THE REMORE LCD ICONS WITH FUNCTION:

- | | | | |
|---|---|---|--|
|  | Door Lock
Your vehicle doors are locked |  | Door Unlock
Your vehicle doors are unlocked and the system is Disarmed |
| ARMED | Armed Mode
Your vehicle is in armed mode |  | Valet Mode
All the function shall be temporarily on hold. |
|  | Remote Transmission
You are transmitting the signal to control unit |  | In - Range Indicator
Your are within the remote control range. |
|  | Door Open Warning
Doors are illegally opened (Zone 3) |  | Trunk/Hood Trigger
Trunk or Hood is illegally opened (Zone 2) |
|  | Shock Sensor Trigger
Trigger on Shock Sensor (Zone 4) |  | Warn Away trigger
Trigger on Shock Sensor (Zone 1) |
|  | Engine Starting
Your vehicle engine starting by remote control |  | Engine Running
Your vehicle's engine is running |
|  | Timer Control Start
Engine start automatically at the same time next day or every 3-hour. |  | Temperature Monitor
Indoor temperature of your vehicle |

Time Monitor

Count Down Timer
Reminder when time is up for parking

Vibration Mode
Remote Control vibrates when the system is triggered

Driver paging
Someone is paging you in front of your vehicle

Alert Alarm

SAVE



Alert Alarm
You have set morning call alarm

Power Save Mode
Save the battery power

Button Lock
Disable the transmission function temporarily

Low Battery
You have to replace the battery of remote control.

C.PROGRAMMING OF THE LCD REMOTE TRANSMITTER:

Transmitter Button	Description	Operation
SET (1 second)	LCD screen lamp turns on for 5 seconds.	Press and hold for 1 second 1 melody sound to confirm enters.
SET (3 seconds)	Timer Programming Mode.	Press and hold for 3 seconds 2-melody sounds to confirm enter.
SET (5 seconds)	Power Save Mode	Press and hold for 5 seconds 1 melody sound to confirm enters.
SET - SET- SET	Clear the Flash Icon and Melody Sound on the LCD Screen Transmitter	Press within 3 seconds
SET - (2-second)	Button Lock () enable / disable	Press within 3 seconds
SET - (2-second)	Melody / Vibration () Mode	Press within 3 seconds
SET - (2-second)	Program Count Down Timer () (10-Minute / 20M / 30 M /1Hour /1.5H / 2.0H)	Press within 3 seconds cycling *leave the buttons starting count down then flashes
SET - * (2-second)	Enable / Disable Bi Sound (Bi) While Pressing Button	

- Screen Lamp ON:** Press and hold the SET button one second, with one melody sound and the LCD screen lamp will turns on for 5 seconds
- Power Save Mode:** While the power save mode, the LCD remote transmitter uses “0” current to save the battery power.

Entry: 1. Press & hold the SET button for 5 seconds, with one melody sound and SAVE icon on the LCD screen to indicate entry the “power save mode”.
2. Under the “Active Arming Mode” and Disarm mode. Turn the ignition switch to on, the LCD remote transmitter will automatically entry the “Power Save Mode”



Exit: Press any button of the LCD remote transmitter to exit the “Power Save Mode”.

- Clear the Flash Icon and Melody Sound:** Press the SET button 3 times within 3 seconds will clear the flash icon and melody sound on the LCD screen transmitter
- Stop The Trigger Melody Sound:** While triggering the alarm the LCD screen will alert user through melody sound and flashing trigger icon, press any button on the LCD remote transmitter to stop melody sound only.

5. Button Lock: It is useful if you want to disable the transmission function of the remote control temporarily to prevent from any inadvertent pressing of buttons by others. Press the SET button first, within 3 seconds press and hold the () button for 2 seconds to activate or cancel the button lock function, the icon will displayed on the LCD screen to show the LCD remote transmitter is on “Button Lock”.



6. Vibration / Melody Mode:

It is useful when you are in a noisy place and difficult to hear beep sound from the remote control as the remote control in this mode, vibrates itself if your security system is triggered.



Press the **SET** button first, within 3 seconds press and hold the () button for 2 seconds to select the mode of vibration or melody, the icon will displayed on the LCD screen to show the LCD remote transmitter is on vibration mode.

7. Enable / Disable Bi Sound While Pressing Button:

It has a short “bi” sound while pressing the button of the LCD screen transmitter

If you want mute the “bi” sound while press button. Press the **SET** button first, within 3 seconds press and hold the *** (Bi)** button for 2 seconds to disable the “bi” sound.

8. Low Battery Indication:

When the power of the battery weakens, it has two short “bi” sound and flash icon while pressing the button of the LCD screen transmitter.

9. Set Up Fixed Count Down Timer:

1. Press the **SET** button first, within 3 seconds press and hold the () button for 2 seconds, the LCD screen will shows icon and timer (ie. 0:10) ,
2. Press the () button again showing next order time on the screen (ie.0:20), press them again (ie.0:30).....and so on.
3. Leave the buttons starting count down then icon flashes

Note: 1.The count down period is fixed as 10 minutes, 20 minutes, 30 minutes, 1 hour, 1.5 hours and 2 hours maximum.

2.When count down timer showing 0:00 means to turn off the timer.

3. Press **SET** button for real time indication when the timer is counting down.

10. Out Of Range Indication:

1. If within the range, the icon will display on the LCD screen.
2. If you are out of range, the icon will disappear on the LCD screen.







D. TIMER SETTING:

	Transmitter Button	Description	Press Transmitter Button
1	Press & Hold the SET button for 3 seconds	Timer Setting (Hour) *Flash digit for adjusting	* for - and for +
	Press the SET button once	Time setting (Minute) *Flash digit for adjusting	* for - and for +
	Press the SET button once.	Alert Alarm Time Setting (Hour) *Flash digit for adjusting	* for - and for +
2	Press the SET button once	Alert Alarm Time Setting (Minute) *Flash digit for adjusting	* for - and for +
	Press the SET button once	Alert Alarm Setting ON / OFF	* for OFF and for ON
	Press the SET button once	Count Down Timer Setting (Hour) *Flash digit for adjusting (Max.19 hours 59 minutes)	* for - and for +
3	Press the SET button once	Count down Timer Setting (Minute) *Flash digit for adjusting	* for - and for +
	Press the SET button once	Count down Timer Setting ON / OFF	* for OFF and for ON
	Press & hold the button for 2 seconds.	Daily Timer Start Timer Setting Flash / icon and “Hours” for adjusting	* for - and for +













EXIT: Press and hold the **SET** button for 2 seconds or leave it for 10seconds, the system will exit the programming mode.

1. Timer Setting: Example to AM10:30













1. Press & hold the **SET** button for 3 seconds, with two-melody sound and the “Hours” digit flashes for adjusting.

2. Press the  or  button to decrease or increase the “Hour” digit until AM10:xx
3. Press the  button once again then the “Minute” digit flashes for adjusting.
4. Press the  or  button to decrease or increase the “Minutes” digit until AM 10:30
5. Press the  button for 2 seconds with one-melody sound to confirm exit the timer program mode.











2. Alert Alarm Timer Setting: Example to PM 6:30

1. Press & hold the  button for 3 seconds, with two-melody sound and the “Hours” digit flashes for adjusting.
2. Press the  button twice, the LCD screen will shows  icon and “Hours” digit is flashes for adjusting.
3. Press the  or  button to decrease or increase the “Hour” digit until **PM 6:xx**
4. Press the  button once again then the “Minutes” digit flashes for adjusting.
5. Press the  or  button to decrease or increase the “Minutes” digit until **PM 6:30**
6. Press the  button once again then  icon flashes for alert alarm “ON / OFF” setting
7. Press the  button to start the “Alert Alarm Timer”, and the “ON” icon will show on the LCD screen.
Press the  button to stop the “Alert Alarm Timer”, and the “OFF” icon will show on the LCD screen.
8. Press  button for 2 seconds with one-melody sound to confirm exit the timer program mode.

3. Count Down Timer Setting: Example Set count down timer at 2:30

1. Press & hold the  button for 3 seconds, with two-melody sound and the “Hours” digit flashes for adjusting.
 2. Press the  button 5 times, the LCD screen will shows  icon and “Hours” digit is flashes for adjusting.
 3. Press the  or  button to decrease or increase the “Hour” digit until **2:xx**
 4. Press the  button once again then the “Minutes” digit flashes for adjusting.
 5. Press the  or  button to decrease or increase the “Minute” digit until **2:30**
 6. Press the  button once again then  icon flashes for alert alarm “ON / OFF” setting
 7. Press the  button to start the count down timer, and the “ON” icon will show on the LCD screen.
Press the  button to stop the count down timer, and the “OFF” icon will show on the LCD screen.
 8. Press the  button for 2 seconds with one-melody sound to confirm exit the timer program mode.
- Note:** Maximum is 19 hours.

4. Time Set-Up For “Daily Timer Start”: Example to AM 6:30

1. Press & hold the  button for 3 seconds, with two-melody sound and the “Hours” digit flashes for adjusting.
2. Press & hold the  button for 2 seconds, the LCD screen will flash  /  icon and “Hours” digit for Hour set-up.
3. Press the  or  button to decrease or increase the hour digit until **AM 6:00**
4. Press the  button once again then the minute digit flashes.
5. Press the  or  button to decrease or increase the minutes digit until **AM 6:30**
6. Press the  button for 2 seconds with one-melody sound to confirm exit the timer program mode.

This device complies with part 15 of the FCC rules. Operation is subject to the following two conditions:

- (1) This device may not cause harmful interference
- (2) This device must accept any interference received: including interference that may cause undesired operation.

Note: The manufacturer is not responsible for any radio TV interference caused by unauthorized modification to this equipment. Such modifications could void the user's authority to operate the equipment.

MODEL RST871A
REMOTE ENGINE STARTER
WITH ALARM SYSTEM
INSTALLATION MANUAL

TABLE OF CONTENTS:

INSTALLATION DIAGRAM	4
H1: 6 PIN HEAVY GAUGE WIRING CONNECTION	6
H1/1 Violet Wire – Starter Output	6
H1/2 & H1/3 Red Wire – +12V Power Input	6
H1/4 Yellow Wire – Ignition 1 Output	6
H1/5 Pink Wire – Ignition 2 Output	6
H1/6 Brown Wire – Accessory Output (Heater /ACC Output)	6
H2: 5 PIN WIRE HARNESS	7
H2/1 Red / White wire – Parking Light Relay Power Input	7
H2/2 White wire – Parking Light Relay Output	7
H2/3 Black wire – System Ground	7
H2/4 Brown wire – Siren Drive Output	7
H2/5 Red wire – System Power	7
H3: BLACK 4-PIN CONNECTOR FOR TWO-WAY TRANSCEIVER/ANTENNA MODULE	7
H4: 3-PIN BROWN CONNECTOR FOR OPTIONAL PAGING (KNOCK) SENSOR	7
H5: 9 PIN MINI BLACK INPUT WIRE CONNECTOR	7
H5/1 White / Black wire – Negative Safety Shut Down Input (Hood -)	7
H5/2 White / Violet wire – Positive Safety Shut Down Input (Brake +)	8
H5/3 Black / White wire – (-) Remote Start Enable Toggle Switch Input	8
– (-) Neutral Safety Switch Input	8
H5/4 Blue wire – Ground Instant Trigger Input (Zone 2)	8
H5/5 White / Green wire – (-) Diesel Wait – To - Start Input	8
H5/6 Green wire – Negative Door Switch Sensing Input (Zone 3)	8
H5/7 Violet Wire – Positive Door Switch Sensing Input (Zone 3)	9
H5/8 White / Blue wire – (-) Instant Start & Turn Off Input	9
H5/9 White / Red wire – Tachometer Signal Connection	9
H7. 4 PIN ORANGE CONNECTOR FOR 2 STAGE SHOCK SENSOR (ZONE 1 / 4)	9
H8: 10-PIN MINI WHITE OUTPUT WIRE CONNECTOR	9
H8/1 Yellow wire – (-) 200ma Ignition 3 Output	9
Transponder Interfacing	
GM VATS Key Override	
H8/2 Black / Violet wire – (-) 200mA Timer Control Channel 6 Output	10
H8/3 Brown / White wire – (-) 200ma Programmable Output	10
Horn Output – (Factory Default Setting)	
Factory Security Rearm Signal Output	
H8/4 White wire – (-) 200ma Dome Light Control Output	10
H8/5 Black / Red wire – (-) 200mA Timer Control Channel 5 Output	11
H8/6 Black / Green wire – (-) 200mA Programmable Output	11
Programmable Timer Channel 4 Output – (Factory Default Setting)	
Key Sensor By-Pass Output	
H8/7 Gray wire – (-) 200ma Channel 3 Output	11
H8/8 Pink wire – (-) 200ma Programmable Output	11
2 Steps Unlock Output (Factory default setting)	
Factory Security Disarm Signal Output	
Start Status (Shock Sensor By-Pass Control) Output	11
H8/9 Orange / White wire – (-) 200ma Grounded Output When Disarmed	11
H8/10 Orange wire – (-) 200ma Grounded Output When Armed	11
H9. 3 PIN GREEN CONNECTOR FOR OPTIONAL TEMPERATURE SENSOR	12
H10. 2 PIN BLUE CONNECTOR FOR THE VALET SWITCH	12
H11. 2 PIN WHITE CONNECTOR FOR THE LED STATUS INDICATOR	12
H6. 3 PIN DOOR LOCK CONNECTOR	12
Install New Door Lock Motors	12
Negative Trigger Door Lock System	12
Positive Trigger Door Lock System	12
Alternating Door Lock System	13
Vacuum Operate Door Locking System	13
2 Steps Door Unlock Wire Connection For 5 Wires Alternating Door Lock System	13
2 Steps Door Unlock Wire Connection For Ground Switched Door Lock System	13

2 Steps Door Unlock Wire Connection For Positive Switched Door Lock System 13

PROGRAMMING & TESTING:

A. PROGRAMMING THE REMOTE TRANSMITTER14
B. FEATURES PROGRAMMING 14
 Alarm Feature "I" Programming 14
 3 / 30 seconds Delay Door Ajar Error Chirp 15
 45 second Door By-Pass (With Dome Light Turn On After Ignition Off) 15
 Alarm Feature "II" Programming 15
 Alarm Feature "III" Programming 15
 Channel 4 (5 / 6) Timer Control Output Programming 16
 Key Sensor By-Pass Output Programming 17
 Password Pin Code Setup 17
 Start Feature "I" Programming 18
 Safe Start (Child Safety Mode) 18
 Start Feature "II" Programming 18
 Tachometer Checking Type – RPM Learning & Testing 19
 Voltage Checking Type – Start Timer Set-up & Testing 19
 Timer Checking Type – Start Timer Set-up & Testing 20
 Test Mode 21
RETURN TO FACTORY DEFAULT SETTING 21
SHUTDOWN DIAGNOSTICS 21
TESTING YOUR INSTALLATION 22
 Test the Brake shutdown circuit... .. 22
 Test the Hood Pin shutdown circuit... .. 22
 Neutral Start Safety Test 22
 Mechanical Neutral Safety Switch Considerations 22
 Park/Neutral ECM Input 22
 Key In Sensor Circuits 23

INTRODUCTION

INSTALLER WARNINGS

This Remote Starter with Alarm System is designed to be installed on fuel injected vehicles with an automatic transmission ONLY.

- Never install this remote starter on a manual transmission vehicle.
- This system must be installed and wired through a safety switch it will not start in any forward or reverse gear.
- Some automatic transmission vehicle [mainly older GM vehicles with a purple starter wire] have a mechanical-type park safety switch instead of electrical safety switch. The mechanical type does not interrupt the starter circuit when the transmission is any gear and does not offer the 100% level of safety required for remote starting purposes. Therefore, our system should never be installed on any vehicle that uses a mechanical type park safety switch.
- Once you install this system, you must verify that the vehicle will not start any forward or reverse gear. Regardless of the type of vehicle.
- Read operation manual for operating and programming routine.
- Do not install any component near the brake, gas pedal or steering linkage.
- Some vehicles have a factory installed transponder immobilizer system that can severely complicate the installation. There is possibility that this system can not be installed on some immobilizer equipped vehicles.
- Most vehicles have an SRS air bag system. Use extreme care and do not probe any wires of the SRS system.
- Disconnect the car battery before connecting work on the vehicle.
- Check behind panels before drilling any holes. Ensure that no wiring harness or other components are located behind the panels that would otherwise be damaged.
- Use conventional crimp lock, bullet on any wiring. Poor wiring, i.e. taped joints will possibly introduce unreliability into the alarm system and may result in false alarms or incorrect operation.
- Install wiring neatly under carpets or behind trim to prevent possible damage to wires.
- For the wire operates the current more than 10A. We suggest soldering all connection point. Do not use crimp lock type connectors or wire nuts.

INSTALLATION DIAGRAM

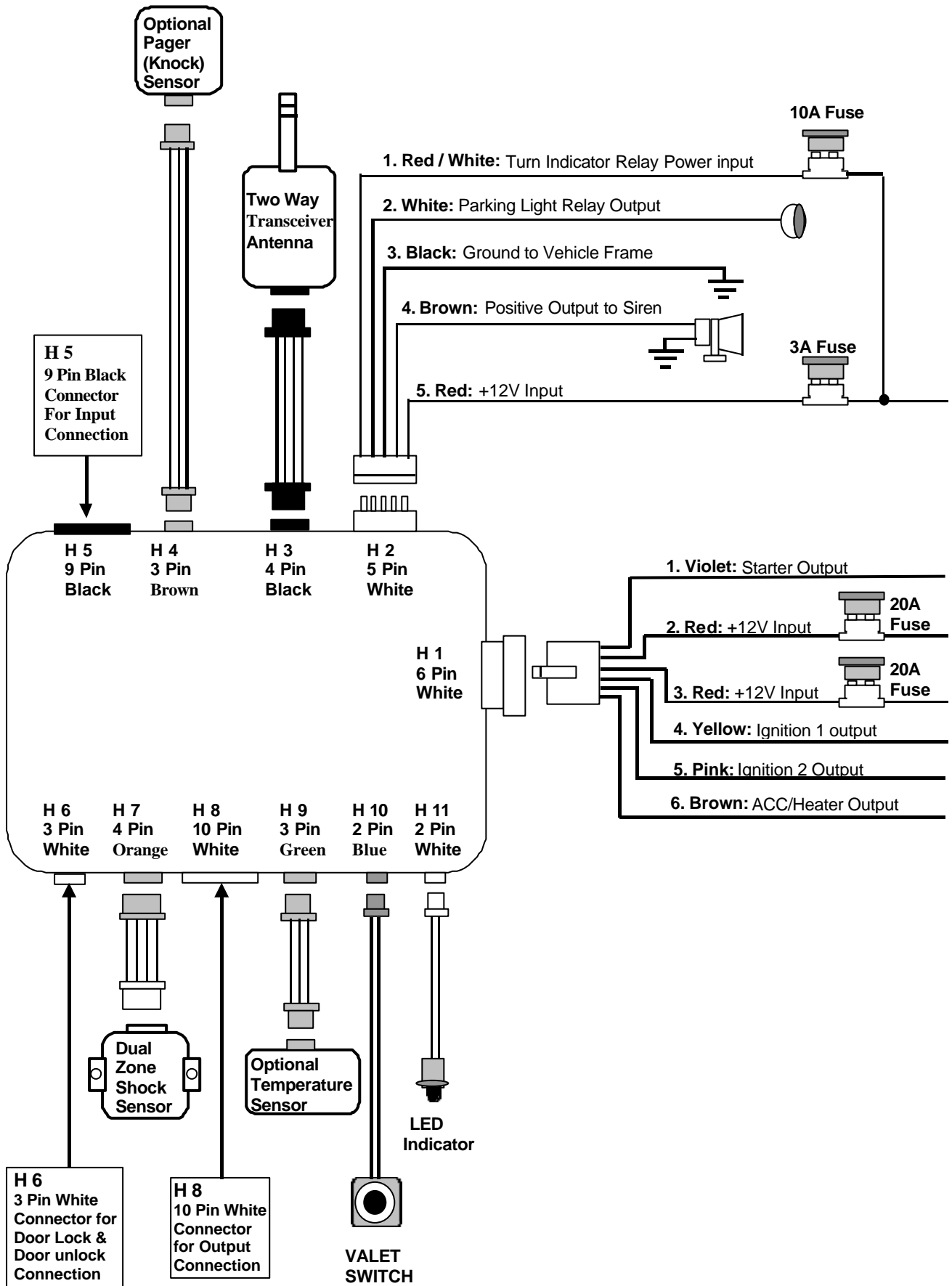

#H5. 9 PIN BLACK CONNECTOR FOR INPUT CONNECTION:

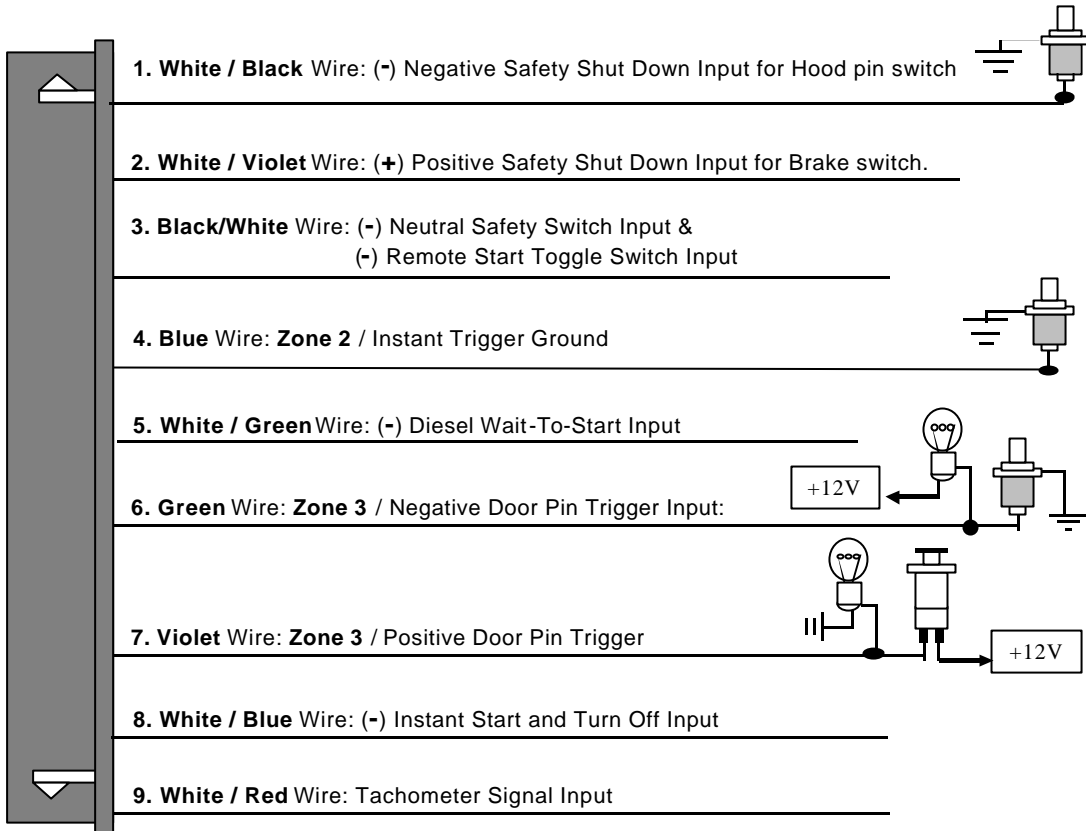

IMPORTANT NOTE: Directly connect the H5/3 BLACK/WHITE wire to the "GROUND" when this wire is not used.

#H8. 10 PIN WHITE CONNECTOR FOR OUTPUT CONNECTION

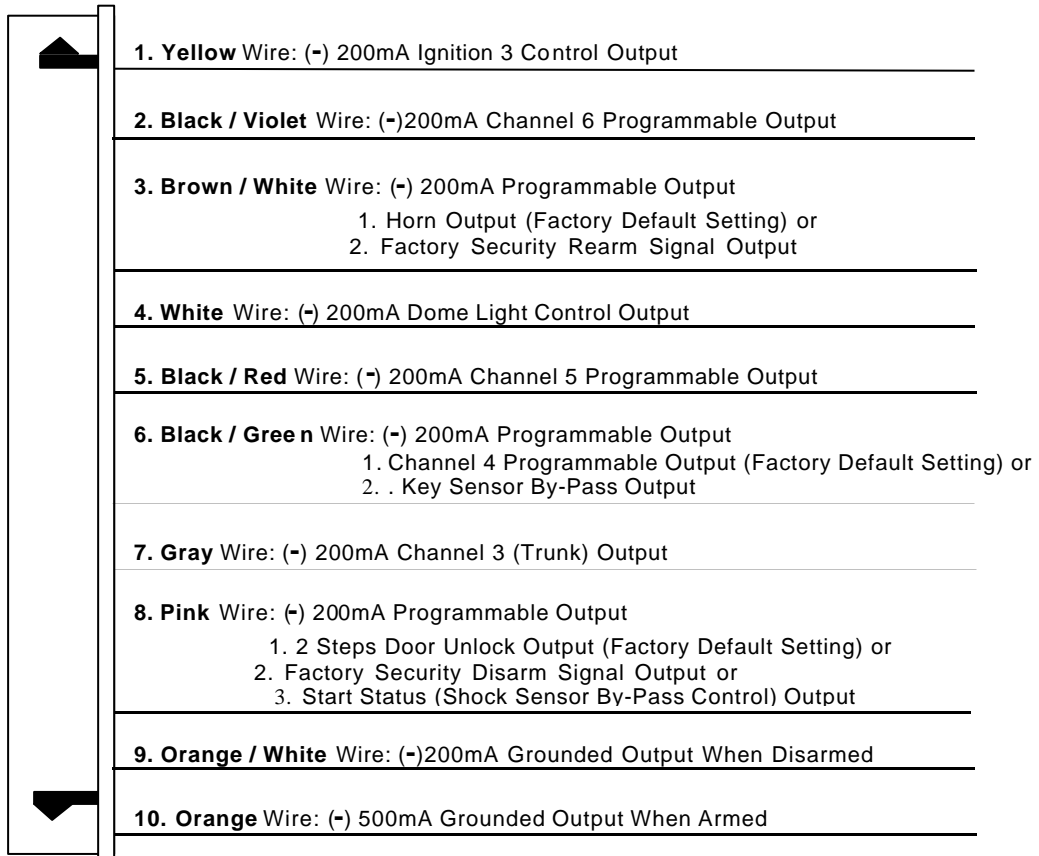

WIRING

Keep wiring away from moving engine parts, exhaust pipes and high-tension cable. Tape wires that pass through holes on the firewall to prevent fraying. Watch out for sharp edges that may damage wires and cause short circuit.

CAUTION: Do not connect the wire harness to the control module until all wiring to vehicle is complete.

H1: 6 PIN HEAVY GAUGE WIRING CONNECTIONS:

Remember that the system does to start a vehicle is duplicate the functions of the ignition key switch! Below, we will explain the three basic functions of the ignition switch. Since this installation will require analysis of the ignition switch functions, we recommend making the three connections below at the ignition switch harness directly.

H1/1 Violet wire – Starter Output –

Careful consideration for the connection of this wire must be made to prevent the vehicle from starting while in gear. Understanding the difference between a mechanical and an electrical Neutral Start Switch will allow you to properly identify the circuit and select the correct installation method. In addition you will realize why the connection of the safety wire is required for all mechanical switch configurations.

Failure to make this connection properly can result in personal injury and property damage.

In all installations it is the responsibility of the installing technician to test the remote start unit and assure that the vehicle can not start via RF control in any gear selection other than park or neutral.

In both mechanical and electrical neutral start switch configurations; the connection of the VIOLET wire will be made to the low current start solenoid wire of the ignition switch harness. This wire has +12 volts when the ignition switch is turned to the "START" (CRANK) position only. This wire has 0 volts in all other ignition switch positions.

NOTE: This wire must be connected to the vehicle side of the starter cut relay (when used). For the electrical neutral switch configuration, this connection must be made between the starter inhibit relay (when used) and the neutral safety switch as shown in the following diagram.

Failure to connect this wire to the ignition switch side of the neutral safety switch can result in personal injury and property damage. SEE NEUTRAL START SAFETY TEST FOR FURTHER DETAILS.

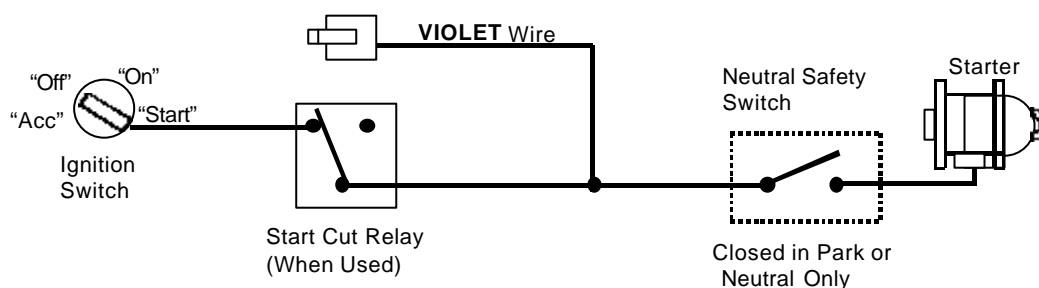

H1/2 & H1/3 Red wire – +12V Power Input –

Remove the two 20A fuses prior to connecting these wires and do not replace them until the satellite has been plugged into the control module. These wires are the source of current for all the circuits the relay satellite will energize. They must be connected to a high current source. Since the factory supplies (+) 12V to the key switch that is used to operate the motor, it is recommended that these wires be connected there.

Note: If the factory supplies two separate (+) 12V feeds to the ignition switch, connect one RED wire of the satellite to each feed at the switch.

H1/4 Yellow wire – Ignition Output –

Connect the YELLOW wire to the ignition wire from the ignition switch. The ignition wire should receive "12 volts" when the ignition key is in the "ON" or "RUN" and "START" or "CRANK" position. When the ignition is turned "OFF", the ignition wire should receive "0" voltage. **The YELLOW wire must be connected.**

H1/5 Pink wire – Ignition 2 Output

Some vehicles have [2] ignition wires that must be power. Connect the PINK wire to the ignition 2 wire from the ignition switch. The ignition wire should receive "12 volts" when the ignition key is in the "ON" or "RUN" and "START" or "CRANK" position. When the ignition is turned "OFF", the ignition wire should receive "0" voltage. If the PINK wire is not used, cap the end of the wire.

H1/6 Brown wire – Accessory Output (Heater /ACC Output) –

Connect the BROWN wire to the accessory wire in the vehicle that powers the climate control system.

An accessory wire will show + 12 volts when the ignition switch is turned to the "ACCESSORY" or "ON" and "RUN" positions, and will show 0 Volts when the key is turned to the "OFF" and "START" or "CRANK" position.

There will often be more than one accessory wire in the ignition harness. The correct accessory wire will

power the vehicle's climate control system. Some vehicle may have separate wires for the blower motor and the air conditioning compressor. In such cases, it will be necessary to add a relay to power the second accessory wire.

H2: 5 PIN WIRE HARNESS:

H2/1 Red / White wire – Parking Light Relay Power Input –

The RED/WHITE wire is the input to the flashing parking light relay. The connection of the RED/WHITE wire will determine the output polarity of the flashing parking light relay.

If the vehicle you are working on has +12volt switched parking light, you don't need connect this wire. This wire already connected to +12 volt.

If the vehicle's parking light are ground switched, cut the RED/WHITE wire, connect the RED/WHITE wire to chassis ground.

H2/2 White wire – Parking Light Relay Output (10A power output) –

Connect the WHITE wire to the parking light wire coming from the headlight switch. Do not connect the WHITE wire to the dashboard lighting dimmer switch. (Damage to the dimmer will result). The limitation of the WHITE wire is 10 AMP max. Do not exceed this limit or damage to the alarm and parking relay will result.

H2/3 Black wire – System Ground –

This is main ground connection of the alarm module. Make this connection to a solid section of the vehicle frame. Do not connect this wire to any existing ground wires supplied by the factory wire loom, make the connection to the vehicle's frame directly.

H2/4 Brown wire – Siren Drive Output – (See Alarm Feature II - 4 Programming)

This is the positive (+) output connection for the siren. Current capacity is 2 amps. Make connection to the (+) red wire from the siren. Make the (-) black wire coming from the siren to a good chassis ground.

H2/5 Red wire – System Power (+12V Constant) –

The RED wire supplies power to the system. Connect this wire to a constant +12 volt source.

H3. BLACK 4-PIN CONNECTOR. – TWO-WAY TRANSCEIVER/ANTENNA MODULE

The Two-way transceiver/antenna mounts on the windshield (Inside). We suggest you mount it on the lower left or upper left-hand side of windshield.

Warning! Do not mount in such a manner that it obstructs the driver's view.

- Remove the protective tape backing.
- Carefully align the two-way transceiver/antenna and apply to windshield.
- Route the black connector wire behind the trim and connect to the two-way transceiver/antenna.
- Connect the other end to the control module.
- Special considerations must be made for windshield glass as some newer vehicles utilize a metallic shielded window glass that will inhibit or restrict RF reception. In these vehicles, route the two ways transceiver/antenna module away from metallic shielded window glass as far as possible.

H4. 3-PIN BROWN CONNECTOR FOR OPTIONAL PAGING (KNOCK) SENSOR

The optional Paging (Knock) Sensor can be add on.

1. Detach the protecting paper from the double-sided adhesive tape and attach one side of the double-sided adhesive tape to the bottom part of the Paging (Knock) Sensor.
2. After cleansing the area around left bottom part of the front window so that it stays attached firmly, the Paging Sensor should be attached on the front window so that the side on which a sticker with a printed words "**Tap Here Paging Driver**" is attached face outward.
3. Hide the wire by carefully pushing it inside the space of the front window's mold trim.
4. Adjust the sensitivity of the Paging Sensor, If you turn the tuning screw at the center of the Paging Sensor clockwise, the sensitivity goes sharp and if turned counter-clockwise, the sensitivity goes dull.

H5: 9 PIN MINI BLACK INPUT WIRE CONNECTORS:

H5/1 White / Black wire – Negative Safety Shut Down Input –

The WHITE/BLACK wire provides an instant shutdown for the remote start, whenever it is grounded. Connect the wire to the hood pin switch previously installed. This wire must be routed through a grommet in the firewall and connected to the hood pin switch. If the pin switch is to be used with an alarm system, connect this wire with diode.

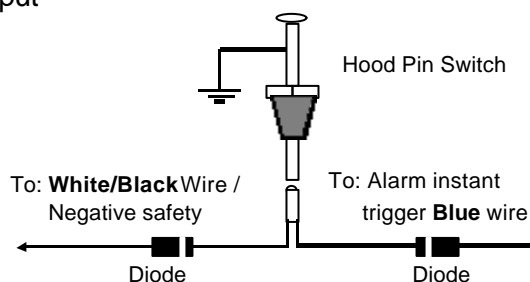

Important! This connection is a safety wire and must be connected as shown and tested as specified. Failure to do so may result in personal injury or property damage. See detail of wiring in the following diagram. This wire may also be used if the vehicle brake light circuit switches ground to the brake lights. An isolation diode must be used for ground switched brake light circuits and must be connected to the output of the brake switch.

H5/2 White / Violet wire – Positive Safety Shut Down Input –

This wire provides an instant shutdown for the remote start, whenever it gets +12volts. If the brake lights switch in the vehicle switches +12 volts to the brake light circuit, connect this wire to the output side of the brake switch. This will allow the remote start to shut down if an attempt is made to operate the vehicle without the key while running under the control of the remote start. In most vehicles, in order to shift gear, the brake pedal must be depressed. The brake input will in turn cause the remote start unit to shut off. See below diagram.

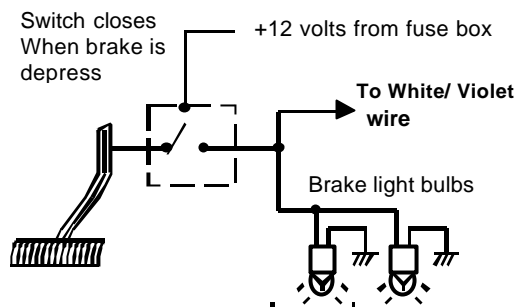

**H5/3 Black/White wire – (-) Remote Start Enable Toggle Switch Input –
– (-) Neutral Safety Switch Input –**

When the BLACK/WHITE wire is grounded, the remote start unit is operable. When this wire is open from ground, the remote start is disable.

1. The optional "remote start toggle switch" can be added on to temporarily disable the Remote Start Device, it can prevent the vehicle from being remote started accidentally. This feature is useful if the vehicle is being serviced or stored in an enclosed area. To disable the remote start, move the optional remote start enable toggle switch to the OFF position. To enable the remote start, move the optional remote start enable toggle switch to the ON position.
2. If needed, This wire can connect to the PARK/NEUTRAL switch in the vehicle. (See the TESTING YOUR INSTALLATION GUIDE)

IMPORTANT NOTE: Directly connect the BLACK/WHITE wire to the "GROUND" when this wire is not used.

H5/4 Blue wire – Ground Instant Trigger Input (Zone 2) –

This wire is the ground trigger input wire for hood/trunk pin switches.

H5/5 White / Green wire – (-) Diesel Wait – To - Start Input –

In diesel vehicles it is necessary to interface with the wire that on the WAIT-TO-START light in the dashboard. This wire illuminates the bulb until the vehicle's glow plugs are properly heated. When the light goes out the vehicle can be started. This wire is always at the connector leading to the bulb in the dashboard. It can also be found at the Engine Control Module (ECM) in many vehicles.

To test and determine the polarity of this wire:

1. Set your multi-meter to DVC or DC voltage (12V or 20V is fine).
2. Attach the (+) probe of the meter to (+) 12V.
3. Probe the wire that you suspect leads to the bulb with the (-) probe of the meter.
4. Turn the ignition switch to the ON position.
5. If the meter indicates 12 volts until the light goes out you have isolated the connect wire and the wire's polarity is negative (ground while the bulb is on).
6. If the meter reads zero volts until the light goes out and then reads 12 volts, you have isolated the connect wire and the wire's polarity is positive.

Connect this wire to the wire in the vehicle that sends the signal to turn on the WAIT-TO-START bulb in the dashboard. In most diesels the wire is negative (ground turns on the bulb) and this wire can be directly connected to the wire in the vehicle. If the vehicles use a positive wire (12V to turn the bulb) a relay must be used to change the polarity.

(-) Wait To Start Wire

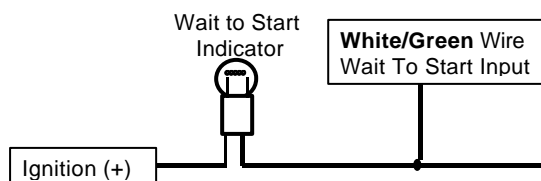

(+) Wait To Start

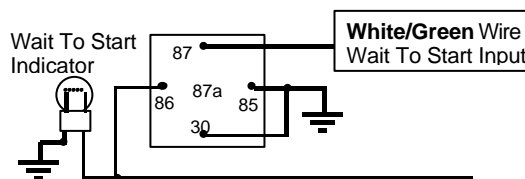

H5/6 Green wire – Negative Door Switch Sensing Input (Zone 3) –

This wire is the ground trigger input wire for negative door pin switch. This wire is connection for "grounding" type factory door pins locate the "common wire" that connects the door pin switches. Make the connection of the GREEN Wire here.

H5/7 Violet wire – Positive Door Switch Sensing Input (Zone 3)–

This wire is the positive trigger input wire for positive door pin switch. This wire is connection for "positive" type factory door pins (typical FORD MOTOR). Locate the "common wire" for all door pins and make the connection of the VIOLET Wire here.

H5/8 White / Blue wire – (-) Instant Start & Turn Off Input –(See Start Feature I - 6 Programming)

This wires activates and turns off the remote starter each time it sees a momentary ground signal. Normally only used for testing during installation or when activating the module from an after-market system.

H5/9 White / Red wire – Tachometer Signal Connection –

Note: You should connect this wire if you program the Start Feature **II – 2** to "Tachometer checking type", otherwise not to connect this wire and tap the end.

Note: No connection of this wire is required, if you use the voltage or timer checking type mode.

This input provides the remote start system with information about the engine's revolutions per minute (RPM). It can be connected to the negative side of the coil in vehicle with conventional coils. In multi-coil and high energy ignition system locating a proper signal may be more difficult. Once connected,

To test for a tachometer wire, a multi-meter capable of test AC voltage must be used. The tachometer wire will show between 1V and 6V AC at idle, and will increase as engine RPM increases. In multi-coil ignition system, the system can learn individual coil wire. Individual coil wires in a multi-coil ignition system will register lower amounts of AC voltage. Also, if necessary, the system can use a fuel injector control wire for engine speed sensing. Common locations for a tachometer wire are the ignition coil itself, the back of the gauges, engine computers, and automatic transmission computers.

IMPORTANT! Do not test tachometer wires with a test light or logic probe. The vehicle will be damaged.

How to find a tachometer wire with your multi-meter

1. Set the ACV or AC voltage (12V or 20V is fine.)
2. Attach the (-) probe of the meter to chassis ground.
3. Start and run the vehicle.
4. Probe the wire you suspect of being the tachometer wire with the red probe of the meter.
5. If this is the correct wire the meter will read between 1V and 6V.

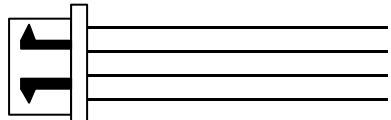
H7. 4 PIN ORANGE CONNECTOR FOR 2 STAGE SHOCK SENSOR (ZONE 1 / 4)

1. **Green Wire / Zone 1** Warn Away Input
2. **Blue Wire / Zone 4** Ground Trigger
3. **Black Wire / Negative**
4. **Red Wire / +12Volts**

H8: 10-PIN MINI WHITE OUTPUT WIRE CONNECTOR:**H8/1 Yellow wire – (-) 200ma Ignition 3 Output –**

This wire provides a 200mA (-) ground output that becomes active 4 seconds before the remote start unit initialize, and remains grounded while running.

Ignition 3 output:

Some newer vehicles use a third ignition wire which is required to start and keep the vehicle's engine running. If this is the case, wire an IGN 3 relay (not supplied) as shown below:

Do not connect any vehicle circuits together, they are isolated for a reason.

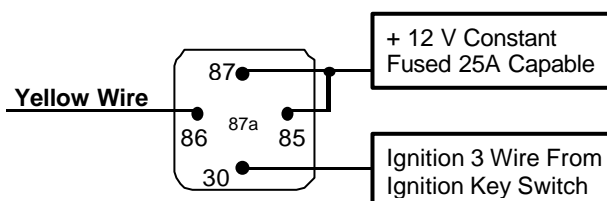
**Transponder interfacing using relay:**

If the vehicle has transponder system installed, you will need to by-pass the system while the vehicle is operating under the control of the Remote Start Unit. To do this:

1. You will need a transponder key that's already programmed to the vehicle.
2. Remove the trim around the ignition switch.
3. Wrap a thin (28 - 30awg) wire tightly around ignition switch 6 to 8 times and secure it.
4. About 6" down line make another loop of approximately 2" diameter.
5. Place the key inside this loop and secure it to the loop.
6. Connect one end of the (28 - 30awg) wire to pin (87) of the relay module.
7. Connect the other end of the loop wire to Pin (30) of relay module.
8. Connect the pin (86) of the relay module to the ignition wire from the ignition switch.
9. connect the pin (85) of the relay module to the **H8/1** yellow wire of 10-pin mini white connector.

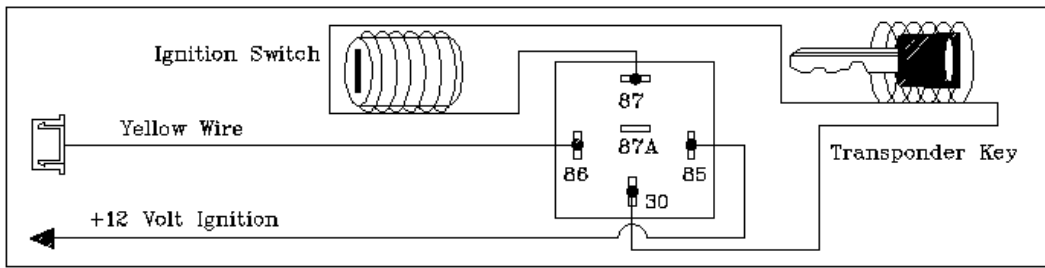

GM VATS KEY OVERRIDE:

If the vehicle has the General Motor VATS system installed, you will need to by-pass the system while the vehicle is operating under the control of the Remote Start Unit. To do this:

1. Measure the resistance of the resistor pellet on the ignition key then select a resistor within 5% of the key's value.
2. Locate the pair of VATS wires in the vehicle, usually a pair of thin gauge wires running from the ignition switch to the VATS control module.
3. Connect the YELLOW wire from Remote Start Unit to TERMINAL #85 of an external relay. Connect terminal #86 of the relay to a fused +12 volt.
4. Cut (#1) wire (as shown), and connect the ignition switch side of the cut wire to terminal #87a of the relay. Connect the other side of the (#1) wire to terminal #30.
5. Connect the previously selcesed resistor from terminal #87 to the second(#2) wire (as shown).

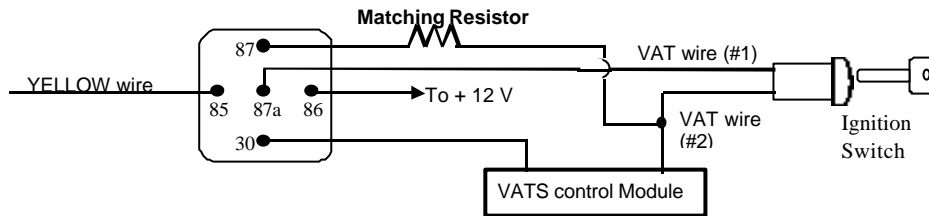

H8/2. Black / Violet wire – (-) 200mA Timer Control Channel 6 Output –

(See Alarm Feature III – 7 Programming) (Factory default setting on momentary grounded)

This wire is built-in user-programmable timer output provides a ground through this wire. Press the transmitter * and button at the same time. You may program the built-in timer to send a ground signal for any time interval between 1 second and 2 minutes. For instance, this timer output may be used to turn on the headlight with the remote control. Also on certain BMW, Mercedes Benz, Jaguar and Volkswagen cars, you can use this unique timed output to allow remote closure of all power window and sunroof without the need for an external module!

H8/3 Brown / White wire – (-) 200ma Programmable Output (See Alarm Feature III – 4 Programming) –

Horn Output – (Factory default setting)

This wire is provided to use the existing vehicle's horn as the alarm system's optional's warning audible device. It's a transistorized low current output, and should only be connected to the low current ground output from the vehicle's horn switch. When the system is triggered, the horn will sound.

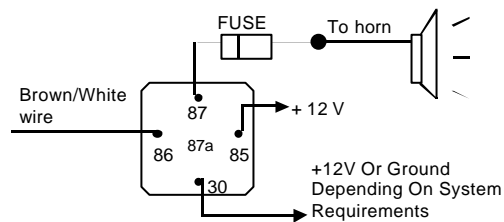

Factory Security Rearm Signal Output –

This output is programmable. If programmed rearm a factory installed security system. This wire will supply a pulse whenever the remote start times out or is shut down using the transmitter and remote door locking..

H8/4 White wire – (-) 200ma Dome Light Control Output –

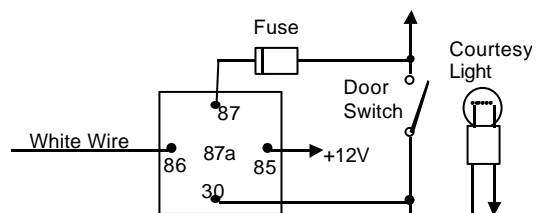

This wire becomes grounded when the dome light controls circuit active. The current capacity of this wire is 200mA. This wire can control the operation of the interior lights. An optional 10 Amps relay can be used to this system for interior lights operation.



- a). Upon disarming, the interior lights will remain on for 30 seconds.
- b). If the vehicle is violated, the interior light will flash for the same duration as the siren.



H8/5. Black / Red wire – (-) 200mA Timer Control Channel 5 Output –

(See Alarm Feature **III – 6** Programming) (Factory default setting on momentary grounded)

This wire is built-in user-programmable timer output provides a ground through this wire. Press the transmitter  and  button at the same time. You may program the built-in timer to send a ground signal for any time interval between 1 second and 2 minutes. For instance, this timer output may be used to turn on the headlight with the remote control. Also on certain BMW, Mercedes Benz, Jaguar and Volkswagen cars, you can use this unique timed output to allow remote closure of all power window and sunroof without the need for an external module!

H8/6 Black / Green wire – (-) 200mA Timer Control Channel 4 / Key Sensor Output –

Channel 4 Output (See Alarm Feature **III – 5** Programming) (Factory default setting on momentary grounded)

This wire is built-in user-programmable timer output provides a ground through this wire. Press the transmitter  and  button at the same time. You may program the built-in timer to send a ground signal for any time interval between 1 second and 2 minutes. For instance, this timer output may be used to turn on the headlight with the remote control. Also on certain BMW, Mercedes Benz, Jaguar and Volkswagen cars, you can use this unique timed output to allow remote closure of all power window and sunroof without the need for an external module!

Key Sensor By-Pass Output –

This output is for a Key sense wire by-pass that some Chrysler and Toyota vehicles need to activated remote start. It wire come on when the start is activated and stay on for 20 seconds.

H8/7 Gray wire – (-) 200ma Channel 3 Output –

This will become a 1 second pulse ground by activate channel 3 on transmitter for two seconds, the current capacity of this wire is 200 mA. This feature allows you to remote control trunk release or other electric device.

H8/8 Pink wire – (-) 200ma Programmable Output (See Alarm Feature **III – 2 Programming) – 2 Steps Unlock Output – (Factory default setting)**

The 2 steps unlock feature will work for the most fully electronic door lock circuit. The vehicle must have an electronic door lock switch (not the lock knob or key switch), which locks and unlocks all of vehicle's doors. When wired for this feature, press the disarm (or unlock) button one time will disarm the alarm and unlock the driver's door only. If, press disarm (or unlock) button two times within 3 seconds, the alarm will disarm and all doors will unlock.

Factory Security Disarm Signal Output –

This wire is designed to disarm a factory installed security system. This wire sends a negative (-) 1 seconds pulse upon a remote start and remote door unlocking. Some factory systems must be disarmed to allow remote starting. In most cases, this wire may be connected directly to the factory alarm disarm wire. The correct wire will show negative ground when the key is used to unlock the doors or trunk. This wire is usually found in the kick panel area in the wiring harness coming into the car body from the door.

Start Status (Shock Sensor By-Pass Control) Output–

This wire is designed to by-pass shock sensor module. This wire will supply an output at all times the remote start is operating plus an additional 3 seconds after the remote start unit turn off.

H8/9 Orange / White wire – 200mA Grounded Output when Disarmed – N.O. Disable –

This wire will become grounded when the alarm is disarmed. The current capacity of this wire is 200mA. It can be connected to optional Ignition disable relay / ECU disable relay / Fuel Pump disable relay.

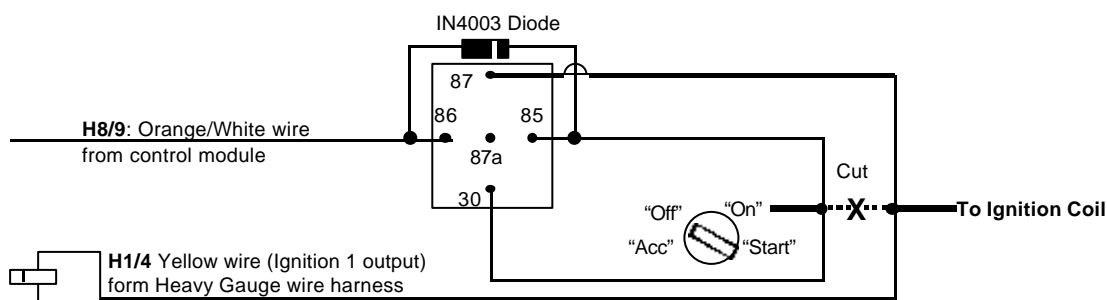

H8/10 Orange wire – (-) 200ma Grounded Output When Armed –

This wire will become grounded when the alarm is armed. The current capacity of this wire is 200mA. This output can control starter disable, when an intrusion is detected and the system is triggered. The vehicles

prevent from any unauthorized starting.

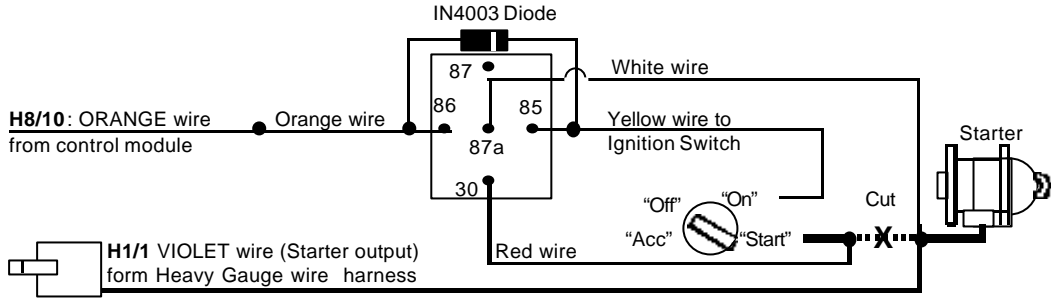

H9. 3 PIN GREEN CONNECTOR FOR OPTIONAL TEMPERATURE SENSOR.

(See Start Feature 1 – 7 Programming.)

The optional Temperature Sensor can be add on. You can monitor, through the LCD screen, the present indoor temperature of the passenger compartment before cooling or heating your vehicle.

It also can be programmed to automatically start the vehicle engine whenever the temperature inside the vehicle reaches or drops below the preprogrammed temperature level. The system will monitor the air temperature every 3 hour and will only start the engine during extreme cold temperatures.

H10. 2 PIN BLUE CONNECTOR FOR THE VALET SWITCH:

Select a mounting location for the switch that is easily accessible to the driver of the vehicle. The switch does not have to be concealed, however, concealing the switch is always recommended, as this provides an even higher level of security to the vehicle. Mount the valet switch in a hidden but accessible location. Route the valet switch wires to the control module.

H11. 2 PIN WHITE CONNECTOR FOR THE LED STATUS INDICATOR:

The led indicator status should be mounted in a highly visible area such as top of the dashboard, on top of the shifter console or on dashboard face. Leave at least 6mm space behind the mounting location for LED housing. Once a suitable location is chosen, drill a 6mm hole. Run the LED wires through the hole then press the 2 pin LED housing into the place. Route the LED wires to the control module.

H6. 3 PIN DOOR LOCK CONNECTOR:

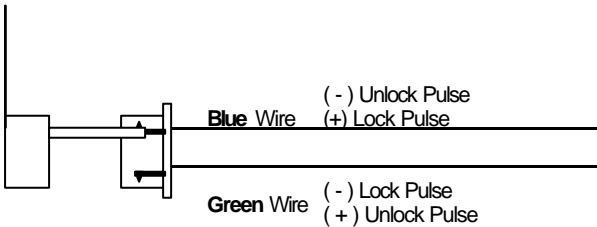

INSTALL NEW DOOR LOCK MOTOR

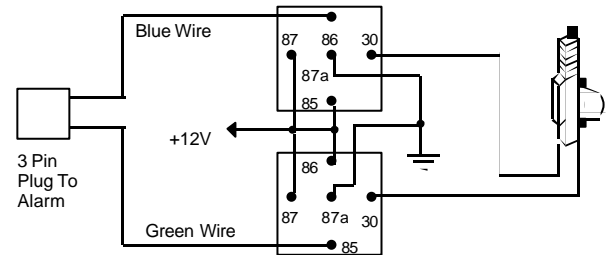

NEGATIVE TRIGGER DOOR LOCK SYSTEM

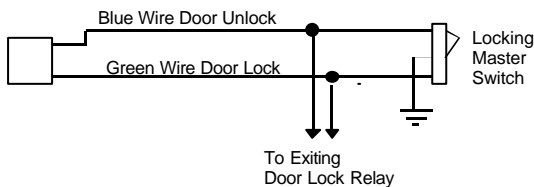

POSITIVE TRIGGER DOOR LOCK SYSTEM

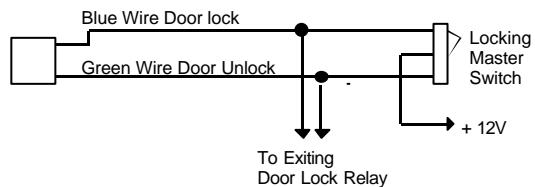

5-WIRE ALTERNATING DOOR LOCK

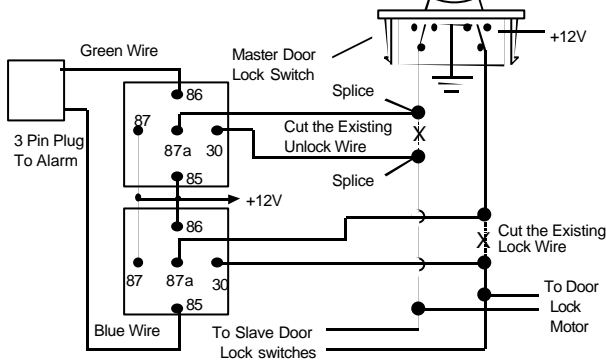

VACUUM OPERATED CENTROL LOCKING

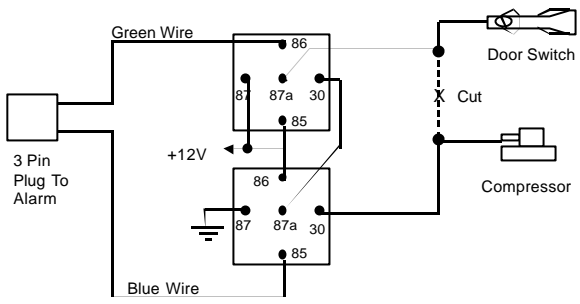

2 STEP DOOR UNLOCK WIRE CONNECTION FOR 5 WIRE ALTERNATING DOOR LOCKS

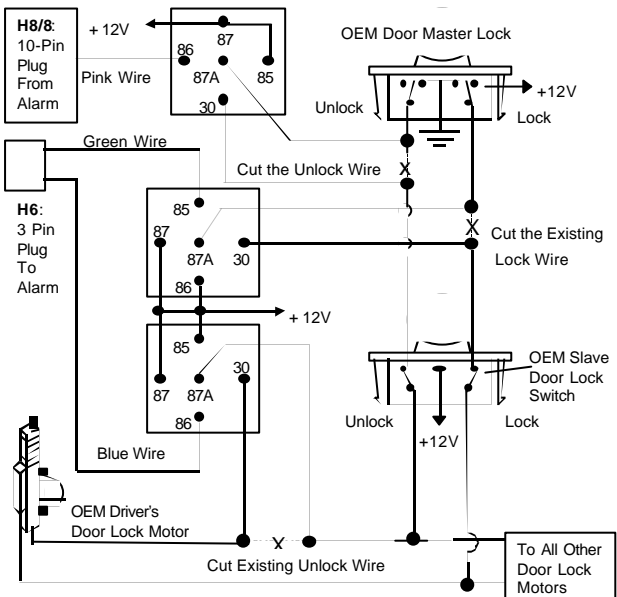

VACUUM OPERATED DOOR LOCKING SYSTEM:

TYPICAL OF MERCEDES BENZ AND AUDI.

Locate the wire under the driver's kick panel. Use the voltmeter connecting to ground, verify that you have the correct wire with the doors unlocked, the voltmeter will receive "12 volts". Lock the doors and the voltmeter will read "0 volt". Move the alligator clip to +12V and the voltmeter will receive "12 volts". Cut this wire and make connections. Be sure to program door lock timer to 3.5 seconds.(See Alarm Feature II – 1 Programming.)

2 STEP DOOR UNLOCK WIRE CONNECTION FOR GROUND SWITCHED DOOR LOCKS

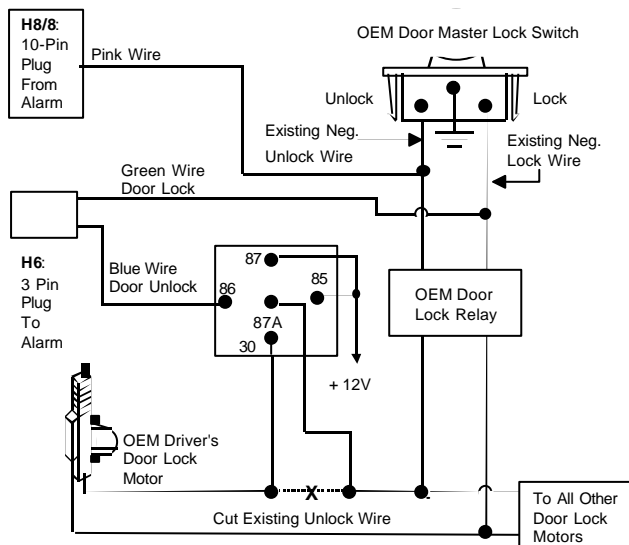

2 STEP DOOR UNLOCK WIRE CONNECTION FOR POSITIVE SWITCHED DOOR LOCKS

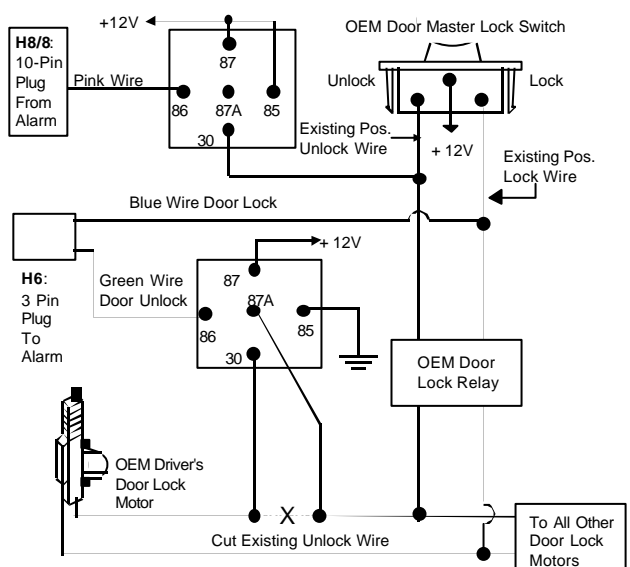

ROGRAMMING

A. PROGRAMMING TRANSMITTER:

PROGRAMMING THE REMOTE TRANSMITTER

Note: This mode will only retain the last 4 remote transmitters programmed. If the transmitter memory is exceeded, the security system will start deleting transmitters from memory in chronological order.

Enter:

1. Turn the Ignition 'switch 'OFF/ON' 3 TIMES and stay in ON position. Within 15 seconds.
2. Push the Valet switch 3 times and hold it until a long chirp is hearing then release the valet switch. You are now in the Transmitter programming mode.

Program:

1. Press button on one of the transmitter until the siren responds with a confirming chirp the first transmitter is now programmed.
2. Press button on the second transmitter until the siren responds with a confirming chirp, the second transmitter is now programmed.
3. Apply the same procedure to program 3rd and 4th



Exit: Turn Ignition to 'OFF' position, or leave it for 15 seconds. A 3 long chirps & 3 parking light flashes to confirm exit.





B. FEATURES PROGRAMMING:







ALARM FEATURE "I" PRORAMMING:

1. Turn the Ignition 'switch 'ON/OFF' 3 TIMES and stay in OFF position.
2. Push the Valet switch 2 times and hold it until **one** chirp with a long chirp is hearing then release the valet switch. You are now in the Alarm feature ' I ' programming mode.
3. Press and release the transmitter button 'A' corresponding to the feature 'A' you want to program.
 - a. The siren chirps and LED pause will indicate previously setting.
 - b. The factory default settings is always [1] LED flash, [1] chirp.
4. Depress the transmitter button 'A' a gain to change the feature. Simple keep re-depressing the transmitter button 'A' again until the module advances to your desired setting.
 - a. In this case, Press button 'A' again, the module would advance to [2] LED flash, [2] chirps.
 - b. Press button 'A' again, t he module would advance to [3] LED flash, [3] chirps etc.
5. Depress the transmitter button 'B' corresponding to the feature 'B' you wants to program.

For example: To program the arming mode form "Active arming" to "Passive Arming without Passive Door Locking", After "Arming mode" program, the next program is "Rearm on/off"

1. Turn the Ignition 'switch 'ON/OFF' 3 TIMES and stay in OFF position.
2. Push the Valet switch 2 times and hold it until a chirp with a long chirp is hearing then release the valet switch.
3. Press and release the transmitter  button corresponding to the feature 'Arming mode' you wants to program. [1] LED flash, [1] chirp to indicate your are in features "Active Arming".
4. Depress the transmitter  button twice to change the feature. [3] LED flash, [3] chirps to indicate your are in features "Passive Arming without Passive Door Locking".
5. Depress the transmitter  button corresponding to the features "Rearm on/off" you want to program... ..

Press Transmitter Button	One Chirp / LED one pulse Factory Default Setting	Two Chirps / LED two pulses	Three Chirps / LED three pulses	Four Chirps / LED four pulses
1 	All chirps on	Siren chirp on only	Horn chirp on only	All chirps off
2 	Active arming	Passive arming without passive door locking	Passive arming with passive door locking.	
3 	Automatic Rearm on	Automatic Rearm off		
4 	3 seconds delay Door Ajar error chirp	30 seconds delay Door Ajar error chirp.		

5  + 	Without this feature	With Dome light turns on after ignition off (45 second door by-pass)		
6  + 	Without Car-jack mode	Active Car-jack mode	Passive Car-jack mode	
7  + 	Panic with Ignition off	Panic with Ignition on & off	Panic with Ignition on & off. Panic with No time limit.	Without Panic function.

Exit: Turn Ignition to 'ON' position, or leave it for 15 seconds. A 3 long chirps & 3 parking light flashes to confirm exit.

3 / 30 seconds Delay Door Ajar Error Chirp:





This feature controls the error chirp that is generated if the system is armed with the door trigger active. This useful in a vehicle that has a long dome light delays after the door has been closed. If the system is armed before the dome light has turned off, the security system will generate the door trigger error chirp. Use this feature to disable the door open error chirp.

With Dome light turns on after ignition off:

Some vehicles turn on the dome light when ignition key is turned off. After remote start, with alarm on, a false alarm may occur when the run time elapses and the dome light comes on. To prevent this from happening, program Alarm Feature I – 5 to “With Dome light turns on after ignition off (45 second door by-pass)”.

ALARM FEATURE “II” PRORAMMING:

- 1 Turn the Ignition switch 'ON/OFF' 3 TIMES and stay in OFF position.
- 2 Push the Valet switch 4 times and hold it until **two** chirps with a long chirp is hearing then release the valet switch. You are now in the Alarm feature 'II' programming mode.
- 3 Press and release the transmitter button 'A' corresponding to the feature 'A' you want to program.

Press Transmitter Button	One Chirp / LED one pulse Factory Default Setting	Two Chirps / LED two pulses	Three Chirps / LED three pulses	Four Chirps / LED four pulses
1 	0.8-second Door lock pulses.	3.5-second Door lock pulse.	Double pulse unlock	
2 	Ignition controlled door locks & unlocks	Ignition controlled door locks only	Ignition controlled door unlocks only	Without ignition controlled door locks & unlocks
3 	Pathway illumination feature “off”	Parking light turns “on” for 30 - second upon an unlock signal	Parking light turns “on” for 30 - second upon an unlock signal & 10-second upon a lock signal.	
4 	H2/5 Brown Wire = Constant Siren output	H2/5 Brown Wire = 5-second pulse Siren output	H2/5 Brown Wire = Random pulse Siren output	H2/5 Brown Wire = Horn Output

Exit: Turn Ignition to 'ON' position, or leave it for 15 seconds. A 3 long chirps & 3 parking light flashes to confirm exit.

ALARM FEATURE “III” PRORAMMING:

- 1 Turn the Ignition 'switch 'ON/OFF' 3 TIMES and stay in OFF position.
- 2 Push the Valet switch 6 times and hold it until **three** chirps with a long chirp is hearing then release the valet switch. You are now in the Alarm feature 'III' programming mode.
- 3 Press and release the transmitter button 'A' corresponding to the feature 'A' you want to program.

Press Transmitter Button	One Chirp / LED one pulse Factory Default Setting	Two Chirps / LED two pulses	Three Chirps / LED three pulses	Four Chirps / LED four pulses
1	Override Without Password Pin Code	Override With Password Pin Code		
2	H8/8 Pink Wire = Two step door unlock output	H8/8 Pink Wire = Factory Security Disarm Signal Output	H8/8 Pink Wire = Start Status Output (Shock Sensor Bypass)	
3				
4 *	H8/3 Brown / White Wire = (-) 200ma Horn Output	H8/3 Brown / White Wire = Factory Security Rearm Signal Output		
5 + *	H8/6 Black / Green Wire Channel 4 Output = Momentary output	H8/6 Black / Green Wire Channel 4 Output = Latched output	H8/6 Black / Green Wire Channel 4 Output = Latched output and reset with ignition "on"	H8/6 Black / Green Wire Channel 4 Output = Timer programming (set to any interval between 1 second and 2 minutes.)
	Five Chirps / LED five pulse	H8/6 Black / Green Wire = Key Sensor By-Pass Output (20second Ground output during the remote start is activated)		
6 + *	H8/5 Black / Red Wire Channel 5 Output = Momentary output	H8/5 Black / Red Wire Channel 5 Output = Latched output	H8/5 Black / Red Wire Channel 5 Output = Latched output and reset with ignition "on"	H8/5 Black / Red Wire Channel 5 Output = Timer programming (set to any interval between 1 second and 2 minutes.)
7 + *	H8/2 Black / Violet Wire Channel 6 Output = Momentary output	H8/2 Black / Violet Wire Channel 6 Output = Latched output	H8/2 Black / Violet Wire Channel 6 Output = Latched output and reset with ignition "on"	H8/2 Black / Violet Wire Channel 6 Output = Timer programming (set to any interval between 1 second and 2 minutes.)

Exit: Turn Ignition to 'ON' position, or leave it for 15 seconds. A 3 long chirps & 3 parking light flashes to confirm exit.

Channel 4 (5 / 6) Timer Control Output Programming.

Enter:

1. Turn the Ignition 'switch 'ON/OFF' 3 TIMES and stay in O FF position.
2. Push the Valet switch 6 times and hold it until **three** chirps with a long chirp is hearing then release the valet switch. You are now in the Alarm feature 'III' programming mode.

Timer Program:

- 1-a. Press and release the transmitter + * button 4 times, [4] LED flash, [4] siren/horn chirp to indicate your are in features "Channel 4 Timer Programming mode".
- 1-b. Press and release the transmitter + * button 4 times, [4] LED flash, [4] siren/horn chirp to indicate your are in features "Channel 5 Timer Programming mode".
- 1-c. Press and release the transmitter + * button 4 times, [4] LED flash, [4] siren/horn chirp to indicate your are in features "Channel 6 Timer Programming mode".

2. Press and hold the valet switch, the timer will immediately start.
3. When the desired interval has passed, release the valet switch. 1 long chirp for confirmation.
(Set to any interval between 1 second and 2 minutes)

Note 1:

If your built-in timer controls window/sunroof closure in your car DO NOT change the timer setting! This requires installer-only programming. Changing the value will adversely effect operation and may cause damage.

Note 2:

Momentary output = The momentary output selection will output a negative signal from the Channel 4 (5/6) output immediately when the channel 4 (5/6) button is pressed and will continue until the button is release.

Latched output = The latched output selection will output a negative signal as soon as the Channel 4 (5/6) button is pressed and will continue until the button is pressed again.

Latched output / reset with ignition = The latched / reset with ignition output selection operates just like the latched output but will reset or stop when the ignition is turned on.

Key Sensor By-Pass Output = The 20 seconds setting is for a Key sense wire by-pass that some Chrysler and Toyota vehicles need to activated remote start. It wire come on when the start is activated and stay on for 20 seconds.

Password Pin Code Setup:

Enter:

1. Turn the Ignition 'switch 'ON/OFF' 3 times and stay in OFF position.
2. Push the Valet switch **6** times and hold it until **three** chirps with a long chirp is hearing then release the valet switch. You are now in the Alarm feature 'III' programming mode. You can program or delete the password pin code as below:

Program:

1. Press and release the transmitter  button twice, [2] LED flash, [2] siren/horn chirp to indicate your are in features "Password Pin Code Programming mode".
2. Within 5 seconds, begin to enter your chosen first 9ths digit by pressing and releasing the valet Switch from 1 – 9 times.
3. Within 15 seconds of the last entered 9ths digit, turn the Ignition switch to "ON" posi tion.
4. Within 15 seconds, enter your chosen second 9ths digit by pressing and releasing the valet Switch from 1 – 9 times.
5. Finish by turning the ignition switch to "OFF" position.

If the new password code was accepted, the unit would report back the newly entered code, by flashing the LED, first indicating the first digit code has been memorized, pause and then the second digit code. The unit will report the new code three times with a one-second's pause between each code.

Note: If 15 seconds of inactivity expire, or if the ignition switch is turned "ON" for more then 5 seconds during of above steps, the unit will revert back to the last successfully stored code. A [3] long chirps to confirm exit. Will revert back to the last successfully stored code

Delete Password Pin Code / Override Without Password Pin Code (Factory default setting):

Within 15 seconds, press and hold the transmitter  button for 3 seconds. A one long chirps to confirm Deleted the Password Pin Code.

Example: To program the Password Code 92, you would;

Enter:

1. Turn the Ignition 'switch 'ON/OFF' 3 times and stay in OFF position.
2. Push the Valet switch **6** times and hold it until **three** chirps with a long chirp is hearing then release the valet switch. You are now in the Alarm feature 'III' programming mode.

Program:

1. Press and release the transmitter  button once, [2] LED flash, [2] siren/horn chirp to indicate your are in features "Password pin code programming mode".
2. Within 5 seconds, press and release the valet Switch 9 times.
3. Within 15 seconds of the last entered 9ths digit, Turn the Ignition Switch to "ON" position.
4. Within 15 seconds press the valet Switch twice.
5. Turn the Ignition Switch to "OFF" position.







You will note the LED flashing nine times, pause and then flash two times, pause. This pattern will be repeated three times indicating the new code (92) has been accepted and stored in memory.

Exit: Press any button (except  button) of the transmitter to exit the password pin set up mode. A 3 long chirps & 3 parking light flashes to confirm exit.

REMOTE START FEATURE PROGRAM MODE.

START FEATURE “I” PRORAMMING:

1. Turn the Ignition 'switch 'ON/OFF' 3 TIMES and stay in OFF position.
2. Push the Valet switch **8** times and hold it until **four** chirps with a long chirp is hearing then release the valet switch. You are now in the Start feature 'I' programming mode.
3. Press and release the transmitter button 'A' corresponding to the feature 'A' you want to program.

Press Transmitter Button	One Chirp / LED one pulse Factory Default Setting	Two Chirps / LED two pulse	Three Chirps / LED three pulse	Four Chirps / LED four pulse
1 	10 minutes run time	20 minutes run time	30 minutes run time	5 minutes run time
2 	Factory alarm disarm with channel 3 on	Without this feature		
3 	Constant parking light output	Flashing parking light output		
4 *	Door lock before start	Door lock after shut-down	Door lock before start and Door lock after shut-down	Without this feature
5  + *	Press * - * button = Activate Remote Start.	Press  + * button = Activate Remote Start.	Press * button = Activate Remote Start.	
6  + *	H5/8 White / Blue Wire = 1 pulse activate	H5/8 White / Blue Wire = 2 pulse activate	H5/8 White / Blue Wire = 3 pulse activate	
7  + *	Temperature-Control Starting OFF	Temperature-Control Starting 5 F	Temperature-Control Starting - 4 F	Temperature-Control Starting - 22 F

Exit: Turn Ignition to 'ON' position, or leave it for 15 seconds. A 3 long chirps & 3 parking light flashes to confirm exit.

SAFE START (Child safety mode)



Factory defaults setting to press the * button twice to start the vehicle.



Programming this feature to eliminate an accidental remote start, when kids enter this transmitter, it requires:

The user press the transmitter  and * buttons at the same time to start the vehicle.

START FEATURE “II” PRORAMMING:

1. Turn the Ignition 'switch 'ON/OFF' 3 TIMES and stay in OFF position.
2. Push the Valet switch **10** times and hold it until **five** chirps with a long chirp is hearing then release the valet switch. You are now in the Start feature 'II' programming mode.
3. Press and release the transmitter button 'A' corresponding to the feature 'A' you want to program.

Press Transmitter Button	One Chirp / LED one pulse Factory Default Setting	Two Chirps / LED two pulse	Three Chirps / LED three pulse	Four Chirps / LED four pulse
1 	Exit the programming mode. (3 long chirp & 3 parking light flashes to confirm this exit.)			
2  + 	Tachometer checking type.	Voltage checking type	Timer checking type	

3 	RPM learning			
	Start Timer: 0.6-second	0.8-second (2 chirps), 1.0-second (3 chirps), 1.2-second (4 chirps), 1.4-second (5 chirps), 1.6-second (6 chirps), 1.8-second (7 chirps), 2.0-second (8 chirps), 3.0-second (9 chirps), 4.0-second (10 chirps),		
4 	Hi check level	Low check level		
5 * - *	Start or Stop the system for TESTING & ADJUSTMENT			
6  + *	"TEST" Mode for Zone 2 / instant trigger & Zone 3 / Door trigger	"TEST" Mode for Zone 1 & Zone 4 (2 Stage Shock Sensor)		



Exit: Press the  button on the transmitter. A 3 long chirps & 3 parking light flashes to confirm exit.

TACHOMETER CHECKING TYPE

Enter Start Feature 'II' Programming Mode:

1. Turn the Ignition 'switch 'ON/OFF' 3 TIMES and stay in OFF position.
2. Push the Valet switch **10** times and hold it until **five** chirps with a long chirp is hearing then release the valet switch. You are now in the Start feature 'II' programming mode.

Select "Checking Type":

3. Press and release the transmitter  and  button at the same time once to set the "Tachometer Checking Type". [1] LED flash, [1] chirp to Confirm this setting.
4. Once you complete step 3, you can program "RPM Learning Mode" as below:



RPM Learning

While the system stay in Start Feature "II" programming mode,

1. Press and release the transmitter  button once, [1] LED flash, [1] chirp to indicate your are in features "RPM Learning mode".
2. Start the vehicle with the key. (While the engine is running, the parking & LED will flash, If don't, please check tachometer White/Red wire connection. **(H5/9)**)
3. Press and hold the valet switch for 2 seconds until a long chirp and the LED light constant for two seconds. The RPM signal is learned.
4. Once you complete step 3, you can adjust and test "Check Level" as below:

CHECK LEVEL PROGRAMMING: (TEST and ADJUST)

While the system stay in Start Feature "II" programming mode,

1. Press the * button twice on the transmitter to start the vehicle.
2. If everything goes well:
 - a. Press the * button twice on the transmitter to stop engine running. You have been completed this programming successfully.
 - b. Press  button on the transmitter to exit the program mode. There will be 3 long chirps & 3 parking light flashes for confirmation.
3. If the crank time is too long, (Engine already successfully running, while still cranks):
 - a. Press the * button twice on the transmitter to stop engine running.
Press  button on the transmitter to set proper "Check Level " to Low position. [2] LED flash, [2] chirps to confirm this setting
 - b. Repeat the step1 – 4.
4. If the crank time is too short, (Engine not running, while stops cranks):
 - a. Press the * button twice on the transmitter to stop engine running.
Press  button on the transmitter to set proper " Check Level " to Hi position. [1] LED flash, [1] chirp to confirm this setting
 - b. Repeat the step1 – 4.



VOLTAGE CHECKING TYPE

Enter Start Feature 'II' Programming Mode:

1. Turn the Ignition 'switch 'ON/OFF' 3 TIMES and stay in OFF position.





2. Push the Valet switch **10** times and hold it until **five** chirps with a long chirp is hearing then release the valet switch. You are now in the Start feature 'II' programming mode.

Select "Checking Type":

3. Press the transmitter  and  button at the same time to set the "Voltage Checking Type". [2] LED flash, [2] chirp to confirm this setting
4. Once you complete step 3, you can adjust and test "Start Timer" as below:

START TIMER PROGRAMMING: (TEST and ADJUST)

While the system stay in Start Feature "II" programming mode,



1. Press the * button twice on the transmitter to start the vehicle.
2. If everything goes well:
 - Wait for 15 seconds:
 - If the engine still running.
 - Press the * button twice on the transmitter to stop engine running. You have been completed this programming successfully.
 - Press  button on the transmitter to exit the program mode. There will be 3 long chirps & 3 parking light flashes for confirmation.
 - If the engine shut down after the vehicle has been started.
 - Press the * button twice on the transmitter to stop engine running.
 - Press  button on the transmitter to set "Check Level" to LOW position. [2] LED flash, [2] chirp to confirm this setting
 - Repeat the step1 – 2.
3. If the crank time is too long, (Engine already successfully running, while still cranks):
 - Press the * button twice on the transmitter to stop engine running.
 - Press  button on the transmitter to set proper "Start Timer". The chirp & LED pause will confirm this enter. (Decrease "Start Timer" is necessary.)
 - Repeat the step1 – 4.
4. If the crank time is too short, (Engine not running, while stops cranks):
 - Press the * button twice on the transmitter to stop engine running.
 - Press  button on the transmitter to set proper "Start Timer". The chirp & LED pause will confirm this enter. (Increase "Start Timer" is necessary.)
 - Repeat the step1 – 4.

Timer Checking Type

Enter Start Feature 'II' Programming Mode:



1. Turn the Ignition 'switch 'ON/OFF' 3 TIMES and stay in OFF position.
2. Push the Valet switch **10** times and hold it until **five** chirps with a long chirp is hearing then release the valet switch. You are now in the Start feature 'II' programming mode.

Select "Checking Type":

3. Press the transmitter  and  button at the same time to set the "Timer Checking Type". [3] LED flash, [3] chirp to confirm this setting
4. Once you complete step 3, you can adjust and test "Start Timer" as below:

START TIMER PROGRAMMING: (TEST and ADJUST)

While the system stay in Start Feature "II" programming mode,

1. Press the * button twice on the transmitter to start the vehicle.
2. If everything goes well:
 - Press the * button twice on the transmitter to stop engine running. You have been completed this programming successfully.
 - Press  button on the transmitter to exit the program mode. There will be 3 long chirps & 3 parking light flashes for confirmation.
3. If the crank time is too long, (Engine already successfully running, while still cranks):
 - Press the * button twice on the transmitter to stop engine running.
 - Press the  button on the transmitter to set proper "Start Timer". The chirp & LED pause will confirm this enter. (Decrease "Start Timer" is necessary.)
 - Repeat the step1 – 4.
4. If the crank time is too short, (Engine not running, while stops cranks):

- a. Press the * button twice on the transmitter to stop engine running.
- b. Press  button on the transmitter to set proper "Start Timer". The chirp & LED pause will confirm this enter. (Increase "Start Timer" is necessary.)
- c. Repeat the step 1 – 4.

TEST MODE

In this test mode, this system can test the Zone 2 (Instant ground trigger), the Zone 3 (Door trigger), and the Zone 1 & Zone 4 (2 stage shock sensor) sensitivity. The installer can save time to test the 2 stage shock sensor sensitivity and sensor without using the traditional arming/disarming procedures to test the sensors.

Enter:

- 1. Turn the Ignition 'switch 'ON/OFF' 3 TIMES and stay in OFF position.
- 2. Push the Valet switch **10** times and hold it until **five** chirps with a long chirp is hearing then release the valet switch. You are now in the Start feature ' II' programming mode.

a. Test the Zone 2 / Instant Ground Trigger & Zone 3 / Door Trigger:

Press and release the transmitter  and * button at the same time once. [1] LED flash, [1] siren/horn chirp to indicate your are in Zone 2 / instant ground trigger and Zone 3 / Door trigger test mode.



Trigger sensor	Siren chirps
Zone 2 / Instant Ground trigger (H5/4 Blue wire)	2
Zone 3 / Door trigger (H5/6 Green or H5/7 Violet wire)	3

b. Test the Zone 1 & Zone 4 / Two Stage Shock Sensor (Connected to H7 4 Pin Plug):

Press and release the transmitter  and * button at the same time again. [2] LED flash, [2] siren/horn chirps to indicate your are in the shock sensor (connected to H7 4 pin plug) test mode.

- 1. Activate the warn-away (first stage of the shock sensor / Zone 1), system will emit a short chirp.
- 2. Activate the full alarm (second stage of the shock sensor / Zone 4), system will emit a long chirp.
- 3. Continue to test the shock sensor until reach the proper sensitivity.

RETURN TO FACTORY DEFAULT SETTING:

- 1. Turn the ignition ON then OFF 3 TIMES and stay in OFF position.
- 2. Push the Valet switch **12** times and hold it until **six** chirp with a long chirp is hearing then release the valet switch. You are now in the "Return To Factory Default Setting" programming mode.
- 3. Press and hold the  and  button at the same time on the transmitter for 6 seconds, there will be a confirmation six chirp with 3 long chirp & 3 parking light flashes to confirm the system "Alarm Feature I & II & III Programming" all returns to factory default setting then exit.

Exit: Turn Ignition to 'ON' position, or leave it for 15 seconds. A 3 long chirps & 3 parking light flashes to confirm exit.

SHUTDOWN DIAGNOSTICS

The unit has the ability to report the cause of the last shutdown of the remote start system.

Enter:

- 1. Turn the Ignition switch to 'ON position.
- 2. Press the  button on the transmitter.
- 3. The LED will now report the last system shutdown by flashing for one minute in the following grouped patterns:

LED Flashes	Shutdown Mode	
1	(-) Safety Shutdown input (Hood)	1. Close the hood. 2. Check H5/1 White/ Black wire connection.

2	(+) Safety Shutdown input (Brake) or Neutral Safety Switch input fail.	1. Check H5/2 White/ Violet wire connection. 2. Move the Enable Toggle Switch to "ON" position. (If installed.) 3. Move the gear selector to "Park"/ "NEUTRAL" position. 4. Check H5/3 Black/White wire connection.
3	No RPM or Low Voltage.	Tachometer Checking Type: Check H5/9 White/Red wire connection Voltage Checking Type: Program the "CHECK LEVEL" from "Hi Check Level" to "Low Check Level"
5	Over-rev	
6	System timed out	
7	Transmitter	
8	Tach. Signal has not been learned	Re-learning the RPM (Start Feature II – 2 / 3)
9	The procedure of the Engine start memorizing for the vehicle with standard (manual) transmission gear is not completed.	Check Operation Manual # Remote Start Operation B section.

TESTING YOUR INSTALLATION:

Caution!! The follow procedure must be performed after the installation of the Remote Start Device. It is the responsibility of the installing technician to complete these tests. Failure to test the unit in the following manner may result in personal injury, property damage, or both.

1. Test the BRAKE shutdown circuit: With the vehicle in park (P), start the vehicle using the remote transmitter, Once the engine is running, press the brake pedal. The vehicle should shut down immediately. If the vehicle continues to run, check the brake circuit WHITE/ VIOLET wire (**H5/2**) connection.
2. Test the HOOD PIN shutdown circuit: Start the vehicle using the remote transmitter, Once the engine is running, pull the hood release and raise the hood. The vehicle should shut down immediately. If the vehicle continues to run, check the hood pin WHITE/ BLACK wire (**H5/1**) connection.

3. NEUTRAL START SAFETY TEST:

1. Set the vehicle parking brake.
2. Block the drive wheels to prevent vehicle movement.
3. Sitting in the vehicle, turn the ignition switch to "ON" or "RUN" position. But do not start the engine.
4. Step on the brake pedal and shift the gear selector into "DRIVE" (D).
5. Put your foot over the brake pedal but do not press down on it. Be ready to step on the brake to shut down the Remote Start Device.
6. Start the vehicle using remote transmitter.
 - a. If the starter does not engage, the test is complete.
 - b. If the starter engages, immediately step on the brake pedal to shut down the system, recheck your VIOLET wire (**H11/1** starter output wire) connection. The heavy gauge VIOLET wire must be connected to the ignition switch side of the Neutral Start Switch. If the vehicle you are working on does not have an Electrical Neutral Safety Switch, it will be necessary to reconfigure the Remote Starts Wiring to accommodate this vehicle. The information concerning the Mechanical Neutral Safety Switch provided below will help you to determine if the vehicle you are working on has this type of safety switch and will provide alternate wiring methods to accommodate this situation.

MECHANICAL NEUTRAL SAFETY SWITCH CONSIDERATIONS:

Mechanical neutral safety switch configurations differ slightly in that they do not offer the same level of safety when installing a remote start device. Often when the ignition switch is turned off while the gear selector is in any position other than park or neutral, the mechanical function will not allow the key to be turned to the start position or be removed from the ignition cylinder. This configuration prevents mechanical operation while the vehicle is in gear but offers no consideration for electrical operation. Because of this potential problem, this installation requires the additional connection of a safety wire from the remote start device to the vehicle PARK/NEUTRAL ECM input or the vehicle key in sensor. This connection will prevent remote start operation if the key is left in the ignition switch regardless of the gear selector position.

PARK/NEUTRAL ECM INPUT:

The Park/Neutral ECM input is the preferred method of installation. This not only maintains the integrity of the factory circuit, it is also the easiest to install, providing the vehicle you are working on has this ECM input.

The installation required for this application (shown below), indicates in the slight reconfiguration of the control switch wiring. Shown is a typical GM Park/Neutral ECM input circuit. To connect the Remote Start unit to the GM Park/Neutral ECM input:

1. Locate the Orange/Black reference wire in the "C2" connector found at the ECM in GM B Body vehicles or, locate the equivalent reference wire in the vehicle you are installing the Remote Start Unit in.
2. Connect the BLACK/WHITE Neutral Safety Switch wire (**H5/3**) to this reference wire.

NOTE: If the optional remote starts enable toggle switch is installed, connect the one side the enable switch to this reference wire and connect the other side of the enable switch to the BLACK/WHITE Neutral Safety Switch wire (**H5/3**) of the Remote Start unit.

The reference diagram below shows a typical GM B Body ECM reference wire and how it is to be connected to the Remote Start Unit.

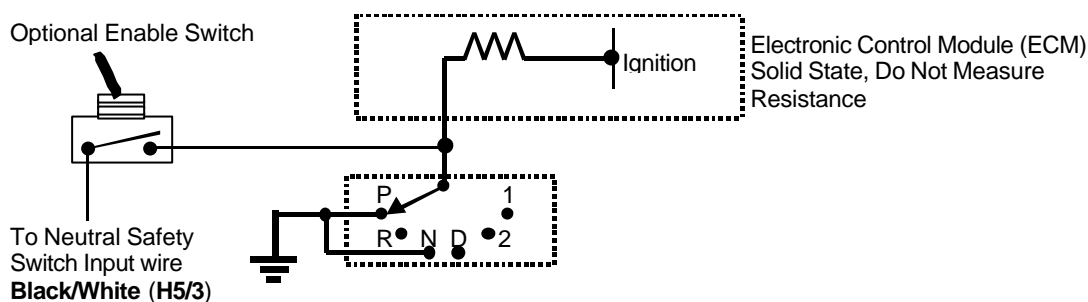

KEY IN SENSOR CIRCUITS:

If the vehicle you are working on does not have or you cannot locate the ECM reference wire, there are two alternatives available. Although not preferred, the vehicle Key In Sensor may be reconfigured to allow a margin of safety and will prevent the vehicle with a Mechanical Neutral Start Switch from starting in gear.

WE ADVISES THAT YOU MAINTAIN THE FACTORY CIRCUIT WHENEVER POSSIBLE. The following two circuits may be used only if the above circuit is not available.

NOTE: When completing an installation using either of the following key in sensor circuits, if the operator inserts the ignition key while the vehicle is running under the control of the Remote Start, the vehicle will shut down. This must be explained to the operator as it is in contrast to the normal operation of a vehicle utilizing an electrical neutral start switch and is inconsistent with the operators manual.

Additional information concerning Key in Sensor methods 1&2 are listed below and should be reviewed before considering either alternative.

Method 1 will allow the safety required for the remote start unit and prevent the vehicle from starting while in any gear other than Park or Neutral while the key is in the ignition cylinder however, if the key is left in the ignition switch and the door is left opened, the added relay will be energized causing a 150mA drain on the battery.

Method 2 will allow the safety required for the remote start unit and prevent the vehicle from starting while in any gear other than Park or Neutral while the key is in the ignition cylinder however, the original factory key in chime module will not alert the owner that the key has been left in the ignition switch. In addition, this may also effect other warning tones such as the light on reminder.

These situations should be carefully considered before altering the vehicle's wiring and must be fully explained to the consumer.

METHOD 1

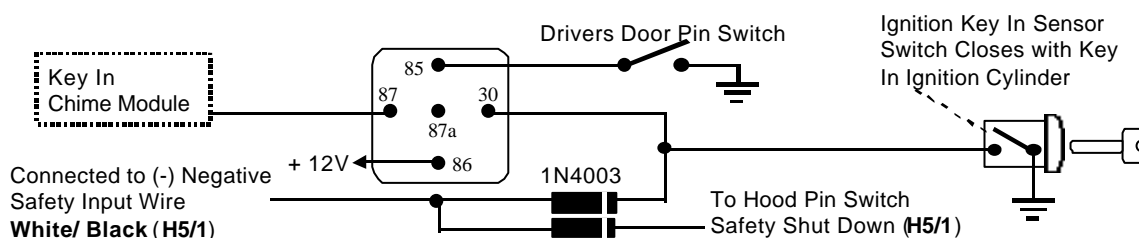

To connect to the key in sensor as shown in method 1:

- A. Locate the control wire that connects the drivers door pin switch to the key in sensor switch.
- B. Cut this wire and connect the ignition cylinder side to chassis ground.
- C. Locate the key in sensor switch wire that connects the chime module to the ignition cylinder.

- D. Cut this wire and connect the ignition cylinder side to terminal 30 of a P&B VF45F11 or equivalent relay.
 - E. Connect the cathode (striped) side of a 4003 series diode to this same wire, and connect the (non striped) side to the negative safety input wire (WHITE/ BLACK) (H5/1) of the Remote Start Unit.
 - F. Connect terminal 86 of the relay to a fused + 12 volt constant battery source.
 - G. Connect terminal 87 of the relay to the Chime Module side of the previously cut wire in step D.
 - H. Connect terminal 85 of the relay to the Drivers Door side of the pin switch wire previously cut in step B.
- Note:** A second 4003 series diode may be required to maintain the integrity of the hood open, shut down circuit. If this is the case, it must be installed as shown in the diagram above. The anode (Non Stripped) side must be connected to the WHITE/ BLACK wire (H5/1) of the Remote Start Unit. The cathode (Striped) side must be connected to the hood pin switch. If the hood pin switch is also used for an alarm trigger input, be certain to use the dual diode assembly packaged with the Remote Start Unit as shown in this installation guide.

METHOD 2

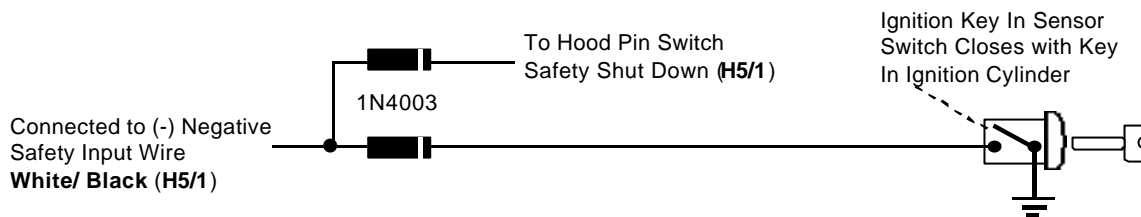

To connect to the key in sensor circuit as shown for method 2:

- A. Locate the control wire that connects the drivers door pin switch to the key in sensor switch.
- B. Cut this wire and connect the ignition cylinder side to chassis ground.
- C. Locate the key in sensor switch wire that connects the chime module to the ignition cylinder.
- D. Cut this wire and connect the ignition cylinder side to the Remote Start Negative Safety Shut down wire WHITE/ BLACK (H5/1), using a 4003 series diode as shown above.

Note: A second 4003 series diode may be required to maintain the integrity of the hood open, shut down circuit. If this is the case, it must be installed as shown in the diagram above. The anode (Non Stripped) side must be connected to the WHITE/ BLACK wire (H5/1) of the Remote Start Unit. The cathode (Striped) side must be connected to the hood pin switch. If the hood pin switch is also used for an alarm trigger input, be certain to use the dual diode assembly packaged with the Remote Start Unit as shown in this installation guide. AFTER THE CONNECTION OF THE NEUTRAL START SAFETY WIRE AS INDICATED IN ANY OF THE PREVIOUS ALTERNATE CONFIGURATIONS, THIS CIRCUIT MUST BE TESTED FOR OPERATION. Retest by following the steps outlined in the NEUTRAL START SAFETY TEST shown in this manual.

This device complies with part 15 of the FCC rules. Operation is subject to the following two conditions:

- (1) This device may not cause harmful interference
- (2) This device must accept any interference received: including interference that may cause undesired operation.

Note: The manufacturer is not responsible for any radio TV interference caused by unauthorized modification to this equipment. Such modifications could void the user's authority to operate the equipment.