

**MODEL SRT-9000  
REMOTE ENGINE STARTER  
WITH ALARM SYSTEM  
OWNER'S MANUAL**

## OLED REMOTE TRANSCEIVER

<b>A. OLED DISPLAY</b> .....	<b>4</b>
Reset the Remote Transceiver	
<b>B. CHARGE THE BATTERY</b> .....	<b>4</b>
<b>C. MAIN PAGE</b> .....	<b>5</b>
<b>D. SELECT THE TRANSCEIVER'S BUTTON CONFIGURATION</b> .....	<b>6</b>
<b>E. SELECT THE TRANSCEIVER FEATURES</b> .....	<b>6</b>
P1-1: Enable / Disable Bi Sound While Pressing Button (7)	
P1-2: Button Lock Setting (7)	
P1-3: Melody / Vibration Mode (7)	
P1-4: Demo Mode (8)	
P2-1: Power Save Mode (8)	
P2-2: Parking Meter Setting (8)	
P2-3: Parking Area Setting (8)	
P2-4: "Light For OLED" Timer Setting (9)	
P3-1: Timer Setting (9)	
P3-2: Alert Alarm Timer Setting (9)	
P3-3: Count Down Timer Setting (10)	
P3-4: Daily Start Timer Setting (10)	
P4-1: Name of Transceiver Setting (11)	
P5-1: Name of Channel Setting (11)	
P6-1: Language Setting (11)	
P6-4: Set To Defaults (12)	

## TABLE OF CONTENTS

<b>A. REMOTE TRANSMITTER OPERATION</b> .....	<b>12</b>
<b>B. LED DISPLAY</b> .....	<b>12</b>
<b>C. CHIRP INDICATOR</b> .....	<b>12</b>
<b>D. PARKING LIGHT</b> .....	<b>12</b>
<b>E. ACTIVE ARMING – ARM &amp; LOCK</b> .....	<b>13</b>
Ajar Warning	
Silent Arming	
Sensor By-Pass	
Hidden Alarm Mode	
<b>F. PASSIVE ARMING</b> .....	<b>13</b>
Passive Arming with Passive Door Locking	
Passive Arming By-Pass	
<b>G. ACTIVE DISARMING – UNLOCK &amp; DISARM</b> .....	<b>13</b>
Silent Disarming	
Tamper Disarming	
Pathway Illumination	
Two Steps Door Unlock	
Automatic Re-Arm	
<b>H. DISARMING WITHOUT A TRANSMITTER</b> .....	<b>14</b>
Overrides the Alarm without Password Pin Code	
Overrides the Alarm With Password Pin Code	
<b>I. VALET MODE</b> .....	<b>14</b>
<b>J. CAR LOCATOR</b> .....	<b>15</b>
<b>K. PANIC FUNCTION</b> .....	<b>15</b>
<b>L. TRIGGER THE SYSTEM</b> .....	<b>15</b>
Stop The Melody Sound	
Noise Abatement Circuit	
<b>M. ANTI CAR- JACKING</b> .....	<b>16</b>
<b>N. SYSTEM'S TRIGGER CHECK</b> .....	<b>16</b>
<b>O. SYSTEM'S STATUS CHECK</b> .....	<b>16</b>
<b>P. DRIVER PAGING / LOSE AND FOUND</b> .....	<b>16</b>
<b>Q. DOME LIGHT CONVENIENCE DELAY &amp; SUPERVISION</b> .....	<b>17</b>
<b>R. IGNITION CONTROL THE DOOR LOCK/UNLOCK.</b> .....	<b>17</b>
<b>S. TRUNK RELEASE (CHANNEL 3) OUTPUT</b> .....	<b>17</b>
<b>T. AUX1/2/3/4 TIMER CONTROL OUTPUT</b> .....	<b>17</b>
<b>U. MULTI-VEHICLE SECURITY OPREATION</b> .....	<b>17</b>
<b>V. POWER ON MEMONRY</b> .....	<b>18</b>

## REMOTE START OPERATION

A. TO REMOTE START THE VEHICLE .....	18
B. TO OPERATE THE VEHICLE WHILE RUNNING ON THE REMOTE START .....	18
C. TEMPORARY STOP FEATURE .....	18
D. TURBO TIMER MODE .....	18
E. TIMER START .....	19
3 (2 or 1) Hours Timer Start	
Daily Timer Start	
Cancel the Timer Start	
F. TEMPERATURE CHECK .....	19
G. TO TURN OFF THE REMOTE START .....	19
H. SHUT-DOWN INPUT FOR REMOTE STARTER .....	19
I. DISABLING THE REMOTE START SYSTEM .....	20
TEST MODE .....	20
SHUTDOWN DIAGNOSTICS .....	20

### WARNINGS:

As with any product that performs automatic functions, there are certain safety precautions that you must practice and be aware of.

1. Keep the transmitter out of children's reach.
2. Do not leave anyone in the vehicle while running on remote control.
3. Alert servicing personnel that the vehicle can be started automatically.
4. Do not start the vehicle by remote while it's in an enclosed area or garage.
5. Always apply the parking brake and lock the vehicle as you exit the vehicle.
6. The vehicle windows must be rolled up.
7. Should the unit malfunction, disconnect the fuse until the problem is corrected.
8. The use and operations of this system is the sole responsibility of the operator.
9. Some areas may have local ordinances that prohibit leaving a vehicle running on public streets.
10. Do not start the vehicle by remote while the standard transmission vehicle is parked at a steep place.

# REMOTE TRANSCIVER (TX)

## A. OLED DISPLAY

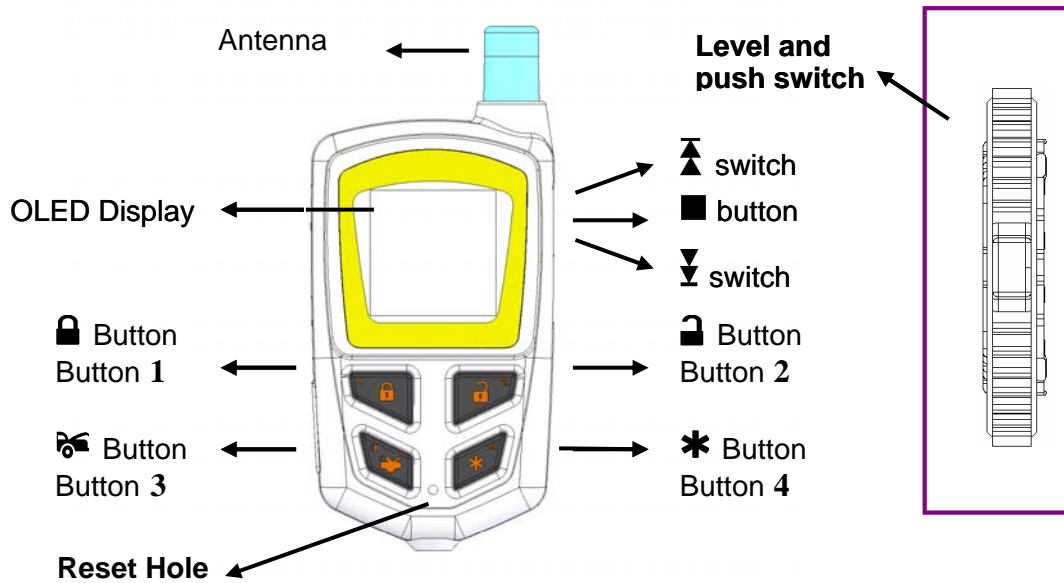
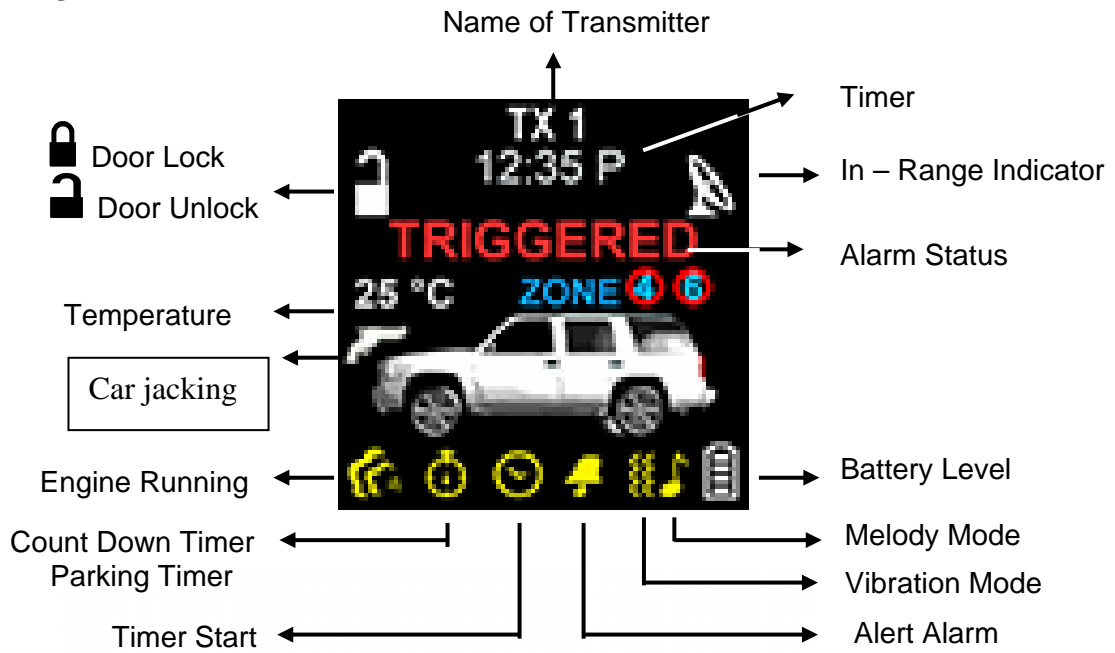

Power by built-in 3.7V lithium polymer battery, if the OLED screen display low battery or  is flash, charge your remote transceiver. While the battery of the Remote Transceiver is under the battery charging, you can push the "■" button to check charging condition.

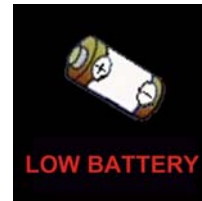

**Optional AC Power Supply**

If you have optional AC POWER SUPPLY / AC ADAPTOR (Output Voltage: 4.2VDC – 5.5VDC and with same USB plug), then you can charge the battery indoors.

**Charge Input  
USB Input**

While the battery of the Remote Transceiver is under charging.

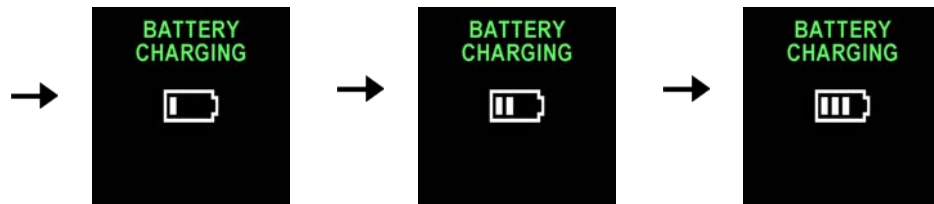

Push the "■" button; the screen will display Battery charging.

**C. MAIN PAGE:**

1. Press the "■" button, the screen will display main page.



2. While the icon flashing on the OLED screen, press the "■" button, the OLED screen will display the detail of the flash icon, the display sequence of flash icon as follows: TRIGGERED / ENGINE RUNNING / COUNT DOWN TIMER / TIMER START / ALART TIMER condition.



While the TRIGGERED icon flash.

Push the "■" button to display triggered area.



While the  icon flash



Push the "■" button



While the icon flash

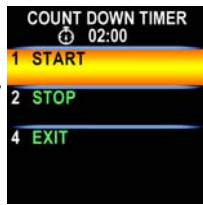

Push the button, the count down timer will display.



Press the button 2 to set off the count down time



While the icon flash



or



or



Push the button, the OLED screen will display individually i.e. daily start timer, timer start or temperature start, depend on which you selected.

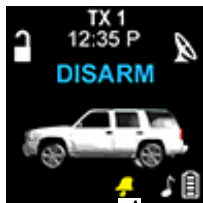

While the icon flash



Push the button, the alert alarm time will display.



Press the button 2 to set off the alert alarm timer

#### D. SELECT THE TRANSCIEVER'S BUTTON CONFIGURATION:

- Spin up the Switch to select the transceiver button configuration you need and the OLED screen will display the transceiver button configuration you select.
  - Within 5 seconds press the button 1, 2, 3 or 4 to remote control "button configuration" you selected.
- Note: If 5 seconds of inactivity expired, or push the button, the transceiver button configuration mode will exit.



Spin up the switch  
To the page 1



Spin up the switch  
to the page 2

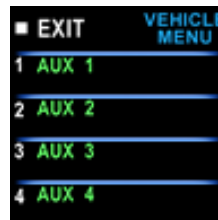

Spin up the switch  
To the page 3

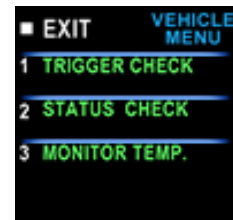

Spin up the switch  
to the page 4

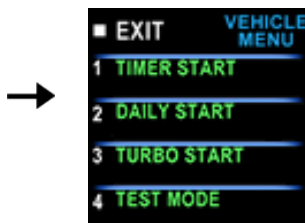

Spin up the switch  
to the page 5

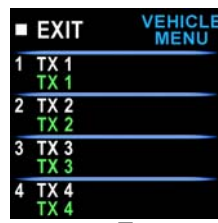

Spin up the switch  
to the page 6

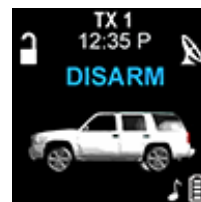

Spin up the switch  
resume to main page.

#### E. SELECT THE TRANSCIEVER FEATURES:

- Spin down the Switch to select the transceiver feature you need and the OLED screen will display the features you select.
  - Press the button 1, 2, 3 or 4 once within 3 seconds after finished selection and the OLED screen will change the display alternatively.
- Note: If 5 seconds of inactivity expire, or push the button, the transceiver features program mode will exit.



Spin down the  switch to the page 1



Spin down the  switch to the page 2



Spin down the  switch to the page 3

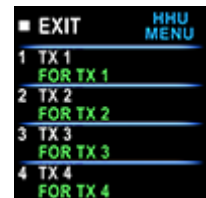

Spin down the  switch to the page 4

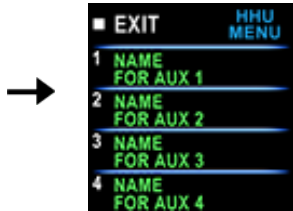

Spin down the  switch to the page 5



Spin down the  switch to the page 6



Spin down the  switch resume to main page.

**E- P1- 1. "BUTTON BEEP" SETTING:** Example: Set the "Button Beep Disable". It has a short "bi" sound while pressing the button of the remote transceiver



Spin down the  switch to the page 1



Press the button 1 and it will display previously setting



Press the button 2 to change the setting

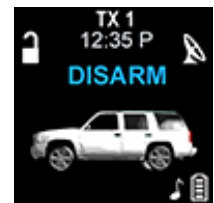

Press the  button and the setting is done.

**E- P1- 2. "BUTTON LOCK" SETTING:** Example: Set the "Button Lock Enable".



Spin down the  switch to the page 1



Press the button 2 and it will display previously setting

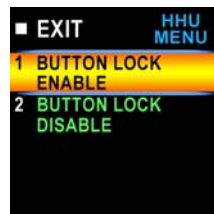

Press the button 1 to change the setting

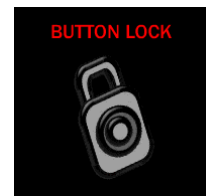

Press the  button and the setting is done.

**D- P1- 3. "MELODY / VIBRATION MODE" SETTING:** Example: set the Vibration mode.



Spin down the  switch to the page 1

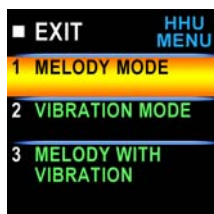

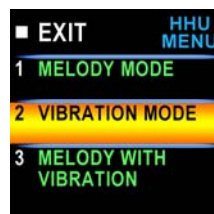

Press the button 3 and it will display previously setting

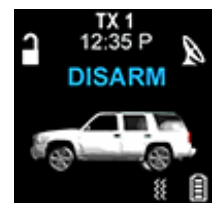

Press the button 2 to change the setting



Press the  button and the setting is done also the  icon will display on the OLED screen

**E- P1- 4. "DEMO MODE":**

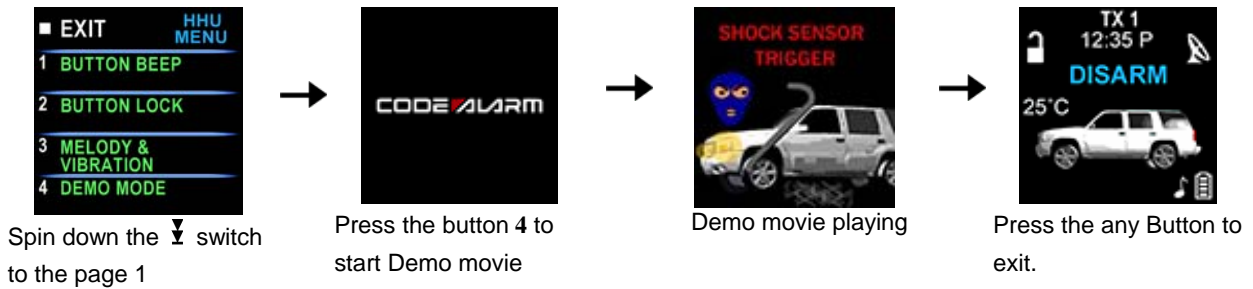

**E- P2- 1. "POWER SAVE" SETTING:** Example set the "Power Save Enable".

While the power save mode, the LCD remote transceiver uses "0" current to save the battery power.

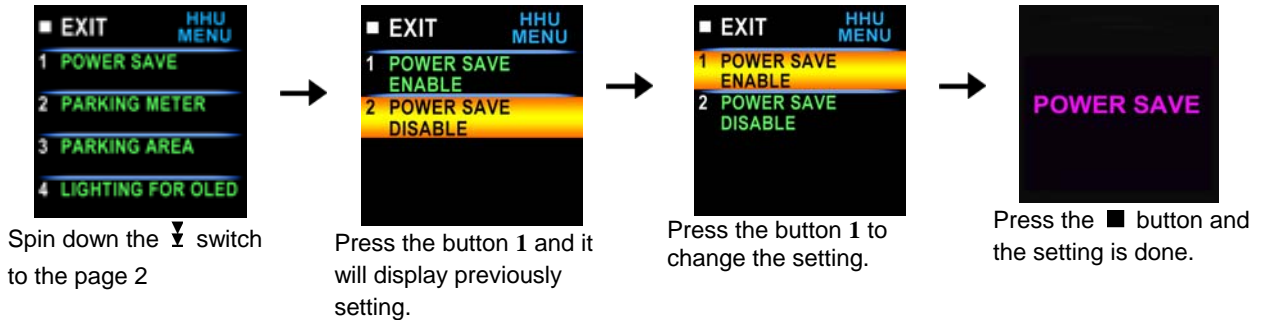

**E- P2- 2. "PARKING METER" SETTING:** Example set the "Parking Meter 30 min..

**Note:** When "parking meter" trigger presses any button to stop the beeper.

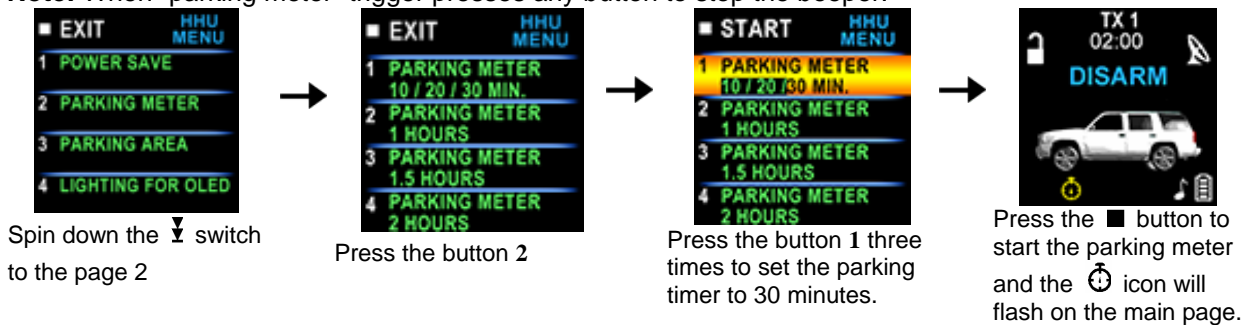

**D- P2- 3. "PARKING AREA" SETTING:** Example set the "Parking Area." to "B120

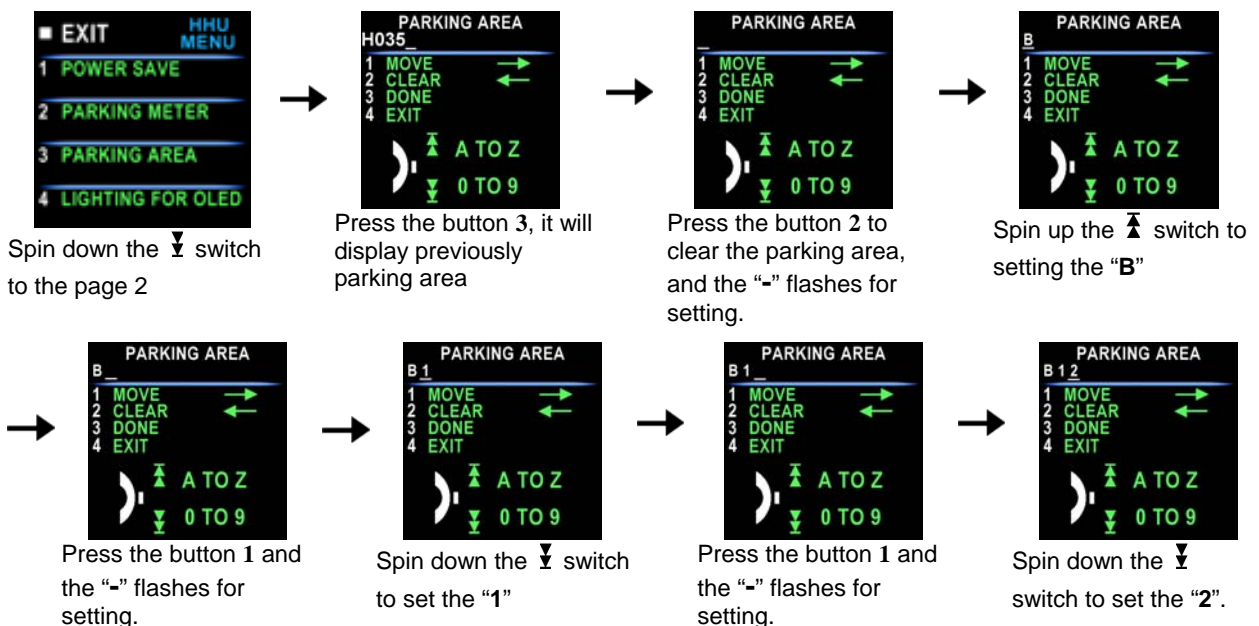



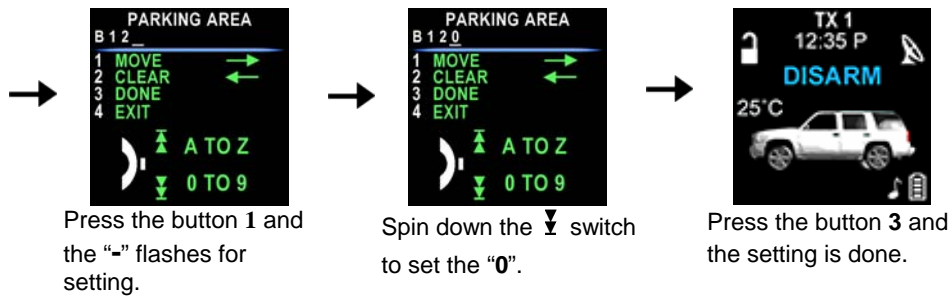

**D- P2- 4. "LIGHTING FOR OLED" TIMER SETTING:** Example: set the LCD display from 3 seconds to 9 seconds.

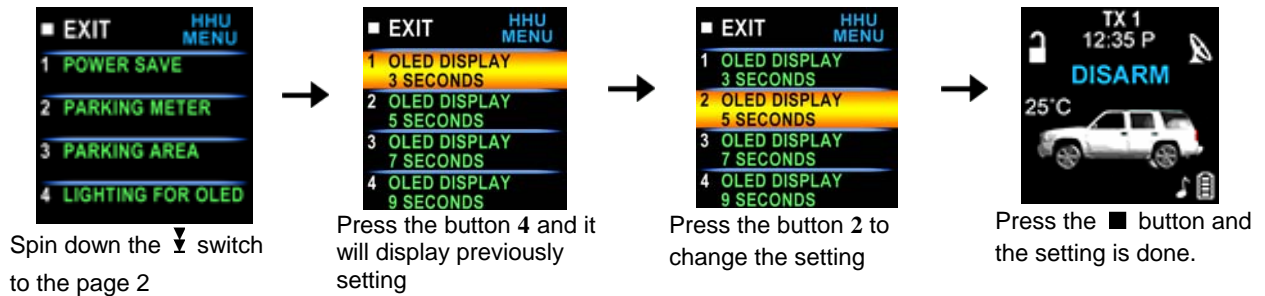

**D- P3- 1. "TIMER" SETTING:** Example set the timer to 08:20P

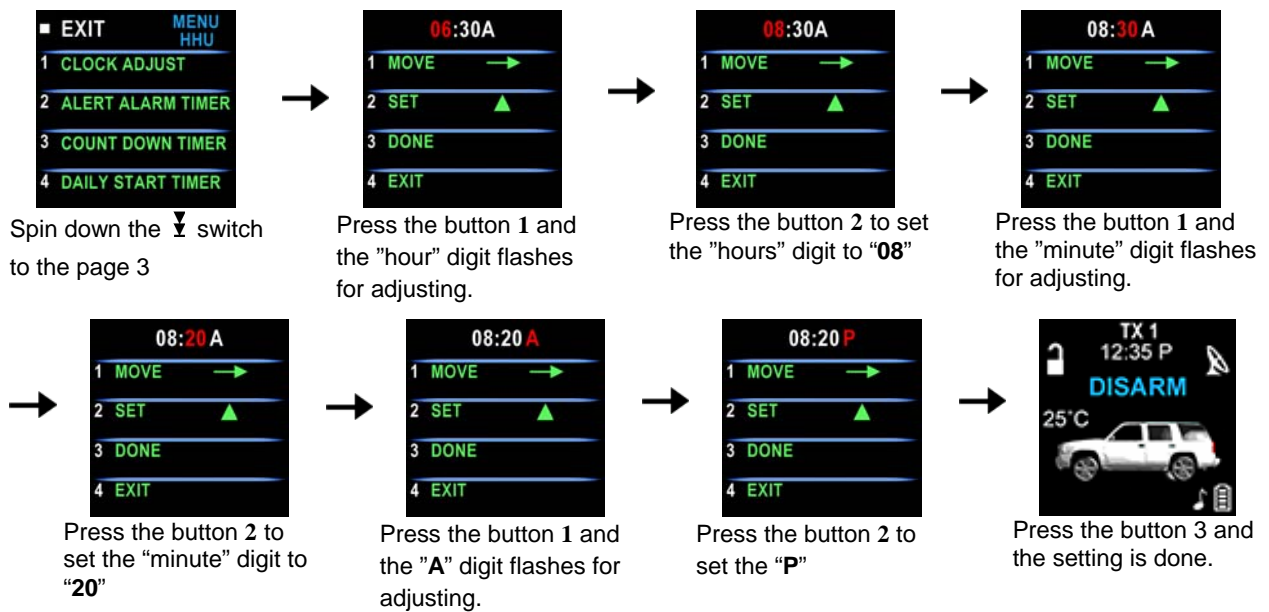

**D- P3- 2. "ALERT ALARM TIMER" SETTING:** Example set alert alarm timer to 06:30A

**Note:** When alert alarm timer trigger press any button to stop the beeper.

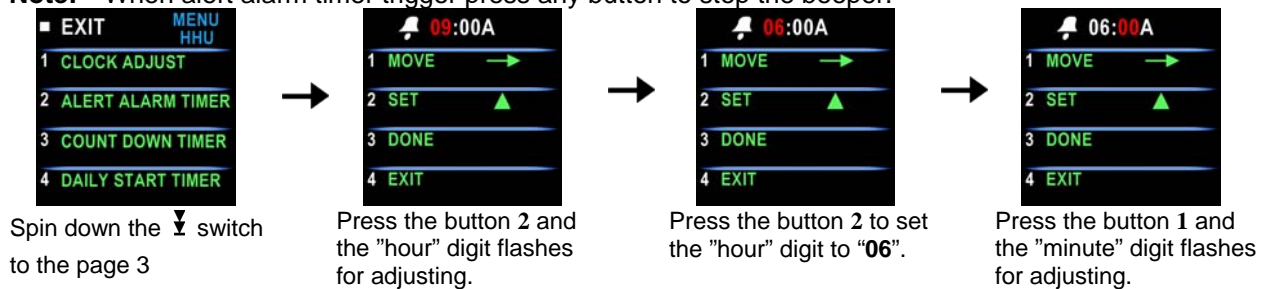

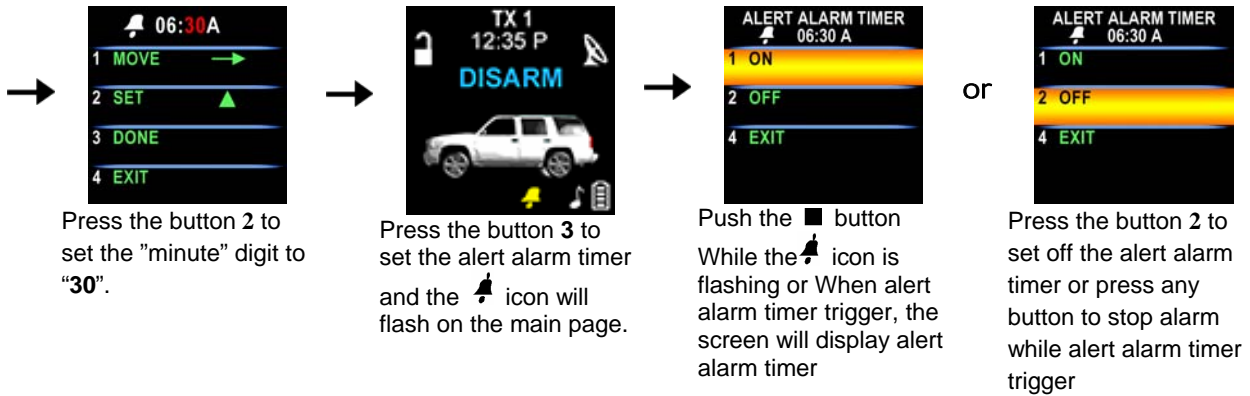

**C- P3- 3. "COUNT DOWN TIMER" SETTING:** Example set the count down timer to 2:30

**Note:** When count down timer is trigger, press any button to stop the beeper.

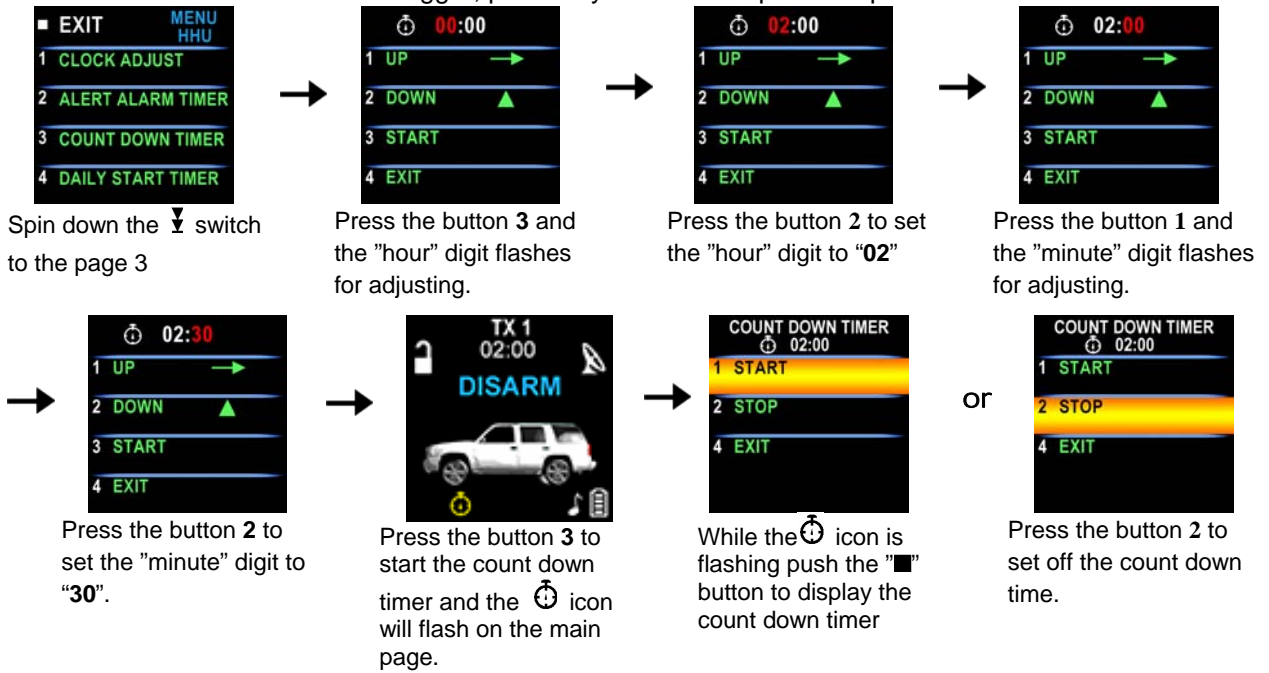

**C- P3- 4. "DAILY START TIMER" SETTING:** Example set the Daily Start Timer to 05:00A

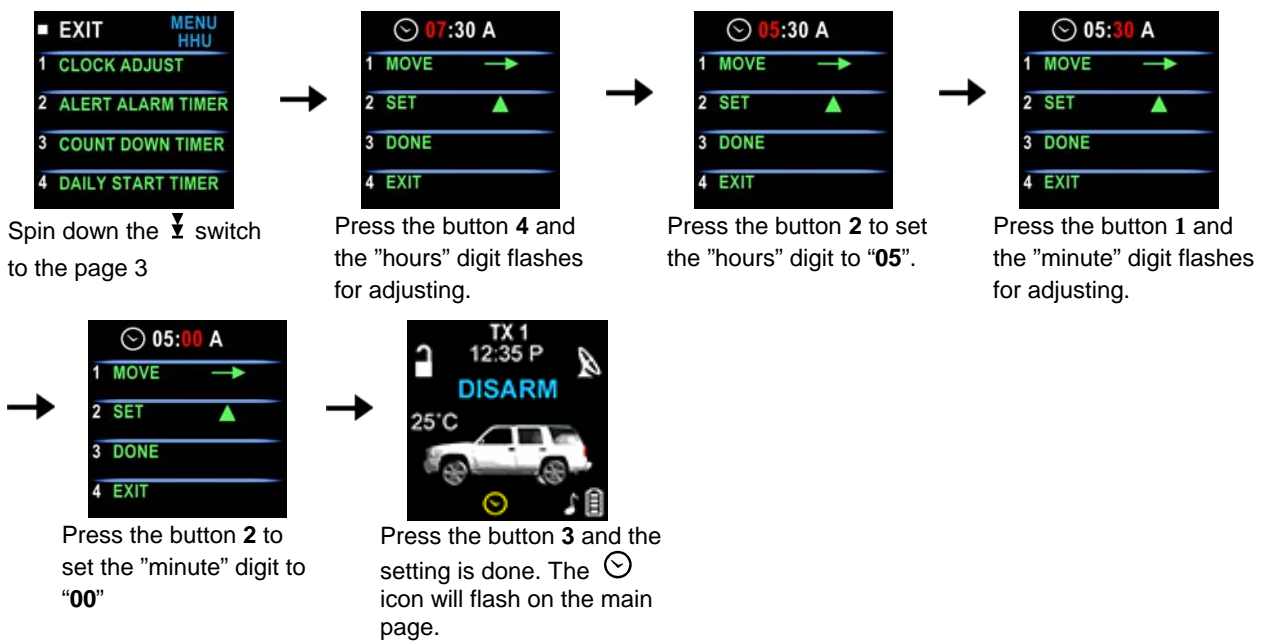

**D- P4- 1. "NAME OF TX " SETTING:** Example Set Name of Transceiver 1 to MIKE

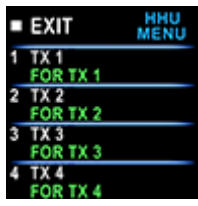

Spin down the  $\downarrow$  switch to the page 4



Press the button 1 and the "-" flashes for setting.



Spin down the  $\downarrow$  switch to set the "M".

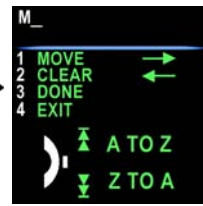

Press the button 1 and the "-" flashes for setting.



Spin up the  $\uparrow$  switch to set the "I".



Press the button 1 and the "-" flashes for setting.



Spin down the  $\downarrow$  switch to set the "K".



Press the button 1 and the "-" flashes for setting.



Spin up the  $\uparrow$  switch to set the "E".



Press the button 3 and the setting is done.

**D- P5- 1. "NAME OF CHANNEL " SETTING:** Example Set Name of channel 4 to GARAGE DOOR

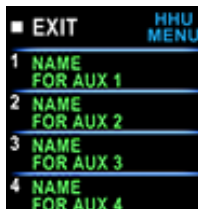

Spin down the  $\downarrow$  switch to the page 5



Press the button 1 and the "-" flashes for setting.

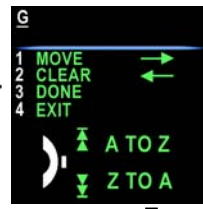

Spin up the  $\uparrow$  switch to set the "G".

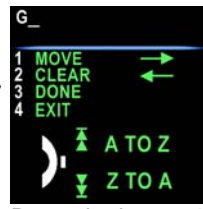

Press the button 1 and the "-" flashes for setting.



Spin down the  $\downarrow$  switch to setting the "A".

Following the above step to setting Alphabetical to GRAGE DOOR



Press the button 1 and the "-" flashes for setting.



Spin down the  $\downarrow$  switch to set the "R".



Press the button 3 and the setting is done.

**D- P6- 1. LANGUAGE SETTING:** Example set the Language to **English**



Spin down the  $\downarrow$  switch to the page 6



Press the button 1 to set the Language to "ENGLISH".



Press the  $\blacksquare$  button and the setting is done.

**D- P6- 4. SET TO DEFAULTS:**



Spin down the  switch to the page 6

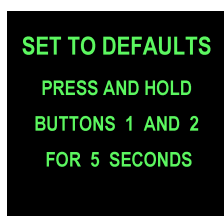

Press the button 4.

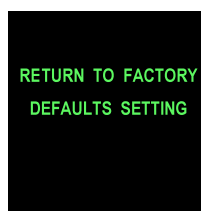

Press the button 1 & 2 at same time to set the defaults.

## OPERATION

### A. REMOTE TRANSMITTER OPERATION:

Transmitter Button	System Function	Remark
1	Lock Doors & Arm System / Button 1	
-	Arm and Double Lock Pulse	Press twice within 3 seconds
-	Arm and Bypass The Zone 4	Press within 5 seconds
-  -	Arm and Bypass The Zone 6	Press within 5 seconds
-  -  -	Arm and Bypass The Zone 4 and 6	Press within 5 seconds
-	Arm System and Hidden Alarm Function	Press within 3 seconds
+	Car Locator	Any time pressed
+  (3-second)	Panic function	Press and Hold for 3 seconds.
(2-second)	Silent Arming	Ignition in "off" position.
(2-second)	Silent Disarming	Ignition in "off" position.
+  (5-second)	Active Anti Car-Jacking Mode	Ignition in "on" position press and hold for 5 seconds
2	Unlock Doors & Disarm System / Button 2	
-	Two Steps Door Unlock & Disarm System	Press twice within 3 seconds.
3	Button 3	
(2-second)	Trunk Release (Channel 3)	Press and Hold for 2 seconds
-	Passive Arming By-pass	While the system Disarmed.
* 4	Turn Off The Remote Start / Button 4	.
* - *	Activate The Remote Start	Press twice within 3 seconds.
+	AUXILIARY 1 Timer Output	
+	AUXILIARY 2 Timer Output	
+ *	AUXILIARY 3 Timer Output	
+ *	AUXILIARY 4 Timer Output	
	Switching code For 2nd Car Operation.	For regular remote transmitter
	Button Function Selection	For Two way Remote transceiver
	Confirm Button / Back to Main Page	For Two way Remote transceiver
	Feature Selection	For Two way Remote transceiver

### B. LED display:

LED	Function
Off	Disarmed
Slow Flash	Armed
Fast Flash	Passive Arming
On (Solid)	Valet Mode
Pause On	Password Lock-Out

LED	Function
1 flashes... pause	Zone 1 / Trigger on Hood
2 flashes... pause	Zone 2 / Trigger on Trunk
3 flashes... pause	Zone 3 / Trigger on Door Switch
4 flashes... pause	Zone 4 / Trigger on Shock Sensor
5 flashes... pause	Zone 5 / Trigger on Ignition Switch
6 flashes... pause	Zone 6 / Trigger on Optional Sensor

### C. CHIRP INDICATORS:

Chirp	Function
1 chirp	Arm
2 chirps	Disarm
3 chirps	Ajar Warning
4 chirps	Disarm / Triggered
6 chirps	Car Locator

### D. PARKING LIGHT:



Parking light	Function
1 flash	Arm
2 flashes	Disarm
3 flashes	Disarm / Triggered
12 flashes	Car Locator
Constant On	Under Remote Start

### E. ACTIVE ARMING – LOCK & ARM:

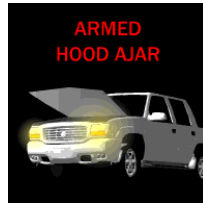

1. Press  button on the transmitter.
2. The siren will chirp once and parking light will flash once indicating that the system is now armed. The vehicle door will lock upon arming when interfaced with the security system.











**AJAR WARNING:** If the siren sounds 3 chirps, then you have left a door, trunk, or hood lid ajar.

**SILENT ARMING:** Spin up the  switch to the page 1 and then press the “Silent Arm” button or Press the transmitter  buttons 2 seconds to arm your security system, No chirp sound will be heard, arm confirmation will be through the vehicles parking lights only.



#### SENSOR BY-PASS:

**Bypass The Zone 4:** Spin up the  switch to the page 2 and then press the button 1 or press the  -  button within 5 seconds on the transmitter will arm the security system and by-pass the zone 4-shock sensor.

**Bypass The Zone 6:** Spin up the  switch to the page 2 and then press the button 2 or press the  -  -  button within 5 seconds on the transmitter will arm the security system and by-pass the zone 6-shock sensor..

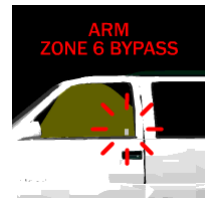
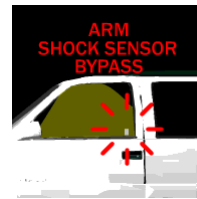
**Bypass The Zone 4 and Zone 6:** Spin up the  switch to the page 2 and then press the button 3 or press the  -  -  -  button within 5 seconds on the transmitter will arm the security system and by-pass the zone 4 and 6-shock sensor. The system will chirp one additional time to confirm the sensor bypass mode was activated. The sensor bypass feature is programmed to activate for one arming cycle only. The security system will return to normal operation during the next arming cycle.



**HIDDEN ALARM FUNCTION:** Spin up the  switch to the page 1 and then press the “Hidden Alarm” button or press the  button first; within 3 seconds press the  button to activate the hidden alarm function. The security system will arm and with “Hidden Alarm Function” The siren / horn will be silenced even if the sensor is triggered in the armed status.





### F. PASSIVE ARMING

Active arming / disarming is controlling your security system via the remote transmitter. This security system is equipped with an optional Passive Arming feature, which allows the security system to arm 30 seconds after the last door is closed. Operation is as follows.

1. Turn the ignition to the “OFF” position and exit the vehicle.
2. After all entrances are closed, the security system LED will flash fast for 30 seconds. If you reopen any door / hood / trunk, the security system LED will stop flashing. It will begin flashing again once the vehicle all entrances are closed.
3. After 30-second timer has elapsed, the security system will automatically “ARM”. The siren will chirp [1] time and the parking lights will flash [1] time.

#### PASSIVE ARMING WITH PASSIVE DOOR LOCKING:

The vehicle doors will automatically lock after passive arming cycle has been completed.



**PASSIVE ARMING BY-PASS:** While the system disarmed, Press the  button twice, the security will respond with [1] chirp and LED will turn “ON”. The security system will remain in this temporarily state for as long as you wish. To exit passive by-pass, press the transmitter  or  button and the system will return to normal status.

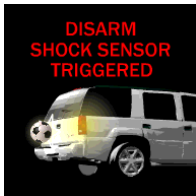
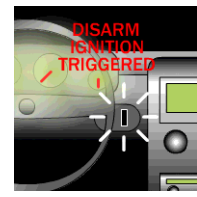

## G. ACTIVE DISARMING – UNLOCK & DISARM:

1. Press  button on the transmitter.
2. The siren will chirp twice and parking light flash twice to indicating that the security system is now disarmed. The vehicle's door will unlock and dome light turns on for 30 seconds upon disarming when interfaced with the security system.



**SILENT DISARMING:** Spin up the  switch to the page 1 and then press the “Silent Disarm” button or Press the transmitter  and  buttons at the same time to disarm your security system, No chirp sound will be heard, arm confirmation will be through the vehicles parking lights only.

**TAMPER DISARMING:** If alarm triggered, upon disarm the system, siren chirp 4 times, parking light flash 3 times.

**PATHWAY ILLUMINATION:** This feature turns the parking light “ON” for 30 seconds upon a unlock signal and for 10 seconds upon the lock signal

**TWO STEPS DOOR UNLOCK:** This feature will independently unlock the driver's door only when disarming the security system. Pushing the  button a second time within 3 seconds will unlock the other doors.

**AUTOMATIC RE-ARM:** If this feature is selected, the security system will automatically re-arm itself in 60 seconds after disarming with remote transmitter. Automatic rearm will cancel if any door is opened before the 60 seconds timer has elapsed.

## H. DISARMING WITHOUT A TRANSMITTER

**OVERRIDES THE ALARM WITHOUT PASSWORD PIN CODE:** (Factory Default Setting)

The Override function may be used if the remote transmitter is lost or inoperative.

1. Enter the vehicle and turn the ignition switch to 'ON' position. (Alarm will sound.)
2. Within 10 seconds push and release the valet switch

The alarm will stop sounding and enter the disarm mode. You can now start and operate the vehicle normally.

**OVERRIDE THE ALARM WITH PASSWORD PIN CODE:**

Unlike valet switch easily found, and defeated, this security system allows the consumer to program a password pin code. Offering a higher level of security.

1. Enter the vehicle and turn the ignition switch to 'ON' position. (Alarm will sound.)
2. Within 5 seconds, enter your chosen the first digit code by press and release the Valet Switch. (When finished above procedures, system's siren stop alarming, parking light stop flashing, but the vehicle cannot be start and drive away.)
3. If you use one digit to be a password pin code, skip to Step 6. If you use two digits to be a password pin code, advance to Step 4
4. Within 15 seconds of the last digit code enter (the 1st code), turn the Ignition Switch “Off” and then “On”.
5. Within 15 seconds, enter your chosen of the second digit code by press and release the Valet Switch.
6. Turn the ignition switch “OFF” position. [4] Chirps form siren/horn, [3] flash from parking light to indicate the system was disarmed.

**Note:** If some one key-in at wrong password pin code, the system allows him to make 2 mistakes, if third time still wrong, it will automatically shut down for 5 minutes. During the period the system will not accept any correct number and the LED will “pause on” (the LED will turns on 1 second and turns off 0.1 seconds pause).

**EXAMPLE: To Override The System With The Password Code 83, you would;**

1. Enter the vehicle and turn the ignition switch to 'ON' position. (Alarm will sound.)
2. Within 5 seconds, Press and Release the Valet Switch 8 times (When finished above procedures, system's siren stop alarming, parking light stop flashing, but the vehicle cannot be start and drive away.)
3. Within 15 seconds of the last digit code enter (the 1<sup>st</sup> code), turn the Ignition Switch “Off” and then “ON”.
4. Within 15 seconds, Press and Release the Valet Switch 3 times
5. Turn the Ignition Switch to “Off” position. [4] Chirps form siren/horn, [3] flash from parking light to indicate the system was disarmed.

## I. VALET MODE: (System in Disarm or Valet mode)

The valet switch allows you to temporarily bypass all alarm function, eliminating the need to hand your transmitter to parking attendants or garage mechanics.

When the system is in valet mode, all alarm function and remote start functions are bypassed, however the remote panic feature and remote door locks will remain operational. To use the valet mode, the system must first be disarmed either by using your remote transmitter, or by operating the Manual override sequence.



### Enter Valet Mode:

1. From the disarmed condition, turn the ignition to "ON" position.
2. Push and hold valet switch for 2 seconds until the LED turns on. The LED will remain on as long as the system is in 'valet mode'.



### Exit Valet Mode:

1. Return to normal operation, turn ignition 'on'.
2. Push and hold valet switch for 2 seconds, The LED will turn off indicate the system are exiting the valet mode.

## J. CAR LOCATOR

Under armed mode, press the + button to active car locator function. The siren will chirp 5 times. The parking light will flash 5 times, for you to easily locate your car.

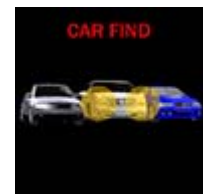

## K. PANIC FUNCTION:

The transmitter can be used as a remote panic switch to manually trigger the alarm in case emergency.

1. Press and hold the + button for 3 second. The alarm will immediately sound and the "Panic" icon will display on the OLED screen.
2. During panic mode, the normal function of this transmitter button will be suspended. The transmitter and buttons can be used to lock and unlock the door (if the option is installed), however once the button is pressed, the vehicle's starter disable device, (where installed) will be enable allowing the vehicle to start.
3. To stop the alarm, any transmitter buttons pressed and released, the panic mode will be turned off immediately.
4. If the button is not pressed, the alarm will automatically stop after 30 seconds.



## L. TRIGGER THE SYSTEM

When armed, your vehicle is protected as follows:

1. Light impact will trigger the warn-away signal.
2. Heavy impacts / Doors open / Hood open / Trunk open / Turn on the ignition key will trigger the programmed sequence.

The starter disable relay (if installed) prevents the vehicle's starter from cranking. The siren, horn, parking lights, and dome light will turn on to alerting of an intrusion for 30 seconds. Then it will stop and automatic reset and re-arm. If the one of sensors or detectors still active, the alarm system will sound a maximum of 6 times of 30 seconds cycles.



**Stop The Melody Sound:** While triggering the alarm the OLED screen will alert user through melody sound and flashing trigger icon, press any button on the OLED remote transceiver to stop melody sound.

**NOISE ABATEMENT CIRCUIT:** Your system has "Noise Abatement Circuit". It prevents annoying repetitive trigger sequences due to faulty door pin switches or environmental condition such as thunder, jackhammers airport noise, etc.

Here's how "Noise Abatement Circuit" works: The alarm triggers five times or ten times for warn-away triggers. Each time, the same sensor (zone 4 or zone 6) is triggering the alarm. "Noise Abatement Circuit" will interpret this pattern of triggers as false alarm. After the fifth trigger (tenth for warn-away), "Noise Abatement Circuit" ignores, or bypasses that sensor until the other sensor or switch is trigger. "Noise Abatement Circuit" covers doors (Hood/Trunk) differently: If the alarm is triggered by an open door for six full cycles, the doors will be bypassed until the trigger ceases.

**M. ANTI CAR- JACKING**

**Warning:** If you don't need the car jacking function in this alarm system, be sure to set car jacking feature "OFF". This system is default setting all car-jacking "OFF".

**ACTIVE ANTI CAR JACKING:**

1. Spin up the ▲ switch to the page 1 and then press and hold the "Car Jacking" button for 2 seconds or press and hold the transmitter 🔑 and 🔑 buttons at the same time for 5 seconds while the vehicle's ignition is ON. The parking lights will turns on for 1.5 seconds to indicate the system enters the car-jacking mode.

2. Once the system in car-jacking mode, If you are forced from the vehicle, the system will be trigger when the door is opened and closed while the ignition is "ON".

**PASSIVE ANTI CAR- JACKING:**

1. Turn the ignition switch to "ON" position; the system enters the car-jacking mode.  
 2. Once the system in car-jacking mode, If you are forced from the vehicle, the system will trigger when the door is opened and closed while the ignition is "ON".

**TRIGGER THE ANTI CAR -JACKING MODE:**

- a). 50 seconds after the system has been triggered. The siren will start chirping for 15 seconds.
- b). During this 15 seconds period of chirping, you will be alerting to push the valet switch once to turn off the car-jacking feature. If not, it will enter second timer car jacking.
- c). 65 seconds after the system has been triggered. The siren starts alarming and the parking light starts flashing.
- d). 90 seconds after the system has been triggered
  - 1. The siren still alarming and the parking light flashing, and
  - 2. The starter disable will activate to prevent the vehicle from starting.
  - 3. It will remain active until the vehicle's battery power exhausted.

**OVERRIDE THE SYSTEM TO TURN OFF ANTI CAR- JACKING:**

Turn the ignition switch from OFF to ON, and within 10 seconds push valet switch, the siren will stop and the system disarmed

**Note:** If you use password pin code to double protect the vehicle security, you will need to use it to completely disarm the system.



**N. SYSTEM'S TRIGGER CHECK**

Spin up the ▲ switch to the page 4 and then press the "Trigger Check" button, it responds with one melody sound and all trigger's records will immediately displayed on the OLED screen.

**Note:** If it has no responds then you are out of range.

**O. SYSTEM'S STATUS CHECK**

Spin up the ▲ switch to the page 4 and then press the "Status Check" button, it responds with one melody sound and all vehicles' status records will immediately displayed on the OLED screen.

**Note:** If it has no responds then you are out of range.

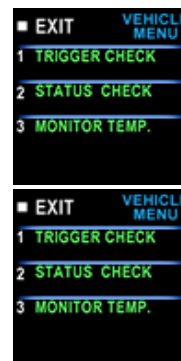

**P. DRIVER PAGING / LOSE & FOUND**

It is useful the event that someone wants to page the driver of the parked vehicle or someone cannot find his OLED remote transceiver.

**Indoor Driving Paging**

Under the ignition switch "off" condition, press and hold the valet switch for 2 seconds to page the driver, one chirp sound shall be emitted from the vehicle and the paging melody sound continues sounding from you Remote OLED transceiver and "DRIVER PAGING" indication flashes on the OLED screen.

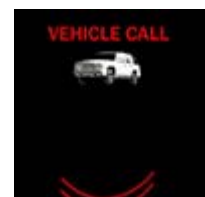



**Q. DOME LIGHT CONVENIENCE DELAY & SUPERVISION**

- The alarm with a unique feature which will turn on your vehicle dome light as following:
1. Upon disarming, the interior light will remain on for 30 seconds.
  2. If the vehicle is intruded, the interior light will flash for the same duration as the siren.
- Note: Turn on the ignition switch or arm the alarm will turn off the dome light.

**R. IGNITION CONTROL DOOR LOCK/UNLOCK.** (See Alarm Feature II – 2 Programming).

If the vehicles door locks have been interfaced to the security system, the system will automatically lock the vehicle's doors when the ignition is turned "ON" and /or unlock the vehicle's doors when the ignition is turned "OFF".

**S. TRUNK RELEASE (CHANNEL 3) OUTPUT.**

Press and hold button on the transmitter for two seconds to remote control the trunk release or other electric devices.



**T. AUXILIARY 1 /2/3/4 TIMER CONTROL OUTPUT**

**Activate The AUXILIARY 1:** Spin up the switch to the page 3 and then press the "Auxiliary 1" button or press the transmitter and buttons at the same time to active Auxiliary 1 function.

**Activate The AUXILIARY 2:** Spin up the switch to the page 3 and then press the "Auxiliary 2" button or press the transmitter and buttons at the same time to active Auxiliary 2 function.

**Activate The AUXILIARY 3:** Spin up the switch to the page 3 and then press the "Auxiliary 3" button or press the transmitter and buttons at the same time to active Auxiliary 3 function.

**Activate The AUXILIARY 4:** Spin up the switch to the page 3 and then press the "Auxiliary 4" button or press the transmitter and buttons at the same time to active Auxiliary 4 function.

The channel output is user-programmable timer output. For instance, this timer output may be used to turn on the headlight, power window or sunroof. (Factory defaults setting at momentary output.)

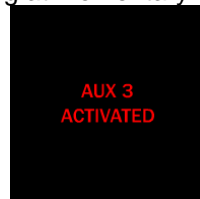
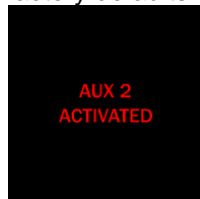
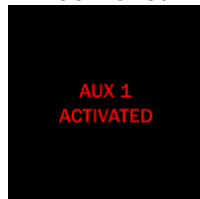
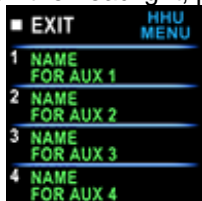

**U. MULTI- VEHICLE SECURITY OPREATION:**

Your remote transmitter can be utilized to control multi- vehicle security system, to program the remote control transmitter to a second vehicle, follow the instructions for Transmitter programming. All programming parameters be the same except for the following:

**For Regular Remote Control Transmitter:**

1. Prior to pushing any button on the transmitter. Press the Select button first on the transmitter.
2. Once button is pressed the LED on the transmitter will illuminate for 3.5 seconds to indicate the second transmitter pin code has built-in.
3. While the LED is illuminated, press any button on the remote control transmitter to control a second vehicle security system.

**For 2-way OLED Remote Control Transceiver:**

A maximum of four vehicle's security system can be control by this transceiver.



TX1 White Vehicle



TX2 Blue Vehicle



TX3 Yellow Vehicle

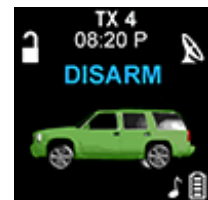

TX4 Green Vehicle

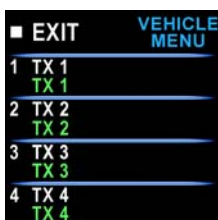

The four transmitters will display on the OLED screen, you can choice one of four transmitters to control your vehicle security system.



Now you can press button to remote control The "TX 3" yellow vehicle security system.

Spin up the  switch  
To the page 6

Press the button 3 and the setting is  
done also the "TX 3" will display on  
the OLED screen

## V. POWER ON MEMORY:

This security system is equipped with circuitry that will allow the unit to remember its alarm state if the power is lost and then reconnected.

## REMOTE START OPERATION

### A. TO REMOTE START THE VEHICLE:

1. Press \* button twice on the transmitter.
2. The parking light will activate to indicate the remote start received the signal. (A melody sounding from your Remote OLED transceiver and  icon will flashes on the OLED screen to confirm the remote start was activated.)
3. The engine will start approximately 5 seconds.
4. Once the engine is running, after couple seconds the parking light will turn on again  
and climate controls will activate and adjust the vehicles interior temperature to your  
Preset setting. (While the vehicle is running, the "Engine Running" icon and the "minutes" digit on the OLED screen will flash and it will indicate count down timer based on the 5, 10, 20 or 30 minute run time set up by your installation center.)
5. The vehicle will run for 5 to 30 minute cycle and automatically shut down. (When the unit shuts off the count down timer will turn off and the transmitter will play a melody.)

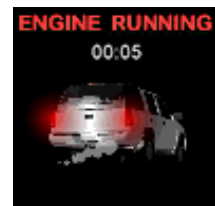

**Note:** The Remote Start Unit will not start the vehicle if any one of the following conditions exists:

1. The hood is opened.
2. The brake pedal is pressed.
3. Move the optional remote start enable toggle switch to OFF position. (If installed)
4. The gear selector is in any gear other then "PARK" or "NEUTRAL"

### B. TO OPERATE THE VEHICLE WHILE RUNNING ON THE REMOTE START:

To operate the vehicle while engine running on the remote start.

1. Insert the ignition key and turn it to "ON" (not the start) position.
2. Press the brake pedal.

**Note:** If the brake pedal is pressed before the key is in the ON position, the engine will shut down.



### C. TEMPORARY STOP FEATURE:

This feature allows the vehicle to remain running after the key has been removed from the ignition. This feature is useful for occasions when you wish to exit and lock the vehicle for short periods of time, but would like to leave the motor running and the climate control on.

1. Before turning off the engine, press the \* button twice on the transmitter.  
-- The LED indicator will flash 3 times to confirm enter.
2. Turn the ignition key to OFF position. (The engine will stay running.)
3. The engine will run until the pre-programmed time elapsed or shutdown input is received.

### D. TURBO TIMER MODE:

Turbo timer mode keeps the engine running after arriving at you destination for a programmable period of 3, 5 or 10 minutes, This allows the system's time to conveniently cool down the turbo after you have left the vehicle. To activate the turbo timer:

1. While engine is running, place the transmission gear in the park position and pull up the hand brake.
2. Before turning off the engine, Spin up the  switch to the page 5 and then press the "Turbo Start" button or press and release  and \* buttons at the same time.  
-- The parking light will activate to indicate the remote start has entered turbo timer mode. --
3. Pull off the "Ignition Key" from the key cylinder.  
-- Engine keeps running. --
4. Exit and secure the vehicle.  
-- Engine continues running until the pre-programmed time elapsed. --

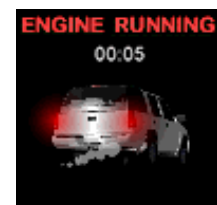

If you do not want the vehicle to continue to run for one cycle, simply step on the vehicle's brake, or activate the \* button in succession. Any of these will cause the engine to turn off.

### E. TIMER START:

Your system has the ability to automatically start the vehicle every 1,2 or 3 hours, run for the pre-programmed time (5, 10, 20 or 30 minutes), and then shut off. This will continue for 48 hours. This feature is especially useful in cold climates where the only means to keep the engine and engine fluids warm is to periodically start the engine.



If the system is set up to start in temperature mode, the system can be programmed to automatically start the vehicle engine whenever the temperature inside the vehicle reaches or drops below the preprogrammed temperature level. The system will monitor the air temperature every 3 (2 /1) hour and will only start the engine during extreme cold temperatures.

**WARNING!** Be certain that the vehicle is outdoors before using this or any remote vehicle-starting device. A running engine produces dangerous carbon monoxide fumes, which can be harmful or fatal if prolonged exposure occurs. DO NOT remote start the vehicle if it is garaged.

#### Timer Start Operation:

1-a. Turn the ignition key on then off. Within 15 seconds, spin up the  switch to the page 5 and then press the "Timer Start".

or

1-b. Press the  button twice to remote start the vehicle. As soon as the vehicle is activate and the parking light has turned on. Within 10 seconds, select the  button first then press the  button once.



2. The parking lights will flash and the siren will chirp 3 times indicating the timed start mode is activated.

**Daily Timer Start Operation:** The feature is very useful for the driver who wants to run the vehicle punctually at the same time next morning. Before set-up of the "Daily Timer Start", you should set you time for engine start. (See the "Daily Timer Start" Setting at page 10)

1. Turn the ignition key on then off.

2. Within 15 seconds, spin up the  switch to the page 5 and then select the "Daily start".

3. The parking lights will flash and the siren will chirp 6 times indicating the daily timed start mode is activated.

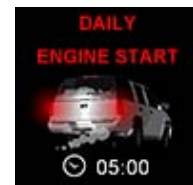

**Cancel the timer start:**

Timer start will be cancelled by starting the vehicle with the ignition key manually.

#### F. TEMPERATURE CHECK

You can monitor through the OLED screen, the present indoor temperature of the passenger compartment before cooling or heating your vehicle.

Spin up the  switch to the page 4 and then select the "Monitor TEMP."; the in-door temperature will be shown on the OLED screen. This reading may be higher than actual ambient temperature due to the greenhouse and is relative only the inside vehicle temperature.



#### G. TO TURN OFF THE REMOTE START:

When the engine is running (by remote start), if you want to stop it,

1. Press  button on the remote transmitter under remote start mode.

2. Move the optional remote start enable toggle switch to OFF position.(If installed)

3. Press the brake pedal.

The vehicle will shut down and turn off the parking light to indicate engine stopped.

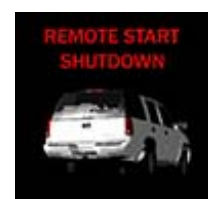

#### H. SHUT-DOWN INPUT FOR REMOTE STARTER:

If any of the following conditions exist while the system is operating, the engine will not start or will shut down immediately:

1. The hood is opened.

2. The brake pedal is pressed.

3. Engine is over-revved. {"Tachometer checking type" only}

4. The pre-programmed run time (5 /10 /20 / 30 minutes) has elapsed.

5. Press  button on the remote transmitter under remote start mode.

6. Move the optional remote start enable toggle switch to OFF position. (If installed)

7. The vehicle refused to start running after {3} unsuccessful attempts.

#### I. DISABLING THE REMOTE START SYSTEM: (If installed)

This feature allows your system's remote start unit to be temporarily disabled to prevent the vehicle from being remote started accidentally. This feature is useful if the vehicle is being serviced or stored in an enclosed area. To disable the remote start, move the optional remote start enable toggle switch to the OFF position.

## TEST MODE

In this test mode, this system can test the all of the trigger input. The installer can save time to test the sensitivity of the 2-stage shock sensor and optional sensor and without using the traditional arming/disarming procedures to test the sensors.

1. Press the  button to disarm the system, within 10 seconds



2. Spin up the  switch to the page 5



3. Select 1 / 2

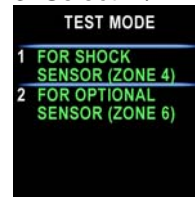

4. Press button **2** to test the Two Stage Shock Sensor: Two chirps to indicate your are in the two-stage shock sensor test mode.

1. Activate the warn-away (first stage of the shock sensor); system will emit a short chirp.
2. Activate the full alarm (second stage of the shock sensor); system will emit a long chirp.
3. Continue to test the shock sensor until reach the proper sensitivity.

5. Press button **3** to test the two-stage Optional Sensor: Three chirps to indicate your are in the two-stage optional sensor test mode.

1. Activate the warn-away (first stage of the shock sensor); system will emit a short chirp.
2. Activate the full alarm (second stage of the shock sensor); system will emit a long chirp.
3. Continue to test the optional sensor until reach the proper sensitivity.

**Exit:** While in test mode, turns the ignition **On** and **OFF**.

### ***Federal Communication Commission Interference Statement***

This equipment has been tested and found to comply with the limits for a Class B digital device, pursuant to Part 15 of the FCC Rules. These limits are designed to provide reasonable protection against harmful interference in a residential installation.

This equipment generates, uses and can radiate radio frequency energy and, if not installed and used in accordance with the instructions, may cause harmful interference to radio communications. However, there is no guarantee that interference will not occur in a particular installation. If this equipment does cause harmful interference to radio or television reception, which can be determined by turning the equipment off and on, the user is encouraged to try to correct the interference by one of the following measures:

- Reorient or relocate the receiving antenna.
- Increase the separation between the equipment and receiver.
- Connect the equipment into an outlet on a circuit different from that to which the receiver is connected.
- Consult the dealer or an experienced radio/TV technician for help.

***FCC Caution*** :To assure continued compliance, any changes or modifications not expressly approved by the party responsible for compliance could void the user's authority to operate this equipment. (Example - use only shielded interface cables when connecting to computer or peripheral devices).

### ***FCC Radiation Exposure Statement***

This device complies with Part 15 of the FCC Rules. Operation is subject to the following two conditions: (1) This device may not cause harmful interference, and (2) This device must accept any interference received, including interference that may cause undesired operation.

To satisfy FCC RF exposure compliance requirements, this device should be used in hand-held, hand-operated configurations only. The device and its antenna must maintain a separation distance of 20cm or more from a person's body, except for the hand and wrists, to satisfy RF exposure compliance.

This device is designed to be used in a person's hands and its operating configurations do not support normal transmissions while it is carried in pockets or holsters next to a person's body.