

ADX DAS User Manual

Version 0.3



**3116 West Vanowen St.
Burbank, CA 91505
Tel: 818-840-8131
Fax: 818-840-8138**

www.adrftech.com



*Information in this document is subject to change without notice.
Advanced RF Technologies, Inc. 1996-2012.
All rights reserved.*

- Please send comments to:

E-Mail: info@adrfttech.com

Phone: (818) 840-8131

(800) 313-9345

Fax: (818) 840-8138

- Address:

Advanced RF Technologies, Inc.
Attention: Technical Publications Department
3116 Vanowen St.
Burbank, CA 91505
USA
www.adrfttech.com

Revision History

Version	Author	Descriptions	Date
0.1	BC Kim	Initial Release	
0.2	Sun Kim	Edited version of the initial release	2/28/12
0.3	YHKO	HE, RU PSU Back panel Fig. revised, HE Back side Fig. revised	3/8/12

Change List

Version	Change list	Contents

Table of Contents

1.	Introduction.....	14
1.1	Highlights	14
1.2	Parts List.....	15
1.2.1	HE Part Lists	15
1.2.2	RU Part Lists	18
1.3	ADX DAS Quick View	20
1.3.1	HE Quick View	20
1.3.2	RU Quick View	21
1.4	Warnings and Hazards	22
2.	Block Diagram	24
2.1	ADX DAS Block Diagram.....	24
2.2	ADX DAS Topology	25
2.3	SISO Configuration	26
2.4	MIMO configuration	27
2.5	ADX-DAS Scalability.....	28
3.	ADX Overview	29
3.1	Head End.....	29
3.1.1	NMS (Network Management System)	30
3.1.1.1	LEDs.....	30
3.1.1.2	Ethernet Port	31
3.1.1.3	Host/Remote Switch.....	31
3.1.1.4	HE View/RU View Switch.....	31
3.1.2	RFU (ADX-H-RFU-x).....	32
3.1.2.1	LEDs.....	32
3.1.2.2	RF Ports	33
3.1.2.3	Communication Port.....	33
3.1.3	Channel Combiner (ADX-H-CHC).....	33
3.1.3.1	RF ports.....	33
3.1.4	Optic Unit (ADX-H-OPT)	34
3.1.4.1	LEDs.....	34
3.1.4.2	RF ports.....	34
3.1.4.3	Optic ports	35
3.1.4.4	Communication Port.....	35
3.1.5	Power Supply Unit (ADX-H-PSU)	35
3.1.5.1	LEDs.....	35
3.1.5.2	AC Input On/Off Switch, AC Input Port and AC Input Selection Switch.....	36
3.1.5.3	Battery Backup Port, Battery Install Port and Battery Backup Switch	36
3.1.6	Optional Band Combiner Unit (ADX-H-BCU-x).....	37

3.1.6.1	LEDs.....	37
3.1.6.2	RF Ports	37
3.1.6.3	Communication Port.....	37
3.1.7	Optional Optic Expansion Unit (ADX-H-OEU)	38
3.1.7.1	LEDs.....	38
3.1.7.2	Optic ports	38
3.1.7.3	DC Power Input port & GUI Port	39
3.1.7.4	Power On/Off Switch & ADDR	39
3.1.7.5	OEU Block Diagram	39
3.2	RU (ADX-R-x30M/S).....	41
3.2.1	Master RU (ADX-R-x30M)	42
3.2.1.1	LEDs.....	42
3.2.1.2	RF Ports	43
3.2.1.3	Optic Port	44
3.2.1.4	Power On/Off Switch & DC IN Port	44
3.2.1.5	PSU Alarm Port.....	44
3.2.1.6	GUI Port	44
3.2.1.7	RS-485 Port.....	44
3.2.1.8	ADDR	46
3.2.2	Slave RU (ADX-R-x30S).....	46
3.2.2.1	LEDs.....	46
3.2.2.2	RF Ports	46
3.2.2.3	Power On/Off Switch & DC IN Port	47
3.2.2.4	RS-485 Port.....	47
3.2.3	RU Power Supply Options	48
3.2.3.1	RU Power Adapter (ADX-R-ADP).....	48
3.2.3.2	RU PSU (ADX-R-PSU-30)	48
3.2.3.3	LEDs.....	48
3.2.3.4	AC Input On/Off Switch, AC Input Port and AC Input Selection Switch.....	49
3.2.3.5	Battery Backup Port and Battery Backup Switch	49
3.2.3.6	DC Output Port.....	50
3.2.3.7	PSU Alarm Port.....	50
3.2.4	Optional 4-Way Combiner (ADX-R-4WS).....	50
4.	Cable Connection.....	51
4.1	Head End Connection Diagrams	51
4.1.1	Front/Rear Head End Connection View with Optional BCU unit	51
4.1.2	Rear Head End Connection View with (4) OPT units	52
4.2	Remote Unit Connection Diagrams	53
4.3	Remote Unit w/ 4-Way Combiner (ADX-R-4WS)	54
5.	Mounting method.....	55

5.1	Head End	55
5.1.1	Rack Mount	55
5.1.2	Wall Mount	56
5.2	Remote Unit	57
5.2.1	Rack Mount	57
5.2.2	Wall Mount	58
5.2.2.1	Remote Unit using RU Chassis (ADX-R-CHA-30).....	58
5.2.2.2	Individual Sub RU.....	58
6.	Installation	59
6.1	Pre-Installation Inspection	59
6.2	ADX DAS Installation Procedure	59
6.2.1	HE Installation Procedure	59
6.2.1.1	Installing a ADX DAS HE in a rack.....	59
6.2.1.2	Wall mounting the ADX DAS HE.....	61
6.2.2	RU Installation Procedure	64
6.2.2.1	Installing a ADX DAS RU in a rack	64
6.2.2.2	Wall mounting the ADX DAS RU	66
6.2.2.3	Wall mounting an ADX Sub RU	69
6.2.3	ADX-H-OEU Installation Procedure	70
6.2.3.1	Installing a ADX-H-OEU in a Rack.....	70
6.2.3.2	Wall mounting the ADX-H-OEU	72
6.3	Grounding	73
6.4	Optic port cleaning	74
7.	Commissioning	75
7.1	Pre-Commissioning Check	75
7.1.1	Verify cable connections	75
7.1.2	Connect to the Web-GUI	75
7.1.3	Check Navigation tree Lock Status	75
7.1.4	Set location Info, Installer Info and Date & Time.....	76
7.1.5	Verify all links in Navigation tree	76
7.1.6	BOM Comparison & Check Band Configuration	76
7.1.7	Lock current navigation tree.....	76
7.2	Optic Loss Verification	78
7.2.1	How to compensate the optic loss	79
7.3	Commissioning	80
7.3.1	Optic Commissioning	80
7.3.2	HE Commissioning.....	80
7.3.2.1	HE BCU commissioning.....	80
7.3.2.2	HE RFU commissioning	80
7.3.3	RU Commissioning	82
7.3.4	Composite power	82

7.3.5	Downlink Composite Input Level Calculations for HE commissioning.....	82
7.3.5.1	One WSP exists in a frequency band	83
7.3.5.2	Multiple WSPs in a frequency band	83
7.3.6	Downlink Composite Output Level Calculations for RU commissioning.....	84
7.3.7	Example of commissioning value calculation.....	84
7.3.7.1	AT&T signal in the PCS band with multiple technologies (without attenuation)	84
7.3.7.2	AT&T signals in the PCS band with multiple technologies (with 10dB of attenuation) 85	
7.3.7.3	Multiple WSPs' signal exists in the PCS band (with power ratio)	85
7.4	DAS Install Verification	87
7.4.1	Setting SNMP & Remote IP	87
7.4.2	Verification through Web based GUI	87
7.4.3	UL noise power detection.....	87
8.	Web-GUI.....	87
8.1	Web-GUI Setup.....	87
8.1.1	DAS system/PC Connection Using Web-GUI.....	87
8.2	Administrator/User Mode	89
8.2.1	Common.....	89
8.2.1.1	Navigation tree Lock/Unlock	89
8.2.1.2	Navigation tree	89
8.2.1.3	Power Status	90
8.2.1.4	Commissioning Status	90
8.2.1.5	Information	90
8.2.2	Status Tab.....	92
8.2.2.1	Status- NMS	92
8.2.2.2	Status-RFU.....	95
8.2.2.3	Status – OPT.....	97
8.2.2.4	Status-RU-Hub	99
8.2.2.5	Status - Sub RU	101
8.2.3	Control Tab.....	104
8.2.3.1	Control- NMS.....	104
8.2.3.2	Control- RFU	105
8.2.3.3	Control-OPT	108
8.2.3.4	Control – RH Hub	109
8.2.3.5	Control – Sub RU	110
8.2.4	Install Tab.....	114
8.2.4.1	Install- NMS.....	114
8.2.4.2	Install- RFU	117
8.2.4.3	Install-OPT	119
8.2.4.4	Install-RU Hub	120

8.2.4.5	Install-Sub RU	121
8.2.5	System	122
8.2.5.1	System: Account	122
8.2.5.2	System: Logs.....	123
8.2.5.3	System: Update.....	124
8.2.5.4	System: System Information	125
8.2.5.5	System: Backup/Restore.....	126
8.2.5.6	System: SNMP	128
8.2.5.7	System: Closeout Package	129
8.2.6	Help	129
8.2.7	Logout	130
8.3	Guest Mode	130
9.	Specification	131
10.	Mechanical Drawing	132

Figures

Figure 1-1	HE Parts List	16
Figure 1-2	RU Parts List	1
Figure 1-3	ADX DAS HE Quick View.....	1
Figure 1-4	ADX DAS RU Quick View	1
Figure 2-1	ADX DAS Block Diagram	24
Figure 2-2	ADX DAS Topology.....	25
Figure 2-3	ADX DAS SISO Configuration	26
Figure 2-4	ADX DAS MIMO Configuration	27
Figure 3-1	Head End Front View	29
Figure 3-2	ADX-H-NMS Front View.....	30
Figure 3-3	NMS LED	30
Figure 3-4	Ethernet Port	31
Figure 3-5	Host/Remote Switch.....	31
Figure 3-6	HE View/RU View Switch	31
Figure 3-7	RFU Front & Rear View.....	32
Figure 3-8	RFU LED	32
Figure 3-9	Communication Port (RFU).....	33
Figure 3-10	ADX-H-CHC Front & Rear View.....	33
Figure 3-11	ADX-H-OPT Front & Rear View	34
Figure 3-12	OPT LED	34
Figure 3-13	OPT RF Ports.....	34
Figure 3-14	OPT Optic Ports	35
Figure 3-15	Communication Port (OPT).....	35
Figure 3-16	ADX-H-PSU Front & Rear View	35
Figure 3-17	HE PSU LED	35
Figure 3-18	HE PSU AC Input On/Off Switch, AC Input Port and AC Input Selection Switch	36
Figure 3-19	Battery Backup Port, Battery Install Port and Battery Backup Switch	36
Figure 3-20	ADX-H-BCU Front & Rear View	37
Figure 3-21	BCU LED	37
Figure 3-22	Communication Port (BCU).....	38
Figure 3-23	ADX-H-OEU Front & Rear View.....	38

Figure 3-24	OPT LED	38
Figure 3-25	OEU Optic Ports	39
Figure 3-26	DC Power Input Port & GUI Port.....	39
Figure 3-27	Power On/Off Switch & ADDR	39
Figure 3-28	OEU Block Diagram	40
Figure 3-29	RU Front View	41
Figure 3-30	RU Rear View.....	41
Figure 3-31	Master RU Front & Rear View.....	42
Figure 3-32	Master RU LED	42
Figure 3-33	RF Ports (Master RU).....	43
Figure 3-34	Master RU block Diagram and RF Port Name	43
Figure 3-35	Ports at the back panel (Master RU).....	44
Figure 3-36	Correct RS-485 connection between Master RU and Slave RU or between Slave RUs	45
Figure 3-37	Wrong RS-485 connection between Master RU and Slave RU or between Slave RUs.....	45
Figure 3-38	Do NOT connect RS-485 ports of Sub RU to network equipment port.....	45
Figure 3-39	Slave RU Front & Rear View	46
Figure 3-40	Slave RU LED	46
Figure 3-41	RF Ports (Slave RU).....	47
Figure 3-42	Slave RU block Diagram and RF Port Name	47
Figure 3-43	Ports at the rear panel (Slave RU)	47
Figure 3-44	RU PSU Front & Rear View	48
Figure 3-45	RU PSU LED	48
Figure 3-46	RU PSU Power Switch View	49
Figure 3-47	Battery Backup Port & Battery Backup Switch.....	49
Figure 3-48	DC Output Port (RU PSU).....	50
Figure 3-49	PSU Alarm Port (RU PSU).....	50
Figure 3-50	ADX-R-4WS Front View	50
Figure 3-51	ADX-R-4WS Inner View	50
Figure 4-1	HE Cable connection (1 OPT+1 BCU).....	51
Figure 4-2	HE Cable connection (4 OPTs).....	52
Figure 4-3	RU Cable connection (4 Sub RU + RU PSU)	53
Figure 4-4	Slave RU Expansion using ADX-R-4WS	54
Figure 5-1	HE Rack Mount (Front & Rear view).....	55
Figure 5-2	HE Wall Mount (Top View).....	56
Figure 5-3	RU Rack Mount (Front view).....	57
Figure 5-4	19" Shelf type - RU Wall Mount (Top view).....	58
Figure 5-5	Sub RU Wall Mount (Top view).....	58
Figure 6-1	ADX HE 19" Rack Mount Instructions	60
Figure 6-2	ADX HE Wall Mount Instructions	62
Figure 6-3	Wall Mount Instructions for ADX-HE added 1U Unit.....	63
Figure 6-4	ADX-RU 19" Rack Mount Instructions.....	65
Figure 6-5	ADX-RU Wall Mount Instructions	67
Figure 6-6	Wall Mount Instructions for ADX-RU added 1.5U Unit.....	68
Figure 6-7	Sub RU Wall Mount Instructions	69
Figure 6-8	ADX-H-OEU Rack Mount Instructions	71
Figure 6-9	ADX-H-OEU Wall Mount Instructions.....	72
Figure 6-10	Ground Cable Connection (HE rear side)	73
Figure 6-11	Ground Cable Connection (RU rear side).....	73
Figure 6-12	Optic Connector Cleaning (left) and Optic Port Cleaning (right).....	74
Figure 6-13	SC/APC Optic Connector Dust Cap.....	74
Figure 7-1	Login window.....	75
Figure 7-2	Navigation tree Lock/Unlock	76
Figure 7-3	Navigation tree	76
Figure 7-4	OPT Install page.....	78
Figure 7-5	measured optic loss display	78
Figure 7-6	BCU Install Window.....	80

Figure 7-7	RFU Install Window.....	81
Figure 7-8	Sub RU Install Window.....	82
Figure 8-1	Login screen.....	87
Figure 8-2	Navigation tree Lock/Unlock.....	89
Figure 8-3	Navigation tree.....	89
Figure 8-4	ADX DAS General Information.....	90
Figure 8-5	Status - NMS.....	92
Figure 8-6	System Summary.....	92
Figure 8-7	System scan time, HE view/RU view.....	93
Figure 8-8	HE alarm status.....	93
Figure 8-9	HE Commissioning status.....	94
Figure 8-10	Status – RFU.....	95
Figure 8-11	Power & Gain Display (Admin).....	96
Figure 8-12	Power & Gain Display (User).....	96
Figure 8-13	Status - OPT.....	97
Figure 8-14	Summary (Status – OPT).....	98
Figure 8-15	RF Status (Status – OPT).....	98
Figure 8-16	Optic Status (Status – OPT).....	98
Figure 8-17	Optic Attenuation (Status – OPT).....	99
Figure 8-18	Optic Path Status (Status – OPT).....	99
Figure 8-19	Status - RU Hub.....	100
Figure 8-20	RU Alarm Status (Status - RU Hub).....	100
Figure 8-21	RU Commissioning Status (Status - RU Hub).....	100
Figure 8-22	Status – Sub RU.....	101
Figure 8-23	PCS Band Information (Status – Sub RU).....	102
Figure 8-24	Power & Gain (Admin).....	102
Figure 8-25	Power & Gain (User).....	102
Figure 8-26	Optic Power (Status – Master RU only).....	103
Figure 8-27	Control - NMS.....	104
Figure 8-28	Heartbeat (Control – NMS).....	104
Figure 8-29	HE System Reboot & Factory Setting (Control – NMS).....	104
Figure 8-30	NMS System Reboot & Factory Setting (Control – NMS).....	104
Figure 8-31	Control - RFU.....	105
Figure 8-32	General Setting (Control – RFU) (Admin).....	105
Figure 8-33	General Setting (Control – RFU) (User).....	105
Figure 8-34	Reboot & Factory Setting (Control – RFU).....	106
Figure 8-35	UL Noise Detection (Control – RFU).....	106
Figure 8-36	UL Noise Detection - PCS band.....	106
Figure 8-37	Manual Attenuator Control Setting (Control – RFU).....	107
Figure 8-38	Alarm Threshold Setting (Control – RFU).....	107
Figure 8-39	Control – OPT.....	108
Figure 8-40	Optic Attenuation – OPT.....	109
Figure 8-41	Reboot & factory Setting (Control – OPT).....	109
Figure 8-42	Control – RU Hub.....	110
Figure 8-43	Reboot & factory Setting (Control – RU Hub).....	110
Figure 8-44	Control – Sub RU.....	111
Figure 8-45	General Setting (Control - RU).....	111
Figure 8-46	Reboot & factory Setting (Control - RU).....	112
Figure 8-47	Optic Setting (Control - RU).....	112
Figure 8-48	Manual Atten Control (Control - RU).....	112
Figure 8-49	Alarm Setting (Control - RU).....	113
Figure 8-50	Install - NMS.....	114
Figure 8-51	HE Commissioning Status (Install – NMS).....	114
Figure 8-52	SNMP (Install – NMS).....	115
Figure 8-53	Location Setting (Install – NMS).....	115
Figure 8-54	External Modem Box Setting (Install – NMS).....	115

Figure 8-55	Description (Install – NMS).....	116
Figure 8-56	SNMP Agent Flase Alarm Test (Install – NMS)	116
Figure 8-57	Location Info / Installer Info (Install – NMS)	116
Figure 8-58	Date & Time Setting (Install – NMS)	117
Figure 8-59	Install - RFU	117
Figure 8-60	RFU Commissioning (Install – RFU)	118
Figure 8-61	Description (Install – RFU)	118
Figure 8-62	Install – OPT.....	119
Figure 8-63	Optic control (Control – OPT).....	119
Figure 8-64	Description (Install – OPT)	120
Figure 8-65	Install-RU Hub	120
Figure 8-66	RU Commissioning Status (Install-RU Hub)	120
Figure 8-67	Description (Install-RU Hub)	121
Figure 8-68	Install-Sub RU	121
Figure 8-69	RU Output Commissioning (Install-RU)	121
Figure 8-70	Description (Install-Sub RU).....	122
Figure 8-71	Account Management	122
Figure 8-72	New Account	122
Figure 8-73	Change Password	123
Figure 8-74	Event Log	123
Figure 8-75	User Log	124
Figure 8-76	System update	124
Figure 8-77	Message after System update is complete	125
Figure 8-78	System Information	125
Figure 8-79	System Notification.....	126
Figure 8-80	Bill of material	126
Figure 8-81	Setting Backup (Before).....	127
Figure 8-82	Setting Backup (After)	127
Figure 8-83	Setting Restore.....	128
Figure 8-84	SNMP V1/V2	128
Figure 8-85	SNMP V3.....	129
Figure 8-86	System- Closeout Package.....	129
Figure 8-87	System- Closeout Package after the file upload	129
Figure 8-88	Help	130
Figure 10-1	HE Drawing	132
Figure 10-2	Master RU Drawing	133
Figure 10-3	Slave RU Drawing	134
Figure 10-4	RU Rack Shelf Drawing.....	135

Tables

Table 1-1	HE Parts List	15
Table 1-2	RU Parts List	18
Table 2-1	ADX-DAS Scalability	28
Table 3-1	NMS LED Specifications	30
Table 3-2	RFU LED Specifications.....	32
Table 3-3	OPT LED Specifications.....	34
Table 3-5	HE PSU LED Specifications.....	36
Table 3-4	BCU LED Specifications.....	37
Table 3-6	OPT LED Specifications.....	38
Table 3-7	Master RU LED Specifications.....	42
Table 3-8	Slave RU LED Specifications	46
Table 3-9	RU PSU LED Specifications.....	48
Table 7-1	Optic loss compensation table	79
Table 7-2	Back-off value for each technology due to traffic breathing	83
Table 7-3	Input signal conditions @HE RFU downlink input.....	84
Table 7-4	HE maximum downlink input level without 10dB attenuator	84
Table 7-5	HE downlink input signal conditions after adding 10dB attenuator to HE downlink input port 85	
Table 7-6	HE maximum downlink input level after adding 10dB attenuator to HE downlink input port	85
Table 7-7	Input signal conditions @HE BCU downlink input	85
Table 7-8	HE maximum downlink input level	85
Table 7-9	Targeted maximum input power.....	86
Table 7-10	Maximum Output Power per carrier	86
Table 9-1	Account Information for Login	88
Table 9-2	Navigation tree	89
Table 9-3	Power Supply Status	90
Table 9-4	Commissioning ICON.....	90
Table 9-5	System Summary Description.....	93
Table 9-6	Description for HE Commissioning status.....	94
Table 9-7	Description for NMS alarm	94
Table 9-8	Band Information (Status-RFU).....	95
Table 9-9	RFU Alarm Status	96
Table 9-10	Summary Description	98
Table 9-11	Description for optic path status.....	99
Table 9-12	Description for RU Commissioning status.....	100
Table 9-13	Alarm Status (Status - RU Hub).....	101
Table 9-14	Operating Status (Status – Sub RU).....	103
Table 9-15	Description for General Setting	105
Table 9-16	Description for Main Gain Control Setting (Control – RFU)	107
Table 9-17	Description for Alarm Threshold Setting (Control – RFU).....	107
Table 9-17	Description for Optic Attenuation (Control – OPT).....	109
Table 9-18	Description for General Setting (Control - RU)	111
Table 9-19	Description for Optic Setting (Control - RU).....	112
Table 9-20	Description for Manual Atten Control (Control - RU).....	112
Table 9-21	Description for HE Commissioning Status (Install – NMS)	114
Table 9-22	Description for Optic control (Control – OPT)	119
Table 9-12	Description for RU Commissioning status.....	120

Terms and Abbreviations

The following is a list of abbreviations and terms used throughout this document.

Abbreviation/Term	Definition
AGC	Automatic Gain Control
ALC	Automatic Level Control
AROMS	ADRF' Repeater Operation and Management System
BCU	Band Combiner Unit
BTS	Base Transceiver Station
CDMA	Code Division Multiple Access
CHC	Channel combiner
CW	Continuous Wave (un-modulated signal)
DAS	Distributed Antenna System
DL	Downlink
Downlink	The path covered from the Base Transceiver Station (BTS) to the subscribers' service area via the repeater
HE	Head End
HPA	High Power Amplifier
HW	Hardware
IF	Intermediate Frequency
LNA	Low Noise Amplifier
LTE	Long Term Evolution
MS	Mobile Station
NMS	Network Management System
ODU	Optic Donor Unit which is located in OPT. A OPT has two ODUs.
OEU	Optic Expansion Unit
OPT	Optic Unit
PLL	Phased Locked Loop
PSU	Power Supply Unit
RF	Radio Frequency
RFU	RF Channel Unit
RU	Remote Unit which is composed of master RU and multiple slaves RU
SQE	Signal Quality Estimate
Sub RU	generic term for master RU and slave RU
SW	Software
UL	Uplink
Uplink	The path covered from the subscribers' service area to the Base Transceiver Station (BTS) via the repeater
VSWR	Voltage Standing Wave Ratio

1. INTRODUCTION

Up to (8) frequency bands in one body: Currently the ADX supports 700 MHz (Lower A, Lower B, Upper C), Cellular, PCS, and AWS bands.

1.1 Highlights

- Modular Structure
 - Supports multi bands service (700MHz, Cell, PCS, AWS, etc.) in one body
 - Can support up to 8 RF units
- Supports optional combining/balancing of multiple carriers' signals via BCU (Band Combiner Unit)
- MIMO capable
- Supports up to a of maximum of 32 Remote Units
- 30dBm of downlink composite output power
- Operates with up to 5dBo optical loss (Single mode)
- Supports SNMP v1, v2, v3 (get, set & traps)
- Web-based GUI Interface; No 3rd party GUI software required
- Web-GUI connectivity via DHCP in host mode
- Versatility and Usability: ADX gives total control to the user. Control parameters such as gain, output power, and alarm threshold can be changed using Web-GUI interface allowing the user to fine tune the system to the given RF environment.
- Automatic uplink noise measurement routine
- Automated installation
- Support RU View mode, refer to section 3.1.1.4
- Incremental Automatic Shutdown/Resume Time: ADX gradually increases the time span between automatic shutdown and resume period before it permanently shuts itself down
- Support ALC function to prevent ADX DAS from input overload or output overpower

1.2 Parts List

1.2.1 HE Part Lists

Table 1-1 HE Parts List

Label	Quantity	Description
ADX-H-NMS (Required)		
A	1	ADX-H-NMS (NMS module)
B	1	HE Chassis
R	1	Extension bracket for added modules, wall mount
C	1	AC Power Cable
D	1	Ethernet Cable (Crossover)
E	1	Ground Cable
F	8	Anchor Bolt
G	1	Documentation CD(User Manual, Quick Start Guide and Troubleshooting Guide)
ADX-H-RFUs (At least 1 required)		
H	Up to 8	ADX-H-RFU, At least 1 module must be present in order to use ADX DAS
I	2/RFU	RF Cables between CHC and RFU, SMA Male to SMA Male
M	1/RFU	Module Data Cable, needed for RFUs connected to AUX CH1 or 2 ports
ADX-H-CHC (Required)		
J	1	ADX-H-CHC (HE Channel Combiner)
ADX-H-PSU (Required)		
J	1	ADX-H-PSU (HE Power Supply Unit)
C	1	AC Cable
ADX-H-OPT or ADX-H-ODU (At least 1 required)		
K	1	ADX-H-OPT or ADX-H-ODU
L	2 or 4	RF Cables between CHC and OPT, SMA Male to SMA Male 4 for ADX-H-OPT/ 2 for ADX-H-ODU
M	1	Module Data Cable
S	1	Extension bracket for wall mount
ADX-H-BCU (Optional)		
N	1	Optional Band Combiner
O	2	RF Cables between BCU and RFU, N Male to N Male
M	1	Module Data Cable
S	1	1U Extension bracket for wall mount
ADX-H-OEU (Optional)		
P	1	ADX-H-OEU (Optic Expansion Unit)
Q	1	AC/DC Adaptor
C	1	AC Cable

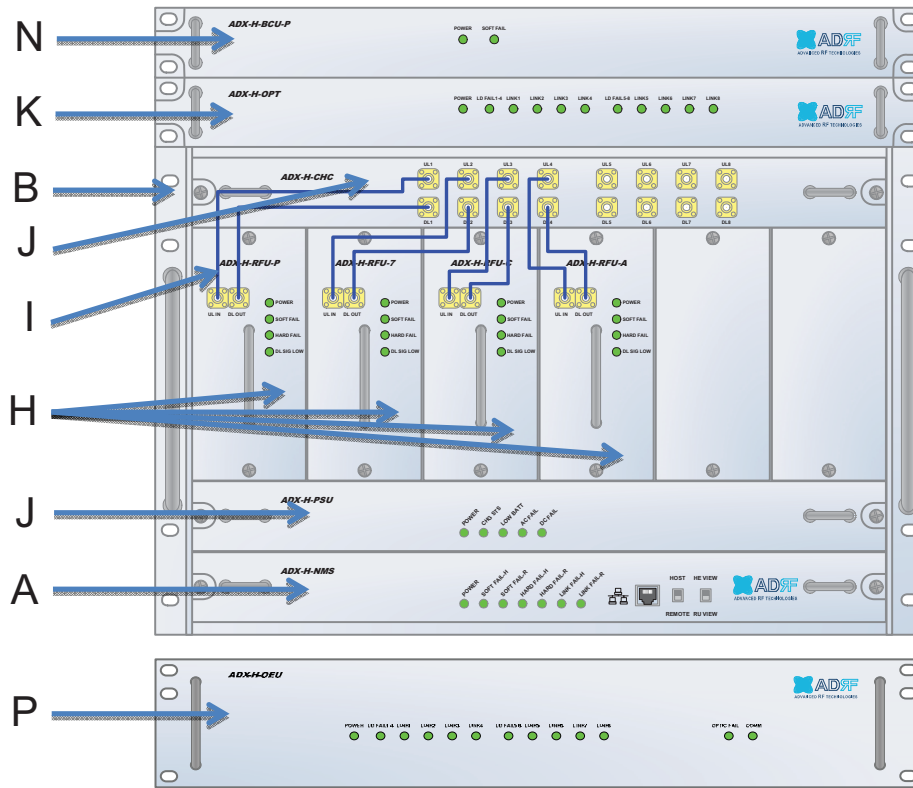

C D E F G



L M O Q



R S

Figure 1-1 HE Parts List

1.2.2 R U Part Lists

Table 1-2 RU Parts List

Label	Quantity	Description
ADX-R-CHA-30 (Optional)		
A	1	ADX-R-CHA-30 (RU Chassis) – Supports (1) Master RU + (3) Slave RU
B	1	Extension bracket for added modules, wall mount
C	1	Anchor Bolt
D	1	Ground Cable
Master RU (At least 1 required)		
E	1	ADX-R-x30M (Master RU)
H	1	USB Cable (Type A to Type B)
I	1	Documentation CD(User Manual, Quick Star Guide and Troubleshooting Guide)
J	1	Power Cable connected to RU PSU
K	1	PSU Alarm Cable connected to RU PSU
L	1	Wall Mount Bracket & Bolt
Slave RU (Optional)		
M	Up to 7	ADX-R-x30S (Slave RU)
N	2	RF cables between Mater RU and Slave RU
O	1	RS 485 Cable
J	1	Power Cable connected to RU PSU
L	1	Wall Mount Bracket & Bolt
ADX-R-4WS (Optional)		
P	1	4W splitter to support more than 4 Sub RUs
Q	2	RF cables between Mater RU and ADX-R-4WS
ADX-R-PSU-30 (Required or can use ADX-R-ADP-30)		
R	1	ADX-R-PSU-30 (Power Supply Unit)
S	1	1.5U Extension bracket for wall mount
ADX-R-CHC-V (Optional)		
T	1	ADX-R-CHC-V (RU channel combiner for VZW)
S	1	1.5U Extension bracket for wall mount
ADX-R-ADP-30 (Required or can use ADX-R-PSU-30)		
F	1	AC/DC Adaptor
G	1	AC Cable

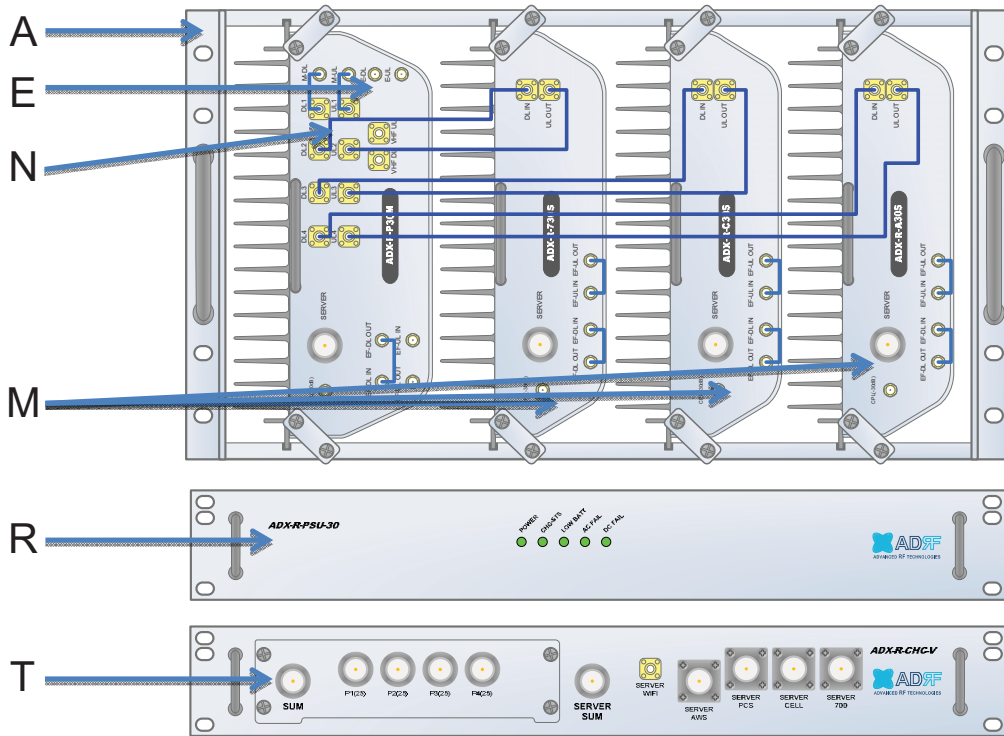

B C D F G



H I J K L O Q

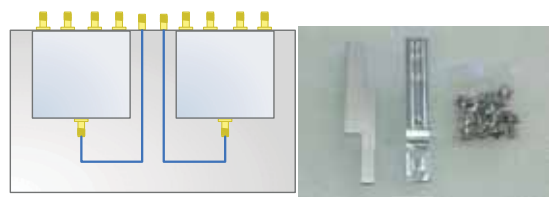

P S

Figure 1-2 RU Parts List

1.3 ADX DAS Quick View

1.3.1 HE Quick View

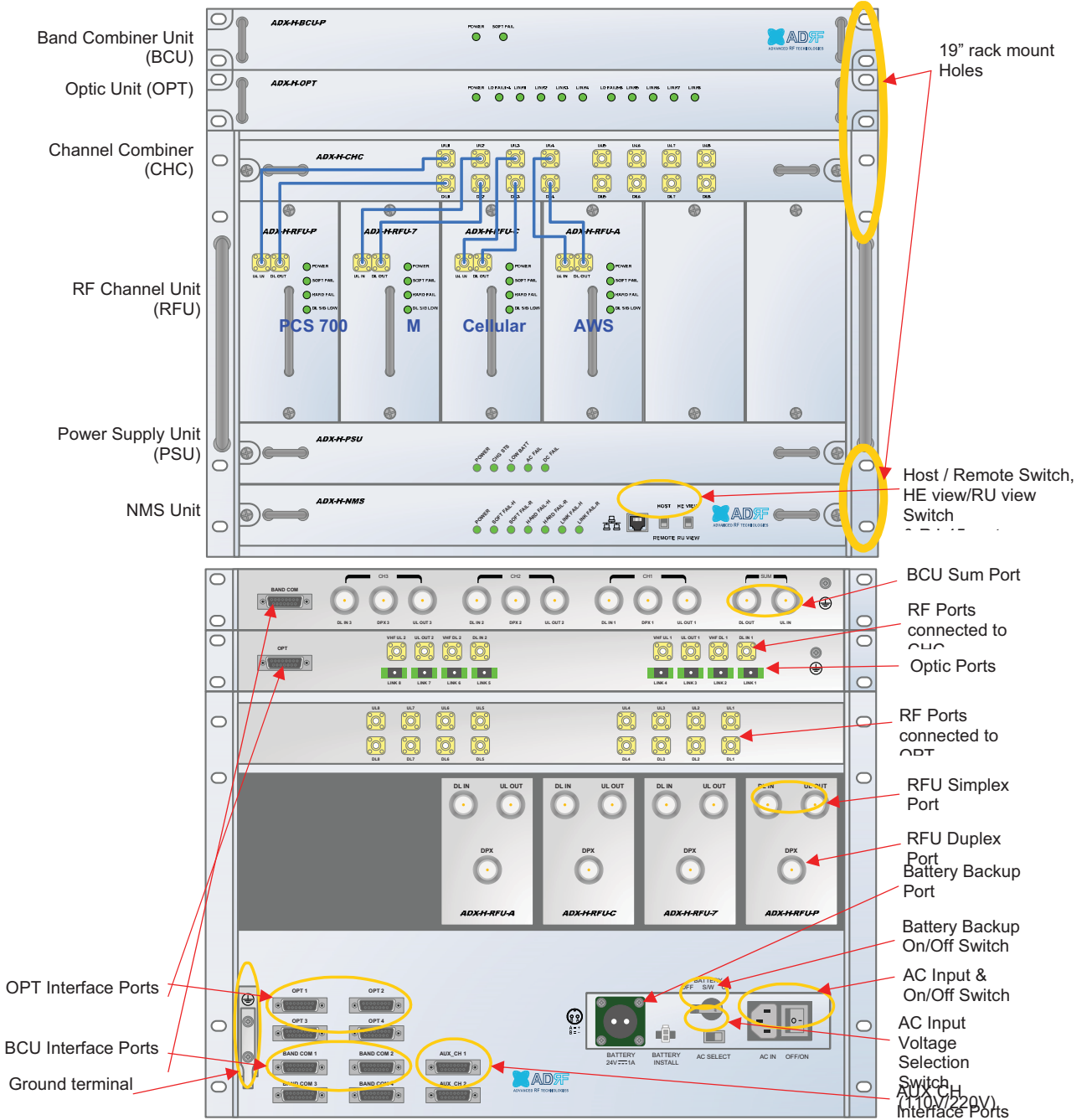

Figure 1-3 ADX DAS HE Quick View

1.3.2 RU Quick View

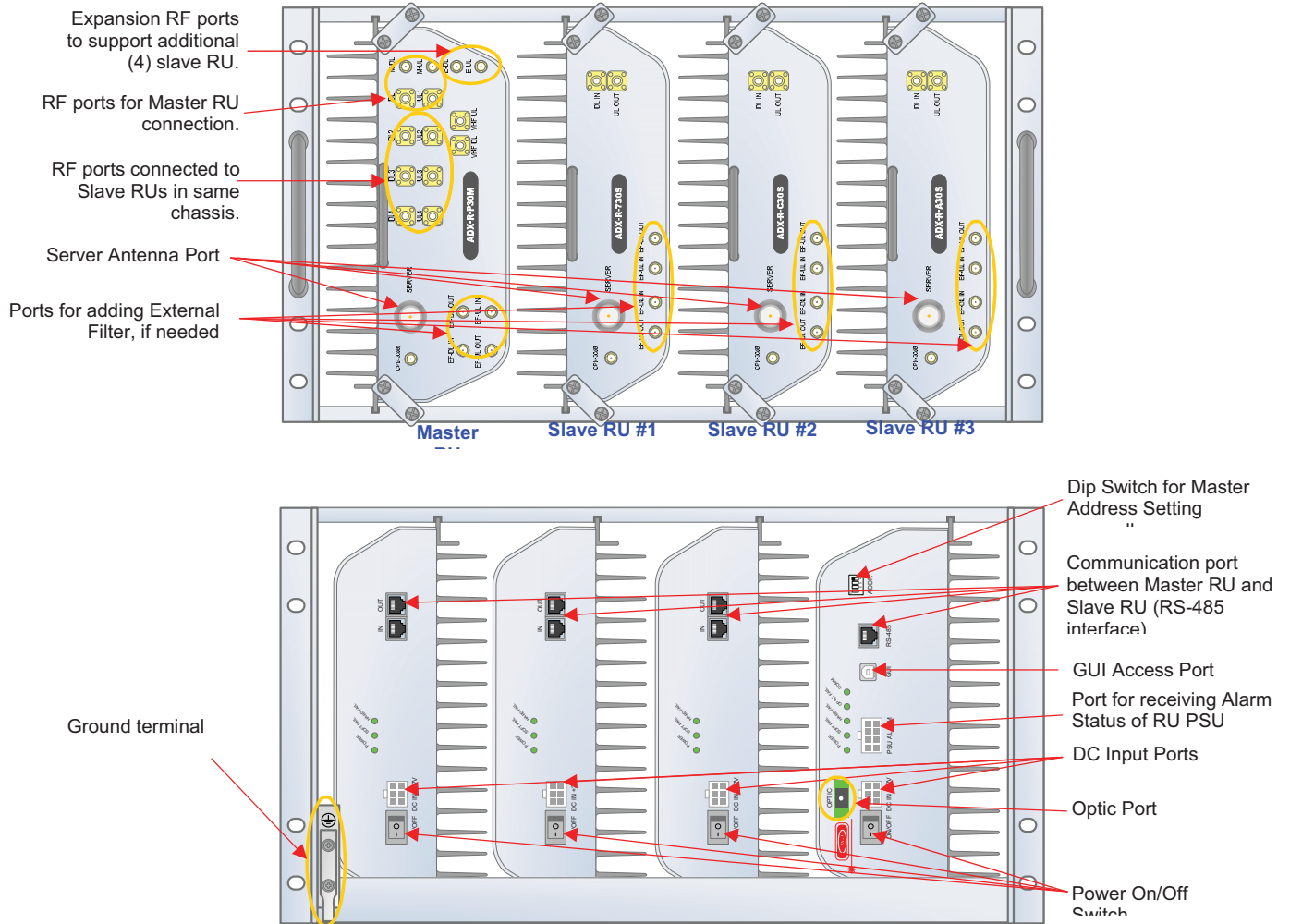

Figure 1-4 ADX DAS RU Quick View

1.4 Warnings and Hazards



WARNING! ELECTRIC

SHOCK

Opening the ADX DAS could result in electric shock and may cause severe injury.



WARNING! EXPOSURE TO RF

Working with the ADX DAS while in operation, may expose the technician to RF electromagnetic fields that exceed FCC rules for human exposure. Visit the FCC website at www.fcc.gov/oet/rfsafety to learn more about the effects of exposure to RF electromagnetic fields.

RF EXPOSURE & ANTENNA PLACEMENT

Guidelines

Actual separation distance is determined upon gain of antenna used.

Please maintain a minimum safe distance of at least 20 cm while operating near the donor and the server antennas. Also, the donor antenna needs to be mounted outdoors on a permanent structure.

WARRANTY

Opening or tampering the ADX DAS will void all warranties.

Lithium Battery: CAUTION. RISK OF EXPLOSION IF BATTERY IS REPLACED BY INCORRECT TYPE. DISPOSE OF USED BATTERIES ACCORDING TO INSTRUCTIONS.

Ethernet Instructions: This equipment is for indoor use only. All cabling should be limited to inside the building.

FCC Part 15 Class A

NOTE: This equipment has been tested and found to comply with the limits for a Class A digital device, pursuant to part 15 of the FCC Rules. These limits are designed to provide reasonable protection against harmful interference when the equipment is operated in a commercial environment. This equipment generates, uses, and can radiate radio frequency energy and, if not installed and used in accordance with the instruction manual, may cause harmful interference to radio communications. Operation of this equipment in a residential area is likely to cause harmful interference in which case the user will be required to correct the interference at their own expense.

Laser Safety

Fiber optic ports of the ADX DAS emit invisible laser radiation at the 1310, 1550nm wavelength window.

To avoid eye injury never look directly into the optical ports, patch cords or optical cables. Do not stare into beam or view directly with optical instruments. Always assume optical output is on.

Only technicians familiar with fiber optic safety practices and procedures should perform optical fiber connections and disconnections of the ADX DAS and the associated cables.

The ADX DAS complies with 21 CFR 1040.10 and 1040.11 except for deviations pursuant to laser notice No 50 (July 26 2001) @ IEC 60825-1 Amendment 2 (Jan 2001)

Care of Fiber Optic Connectors

Do not remove the protective covers on the fiber optic connectors until a connection is ready to be made. Do not leave connectors uncovered when not connected.

The tip of the fiber optic connectors should not come into contact with any object or dust.

Refer to the cleaning procedure for information on the cleaning of the fiber tip.

2.3 SISO Configuration

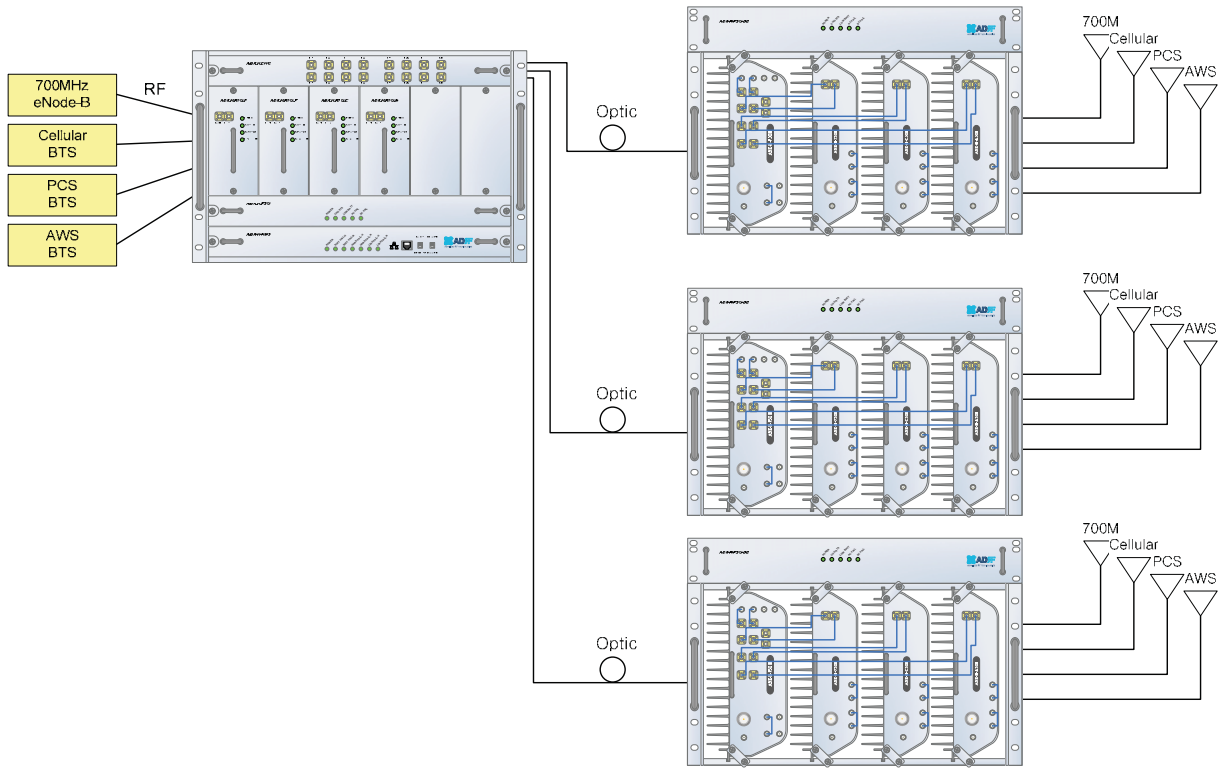

Figure 2-3 ADX DAS SISO Configuration

2.4 MIMO configuration

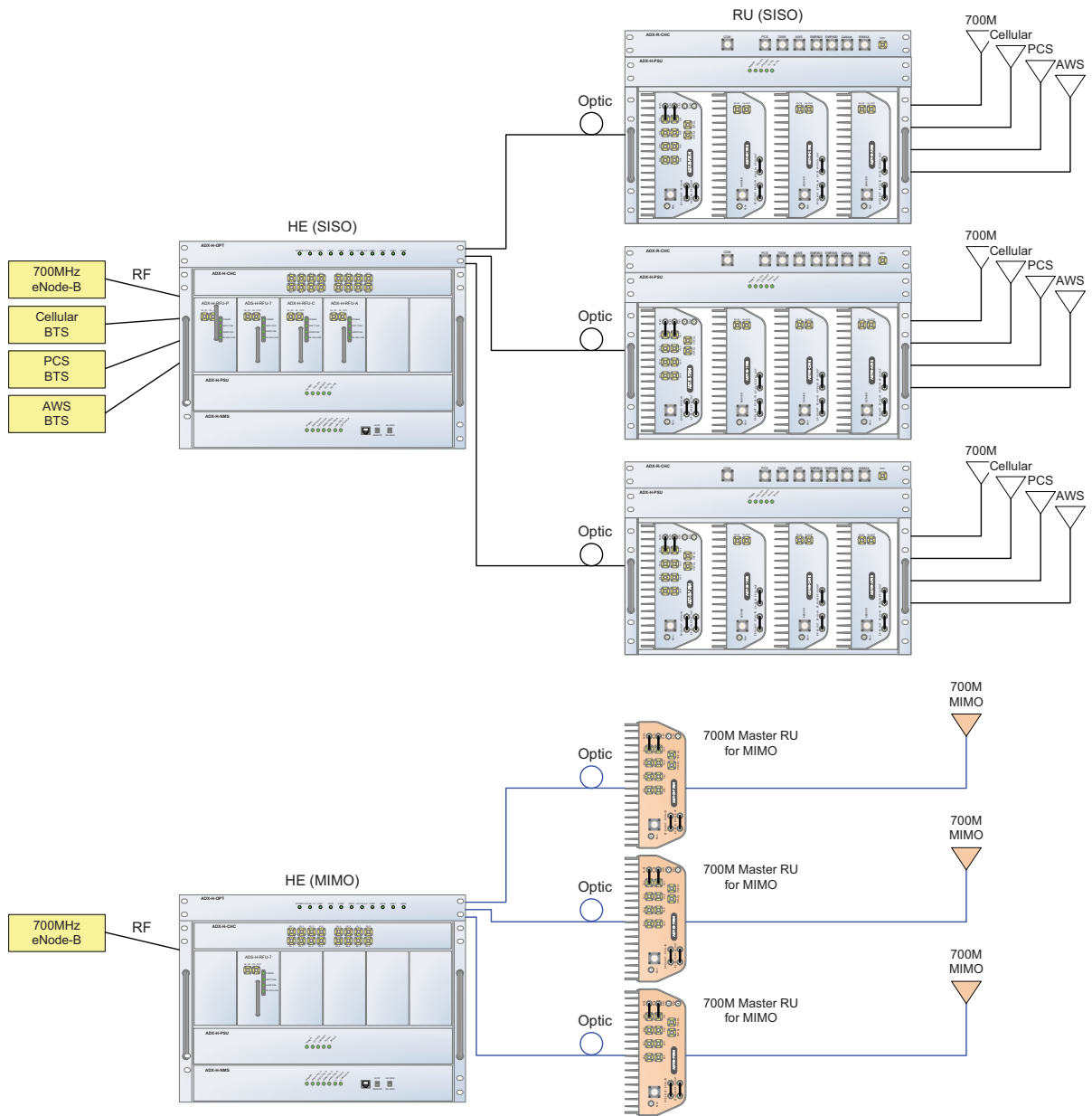

Figure 2-4 ADX DAS MIMO Configuration

- DAS system for MIMO can be supported by separate DAS System.
-

2.5 ADX-DAS Scalability

Table 2-1 ADX-DAS Scalability

Unit		Scalability	Remarks	
Supported band	Current	700M, Cellular, PCS, AWS		
	Future	Single Band	700M including Lower C, SMR800/900, SMR700/800, VHF/UHF, BRS	BRS band (TDD system) will be supported as independent system.
		Dual Band	PCS & SMR800/900, PCS & Cellular	
HE	RFU	Up to 8	up to 6: card type 7 th & 8 th RFU: 19" rack type	
	NMS	1		
	Channel Combiner	1		
	Optic Unit	Up to 4		
	Band Combiner Unit	Up to 4	To support multiple carriers	
	Power Supply Unit	1	Capable of supplying power to 8 RFUs, 4 BCUs, 4 OPTs and NMS.	
RU	RU	Up to 32		
	OEU	Up to 4		
	PS U	Adaptor type	1 per Sub RU	
		19" rack mount	1	Capable of supplying power to 8 Sub RUs

2.6

3. A DX OVERVIEW

3.1 Head End

HE Unit is composed of CHC-H, RFU, NMS, BCU, OPT and PSU.
 ADX-HE can support up to 8 RFUs and 4 BCUs.

- Spec
 - Size: 19.0 x 14.6 x 12.2 inches (482 x 370 x 311 mm)
 - Weight: 83.7 lbs (38.0 Kg)@4 RFU, CHC-H, PSU and NMS
 - Power Consumption: 55W@4 RFU, 1 OPT and NMS, 28W@1 RFU, 1 OPT and NMS
 - Power Input: 110VAC or -48VDC(optional)
 - Can support an ADRF-BBU for external battery backup solution

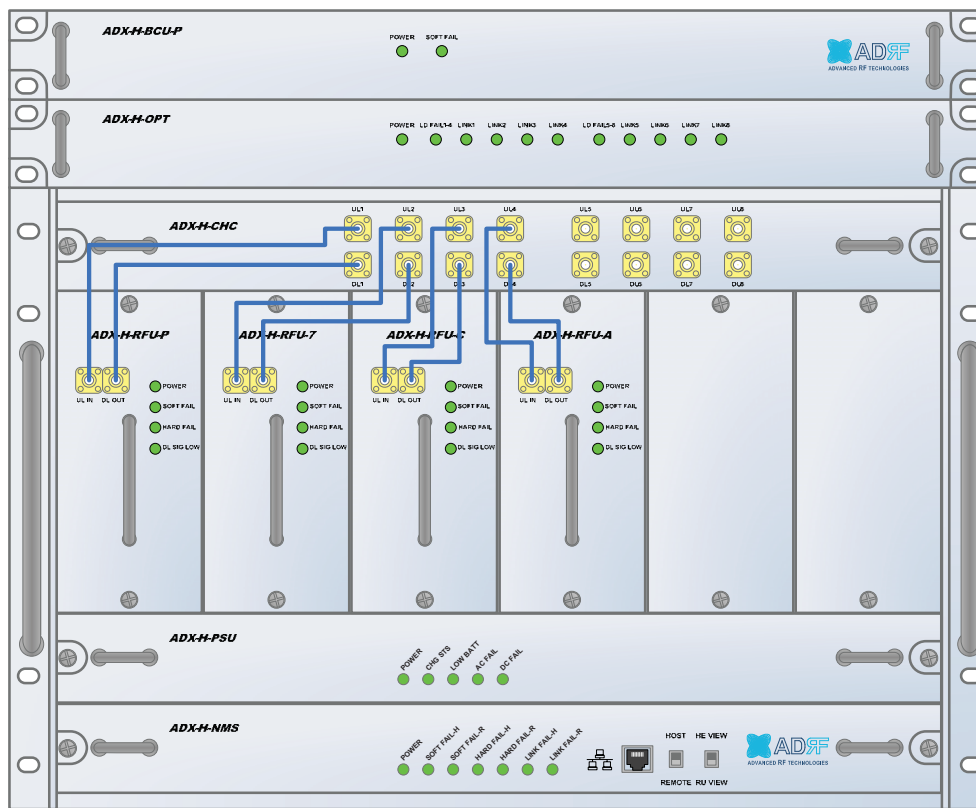

Figure 3-1 Head End Front View

3.1.1 NMS (Network Management System)

- Functions and features
 - Supports full SNMP v1,v2, and v3 (get, set & trap) and web-based GUI Interface.
 - Monitors alarms and status
 - Provides control interfaces with all subordinate modules
 - Provides overall DAS structure via the auto tree update function
- Spec
 - Size: 19.0 x 12.1 x 1.7 inches (482 x 307 x 44 mm)
 - Weight: 5.5 lbs (2.5 kg)

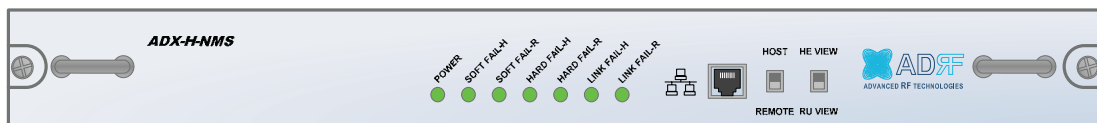

Figure 3-2 ADX-H-NMS Front View

3.1.1.1 LEDs

NMS has LEDs on the front panel as shown in Figure 3-3.



Figure 3-3 NMS LED

Table 3-1 NMS LED Specifications

ADX DAS-NMS		Specifications
Power	Solid Green	NMS power is ON
	OFF	NMS power is OFF
SOFT FAIL-H	Solid Yellow	HE Soft Fail alarm exists in the system
	Solid Green	No HE Soft Fail alarms are present in the system
SOFT FAIL-R	Solid Yellow	RU Soft Fail alarm exists in the system
	Solid Green	No RU Soft Fail alarms are present in the system
HARD FAIL-H	Solid Red	HE Hard Fail alarm exists in the system
	Solid Green	No HE Hard Fail alarms are present in the system
HARD FAIL-R	Solid Red	RU Hard Fail alarm exists in the system
	Solid Green	No RU Hard Fail alarms are present in the system
LINK FAIL-H	Solid Yellow	HE Link Fail alarm exists in the system
	Solid Green	No HE Link Fail alarms are present in the system
LINK FAIL-R	Solid Yellow	RU Link Fail alarm exists in the system
	Solid Green	No RU Link Fail alarms are present in the system

3.1.1.2 Ethernet Port

The Ethernet port can be used to communicate directly with the ADX DAS using a RJ-45 crossover cable or can also be used to connect the ADX DAS to an external modem box.



Figure 3-4 Ethernet Port

3.1.1.3 Host/Remote Switch

The Host/Remote Switch allows the user to switch the default Repeater IP, Subnet Mask, and Gateway of the repeater to an alternative setup. These settings can be adjusted by logging into the ADX DAS in HOST mode and configuring the settings under the Modem Box Setting section on the Install Page of NMS.

Once the settings are set, flipping the switch to the REMOTE position will reboot NMS module with the new alternate settings. *Please note that when the NMS is set to the REMOTE position, DHCP is disabled and the NMS will not automatically assign an IP address to any device that connects directly to the NMS.*

HOST



REMOTE

Figure 3-5 Host/Remote Switch

- Host IP: 192.168.63.1 (Fixed IP, unable to modify this IP address)
- Remote IP: 192.168.63.5 (Default IP, but can be modified in Host mode)

3.1.1.4 HE View/RU View Switch

The HE View/RU View Switch allows the user to be able to disable periodic monitoring operated by NMS. In the HE view mode, NMS monitors the status of all subordinate units connected to NMS periodically but when switched to RU view the NMS does not monitor the subordinate units. When the user goes to a RU and wants to monitor/control the HE, the user should set the NMS as RU view mode before going to the RU. If not, there might be some data collisions between the NMS and RU, which may prevent the user from properly monitoring or configuring the HE when at the RU. Consequently, the user should set as HE view mode when the user is at the HE and should set as RU view mode when the user is at the RU.

HE VIEW



RU VIEW

Figure 3-6 HE View/RU View Switch

3.1.2 R FU (ADX-H-RFU-x)

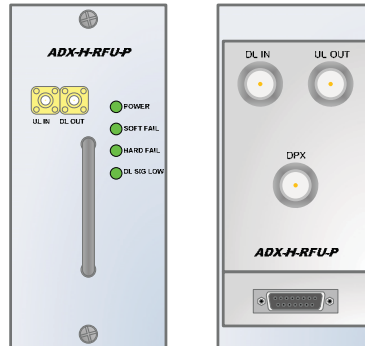

Figure 3-7 RFU Front & Rear View

- Functions and features
 - Provide RF interface with BTS or BDA
 - Each RFU has independent gain control and filtering
 - Modular type and Hot swappable
 - Supports duplex port or simplex TX & RX ports
 - Easily support additional frequency bands by adding a single RFU
 - Reduces complexity and overall equipment size
- Spec
 - Size: 12.8 x 6.2 x 2.8 inches (324 x 156.5 x 71.3 mm)
 - Weight: 7.3 lbs (3.3 kg)

3.1.2.1 L EDs

RFU has LEDs on the front panel as shown in Figure 3-8.

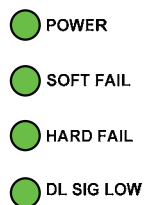

Figure 3-8 RFU LED

Table 3-2 RFU LED Specifications

ADX DAS-Module		Specifications
Power	Solid Green	Module power is ON.
	OFF	Module power is OFF.
Soft Fail	Solid Yellow	Soft Fail alarm exists in the RFU.
	Solid Green	No Soft Fail alarms are present in the RFU.
Hard Fail	Solid Red	Hard Fail alarm exists in the RFU.
	Solid Green	No Hard Fail alarms are present in the RFU.
DL SIG LOW	Solid Yellow	When DL input signal level is lower than the defined threshold level. (default threshold value: -5dBm)
	Solid Green	When DL input signal level is upper than the defined

		threshold level.
--	--	------------------

3.1.2.2 R F Ports

3.1.2.2.1 DL IN/UL OUT & DPX ports

DL IN/UL OUT & DPX Ports (refer to Figure 3-7) are located at the back of RFU and can be connected directly to the BDA or the BTS. A BCU can be used before inserting the signal into the RFU if multiple multiple BDA or BTS sources exist. The RFU can support an incoming signal strength from 0 to 25 dBm.

3.1.2.2.2 DL OUT/UL IN

DL OUT/UL IN Ports (refer to Figure 3-7) are located at the front of RFU and connect directly to the HE Channel Combiner (ADX-H-CHC).

3.1.2.3 C ommunication Port

ADX DAS-NMS monitors and controls a RFU via this port. DC Power is also provided to the RFU via this port.

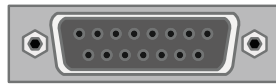

Figure 3-9 Communication Port (RFU)

3.1.3 C hannel Combiner (ADX-H-CHC)

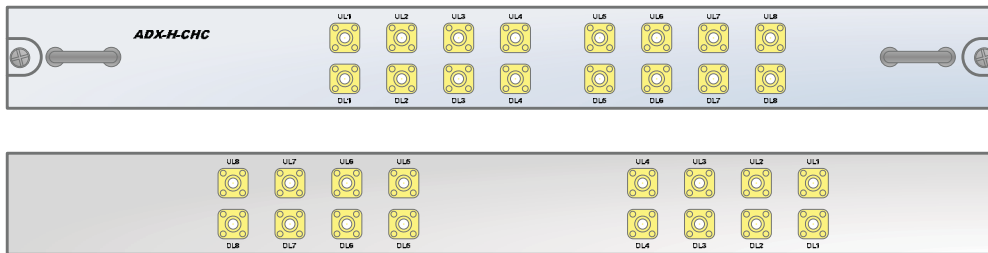

Figure 3-10 ADX-H-CHC Front & Rear View

- Functions & Features
 - Combines DL signals received from each RFU and divides to all connected RUs
 - Combines UL signals received from each RU and divides to all connected RFUs
 - Supports up to 8 RFUs and (4) ADX-H-OPT
- Spec
 - Size: 16.9 x 12.9 x 1.7 inches (430 x 327 x 44 mm)
 - Weight: 11.0 lbs (5.0 kg)

3.1.3.1 R F ports

3.1.3.1.1 RF ports at the front panel(DL 1 to DL 8, UL 1 to UL 8)

DL 1(to DL 8) & UL 1(to UL 8) RF ports are connected to DL OUT/UL IN Ports at the front panel of RFU.

- Receive the downlink signal from each RFU
- Split the uplink signal received from OPT to each RFU

3.1.3.1.2 RF ports at the back panel(DL 1 to DL 8, UL 1 to UL 8)

DL 1(to DL 8) & UL 1(to UL 8) RF ports are connected to DL IN/UL OUT Ports at the back panel of OPT.

- Transfer the combined downlink signals to OPT
- Receive the uplink signal from OPT

3.1.4 Opt ic Unit (ADX-H-OPT)

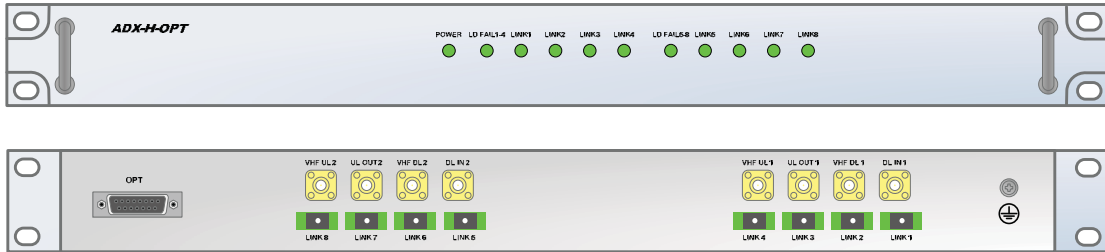

Figure 3-11 ADX-H-OPT Front & Rear View

- Functions & Features
 - Converts RF to optical signal and transports signals up to a maximum of 10Km (optical 5dBo loss including optical connection loss).
 - Supports up to (8) Master RUs
 - Minimizes the number of optical fiber cable needed by transporting multi band signals over a single strand of fiber using WDM technology.
- Spec
 - Size: 19.0 x 12.9 x 1.7 inches (482 x 327 x 44 mm)
 - Weight: 13.2 lbs (6.0 kg)

3.1.4.1 L EDs

The ADX-H-OPT has the following LEDs on the front panel as shown in Figure 3-12.



Figure 3-12 OPT LED

Table 3-3 OPT LED Specifications

ADX DAS-Module		Specifications
Power	Solid Green	Module power is ON
	OFF	Module power is OFF
LD FAIL 1-4/ LD FAIL 5-8	OFF	ODU is not installed
	Solid Yellow	LD Fail alarm exists in the ODU
	Solid Green	No LD Fail alarm is present in the ODU
LINK1 to LINK8	Solid Yellow	PD Fail alarm exists
	Solid Green	No PD Fail alarm is present

3.1.4.2 R F ports

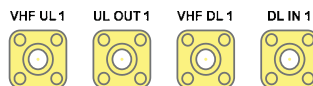

Figure 3-13 OPT RF Ports

3.1.4.2.1 DL IN/UL OUT

The combined downlink signal received from ADX-H-CHC is transferred to the DL IN 1(or 2) at the back of OPT.

UL OUT is connected to one port among UL 1 to UL 8 ports at the back panel of ADX-H-CHC.

3.1.4.2.2 VHF DL/VHF UL

VHF DL/UHF UL is used to support Public Safety in the VHF & UHF frequency band. VHF/UHF signals for Public Safety are not combined by ADX-H-CHC but VHF/UHF signals received from RFU for VHF/UHF are directly connected to the VHF DL/UHF UL port of OPT.

3.1.4.3 Opt ic ports



Figure 3-14OPT Optic Ports

One ADX-H-OPT has (8) optic ports and can support up to (8) Master RU's.

3.1.4.4 C ommunication Port

ADX-H-NMS monitors and controls a OPT via this port. DC Power is provided from the PSU to a OPT via this port.

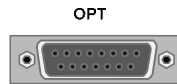

Figure 3-15Communication Port (OPT)

3.1.5 Power Supply Unit (ADX-H-PSU)

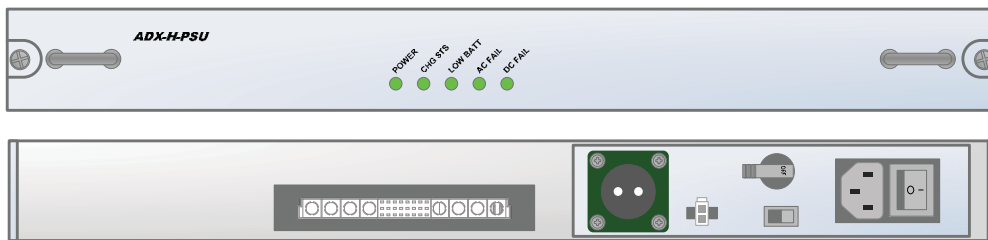

Figure 3-16ADX-H-PSU Front & Rear View

- Functions & Features
 - Capable of supplying power to 8 RFUs, 4 BCUs, 4 OPTs and NMS
 - Support Battery Backup via ADRF-BBU
- Spec
 - Size: 16.9 x 13.1 x 1.7 inches (430 x 332.7x 44 mm)
 - Weight: 7.7lbs (3.5 kg)
 - Power Input: 110V or 220VAC, selectable by switch

3.1.5.1 L EDs

ADX-H-PSU has the following LEDs on the front panel as shown in Figure 3-17.



Figure 3-17HE PSU LED

Table 3-4 HE PSU LED Specifications

ADX DAS-Module		Specifications
Power	Solid Green	Module power is ON
	OFF	Module power is OFF
CHG STS	Solid Yellow	No AC power is available and ADRF-BBU is being used
	Blinking Green	PSU is charging the ADRF-BBU
	Solid Green	ADRF-BBU is completely charged
	OFF	Battery is not connected
LOW BATT	Solid Yellow	Low Battery alarm exist in the PSU
	Solid Green	No Low Battery alarm is present in the PSU
AC FAIL	Solid Yellow	AC Fail alarm exists in the PSU
	Solid Green	No AC Fail alarm is present in the PSU
DC FAIL	Solid Yellow	DC Fail alarm exists in the RFU
	Solid Green	No DC Fail alarms is present in the PSU

3.1.5.2 AC Input On/Off Switch, AC Input Port and AC Input Selection Switch

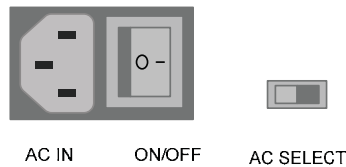

Figure 3-18 HE PSU AC Input On/Off Switch, AC Input Port and AC Input Selection Switch

The AC Power on/off switch is located at the back panel of HE PSU. HE PSU can be operated at the AC110V and AC220V input but AC Input Voltage should be selected properly through AC input voltage selection switch by the user.

3.1.5.3 Battery Backup Port, Battery Install Port and Battery Backup Switch

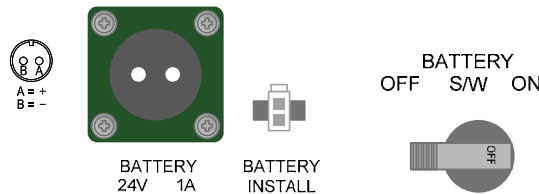

Figure 3-19 Battery Backup Port, Battery Install Port and Battery Backup Switch

The Battery Switch can be used to provide power to the optional External Backup Battery (ADRF-BBU) (Figure 3-19).

The HE PSU can be connected to an ADRF-BBU (ADRF Battery Backup Unit) to provide power during a power failure. If an ADRF-BBU is utilized, connect the ADRF-BBU to the HE PSU via the external battery backup port as shown in Figure 3-19.

(WARNING: The circuit switch on the ADRF-BBU must be set to OFF before connecting the ADRF-BBU to the HE PSU to prevent damage to the HE PSU or the ADRF-BBU and personal injury.)

Note: Please contact ADRF Technical Support for assistance if you are unfamiliar with the installation procedure of our battery box.

The Battery Install port is used to let NMS know if an ADRF-BBU is connected to the HE PSU or not. If an ADRF-BBU is connected without the cable connection to Battery Install port, the ADX-H-NMS will not detect the ADRF-BBU.

The procedure for connecting HE PSU to BBU

1. BATT S/W OFF
2. Connect ADRF-BBU to HE PSU Battery port and Battery Install port using HE battery cable
3. BATT S/W ON

3.1.6 Optional Band Combiner Unit (ADX-H-BCU-x)

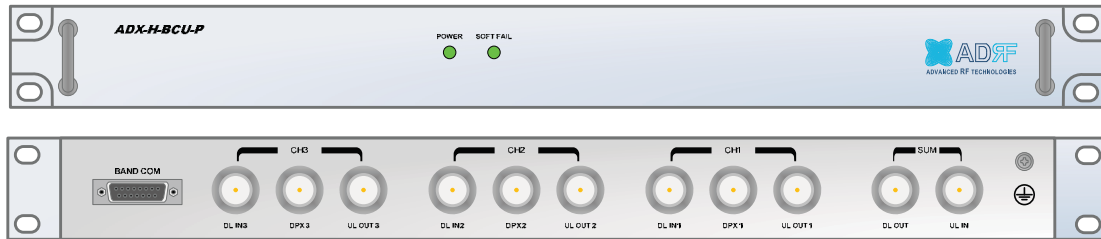

Figure 3-20 ADX-H-BCU Front & Rear View

- Functions & Features
 - Combines and balances up to 3 carriers' signals
 - Easily adds multiple carriers' signals without adding equipment
 - Reduces complexity and expansion costs to support multiple carriers' signals
- Spec
 - Size: 19.0 x 12.9 x 1.7 inches (482 x 327 x 44 mm)
 - Weight: 13.2 lbs (6.0 kg)

3.1.6.1 LEDs

BCU has LEDs on the front panel as shown in Figure 3-21.

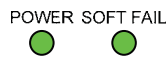

Figure 3-21 BCU LED

Table 3-5 BCU LED Specifications

ADX DAS-Module		Specifications
Power	Solid Green	Module power is ON
	OFF	Module power is OFF
Soft Fail	Solid Yellow	Soft Fail alarm exist in the RFU
	Solid Green	No Soft Fail alarms are present in the RFU

3.1.6.2 RF Ports

3.1.6.2.1 DL IN/UL OUT & DPX ports

DL IN/UL OUT & DPX Ports are located at the back of BCU and connect directly to the BDA or BTS.

3.1.6.2.2 DL OUT/UL IN

DL OUT/UL IN Ports are located on the back of BCU and connect directly to the RFU.

3.1.6.3 Communication Port

ADX-H-NMS monitors and controls a BCU via this port. DC Power is provided from PSU to a BCU via this port.

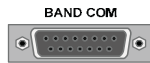

Figure 3-22 Communication Port (BCU)

3.1.7 Optional Optic Expansion Unit (ADX-H-OEU)

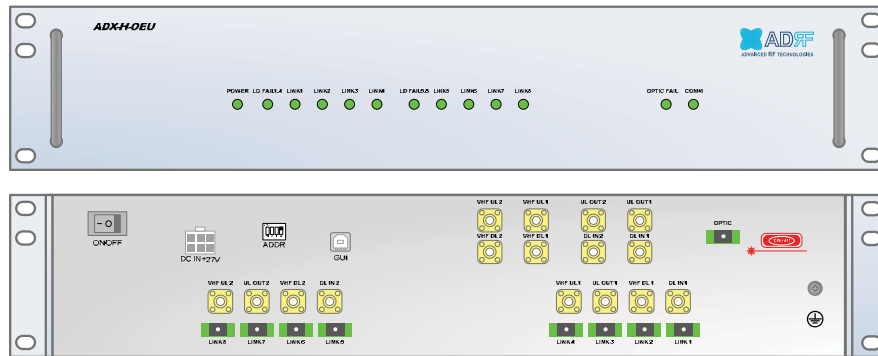

Figure 3-23 ADX-H-OEU Front & Rear View

- Functions & Features
 - Used to extend DAS coverage to other buildings
 - Drives up to (8) additional Master RUs
 - Provides DAS coverage in remote building with minimized equipment and minimum optic line
- Spec
 - Size: 19.0 x 12.8 x 3.5 inches (482 x 325 x 89 mm)
 - Weight: TBD lbs (TBD kg)
 - Power Input: 110VAC or -48VDC(optional)

3.1.7.1 L EDs

OEU has the following LEDs on the front panel as shown in Figure 3-12.



Figure 3-24 OPT LED

Table 3-6 OPT LED Specifications

ADX DAS-Module	Specifications	
Power	Solid Green	Module power is ON
	OFF	Module power is OFF
LD FAIL 1-4/ LD FAIL 5-8	OFF	ODU is not installed
	Solid Yellow	LD Fail alarm exist in the OEU
LINK1 to LINK8	Solid Green	No LD Fail alarm is present in the OEU
	Solid Yellow	PD Fail alarm exist
Optic Fail	Solid Green	No PD Fail alarm is present
	Solid Yellow	Optic Fail alarm exist in the OEU
COMM	Solid Green	No Optic Fail alarm is present in the OEU
	Solid Yellow	COMM Fail alarm exist in the OEU
	Solid Green	No COMM Fail alarm is present in the OEU

3.1.7.2 Opt ic ports

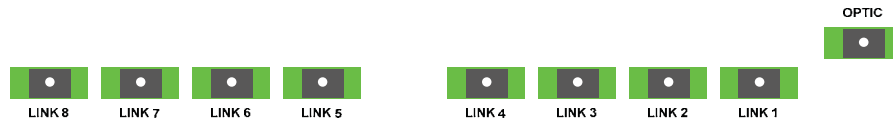

Figure 3-25 OEU Optic Ports

- OPTIC port
 - connected to OPT of HE
- LINK 1~8 ports
 - connected to extended RUs

3.1.7.3 DC Power Input port & GUI Port



Figure 3-26 DC Power Input Port & GUI Port

- DC IN Port
 - Connect DC output of AC/DC adaptor to the OEU's DC IN Port
- GUI Port
 - Connects to laptop via USB cable (32-bit/64-bit Windows only supported)
 - Used for internal purposes only

3.1.7.4 Power On/Off Switch & ADDR

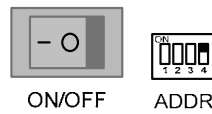

Figure 3-27 Power On/Off Switch & ADDR

- ON/OFF switch
 - OEU Power On/Off switch
- ADDR switch
 - The ID of OEU can be set manually using ADDR switch in case the ID of OEU is not correctly assigned automatically.

3.1.7.5 O EU Block Diagram

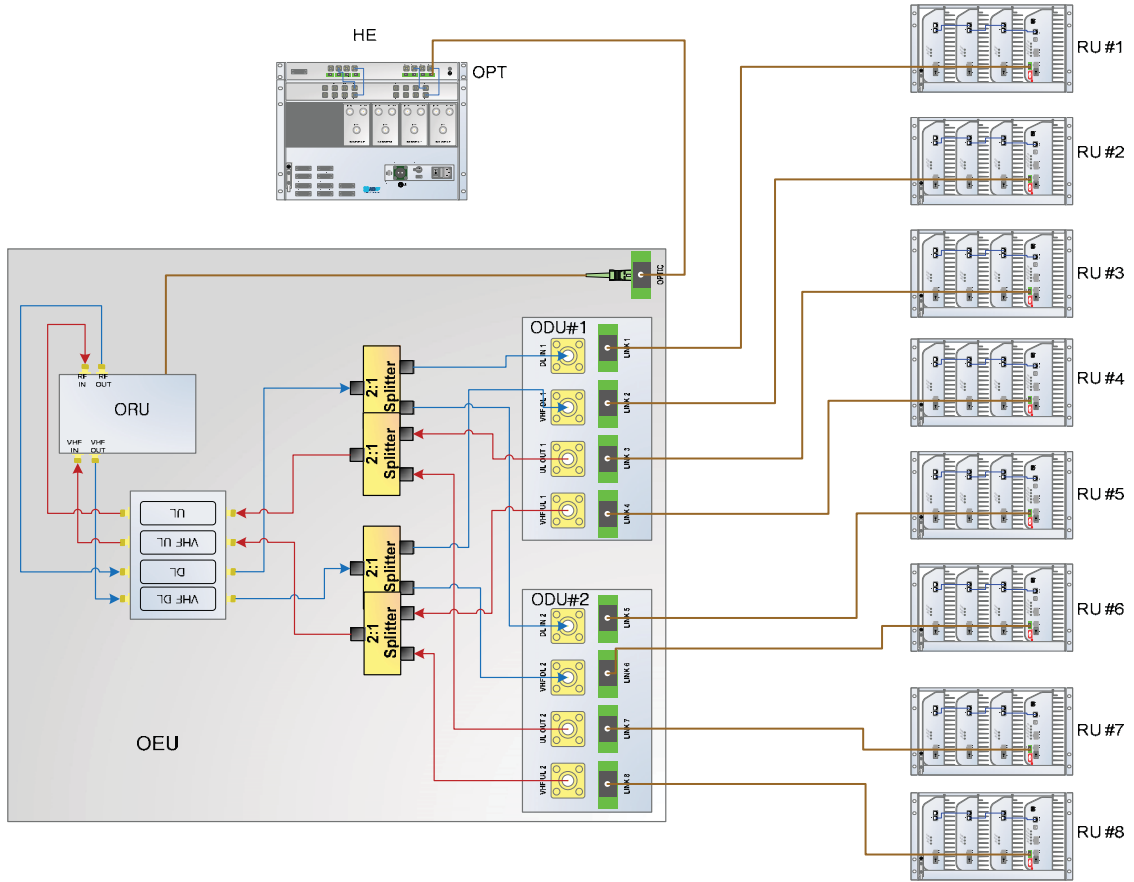

Figure 3-28 OEU Block Diagram

3.2 RU (ADX-R-x30M/S)

RU is composed of a (1) Master RU and up to (7) Slave RU's (use the use of ADX-R-4WS). A power supply, either the ADX-R-ADP (supports [1] Master/Slave RU) or ADX-R-PSU-30 (supports up to [8] Master/Slave RU) is required.

- Spec
 - Size: 19.0 x 12.9 x 10.5 inches (482 x 328.2 x 266.5 mm)
 - Weight: 61.0 lbs (27.7 kg)
 - Power Input: 110VAC or -48VDC(optional)
 - Battery Backup supported

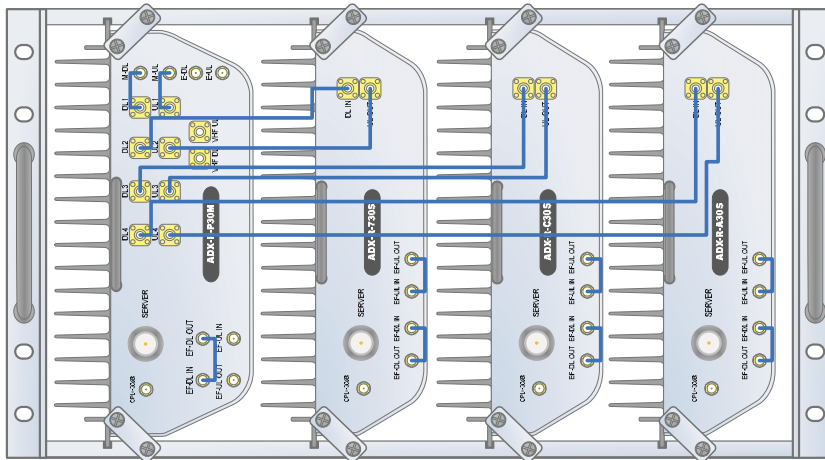

Figure 3-29RU Front View

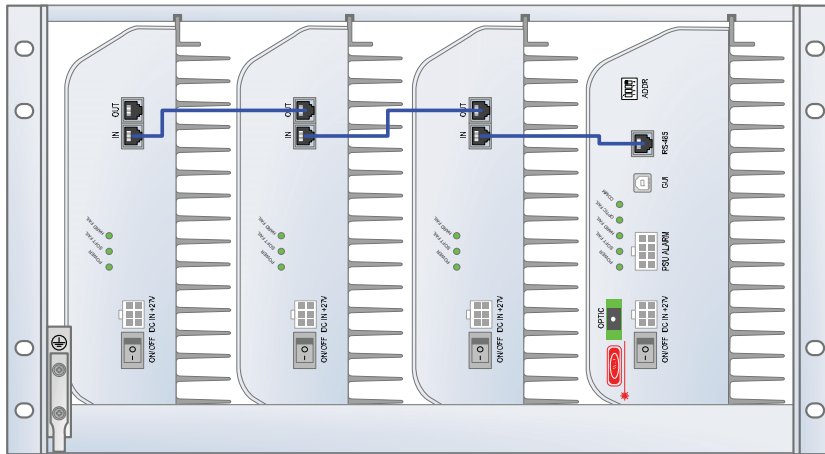

Figure 3-30RU Rear View

3.2.1 Master RU (ADX-R-x30M)

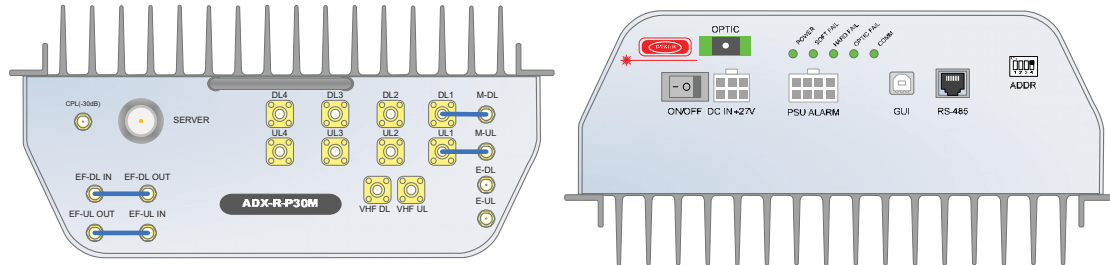

Figure 3-31 Master RU Front & Rear View

- Functions & Features
 - Converts optic signal into RF signal
 - Divides and provides RF signals to Slave RU
 - Transmits DL signal and receives UL signal through server antenna
 - Drive up to 7 slave RUs
 - Eliminate the need of fans by applying convection cooling structure for wall mount application
 - Efficiently solves out of band interference problems by supporting external filters
 - Easy to install and add RUs since each RU is independent and modular
- Spec
 - Size: 11.8 x 9.8 x 4.5 inches (300 x 249.6 x 114.5 mm)
 - Weight: 13.2 lbs (6.0 kg)

3.2.1.1 LEDs

Master RU's have the following LEDs on the front panel as shown in Figure 3-32.



Figure 3-32 Master RU LED

Table 3-7 Master RU LED Specifications

ADX DAS-Module		Specifications
Power	Solid Green	Module power is ON
	OFF	Module power is OFF
Soft Fail	Solid Yellow	Soft Fail alarm exists in the Master RU
	Solid Green	No Soft Fail alarms are present in the Master RU
Hard Fail	Solid Red	Hard Fail alarm exists in the Master RU
	Solid Green	No Hard Fail alarms are present in the Master RU
Optic Fail	Solid Yellow	Optic Fail alarm exists in the Master RU
	Solid Green	No Optic Fail alarm is present in the Master RU
COMM	Solid Yellow	COMM Fail alarm exists in the Master RU
	Solid Green	No COMM Fail alarm is present in the Master RU

3.2.1.2 R F Ports

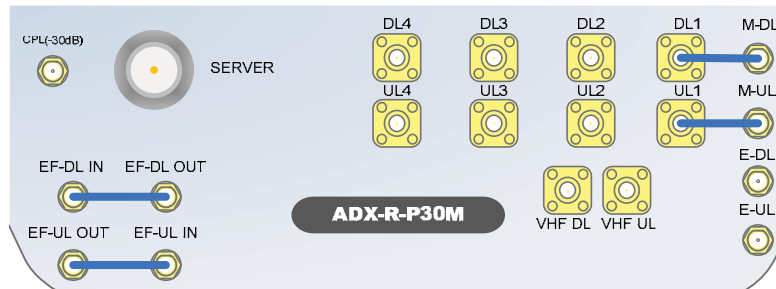

Figure 3-33RF Ports (Master RU)

3.2.1.2.1 M-DL/M-UL, DL1 to DL4 & UL1 to UL4

- M-DL/M-UL ports
 - Master RU units will come with the M-DL and M-UL ports pre-connected to the DL1 and UL1 ports.
- DL2 to DL4 & UL2 to UL4 ports
 - DL2 through DL4 and UL2 through UL4 ports are used to connect additional Slave RU units.

3.2.1.2.2 E- DL/E-UL

- Used to support additional (4) Slave RU units in addition to the (1) Master RU unit and (3) Slave RU units already being utilized
- An ADX-R-4WS is required if utilizing the E-DL/E-UL ports
- ADX-R-4WS divides the output of E-DL port to extended slave RUs and combines/transfers UL signal received from extended slave RUs to E-UL port. (refer to section 3.2.4, Figure 4-4)

3.2.1.2.3 VHF DL/VHF UL

- Used to support Slave RU for public safety service of VHF/UHF band (ADX-R-V30S)

3.2.1.2.4 SERVER & CPL

- Server Port
 - Connected to Server Antenna or RU channel combiner (ADX-R-CHC).
- CPL Port
 - 30dB coupling port of Server port.

3.2.1.2.5 EF-DL IN/EF-DL OUT & EF-UL IN/EF- UL OUT

- Can be connected to the DL/UL external filter
- DL external filter can be used to reduce DL out-band emissions
- UL external filter can be used to reduce out-band frequencies

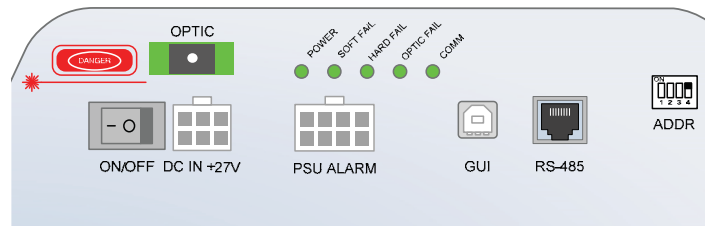

Figure 3-35 Ports at the back panel (Master RU)

3.2.1.3 Optic Port

- Connects to ADX-H-OPT via optic line

3.2.1.4 Power On/Off Switch & DC IN Port

- Power On/Off switch
 - Master RU Power On/Off switch
- DC IN Port
 - Connected to DC output port of AC/DC adaptor (ADX-R-ADP-30) or RU PSU (ADX-R-PSU-30)

3.2.1.5 PSU Alarm Port

- Connected to the ADX-R-PSU-30
- NMS & master RU can monitor the status of RU PSU via this port

3.2.1.6 GUI Port

- Connects to a laptop via USB cable
- Monitor/control the RU and the HE connected to the RU using User GUI, which is a Windows based program. ADRF 32-bit or 64-bit drivers will also be required to access the RU using the User GUI.

3.2.1.7 RS-485 Port

- Slave RU should be connected to master RU in a daisy chain structure using RS-485 line to monitor and control slave RUs.
- The RS-485 cable connected to master RU should be connected to RS-485 IN port of slave RU. When a slave RU is connected to another slave RU, then the RS-485 cable should be connected from the RS-485 OUT port to the RS-485 IN of the 2nd Slave RU. (Figure 3-36)
- If RS-485 port connections between sub RUs are not correct, master RU will not be able to recognize all subordinate slave RUs. (Figure 3-37)
- **WARNING! The RS-485 ports should NEVER be connected to the Ethernet port of laptop or Ethernet Network Equipment. Doing so may cause serious damage to the sub RUs or network equipments. (Figure 3-38)**

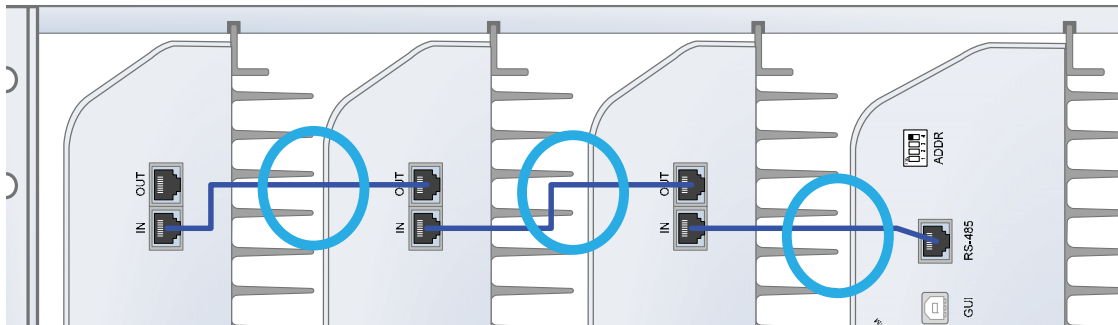

Figure 3-36 Correct RS-485 connection between Master RU and Slave RU or between Slave RUs

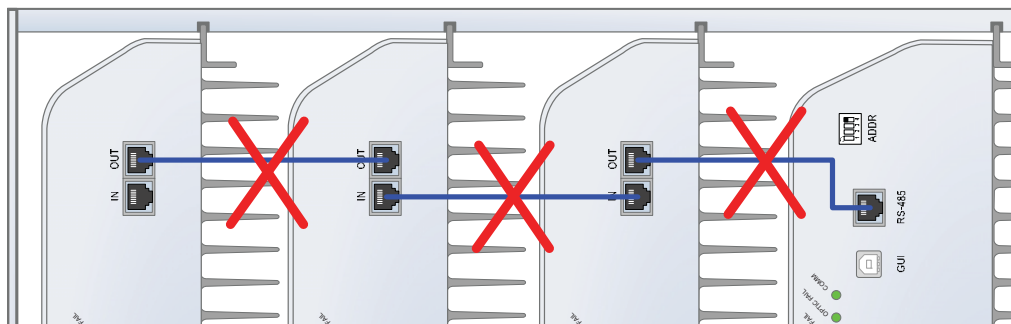
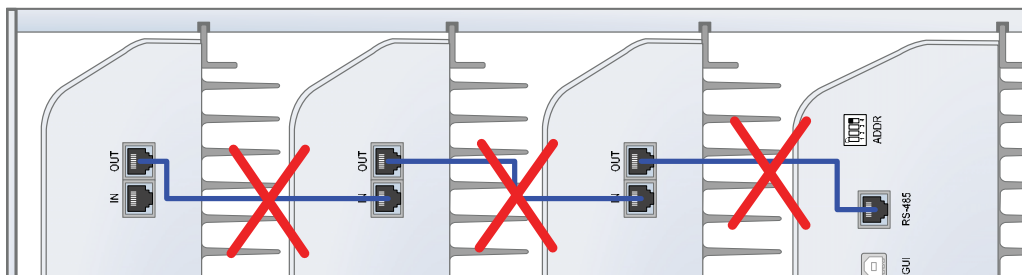

Figure 3-37 Wrong RS-485 connection between Master RU and Slave RU or between Slave RUs

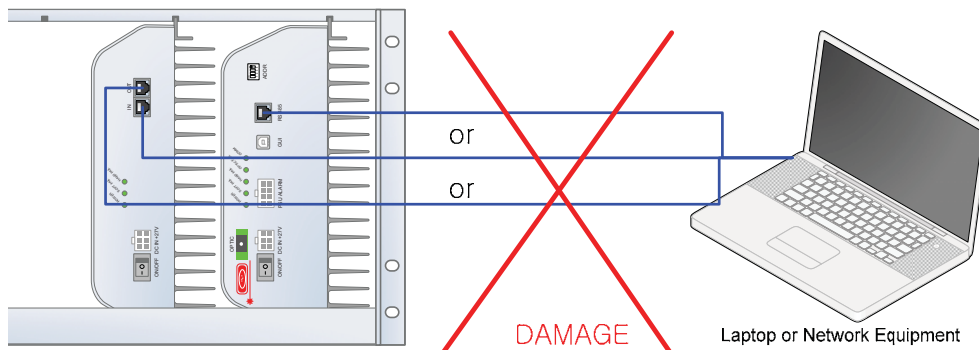

Figure 3-38 Do NOT connect RS-485 ports of Sub RU to network equipment port

3.2.1.8 A DDR

- The ID of master RU can be set manually using ADDR switch. This switch should only be use if instructed by ADRF Technical Support.

3.2.2 Slave RU (ADX-R-x30S)

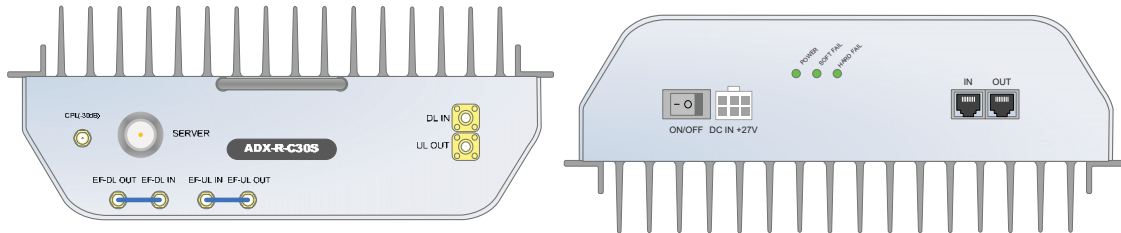

Figure 3-39 Slave RU Front & Rear View

- Functions & Features
 - Transmits DL signal and receives UL signal through server antenna port
 - Eliminate the need for fans by applying convection cooling structure for wall mount application
 - Efficiently solves out of band interference problems by supporting external filter
 - Easy to install and add RUs since each RU is independent and modular
- Spec
 - Size: 11.8 x 9.8 x 3.7 inches (300 x 249.6 x 94.5 mm)
 - Weight: 11.7 lbs (5.3 kg)

3.2.2.1 L EDs

ADX DAS has the following LEDs on the front of the Slave RU as shown below in Figure 3-32.



Figure 3-40 Slave RU LED

Table 3-8 Slave RU LED Specifications

ADX DAS-Module		Specifications
Power	Solid Green	Module power is ON
	OFF	Module power is OFF
Soft Fail	Solid Yellow	Soft Fail alarm exists in the Slave RU
	Solid Green	No Soft Fail alarms are present in the Slave RU
Hard Fail	Solid Red	Hard Fail alarm exists in the Slave RU
	Solid Green	No Hard Fail alarms are present in the Slave RU

3.2.2.2 R F Ports

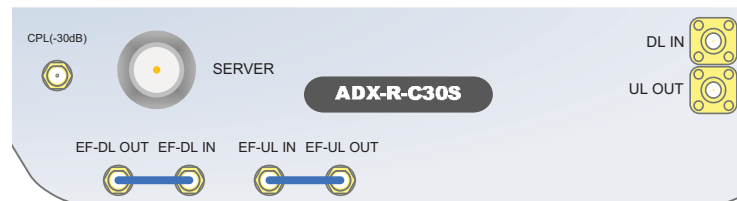

Figure 3-41 RF Ports (Slave RU)

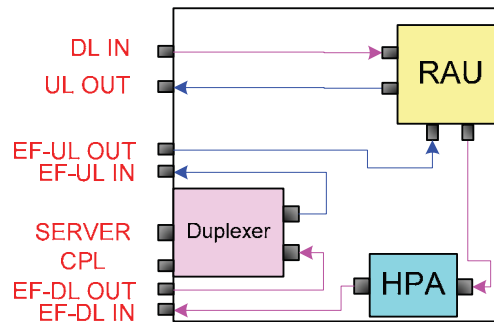

Figure 3-42 Slave RU block Diagram and RF Port Name

3.2.2.2.1 DL IN & UL OUT

- Connects to one of the available DL 2 to 4/UL 2 to 4 ports of master RU
- DL IN port receives the divided DL output of master RU
- UL OUT port transfers the UL output of slave RU to master RU

3.2.2.2.2 SERVER & CPL

- Server Port
 - Connects to a Server Antenna or RU channel combiner (ADX-R-CHC)
- CPL Port
 - 30dB coupling port from the Server port

3.2.2.2.3 EF-DL IN/EF-DL OUT & EF-UL IN/EF- UL OUT

- Can be connected to the DL/UL external filter
- DL external filter can be used to reduce out-band emissions
- UL external filter can be used to reduce uplink out-band signals



Figure 3-43 Ports at the rear panel (Slave RU)

3.2.2.3 Power On/Off Switch & DC IN Port

- Power On/Off switch
 - Slave RU Power On/Off switch
- DC IN Port
 - Connected to DC output port of AC/DC adaptor (ADX-R-ADP-30) or RU PSU (ADX-R-PSU-30)

3.2.2.4 R S-485 Port

- Slave RU is connected to master RU or other slave RU in a daisy chain structure using RS-485 line to monitor and control slave RUs.
- The RS-485 cable connected to master RU should be connected to RS-485 IN port of slave RU. When a slave RU is connected to another slave RU, then the RS-485 cable should be connected from the RS-485 OUT port to the RS-485 IN of the 2nd Slave RU. (Figure 3-36)
- If RS-485 port connections between sub RUs are not correct, master RU will not be able to recognize all subordinate slave RUs. (Figure 3-37)
- **WARNING! The RS-485 ports should NEVER be connected to the Ethernet port of laptop or Ethernet Network Equipment. Doing so may cause serious damage to the sub RUs or network equipments. (Figure 3-38)**

3.2.3 RU Power Supply Options

3.2.3.1 RU Power Adapter (ADX-R-ADP)

One power adapter can support up to (1) sub-RU.

3.2.3.2 RU PSU (ADX-R-PSU-30)

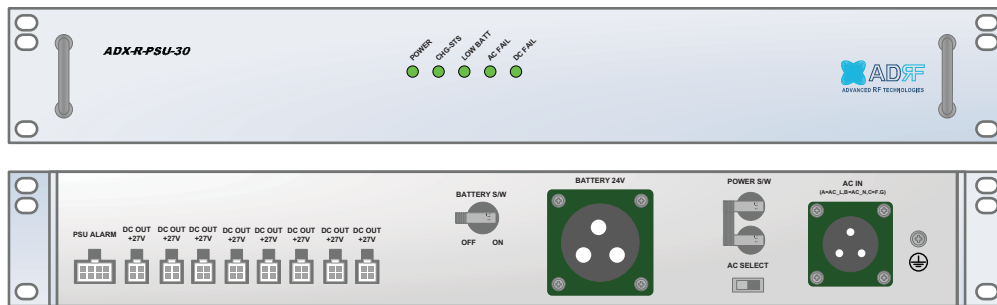

Figure 3-44RU PSU Front & Rear View

- Functions & Features
 - Capable of supplying power to 8 Sub Rus (Master/Slave RU)
 - Support Battery Backup (24V DC output)
- Spec
 - Size: 19.0 x 12.0 x 2.6 inches (482 x 304x 66 mm)
 - Weight: 9.9lbs (4.5 kg)
 - Power Input: 110V or 220VAC, selectable by switch

3.2.3.3 L EDs

ADX DAS has the following LEDs on the front of the RU PSU as shown below in Figure 3-45.



Figure 3-45RU PSU LED

Table 3-9 RU PSU LED Specifications

ADX DAS-Module		Specifications
Power	Solid Green	Module power is ON
	OFF	Module power is OFF
CHG STS	Solid Yellow	No AC power detected and ADRF-BBU is being used
	Blinking Green	ADRF-BBU is being charged
	Solid Green	Completely Charged
	OFF	Battery is not connected
LOW BATT	Solid Yellow	Low Battery alarm exist in the PSU
	Solid Green	No Low Battery alarm is present in the PSU
AC FAIL	Solid Yellow	AC Fail alarm exist in the PSU
	Solid Green	No AC Fail alarm is present in the PSU
DC FAIL	Solid Yellow	DC Fail alarm exist in the RFU
	Solid Green	No DC Fail alarms is present in the PSU

3.2.3.4 AC Input On/Off Switch, AC Input Port and AC Input Selection Switch

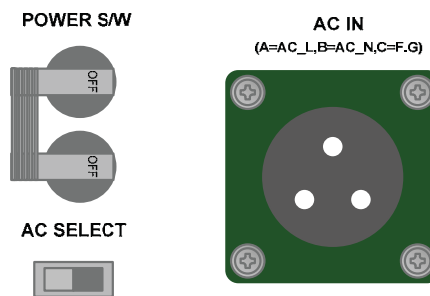

Figure 3-46RU PSU Power Switch View

The AC Power on/off switch is located at the back panel of ADX-R-PSU-30. The ADX-R-PSU-30 can be operated at the AC110V and AC220V input but AC Input Voltage should be selected properly through AC input voltage selection switch by the user.

3.2.3.5 Battery Backup Port and Battery Backup Switch

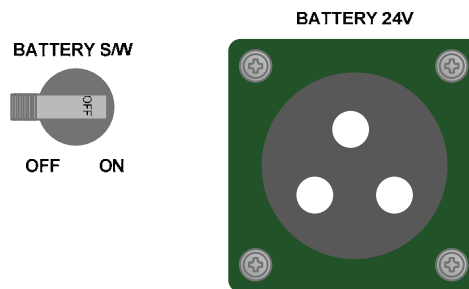

Figure 3-47Battery Backup Port & Battery Backup Switch

The Battery Switch can be used to provide power to the optional ADRF-BBU (External Backup Battery) (Figure 3-47).

The RU PSU can be connected to an ADRF-BBU (ADRF Battery Backup Unit) to provide power during a power failure. If an ADRF-BBU is utilized, connect the ADRF-BBU to the RU PSU via the external battery backup port as shown in Figure 3-47.

(WARNING: The circuit switch on the ADRF-BBU must be set to OFF before connecting the ADRF-BBU to the HE PSU to prevent damage to the HE PSU or the ADRF-BBU and personal injury.)

Note: Please contact ADRF Technical Support for assistance if you are unfamiliar with the installation procedure of our battery box.

The procedure for connecting RU PSU to BBU

1. BATT S/W OFF
2. Connect BBU to RU PSU Battery port using RU battery cable
3. BATT S/W ON

3.2.3.6 DC Output Port

DC OUT
+27V



Figure 3-48 DC Output Port (RU PSU)

- The number of DC output port: 8
- DC Output Ports provide DC Power up to 8 Sub RUs.

3.2.3.7 P SU Alarm Port

PSU ALARM



Figure 3-49 PSU Alarm Port (RU PSU)

- Connects to master RU
- NMS & master RU can monitor the status of the ADX-R-PSU-30 via this port.

3.2.4 Optional 4-Way Combiner (ADX-R-4WS)



Figure 3-50 ADX-R-4WS Front View

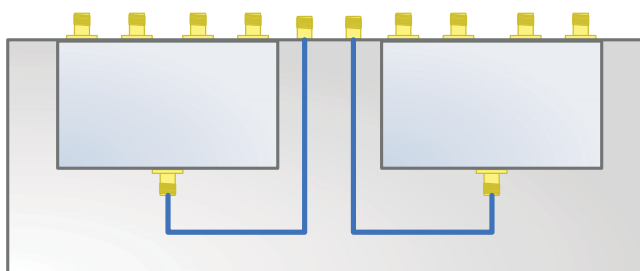

Figure 3-51 ADX-R-4WS Inner View

- ADX-R-4WS is required when more than 4 sub-RU's are being used
- ADX-R-4WS connects to E-DL/E-UL port of master RU
- ADX-R-4WS divides the output of E-DL port into extended slave RUs

- ADX-R-4WS combines/transfers UL signal received from extended slave RUs to E-UL port (refer to Figure 4-4)

4. C ABLE CONNECTION

4.1 Head End Connection Diagrams

4.1.1 Front/Rear Head End Connection View with Optional BCU unit

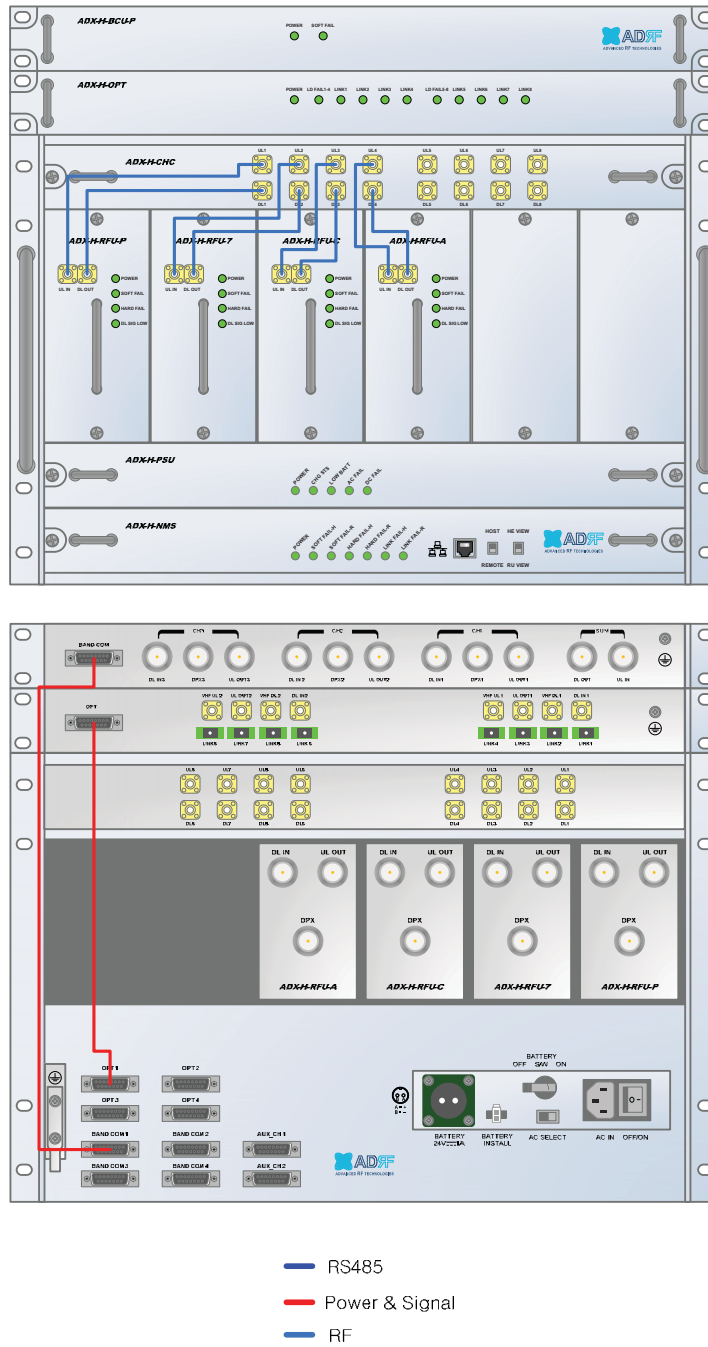

Figure 4-1 HE Cable connection (1 OPT+1 BCU)

4.1.2 Rear Head End Connection View with (4) OPT units

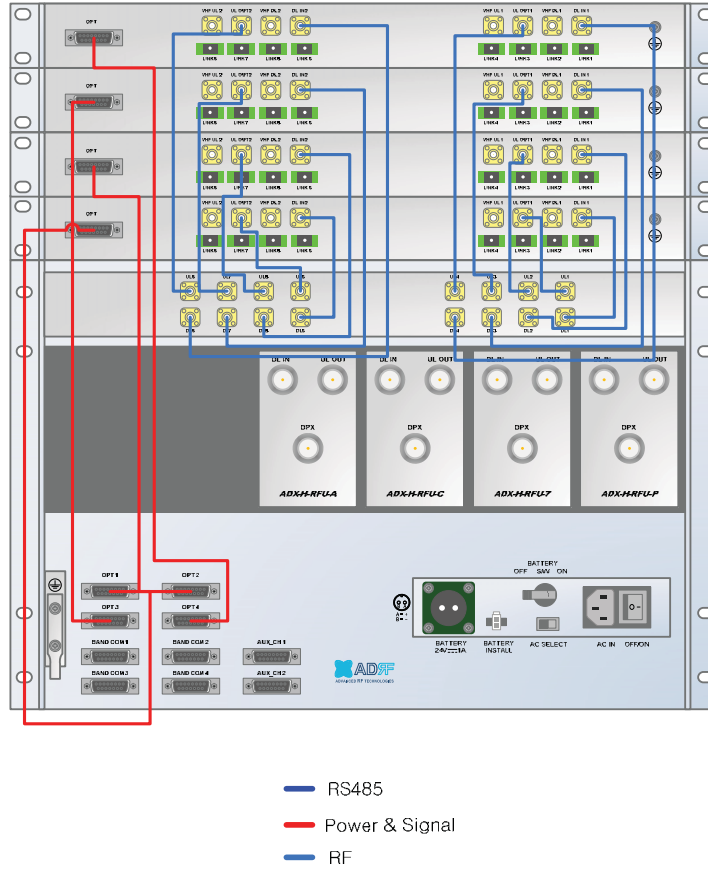

Figure 4-2 HE Cable connection (4 OPTs)

4.2 Remote Unit Connection Diagrams

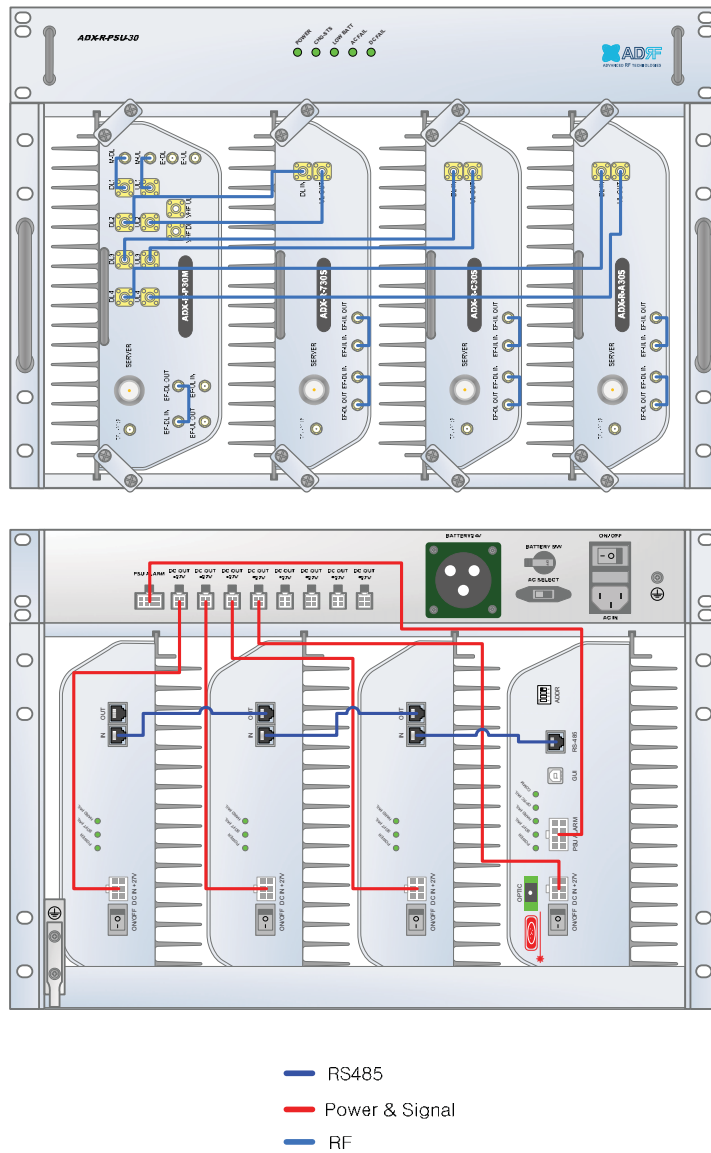

Figure 4-3 RU Cable connection (4 Sub RU + RU PSU)

4.3 Remote Unit w/ 4-Way Combiner (ADX-R-4WS)

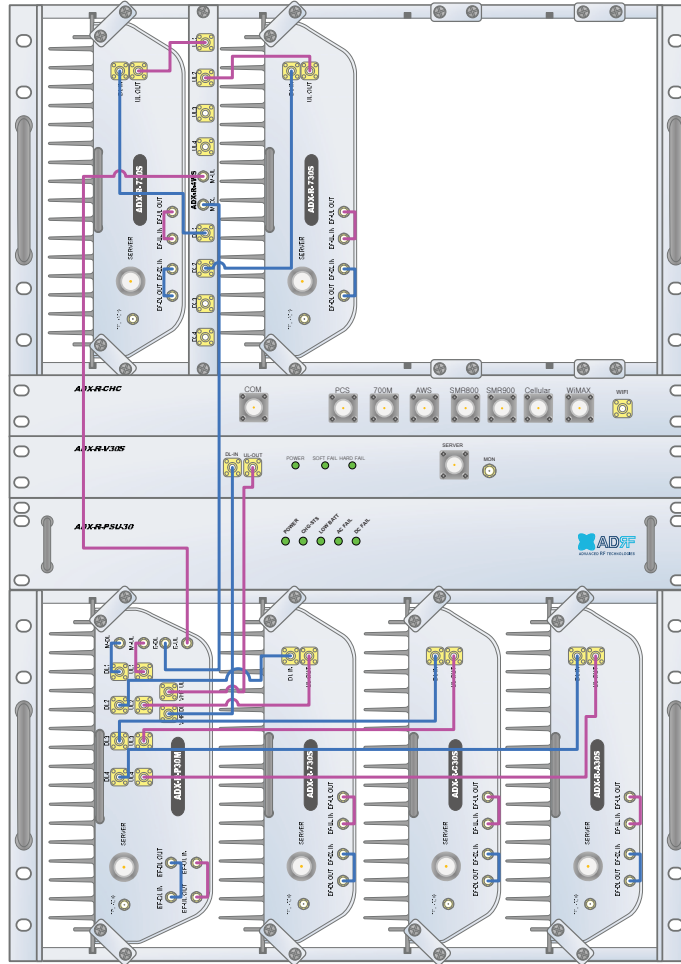

Figure 4-4 Slave RU Expansion using ADX-R-4WS

5. MOUNTIN G METHOD

5.1 Head End

5.1.1 Rack Mount

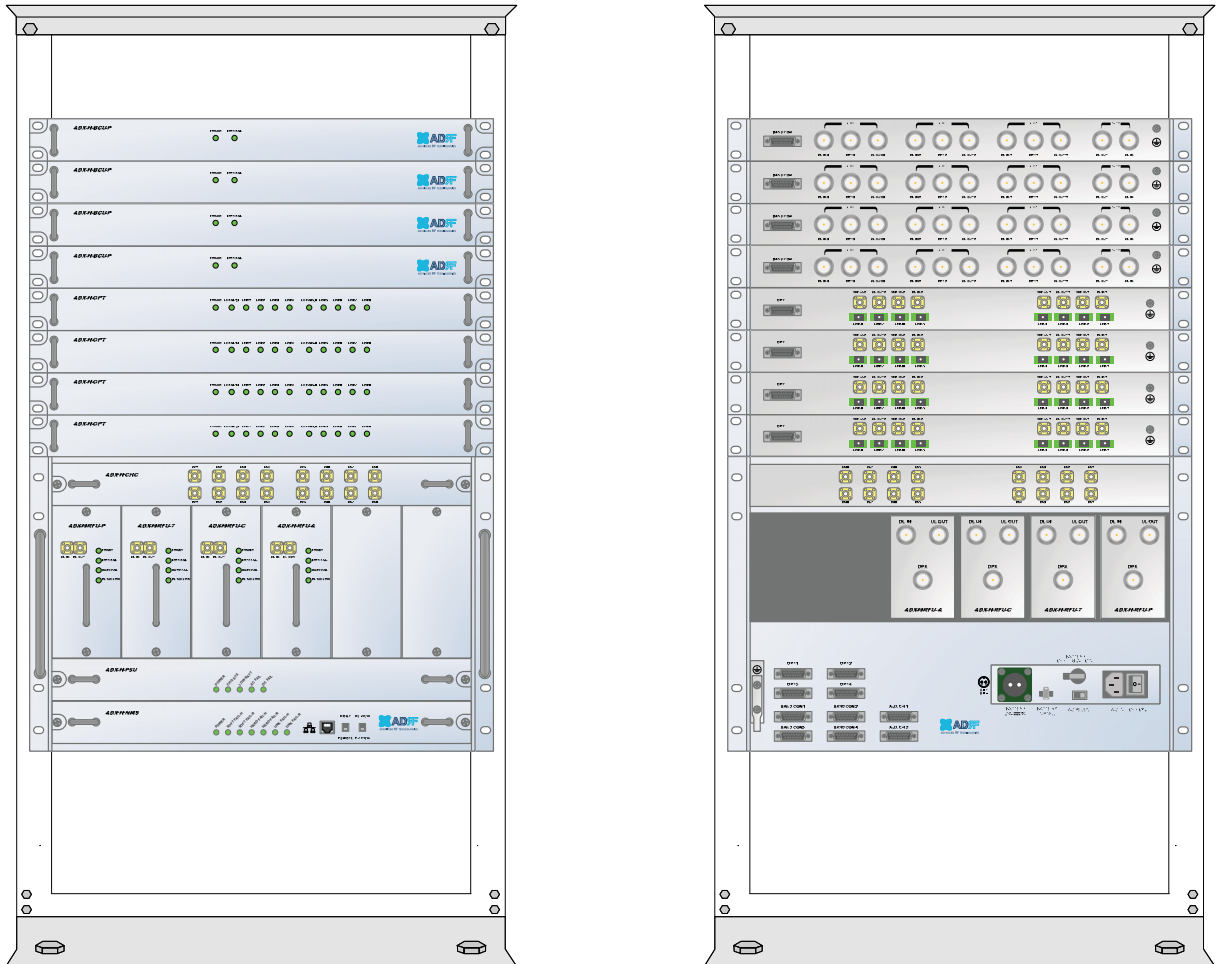

Figure 5-1 HE Rack Mount (Front & Rear view)

- Expandable up to 4 OPTs, 4 BCUs and 2 AUX CHs

5.1.2 W all Mount

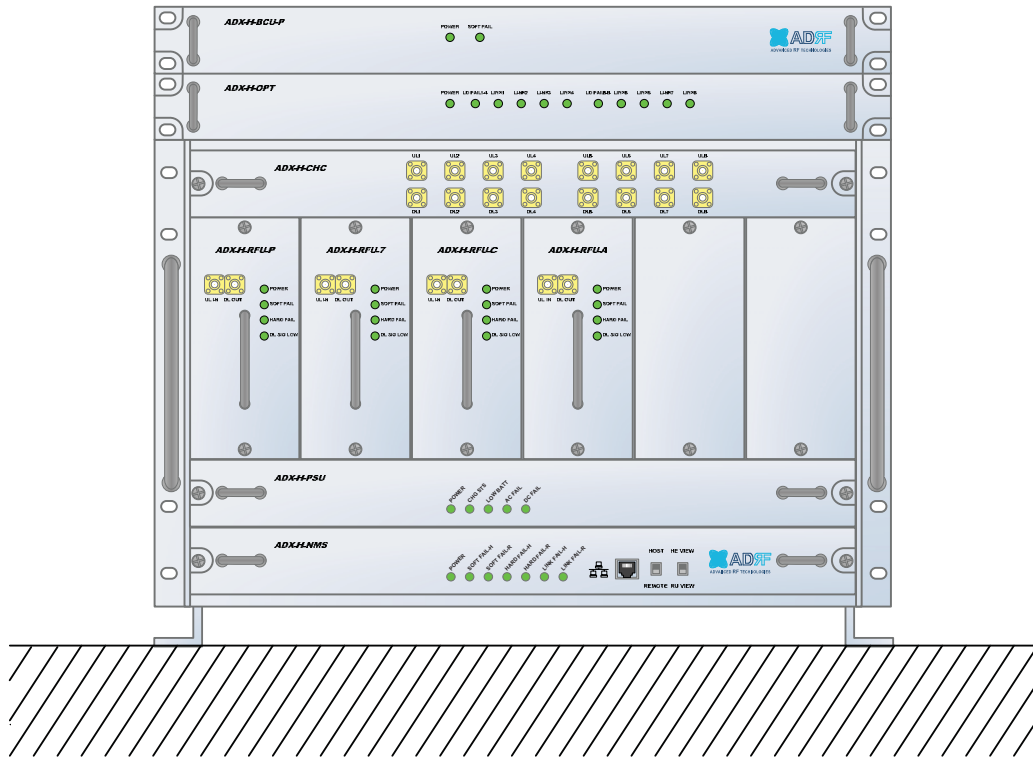

Figure 5-2 HE Wall Mount (Top View)

- Expandable up to 3 units (OPT, BCU) or max 3U (132mm)
 - OPT or BCU will be stacked up above basic 19" HE chassis which includes NMS, RFU, PSU and CHC

5.2 Remote Unit
5.2.1 Rack Mount

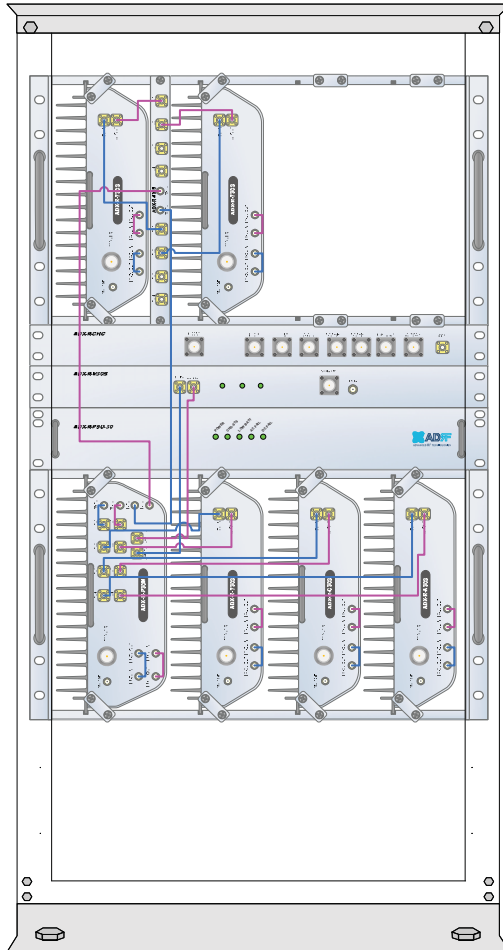
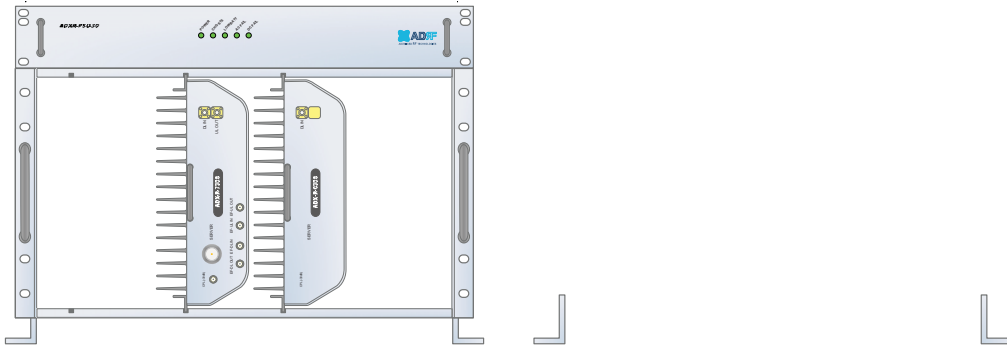

Figure 5-3 RU Rack Mount (Front view)

5.2.2 Wall Mount

5.2.2.1 Remote Unit using RU Chassis (ADX-R-CHA-30)

Wall mount brackets attached to the individual Sub-RU's must be removed before installing Sub-RU's to the RU Chassis.



IC Warning

This device complies with Industry Canada licence-exempt RSS standard(s).

Operation is subject to the following two conditions: (1) this device may not cause interference, and

(2) this device must accept any interference, including interference that may cause undesired operation of the device.

Le présent appareil est conforme aux CNR d'Industrie Canada applicables aux appareils radio exempts de licence.

L'exploitation est autorisée aux deux conditions suivantes : (1) l'appareil ne doit pas produire de brouillage, et

The users manual or instruction manual for an intentional or unintentional radiator shall caution the user that changes or modifications not expressly approved by the party responsible for compliance could void the user's authority to operate the equipment.

1. SPECIFICATION

Parameters		ADX-R-730S		ADX-R-C30S	ADX-R-P30M	ADX-R-A30S
Frequency	Downlink	Lower A	728–734MHz	869–894MHz	1930–1995MHz	2110–2155MHz
		Lower B	734–740MHz			
		Upper C	746–757MHz			
	Uplink	Lower A	698–704MHz	824–849MHz	1850–1915MHz	1710–1755MHz
		Lower B	704–710MHz			
		Upper C	776–787MHz			
Input Power Range		0~+25dBm				
Gain	Downlink	5~30dB				
	Uplink	-15~20dB				
Maximum Output Power		30dBm(composite)				
Noise Figure		< 20dB@maximum gain				
VSWR		< 1:1.5				
EVM		< 12.5%				
Optical Loss		0~5dBo				
System Delay		< 2us				
Spurious		Meet FCC rules, 3GPP TS 36.104, 3GPP2 C.S0010-C				
Dimension (WXDXH)	Head-End Shelf	19.0 x 14.6 x 12.2 inches (482 x 370 x 311 mm)				
	Remote-Unit Shelf	19.0 x 12.9 x 10.5 inches (482 x 328.2 x 266.5 mm)				
	Master RU	11.8 x 9.8 x 4.5 inches (300 x 249.6 x 114.5 mm)				
	Slave RU	11.8 x 9.8 x 3.7 inches (300 x 249.6 x 94.5 mm)				
Weight	Head-End Shelf	83.7 lbs (38.0 Kg) @4 RFU, CHC-H, PSU and NMS				
	Remote-Unit Shelf	61.0 lbs (27.7 kg) @ 1 master RU, 3 Slave RU				
	Master RU	13.2 lbs (6.0 kg)				
	Slave RU	11.7 lbs (5.3 kg)				
Operating Temperature		14–122 F(-10–50°C)				
Operating Humidity		5~90%RH				
Power Input		110/220V, 50–60Hz or -48V DC(optional)				
Power consumption	Head-End	55W@4 RFU, 1 OPT and NMS				
		28W@1 RFU, 1 OPT and NMS				
	Remote-Unit	230W@ 1 Master RU, 3 Slave RU				
		70W@ 1 Master RU or 1 Slave RU				
Network Management System		Ethernet(RJ45)				
RF connector	Head-End	N-type(Female)				
	Remote-Unit	N-type(Female)				