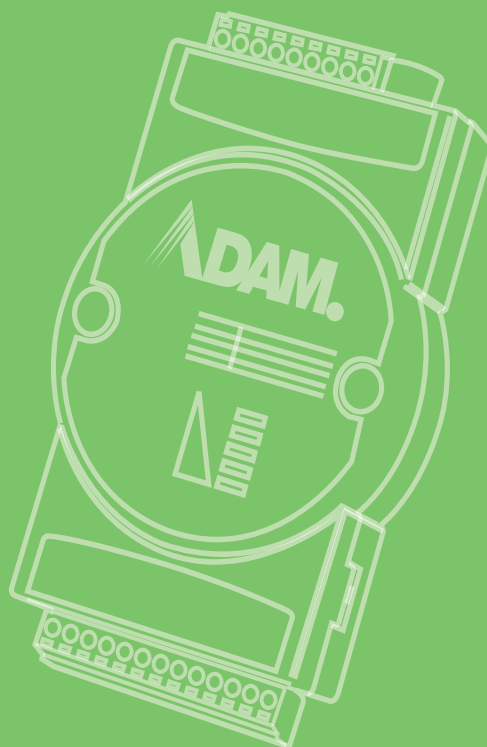


**User Manual**



## **ADAM-2000 Series**

**Wireless Sensor Network Data  
Acquisition Modules**

**ADVANTECH**

**eAutomation**

---

## Copyright

The documentation and the software included with this product are copyrighted 2006 by Advantech Co., Ltd. All rights are reserved. Advantech Co., Ltd. reserves the right to make improvements in the products described in this manual at any time without notice. No part of this manual may be reproduced, copied, translated or transmitted in any form or by any means without the prior written permission of Advantech Co., Ltd. Information provided in this manual is intended to be accurate and reliable. However, Advantech Co., Ltd. assumes no responsibility for its use, nor for any infringements of the rights of third parties, which may result from its use.

## Acknowledgements

Intel and Pentium are trademarks of Intel Corporation.

Microsoft Windows and MS-DOS are registered trademarks of Microsoft Corp.

All other product names or trademarks are properties of their respective owners.

## Product Warranty (2 years)

Advantech warrants to you, the original purchaser, that each of its products will be free from defects in materials and workmanship for two years from the date of purchase.

This warranty does not apply to any products which have been repaired or altered by persons other than repair personnel authorized by Advantech, or which have been subject to misuse, abuse, accident or improper installation. Advantech assumes no liability under the terms of this warranty as a consequence of such events.

Because of Advantech's high quality-control standards and rigorous testing, most of our customers never need to use our repair service. If an Advantech product is defective, it will be repaired or replaced at no charge during the warranty period. For out-of-warranty repairs, you will be billed according to the cost of replacement materials, service time and freight. Please consult your dealer for more details.

If you think you have a defective product, follow these steps:

1. Collect all the information about the problem encountered. (For example, CPU speed, Advantech products used, other hardware and software used, etc.) Note anything abnormal and list any onscreen messages you get when the problem occurs.
2. Call your dealer and describe the problem. Please have your manual, product, and any helpful information readily available.
3. If your product is diagnosed as defective, obtain an RMA (return merchandise authorization) number from your dealer. This allows us to process your return more quickly.
4. Carefully pack the defective product, a fully-completed Repair and Replacement Order Card and a photocopy proof of purchase date (such as your sales receipt) in a shippable container. A product returned without proof of the purchase date is not eligible for warranty service.
5. Write the RMA number visibly on the outside of the package and ship it prepaid to your dealer.

Part No. 2003D01100

Printed in Taiwan

Edition 1

January 2012

# Declaration of Conformity

## FCC

This equipment has been tested and found to comply with the limits for a Class B digital device, pursuant to part 15 of the FCC Rules. These limits are designed to provide reasonable protection against harmful interference in a residential installation. This equipment generates, uses and can radiate radio frequency energy and, if not installed and used in accordance with the instructions, may cause harmful interference to radio communications. However, there is no guarantee that interference will not occur in a particular installation. If this equipment does cause harmful interference to radio or television reception, which can be determined by turning the equipment off and on, the user is encouraged to try to correct the interference by one or more of the following measures:

- Reorient or relocate the receiving antenna.
- Increase the separation between the equipment and receiver.
- Connect the equipment into an outlet on a circuit different from that to which the receiver is connected.
- Consult the dealer or an experienced radio/TV technician for help.

## CE

This product has passed the CE test for environmental specifications when shielded cables are used for external wiring. We recommend the use of shielded cables. This kind of cable is available from Advantech. Please contact your local supplier for ordering information.

## CE

This product has passed the CE test for environmental specifications. Test conditions for passing included the equipment being operated within an industrial enclosure. In order to protect the product from being damaged by ESD (Electrostatic Discharge) and EMI leakage, we strongly recommend the use of CE-compliant industrial enclosure products.

## Technical Support and Assistance

1. Visit the Advantech web site at [www.advantech.com/support](http://www.advantech.com/support) where you can find the latest information about the product.
2. Contact your distributor, sales representative, or Advantech's customer service center for technical support if you need additional assistance. Please have the following information ready before you call:
  - Product name and serial number
  - Description of your peripheral attachments
  - Description of your software (operating system, version, application software, etc.)
  - A complete description of the problem
  - The exact wording of any error messages

---

## Warnings, Cautions and Notes

**Warning!** Warnings indicate conditions, which if not observed, can cause personal injury!



**Caution!** Cautions are included to help you avoid damaging hardware or losing data. e.g.



There is a danger of a new battery exploding if it is incorrectly installed. Do not attempt to recharge, force open, or heat the battery. Replace the battery only with the same or equivalent type recommended by the manufacturer. Discard used batteries according to the manufacturer's instructions.

**Note!** Advantech reserves the right to change this manual at any time without notice.



## Document Feedback

To assist us in making improvements to this manual, we would welcome comments and constructive criticism. Please send all such - in writing to: [support@advantech.com](mailto:support@advantech.com)

## Packing List

Before setting up the system, check that the items listed below are included and in good condition. If any item does not accord with the table, please contact your dealer immediately.

- 1x ADAM-2000 Series Device
- 1x 2dBi Antenna (ADAM-2520Z, ADAM-2510Z, ADAM-2051PZ only)
- 2 x Mounting Kits
- 1x CD

## Safety Instructions

1. Read these safety instructions carefully.
2. Keep this User Manual for later reference.
3. Disconnect this equipment from any AC outlet before cleaning. Use a damp cloth. Do not use liquid or spray detergents for cleaning.
4. For plug-in equipment, the power outlet socket must be located near the equipment and must be easily accessible.
5. Keep this equipment away from humidity.
6. Put this equipment on a reliable surface during installation. Dropping it or letting it fall may cause damage.
7. The openings on the enclosure are for air convection. Protect the equipment from overheating. **DO NOT COVER THE OPENINGS.**
8. Make sure the voltage of the power source is correct before connecting the equipment to the power outlet.

9. Position the power cord so that people cannot step on it. Do not place anything over the power cord.
10. All cautions and warnings on the equipment should be noted.
11. If the equipment is not used for a long time, disconnect it from the power source to avoid damage by transient overvoltage.
12. Never pour any liquid into an opening. This may cause fire or electrical shock.
13. Never open the equipment. For safety reasons, the equipment should be opened only by qualified service personnel.
14. If one of the following situations arises, get the equipment checked by service personnel:
  15. The power cord or plug is damaged.
  16. Liquid has penetrated into the equipment.
  17. The equipment has been exposed to moisture.
  18. The equipment does not work well, or you cannot get it to work according to the user's manual.
  19. The equipment has been dropped and damaged.
  20. The equipment has obvious signs of breakage.
21. DO NOT LEAVE THIS EQUIPMENT IN AN ENVIRONMENT WHERE THE STORAGE TEMPERATURE MAY GO BELOW  $-20^{\circ}\text{C}$  ( $-4^{\circ}\text{F}$ ) OR ABOVE  $60^{\circ}\text{C}$  ( $140^{\circ}\text{F}$ ). THIS COULD DAMAGE THE EQUIPMENT. THE EQUIPMENT SHOULD BE IN A CONTROLLED ENVIRONMENT.
22. CAUTION: DANGER OF EXPLOSION IF BATTERY IS INCORRECTLY REPLACED. REPLACE ONLY WITH THE SAME OR EQUIVALENT TYPE RECOMMENDED BY THE MANUFACTURER, DISCARD USED BATTERIES ACCORDING TO THE MANUFACTURER'S INSTRUCTIONS.
23. The sound pressure level at the operator's position according to IEC 704-1:1982 is no more than 70 dB (A).

DISCLAIMER: This set of instructions is given according to IEC 704-1. Advantech disclaims all responsibility for the accuracy of any statements contained herein.

## **Safety Precaution - Static Electricity**

Follow these simple precautions to protect yourself from harm and the products from damage.

- To avoid electrical shock, always disconnect the power from your PC chassis before you work on it. Don't touch any components on the CPU card or other cards while the PC is on.

Disconnect power before making any configuration changes. The sudden rush of power as you connect a jumper or install a card may damage sensitive electronic components.



# Contents

<b>Chapter 1</b>	<b>Understanding Your System .....</b>	<b>1</b>
1.1	Introduction .....	2
	Figure 1.1 ADAM-2000 Series System Architecture.....	2
	Figure 1.2 ADAM-2000 Series Outdoor Range Distance .....	2
1.1.1	IEEE 802.15.4 Wireless Standard .....	2
	Table 1.1: Wireless Specifications.....	3
1.1.2	Wireless Sensor Network.....	3
1.1.3	Low-power Consumption and Battery-Powered Design .....	3
1.1.4	Sensor Embedded Design .....	3
1.1.5	Wireless Signal Indicator .....	3
1.1.6	Industrial Standard Modbus Protocol.....	4
1.1.7	SCADA Software Support.....	4
1.1.8	Advantech Software Alignment.....	4
1.2	Specifications .....	4
1.2.1	ADAM-2000 Series Hardware Specification .....	4
1.2.2	LED Status.....	5
	Figure 1.3 LED Indicators .....	5
	Table 1.2: LED Indicator Definitions .....	5
1.2.3	Wireless Communication Range.....	6
1.2.4	Selecting Topology .....	6
	Table 1.3: Topology Comparison Table .....	6
1.3	Dimensions .....	7
	Figure 1.4 ADAM-2000 Series Dimensions .....	7
1.4	Mounting .....	8
1.4.1	Panel Mounting .....	8
	Figure 1.5 Panel Mounting Dimensions.....	8
1.4.2	DIN-rail Mounting .....	9
	Figure 1.6 Fixing ADAM-2000 to DIN rail adaptor .....	9
	Figure 1.7 Fix ADAM-2000 to DIN rail .....	9
1.5	Wiring & Connections.....	10
1.5.1	Power Supply Wiring.....	10
	Figure 1.8 Power Wiring Diagram.....	10
1.5.2	I/O Module Wiring .....	11
1.5.3	Communication Wiring.....	11
	Figure 1.9 RS-422/485 and USB interface of ADAM-2520Z. ....	12
	Figure 1.10Wiring Diagram for ADAM-2520Z.....	12
	Figure 1.11TTL Input Wiring Diagram .....	12
	Figure 1.12Contact Closure Input Wiring Diagram .....	12
<b>Chapter 2</b>	<b>Selecting Your Hardware .....</b>	<b>13</b>
2.1	Selecting an ADAM-2000 Module .....	14
2.1.1	Selecting a Communication Module .....	14
	Table 2.1: Communication Module Selection Guidelines .....	14
	Table 2.2: .....	14
2.1.2	Selecting an I/O .....	15
	Table 2.3: I/O Selection Guidelines .....	15
2.1.3	Selecting a Sensor Module .....	15
	Table 2.4: Sensor Mode Selection .....	15
2.2	Selecting an Operator Interface .....	16
<b>Chapter 3</b>	<b>Installation Guide .....</b>	<b>17</b>

3.1	Determining the Proper Environment.....	18
3.1.1	Package Contents .....	18
3.1.2	System Requirements .....	18
3.1.3	Perform a Wireless Sensor Network.....	18
	Figure 3.1 The Architecture of the Wireless Sensor Network....	19
3.2	Establish the Connection .....	20
3.2.1	Basic Installation.....	20
3.2.2	ADAM-2000 Series Installation Flowcharts .....	23
	Figure 3.2 ADAM-2000 Installation Chart.....	23
3.3	Advanced Functions .....	27
3.3.1	Link Quality Indicator .....	27
	Table 3.1: Level of LQI .....	27
3.3.2	Battery Level.....	27
	Table 3.2: Level of battery power .....	27
3.3.3	Associating Devices.....	27
3.3.4	Pairing.....	28
3.3.5	Reboot.....	28

## Chapter 4 Software Configuration Guide ..... 29

4.1	System Software Configuration Utility.....	30
4.2	Installing ADAM.NET Utility Software .....	30
4.3	ADAM.NET Utility Operation .....	30
	Figure 4.1 ADAM.NET Utility Operation Window .....	30
	Figure 4.2 ADAM.NET Utility Toolbar.....	32
4.3.1	Search and Configure the ADAM-2000 Series.....	33
	Figure 4.3 ADAM-2000 Series ADAM .NET Utility Support.....	33
	Figure 4.4 Search the USB interface ADAM-2000 devices on the host PC for the virtual COM port. ....	34
	Figure 4.5 Search the COM port for the ADAM-2000 devices. .	34
	Figure 4.6 Searching the network dialog .....	35
	Figure 4.7 Searching the ADAM-2000 coordinators.....	35
	Figure 4.8 ADAM-2000 devices lists on the Tree View and Infor- mation page.....	36
	Figure 4.9 The overview of ADAM-2000 end devices. ....	37
	Figure 4.10The overview of ADAM-2000 routers .....	37
	Figure 4.11Information page of ADAM-2520Z.....	38
	Figure 4.12Wireless Configuration page of the ADAM-2520Z. .	38
	Figure 4.13 Information page of ADAM-2510Z.....	39
	Figure 4.14Wireless Configuration page of ADAM-2510Z .....	39
	Figure 4.15 The Device Status page of the ADAM-2510Z .....	40
	Figure 4.16 Information Page of ADAM-2051Z .....	40
	Figure 4.17Wireless Configuration page of ADAM-2051Z .....	41
	Figure 4.18The Device Status page of the ADAM-2051Z .....	41
	Figure 4.19The Signal page of the ADAM-2051Z .....	42
	Figure 4.20Information Page .....	42
	Figure 4.21Wireless Configuration Page .....	43
	Figure 4.22Device Status Page .....	43
	Figure 4.23Sensor Page.....	44
4.3.2	Network Topology of ADAM-2000 Series .....	44
	Figure 4.24Topology of the ADAM-2000 series .....	44
	Figure 4.25Topology of ADAM-2000 network with specific back- ground image .....	45

## Chapter A Module Introduction ..... 47

A.1	Communication Modules .....	48
A.1.1	ADAM-2510Z .....	48
A.1.2	ADAM-2520Z .....	49



A.2	I/O and Sensor Modules .....	50
A.2.1	ADAM-2017Z .....	50
A.2.2	ADAM-2031Z .....	51
A.2.3	ADAM-2051Z .....	52
A.2.4	ADAM-2051PZ .....	53

## **Chapter B ADAM-2000 Series Functions.....55**

B.1	Introduction .....	56
B.2	ADAM-2000 I/O Modbus Mapping Table .....	56
	Table B.1: Modbus ID Table of ADAM-2000 series .....	56
B.2.1	ADAM-2520Z .....	56
	Table B.2: ADAM-2520Z Function Table .....	56
B.2.2	ADAM-2510Z .....	57
	Table B.3: ADAM-2510Z Function Table .....	57
B.2.3	ADAM-2017Z .....	57
	Table B.4: ADAM-2017Z Function Table .....	57
B.2.4	ADAM-2031Z .....	58
	Table B.5: ADAM-2031Z Function Table .....	58
B.2.5	ADAM-2051Z .....	59
	Table B.6: ADAM-2051Z Function Table .....	59
B.2.6	ADAM-2051PZ .....	60
	Table B.7: ADAM-2051PZ Function Table .....	60

## **Chapter C Troubleshooting .....61**

C.1	Troubleshooting .....	62
C.2	Notice .....	63



# Chapter 1

Understanding Your  
System

## 1.1 Introduction

ADAM-2000 series is the wireless solution of the ADAM families and integrates the IEEE 802.15.4 standard, I/O and Sensor technologies known as Wireless Sensor Network. Different from the wired solution, the flexible network capability makes it easy to extend or construct a cost-effective distributed monitoring system for variety of applications. Through popular industrial Modbus protocol, the ADAM-2000 can be integrated into any HMI and SCADA system. The low-power consumption design also makes it possible for standalone applications with batteries. The sensor embedded design provides compact size for specified application. With the ADAM-4000 and ADAM-6000, the ADAM provides the total solutions of remote I/O. Please refer to Figure 1-1 for a brief overview of the ADAM-2000 system architecture..

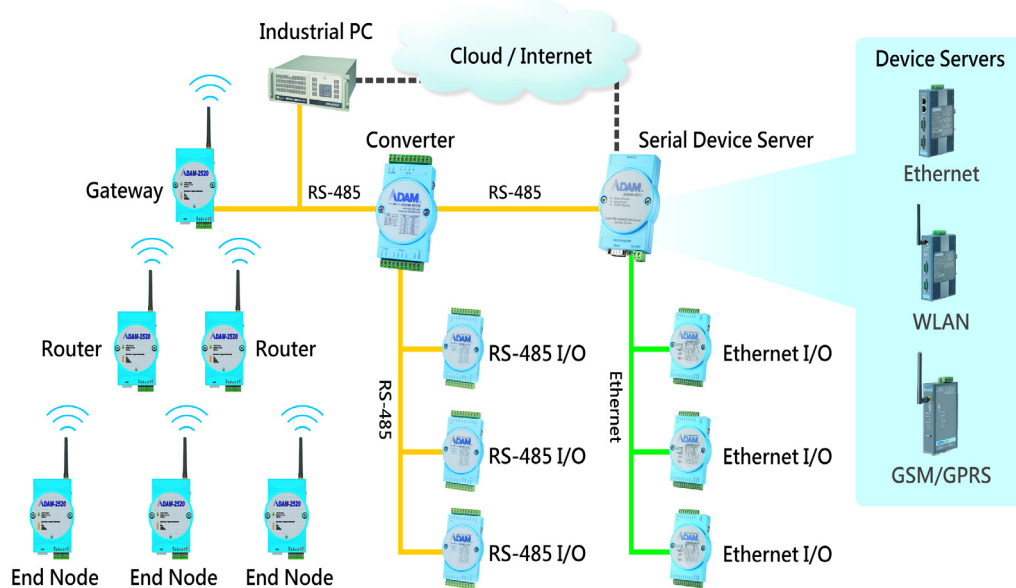


Figure 1.1 ADAM-2000 Series System Architecture

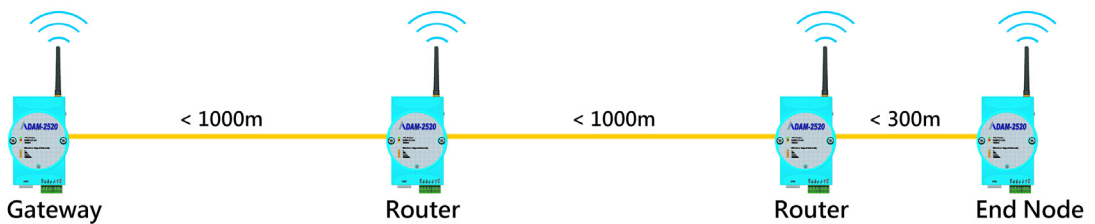


Figure 1.2 ADAM-2000 Series Outdoor Range Distance

### 1.1.1 IEEE 802.15.4 Wireless Standard

IEEE 802.15.4 is a wireless standard defined as Low Rate Wireless Personal Area Network (LR-WPAN) or usually called Wireless Personal Area Network (WPAN) instead. It is designed for low-power consumption and robust wireless communication, especially for small data packet applications, such as sensor, I/O and etc. IEEE 802.15.4 is a low data rate, low power consumption, low cost, wireless networking protocol targeted towards automation and remote control applications. It is expected to provide low cost and low power connectivity for equipment that needs battery life as long as several months to several years but does not require data transfer rates as high as those enabled by Bluetooth. The IEEE 802.15.4 standard only defines the

PHY and MAC layers. The working RF are 868MHz for USA, 918MHz for EU and 2.4GHz for World Wide.

**Table 1.1: Wireless Specifications**

Feature(s)	IEEE 802.11b	Bluetooth	ZigBee
Data Rate	11Mbps	1Mbps	250Kbps
Power Consumption	Hours (High)	Days	Years (Low)
Transmission Distance	100m	10m	70m~300m
Connection	Very Complex	Complex	Simple
Connection Speed	Up to 3 seconds	Up to 10 seconds	30ms
Extendibility	Roaming possible	No	Yes
Reliability	Low	High	High

### 1.1.2 Wireless Sensor Network

The Wireless Sensor Network is based on the IEEE 802.15.4 standard and inherits all the characteristics. Coordinator, Router and End Device (or called End Node) are the basic components to perform the PAN.

A coordinator is the data collection center in a PAN and also plays as a gateway to transfer and translate wireless data to other interfaces, such as RS-232, RS-485, Ethernet and so on.

A router is a wireless repeater to enhance the wireless signal and a wireless router to select optimized path for wireless communication between coordinator and end nodes.

An end node is a wireless remote I/O for data acquisition. The data acquires from sensors or devices can be transmitted through it. The end node can communicate with coordinator directly or via a router to coordinator.

As traditional network, the Wireless Sensor Network provides the star, tree and mesh topologies for various applications.

### 1.1.3 Low-power Consumption and Battery-Powered Design

ADAM-2000 is designed as a standalone device for applications that require long-time operation without maintenance. Therefore power consumption taken into consideration during its design. The ADAM-2000 not only follows the IEEE 802.15.4 standard for low-power consumption wireless communication, but also optimizes the peripheral HW and FW design to achieve the uA power consumption: making it capable of being powered using 2 AA Alkaline batteries.

### 1.1.4 Sensor Embedded Design

Sensor embedded design makes the ADAM-2000 even better in some specified and compact applications. The ADAM-2031Z integrates a temperature, humidity. The module is suitable for building automation, Green-house, environment applications which require the specified sensors. With the batteries installed into the ADAM-2031Z no extra wiring is required and the two modules can work independently.

### 1.1.5 Wireless Signal Indicator

There are LEDs in the front of the panel to display the status of device. The LEDs can indicate the device's status, wireless signal strength, battery power level and error conditions. With the LEDs, users can easily see the status of the ADAM-2000 by pressing a button on the side of the ADAM-2000.

## 1.1.6 Industrial Standard Modbus Protocol

Modbus is an industrial standard serial communication protocol, and a commonly available means of connecting industrial electronic devices. Modbus allows for communication between many devices connected to the same network. Modbus RTU is used in serial communication and makes use of a compact binary representation of the data for protocol communication. The RTU format follows the commands/data with a cyclic redundancy check checksum as an error check mechanism to ensure the reliability of data.

## 1.1.7 SCADA Software Support

ADAM-2000 supports industrial standard Modbus protocol and can be integrated into Advantech HMI, WOP, SCADA - WebAccess and 3rd party HMI. With the different ADAM-2000 modules, it is able to acquire signal from digital input, analog input, temperature, humidity, luminance and CO2 concentration then the signals can be apply to your application.

## 1.1.8 Advantech Software Alignment

As with all other ADAM devices, the ADAM-2000 integrates into the ADAM .NET Utility, therefore users will have an identical user experience. With the powerful Advantech software, only a few steps are required to search and configure the ADAM-2000 series.

# 1.2 Specifications

## 1.2.1 ADAM-2000 Series Hardware Specification

- IEEE Standards: IEEE 802.15.4
- Modulation Type: OQPSK
- Frequency Band: 2.4GHz ~ 2.4835GHz
- Channels: 11 - 26
- RF Data Rate: 250 kbps
- Transmit Power: 3dBm (1.6mW) & 19dBm(79mW)
- Receiver Sensitivity: -97 dBm
- Transmission Power:
  - ADAM-2031Z, 2051Z:  $3 \pm 1$  dBm
  - ADAM-2051PZ, 2510Z, 2520Z:  $19 \pm 1$  dBm
- Outdoor Range:
  - ADAM-2031Z, 2017Z, 2051Z: 110m
  - ADAM-2051PZ, 2510Z, 2520Z: 1000m
- Topology: Star/Tree/Mesh
- Network Depth/Scale: 6 Routers x 6 Routers
- Function: Coordinator/Router/End Device
- Operating Temperature Range: -20°C ~ 70°C (-4°F ~ 157.9°F)
- Operating Temperature Range (Battery Powered): 0°C ~ 50°C (32°F~122°F)
- Storage Temperature: -40°C ~ 85°C (-40°F~185°F)
- Operation Humidity: 20% ~ 95%

- Storage Humidity: 0% ~ 95%

**Note!** *This products components will operate at temperatures up to 85°C however the case the casing will crack if subjected to temperatures above 70°C for a long period.*



*If you need to operate the device in temperatures exceeding those stated, contact your nearest sales agent.*

## 1.2.2 LED Status

There are four types of LED status on the front panel of ADAM-2000 series.

1. Ext PWR: Green LED
2. Error: Red LED
3. Status: Yellow LED
4. Level Index: 4x Amber LEDs

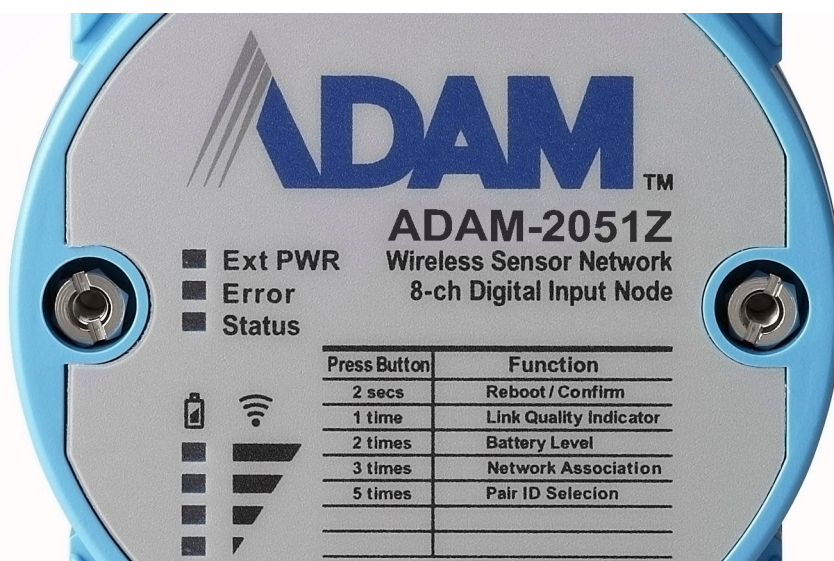


Figure 1.3 LED Indicators

Table 1.2: LED Indicator Definitions

Name	Color	LED Status	Definition	
1	Ext PWR	Green	On	External/USB Power Input
			Off	No External/USB Power Input
2	Error	Red	Blinking	Error: Refer to Appendix C for more information
			Off	No error
3	Status	Yellow	On	Initial Mode
			Off	Normal Mode
			Blinking	Configure Pairing ID (Initial Mode)
4	Level Index	Amber	On	LQI Level, Battery Level, Pair ID, Modbus ID. Refer to the section for more detail.
			Off	No LQI / Battery Level
			Blinking	Selected Pair ID

### 1.2.3 Wireless Communication Range

Thought the wireless technology brings the advantage of flexibility, cost-effective wiring and easy deployment, but users must understand its limitations to enjoy the benefits of the wireless technology.

The Link Quality Indicator (LQI) of the ADAM-2000 displays how the facts below affect the wireless signal. Its indicator represents the Received Signal Strength Indication (RSSI) and the retransmission times of a packet. The better the LQI, the better the wireless data packet transmission quality. The limitation of the wireless communication range depends on following factors:

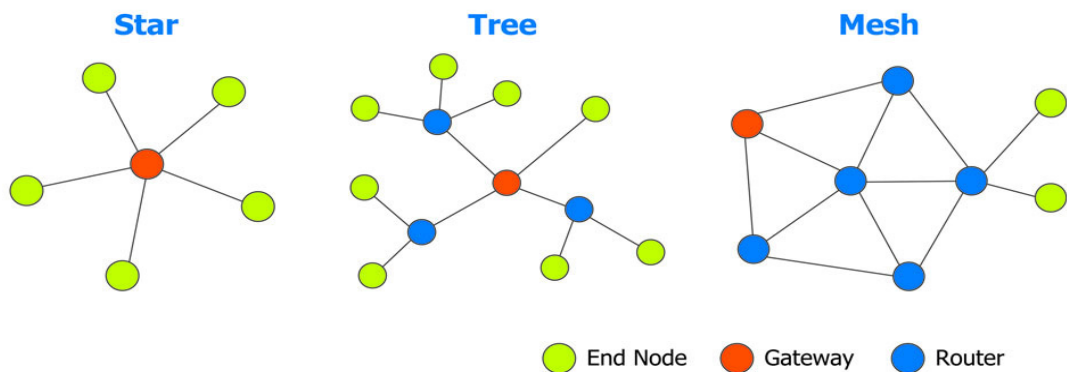
■ Transmission power	■ Receiver sensitivity
■ Interference	■ Line of Sight
■ Antenna Performance	■ Shelter
■ Altitude above Ground	■ Free Space Loss

**Note!** For more information on these factors, contact your supplier.



### 1.2.4 Selecting Topology

Usually, when building a network solution, the user has to take into consideration the topology that will be used since different topologies have different characteristics. The ADAM-2000 series provides star, tree and mesh topologies. No further configuration is required, the ADAM-2000 series will automatically associate the network by the locations of the ADAM-2000 series units. Users may select the correct topology and install ADAM-2000s for their application systems. See the image below and Table 1.2 provide the illustrations and characteristics comparison table of the three topologies.



**Table 1.3: Topology Comparison Table**

Topology	Star	Tree	Mesh
<b>Power Consumption</b>	Low	Medium	High
<b>Installation Fee</b>	Low	Medium	High
<b>Network Coverage</b>	Small	Large	Large
<b>Network Capability</b>	Small	Large	Large



### 1.3 Dimensions

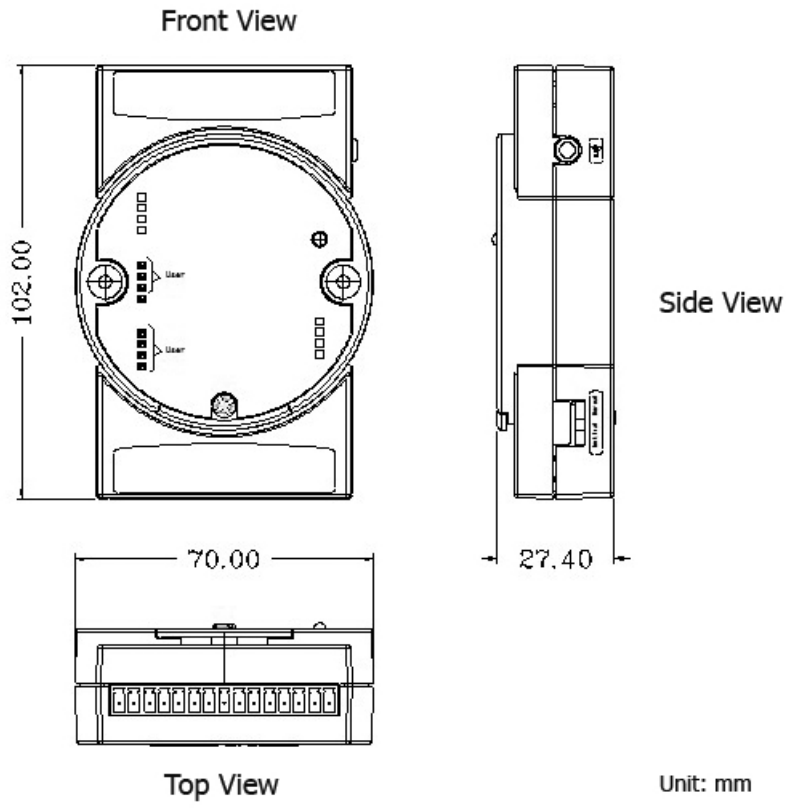


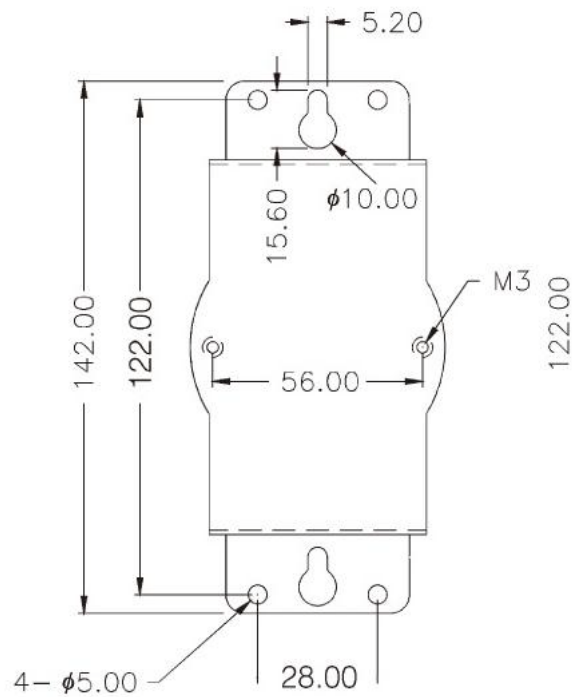
Figure 1.4 ADAM-2000 Series Dimensions

## 1.4 Mounting

ADAM-2000 series modules are designed as compact units and are allowed to be installed in the field site with the following method.

### 1.4.1 Panel Mounting

Each ADAM-2000 Module is packed with a plastic panel mounting bracket. Users can refer the dimensions of the bracket to configure an optimal placement in a panel or cabinet. Fix the bracket first, then, fix the ADAM-2000 module on the bracket.



**Figure 1.5 Panel Mounting Dimensions**

## 1.4.2 DIN-rail Mounting

The ADAM-2000 module can also be secured to the cabinet by using mounting rails. Fix the ADAM-2000 module with the DIN-rail adaptor as Figure 3.2. Then secure it on the DIN-rail as Figure 3.3. If you mount the module on a rail, you should also consider using end brackets at each end of the rail. The end brackets help keep the modules from sliding horizontally along the rail.

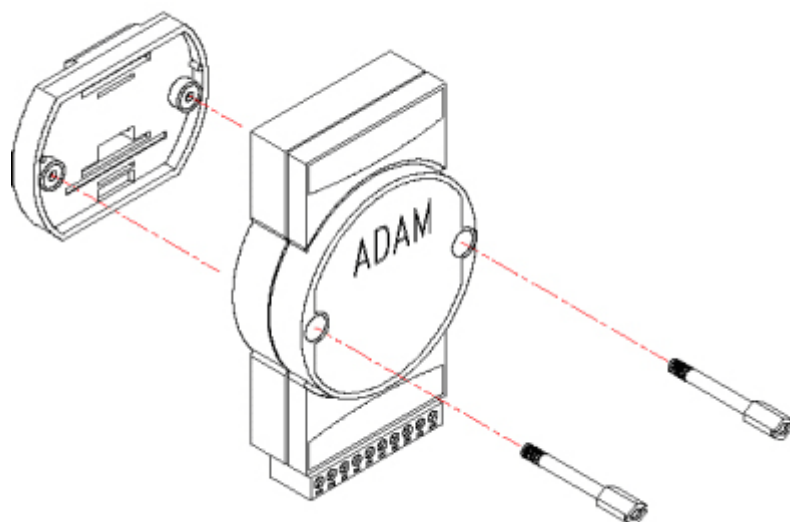


Figure 1.6 Fixing ADAM-2000 to DIN rail adaptor

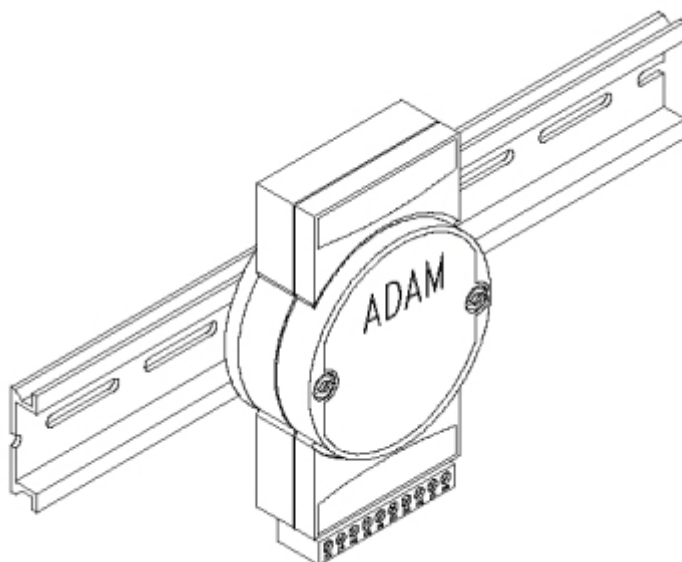


Figure 1.7 Fix ADAM-2000 to DIN rail

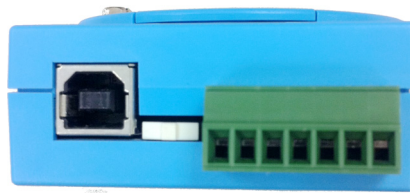
## 1.5 Wiring & Connections

This section provides basic information of wiring the power supply, I/O units, communication units, and network connection.

### 1.5.1 Power Supply Wiring

You can choose power supply type with 3 type: USB port, RS-485 port, battery for ADAM-2520Z gateway, other devices can use RS-485 or battery to get power.

When you want to set up ADAM-2520Z gateway, please see as a wireless receiver to use USB or RS-485 to do data transfer between router or end-device.



**Note!** On the base of the ADAM-2520Z, if you want to receive power from the USB port move the switch to left, if you want to get power from RS-485, move the switch to the right. Do this before plugging in the cable.



#### 1.5.1.1 External Power Input

Although the ADAM-2000 systems are designed for a standard industrial unregulated 24 V<sub>DC</sub> power supply, they accept any power unit that supplies within the range of +10 to +30 V<sub>DC</sub>. The power supply ripple must be limited to 200mV peak-to-peak, and the immediate ripple voltage should be maintained between +10 and +30 V<sub>DC</sub>. Screw terminals +Vs and GND are for power supply wiring.

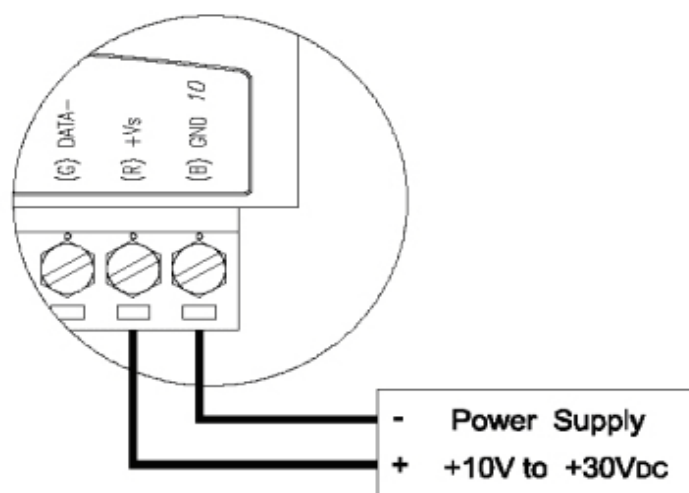


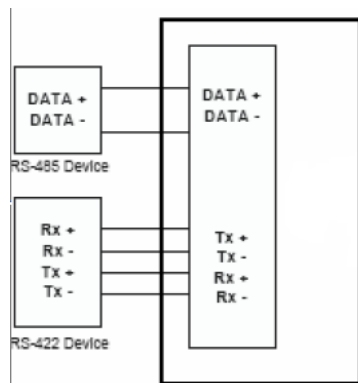
Figure 1.8 Power Wiring Diagram

### 1.5.1.2 ADAM-2520Z Basic Configuration with USB Power Supply

To use the USB cable as a power supply from a PC, connect the T Type USB connector to the computer and the other end (USB Type B) to the ADAM-2520Z WSN Gateway.

### 1.5.1.3 ADAM-2520Z Basic Configuration without USB Power Supply

To power the device via RS-485, the module should be properly configured. See the diagram below:



### 1.5.1.4 Battery Power Slot

The ADAM-2000 series can be powered by batteries. Remove the name plate in the front of the ADAM-2000 series device and install 2 AA Alkaline batteries for backup power or standard operation (depends on the power consumption of the devices). The ADAM-2000 is powered by batteries only if the external power is not available.

Note\* The batteries will not be charged when using external input power.

## 1.5.2 I/O Module Wiring

The system uses a plug-in screw terminal block as the interface between I/O modules and external devices. When connecting external devices to the I/O modules, follows the guideline below.

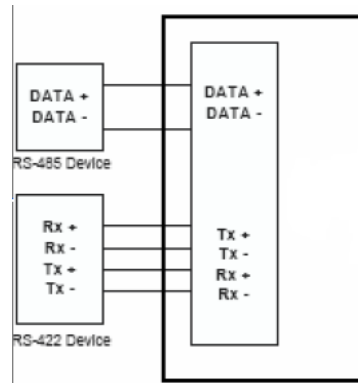
1. The maximum wire diameter allowed for the terminal block is 0.5 mm to 2.5 mm.
2. Always use an integrity wire.
3. Keep wires as short as possible.
4. Use wire trays or wire holders to secure wires.
5. Avoid running wires close to high energy wiring.
6. Keep input wiring and output wiring apart.
7. Avoid any sharp bend to the wires.
8. Follow the (+) and (-) symbols on the side panel to wire correctly.

## 1.5.3 Communication Wiring

In a WPAN, only the Gateway needs to connect to a host. The ADAM-2520Z is the Wireless Sensor Network Modbus RTU Gateway of the ADAM-2000 series and provides RS-422/485 and USB interfaces to connect to host. Users can choose one of the interfaces by pushing the switch to RS-422/485 or USB position.

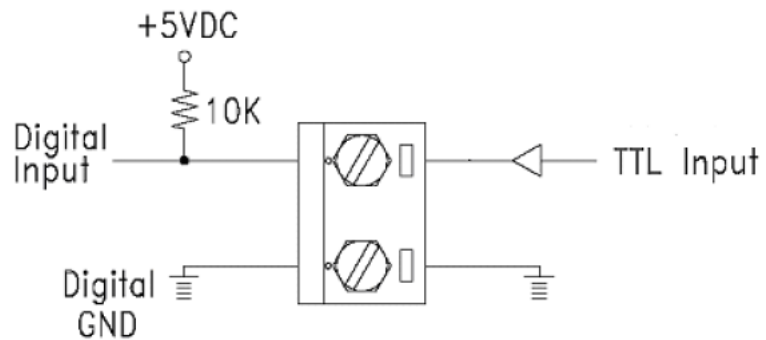


**Figure 1.9 RS-422/485 and USB interface of ADAM-2520Z.**

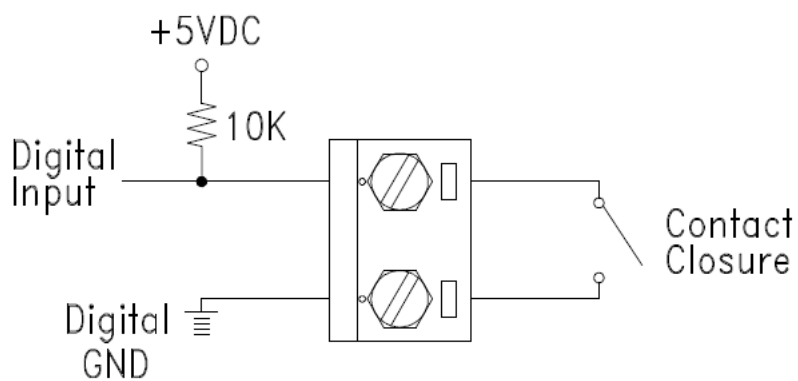


**Figure 1.10 Wiring Diagram for ADAM-2520Z**

**Application Wiring**



**Figure 1.11 TTL Input Wiring Diagram**

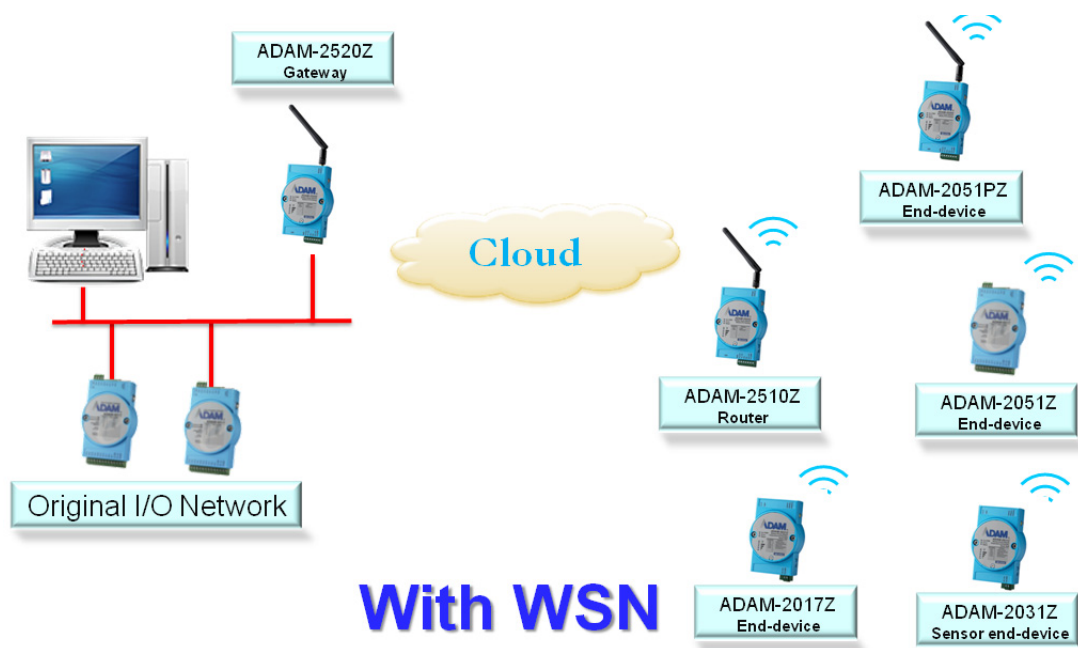


**Figure 1.12 Contact Closure Input Wiring Diagram**

# Chapter 2

Selecting Your  
Hardware

## 2.1 Selecting an ADAM-2000 Module



Communication Module	ADAM-2520Z, ADAM-2510Z
I/O Module	ADAM-2051Z, ADAM-2051PZ, ADAM-2017Z
Sensor Module	ADAM-2031Z

### 2.1.1 Selecting a Communication Module

Communication modules are fundamental when needing to perform data acquisition and control Wireless Sensor Networks systems. There are two types of communications modules: the coordinator and the router.

A coordinator is essential to associate an Wireless Personal Area Network (WPAN) and as a data collector of the WPAN. Only one coordinator available in a specified WPAN of a specified RF channel. A coordinator also acts as a gateway to translate data packets between two different networks.

The router is optional in a PAN. The major function of a router is to repeat the wireless signal to improve the LQI. With routers, a PAN can be easily extended. More routers in a PAN means larger coverage and capacity of the network.

**Table 2.1: Communication Module Selection Guidelines**

**Choose this communication module:** Description

Router	Routers as a wireless signal repeater extends the transmission range and communication quality
Gateway	A gateway collects wireless data from the end node and translate to other communication protocols, such as Modbus RTU.



## 2.1.2 Selecting an I/O

To organize an ADAM-2000 series remote data acquisition and control system, you need to select proper I/O or sensor modules to connect to field devices or processes that you have previously determined.

**Table 2.3: I/O Selection Guidelines**

Choose this I/O module:	For these types of field devices or operations (examples):	Description:
Digital Input Node	<ul style="list-style-type: none"> <li>■ Selector switches</li> <li>■ Push buttons</li> <li>■ Photoelectric eyes</li> <li>■ Limit switches</li> <li>■ Circuit breakers</li> <li>■ Proximity switches</li> <li>■ Level switches</li> <li>■ Motor starter contacts</li> <li>■ Relay contacts</li> <li>■ Thumb wheel switches</li> </ul>	Input modules sense: On/Off signals or Open/Closed signals.
Analog Input Node	<ul style="list-style-type: none"> <li>■ Thermocouple signals</li> <li>■ RTD signals</li> <li>■ Temperature transducers,</li> <li>■ Pressure transducers</li> <li>■ Load</li> <li>■ Cell transducers</li> <li>■ Humidity transducers</li> <li>■ Flow transducers,</li> <li>■ Potential meters</li> </ul>	Convert continuous analog signals into digital input values for host device

## 2.1.3 Selecting a Sensor Module

**Table 2.4: Sensor Mode Selection**

Choose this I/O module:	For these types of field devices or operations (examples):	Description:
Sensors Node	<ul style="list-style-type: none"> <li>■ Temperature measurement</li> <li>■ Humidity measurement</li> </ul>	Directly measure the physical signal without any conversion.

---

## 2.2 Selecting an Operator Interface

To complete your data acquisition and control system, selecting an operator interface is necessary. Adopting the Modbus protocol, ADAM-2000 series I/O modules exhibit high ability in system integration for various applications. For reading the real-time status of ADAM-2000 series modules anywhere without any engineering effort, there is a lot of third-party Modbus software available.

To integrate ADAM-2000 series I/O with HMI, Human Machine Interface, software in a SCADA, Supervisory Control and Data acquisition, system, there are a lot of HMI software packages which support Modbus driver.

- Advantech Studio
- Advantech WebAccess
- Wonderware InTouch
- Intellution Fix of I-Fix
- Any other software which supports the Modbus protocol

# Chapter 3

## Installation Guide

---

## 3.1 Determining the Proper Environment

Prior to installing ADAM-2000 series modules, please check the following.

### 3.1.1 Package Contents

Unpack the package and make sure that the contents include:

- ADAM-2000 series module
- 2 dBi antenna
- 2 x Mounting kits
- ADAM-2000 series CD (User manual, datasheet, Quick start guide and-ADAM.NET Utility.)

### 3.1.2 System Requirements

- IBM PC compatible computer with at least 486 CPU (Pentium recommended)
- Microsoft Windows 2000, XP, Vista and 7 (32Bit)
- At least 32 MB RAM
- 20 MB of hard disk space available
- VGA color monitor
- CD-ROM or DVD-ROM
- Mouse or other pointing devices
- Power Supply for ADAM-2000 Series (+10 ~ +30 V<sub>DC</sub> Unregulated)

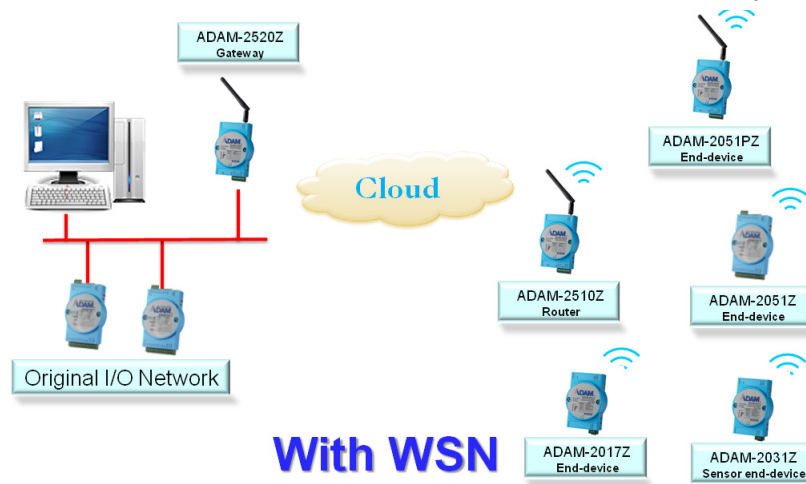
### 3.1.3 Perform a Wireless Sensor Network

Coordinator, Router and End Device are three basic elements of the Wireless Sensor Network. Each of them has different functions. All the nodes have to set the same PAN ID and RF channel to perform the communication.

A Coordinator is essential to associate a PAN of the Wireless Sensor Network in a specific PAN ID and RF channel. It is also a data collector of the PAN and usually works as a gateway to translate wireless data into any other data formats, such as Modbus RTU.

A router is optional in a PAN. It works as a wireless repeater to enhance the wireless signal strength and selects the optimistic path for a end node to route data back to the coordinator. A PAN with routers can make the network work as tree or mesh topology.

An End Device (End Node) is the basic element to acquire the physical signals and data from I/O, sensor and even communication interface. It can be designed for many different functions and is possible for standalone applications by battery-power.



**Figure 3.1 The Architecture of the Wireless Sensor Network**

## 3.2 Establish the Connection

### 3.2.1 Basic Installation

In the side of the ADAM-2000 series, users can find **Mode Switch** and **Function Button**. The two hardware keys contain several combinations for device operations. The default position of **Mode Switch** is set in the Initial Mode to configure the device and establish connection for Normal Mode.

It is easily to use the ADAM-2000 series with default configuration. Push the **Mode Switch** on the side of ADAM-2000 devices to **Normal** position then the PAN can be operated to collect data from modules. The ADAM-2000 series also provides advanced functions for further operations.

#### Initial Mode

The Initial Mode is for user to configure parameters of the ADAM-2000 devices. While the device is in the **Initial Mode**, Status LED turns on.

1. Push the **Mode Switch** to the **Initial** position.
2. Open the ADAM.NET Utility to search and configure the ADAM-2000 devices.

#### Normal Mode

After all the ADAM-2000 devices are configured in the same PAN ID and channel, push the **Mode Switch** to **Normal** position to perform the Wireless Sensor Network.

Connection Steps in Initial Mode:





#### 3.2.1.1 Coordinator

1. Power on.
2. All LEDs turn on for 0.5 second then turn off.
3. Status LED turns on, Error LED blinks.
4. **Level Index** turns on to indicate Pair ID 1. (Pair ID will automatically count if there is a coordinator nearby. For advanced setting, please refer to the section 3.5)
5. Error LED turns off when it hosts a PAN.




### 3.2.1.2 Router/End Device

Routers and End Devices must have to associate with corresponding Pair ID Coordinator in **Initial Mode** to build up the wireless communication. The function is for Router and End Devices only.

1. Power on.
2. All LEDs turn on for 0.5 second then turn off.
3. Press the  **Function Button** 3 times to join a PAN with the default Pair ID 1.
4. Status LED turns on, Error LED blinks.
5.  **Level Index** turns on to indicate Pair ID 1. (Pair ID needs to be properly configured if there are coordinators. For advanced settings, please refer to section 3.3)
6. If the Coordinator Pair ID is not 1, hold the **Function Button** for 2 seconds to reboot your router or end-devices, then press **Function Button** 5 times to enter Pair ID selection, the click N times according the Coordinator Pair ID, then hold the **Function Button** for 2 seconds to confirm your setting, finally press the **Function Button** 3 times to join a PAN.
7. Error LED turns off when it join a PAN.





Once the Coordinator, Routers and End Devices are connected in the same Pair ID then all devices can be configured through ADAM.NET Utility for Normal Mode operation. (For detailed operation and functionality of ADAM.NET Utility, please refer to Chapter 5.) Push the  **Mode Switch** to the **Normal** position to reboot the device to Normal Mode.

**Note!** *To set up the Coordinator, Routers and End Devices, make sure they are in the same mode, otherwise they can't be configured.*





### 3.2.2 ADAM-2000 Series Installation Flowcharts

The following flowcharts are designed to tell you how to install the ADAM-2000 models.

#### 3.2.2.1 ADAM-2000 Series Installation Overview

The section describe how to host a WPAN for ADAM-2000 series. The coordinator, end devices are basic component for the wireless data acquisition system. Routers are optional to enhance the network coverage and mesh mechanism. Please refer to the following flowchart for the overview of ADAM-2000 installation, configuration and operation.

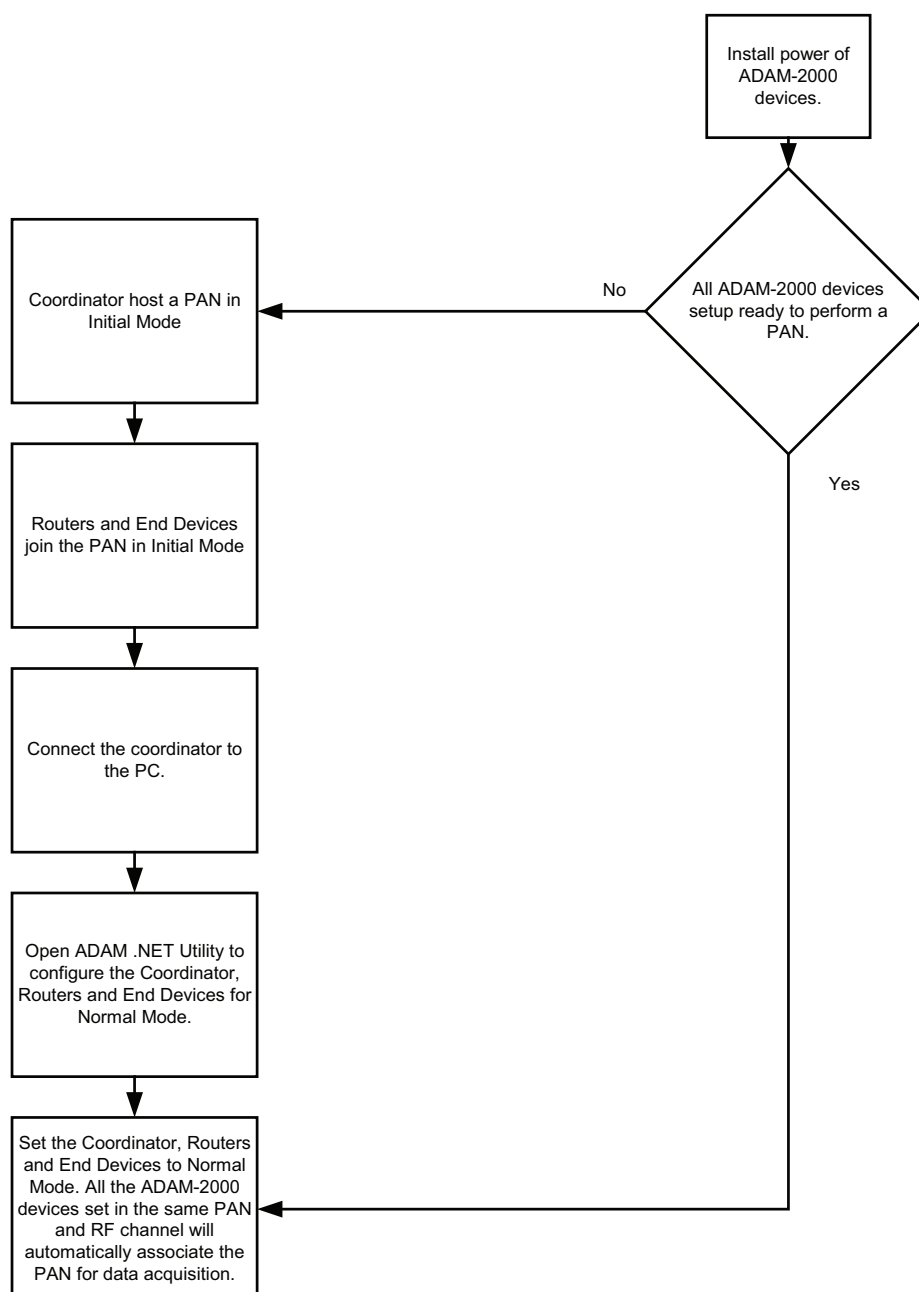
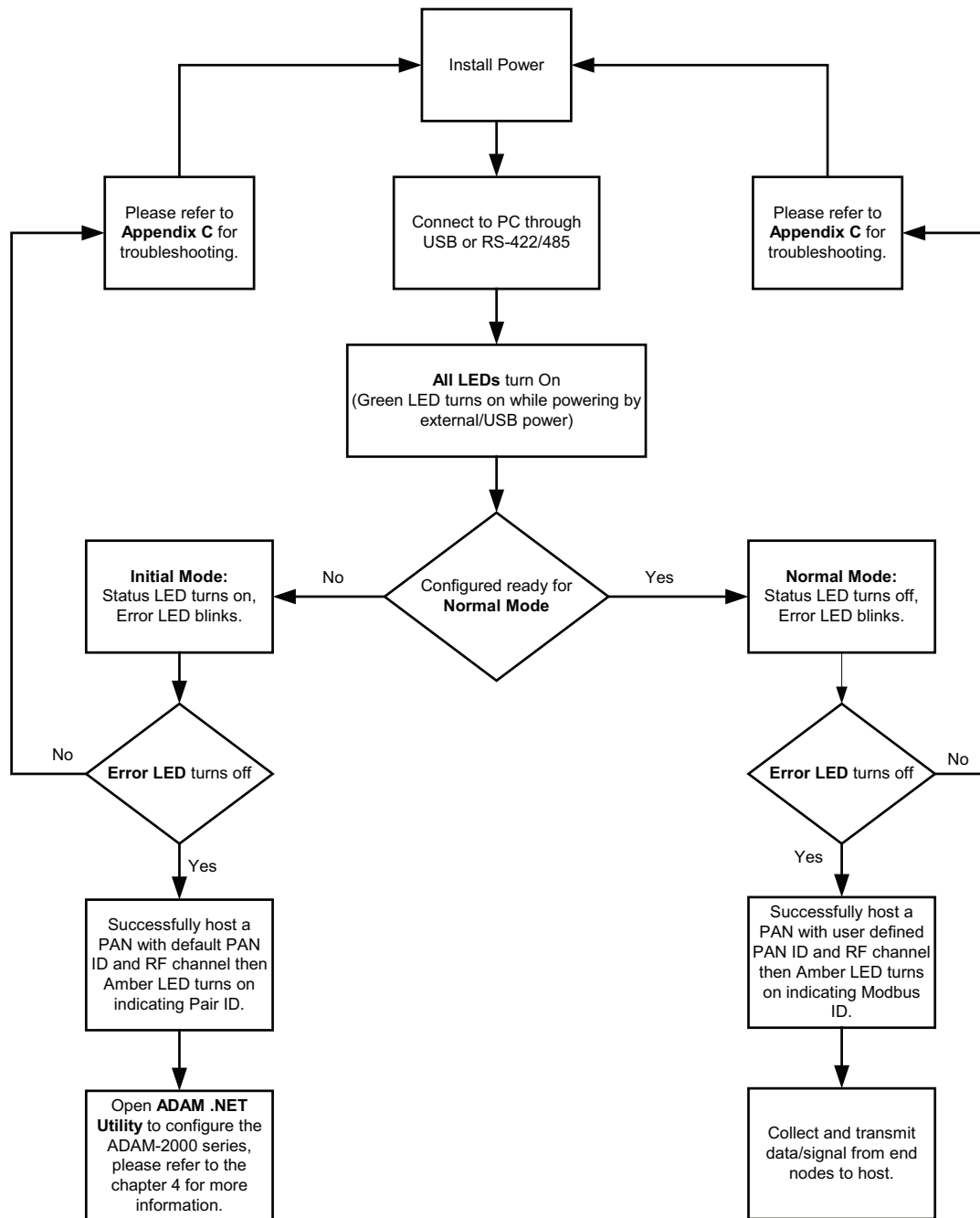


Figure 3.2 ADAM-2000 Installation Chart

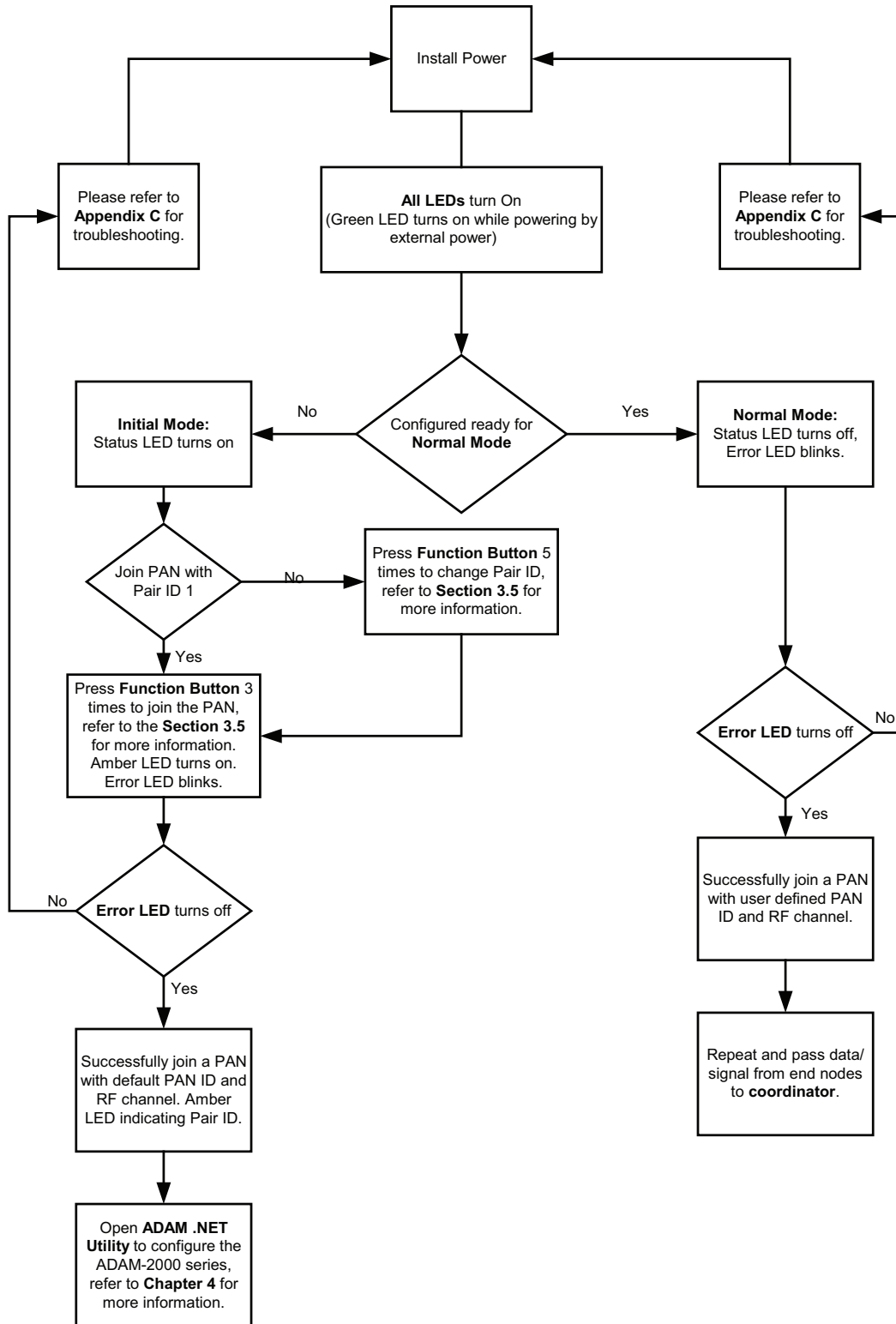
### 3.2.2.2 Coordinator Configuration Flowchart

The section tells the user how to setup the Coordinator to host a PAN for a wireless sensor network.



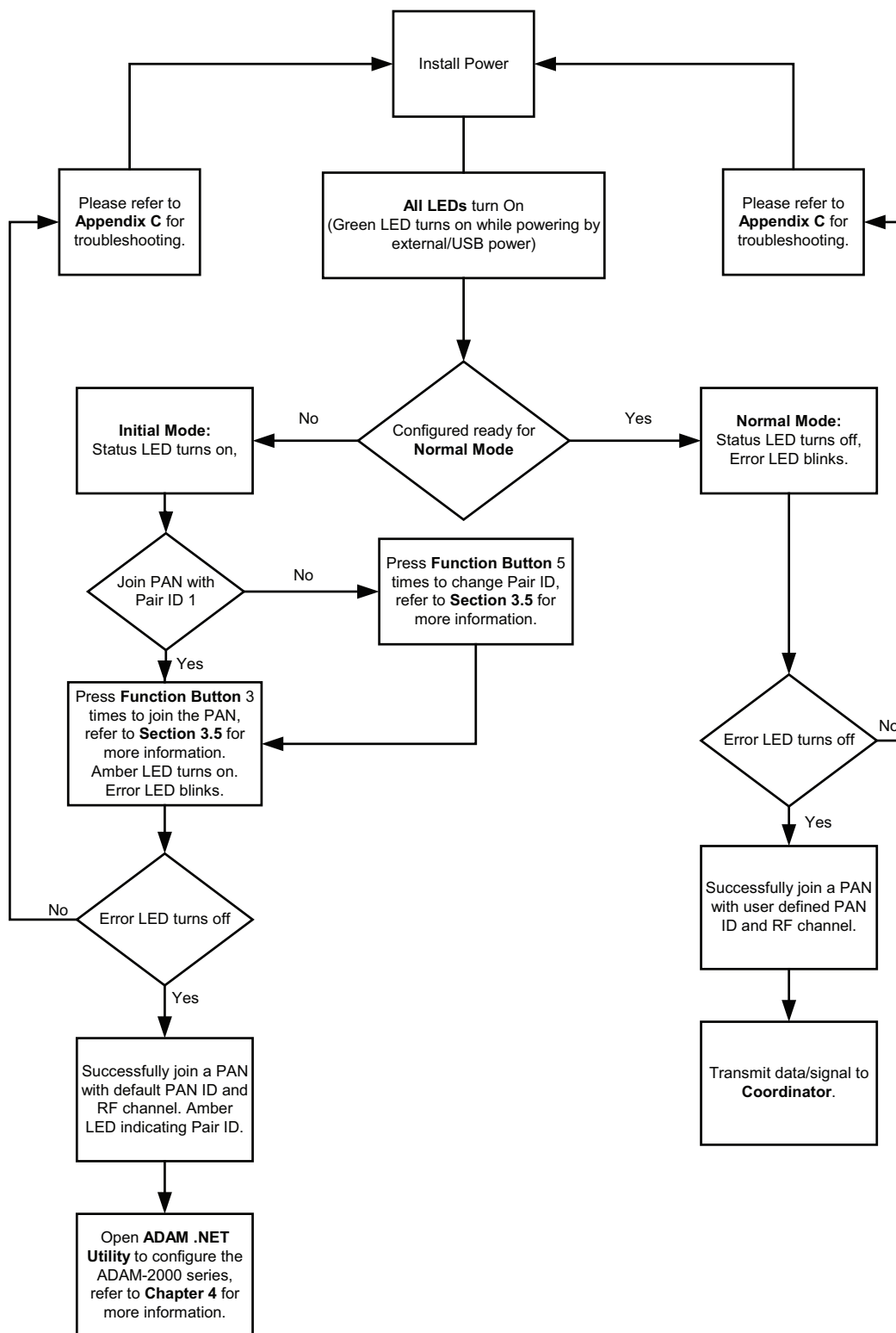
### 3.2.2.3 Router Configuration Flowchart

The section tells the user how to setup the Router to enhance the wireless communication range and coverage of a PAN for a wireless sensor network.



### 3.2.2.4 End Device Configuration Flowchart

The section tells the user how to setup the End Devices to do data acquisition of a PAN for a wireless sensor network.



## 3.3 Advanced Functions

### 3.3.1 Link Quality Indicator

The LQI represents the wireless signal index and can assist the user to install the ADAM-2000 devices in proper location for good communication quality. The LQI function is only available for Router and End Devices. Press the **Function Button** once and the **Level Index** in the front panel will turn on to indicate the level of LQI.

**Table 3.1: Level of LQI**

Level Index Conditions	Description
4 LEDs on	Excellent
3 LEDs on	Good
2 LEDs on	Normal
1 LED on	Poor
No LED on, Error LED blinks	No Signal

### 3.3.2 Battery Level

All ADAM-2000 devices are all designed to be used with batteries. Users can install two AA Alkaline batteries for extended operation or back-up power. Press the **Function Button** twice and the Level Index in the front panel will turn on to indicate the level of battery power./

**Table 3.2: Level of battery power**

Level Index Conditions	Description
4 LEDs on	Excellent
3 LEDs on	Good
2 LEDs on	Normal
1 LED on	Poor
No LED on, Error LED blinks	Low battery

### 3.3.3 Associating Devices

Routers and End Devices must have to associate with corresponding Pair ID Coordinator in **Initial Mode** to build up the wireless communication. The function is for Router and End Devices only.

1. Press the **Function Button** 3 times to join a PAN with specific Pair ID Coordinator.
2. Status LED turns on, Error LED blinks.
3. Level LED turns on to indicate the Pair ID to associate with.
4. Error LED turns off when it joins a PAN.

---

### 3.3.4 Pairing

In the **Initial Mode**, Routers and End Devices must be associated with the corresponding Coordinator. The function is for Router and End Devices only.

1. Press the **Function Button** 5 times to enter the change Pair ID mode.
2. Status LED blinks
3. Level Index LED turns on to indicate Pair ID.
4. Press the **Function Button** once to change Pair ID.
5. Press and hold the **Function Button** for over 3 seconds to save and confirm the Pair ID.
6. Press the **Function Button** 3 times to associate with specific Pair ID Coordinator.
7. Error LED turns off when it join a PAN.

### 3.3.5 Reboot

Press the **Function Button** for over 3 seconds to reboot the device.


# Chapter 4

Software  
Configuration Guide

## 4.1 System Software Configuration Utility

The ADAM.NET Utility software offers a graphical interface that helps you configure the ADAM-2000 series. It is also very convenient to test and monitor your remote data acquisition and control system. The following guidelines will give you some brief instructions on how to use this Utility. Before installing the ADAM.NET Utility, remember to first install .NET Framework 1.1 or later from Microsoft website.

## 4.2 Installing ADAM.NET Utility Software

- Caution!**
- 
1. Make sure both coordination and devices are in **Initial Mode**
  2. Ensure that you are using a minimum of Windows 2000, XP or Windows 7
  3. Before installing ADAM.NET Utility, you need to install the .NET Framework 1.1 or later.

Advantech provides a free download of ADAM.NET Utility software for module operation and configuration. You can find the Utility installation file in the CD with your module, or on our website at: <http://www.advantech.com> and click the Download Area under Service & Support to get the latest version of the ADAM.NET Utility. Once you download and setup the Utility software, there will be a shortcut of the Utility program on the desktop.

## 4.3 ADAM.NET Utility Operation

After you have successfully installed ADAM.NET Utility, there will be one shortcut icon on the desktop. Double click the shortcut icon that you should be able to see the operation window.

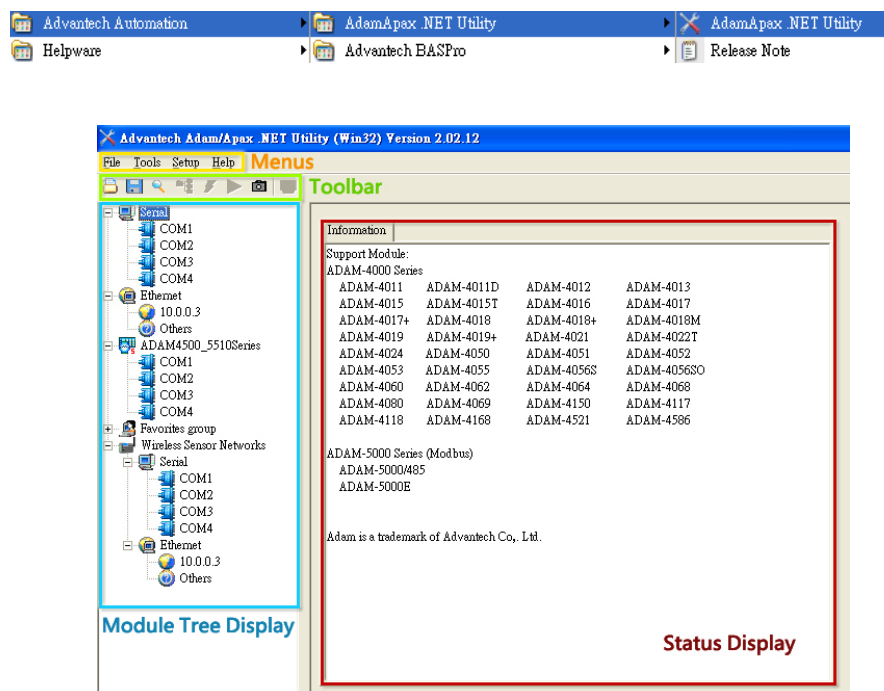


Figure 4.1 ADAM.NET Utility Operation Window



The operation window consists of four areas --- the **Menus**, the **Toolbar**, the **Module Tree Display Area** and the **Status Display Area**.

## Menus

The menus at the top of the operation window contain:

### File Menu:

1. Open Favorite Group - You can configure your favorite group and save the configuration into one file. Using this option, you can load your configuration file for favorite group.
2. Save Favorite Group - You can configure your favorite group and save the configuration into one file. Using this option, you can save your favorite group into one configuration file.
3. Auto-Initial Group - If you want to have the same favorite group configuration when you exit ADAM.NET utility and launch it again, you need to check this option.
4. Exit - Exit ADAM.NET Utility.

### Tools Menu:

1. Search - Search all the ADAM-2000, ADAM-4000, ADAM-5000, ADAM-6000 and WSN-40000 modules you connected. The operation process will be described in Section 5.3.2.
2. Add Devices to Group - You can add ADAM-2000 modules to your favorite group by this option. You need to select the device you want to add in the **Module Tree Display** area (it will be described below) first, and then select this option to add.
3. Print Screen - You can save current ADAM.NET Utility screen into an image file by this option.

### Setup Menu:

1. Favorite Group - You can configure your favorite group including add one new device, modify or delete one current device, sort current devices and diagnose connection to one device.
2. Refresh COM and LAN node - ADAM.NET utility will refresh the serial and LAN network connection situation.
3. Add COM Port Tree Nodes - This option is used to add serial COM ports in ADAM.NET Utility.
4. Show TreeView - Check this option to display the **Module Tree Display** area.

### Help Menu:

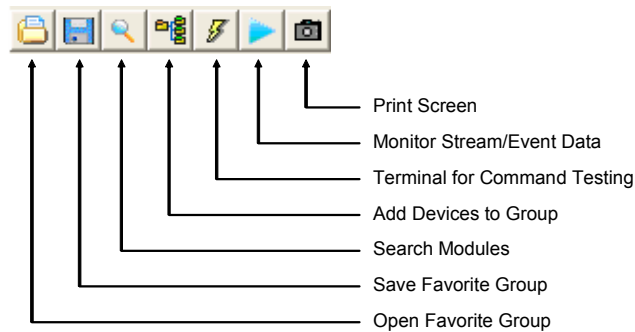
1. Check Up-to-Date on the Web - Choose this option, it will automatically connect to Advantech download website. You can download the latest utility there.
2. About Adam.NET Utility - Choose this option, you can see version of ADAM.NET Utility installed on your computer.

**Note!** The **Favorite Group** function is for the ADAM-4000, ADAM-5000/TCP and ADAM-6000



## Toolbar

There are 7 graphical icons on the toolbar for 7 common used options of Menu. Figure 5.2 below shows definition for each graphical icon.



## Module Tree Display Area

ADAM.NET Utility is one complete software tool that all ADAM remote I/O module and controller can be configured and operated in this utility. The **Module Tree Display** is on the left part of the utility operation window. There are five categories in the **Module Tree Display Area**:

- **Serial**  
All serial I/O Modules (ADAM-4000 and ADAM-5000 RS-485 serial modules) connected to the host PC will be listed in this category.
- **Ethernet**  
All Ethernet I/O Modules (ADAM-6000 and ADAM-5000 TCP modules) connected to the host PC will be listed in this category.
- **ADAM-4500\_5510 Series**  
This is a DOS interface utility for remote controllers such as ADAM-4500 and ADAM-5510 series.
- **Favorite Group**  
You can define which devices listed in the three categories above into your personal favorite group. This will make you easier to find your interested modules. Right click on the ADAM device item under the Favorite Group item and you can select **New >> Group** to create a new group. After you create your own group, right click on your group and select **New >> Adam device** to add ADAM devices into your group. You can also select **Diagnose connection** to check the communication.
- **Wireless Sensor Networks**  
The category contains the WSN-4000 and ADAM-2000 series. You can connect the WSN-4000 and ADAM-2000 series, through the serial interface. The WSN-4000 and ADAM-2000 series will be listed for further configuration.

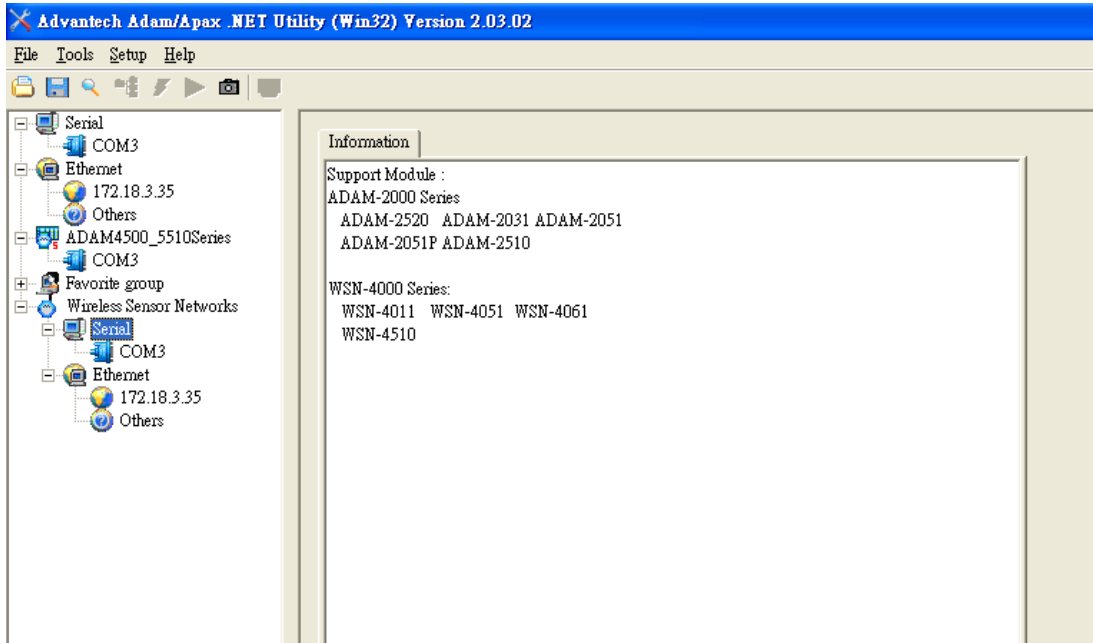
## Status Display Area

**Status Display** area, on the right part of utility operation window, is the main screen for operation. When you select different items in **Module Tree Display**, **Status Display** will change dependently. You can do all configurations and test in this area.

### 4.3.1 Search and Configure the ADAM-2000 Series

The ADAM-2000 series can be searched and configured through ADAM .NET Utility. Make sure the ADAM-2000 devices are installed properly in Initial Mode. For more information, please refer to the section 3.4.

The supported Wireless Sensor Networks Modules are listed in the information page

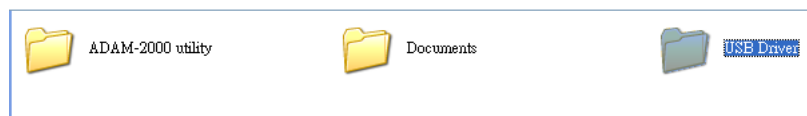


**Figure 4.3 ADAM-2000 Series ADAM .NET Utility Support**

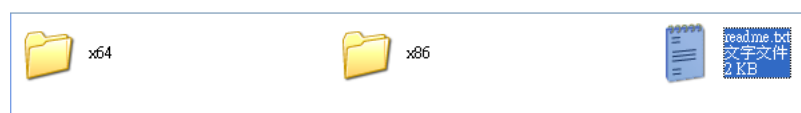
If the user wants to use USB cable to connection with ADAM utility on PC, they need to install USB chip driver in CD.

**Step 1**

Connect a USB cable between the ADAM-2520Z and the PC, and the system will pop out message to install new device, find the USB folder to select USB chip driver in out CD.

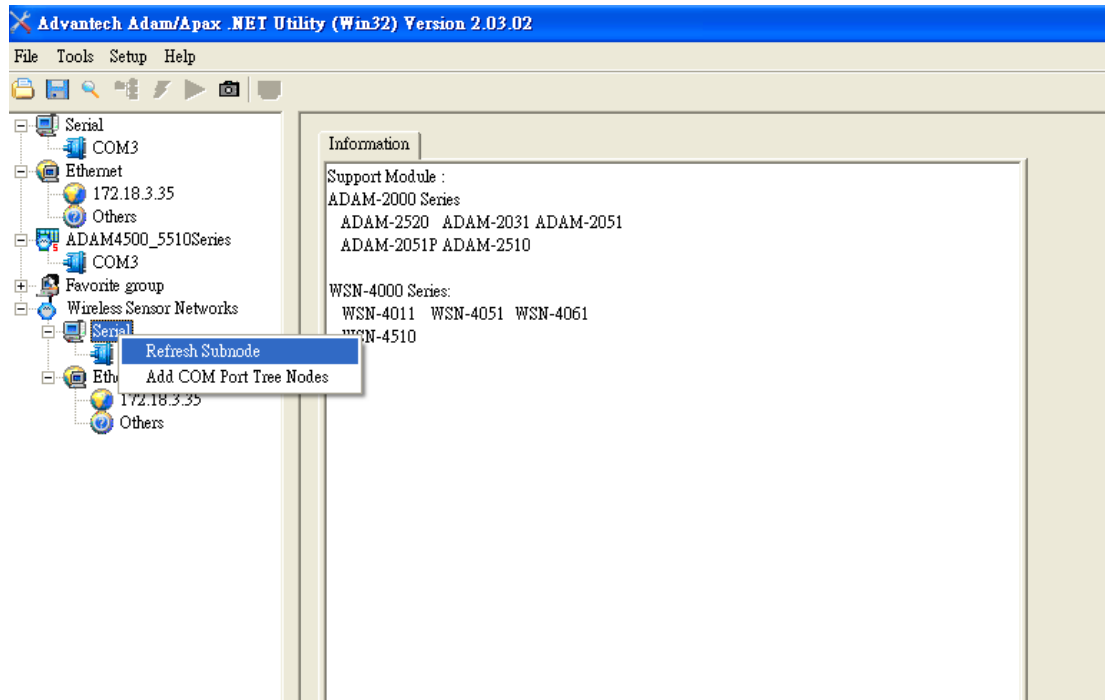


Base on your PC for 32 bit or 64 bit to select your suitable USB chip driver, then PC will auto install. After install finished, you can see which port your system get in device manager like bellow one. (Note: base on your system, this picture just for sample)



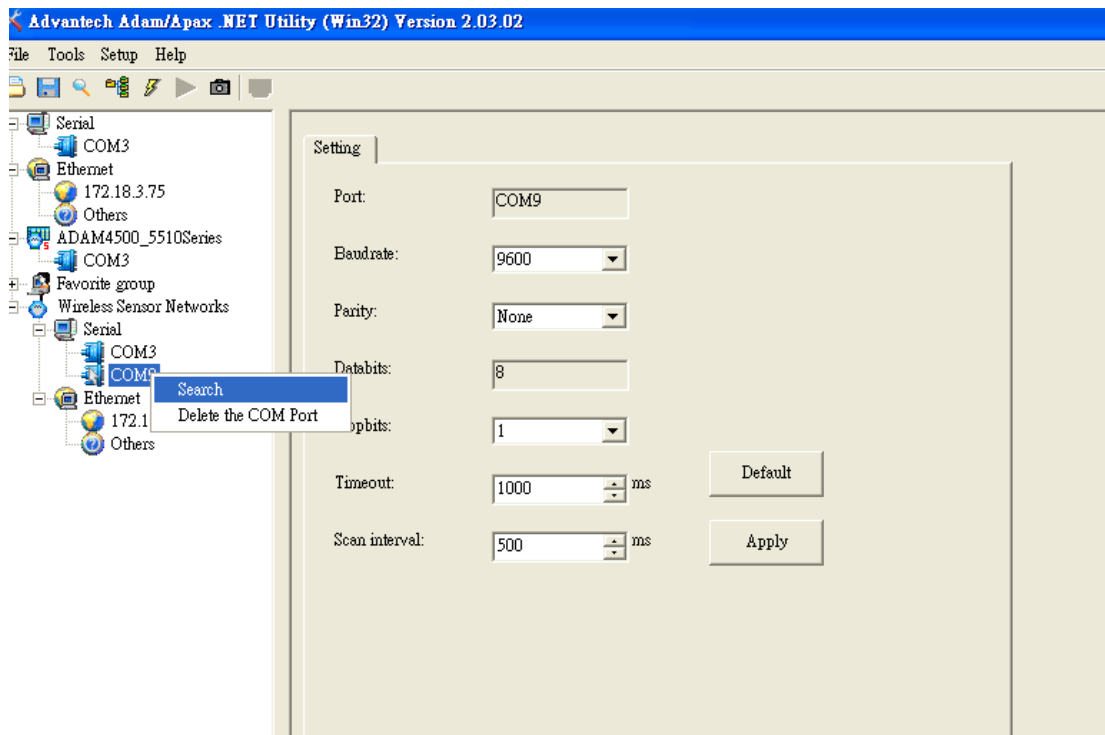
Then restart the ADAM utility.

Click the "Serial" in the Wireless Sensor Networks category then click right button to select the "Refresh Subnode" to search the virtual COM port on the host PC.



**Figure 4.4 Search the USB interface ADAM-2000 devices on the host PC for the virtual COM port.**

Click the COM port then click right button to select the "Search" to find the ADAM-2000 devices.



**Figure 4.5 Search the COM port for the ADAM-2000 devices.**

The "Searching the network" dialog will pop up, click "Start" to search the ADAM-2000 devices. The ADAM .NET Utility search the ADAM-2000 Coordinators from Modbus ID 241 to 244, please refer to the Appendix B.2 for more information.

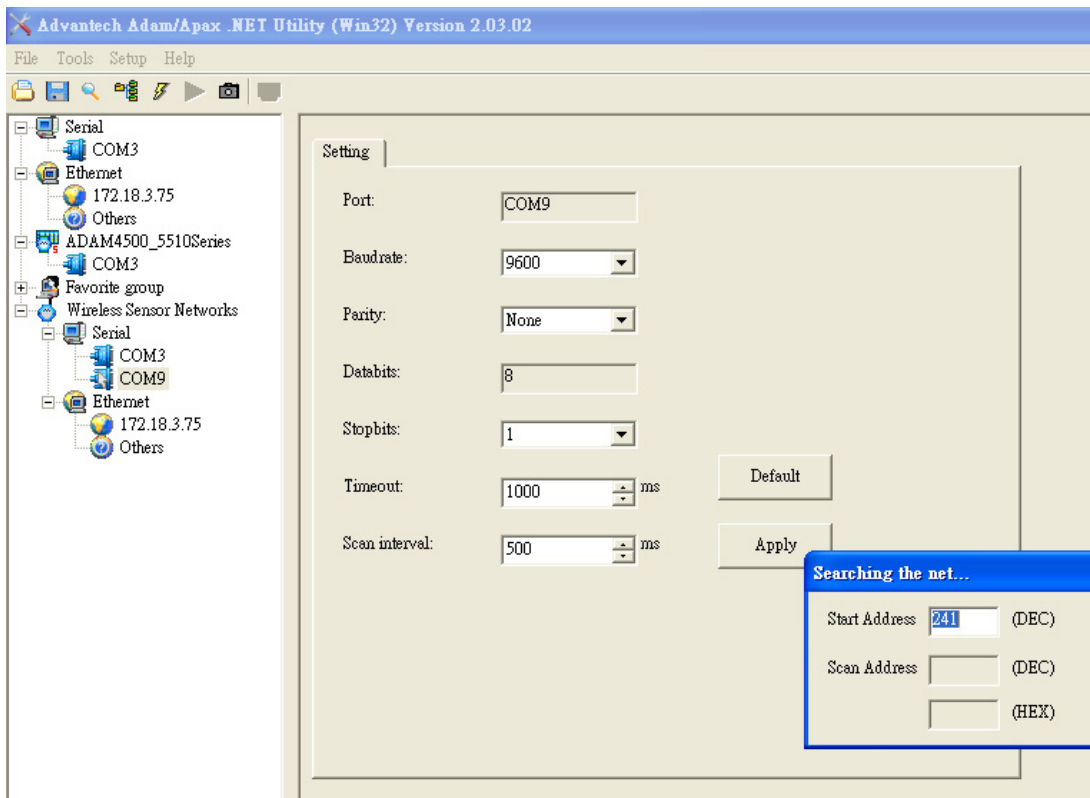


Figure 4.6 Searching the network dialog

The ADAM-2000 coordinators will be listed on the Tree View of the selected COM port till the Modbus is 244 or user can cancel the searching.

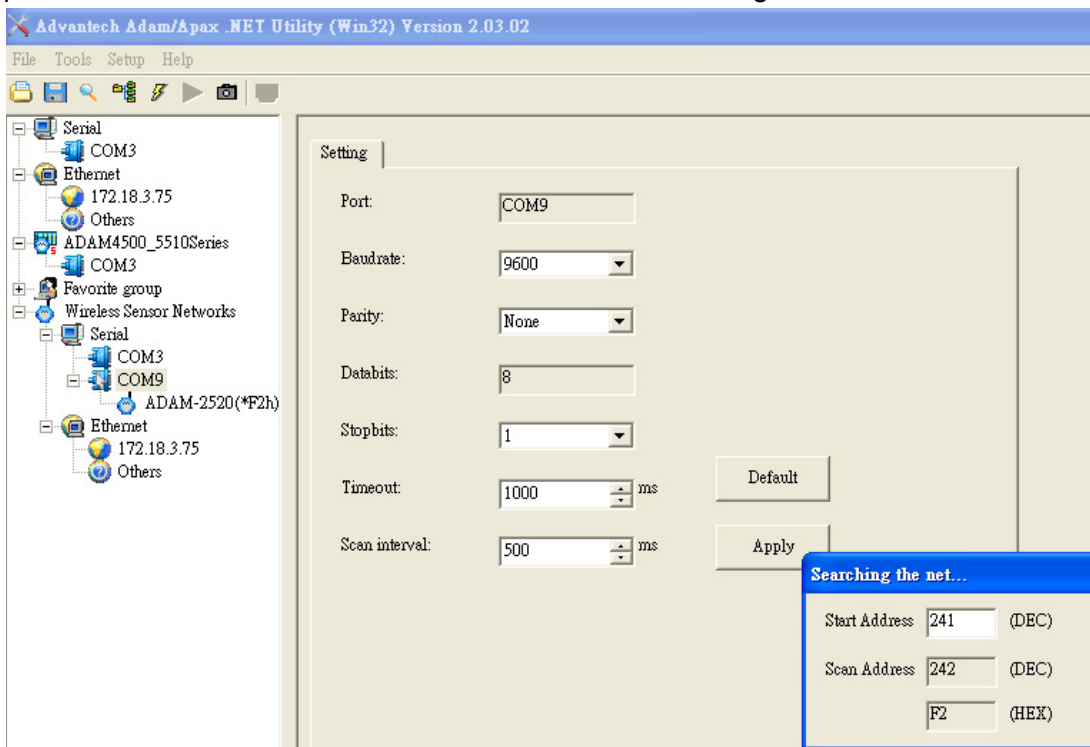


Figure 4.7 Searching the ADAM-2000 coordinators.

If you also want to connect ADAM-2000 series to utility at the same time,

1. Make sure they are in initial mode
2. Set PAN ID in the same group

Bellow picture is router or end-device signal label for you reference, it also list on ADAM-2000 series part.

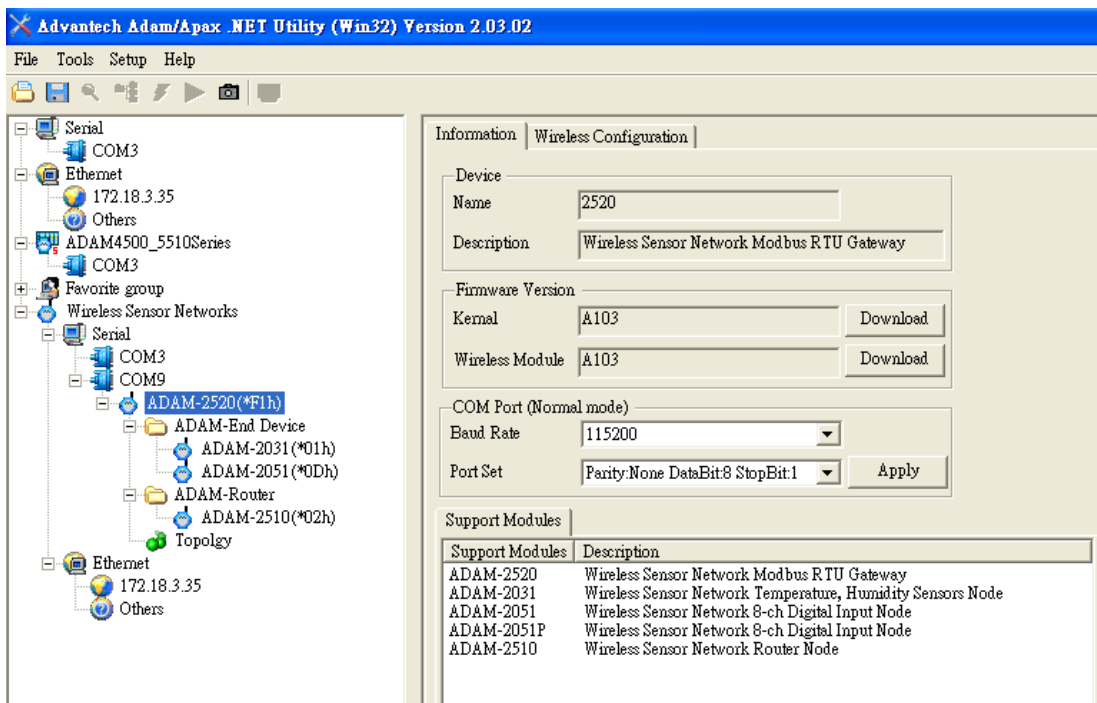
Press Button	Function
2 seconds	Reboot / Confirm
1 time	Link Quality Indicator
2 times	Battery Level
3 times	Associate
5 times	Pair ID

**Note!** ADAM-2520Z each time you turn to initial mode, beware its' PAD ID would be change because system will depend on your wireless environment to get PAD ID.



So must make sure your using system in the same PAN ID in same group.

While the searching is done, the ADAM-2000 devices will be listed on the Tree View with information and parameter pages. The ADAM-Router folder lists routers under the coordinator (Gateway). The ADAM-End Device folder lists end devices also under the coordinator (Gateway).



**Figure 4.8 ADAM-2000 devices lists on the Tree View and Information page.**

Folder of ADAM-End Device lists the ADAM-2000 end devices in Tree View and List View of End Device page. The page contains an overview of the end devices and the status.

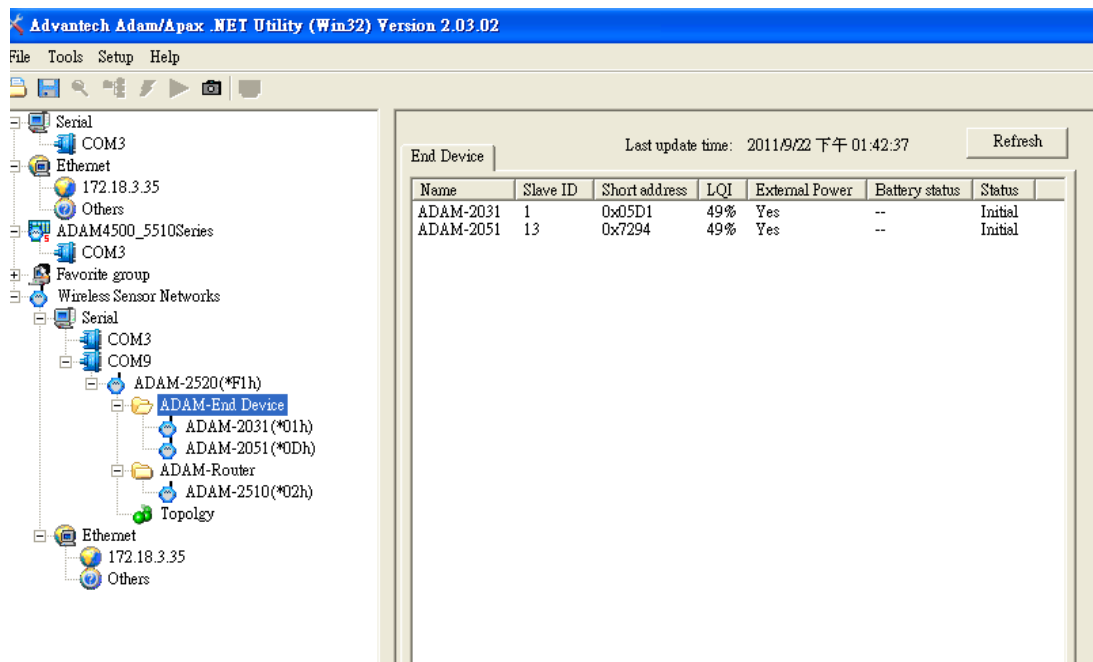


Figure 4.9 The overview of ADAM-2000 end devices.

Folder of ADAM-Router lists the ADAM-2000 routers in Tree View and List View of Router page. The page contains an overview of the routers and the status.

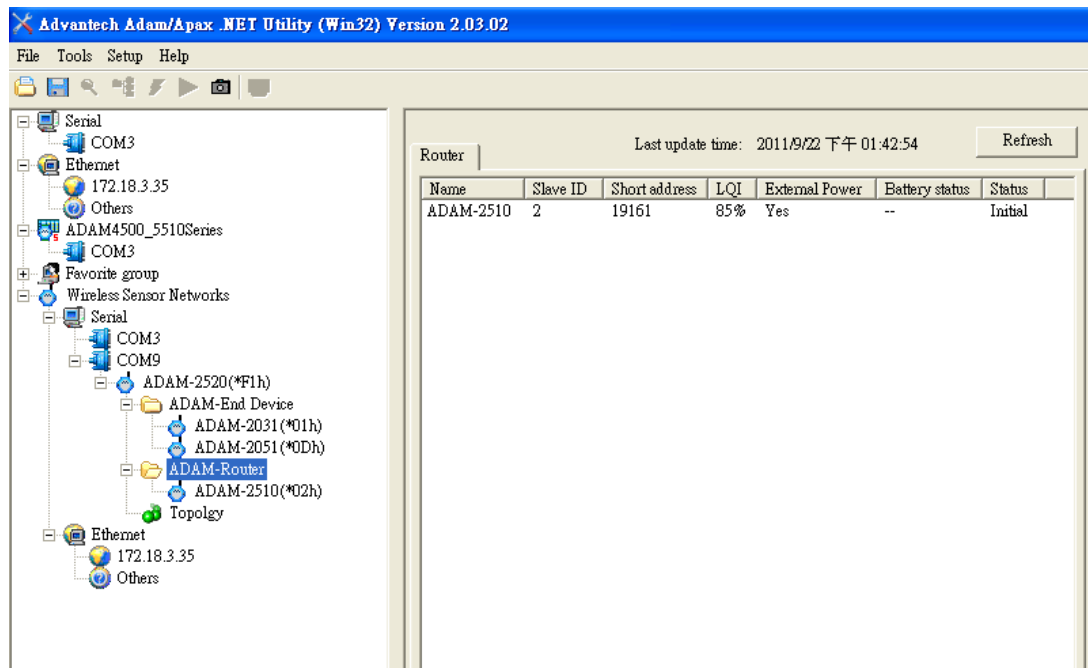


Figure 4.10 The overview of ADAM-2000 routers

#### 4.3.1.1 Gateway - ADAM-2520Z

Click the ADAM-2520Z, it will display the Information and Wireless Configuration pages.

In the Information page:

1. User can download the firmware to the ADAM-2520Z if there is any upgrade firmware from the Advantech.
2. User can modify the COM port parameters for **Normal Mode**.

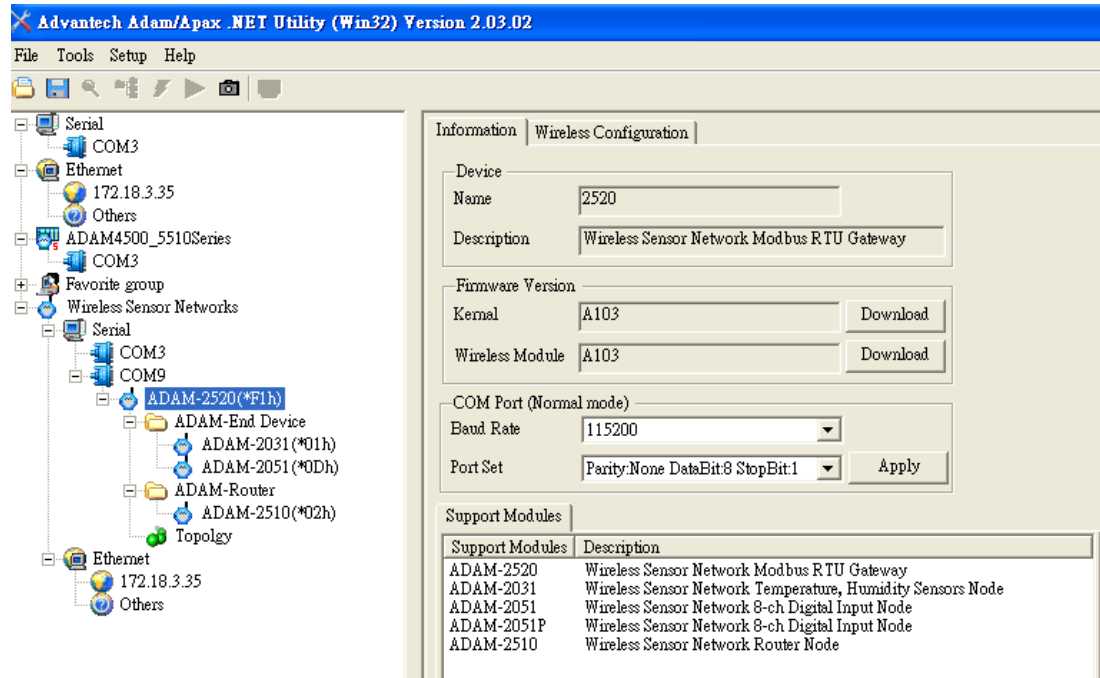


Figure 4.11 Information page of ADAM-2520Z

Select the "Wireless Configuration" page.

1. Set PAN ID and RF Channel to host a PAN for wireless communication in **Normal Mode**.
2. Set Slave ID for Modbus communication in **Normal Mode**.

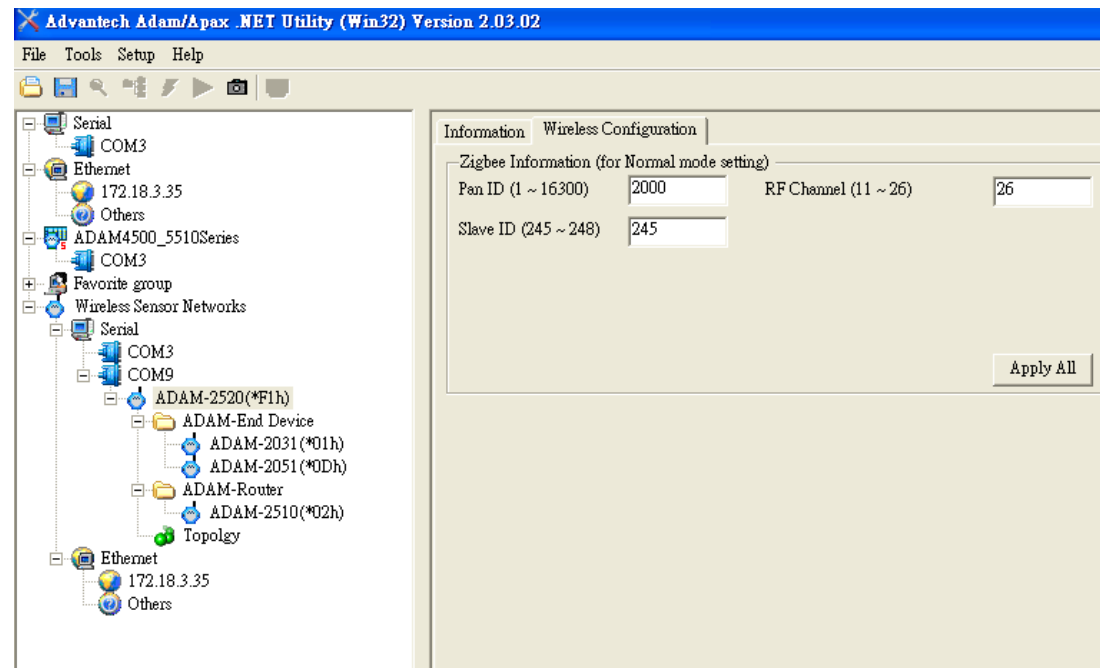
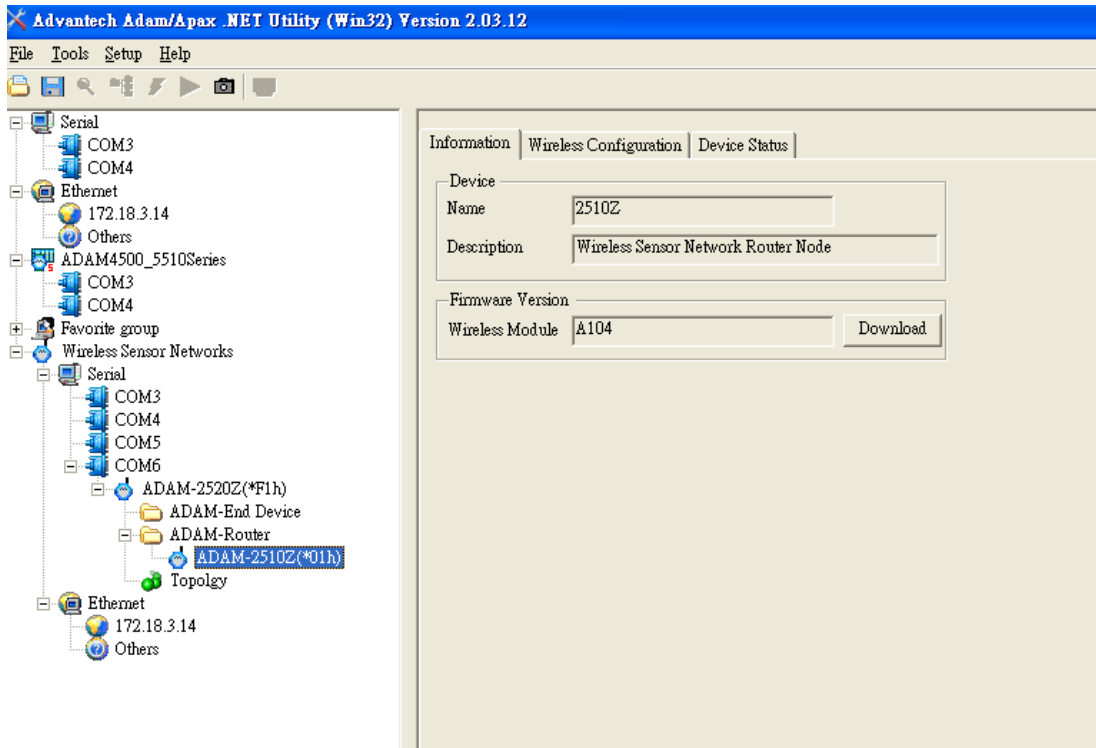


Figure 4.12 Wireless Configuration page of the ADAM-2520Z.



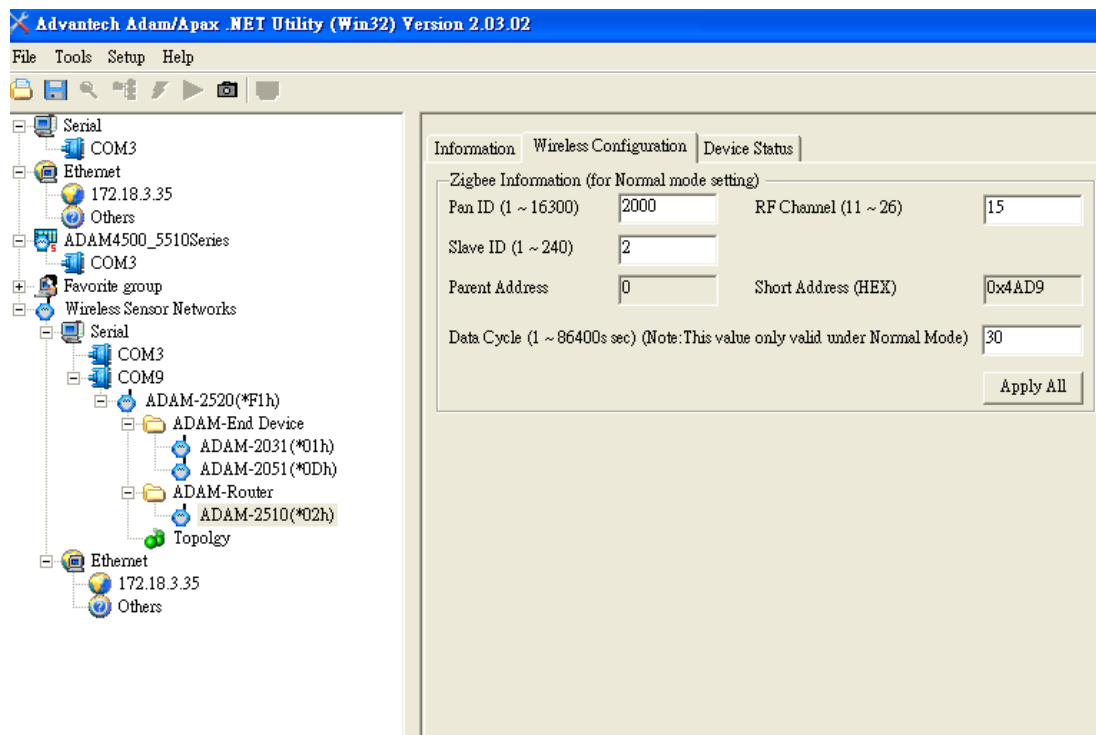
### 4.3.1.2 Router - ADAM-2510Z

Click the ADAM-2510Z, it will display the Information, Wireless Configurations and Device Status. In the Information page, users can download the firmware to the ADAM-2510Z if there is any upgrade firmware from the Advantech.



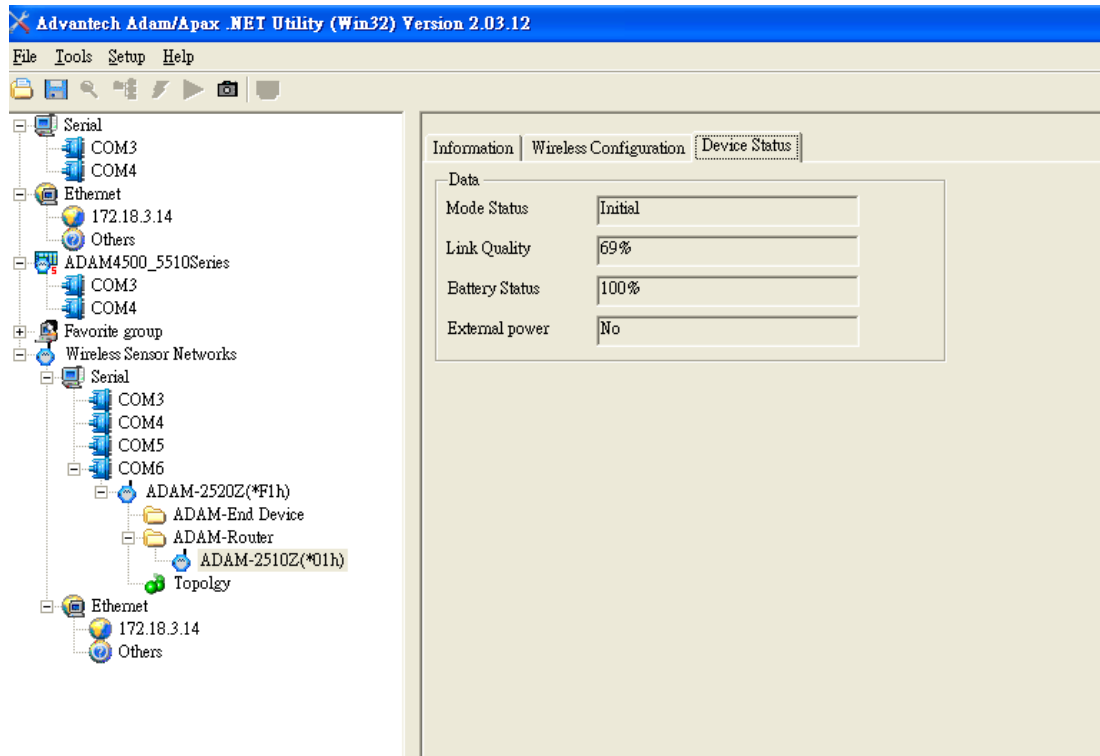
**Figure 4.13 Information page of ADAM-2510Z**

In the Wireless Configuration page, set PAN ID and RF Channel to host a PAN for wireless communication in **Normal Mode**.



**Figure 4.14 Wireless Configuration page of ADAM-2510Z**

In the Device Status page, user can check the Module Status, Link Quality, Battery Status and External Power of a device.

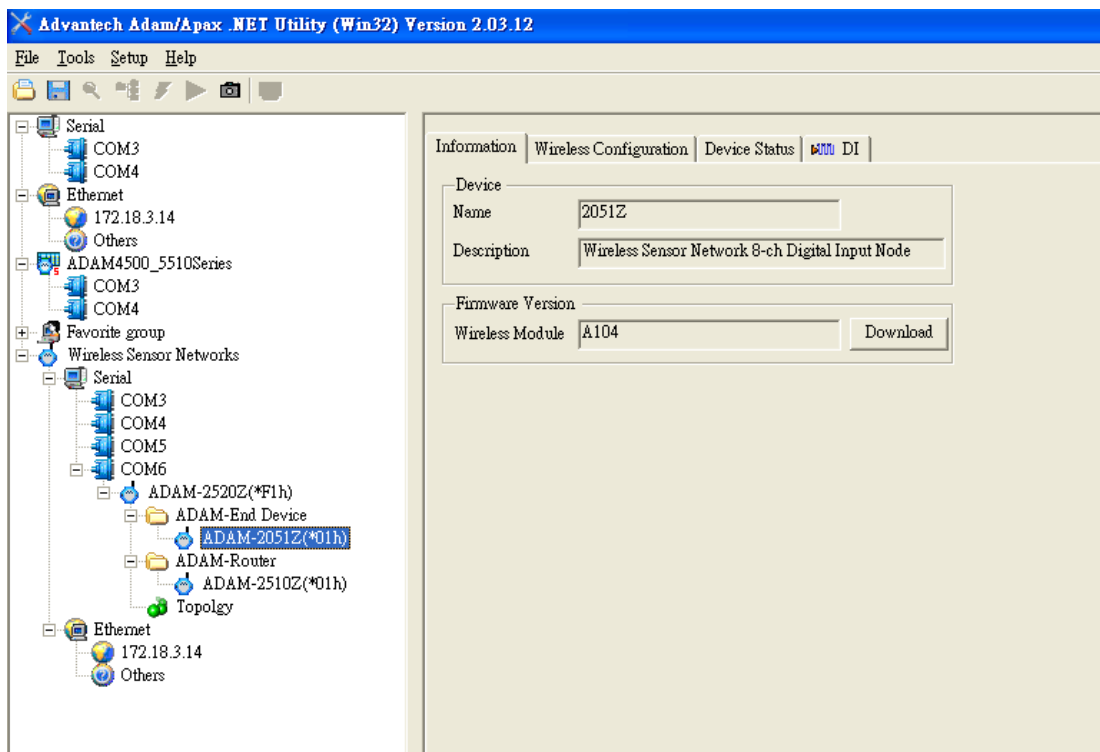


**Figure 4.15 The Device Status page of the ADAM-2510Z**

#### 4.3.1.3 End Device - ADAM-2017, ADAM-2031Z, ADAN-2051Z, ADAM-2051PZ

Click the ADAM-2051Z, it will display the Information and Wireless Configuration pages.

In the Information page, user can download the firmware to the ADAM-2051Z if there is any upgrade firmware from Advantech.



**Figure 4.16 Information Page of ADAM-2051Z**

In the “Wireless Configuration page”:

1. Set PAN ID and RF Channel to host a PAN for wireless communication in Normal Mode.
2. The Duty Cycle is the transmit interval of the device, the device can update the data by 1 second to 1 day.

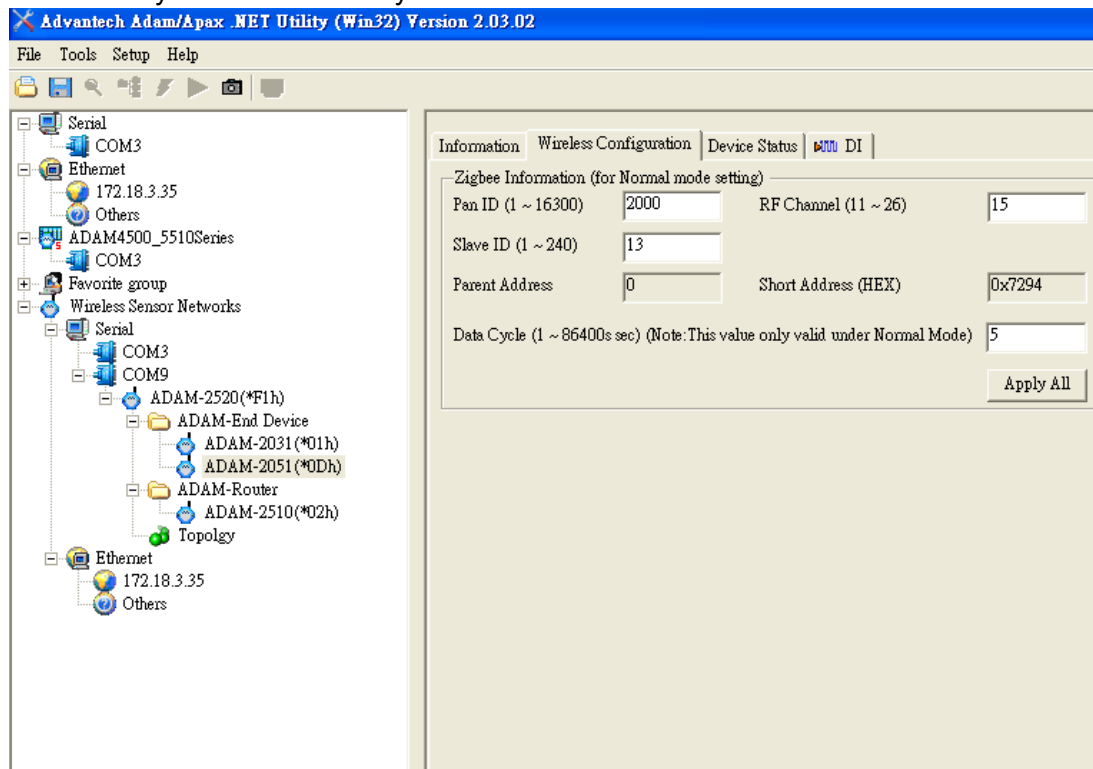


Figure 4.17 Wireless Configuration page of ADAM-2051Z

In the Device Status page, user can check the Module Status, Link Quality, Battery Status and External Power of a device.

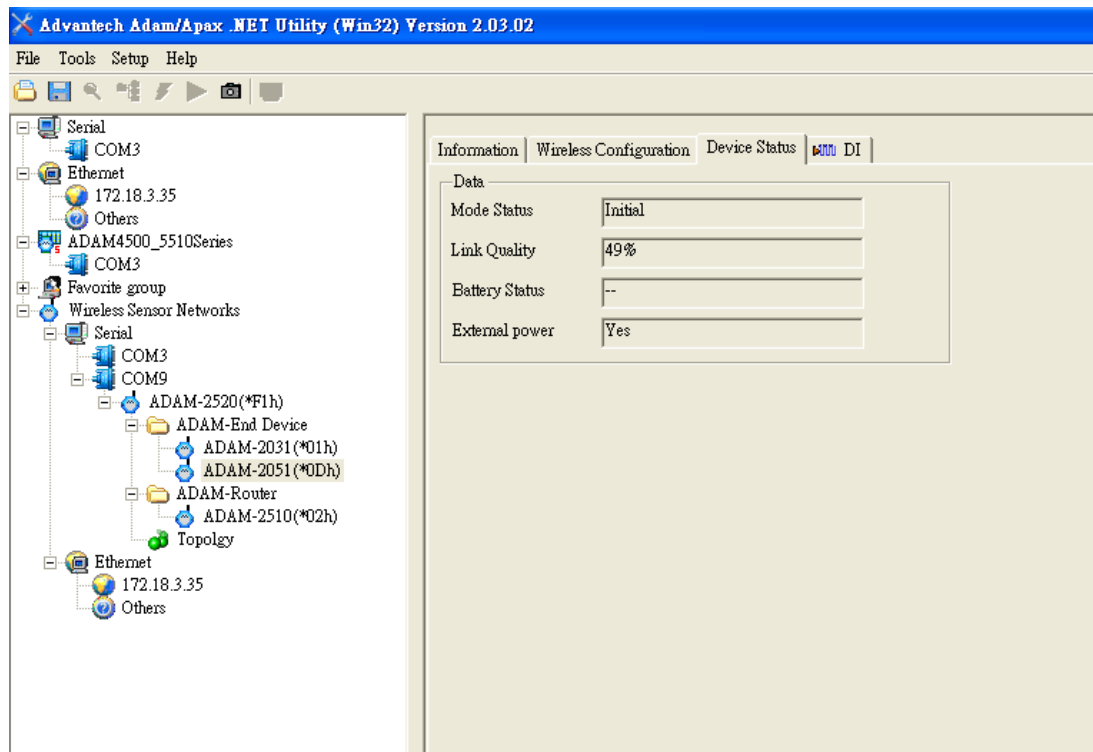
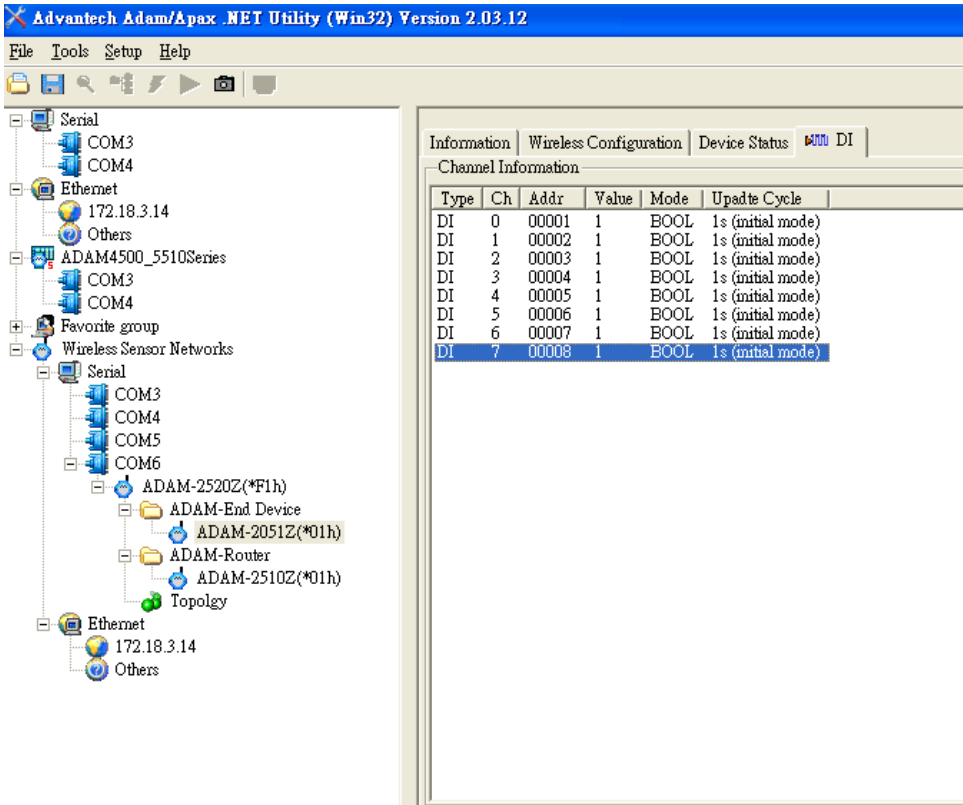


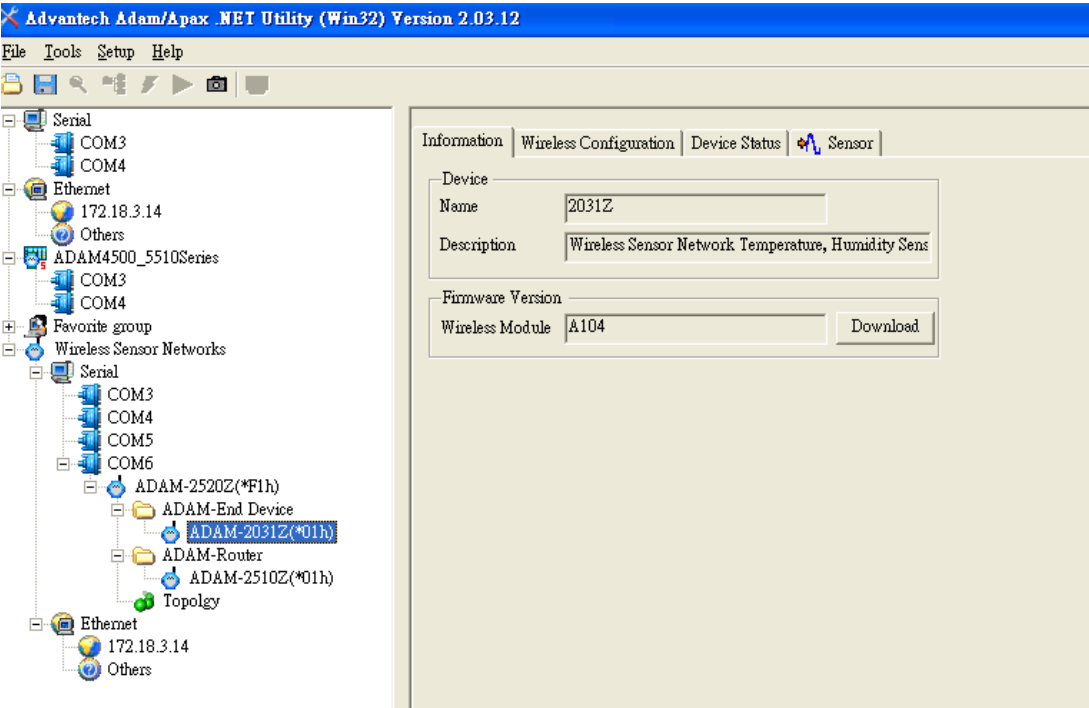
Figure 4.18 The Device Status page of the ADAM-2051Z

In the Signal page, user can check the physical value of the device by related channel or sensor.



**Figure 4.19 The Signal page of the ADAM-2051Z**

Click the ADAM-2031Z, it will display the Information and Wireless Configuration pages.

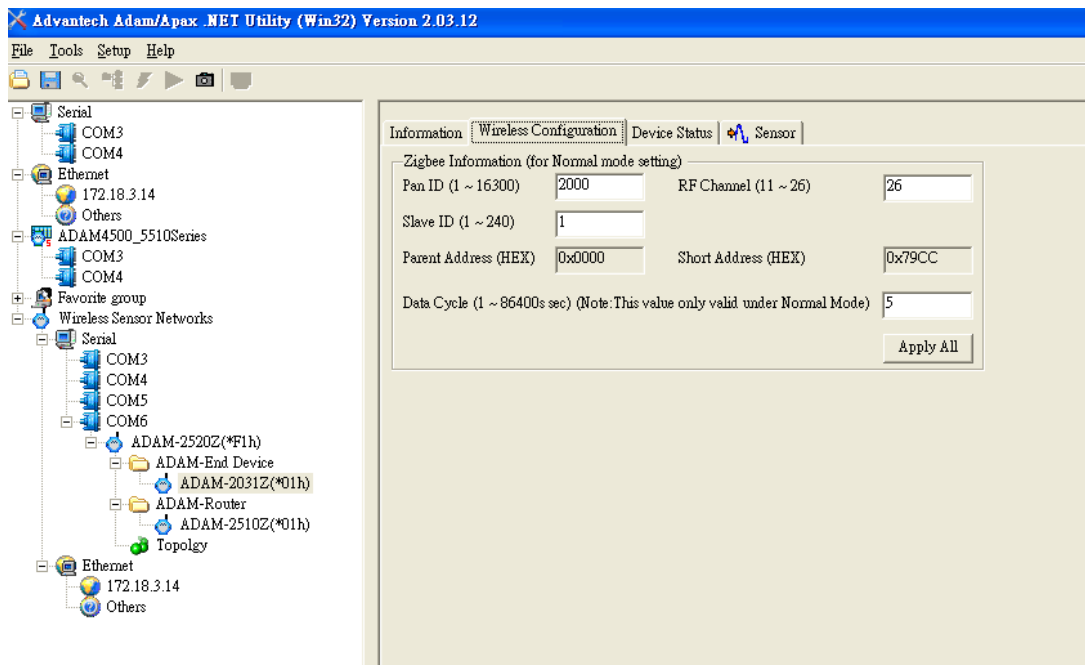


**Figure 4.20 Information Page**

In the Information page, user can download the firmware to the ADAM-2051Z if there is any upgrade firmware from Advantech.

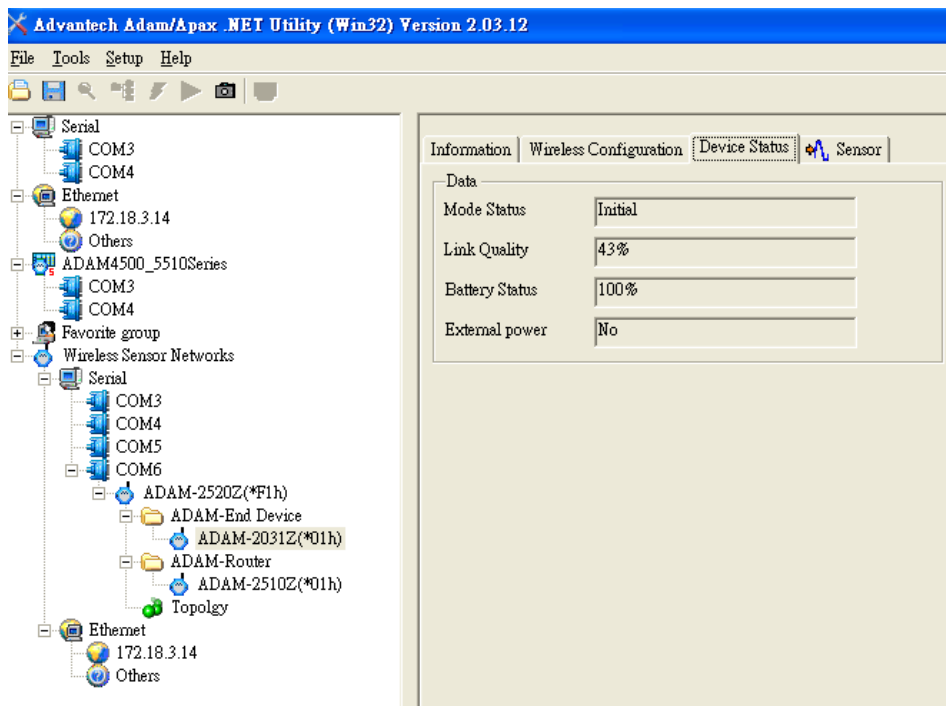
In the "Wireless Configuration page":

1. Set PAN ID and RF Channel to host a PAN for wireless communication in Normal Mode.
2. The Duty Cycle is the transmit interval of the device, the device can update the data by 1 second to 1 day.



**Figure 4.21 Wireless Configuration Page**

In the Device Status page, user can check the Module Status, Link Quality, Battery Status and External Power of a device.



**Figure 4.22 Device Status Page**

In the Sensor page, user can see data get form device by sensor.

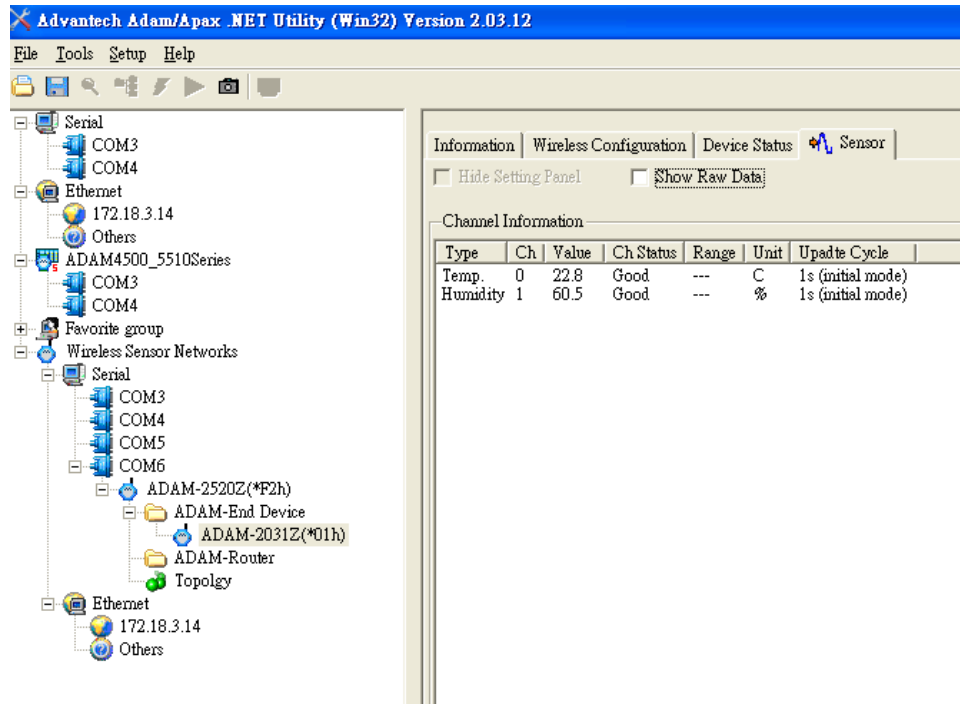


Figure 4.23 Sensor Page

### 4.3.2 Network Topology of ADAM-2000 Series

After the ADAM-2000 devices have been discovered, all the devices will be listed on the Tree View and the Topology also lists the relations between devices in advance. Click the Topology, the relations of ADAM-2000 devices will be illustrated in the Topology page. There are three components with model name and status listed on the Topology. The "C" represents the role of Coordinator, the "R" represents the role of Router and the "E" represents the role of End Device. You can scroll position on the screen using a mouse.

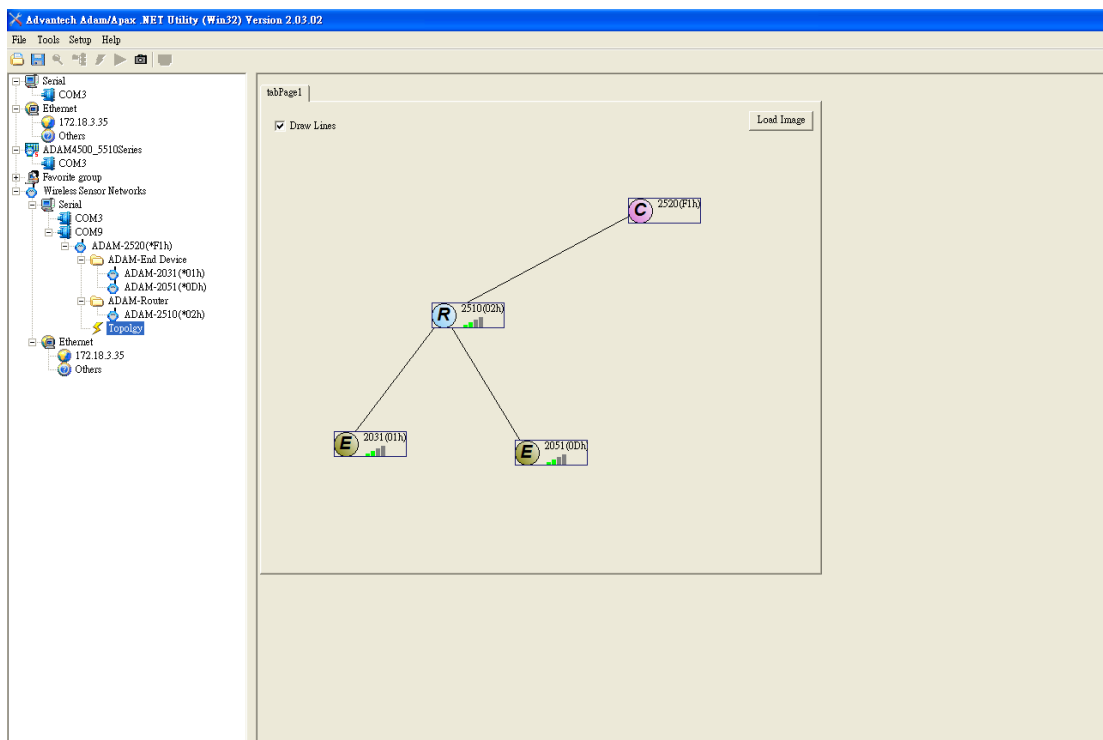


Figure 4.24 Topology of the ADAM-2000 series

The function allows user to put a picture on the background and drag the components to any positions of the background. With the function, user can easily maintain and check the status of the ADAM-2000 network.

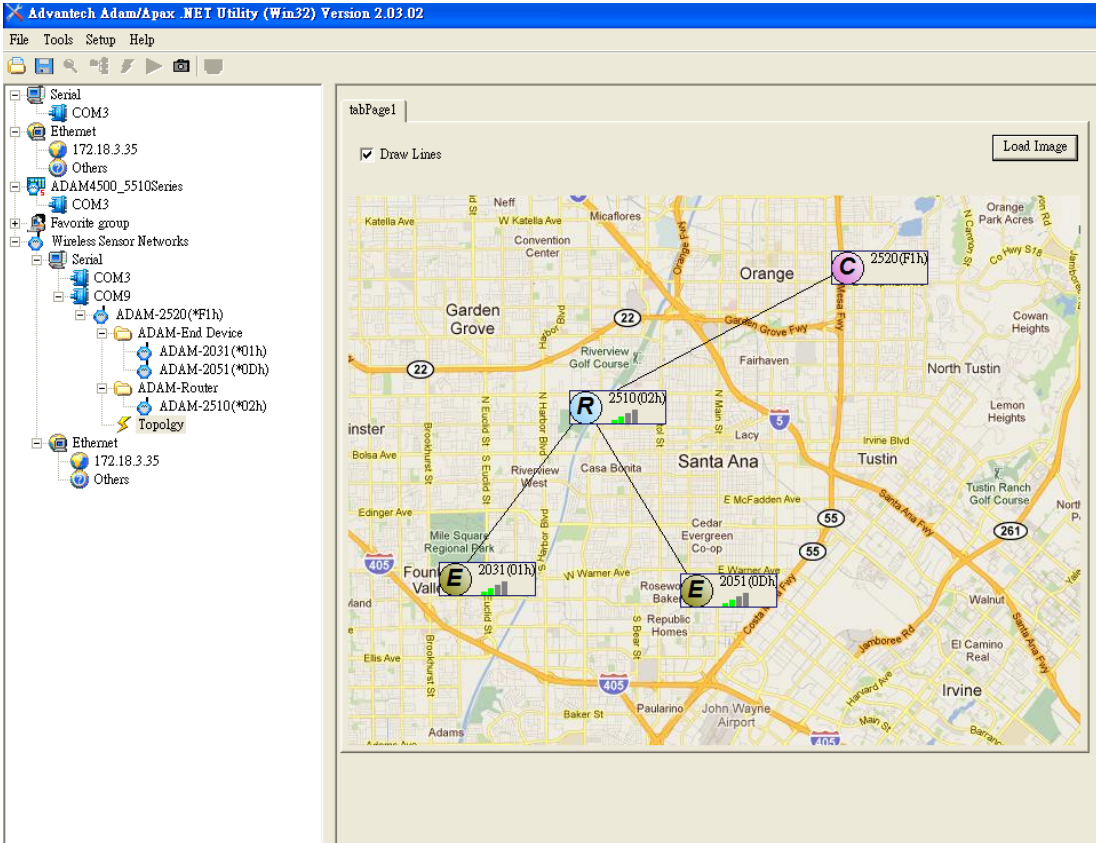


Figure 4.25 Topology of ADAM-2000 network with specific background image





# Appendix **A**

Module Introduction

---

## A.1 Communication Modules

### A.1.1 ADAM-2510Z

#### Wireless Sensor Network Router Node

ADAM-2510Z is a wireless signal repeater / router which is used to extend communication range between the coordinator/gateway and the end device.

#### A.1.1.1 ADAM-2510Z Specifications

##### Wireless:

- IEEE Standard: IEEE 802.15.4
- Modulation Type: DSSS (OQPSK)
- Frequency Band: ISM 2.4GHz (2.4 GHz ~ 2.4835 GHz)
- Channels: 11-26
- RF Data Rate: 250 Kbps
- Transmit Power:  $19 \pm 1$  dBm
- Receiver Sensitivity: -97dBm
- Antenna Type: Dipole
- Antenna Gain: 2 dBi
- Outdoor Range: 1000 m
- Topology: Star/ Tree/ Mesh
- Function: Router

##### General:

- Connectors: 1x plug-in terminal block (#14~22 AWG)
- Power Input: Unregulated 10 ~ 30 V<sub>DC</sub>
- Battery Input: 2 x AA Alkaline
- Power Consumption:
  - 0.5 W @ 24 V<sub>DC</sub>
  - 0.2 W @ 3 V<sub>DC</sub> (2x AA Alkaline Batteries)
- Operating Humidity: 20 ~ 95% RH
- Storage Humidity: 0 ~ 95% RH
- Operating Temperature:
  - External Power -20°C ~ 70°C (-4°F ~ 157.9°F)
  - Battery Power 0°C ~ 50°C (32°F ~ 122°F)
- Storage Temperature: -20°C ~ 85°C (-4°F ~ 157.9°F)

## A.1.2 ADAM-2520Z

### Wireless Sensor Network Modbus RTU Gateway

The ADAM-2520Z is designed as a gateway to translate the IEEE 802.15.4 WPAN to Modbus Network. In a WPAN, the ADAM-2520Z works as a coordinator to collect and translate data from end devices to host PC.

#### A.1.2.1 Specifications

##### Wireless:

- IEEE Standard: IEEE 802.15.4
- Modulation Type: DSSS (OQPSK)
- Frequency Band: ISM 2.4GHz (2.4 GHz ~ 2.4835 GHz)
- Channels: 11-26
- RF Data Rate: 250 Kbps
- Transmit Power:  $19 \pm 1$  dBm
- Receiver Sensitivity: -97 dBm
- Antenna Type: Dipole
- Antenna Gain: 2 dBi
- Outdoor Range: 1000 m
- Topology: Star/ Tree/ Mesh
- Network Capacity: 32 nodes (Routers & End Devices)\*
- Max Routers Scale: 6\*6 pcs
- Function: Coordinator

\*Note: Based on user's configuration

##### General:

- Connector:
  - 1x plug-in terminal block (#14-22 AWG)
  - 1x USB-type A connector (type A to B cable provide)
- Protocol: Modbus RTU
- Power Input: Unregulated  $10 \sim 30 V_{DC}$
- Battery Input: 2 x AA Alkaline
- Power Consumption:
  - 0.8 W @  $24 V_{DC}$
  - 0.5 W @  $5 V_{DC}$  (USB)
  - 0.3 W @  $3 V_{DC}$  (2x AA Alkaline Batteries)
- Operating Humidity: 20 ~ 95% RH
- Storage Humidity: 0 ~ 95% RH
- Operating Temperature:
  - External Power  $-20^{\circ}C \sim 70^{\circ}C$  ( $-4^{\circ}F \sim 157.9^{\circ}F$ )
  - Battery Power  $0^{\circ}C \sim 50^{\circ}C$  ( $32^{\circ}F \sim 122^{\circ}F$ )
- Storage Temperature:  $-20^{\circ}C \sim 70^{\circ}C$  ( $-4^{\circ}F \sim 157.9^{\circ}F$ )

## A.2 I/O and Sensor Modules

### A.2.1 ADAM-2017Z

#### Wireless Sensor Network 6-ch Analog Input Node

The ADAM-2017 is an analog input data acquisition module with 6 channels to measure the voltage and current.

#### A.2.1.1 Specifications

##### Wireless:

- IEEE Standard: IEEE 802.15.4
- Modulation Type: DSSS (OQPSK)
- Frequency Band: ISM 2.4GHz (2.4 GHz ~ 2.4835 GHz)
- Channels: 11-26
- RF Data Rate: 250 Kbps
- Transmit Power:  $3\pm 1$  dBm
- Receiver Sensitivity: -97 dBm
- Antenna Type: Dipole
- Antenna Gain: 2 dBi
- Outdoor Range: 200 m
- Topology: Star / Tree / Mesh
- Transmission Interval: 1 second ~ 24 hours
- Function: End Device

##### General:

- Connector: 1x plug-in terminal block (#14-22 AWG)
- Power Input: Unregulated 10 ~ 30 V<sub>DC</sub>
- Battery Input: 2 x AA Alkaline
- Power Consumption: 0.3 W @ 24 V<sub>DC</sub>
- Operating Humidity: 20 ~ 95% RH
- Storage Humidity: 0 ~ 95% RH
- Operating Temperature:
  - External Power -20°C ~ 70°C (-4°F ~ 157.9°F)
  - Battery Power 0°C ~ 50°C (32°F ~ 122°F)
- Storage Temperature: -20°C ~ 70°C (-4°F ~ 157.9°F)

##### Analog Input

- Channels 8 (differential)
- Input Impedance > 10 M $\Omega$ (voltage) 120  $\Omega$ (current)
- Input Type mV, V, mA
- Input Range  $\pm 150$  mV,  $\pm 500$  mV,  $\pm 1$  V $\pm 5$  V,  $\pm 10$  V,  $\pm 20$  mA, 0-20 mA, 4-20 mA
- Accuracy  $\pm 0.1\%$  or Better (voltage)  $\pm 0.2\%$  or Better (current)
- Span Drift  $\pm 30$  ppm/°C
- Zero Drift  $\pm 6$   $\mu$ V/°C
- Resolution (Refer to mail)
- Sampling Rate 12 sample/second (total)
- CMR @ 50/60 Hz 100 dB
- NMR @ 50/60 Hz 65 dB

## A.2.2 ADAM-2031Z

### Wireless Sensor Network Temperature and Humidity Sensor Node

The ADAM-2031 is an end device embedded sensors to measure the temperature and humidity physical signal.

#### A.2.2.1 Specifications

##### Wireless:

- IEEE Standard: IEEE 802.15.4
- Modulation Type: DSSS (OQPSK)
- Frequency Band: ISM 2.4GHz (2.4 GHz ~ 2.4835 GHz)
- Channels: 11-26
- RF Data Rate: 250 Kbps
- Transmit Power: 3±1 dBm
- Receiver Sensitivity: -97dBm
- Antenna Type: Dipole
- Antenna Gain:0 dBi
- Outdoor Range: 200 m
- Transmission Interval: 1 second ~ 24 hours
- Function: End Device

##### General:

- Connector: 1x plug-in terminal block (#14-22 AWG)
- Power Input: Unregulated 10 ~ 30 V<sub>DC</sub>
- Battery Input: 2 x AA Alkaline
- Power Consumption:
  - 0.3 W @ 24 V<sub>DC</sub>
  - 420 uW @ 3 V<sub>DC</sub> (1 minute Tx interval with 2\* AA Batteries)
  - 240 uW @ 3 V<sub>DC</sub> (2 minute Tx interval with 2\* AA Batteries)
  - 150 uW @ 3 V<sub>DC</sub> (5 minute Tx interval with 2\* AA Batteries)
- Operating Humidity: 20 ~ 95% RH (non-condensing)
- Storage Humidity: 0 ~ 95% RH
- Operating Temperature: -20°C ~ 70°C (-4°F ~ 157.9°F)
- Storage Temperature: -20°C ~ 70°C (-4°F ~ 157.9°F)

##### Temperature Sensor Input

- Operating Range -40~85°C (-40 ~ 185°F)
- Resolution 0.02°C (0.04°F)
- Accuracy ±0.3°C (0.6°F)
- Repeatability ±0.1°C (0.4°F)
- Response Time 5 ~ 30 seconds (Achieving 63% of a step function)
- Long Term Drift < 0.04°C/Year (0.07°F/Year)

##### Humidity Sensor Input

- **Operating Range** 0 ~ 100% RH
- **Resolution** 0.15% RH
- **Accuracy** ±2.0% RH
- **Repeatability** ±0.1% RH
- **Response Time** 8 seconds (Achieving 63% of a step function)
- **Long Term Drift** 0.5% RH/Year

## A.2.3 ADAM-2051Z

### Wireless Sensor Network 8-ch Digital Input Node

The ADAM-2051Z works as an end device provides 8-ch digital input.

#### A.2.3.1 ADAM-2051Z Specifications

##### Wireless:

- IEEE Standard: IEEE 802.15.4
- Modulation Type: DSSS (OQPSK)
- Frequency Band: ISM 2.4GHz (2.4 GHz ~ 2.4835 GHz)
- Channels: 11-26
- RF Data Rate: 250 Kbps
- Transmit Power:  $3\pm 1$  dBm
- Receiver Sensitivity: -97 dBm
- Antenna Type: Dipole
- Antenna Gain: 2 dBi
- Outdoor Range: 200 m
- Topology: Star / Tree / Mesh
- Transmission Interval: 1 second ~ 24 hours
- Function: End Device

##### General:

- Connector: 1x plug-in terminal block (#14-22 AWG)
- Power Input: Unregulated 10 ~ 30 V<sub>DC</sub>
- Battery Input: 2 x AA Alkaline
- Power Consumption:
  - 0.3 W @ 24 V<sub>DC</sub>
  - 380 uW @ 3 V<sub>DC</sub> (1 minute Tx interval with 2\* AA Batteries)
  - 220 uW @ 3 V<sub>DC</sub> (2 minute Tx interval with 2\* AA Batteries)
  - 130 uW @ 3 V<sub>DC</sub> (5 minute Tx interval with 2\* AA Batteries)
- Operating Humidity: 20 ~ 95% RH
- Storage Humidity: 0 ~ 95% RH
- Operating Temperature: -20°C ~ 70°C (-4°F ~ 157.9°F)
- Storage Temperature: -20°C ~ 70°C (-4°F ~ 157.9°F)

##### Digital Input:

- Channels: 8
- Input Resistance: 10 KOhm  
Supports wet and dry contacts
- Input Level:
  - Logical level 0: 0 ~ 0.8 V<sub>max</sub>
  - Logical level 1: 2.0 V<sub>min</sub> ~ 5.0 V<sub>max</sub>

## A.2.4 ADAM-2051PZ

### Wireless Sensor Network 8-ch Digital Input Node with Power Amplifier

The ADAM-2051PZ works as an end device provides 8-ch digital input with wireless power amplifier for better transmission power and receive sensitivity to enhance communication range and quality.

#### A.2.4.1 ADAM-2051PZ Specifications

##### Wireless:

- IEEE Standard: IEEE 802.15.4
- Modulation Type: DSSS (OQPSK)
- Frequency Band: ISM 2.4GHz (2.4 GHz ~ 2.4835 GHz)
- Channels: 11-26
- RF Data Rate: 250 Kbps
- Transmit Power:  $19 \pm 1$  dBm
- Receiver Sensitivity: -97 dBm
- Antenna Type: Dipole
- Antenna Gain: 2 dBi
- Outdoor Range: 1000 m
- Topology: Star / Tree / Mesh
- Transmission Interval: 1 second ~ 24 hours
- Function: End Device

##### General:

- Connectors: 1x Plug-in terminal block (#14-22 AWG)
- Power Input: Unregulated  $10 \sim 30 V_{DC}$
- Power Consumption:
  - $0.3 W @ 24 V_{DC}$
  - $380 \mu W @ 3 V_{DC}$  (1 minute Tx interval with 2\* AA Batteries)
  - $220 \mu W @ 3 V_{DC}$  (2 minute Tx interval with 2\* AA Batteries)
  - $130 \mu W @ 3 V_{DC}$  (5 minute Tx interval with 2\* AA Batteries)
- Operating Humidity: 20 ~ 95% RH
- Storage Humidity: 0 ~ 95% RH
- Operating Temperature:  $-20^{\circ}C \sim 70^{\circ}C$  ( $-4^{\circ}F \sim 157.9^{\circ}F$ )
- Storage Temperature:  $-20^{\circ}C \sim 70^{\circ}C$  ( $-4^{\circ}F \sim 157.9^{\circ}F$ )

##### Digital Input

- Channels: 8
- Input Resistance: 10 KOhm  
Supports wet and dry contacts
- Input Level:
  - Logical level 0:  $0 \sim 0.8 V_{max}$
  - Logical level 1:  $2.0 V_{min} \sim 5.0 V_{max}$





# Appendix **B**

ADAM-2000 Series  
Functions

## B.1 Introduction

ADAM-2000 series supports Modbus RTU protocol and serves as Modbus slave devices that takes commands from a Modbus master. Each module has its own unique Modbus ID such that master can address each individual slave. The ADAM-2000 series are the Modbus RTU ready communication solution for Wireless Sensor Network data acquisition applications.

## B.2 ADAM-2000 I/O Modbus Mapping Table

To use the Modbus devices properly, the Modbus ID, Function code, Register Address and Value must be properly configured. In the session, you can find the detail Modbus information of the ADAM-2000 series.

**Table B.1: Modbus ID Table of ADAM-2000 series**

Function	Modbus ID Range
Coordinator	241 ~ 244 (Initial Mode), 245 ~ 248(Normal Mode)
Router	1~240
End Device	1~240

### B.2.1 ADAM-2520Z

#### Wireless Sensor Network Modbus RTU Gateway

03 Read Holding Register

**Table B.2: ADAM-2520Z Function Table**

Address 4x	Description	Attribute	Value
20001	Module Status	Read	Bit0: 0; Initial Mode
			Bit0: 1; Normal Mode
			Bit1: 0; No External Power Input
			Bit1: 1; External Power Input
20003	Battery Level	Read	0x0000; Low
			0x4000; Poor
			0x8000; Normal
			0xC000; Good
			0xFFFF; Excellent

## B.2.2 ADAM-2510Z

### Wireless Sensor Network Router Node

03 Read Holding Register

**Table B.3: ADAM-2510Z Function Table**

Address 4x	Description	Attribute	Value
20001	Module Status	Read	Bit0: 0; Initial Mode
			Bit0: 1; Normal Mode
			Bit1: 0; No External Power Input
			Bit1: 1; External Power Input
20002	LQI	Read	0x0000~0x00FF; 0x0000: No Signal, 0x00FF: Excellent
20003	Battery Level	Read	0x0000; Low
			0x4000; Poor
			0x8000; Normal
			0xC000; Good
20004	Device Inactive Period		0~51840; 0~51840 counts (5 seconds per count), 0xFFFF: Over 3 days

## B.2.3 ADAM-2017Z

### Wireless Sensor Network 6-ch Analog Input Node

03 Read Holding Register

**Table B.4: ADAM-2017Z Function Table**


Address 4X	Description	Attribute	Value
00001	Channel 1	Read	0x0000~0xFFFF; Selected input range
00002	Channel 2	Read	0x0000~0xFFFF; Selected input range
00003	Channel 3	Read	0x0000~0xFFFF; Selected input range
00004	Channel 4	Read	0x0000~0xFFFF; Selected input range
00004	Channel 5	Read	0x0000~0xFFFF; Selected input range
00004	Channel 6	Read	0x0000~0xFFFF; Selected input range
20001	Module Status	Read	Bit0: 0; Initial Mode
			Bit0: 1; Normal Mode
			Bit1: 0; No External Power Input
			Bit1: 1; External Power Input
20002	LQI	Read	0x0000~0x00FF; 0x0000: No Signal, 0x00FF: Excellent
20003	Battery Level	Read	0x0000; Low
			0x4000; Poor
			0x8000; Normal
			0xC000; Good
20004	Device Inactive Period		0~51840; 0~51840 counts (5 seconds per count), 0xFFFF: Over 3 days

## B.2.4 ADAM-2031Z


### Wireless Sensor Network Temperature and Humidity Sensors Node

**Table B.5: ADAM-2031Z Function Table**

Address 4X	Description	Attribute	Value
00001	Temperature Input	Read	0x0000 ~ 0xFFFF*
00002	Humidity Input	Read	0x0000 ~ 0xFFFF**
20001	Module Status	Read	Bit0: 0; Initial Mode
			Bit0: 1; Normal Mode
			Bit1: 0; No External Power Input
			Bit1: 1; External Power Input
20002	LQI	Read	0x0000~0x00FF; 0x0000: No Signal, 0x00FF: Excellent
20003	Battery Level	Read	0x0000; Low
			0x4000; Poor
			0x8000; Normal
			0xC000; Good
			0xFFFF; Excellent
20004	Device Inactive Period	Read	0~51840; 0~51840 counts (5 seconds per count), 0xFFFF: Over 3 days

**Note!**  \* The temperature  $T$  is calculated by inserting temperature signal output  $S_T$  into the following formula (result is in °C).

$$T = -46.85 + 175.72x \frac{S_T}{2^{16}}$$

**Note!**  \*\* The humidity  $RH$  is calculated by inserting humidity signal output  $S_{RH}$  into the following formula (result is in %RH)

$$RH = 6 + 125x \frac{S_{RH}}{2^{16}}$$

## B.2.5 ADAM-2051Z

### Wireless Sensor Network 8-ch Digital Input Node

**Table B.6: ADAM-2051Z Function Table**

Address 4X	Description	Attribute	Value
00001	DI 0	Read	Bit0: 0; Off
			Bit0: 1; On
00002	DI 1	Read	Bit0: 0; Off
			Bit0: 1; On
00003	DI 2	Read	Bit0: 0; Off
			Bit0: 1; On
00004	DI 3	Read	Bit0: 0; Off
			Bit0: 1; On
00005	DI 4	Read	Bit0: 0; Off
			Bit0: 1; On
00006	DI 5	Read	Bit0: 0; Off
			Bit0: 1; On
00007	DI 6	Read	Bit0: 0; Off
			Bit0: 1; On
00008	DI 7	Read	Bit0: 0; Off
			Bit0: 1; On
20001	Module Status	Read	Bit0: 0; Initial Mode
			Bit0: 1; Normal Mode
			Bit1: 0; No External Power Input
			Bit1: 1; External Power Input
20002	LQI	Read	0x0000~0x00FF; 0x0000: No Signal, 0x00FF: Excellent
20003	Battery Level	Read	0x0000; Low
			0x4000; Poor
			0x8000; Normal
			0xC000; Good
			0xFFFF; Excellent
20004	Device Inactive Period	Read	0~51840; 0~51840 counts (5 seconds per count), 0xFFFF: Over 3 days

## B.2.6 ADAM-2051PZ

### Wireless Sensor Network 8-ch Digital Input Node with Power Amplifier

**Table B.7: ADAM-2051PZ Function Table**

Address 4X	Description	Attribute	Value
00001	DI 0	Read	Bit0: 0; Off
			Bit0: 1; On
00002	DI 1	Read	Bit0: 0; Off
			Bit0: 1; On
00003	DI 2	Read	Bit0: 0; Off
			Bit0: 1; On
00004	DI 3	Read	Bit0: 0; Off
			Bit0: 1; On
00005	DI 4	Read	Bit0: 0; Off
			Bit0: 1; On
00006	DI 5	Read	Bit0: 0; Off
			Bit0: 1; On
00007	DI 6	Read	Bit0: 0; Off
			Bit0: 1; On
00008	DI 7	Read	Bit0: 0; Off
			Bit0: 1; On
20001	Module Status	Read	Bit0: 0; Initial Mode
			Bit0: 1; Normal Mode
			Bit1: 0; No External Power Input
			Bit1: 1; External Power Input
20002	LQI	Read	0x0000~0x00FF; 0x0000: No Signal, 0x00FF: Excellent
20003	Battery Level	Read	0x0000; Low
			0x4000; Poor
			0x8000; Normal
			0xC000; Good
			0xFFFF; Excellent
20004	Device Inactive Period	Read	0~51840; 0~51840 counts (5 seconds per count), 0xFFFF: Over 3 days

# Appendix **C**

Troubleshooting

---

## C.1 Troubleshooting

**Q1:** Why is the Error LED blinking?

**A1:**

1. The Coordinator is not hosting a PAN yet. The PAN ID and Channel might be occupied by another Coordinators. Change to different PAN ID and Channel in initial mode.
2. The Router/End Device is not joining a PAN. Check if there is a coordinator with specified PAN ID and Channel to join.
3. Battery level is low.

**Q2:** Why does the amber LED on Coordinator automatically add a count in initial mode?

**A2:** The Coordinator will automatically add the Pair ID while there is another Coordinator nearby and can be detected.

**Q3:** What are the functions of the amber LEDs in Router and End Device?

**A3:**

1. Press side button 1 time for LQI.
2. Press side button 2 times for battery level.
3. Press side button 5 times to change the Pair ID to associate with the specified Pair ID coordinator.

**Q4:** Why are all the amber LEDs on coordinator blinking while operating in initial mode?

**A4:** Four Pair ID can be selected in initial mode of coordinators. If there are five coordinators set in initial mode at the same time, the last one will blink to indicate there are no available Pair ID to use.

**Q5:** Does the ADAM-2520Z support the HW/SW flow control of serial communication?

**A5:** The ADAM-2520Z does not support the HW/SW flow control and the user application/software must turn off the HW/SW flow control.

**Q6:** Can I use the recharging battery as the ADAM-2000 series power input?

**A6:** The ADAM-2000 can use the Alkaline battery only. Besides, the Alkaline battery will not be charged while using the external power.

**Q7:** Does the utility support Microsoft Windows 7 32 & 64 bit versions?

**A7:** At present it just supports the 32bit version. A 64bit version will be released soon.



## C.2 Notice

1. When there are 4 set of devices being coordinated at the same time, the level Index light will be lit by turns.
2. Devices in initial mode will in high power consumption status, beware of your power status when using batteries.
3. When using the ADAM utility the initial value of an ADAM-2051Z is 1. The ADAM-2051Z also supports dry contacts.
4. If customers want to connect an ADAM-2000 model with SCADA software, they can use ADAM-utility to get ADAM-2000 system parameters then SCADA software can connect them according these parameters.

**Note!** ADAM-2000 models do not currently support Mod-scan. We will support this feature in the future.



ADAM-2000 models do not currently support OPC sever., We will support this feature in the future.

5. ADAM-2000 models do not support the "My Favorite" function in the ADAM utility.
6. When two set of devices are to be coordinated at the same time, the second set router and end-device connect to first set of devices.
7. When there are 2 sets of devices to coordinate with at the same time, they need to reset power to re-initial PAN ID if they want to connect to another set.

# ADVANTECH

## eAutomation

[www.advantech.com](http://www.advantech.com)

Please verify specifications before quoting. This guide is intended for reference purposes only.

All product specifications are subject to change without notice.

No part of this publication may be reproduced in any form or by any means, electronic, photocopying, recording or otherwise, without prior written permission of the publisher.

All brand and product names are trademarks or registered trademarks of their respective companies.

© Advantech Co., Ltd. 2011

**Notice :** The changes or modifications not expressly approved by the party responsible for compliance could void the user's authority to operate the equipment.

**IMPORTANT NOTE:** To comply with the FCC RF exposure compliance requirements, no change to the antenna or the device is permitted. Any change to the antenna or the device could result in the device exceeding the RF exposure requirements and void user's authority to operate the device.