

ADAM-6060W 6-channel Relay Output with DI Module

The ADAM-6060W is a high-density I/O module built-in a 10/100 based-T interface for seamless Ethernet connectivity. Bonding with an Ethernet port and web page, the ADAM-6060W offers 6 relay (form A) output and 6 digital input channels. It supports contact rating as AC 120V @ 0.5A, and DC 30V @ 1A. All of the Digital Input channels support input latch function for important signal handling. Mean while, these DI channels allows to be used as 1 KHz counter. Opposite to the intelligent DI functions, the Digital Output channels also support pulse output function.

ADAM-6060W

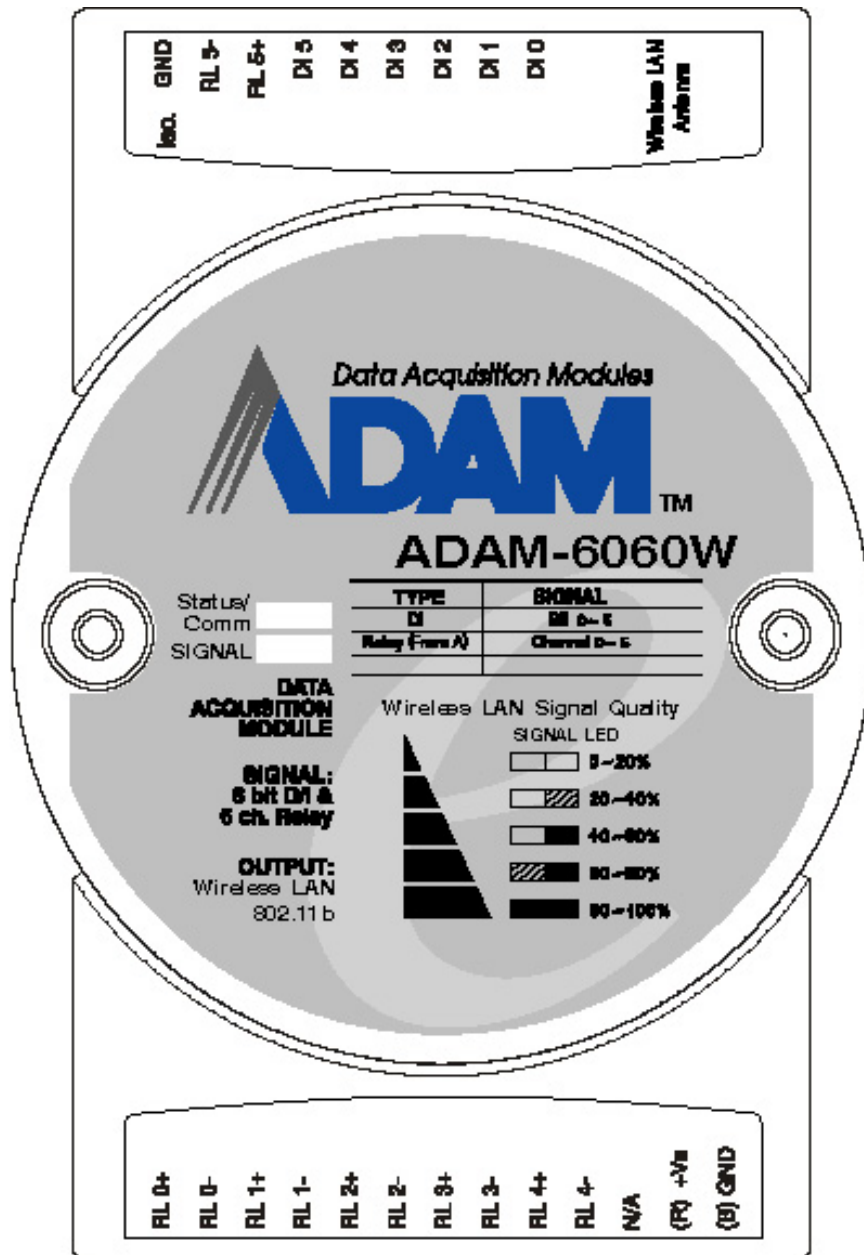

Figure 1: ADAM-6060W 6-channel Relay Output w/DI Module

ADAM-6060W Specification

- **Channel:** 12
- **I/O type:** 6 Relay & 6 DI
- **Relay Output** (Form A): Contact rating: AC: 120 V @ 0.5 A
DC: 30 V @ 1 A
Breakdown voltage: 500 V_{AC} (50/60 Hz)
Relay on time: 7 msec.
Relay off time: 3 msec.
Total switching time: 10 msec.
Insulation resistance: 1000 MW minimum at 500 V_{DC}
- **Digital Input:**
 - Dry Contact:
 - Logic level 0: Close to GND
 - Logic level 1: Open
 - Wet Contact:
 - Logic level 0: +3 V_{max}
 - Logic level 1: +10 to 30 V_{DC}
- **Optical Isolation:** 5000V_{RMS}
- **Communication:** Wireless LAN IEEE802.11b
- **Power Consumption:** 2 W (Typical)

Application Wiring

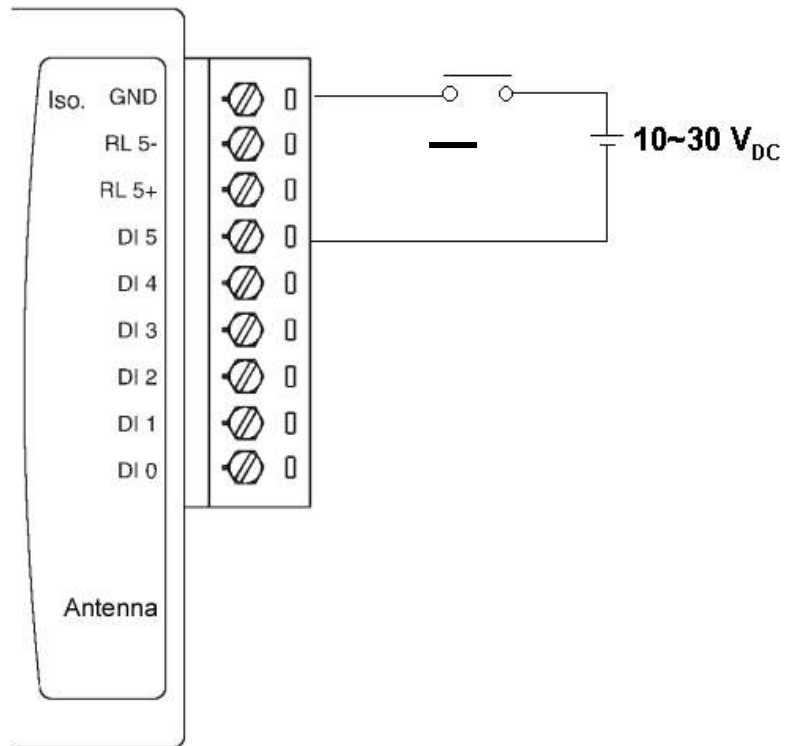

Figure 2: ADAM-6060W Digital Input (Wet Contact) Wiring

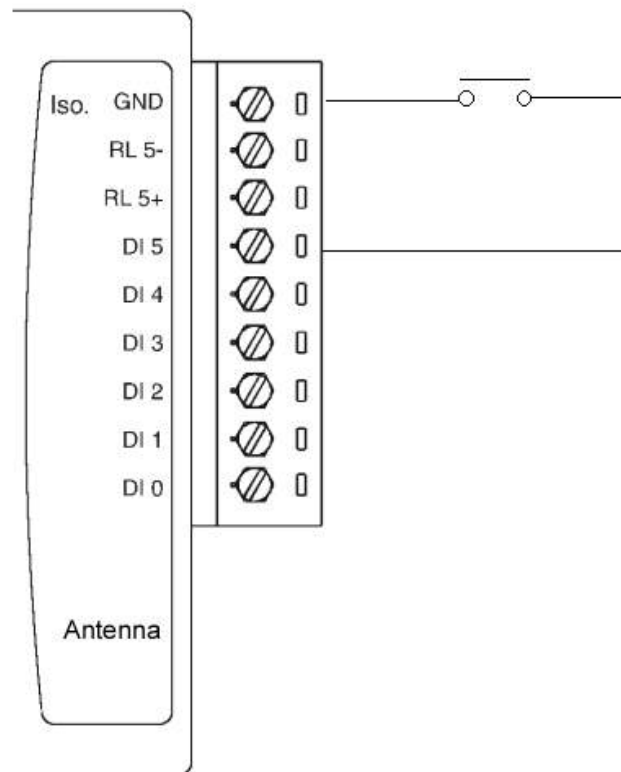

Figure 3: ADAM-6060W Digital Input (Dry Contact) Wiring

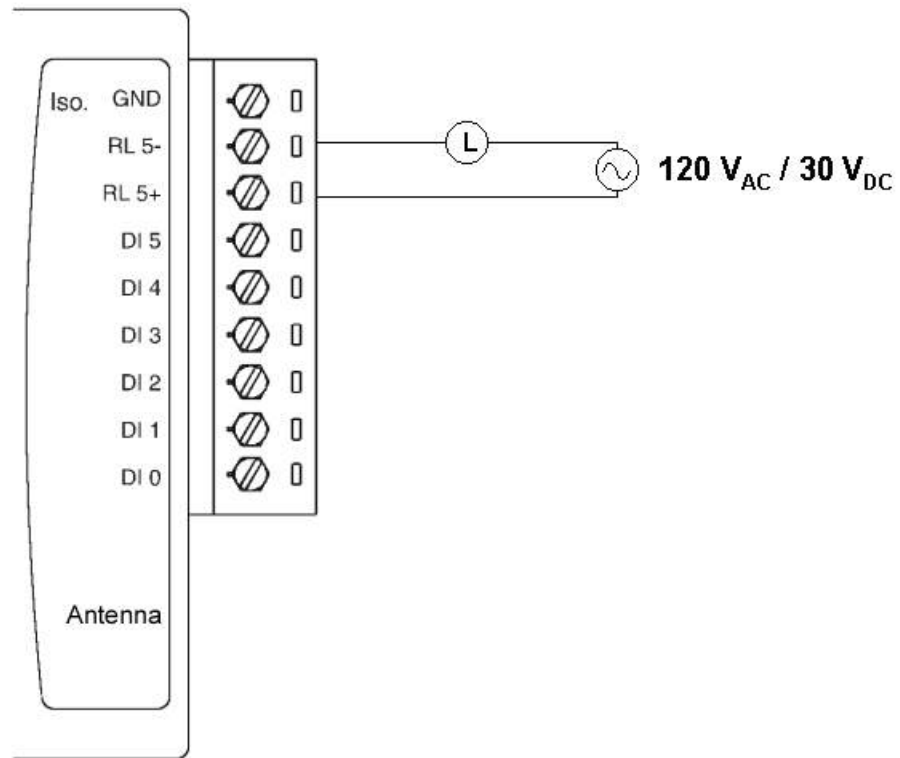
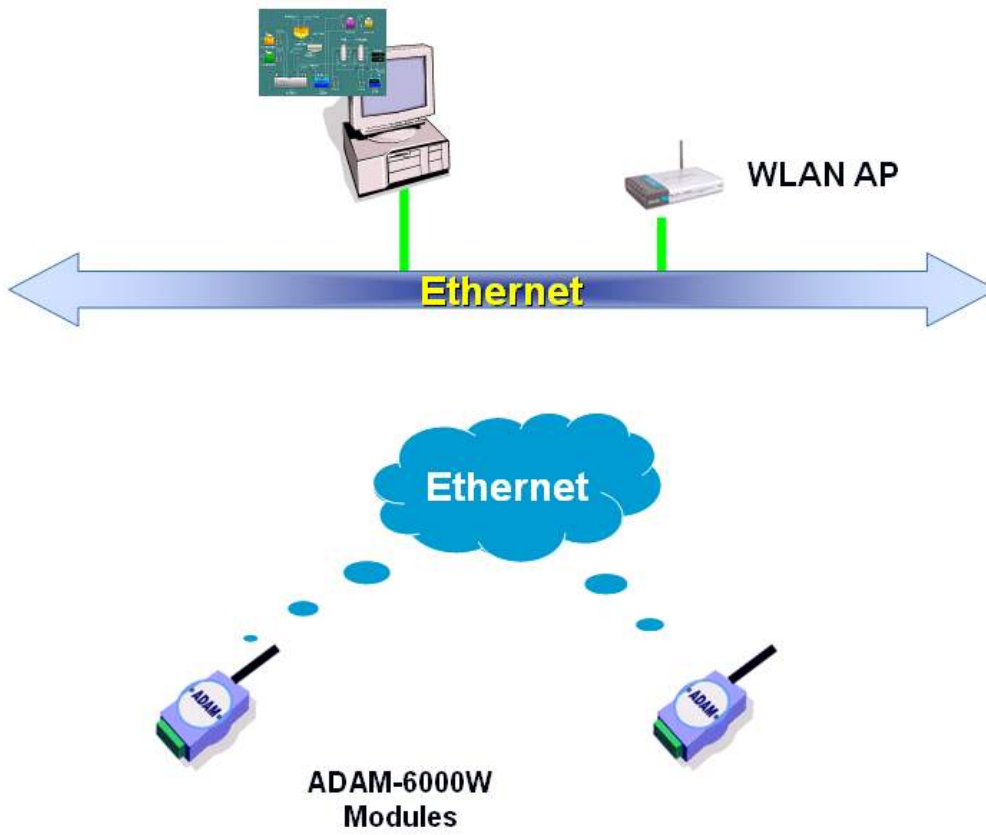

Figure 4: ADAM-6060W Relay Output Wiring

System Architecture



ADAM-6060W Configuration

Network Configuration

Step 1 : Please open the ADAM-5000TCP-6000 utility software. The utility software will automatically scan the ADAM-6000 modules. Please wait for the ADAM-6060W being found by utility software.

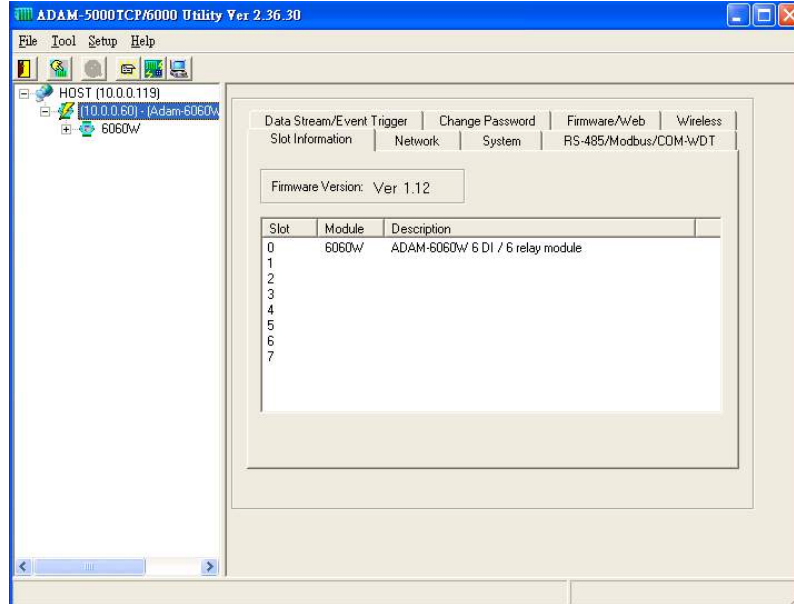

Step 2 : Please go the “Network” page to change the IP address/Subnet Address/Default Gateway of ADAM-6060W module to be compatible with user’s existing network and set the host idle time out value (the ADAM-6000 module can only accept 8 connection from host station. Any host station doesn’t request the communication with this ADAM-6000 module over the time out setting, the connection of this host station will be released for the other stations).

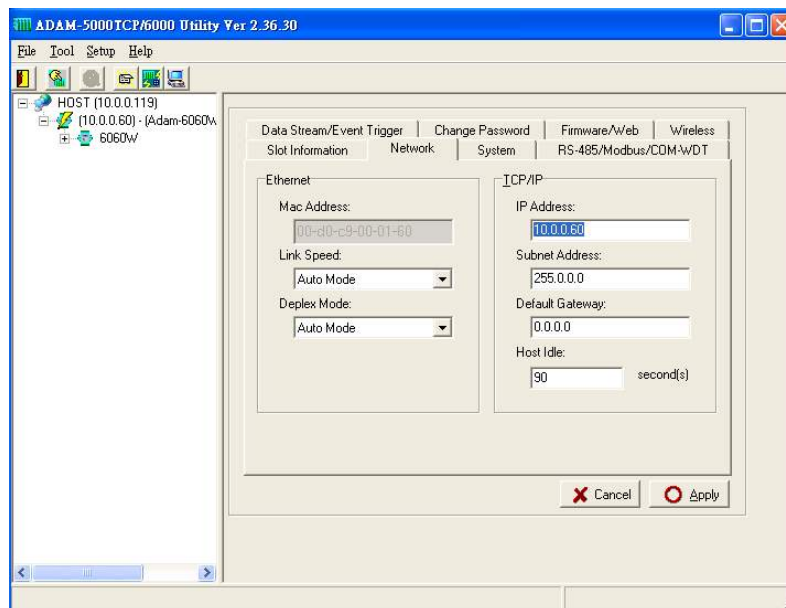

press “Apply” to download the new IP address to ADAM-6060W module (the default password for the changing configuration is “00000000”).



Step 3 : Re-configuring the IP address of the configuration PC to be the original setting (compatible with user's existing network) then re-start the utility software. The software will automatically search the ADAM-6060W module again.

Step 4 : Go to the "Wireless" page to set the wireless LAN configuration.

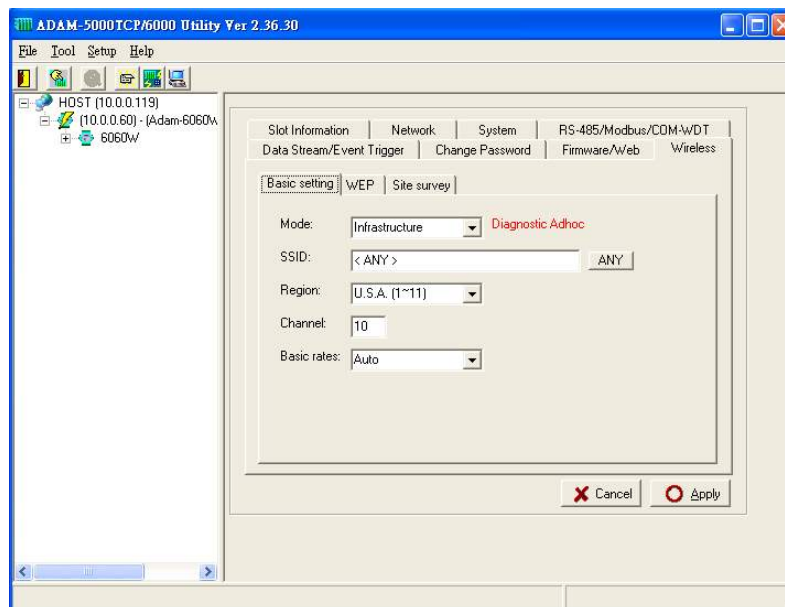

Please set the wireless LAN mode to be "Infrastructure" or "Adhoc" based on exact system architecture.

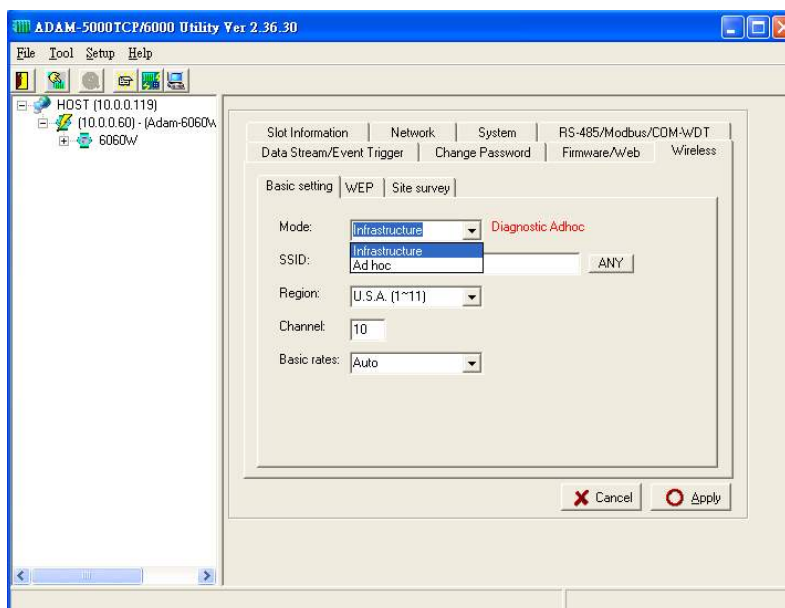

Please assign the SSID for the specific wireless AP to be connected with ADAM-6000W modules. User can place “ANY” key to let the ADAM-6000W modules to automatically search the existing wireless AP. Or key in the specific SSID to assign the dedicated AP (strongly recommending to set up the dedicated SSID, it can guarantee the communication of ADAM-6000W modules to be stable)

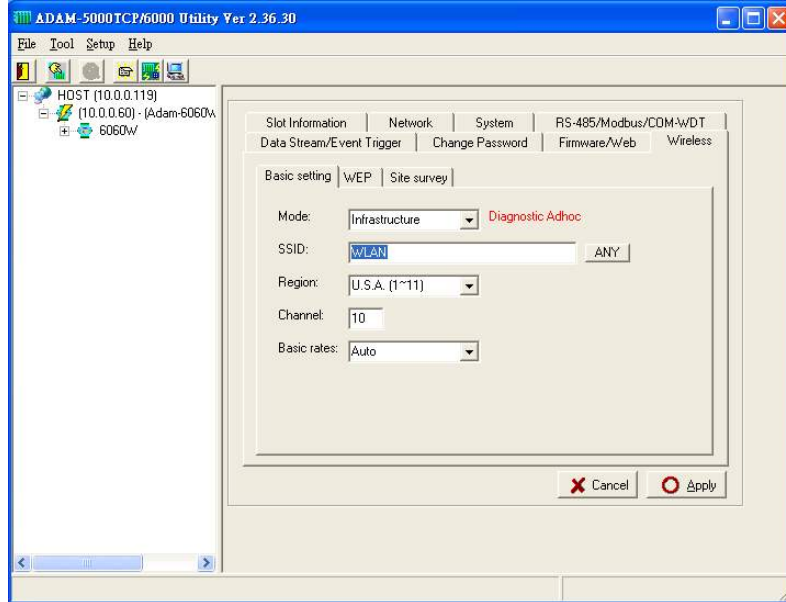

For assigning the dedicated wireless LAN AP, user can use the site survey function to check the existing AP in connection environment. Please go to the “Site Survey” page.

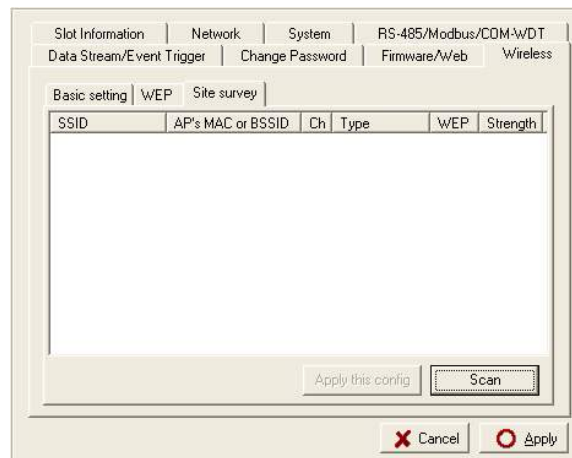

Press “Scan” button to search the existing AP.

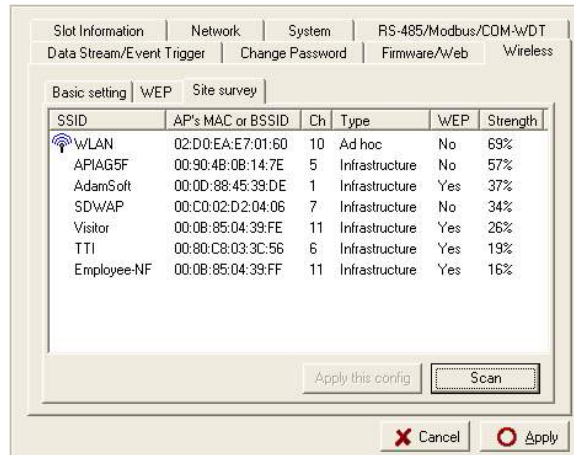

Selecting the AP in the searching result table.

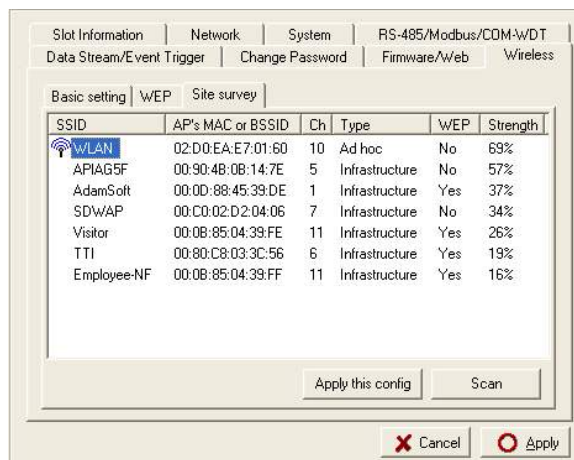

Press "Apply" bottom to accept the AP to finish the set up action.

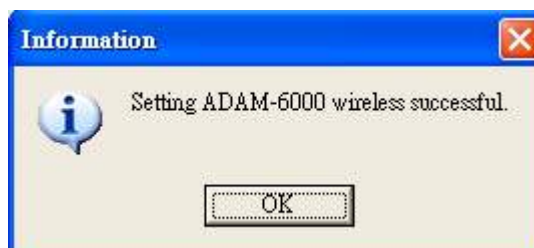
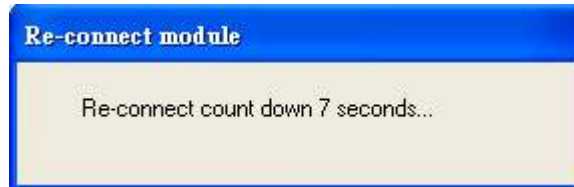

Please select the region for your area.

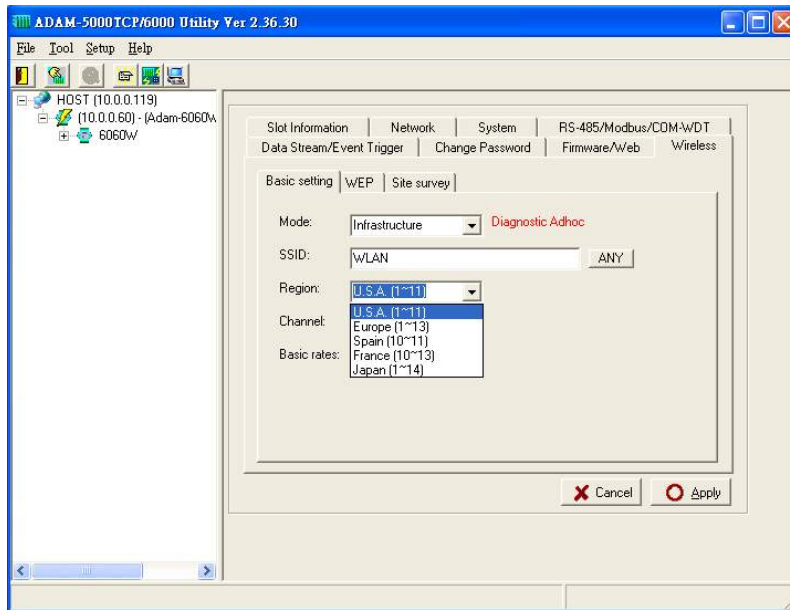

Setting the used channel, the channel number must be included in the channel segment of your region.

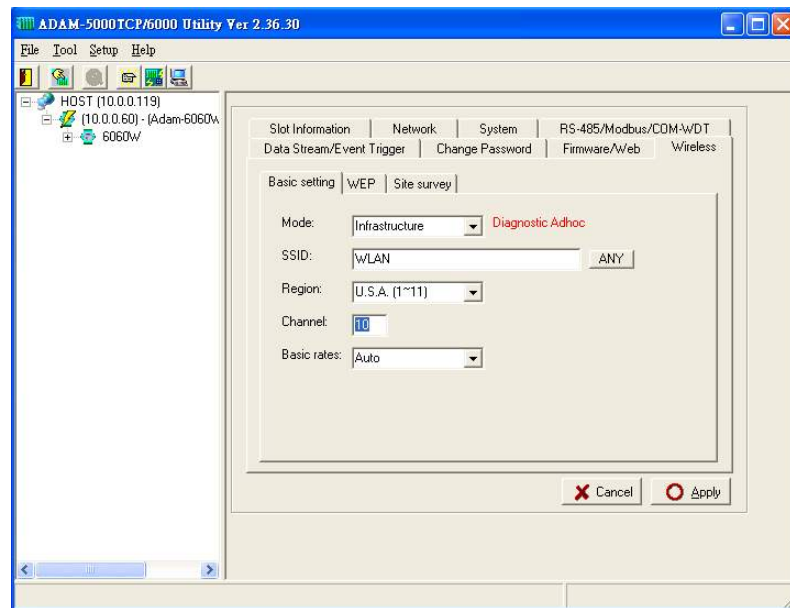

Please select the basic rate for the communication bandwidth.

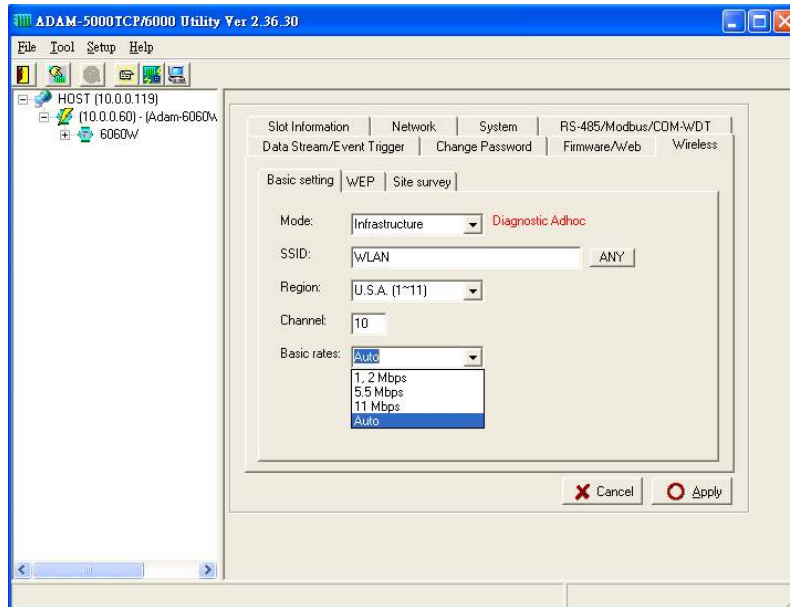

Press the "Apply" button to finish the set up work.

Step 5 : Configure the WEP security setting. Please go to the WEP page in "Wireless" of utility software.

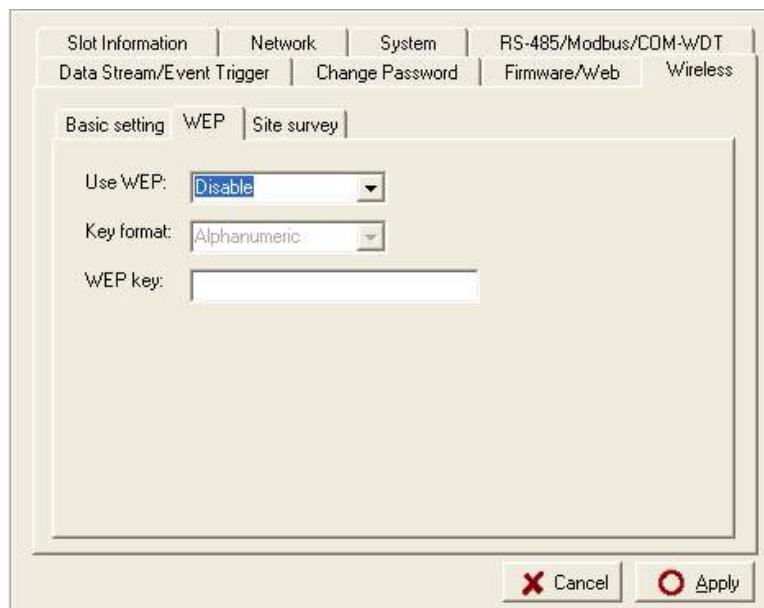

If user want to use the WEP security function, please enable the WEP function in "User WEP" then select the Key format and key in the WEP key for this requirement.

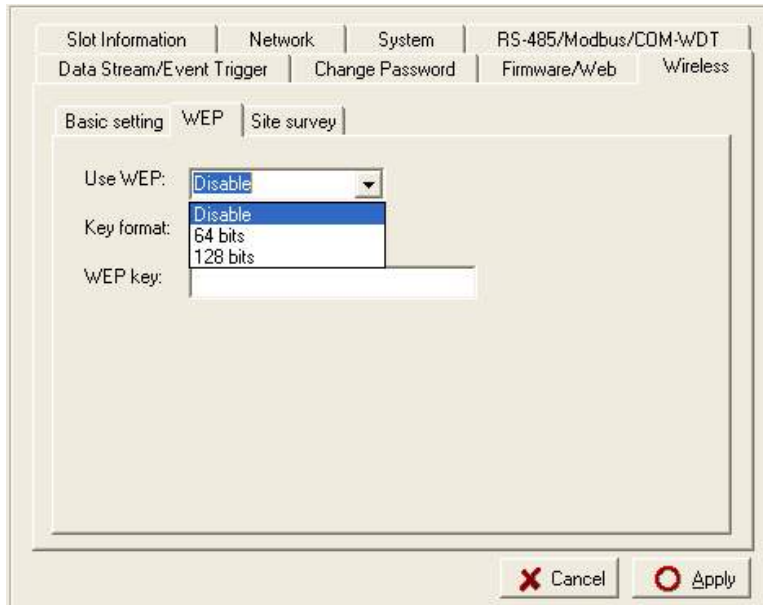

Step 6 : Data Stream Configuration

In addition to TCP/IP communication protocol, ADAM-6000 supports UDP communication protocol to regularly broadcast data to specific host PCs.

Click the tab of Data Stream, then configure the broadcasting interval and the specific IP addresses which need to receive data from the specific ADAM-6000 I/O module. This UDP Data Stream function broadcasts up to 8 host PCs simultaneously, and the interval is user-defined from 50ms to 7 Days.

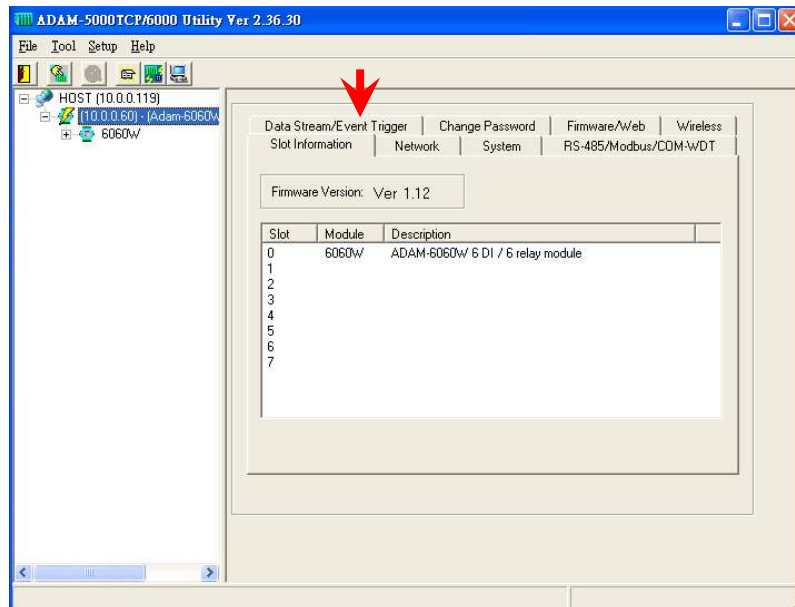

Please Enter the data streaming interval:

Days: 0 Hours: 0 Minutes: 0 Seconds: 0 mSeconds: 100 Update

To active hosts to accept the stream data:

0: <input type="checkbox"/>	255.255.255.255	Update	4: <input type="checkbox"/>	255.255.255.255	Update
1: <input type="checkbox"/>	255.255.255.255	Update	5: <input type="checkbox"/>	255.255.255.255	Update
2: <input type="checkbox"/>	255.255.255.255	Update	6: <input type="checkbox"/>	255.255.255.255	Update
3: <input type="checkbox"/>	255.255.255.255	Update	7: <input type="checkbox"/>	255.255.255.255	Update

Data Stream Monitoring

After finishing the configuration of Data Stream, you can select the item "Monitor Data Stream" in the function bar or click icon to call up operation display as below Figure.

IP Address: 172.18.1.194 Port: 5168 Start Stop

Receiving Stream Data:

```

At AM 09:23:04 Count=0
At AM 09:23:05 Count=1
At AM 09:23:06 Count=2
At AM 09:23:08 Count=3
At AM 09:23:09 Count=4
At AM 09:23:10 Count=5
At AM 09:23:11 Count=6
At AM 09:23:12 Count=7
At AM 09:23:13 Count=8
  
```

HOST (172.18.1.194)

```

6017
  -- DO DATA:0000
  -- CH00: Data:7fff Max:8bf9 Min:7fff
  -- CH01: Data:7fff Max:8ae6 Min:7fff
  -- CH02: Data:7fff Max:89c9 Min:7fff
  -- CH03: Data:7fff Max:88dd Min:7fff
  -- CH04: Data:7fff Max:9136 Min:7fff
  -- CH05: Data:7fff Max:9064 Min:7fff
  -- CH06: Data:7fff Max:8eee Min:7fff
  -- CH07: Data:7fff Max:8d17 Min:7fff
  -- Avg CH: Data:7fff Max:b82c Min:7fff
  
```

Select the IP address of the ADAM-6000 you want to read data, then click "Start" button. The Utility software will begin to receive the stream data on this operation display.

Firmware/Web Page Configuration

Web Page Configuration

Step 1 : Please go to the “Firmware/Web” configuration page

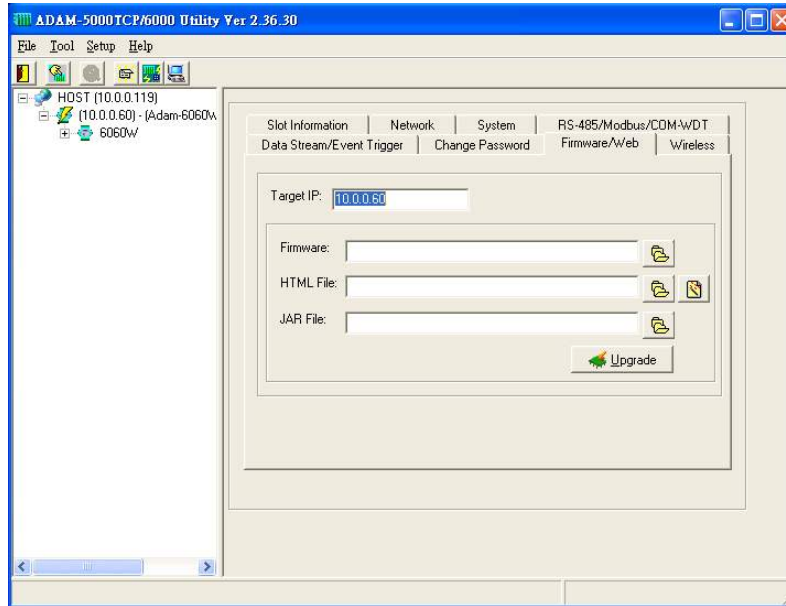

Step 2 : The ADAM-6000W modules support the configurable web page feature. Users don't have to learn the Java language to write the Java program to make the customized web page. Users can use the utility software to easily configure the web page that you want. Please follow the below instruction to configure the web page inside ADAM-6000W modules.

Press the web page configuration bottom.

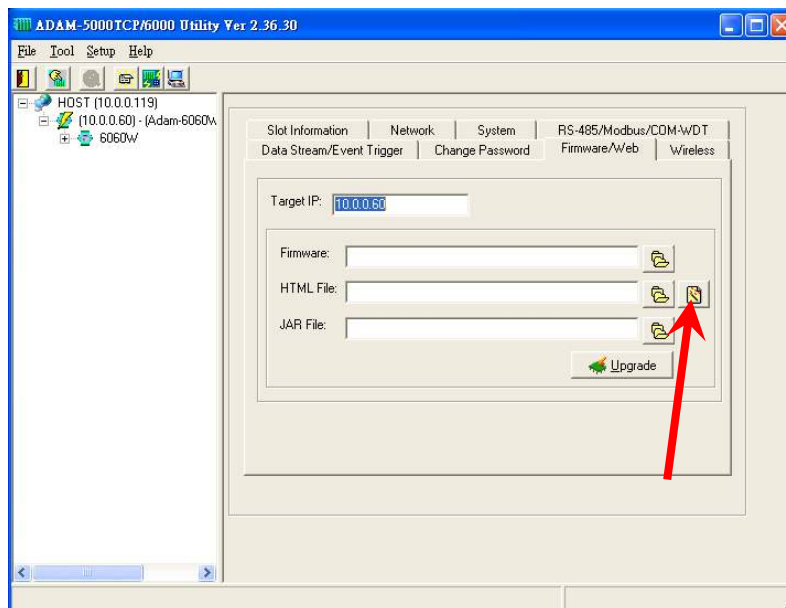

Key in the Tag Name of input channel.

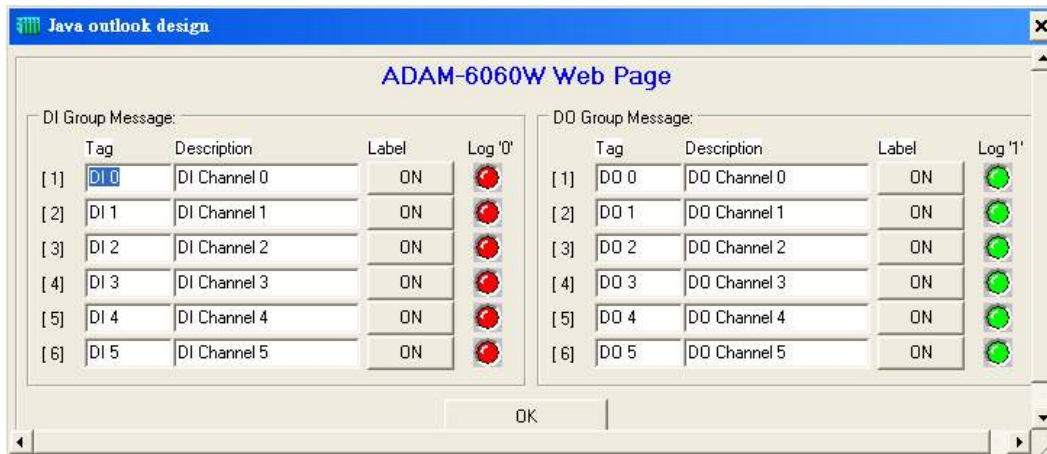

Key in the description of input channel

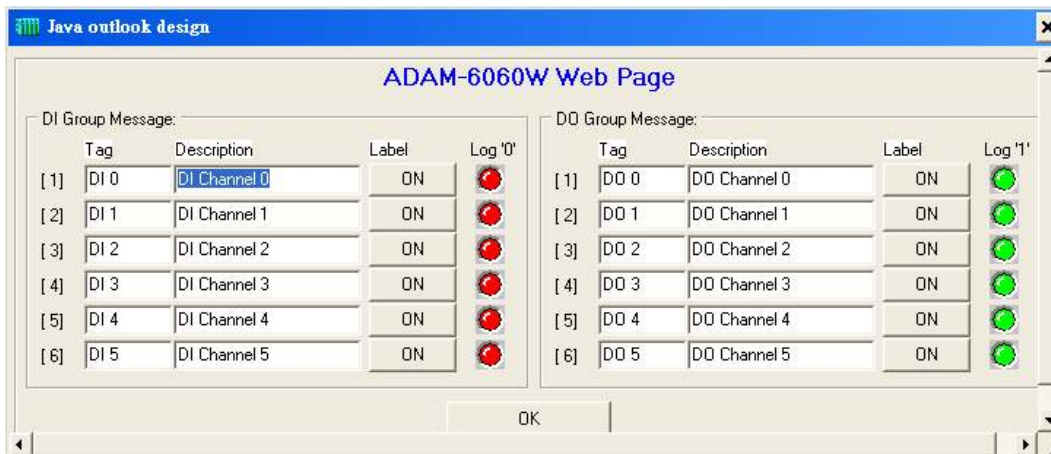

Press the label bottom to configure the label description of input channel.

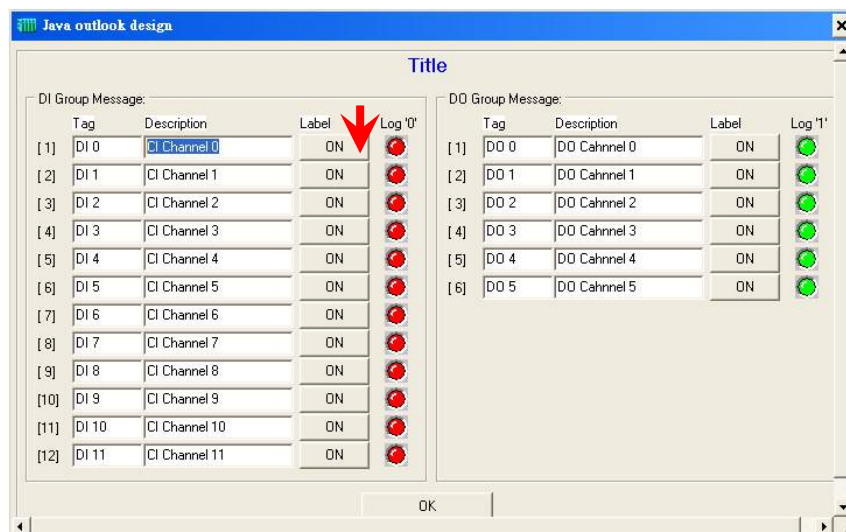

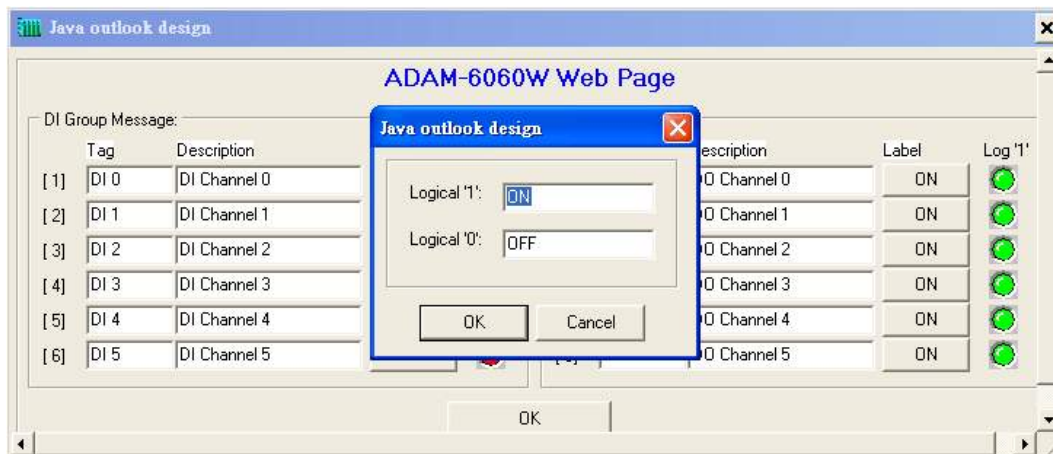

Key in the Tag Name of output channel

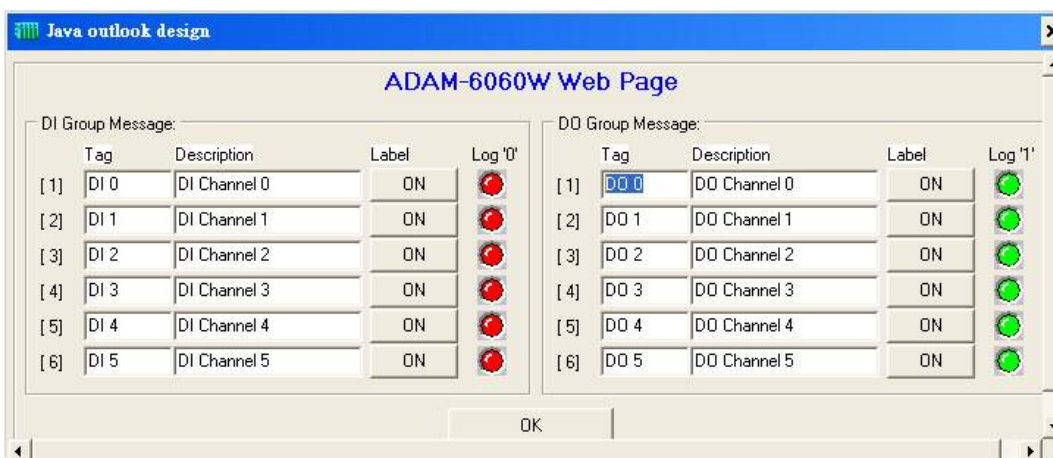

Key in the description of output channel

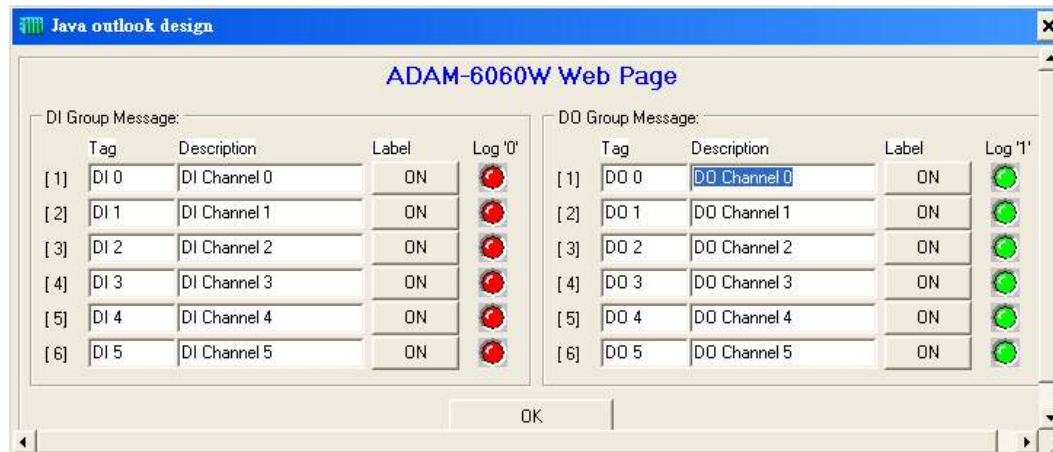

Press the label bottom to configure the label description of output channel

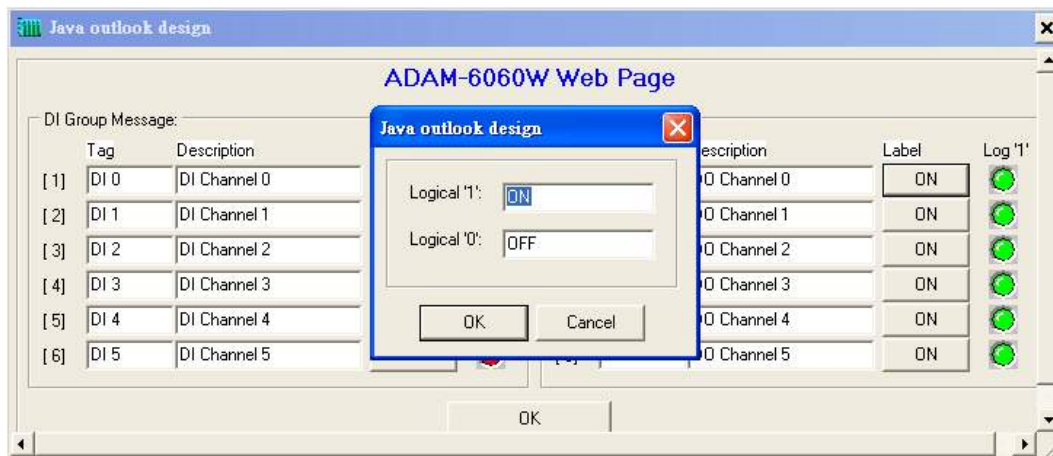
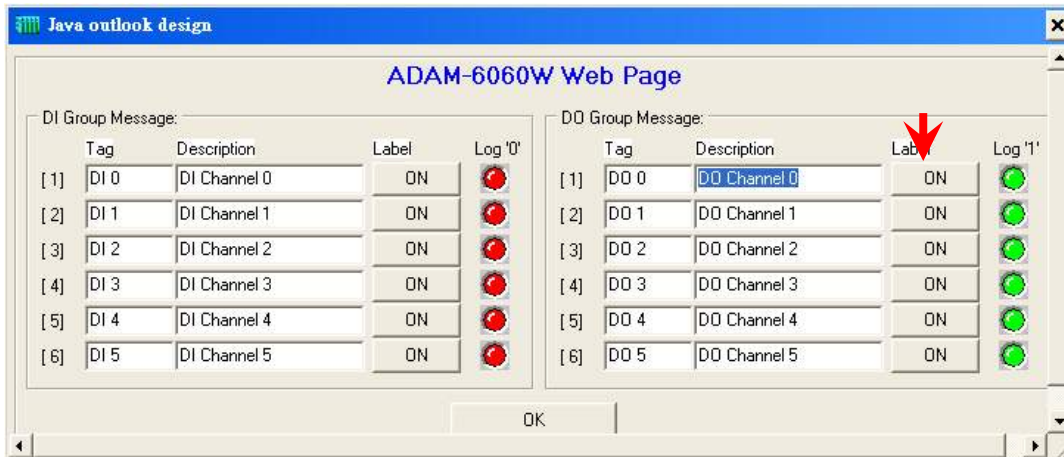

Click the title position to configure the page title description

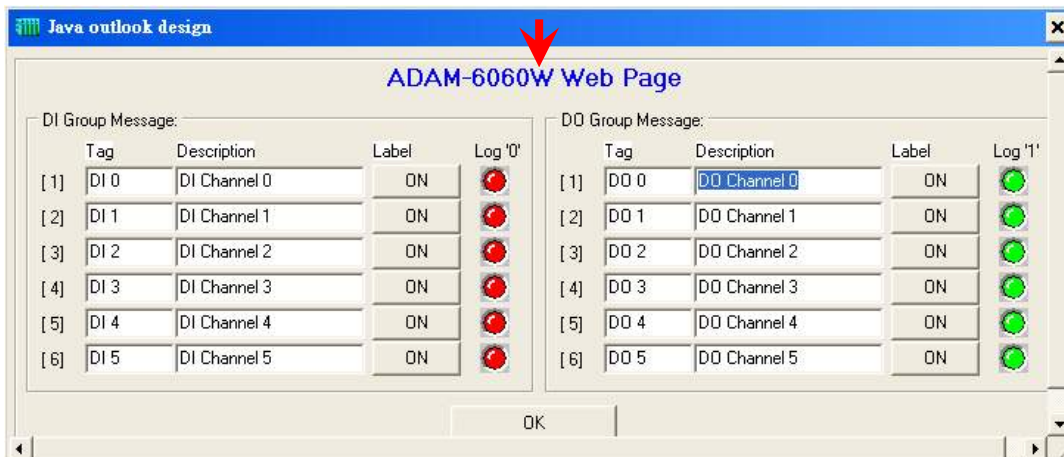

Please press "OK" after finishing all of the web page configuration.

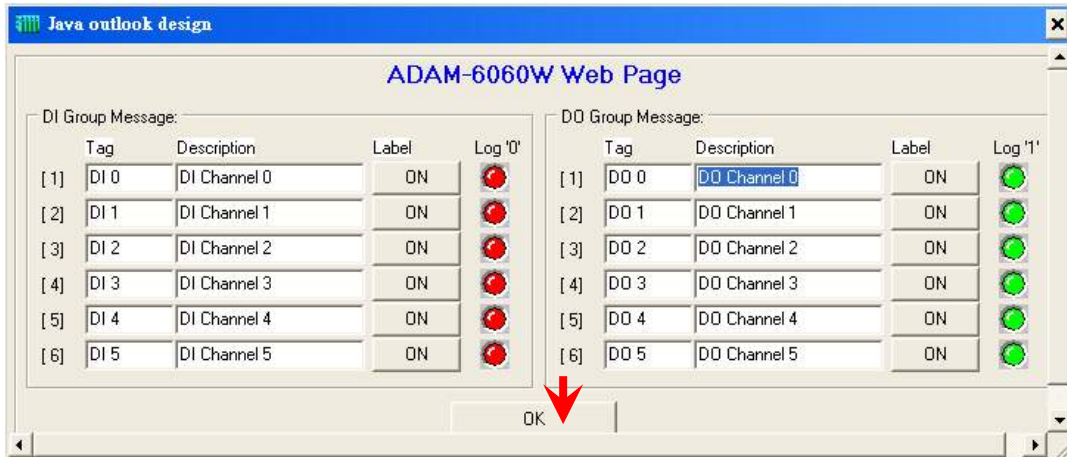

Press "Update" button to download the web page configuration into ADAM-6000W module. And system will save the configuration data as a file in C:\Programs\ADAM-5000TCP-6000 Utility\Program\Firmware\ADAM-6060W\ADAM6060W.html

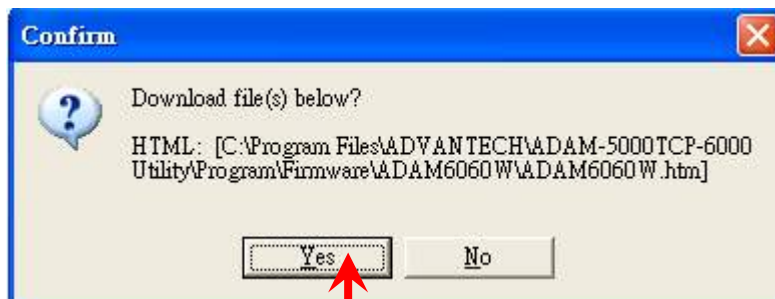
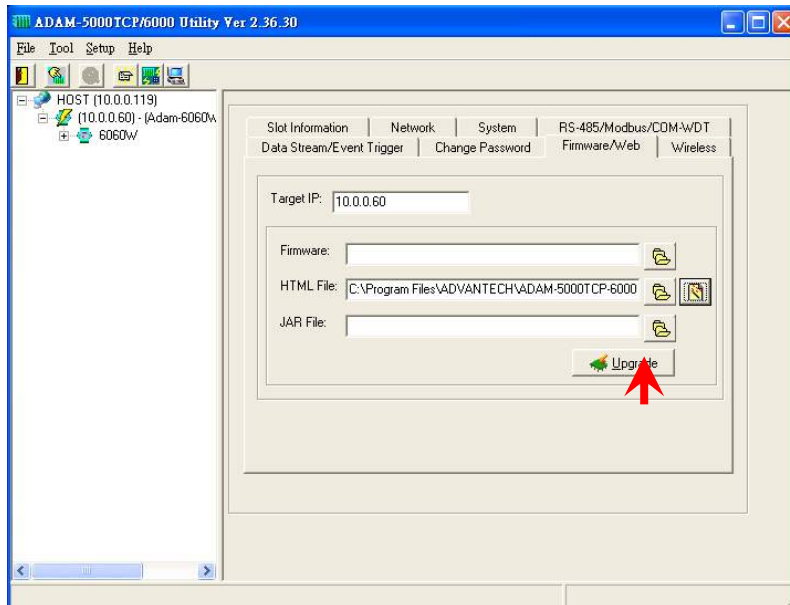



User can also retrieve the previous web page configuration file to download to ADAM-6000W Module.

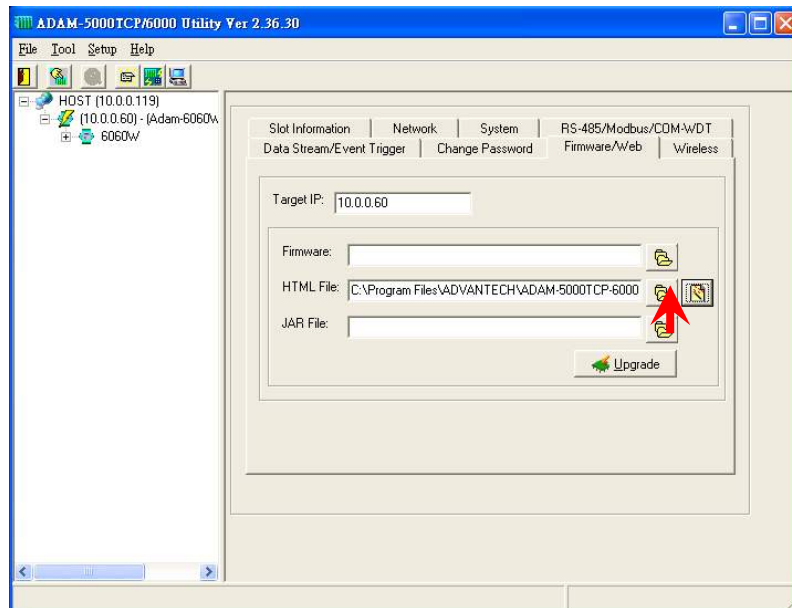

Select the stored web page configuration file then press "Open"

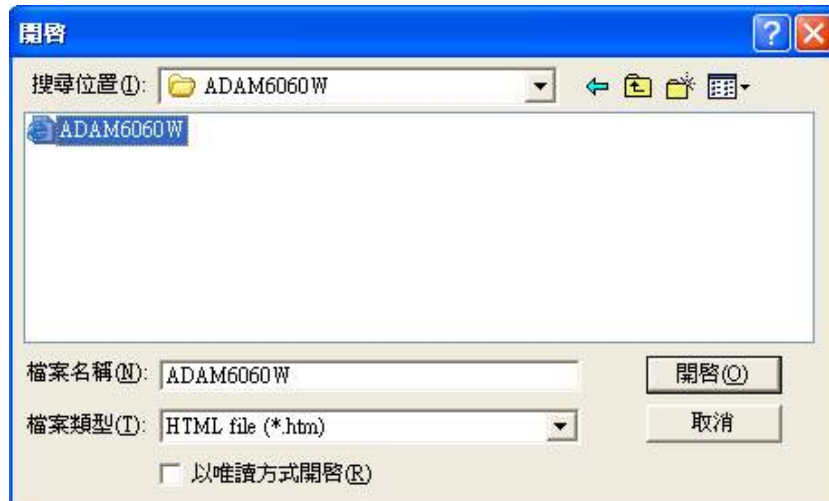

Follow the above action to download the selected file into ADAM-6000W module.

Firmware Update

Step 1 : Press the browse bottom of firmware

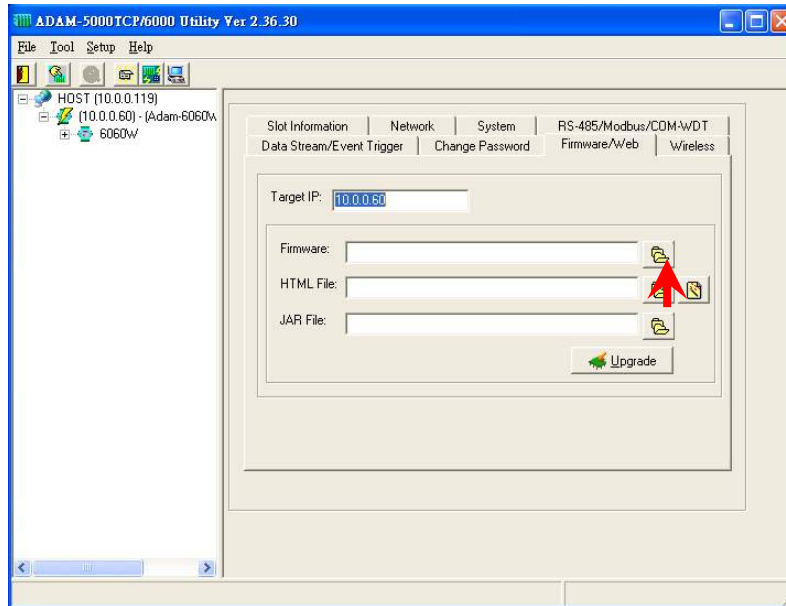

Step 2 : Select the firmware file to be downloaded

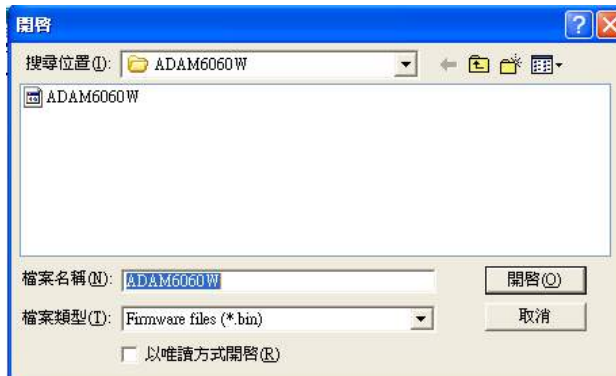

Step 3 : Press "Update" bottom to finish the firmware update action

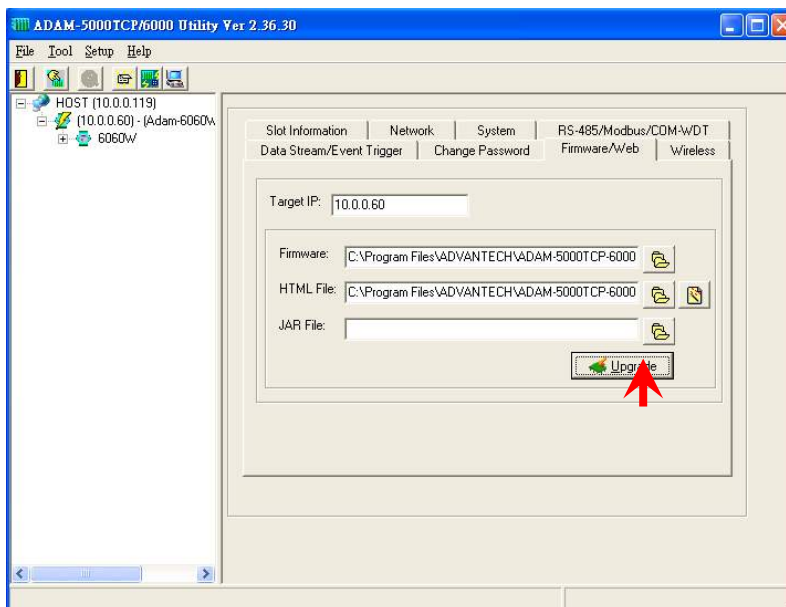

Input/Output Channel Configuration

Step 1 : Please click on the “6060W” to go to the ADAM-6060W configuration main page.

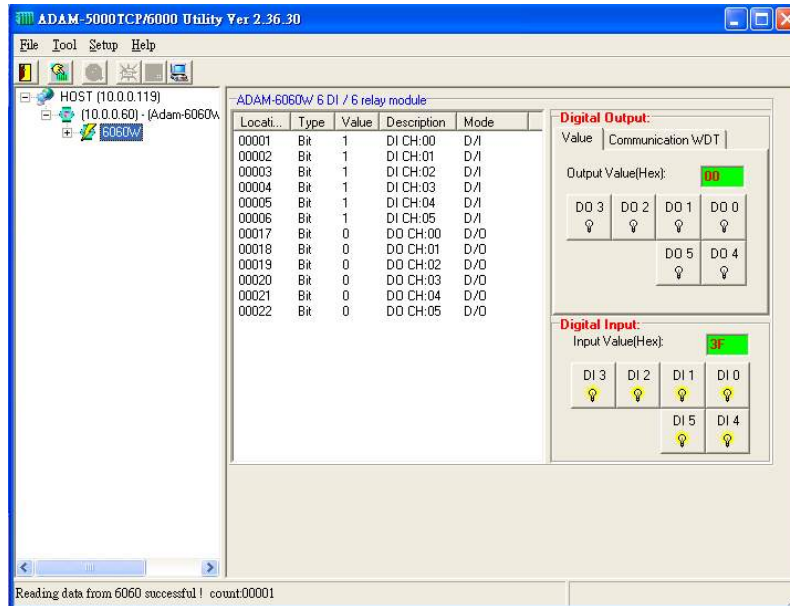

Step 7 : Please go to “Communication WDT” to set up the communication watchdog timer setting. This function is used for security protect, it means sometimes, noise or other reasons will cause the communication fail, and the host PC won’t control the modules anymore, but the modules will keep the latest output status, and this status may cause dangerous, so while this situation happen, the communication WDT will detect it till timeout then reset the module and set the output to safety value to prevent the dangerous, user can set the safety value by themselves.

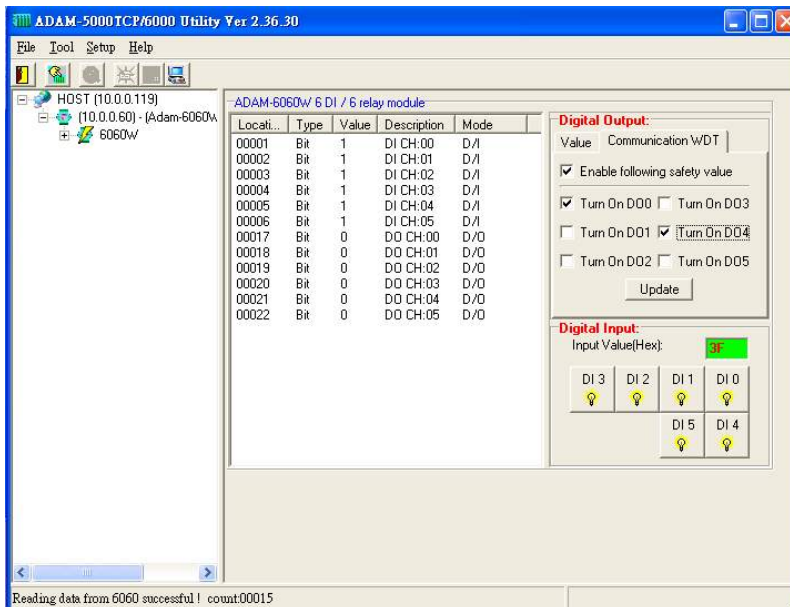

Step 3 : Please click on “DO:XX” to access the digital output channel configuration page. The digital output channel of ADAM-6060W can be configured as typical DO output, pulse output, DO with LO to Hi delay or DO with Hi to LO delay:

For typical DO setting :

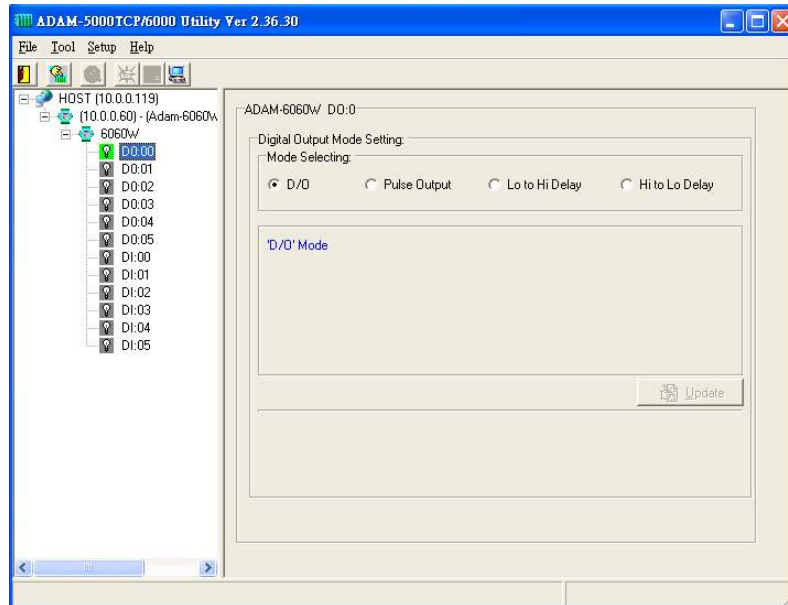

For Pulse Output setting :

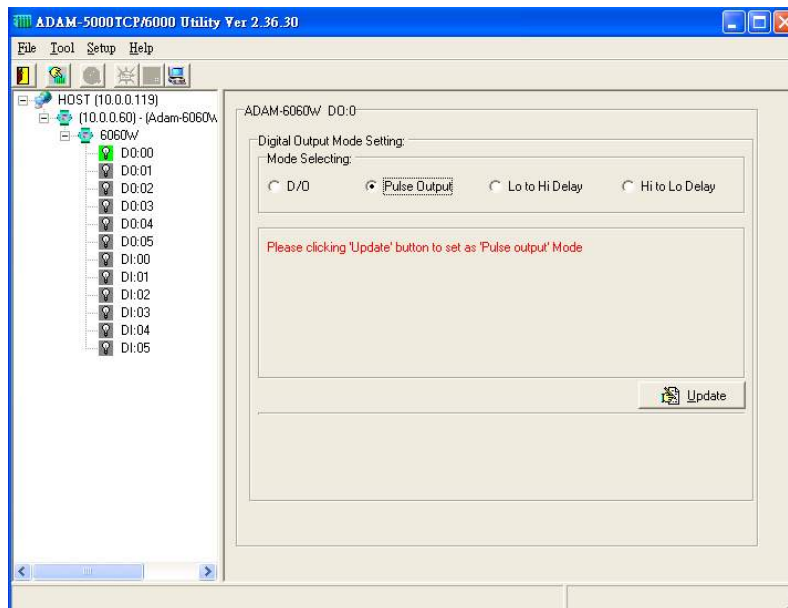

For "Lo to Hi delay" and "Hi to Lo delay" function :

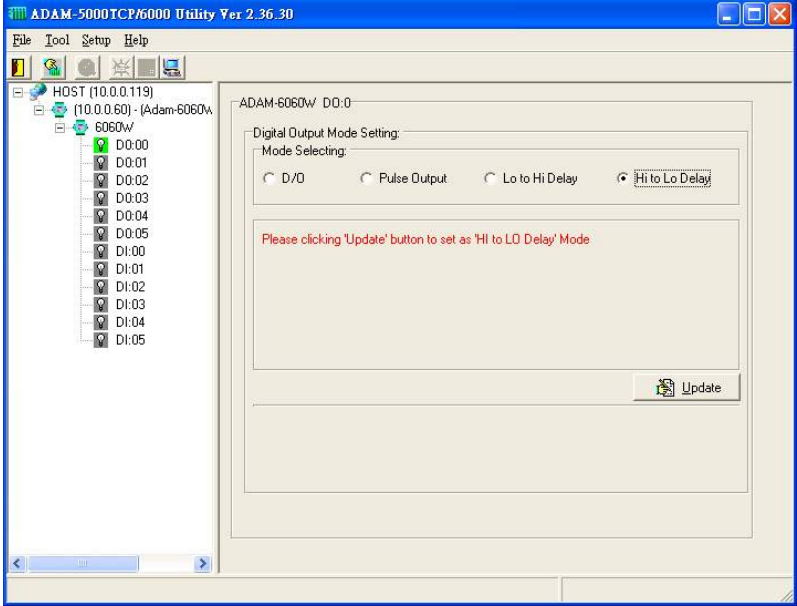
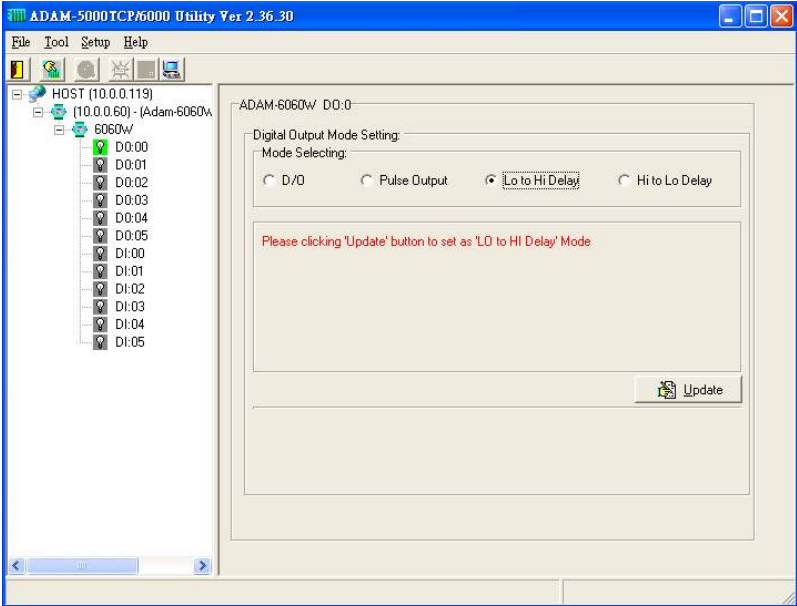

Step 4 : Please click on "DI:XX" to access the digital input configuration page. The digital input channel of ADAM-6060W supports typical DI, counter, frequency, Lo to Hi Latch and Hi to Lo Latch.

For typical DI setting :

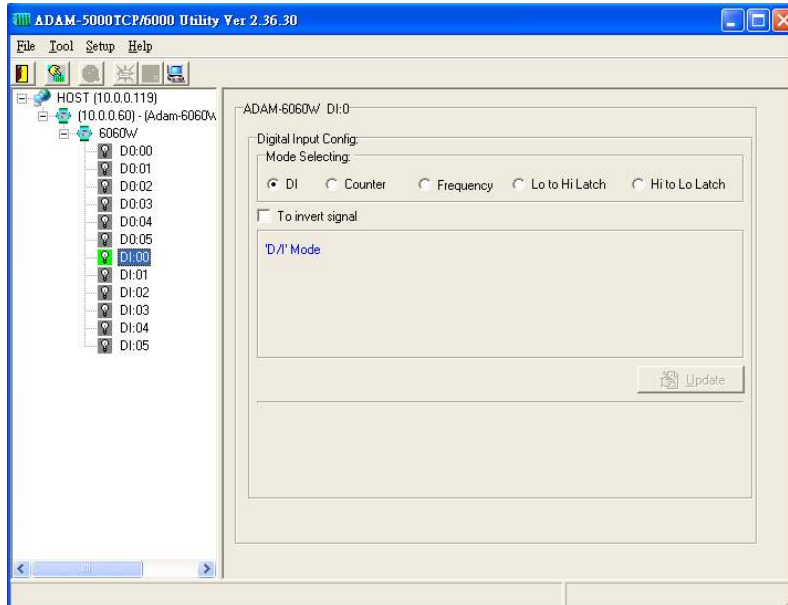

For Counter setting :

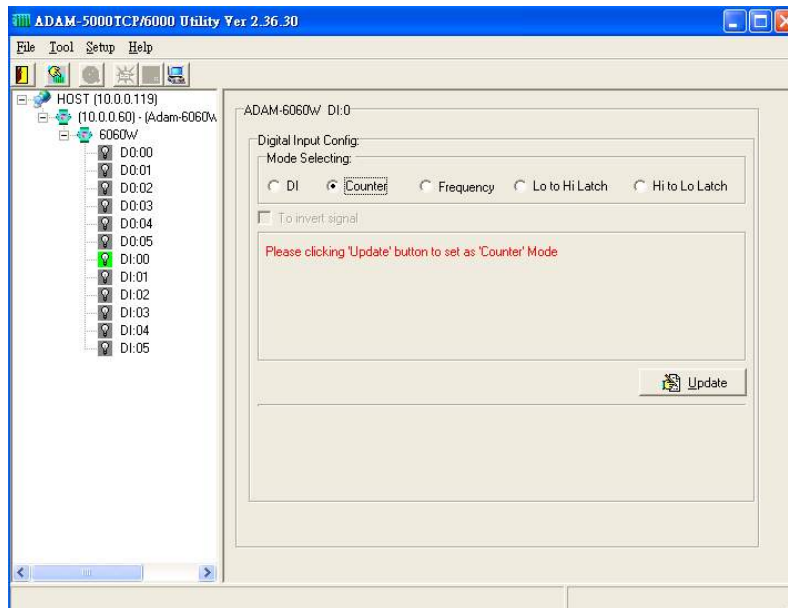

For Frequency setting :

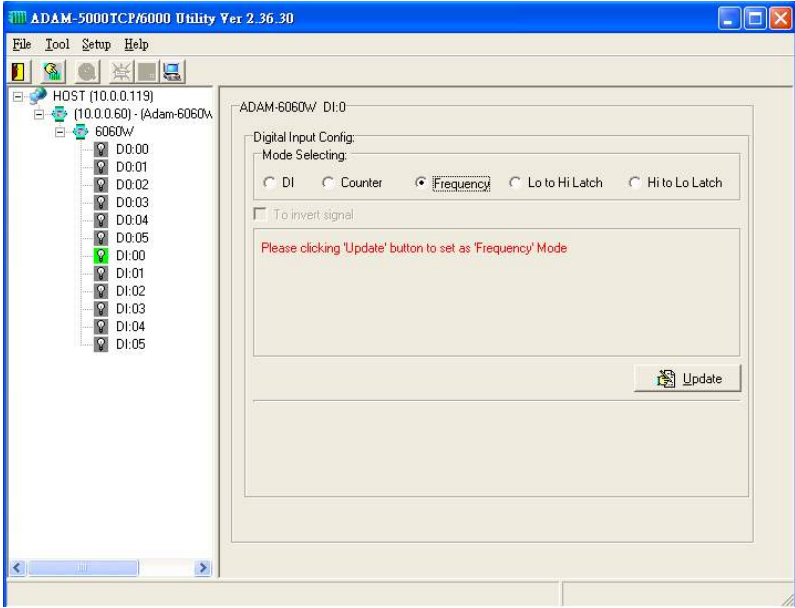

For “Lo to Hi Latch” and “Hi to Lo Latch” setting :

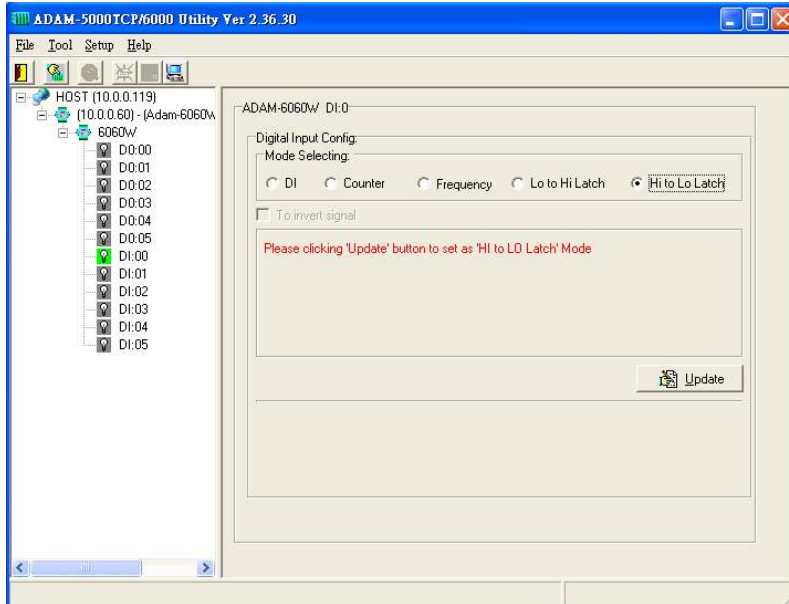
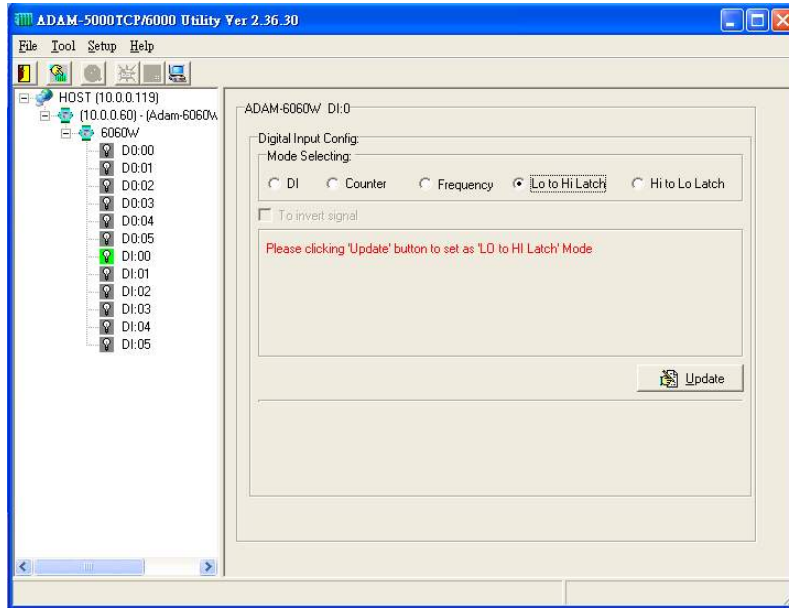

Appendix : Adam-6000W Mode Setting

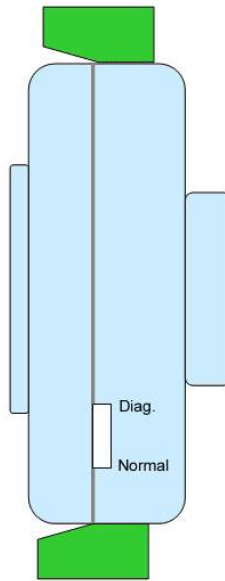

switch

Mode 1 (Normal Mode): In this mode, you can use Utility to configure module to Infrastructure or Ad hoc mode.

Mode 2 (Diagnostic Mode): The purpose of this mode is used to recover the Adam-6000W module from error state. User can switch module to diagnostic Infrastructure/Ad hoc mode that has temporary wireless setting and default IP, subnet mask. Therefore, user can re-configure the wireless setting when module's communication is dead. (*Note: the temporary wireless setting will be cleared after reboot to Normal mode)

Diagnostic-mode default settings:

Diagnostic Ad hoc mode setting:

Temporary SSID: WLAN

Temporary Channel: 10

Temporary Wep: No

IP: 10.0.0.1

Subnet mask: 255.0.0.0

Gateway: 0.0.0.0

Diagnostic Infrastructure mode setting:

Temporary SSID: <ANY>

Temporary Channel: 10

Temporary Wep: No

IP: 10.0.0.1

Subnet mask: 255.0.0.0

Gateway: 0.0.0.0

ADAM-6060 MODBUS Address Mapping table

	ADDR 0X	CH	ITEM	Attribute	ADDR 4X	CH	ITEM	Attribute
	00001	0	DI	R	40001~40002	0	*Counter	R
	00002	1	DI	R	40003~40004	1	*Counter	R
	00003	2	DI	R	40005~40006	2	*Counter	R
	00004	3	DI	R	40007~40008	3	*Counter	R
	00005	4	DI	R	40009~40010	4	*Counter	R
	00006	5	DI	R	40011~40012	5	*Counter	R
	00017	0	DO	R/W	40013~40014	0	Pulse Output Low Level	R
	00018	1	DO	R/W	40015~40016	1	Pulse Output Low Level	R
	00019	2	DO	R/W	40017~40018	2	Pulse Output Low Level	R
	00020	3	DO	R/W	40019~40020	3	Pulse Output Low Level	R
	00021	4	DO	R/W	40021~40022	4	Pulse Output Low Level	R
	00022	5	DO	R/W	40023~40024	5	Pulse Output Low Level	R
	00033	0	Counter Start(1)/Stop(0)	R/W	40025~40026	0	Pulse Output High Level	R
	00034	0	Clear Counter(1)	R/W	40027~40028	1	Pulse Output High Level	R
	00035	0	Clear Overflow	R/W	40029~40030	2	Pulse Output High Level	R
	00036	0	Latch Status/ Clear Status	R/W	40031~40032	3	Pulse Output High Level	R
	00037	1	Counter Start(1)/Stop(0)	R/W	40033~40034	4	Pulse Output High Level	R
	00038	1	Clear Counter(1)	R/W	40035~40036	5	Pulse Output High Level	R
	00039	1	Clear Overflow	R/W				
	00040	1	Latch Status/ Clear Status	R/W				
	00041	2	Counter Start(1)/Stop(0)	R/W				
	00042	2	Clear Counter(1)	R/W				

	00043	2	Clear Overflow	R/W	40037~40038	0	Set Absolute Pulse (0=Continue Mode)	R
	00044	2	Latch Status/ Clear Status	R/W	40039~40040	1	Set Absolute Pulse (0=Continue Mode)	R
	00045	3	Counter Start(1)/Stop(0)	R/W	40041~40042	2	Set Absolute Pulse (0=Continue Mode)	R
	00046	3	Clear Counter(1)	R/W	40043~40044	3	Set Absolute Pulse (0=Continue Mode)	R
	00047	3	Clear Overflow	R/W	40045~40046	4	Set Absolute Pulse (0=Continue Mode)	R
	00048	3	Latch Status/ Clear Status	R/W	40047~40048	5	Set Absolute Pulse (0=Continue Mode)	R
	00049	4	Counter Start(1)/Stop(0)	R/W				
	00050	4	Clear Counter(1)	R/W				
	00051	4	Clear Overflow	R/W	40049~40050	0	Set Incremental Pulse	R
	00052	4	Latch Status/ Clear Status	R/W	40051~40052	1	Set Incremental Pulse	R
	00053	5	Counter Start(1)/Stop(0)	R/W	40053~40054	2	Set Incremental Pulse	R
	00054	5	Clear Counter(1)	R/W	40055~40056	3	Set Incremental Pulse	R
	00055	5	Clear Overflow	R/W	40057~40058	4	Set Incremental Pulse	R
	00056	5	Latch Status/ Clear Status	R/W	40059~40060	5	Set Incremental Pulse	R

***Note : How to retrieve the counter/frequency value on Modbus address mapping**

Example :

$$\text{Counter(dec)} = (\text{value of 40002}) \times 65536 + (\text{value of 40001})$$

$$\text{Frequency(dec)} = (\text{value of 40001})/10 \text{ Hz}$$

This equipment has been tested and found to comply with the limits for a Class B digital device, pursuant to part 15 of the FCC rules. These limits are designed to provide reasonable protection against harmful interference in a residential installation. This equipment generates, uses and can radiate radio frequency energy and, if not installed and used in accordance with the instructions, may cause harmful interference to radio communications. However, there is no guarantee that interference will not occur in a particular installation. If this equipment does cause harmful interference to radio or television reception, which can be determined by turning the equipment off and on, the user is encouraged to try to correct the interference by one or more of the following measures:

-Reorient or relocate the receiving antenna.

-Increase the separation between the equipment and receiver.

-Connect the equipment into an outlet on a circuit different from that to which the receiver is connected.

-Consult the dealer or an experienced radio/TV technician for help.

This Transmitter must not be co-located or operating in conjunction with any other antenna or transmitter.

Any changes or modifications (including the antennas) made to this device that are not expressly approved by the manufacturer may void the user's authority to operate the equipment.

This equipment complies with FCC RF radiation exposure limits set forth for an uncontrolled environment. This equipment should be installed and operated with a minimum distance of 20 centimeters between the radiator and your body.

CE Declaration of Conformity

CE 0984 Ⓢ

Is herewith confirmed to comply with the requirements set out in the Council Directive on the Approximation of the Laws of the Member States relating to Electromagnetic Compatibility (89/336/EEC), Low-voltage Directive (73/23/EEC) and the Amendment Directive (93/68/EEC), the procedures given in European Council Directive 99/5/EC and 89/336/EEC.

The equipment was passed. The test was performed according to the following European standards:

- EN 300 328 V.1.6.1 (2004-04)
- EN 301 489-1 V.1.4.1 (2002-04) / EN 301 489-17 V.1.2.1 (2002-04)
- EN 50371: 2002
- EN 60950: 2000