

1 Introduction – for your safety

- ⇒ Read and observe the quick start guide carefully.
- ⇒ Keep for future reference.
- ⇒ Read and observe the accompanying “DLT-V4108 Safety Instructions” carefully.
- ⇒ Go to www.advantech-dlog.com for detailed manuals, e.g. “DLT-V4108 Manual” and “MDevice Manual”.



Figure: DLT-V4108 Industrial PC



DANGER

Observe the intended use.

Observe the intended use of DLT-V4108, e.g.: no use in EX zone (potentially explosive) and on ships, no use in life-supporting systems or security-critical facilities.

Observe the required qualification.

This quick start guide is intended for qualified skilled personnel. Only skilled personnel may transport, store, commission and maintain the DLT-V4108. Qualified and skilled personnel referred in this quick start guide are persons who are familiar with these processes and have the corresponding qualifications for their activities.

Hazardous voltage, electric shock from contact with live parts.

- ⇒ Do not put DLT-V4108 into operation if it is damaged.
- ⇒ Do not open or modify DLT-V4108.
- ⇒ Only connect or disconnect electrical connections when the device is in a de-energized state (electrically dead)
- ⇒ Operators of the DLT-V4108 must be trained in the handling of the device.
- ⇒ DLT-V4108 is intended to be supplied by DC power source, rated $\geq 9-60$ Vdc, 5 A minimum and $T_{max} \leq 45$ degree C maximum, if need further assistance, please contact Advantech for further information."

Users must be trained / instructed.

Users of the DLT-V4108 must be trained by skilled personnel and instructed about the operation of the device.



CAUTION

Replaceable Battery.

RISK OF EXPLOSION IF BATTERY IS REPLACED BY AN INCORRECT TYPE.
 DISPOSE OF USED BATTERIES ACCORDING TO THE INSTRUCTIONS.

Design method in our quick start guide:

Hazards that pose a risk to life and limb - Personal injury

Possible property damage:



DANGER / WARNING / CAUTION

DANGER: Danger that immediately leads to death or severe injury.

WARNING: Danger that can lead to death or severe injury.

CAUTION: Danger that can lead to slight injuries.

NOTICE:

Physical damage

Information about possible physical damage.

2

Technical data of DLT-V4108

DLT-V4108	
Weight	3.35 kg
Dimensions	290 x 230 x 60.5 mm (width x height x depth)
Operating temp.	-20 to +45 °C
Storage temp.	-20 to +50 °C
Relative humidity	10~95% non-condensing, ambient temperature 25 °C
IP Protection class	IP65

3

Operation of DLT-V4108

NOTICE: Physical damage

Users of DLT-V4108 must be trained by skilled personnel and instructed about the operation of the device.

Enter data

You can enter data using the touchscreen and the built in integrated keyboard.

Operate the touchscreen with:

- Clean, dry fingers.
- Clean, dry, thin gloves.
- Suitable touch stylus

Front keys

Left side:

- Power on/off
- Display brighter
- Display darker
- Backlighting on/off
- Touchscreen on/off
- SHIFT



Right side:

- S1 to S12
programmable keys

LED indication on “Power ON /OFF “Key

System Status	LED Status	Color
System power on	Static	Green
System power off	Off	x
System over/under temperature	Static	Red
System UPS Battery is charging	Static	Orange
System thermal sensor faculty	Blinking 0.5 sec. on / 0.5 sec. off	Red
System UPS Battery Capacity Low	Blinking 0.2 sec. on / 0.8 sec. off	Orange
System is powered by UPS battery only	Blinking 0.5 sec. on / 0.5 sec. off	Green

LED indication on “Touch ON/OFF “Key

Touch Status	LED Status	Color
Touch function ON	Off	x
Touch function OFF	Static	Orange

LED indication on “SHIFT “Key

System Status	LED Status	Color
System switch to S1/S2/S3/S4/S5/S6	Off	x
System switch to S7/S8/S9/S10/S11/S12	Static	Orange

4 Software configuration with MDevice

DLT-V4108 Industrial PCs are configured with the **MDevice** software, e.g., with regard to Wi-Fi settings, network settings, front key assignment, etc.

- ⇒ Start **MDevice** via *Start -> Programs -> DLoG: MDevice*.
- ⇒ Enter the standard password: **gold**.



You can find details on configuration in the "MDevice Manual" at www.advantech-dlog.com.

4.1 Wireless technology

Only authorized skilled personnel are permitted to configure the wireless settings on DLT-V4108.



WARNING

Safety information about radio wave emissions

To comply with the SAR limited values for exposure to radio waves:

- ⇒ While the device is in operation, the antenna must have a distance of **≥ 20 cm to the body**.
- ⇒ Make sure that the transmission power and the radio frequency of DLT-V4108 comply with the regulations for the respective country where the device is deployed.
- ⇒ Depending on the country-specific regulations, the operating company/importing company may be required to ensure the settings of wireless operation are compliant. The regulatory authorities in the relevant country can provide information on this.

Any changes or modifications which are not expressly approved by the party responsible for the compliance can lead to the withdrawal of the operating license and guarantee for this device.

5

Important notes before installation/commissioning



WARNING

Risk of injury and damage due to improper installation.

- ⇒ Observe the “DLT-V4108 Safety Instructions”.
- ⇒ Observe the “DLT-V4108 Manual” with important notes for installation on the targeted subjects.

Important information for mounting to the targeted subjects.

- ⇒ You must take into account all requirements of the targeted subjects’ manufacturer for the attachment of auxiliary devices, such as:
 - Requirements for welding or drilling supporting parts.
 - Requirements for connecting auxiliary consumers.
 - Requirements associated with an emergency-off switch.

The targeted subjects must be properly prepared (e.g. connection to the ignition, correct voltage, etc.)

6

Overview: Recommended sequence of installation steps

Requirement: The installation location must be prepared (e.g. connection to the ignition, correct voltage, etc.).

1. Find a suitable installation position for DLT-V4108.
2. Secure the device mounting (mounting bracket, RAM mount) to the targeted subject.
3. Connect external accessories (optional) to DLT-V4108.
4. Install an easily accessible disconnecting device such as a switch close to the device.
5. Connect all cables (power etc.).
6. Seal cable passages with cable grommets and dummy grommets.
7. Close DLT-V4108 with the cable cover.
8. Install DLT-V4108 on the device mounting (follow the mounting instructions).

NOTICE: Physical damage

- ⇒ Hold DLT-V4108 by the housing whenever in transportation or installation; never use the antenna cap as a handle.
- ⇒ The installation environment must not result in a closed system.
The cooling system of DLT-V4108 requires a supply of fresh air.
Otherwise, there is a danger of overheating and damage to the device.

7 Connect cables, close cable cover

7.1 Connection for DC Power Source

NOTICE: Physical damage

- ⇒ Only trained service personnel are authorized to install and remove the 9 - 60 volt dc power supply, and make the connections to and disconnections from the 9 - 60 volt dc power source. The customer is responsible for ensuring that only trained service personnel install or remove the 9 - 60 volt power cable
- ⇒ Fuse - Non-operator access/soldered-in fuses, for 6.3A /250V input DC board only:
Replacement of fuses replaceable only by service personnel.\
- ⇒ Fuse - Non-operator access/soldered-in fuses, for 6.3A /250V input DC board only:
Replacement of fuses replaceable only by service personnel.

7.1.1 Connect the Power supply

NOTICE: Physical damage

- ⇒ The DC supply source for the equipment power supplied shall be an UL listed power source and suitable for specification, rated 60Vdc, 5A minimum provided by the manufacturer. Please use the jacketed power cable with 60 volt, 18 AWG or 6 Amp. to connect between the equipment and the DC power source.
 - ⇒ This product is intended to be supplied by a listed DC power source, rate 9-60Vdc, 5A minimum and Tma 45 degree C, if need further assistance, please contact Advantech for further information.
1. Turn off DC supply source and equipment that is to be connected to this product.
 2. Ensure DC power source connected earthed cable.
 3. Connect the earthed cable which is of AWG 20 min. green-and-yellow wire of earth of building to the protective earthed terminal of the equipment
 4. Connect signal cables to the product
 5. Connect power cord to the product
 6. Ensure correct polarity of 9 - 60 V dc connections
 7. Turn ON the power source

7.1.2 Disconnect the Power supply

1. Turn OFF DC supply source and equipment.
2. Disconnect the power cord from equipment.
3. Remove the signal cables from the connectors.
4. Remove the earthed cable from the protective earthed terminal of the equipment.

7.2 Preparing the cables, cable grommets and dummy grommets

Cable sealing set (included in the scope of delivery)

Cable grommets (which openings have different sizes)	Dummy grommets	Cable clips	Mounting screws
			

- ⇒ Lay out all cables which are ready to be connected.
- ⇒ Check the cable diameters and cable elasticity as it will determine which cable grommet is the most suitable (diameter of the opening).

IMPORTANT: The cable grommet must completely surround the cable.
The opening of the cable grommet must be slightly smaller than the cable diameter.
If the opening is too large or too small, the sealing of the device will not be ensured.

7.3 Plugging in and screwing on the power supply cable

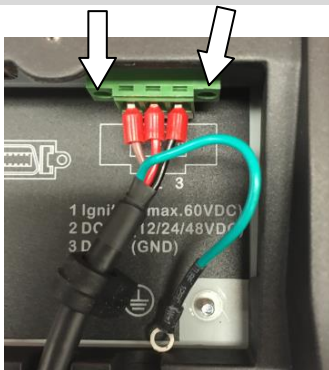

- ⇒ Plug the power supply cable into the power supply plug-in location.
- ⇒ Tighten both mounting screws hand-tight.
- ⇒ Fold-open the round cable passage in the rubber seal.
- ⇒ Insert the power supply cable.

7.4 Securing the ground using ring tongue to the ground bolt

⇒ Secure the ring tongue of the power supply cable to the ground bolt:

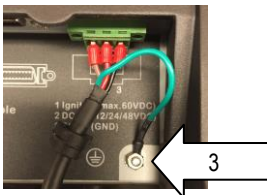
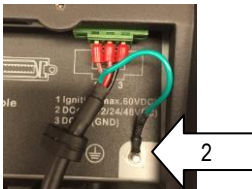
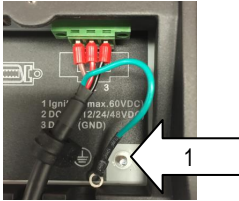

⇒ ATTENTION

To make sure the device is grounding correctly, it is important to follow the correct order to put the components on the ground bolt as below (from inside to outside):

1. Place "**toothed washer**" first(internal)
2. Then put the "**Ring Tongue of the power supply cable**" (flat side faces DLT-V6210 connector panel)
3. Tightening the nut hand-tight.

7.5 Securing the power supply cable to the strain relief rail

- ⇒ Place one cable clip on the power supply cable.
- ⇒ Secure the cable clip to the strain relief rail using 2 mounting screws (M3x10 screws which in accessory box).
- ⇒ Tighten the mounting screws alternately.
- ⇒ **ATTENTION:** Tighten the mounting screws sufficiently but on no account pinch or crush the cable. If you do, the cables may break or the cable insulation may get damaged.

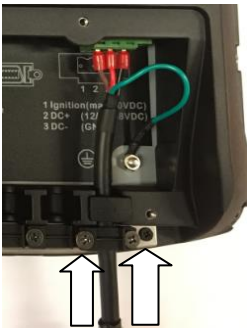

7.6 Connecting the USB, Ethernet, COM etc.

NOTICE: Physical damage

Only use accessories that have been tested and approved by Advantech-DLoG for DLT-V4108.

Proceed as described with the **power supply cable**:

- ⇒ Insert the cable.
- ⇒ Attach matching cable grommet.
- ⇒ Insert in the cable pass-through.
- ⇒ Secure to the strain relief rail using cable clip and screws.

7.7 Closing off unused cable openings

- ⇒ Close off all unused cable pass-throughs with dummy grommets so that they are sealed.

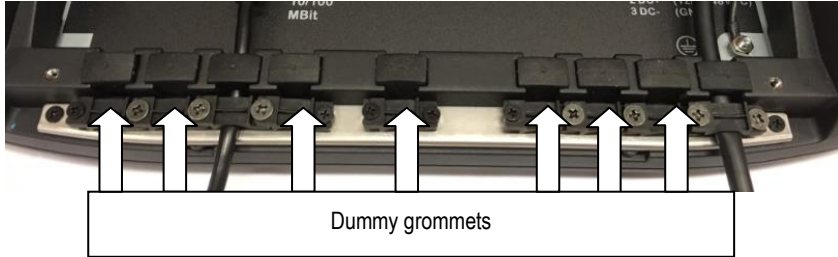

7.8 Attaching the cable cover

- ⇒ Place the cable cover on DLT-V4108 housing slot.
- ⇒ Lock the M3x5 screws loosely into the holes of the cable cover.
- ⇒ Then fully tighten the screws alternatingly with 3 kgf-cm (0.294 nm) torque.
- ⇒



8

VESA-compatible drilling patterns

VESA-compatible drilling patterns for the RAM® attachment and swivel joint brackets are located on the rear side of the DLT-V4108.

Depth of thread: M6 x 8 mm

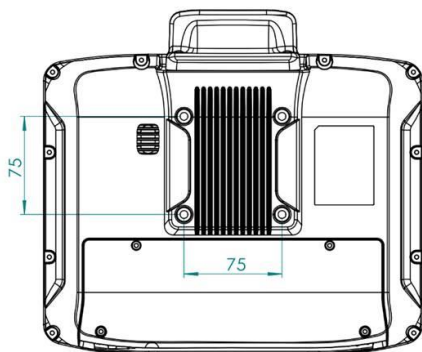

NOTICE: Physical damage

- ⇒ Only use appropriate screws for fixing the RAM® attachment and swivel joint brackets to the VESA drill holes: Depth of thread: M6 x 8 mm.
- ⇒ Use suitable mounting apparatus to avoid risk of injury

9 **Integrated UPS and battery pack**

The DLT-V4108 has an integrated uninterruptible power supply (UPS). The battery pack (lithium-ion technology) of the UPS is located inside of back cover and couldn't be changed by user.



WARNING

Personal injury due to short-circuit, fire, chemical burns, toxic substances.

The integrated UPS contain lithium-ion battery packs. These can ignite if the DLT-V4108 is handled or stored improperly (risk of fire), cause chemical burns or release toxic substances.

- ⇒ Use care when handling the DLT-V4108.
- ⇒ Do not damage the DLT-V4108; otherwise lithium-ion battery packs could be damaged.
- ⇒ Do not allow the DLT-V4108 to come into contact with fire.

Performance specifications Li-ion rechargeable battery pack; 2 cells of UR14650R (900 mAh)	
Bridging time	Typically 15 minutes (when battery pack is fully charged)
Charging time	2 h (fully recharge a completely discharged battery pack)
Charging temperature	0 ~ +45 °C (ambient temp.)
Output power	6.48 W
Battery voltage	7.2 V

10

Recycling information



DLT-V4108 devices that are no longer being used may not be disposed of in the regular residential or domestic waste; they must be taken to an official public collection point and handled by a disposal provider.

Please contact the responsible authorities in your country/region to find out about the applicable regulations for proper disposal, if necessary.

11

Technical customer support

Please contact your distributor, your sales representative or Advantech-DLoG's customer service to receive technical support. Please have the following information available:

- Product name, serial number
- General description of the problem

Manufacturer address

DLoG GmbH, Industriestraße 15, D-82110 Germering

Email: helpdesk@advantech-dlog.com Web: www.advantech-dlog.com

Phone: +49 (0)89 / 41 11 91 999

Warranty

The Advantech-DLoG general terms and conditions of business are applicable to DLT-V4108 and its accessories (Liability for defects -> limitation period for claims in relation to defects). For more details, please refer to www.advantech-dlog.com.

© by DLoG GmbH 2016. Information in this document is subject to change – also without prior notice. DLoG GmbH assumes no liability for technical inaccuracies, typographic errors or faults in this document. DLoG GmbH accepts no liability for damage caused directly or indirectly by the delivery, performance or use of this document. RAM® and RAM Mount™ are both trademarks of National Products Inc., 1205 S. Orr Street, Seattle, WA 98108. We recognize all national and international trademarks and product names.

Document finished on: 12/13/2016