

User Manual

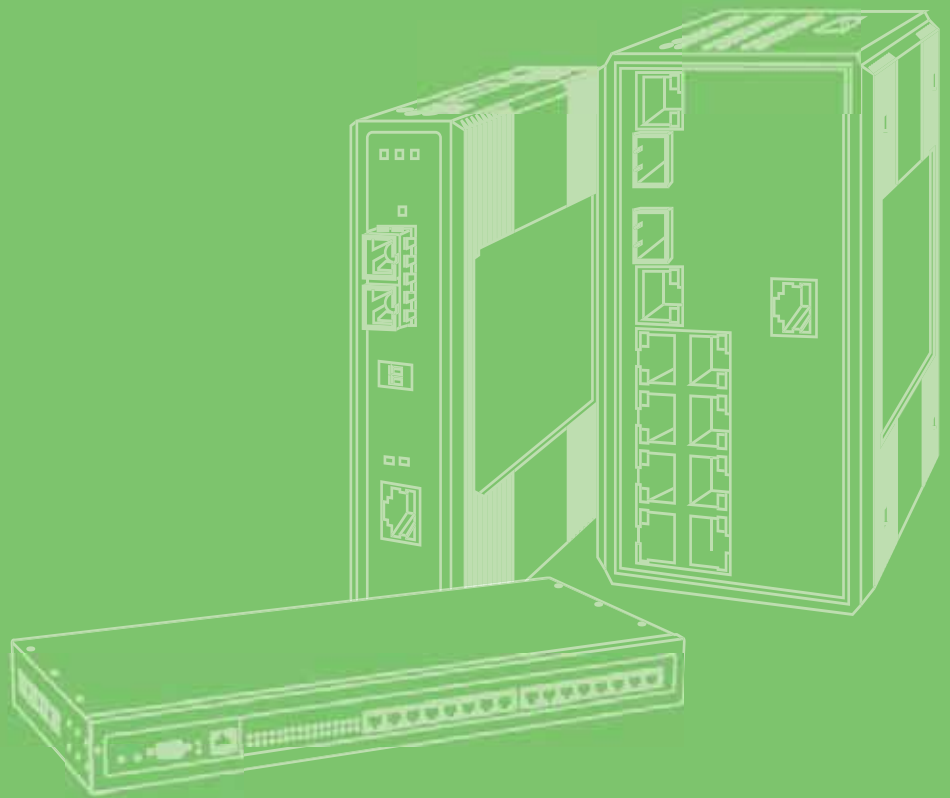

EKI-1361/EKI-1362

1/2-port RS-232/422/485 to
802.11b/g/n WLAN Serial Device
Server

ADVANTECH **iCom**

Industrial Communication

Copyright

The documentation and the software included with this product are copyrighted 2013 by Advantech Co., Ltd. All rights are reserved. Advantech Co., Ltd. reserves the right to make improvements in the products described in this manual at any time without notice. No part of this manual may be reproduced, copied, translated or transmitted in any form or by any means without the prior written permission of Advantech Co., Ltd. Information provided in this manual is intended to be accurate and reliable. However, Advantech Co., Ltd. assumes no responsibility for its use, nor for any infringements of the rights of third parties, which may result from its use.

Acknowledgements

Intel and Pentium are trademarks of Intel Corporation.

Microsoft Windows and MS-DOS are registered trademarks of Microsoft Corp.

All other product names or trademarks are properties of their respective owners.

Product Warranty (5 years)

Advantech warrants to you, the original purchaser, that each of its products will be free from defects in materials and workmanship for two years from the date of purchase.

This warranty does not apply to any products which have been repaired or altered by persons other than repair personnel authorized by Advantech, or which have been subject to misuse, abuse, accident or improper installation. Advantech assumes no liability under the terms of this warranty as a consequence of such events.

Because of Advantech's high quality-control standards and rigorous testing, most of our customers never need to use our repair service. If an Advantech product is defective, it will be repaired or replaced at no charge during the warranty period. For out-of-warranty repairs, you will be billed according to the cost of replacement materials, service time and freight. Please consult your dealer for more details.

If you think you have a defective product, follow these steps:

1. Collect all the information about the problem encountered. (For example, CPU speed, Advantech products used, other hardware and software used, etc.) Note anything abnormal and list any onscreen messages you get when the problem occurs.
2. Call your dealer and describe the problem. Please have your manual, product, and any helpful information readily available.
3. If your product is diagnosed as defective, obtain an RMA (return merchandise authorization) number from your dealer. This allows us to process your return more quickly.
4. Carefully pack the defective product, a fully-completed Repair and Replacement Order Card and a photocopy proof of purchase date (such as your sales receipt) in a shippable container. A product returned without proof of the purchase date is not eligible for warranty service.
5. Write the RMA number visibly on the outside of the package and ship it prepaid to your dealer.

Declaration of Conformity

CE

This product has passed the CE test for environmental specifications. Test conditions for passing included the equipment being operated within an industrial enclosure. In order to protect the product from being damaged by ESD (Electrostatic Discharge) and EMI leakage, we strongly recommend the use of CE-compliant industrial enclosure products.

FCC Class B

Note: This equipment has been tested and found to comply with the limits for a Class B digital device, pursuant to part 15 of the FCC Rules. These limits are designed to provide reasonable protection against harmful interference in a residential installation. This equipment generates, uses and can radiate radio frequency energy and, if not installed and used in accordance with the instructions, may cause harmful interference to radio communications. However, there is no guarantee that interference will not occur in a particular installation. If this equipment does cause harmful interference to radio or television reception, which can be determined by turning the equipment off and on, the user is encouraged to try to correct the interference by one or more of the following measures:

- Reorient or relocate the receiving antenna.
- Increase the separation between the equipment and receiver.
- Connect the equipment into an outlet on a circuit different from that to which the receiver is connected.
- Consult the dealer or an experienced radio/TV technician for help.

Declaration of Conformity

For Wireless Device

This device complies with Industry Canada licence-exempt RSS standard(s). Operation is subject to the following two conditions: (1) this device may not cause interference, and (2) this device must accept any interference, including interference that may cause undesired operation of the device.

For ITE Products

Industry Canada - Class B

This digital apparatus does not exceed the Class B limits for radio noise emissions from digital apparatus as set out in the interference-causing equipment standard entitled "Digital Apparatus", ICES-003 of Industry Canada.

Technical Support and Assistance

1. Visit the Advantech web site at www.advantech.com/support where you can find the latest information about the product.
2. Contact your distributor, sales representative, or Advantech's customer service center for technical support if you need additional assistance. Please have the following information ready before you call:
 - Product name and serial number
 - Description of your peripheral attachments
 - Description of your software (operating system, version, application software, etc.)
 - A complete description of the problem
 - The exact wording of any error messages

Safety Instructions

1. Read these safety instructions carefully.
2. Keep this User Manual for later reference.
3. Disconnect this equipment from any AC outlet before cleaning. Use a damp cloth. Do not use liquid or spray detergents for cleaning.
4. For plug-in equipment, the power outlet socket must be located near the equipment and must be easily accessible.
5. Keep this equipment away from humidity.
6. Put this equipment on a reliable surface during installation. Dropping it or letting it fall may cause damage.
7. The openings on the enclosure are for air convection. Protect the equipment from overheating. **DO NOT COVER THE OPENINGS.**
8. Make sure the voltage of the power source is correct before connecting the equipment to the power outlet.
9. Position the power cord so that people cannot step on it. Do not place anything over the power cord.
10. All cautions and warnings on the equipment should be noted.
11. If the equipment is not used for a long time, disconnect it from the power source to avoid damage by transient overvoltage.
12. Never pour any liquid into an opening. This may cause fire or electrical shock.
13. Never open the equipment. For safety reasons, the equipment should be opened only by qualified service personnel.
14. If one of the following situations arises, get the equipment checked by service personnel:
 - The power cord or plug is damaged.
 - Liquid has penetrated into the equipment.
 - The equipment has been exposed to moisture.
 - The equipment does not work well, or you cannot get it to work according to the user's manual.
 - The equipment has been dropped and damaged.
 - The equipment has obvious signs of breakage.
15. **DO NOT LEAVE THIS EQUIPMENT IN AN ENVIRONMENT WHERE THE STORAGE TEMPERATURE MAY GO BELOW -40° C (-40° F) OR ABOVE 80° C (140° F). THIS COULD DAMAGE THE EQUIPMENT. THE EQUIPMENT SHOULD BE IN A CONTROLLED ENVIRONMENT.**

16. CAUTION: DANGER OF EXPLOSION IF BATTERY IS INCORRECTLY REPLACED. REPLACE ONLY WITH THE SAME OR EQUIVALENT TYPE RECOMMENDED BY THE MANUFACTURER, DISCARD USED BATTERIES ACCORDING TO THE MANUFACTURER'S INSTRUCTIONS.
17. The sound pressure level at the operator's position according to IEC 704-1:1982 is no more than 70 dB (A).

DISCLAIMER: This set of instructions is given according to IEC 704-1. Advantech disclaims all responsibility for the accuracy of any statements contained herein.

Safety Precaution - Static Electricity

Follow these simple precautions to protect yourself from harm and the products from damage.

- To avoid electrical shock, always disconnect the power from your PC chassis before you work on it. Don't touch any components on the CPU card or other cards while the PC is on.
- Disconnect power before making any configuration changes. The sudden rush of power as you connect a jumper or install a card may damage sensitive electronic components.

Contents

Chapter 1	Overview.....	1
1.1	Introduction	2
1.2	Features	3
1.3	Specifications	3
1.4	Package Check List	5
Chapter 2	Getting Started.....	7
2.1	Understanding EKI-1361/EKI-1362.....	8
2.1.1	Product Description.....	8
	Figure 2.1 Dual Ethernet Connections.....	8
2.1.2	COM Port Redirector (Virtual COM Port).....	9
	Figure 2.2 COM Port Redirector	9
	Figure 2.3 Multi-Access Mode	10
2.1.3	TCP Server Mode	11
	Figure 2.4 TCP Server Mode	11
2.1.4	TCP Client Mode.....	11
	Figure 2.5 TCP Client Mode	11
2.1.5	Serial Tunneling Mode	12
	Figure 2.6 Serial Tunneling Mode.....	12
2.1.6	UDP Server/Client Mode.....	12
2.1.7	Control Mode	12
2.2	Hardware.....	13
2.2.1	LED Indicators	13
	Table 2.1: EKI-1361/1362 series LED Indicators	13
2.2.2	Dimensions (Units: mm).....	14
	Figure 2.7 DIN-Rail Mount of EKI-1361	14
	Figure 2.8 Wall Mount of EKI-1361.....	14
	Figure 2.9 DIN-Rail Mount of EKI-1362	15
	Figure 2.10 Wall Mount of EKI-1362.....	15
2.3	Connecting Hardware	16
2.3.1	Choosing the Location	16
	Figure 2.11 Combine the Metal Mounting Kit	16
	Figure 2.12 DIN-rail Step 2	16
2.3.2	Wireless Connection	17
2.3.3	Network Connection.....	17
2.3.4	Power Connection.....	17
	Figure 2.13 Power Connector	17
2.3.5	Serial Connection.....	18
	Table 2.2: EKI-152X series Serial Pin Assignments.....	18
2.4	Installing the Configuration Utility.....	18
Chapter 3	Configuration	21
21		
3.1	Configuration Utility Overview	22
3.2	Discovering Serial Device Servers	23
3.2.1	Auto Searching	23
3.2.2	Clear Device List and Search Again	25
3.2.3	Manual Appending	25
3.3	Network Settings	26
3.4	Administrator Settings	28

	3.4.1	Locate the Serial Device Server	28
	3.4.2	Lock the Serial Device Server (Password Protection)	28
	3.4.3	Restore to Factory Default Settings	30
	3.4.4	Update Firmware	31
Chapter	4	Setting COM Redirector	33
	4.1	Setting COM Redirector (Virtual COM port)	34
	4.1.1	Auto Mapping	34
	4.1.2	Manual Mapping	36
	4.1.3	Manual Direct Mapping Virtual COM Port	38
	4.1.4	Remove the Virtual COM Port	38
Chapter	5	Web-Based Configuration	41
	5.1	Overview	42
	5.2	Accessing the Web Page	42
	5.3	System	43
	5.4	Network Configuration	44
	5.5	Wireless Configuration	45
	5.6	Port Configuration	48
	5.6.1	Basic Port Configuration	49
	5.6.2	Operation Mode	49
	5.7	Monitor	57
	5.8	Auto Warning (Alarm)	58
	5.8.1	Email Alert	58
	5.8.2	SNMP Trap	59
	5.8.3	System Event	59
	5.8.4	Serial Port Event	60
	5.9	Change Password	60
	5.10	Import/Export Device Settings	61
	5.11	Reboot	62
Chapter	6	Telnet Configuration	63
	6.1	Overview	64
	6.2	Telnet Console	64
	6.3	Command List	65
		Table 6.1: Console Command List	65
Appendix A		Pin Assignments	79
	A.1	Pin Assignments	80
	A.1.1	RS-232 Pin Assignments	80
	A.1.2	RS-422/485 Pin Assignments	80
Appendix B		List of Known TCP and UDP Port Numbers	81
	B.1	List of Known TCP and UDP Port Numbers	82

Chapter 1

Overview

1.1 Introduction

Advantech's EKI-1300 series of Industrial Device Servers are a robust, feature-rich, and cost effective way to network-enable equipment in an industrial automation environment. The EKI-1361/1362 provides one or two serial ports, 802.11b/g/n wireless LAN interface to connect any RS-232/422/485 devices to wireless LAN. These wireless serial device servers provide serial-to-wireless network connectivity as an alternative to wired Ethernet connectivity and enable virtually any serial device or equipment to be remotely accessed, controlled, monitored, or shared on an 802.11b/g/n wireless network.

By encapsulating serial data and transporting it over Ethernet, the EKI-1361/1362 allows virtual serial links over Ethernet IP-based networks. After Advantech Serial Device Server Configuration Utility installed, standard serial operation calls with virtual COM port could be transparently redirected to the serial device servers, guaranteeing compatibility with legacy serial devices and enabling backward compatibility with existing software. EKI-1361/1362 also supports serial tunneling, allowing two native serial devices to communicate over a network without any hosts or programming. As a result, you can extend limited distance, point-to-point, direct serial connections within the plant, throughout the factory, the facility, the office building, or across the global enterprise.

The EKI-1361/1362 provides an impressive list of features and functions enabling multiple industrial devices to be connected, controlled, configured, managed, and updated over a network. With serial ports and 802.11b/g/n wireless LAN, the EKI-1361/1362 can easily connects multiple serial devices to a network. The transmission speed of the EKI-1361/1362 is up to 921.6 Kbps totally outstripping the competition to meet the demand for high-speed exchange. Functionally transparent and efficient, the EKI-1361/1362 is especially designed for remotely controlling and monitoring devices via the Internet.

The EKI-1361/1362 provides roaming ability. EKI-1361/1362 can midgrade from AP to AP during certain condition. In some field applications, the device can't use a fixed physical connection, such as AGV, transportation, and cross wide space communication. EKI-1361/1362 can easily installed to fulfill this requirement. With compact size and lightweight design, EKI-1361/1362 could be installed onto the moving vehicle without much extra loading.

Types of supported devices:

- Human Machine Interface (HMI)
- Programmable Controller(PLC)
- Flow meters
- Temperature / pressure monitoring equipment
- Gas leak detection device
- Scales
- Power monitoring equipment
- Data Acquisition Modules

EKI-136X series provides various operation modes: COM port redirection (Virtual COM port), TCP/UDP server/client mode. Serial devices can be connected by means of multi-access modes.

1.2 Features

- Support standard Wireless 802.11 b/g/n
- Support MIMO 2x2 technology
- Expand up 4096 serial ports for one single host
- Provides 10/100/1000 Mbps auto-sensing Ethernet ports for easy diagnostic
- Supports any baud rate setting from 50 bps up to 921.6 Kbps
- Supports various operation modes: COM port redirection (Virtual COM port), TCP server/client, UDP server/client, control mode and RFC-2217 mode
- Easy to diagnostic LED indicators
- Supports multi-access features: allows maximum 5 hosts to access one serial port simultaneously
- Allows maximum 16 peers in TCP/UDP client mode
- Mounts on DIN rail, wall, or panel easily
- Surge protection for RS-422/485 line and power supply
- SNMP MIB-II for network management

1.3 Specifications

WLAN Interface

- Standard Conformance: 802.11b, 802.11g, and 802.11n
- Network Modes: Infrastructure, Ad-Hoc
- Transmit Power:
 - 802.11b: +16 dBm (typical)
 - 802.11g: +16 dBm @ 6~36 Mbps, +11 dBm @ 54Mbps
 - 802.11n/HT20: +16 dBm @ MCS 0 ~ 3, +9 dBm @ MCS 7, +19dBm @ MCS 9, +11 dBm @ MCS 15
 - 802.11n/HT40: +16 dBm @ MCS 0 ~ 3, +8 dBm @ MCS 7, +19dBm @ MCS 9, +11 dBm @ MCS 15
- Receive Sensitivity: -82 dBm (Max.)
- Data Rate:
 - 802.11b: 1, 2, 5.5, and 11 Mbps
 - 802.11g: 6, 9, 12, 18, 24, 36, 48, and 54 Mbps
 - 802.11n:
 - 20 MHz Channel:
 - 1Nss: 65 Mbps @ 800 GI, 72.2 Mbps @ 400 GI (Max.)
 - 2Nss: 130 Mbps @ 800 GI, 144.4 Mbps @ 400 GI (Max.)
 - 40 MHz Channel:
 - 1Nss: 135 Mbps @ 800 GI, 150 Mbps @ 400 GI (Max.)
 - 2Nss: 270 Mbps @ 800 GI, 300 Mbps @ 400 GI (Max.)
- Transmission Distance: Up to 100 meters (in open areas with bundle external antenna)
- Wireless Security:
 - WEP: 64-bit/128-bit data encryption
 - WPA, WPA2, 802.11i: Enterprise mode and Pre-Share Key (PSK) mode
 - Encryption: EAP-TLS, EAP-TTLS, EAP-PEAP
- Antenna Connector: Reverse SMA

Bundle External Antenna

- Frequency Range: 2.4GHz ~ 2.5GHz
- Impedanc: 50Ω Nominal
- VSWR: 1.92:1Max.
- Return Loss: 10dB Max.
- Radiation: Omni-directional
- Gain(Peak): 2dBi
- Polarization: Linear; Vertical
- Admitted Power: 1W

LAN

- Ethernet: 10/100 Mbps auto sensing
- No. of Ports: 1
- Port Connector: RJ45
- Protection: Built-in 1.5 KV magnetic isolation

Serial Interface

- Interface: RS-232/422/485, software selectable
- No. of Ports:
 - EKI-1361: 1
 - EKI-1362: 2
- Port Connector: DB9 male
- Baud Rate: 50 bps to 921.6 Kbps
- Parity: None, Even, Odd, Space, Mark
- Data bits: 5, 6, 7, 8
- Stop bits: 1, 1.5, 2
- Flow control: XON/XOFF, RTS/CTS, DTR/DSR
- Signals:
 - RS-232: TxD, RxD, CTS, RTS, DTR, DSR, DCD, RI, GND
 - RS-422: TxD+, TxD-, RxD+, RxD-, GND
 - RS-485: Data+, Data-, GND
- Protection: 15 KV ESD for all signals, enhanced protection for RS-422/485 lines

Software

- Utility: Advantech Serial Device Server Configuration Utility
- Driver support: Windows 2000/XP/Vista/7, Windows Server 2003/2008, Linux
- Operation Mode:
 - COM port redirection (Virtual COM)
 - TCP/UDP server (polling) mode
 - TCP/UDP client (event handling) mode
 - Pair connection mode
- Configuration: Web interface, Windows utility, Telnet console
- Protocol: ICMP, IP, TCP, UDP, BOOTP, DHCP, Auto IP, Telnet, SNMP, HTTP, DNS, SMTP, ARP, NTP
- Management: SNMP MIB-II

General

- LED indicators:
 - System: Power, System Status
 - WLAN: Signal Strength, Link
 - LAN: Speed, Link/Active
 - Serial: Tx, Rx

Power

- Power input: 12 ~ 48 V(DC), redundant dual inputs
- Power connector: Terminal block
- Power Consumption:
 - EKI-1361: 8W
 - EKI-1362: 9W
- Power Line Protection: 1 KV burst (EN61000-4-4), 0.5 KV surge (EN51000-4-5)

Environmental

- Operation Temperature: -30 ~ 65°C (-22 ~ 149°F)
- Storage Temperature: -40 ~ 80°C (-40 ~ 176°F)
- Operating Humidity: 5 to 95% RH

Regulatory Approvals

- ECM: CE, FCC Part 15 Subpart B (Class B)

1.4 Package Check List

- 1 x EKI-1361/1362 Serial Device Server
- Panel/Wall mounting bracket
- DIN-rail mounting kit
- CD-ROM for utility and user manual

Optional Accessory:

- OPT1-DB9-AE D-sub 9 (female) to terminal block connector (for EKI-1000 series RS-422/485 use)

Chapter 2

Getting Started

2.1 Understanding EKI-1361/EKI-1362

The EKI-136X series are wireless-based, serial device servers for connecting RS-232/422/485 devices to a TCP/IP network. Once connected through EKI series, the serial device will be able to send and receive data on a network like any other network device. It extends traditional COM ports of a PC with access over a TCP/IP network. Through networking, you can control and monitor remote serial devices either over a LAN or over the WAN. Since the EKI series is connected through a TCP/IP network, you might need to know some basic facts about networking in order to get the server hooked up correctly.

2.1.1 Product Description

The EKI series is designed to network-enable any RS-232/422/485 serial device and provide industry-grade hardware and easy-use software to make connecting serial devices to an Ethernet network a surprisingly simple process. These units immediately upgrade your existing serial devices for integration into the Internet world. The EKI series features a lot of powerful functions such as: high speed data transfer, access-control, auto-detection of all EKI series products, remote connection from different network domain, remote firmware download, and more.

After the simple installation steps to attach your network and serial device to the appropriate connectors on the serial device servers and driver installation, you will then be able to communicate with the serial devices via its own application software and with the EKI serial device server. COM port redirector, TCP server mode, TCP client mode, UDP server mode, UDP client mode and Control mode are all different schemes to make a serial connection across using one or more Serial device server.

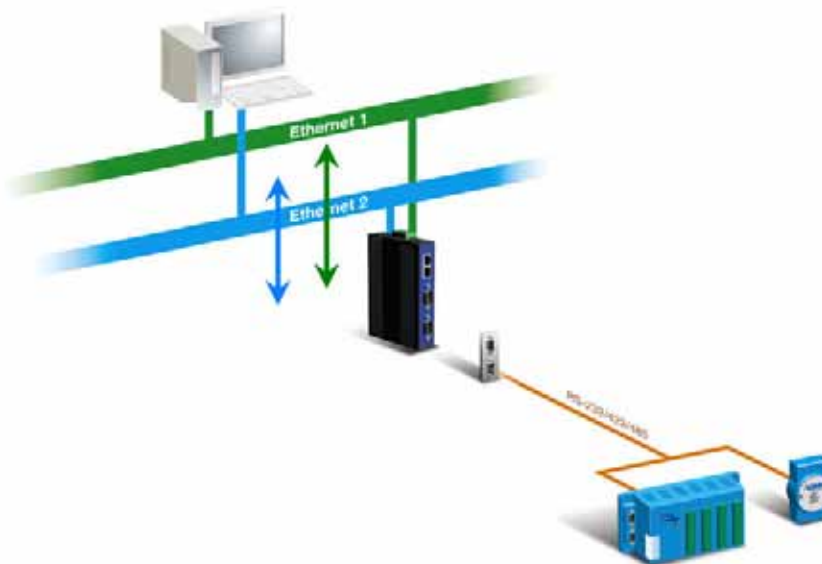

Figure 2.1 Dual Ethernet Connections

2.1.2 COM Port Redirector (Virtual COM Port)

Advantech Serial Device Server Configuration Utility is a serial COM port redirector that creates virtual COM ports and provides access to serial device connected to Advantech serial device server. You can configure the serial device server and enable the Virtual COM port using one integrated utility. Advantech Serial Device Server Configuration Utility allows you to configure Microsoft applications to communicate with network enabled serial device servers as easily as if they were physically installed in or directly connected on the PC.

The Advantech redirector can create up to 4096 virtual COM ports. Application on the host can open virtual COM port to access the serial device servers at the same time. The redirector will handle each active virtual COM port as a separate TCP connection to Advantech serial device servers.

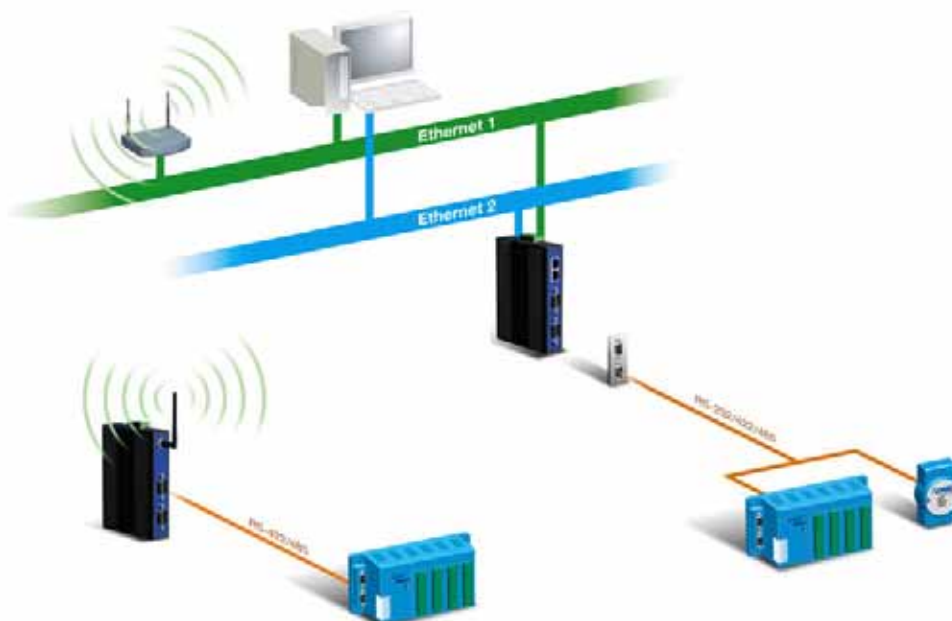

Figure 2.2 COM Port Redirector

2.1.2.1 Normal Mode

The Advantech redirector connects the Advantech serial device servers while an application open the COM port and disconnects from the Advantech serial device servers when the application closes the COM port. The redirector uses TCP network connections to the Advantech serial device server to gain the access to the connected serial devices.

2.1.2.2 Multi-Access Mode (Shared COM port mode)

Most of serial devices are connected directly and physically to the PC serial ports via a cable. The operation system, ex. Windows XP, provides the COM ports that user's application can access, and control the serial device through the serial cable. This means that the serial device can be connected to one host and only one application on this host can handle input, output and control operation on this device.

If you want to run more than one applications to use a serial device, you can employ EKI serial device servers that provide a virtual COM port for a host or multi-hosts on an Ethernet network. EKI serial device server is located between hosts and serial devices. Each serial port on the EKI serial device server can allow max. five host connections through one Ethernet port or two Ethernet ports. There are two major operation modes for Multi-Access Mode. First one is broadcast mode; EKI serial device server handles a command from one application and replies the data from the serial port to all applications that are connecting this serial port. Another one is polling mode; EKI serial device server handles the command from one application and reply to this application only. Query from other applications must be queued and wait for current process completing.

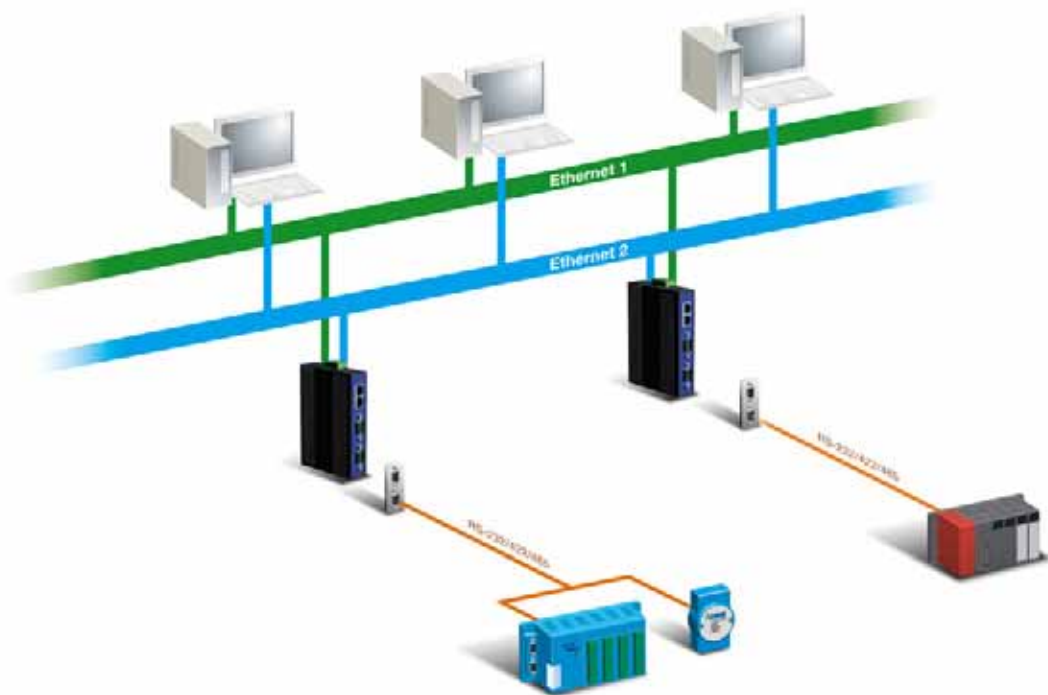

Figure 2.3 Multi-Access Mode

By using a serial device server to share serial device, you eliminate the separate serial lines and serial devices that can be attached to individual hosts. Collecting the data from these serial devices become more easily and more effectively.

2.1.3 TCP Server Mode

In TCP server mode, you might initiate the TCP connection from host to EKI serial device server. This operation mode support max. 5 simultaneous connections for each serial port on EKI serial device server from one host or several hosts, however multi-hosts collect the data from one serial port at the same time

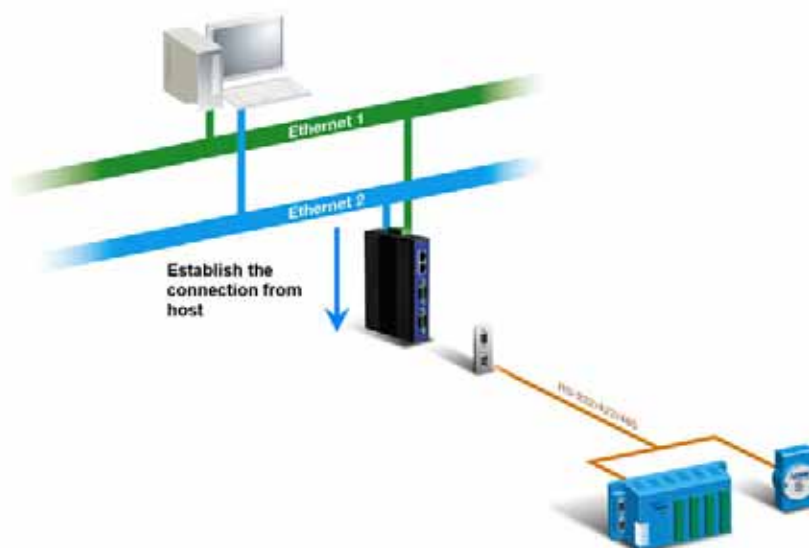

Figure 2.4 TCP Server Mode

2.1.4 TCP Client Mode

In TCP Client mode, the TCP connection will be established from EKI serial device server. This operation mode supports max.16 simultaneous connections for each serial port on EKI series to one host or several hosts. You should configure the IP address and TCP port number of the network hosts which the EKI serial device server connect to using Advantech Serial Device Server Configuration Utility. After configuration, when EKI serial device server receives the data from serial port, the device server will employ the connection to hosts which are configured.

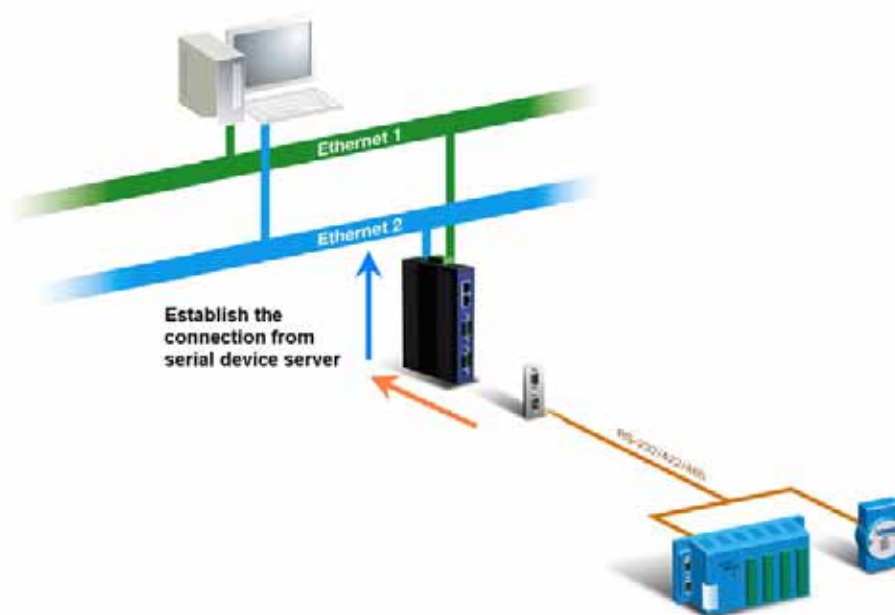

Figure 2.5 TCP Client Mode

2.1.5 Serial Tunneling Mode

Two native serial devices can communicate over an Ethernet network without any intermediate host PC and software programming. Serial Tunneling is very simple to use. You can use Advantech Serial Device Server Configuration Utility to designate one serial port as the tunneling master and another serial device server port as the tunneling slave.

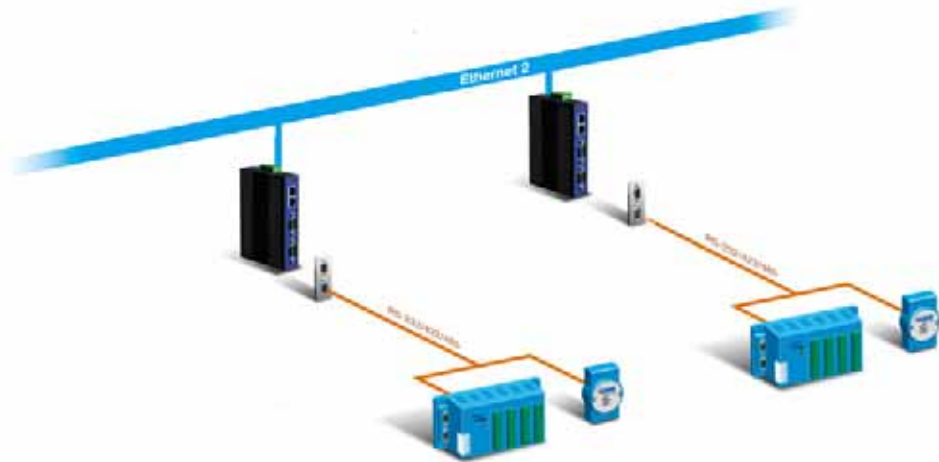

Figure 2.6 Serial Tunneling Mode

2.1.6 UDP Server/Client Mode

UDP is used primarily for broadcasting messages over a network. In the UDP server mode, EKI series access max. 8 hosts' UDP message. In the UDP client mode, EKI serial device servers transmit UDP message to max. 16 hosts simultaneously.

2.1.7 Control Mode

In controlling mode, the EKI serial device server presents a modem interface to the attached serial device: it accepts AT-style modem commands to connect / disconnect to other networking device. If you want serial device running application program to connect/disconnect to different devices by request, you can use controlling mode.

The controlling mode provides three kinds of modem AT-style commands. The serial devices can use these commands to control EKI series connecting or disconnecting to remote networking devices. Thus intelligent serial devices such as stand-alone PLC will send /receive data to/from devices one by one via Ethernet.

2.2 Hardware

In this section, we will give you an overview of EKI-1361/EKI-1362 hardware and installation.

2.2.1 LED Indicators

There are LEDs display the power status, network status, and serial communication status located on the front panel of EKI-1361/EKI-1362, each of them has its own specific meaning as below table.

Table 2.1: EKI-1361/1362 series LED Indicators

LED Name	LED Color	LED Description
PWR1	Green	Power 1 is on.
	Off	Power 1 is off, or power error condition exists.
PWR2	Green	Power 2 is on.
	Off	Power 2 is off, or power error condition exists.
Status	Status	Blinking: System is ready. Steady on: The device server has been located by utility's location function.
	Off	System is not working.
LAN	Green	Blinking: Ethernet port is transmitting or receiving data. Steady on: Ethernet has the good link for 10Mbps or 100Mbps operations.
	Off	Ethernet is not working.
WLAN	Orange	Steady on: WLAN link is ready
	Off	WLAN is not working.
Signal Strength	Off	0~25% WLAN signal strength.
	Orange (One)	25~50% WLAN signal strength.
	Orange (Two)	50~75% WLAN signal strength.
	Orange (Three)	75~100% WLAN signal strength.
Serial	Tx, Orange	Serial port is transmitting data.
	Rx, Green	Serial port is receiving data.
	Off	No data is transmitted or received through the serial port.

2.2.2 Dimensions (Units: mm)

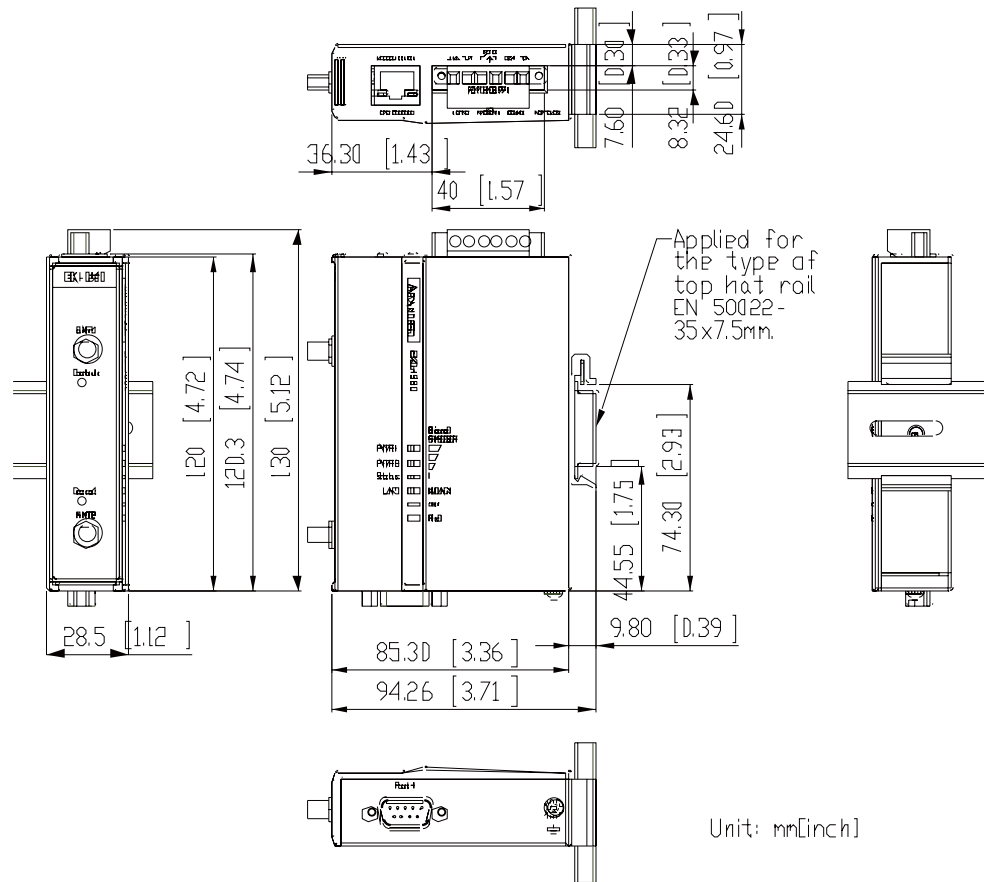

Figure 2.7 DIN-Rail Mount of EKI-1361

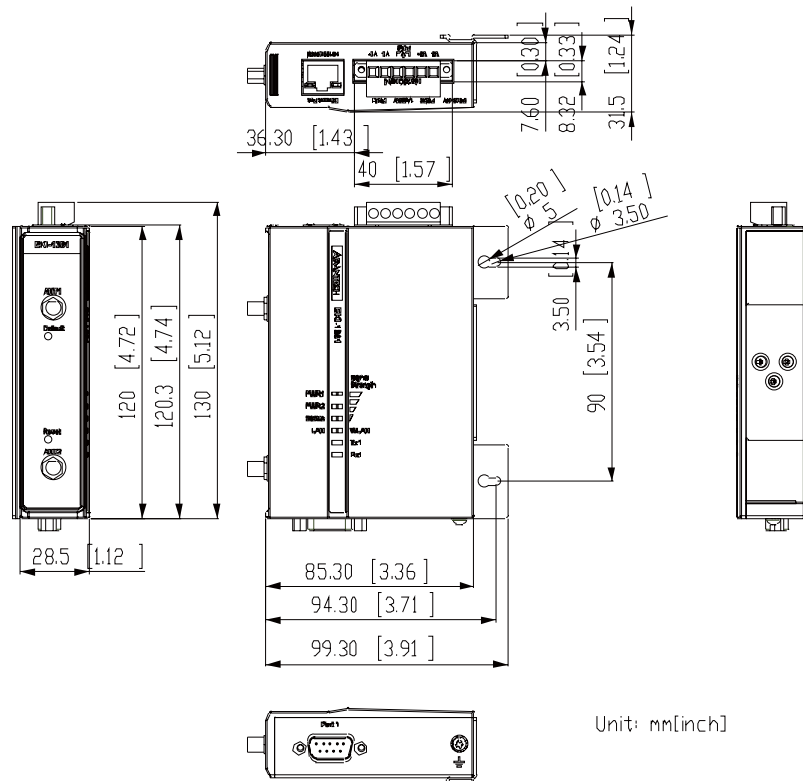

Figure 2.8 Wall Mount of EKI-1361

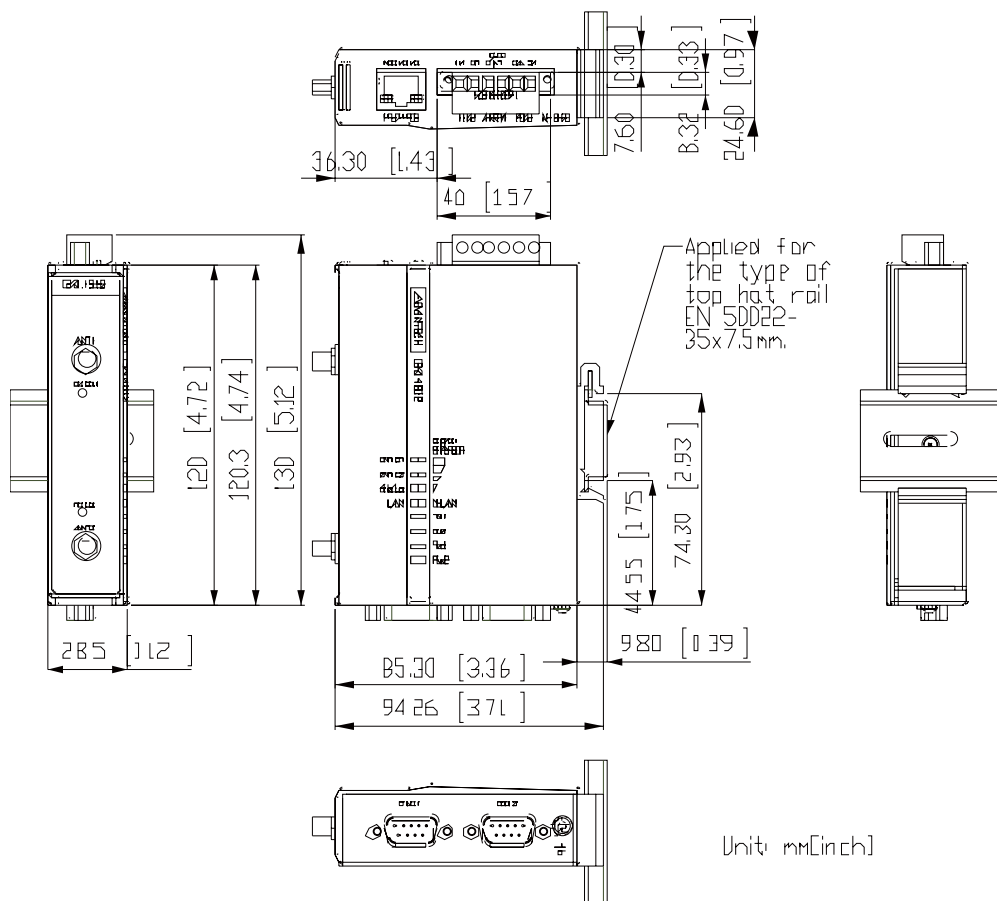

Figure 2.9 DIN-Rail Mount of EKI-1362

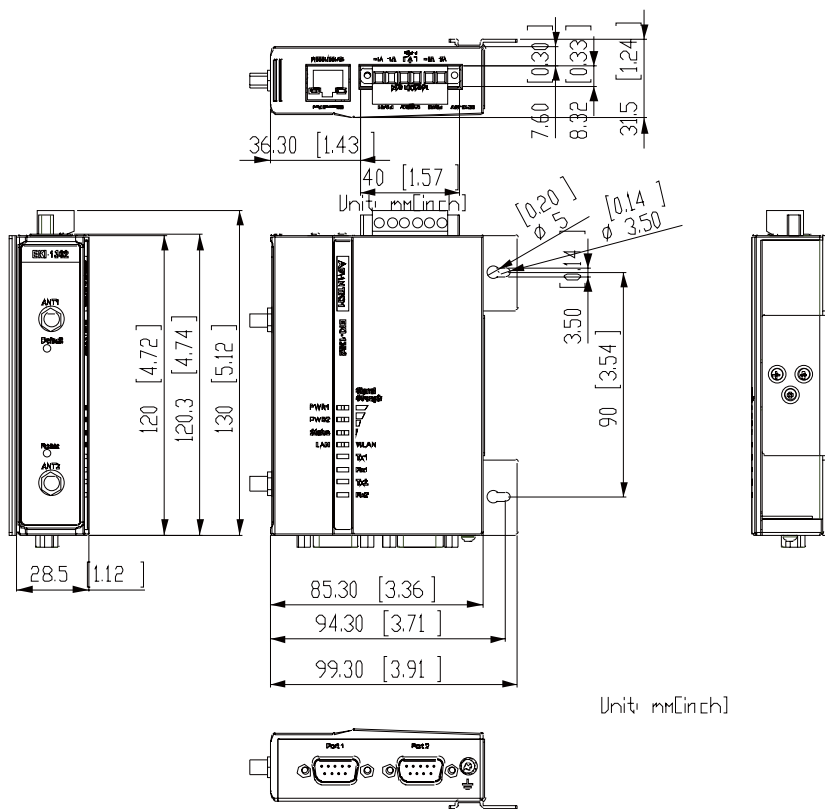

Figure 2.10 Wall Mount of EKI-1362

2.3 Connecting Hardware

Next, we will explain how to find a proper location for your EKI series, and then explain how to connect to the network, hook up the power cable, and connect to the EKI series serial port.

2.3.1 Choosing the Location

Due to its versatility and innovative design, EKI serial device server can be:

- Fixed to a panel/wall mount
- Fixed to a DIN-rail

2.3.1.1 Panel/Wall Mounting

The EKI-1361/EKI-1362 can be attached to a wall using the included metal brackets. Each bracket comes with 3 screws; and then you can install the device firmly via the components, please see the figure as below.

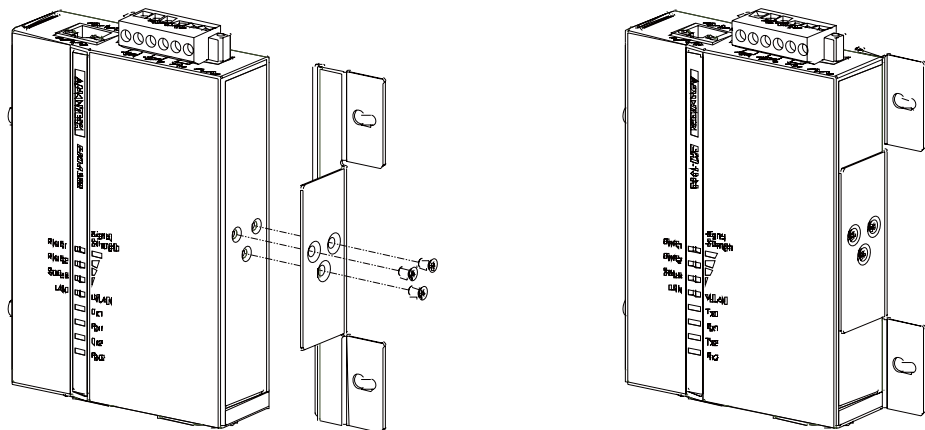

Figure 2.11 Combine the Metal Mounting Kit

2.3.1.2 DIN Rail Mounting

You can mount the EKI-152X series on a standard DIN-rail. Please screw the DIN-rail kit on the serial device server first.

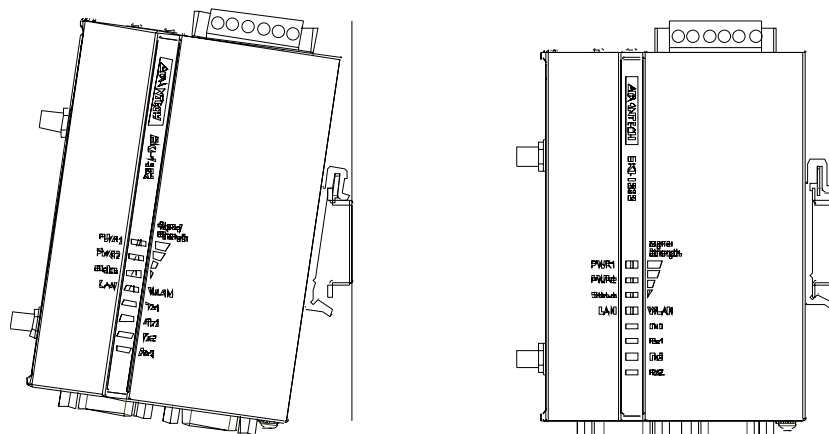

Figure 2.12 DIN-rail Step 2

2.3.2 Wireless Connection

EKI-1361/EKI-1362 operates in the 802.11b/g/n WLAN environment, which is created by an access point working with 802.11b/g/n protocols. When configuring EKI-1361/EKI-1362 in unknown status, user can use the Ethernet port and Configuration Utility to locate device easily. After found device in the Configuration Utility, user can configure the Ethernet and Wireless IP address to access web interface for advanced settings including serial port operation mode and wireless configurations. More detail description can be found in next chapters.

You can check the signal access strength with the WLAN signal strength LED indicators. Adjust the antenna of the EKI serial device server to optimize communication quality.

2.3.3 Network Connection

EKI-1361/EKI-1362 has a RJ-45 Ethernet port that supports 10 Mbps Ethernet, or 100 Mbps Fast Ethernet, and half or full duplex operation. EKI-1361/EKI-1362 can be connected to other hubs or switches through a twisted-pair straight through the cable or a crossover cable up to 100m long. When use EKI-1361/EKI-1362 for first time, user can connect to device with Configuration Utility. Or you can set the host's ip address in the same domain with device. Then user can use popular browser to connect web interface EKI-1361/EKI-1362 built-in for advanced configuration.

2.3.4 Power Connection

The EKI-1361/EKI-1362 supports dual 12 to 48 VDC power inputs and power-fail relay output.

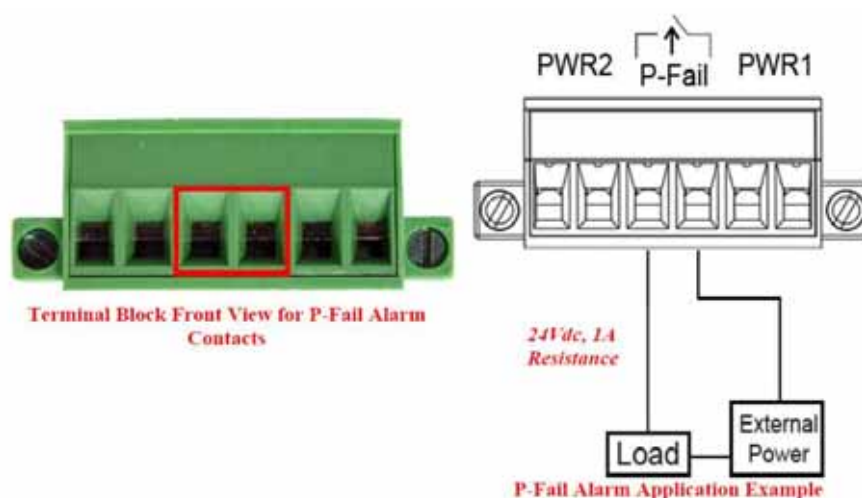

Figure 2.13 Power Connector

You can connect an alarm indicator, buzzer or other signaling equipment through the relay output. The relay opens if power input 1 or 2 fails (“Open” means if you connect relay output with an LED, the light would be off).

2.3.5 Serial Connection

EKI-1361/EKI-1362 provides 1 or 2 serial ports with DB9 (male) connectors. RS-232/422/485 pin assignments as below:

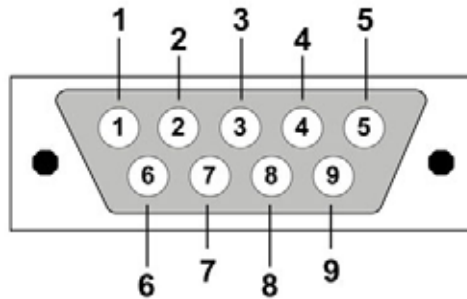

Table 2.2: EKI-152X series Serial Pin Assignments

Pin	1	2	3	4	5	6	7	8	9
RS-232	DCD	RX	TX	DTR	GND	DSR	RTS	CTS	RI
RS-422	TX-	-	-	TX+	GND	-	RX+	-	RX-
RS-485	DATA-	-	-	DATA+	GND	-	-	-	-

2.4 Installing the Configuration Utility

The following section will show you how to install the Advantech serial device server configuration utility, a tool to set up and monitor the EKI serial device servers.

Note! Be sure the Microsoft .NET Framework on your host PC is greater than version 2.0.



1. Insert the Advantech industrial communication IEDG series driver utility CD into the CD-ROM drive (e.g. E:\) on the host PC.
2. Use Windows explorer or the Windows Run command to execute the setup program, the path for the setup program on the CD-ROM should be: E:\Utility&Driver\SerialDeviceServerConfigurationUtility\Serial_Device_Server_Configuration_UTILITY_[Version]_Release_[date].exe

3. Upon executing the setup program, the Welcome Dialog Box will be pop-up. Press the "Next" button to continue.

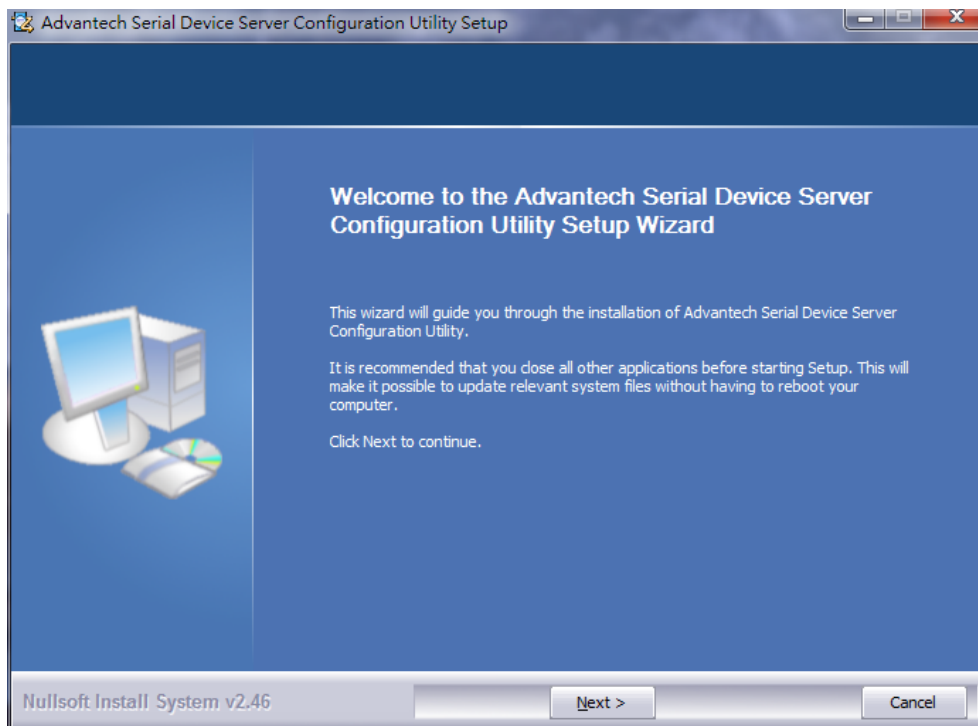

4. Carefully read the Software License Agreement, and press "Yes" to continue.

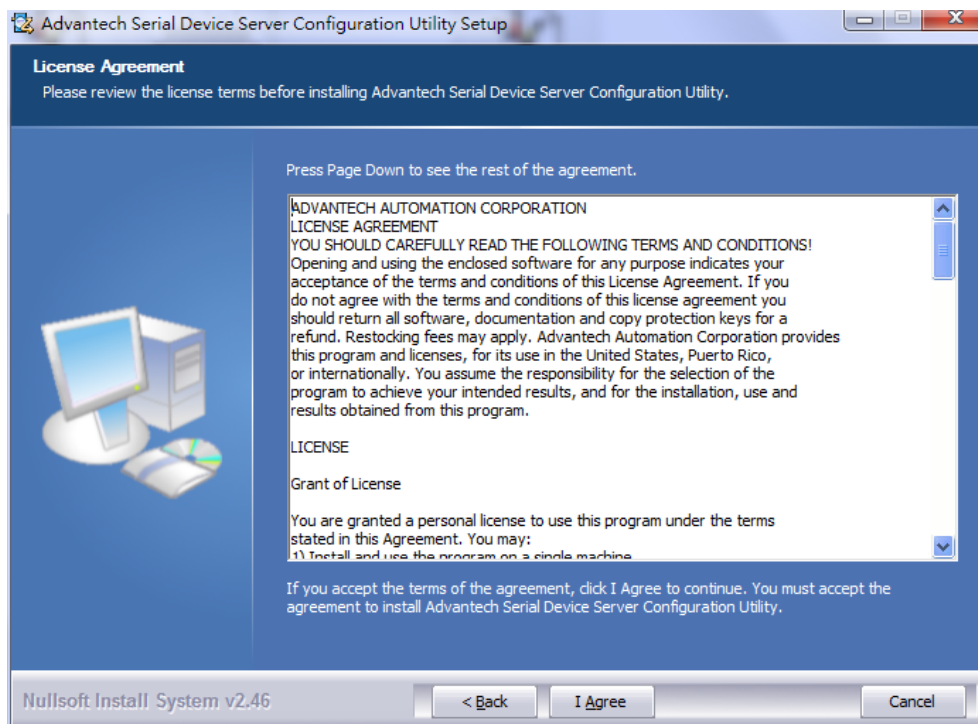

- The Setup program will specify a default installation path: C:\Program Files\Advantech eAutomation\Serial Device Server Configuration Utility\

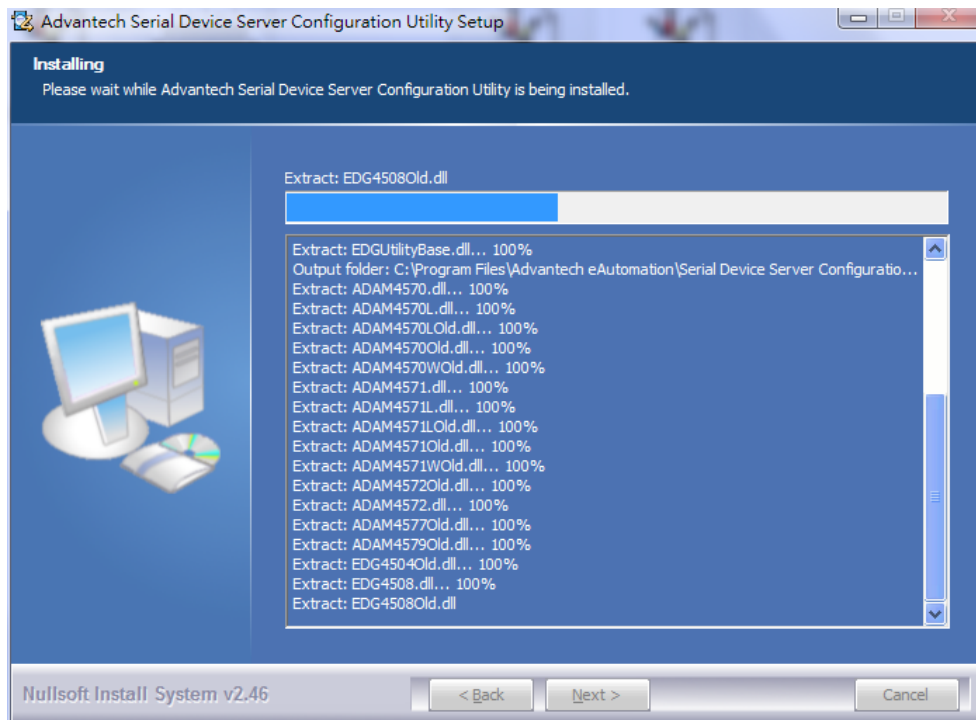

- After setup has copied all program files to your computer, click the <Finish> button to finish the installation.

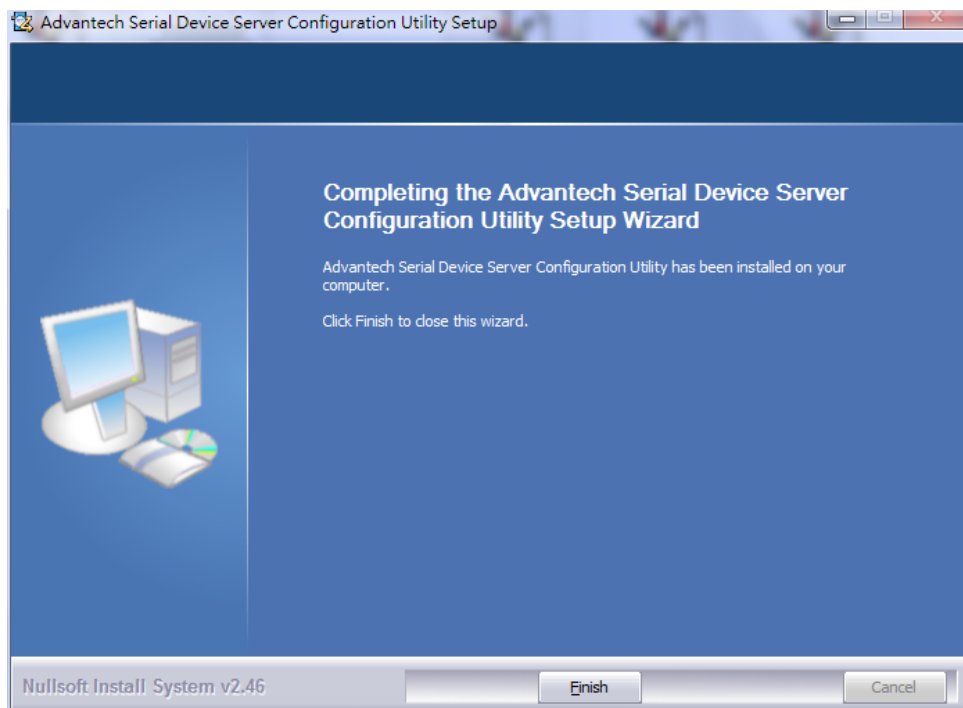

Chapter 3

Configuration

3.1 Configuration Utility Overview

Advantech provides an easy-to-use utility to configure the serial device servers through an Ethernet connection. User can use the utility to search or locate the device and configure it, even don't know the exactly ip address of the device.

Advantech Serial Device Server Configuration Utility is an excellent device server management tool. You can connect and configure the local and remote Advantech serial device servers easily. Moreover, Virtual COM port will be enabled in the same utility.

You may open the Serial Device Server Configuration Utility from the Windows Start Menu by clicking **Start → All Programs → Advantech eAutomation → Serial Device Server Configuration Utility**. The Serial Device Server Configuration Utility will appear as below.

There are four major areas in the serial device server configuration utility.

1. Serial Device Server List Area: All devices will be searched and listed in this area. You can arrange different favorite group and virtual COM ports.
2. Serial Device Server Information Area: Click on the serial device server or move cursor to the serial device server, the related information will be shown on this area.
3. Configuration Area: Click on the item on the Device Server List Area, the configuration page will display on the area.
4. Quick Tool Bar: Useful management functions shortcut.

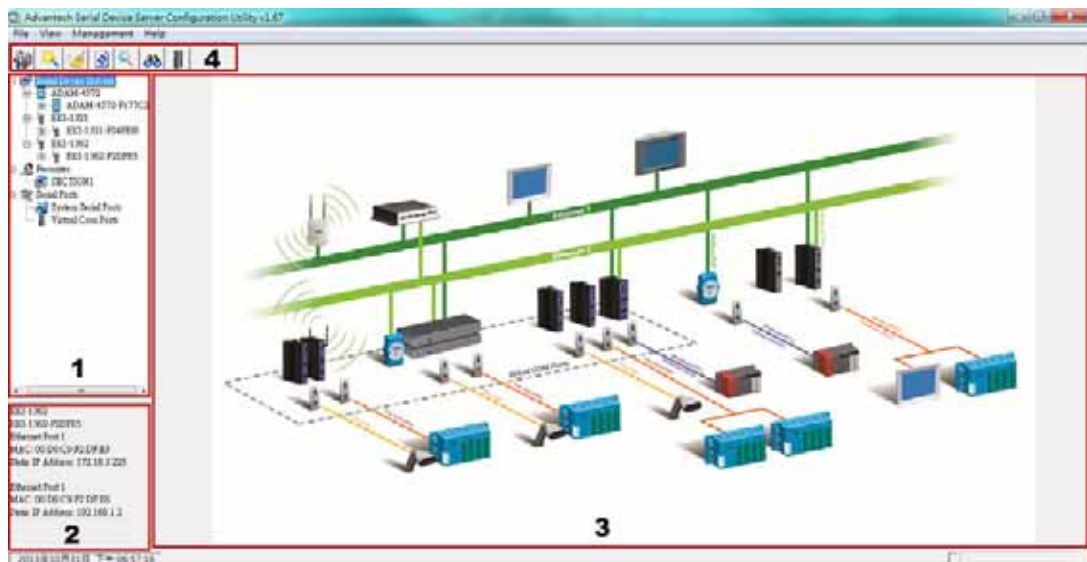

Note! Please reserve TCP/UDP port 5048 and 5058 in your Ethernet network, configuration utility will use these ports to communicate with Advantech EKI-1000, ADAM-4570, and EDG-4500 serial device servers.



3.2 Discovering Serial Device Servers

3.2.1 Auto Searching

Advantech Serial Device Server Configuration Utility will automatically search all the EKI-1000, ADAM-4570 and EDG-4500 series device servers on the network and show them on the Serial Device Server List Area of the utility. The utility provides an auto-search function to show your device(s) by simply executing the configuration utility program from the **Start Menu**.

From here all device on the same network domain will be searched and display on Device Server List Area. You can click on the device name to show the features of the specific device. Click on the “+” before the model name, and the utility will expand the tree structure to show the individual device name. Click on the “-” before the model name, and the utility will collapse the tree structure.



Note! *The default device name shown in the Configuration Utility will be the device model name appended with last 3 bytes of MAC address. You can change to a meaningful name for identification.*



Select the device in this sub-tree. The first tab on the “Configuration Area” shows the summary of “Basic Information” included device type, version, and name, “Ethernet Information”, and “Serial Port Information”. In the serial port information frame, it displays the operation mode, status and connected host IP.

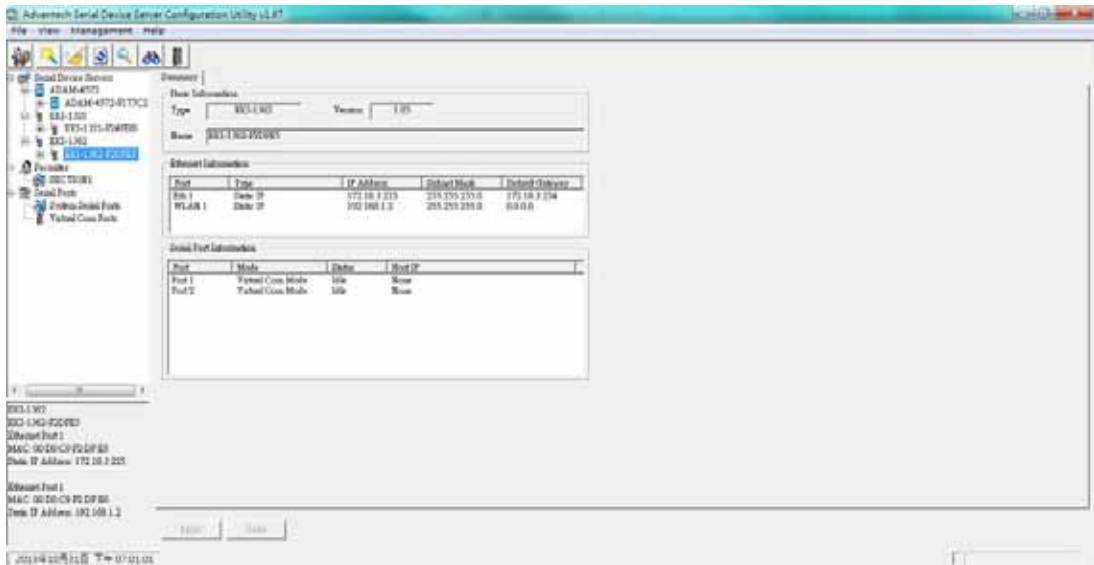

Click on the “+” before the device name, and the utility will expand the interfaces on this device server.

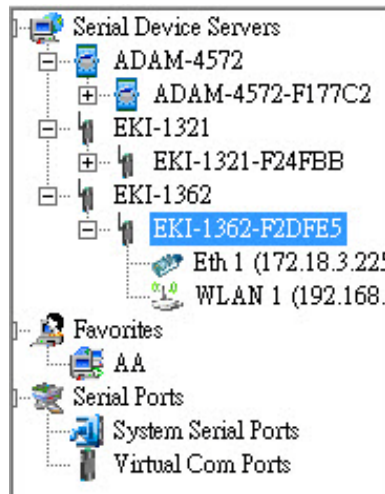

Click on each item, you will entry the configuration page to change the setting. The configuration will be introduced on following sections.

3.2.2 Clear Device List and Search Again

You can click the  button on the Quick Tool Bar. The utility will clear all list device servers in the Serial Device Server List Area and re-search again. Don't use this function frequently. The warning message will be pop-up when you double click this button.

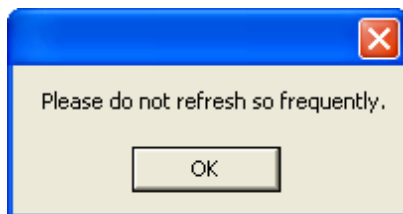

You can click the  button on the "Quick Tool Bar". The utility will search serial device server on local LAN.

3.2.3 Manual Appending

Using "Add IP address to Favorite" or "Search a Range of IP addresses" function, you are able to add one device or group of devices to "Favorites". These devices can locate on local network domain or other network domain.

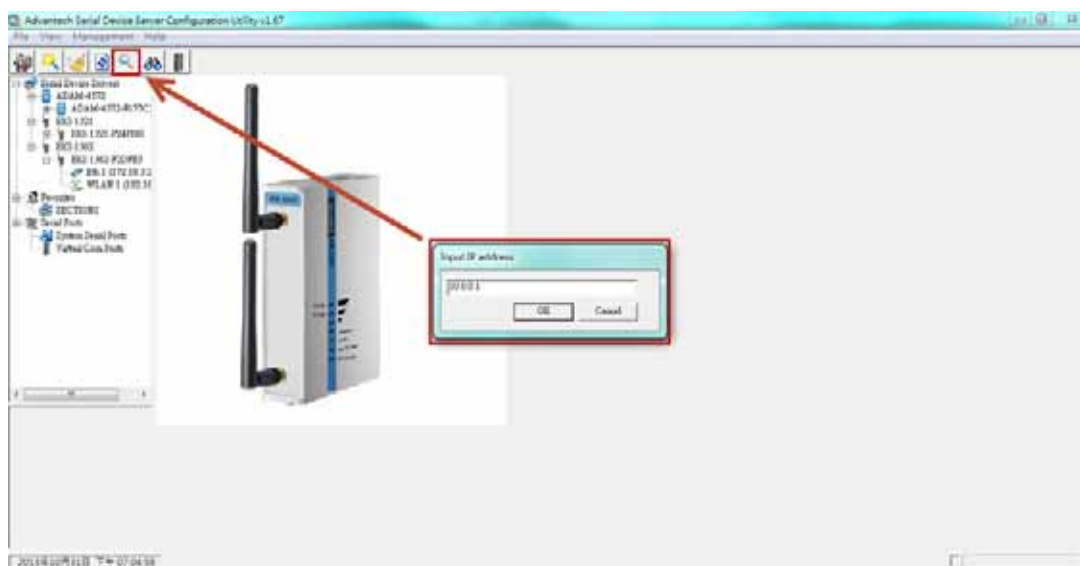

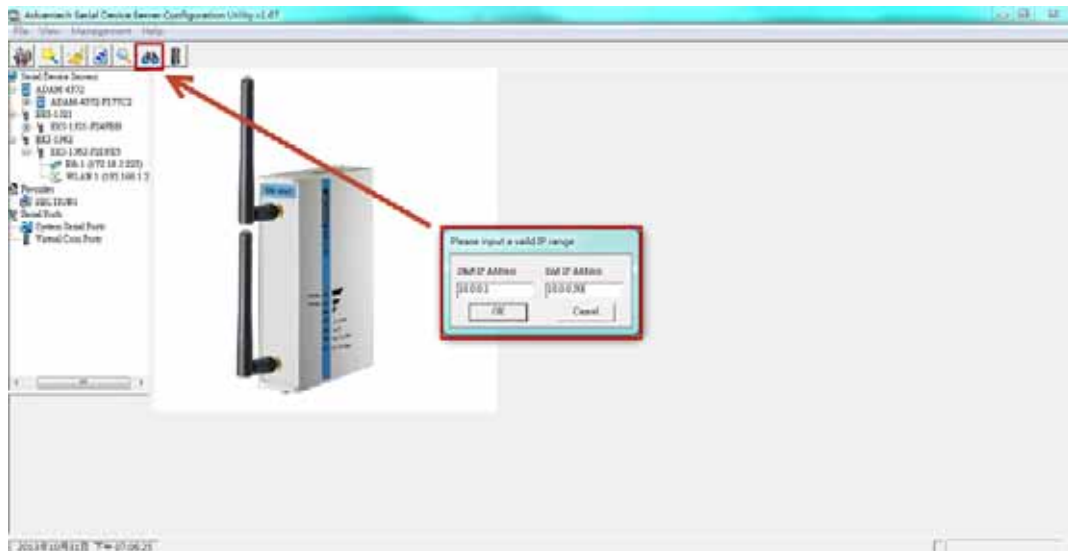

3.3 Network Settings

This section explains how to configure the network setting of EKI device using this utility so that it can communicate over a network with serial devices.

Click on the “+” before the model name, and the utility will expand the tree structure to show the individual device name. And click on the “+” before the device name, and the utility will expand the interfaces on this device server. Select the Ethernet interface. (Select Eth1 or Eth2, these are two individual Ethernet ports)

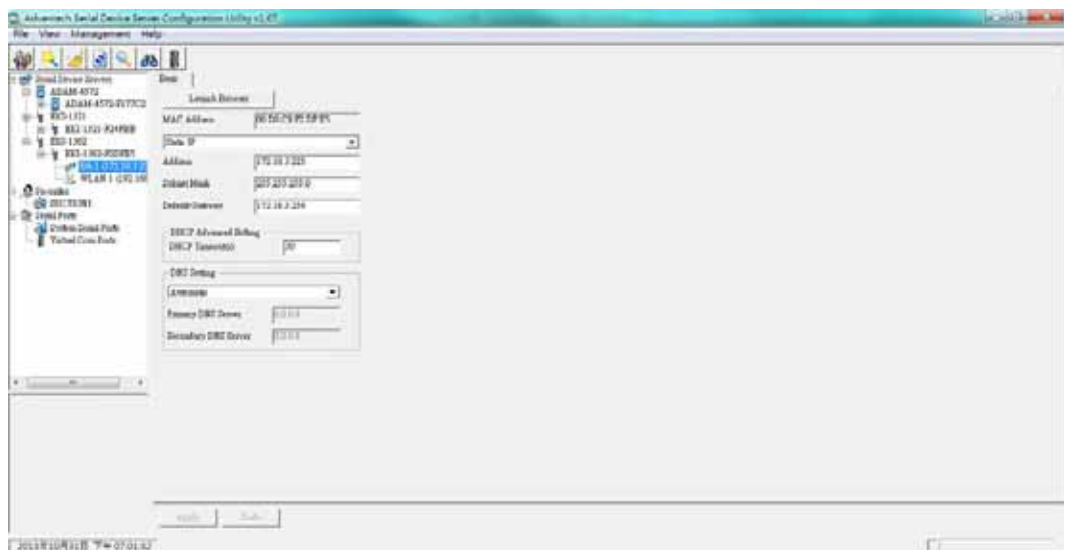

MAC address:

The MAC address is for the local system to identify and locate each serial device servers. This MAC address is already set before delivery from factory, hence no need for further configuration.

IP address, Subnet Mask, Default Gateway:

You can choose from four possible IP Configuration modes --- **Static**, **DHCP**, **BOOTP**, and **DHCP/BOOTP**.

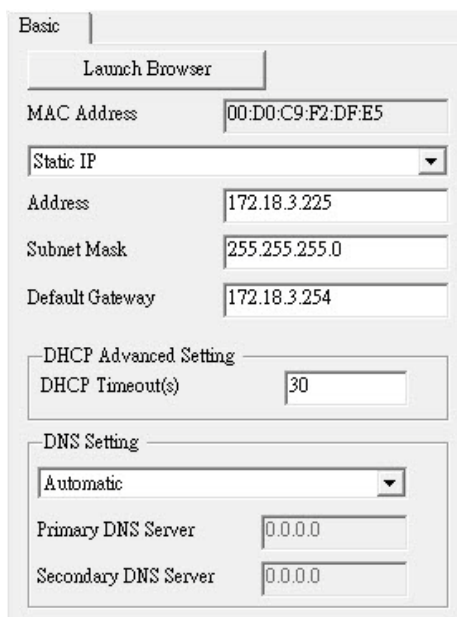
Static IP

User defined IP address, Subnet Mask, and Default Gateway.

DHCP + Auto-IP

DHCP Server assigned IP address, Subnet Mask, Default Gateway, and DNS.

BOOTP + Auto-IP

BOOTP Server assigned IP address.

DHCP + BOOTP + Auto-IP

DHCP Server assigned IP address, Subnet Mask, Default Gateway, and DNS, or BOOTP Server assigned IP address. (If the DHCP Server does not respond)

DHCP Timeout

When EKI device doesn't get response from DHCP server within specific timeout, the EKI device will give up the request and take next action.

DNS Setting

In order to use DNS feature, you need to set the IP address of the DNS server to be able to access the host with the domain name. The EKI-152X series serial device server provides Primary DNS Server and Secondary DNS Server configuration items to set the IP address of the DNS server. Secondary DNS Server is included for use when Primary DNS server is unavailable.

DHCP Advanced Setting

When you enabling DHCP protocol to get IP address, it will be waited DHCP server to give IP within DHCP timeout. The default value is 30 seconds.

Note!  When you have finished the configuration of these settings for each category, please press the "Apply" button in order to make these settings effective on the Serial Device Server. (Will reboot your Serial Device Server immediately)

3.4 Administrator Settings

The configuration utility provides several administrator settings for easy management and configuration. Right click the mouse on the device name in the sub-tree of Serial Device Sever List Area, and select these administrator settings.

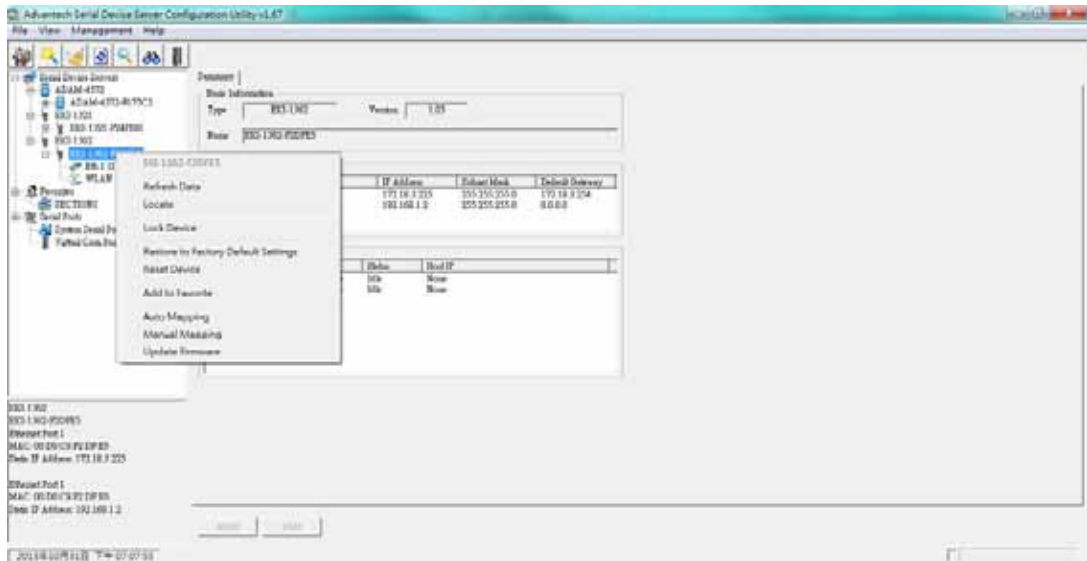

3.4.1 Locate the Serial Device Server

If there are many serial device servers need your management, you may need to identify which unit is correct to configuration on utility. Click “Locate” to make that unit’s “Status” LED be steady on and the buzzer will make the beep sound until you click “Stop Locate”.

3.4.2 Lock the Serial Device Server (Password Protection)

The configuration utility provides the “Lock Device” function to make it more confidential. You need to set up a password while the first time clicking “Lock Device”. Be sure to click “Reset Device” to restart the serial device server and store your setting password into the memory.

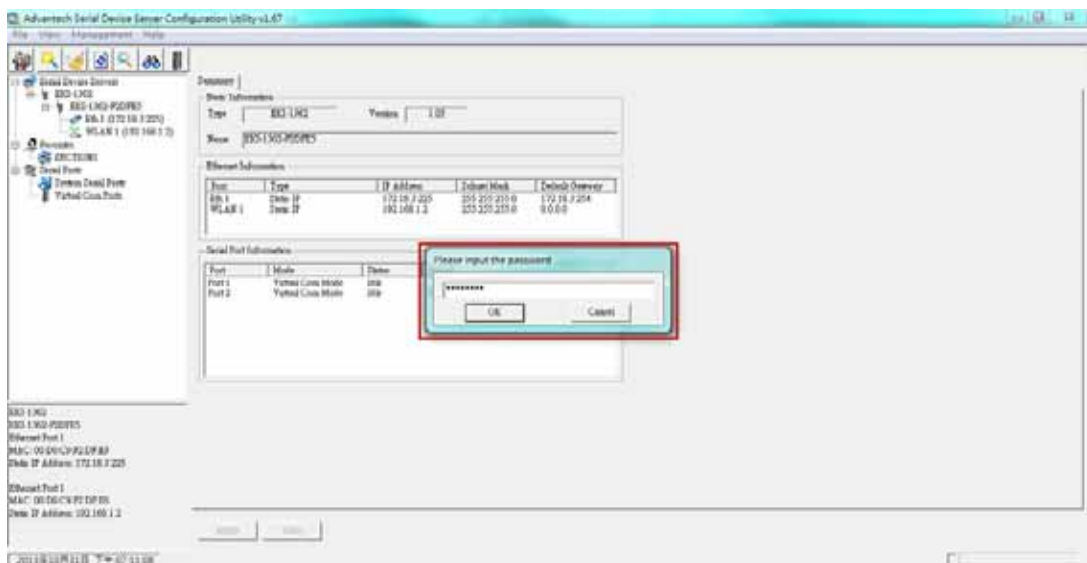

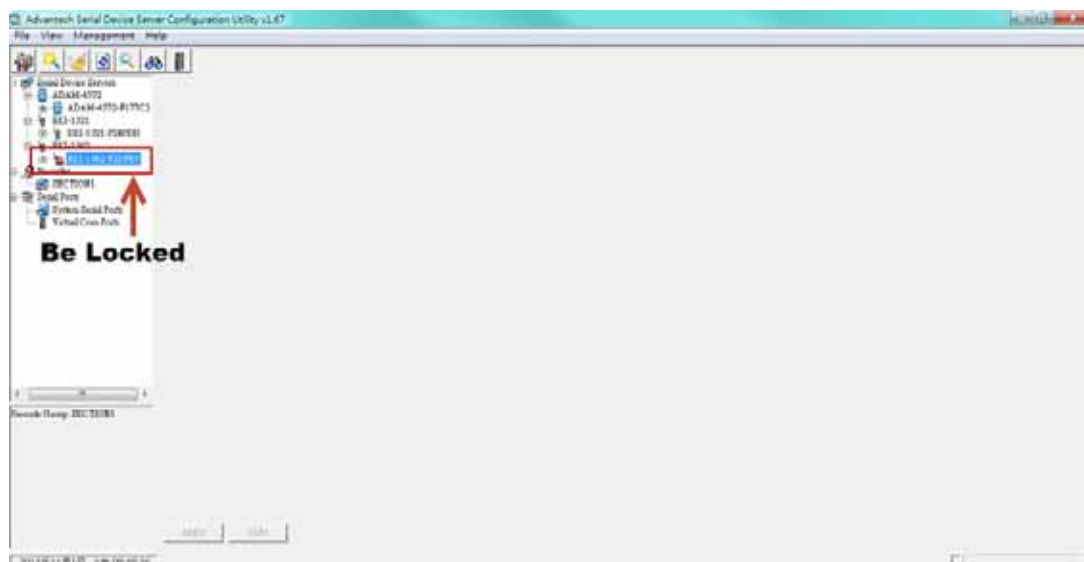

Click “Unlock Device” to unlock the serial device sever, and you need to fill in the password you have set up before. If you forgot the password, the only way to solve this problem is to restore the setting of the serial device server to the factory default which will be introduced next section.

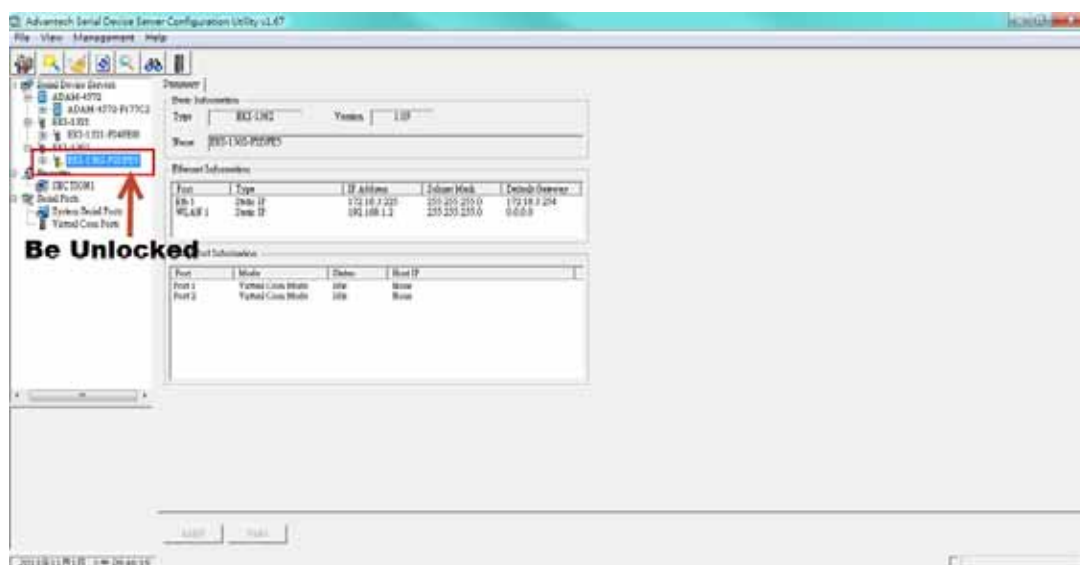

If you want to disable this function or change the password, click “Change Password” to change the password to default “None” (leave the new password and confirm new password columns blank) to disable this function or other password you want to change. Be sure to click “Reset Device” to restart the serial device sever and store the new password into the memory.

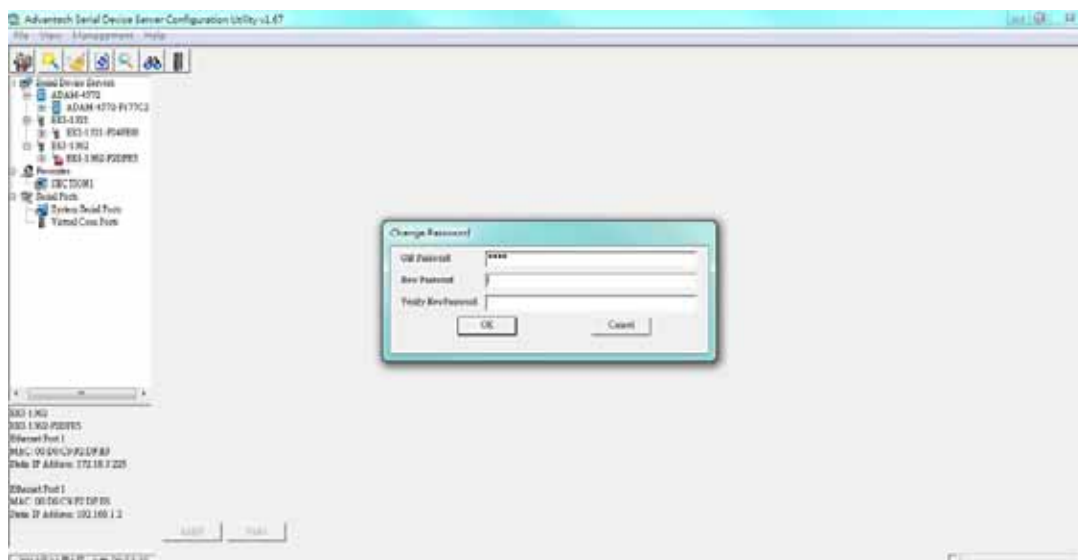

3.4.3 Restore to Factory Default Settings

The configuration utility provides this function to let you can restore the serial device server to factory default settings. The confirm message will be pop-up while clicking “Restore to Factory Default Settings”. If you really want to restore the serial device sever to factory default settings, please click “Yes” button to continue.

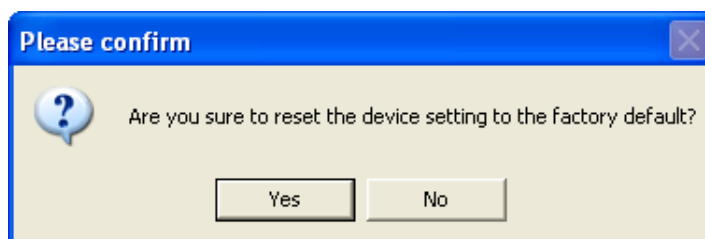

Then, please power off the serial device server within ten seconds, after reconnecting the power back, the all setting will be reset to the factory default. If the power remains more than ten seconds, the serial device server will not have any changes.

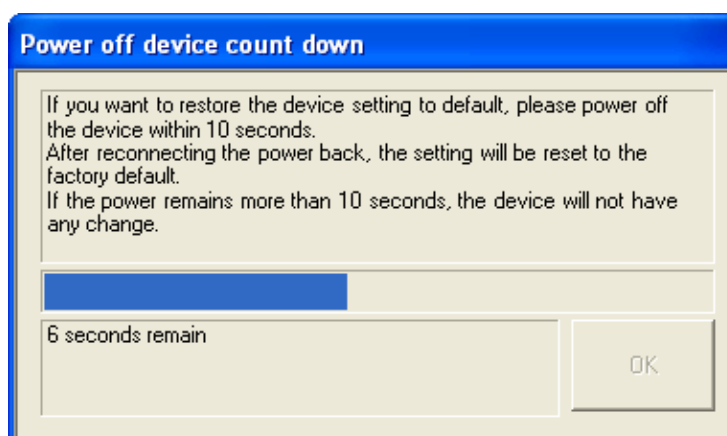

3.4.4 Update Firmware

Advantech continually upgrades its firmware to keep up with the ever-expanding world of computing. You can use the update firmware function in the utility to carry out the upgrade procedure. Please access Advantech's website: <http://www.advantech.com> to download the latest version of the firmware. Before update the firmware, make sure that your host's Network domain is as same as the serial device server or the host can establish the TCP connection to the serial device server.

Right Click on the device name and select "Update Firmware" function.

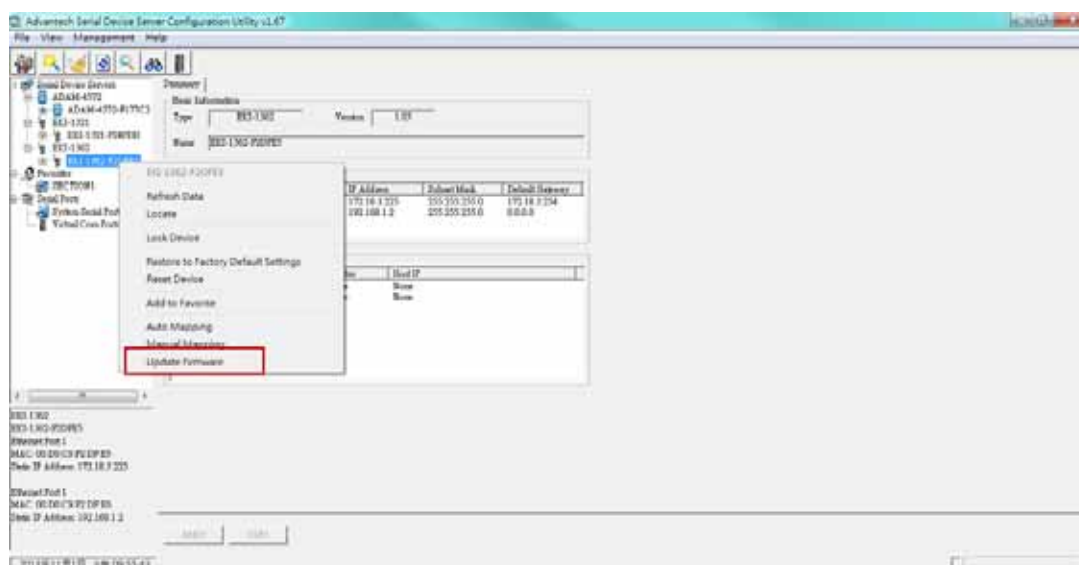

Select the firmware file you want to update.

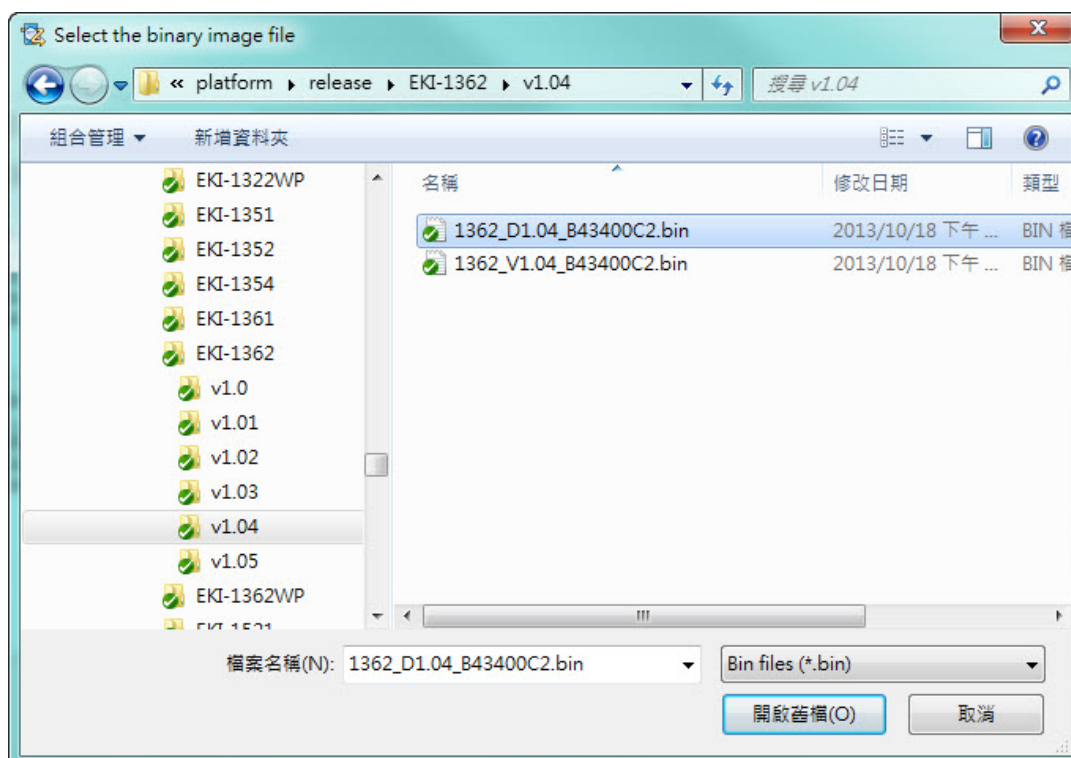

Wait for few seconds to process the updating firmware. After downloading the firmware completely, click on the “OK” button. The serial device server will restart automatically.

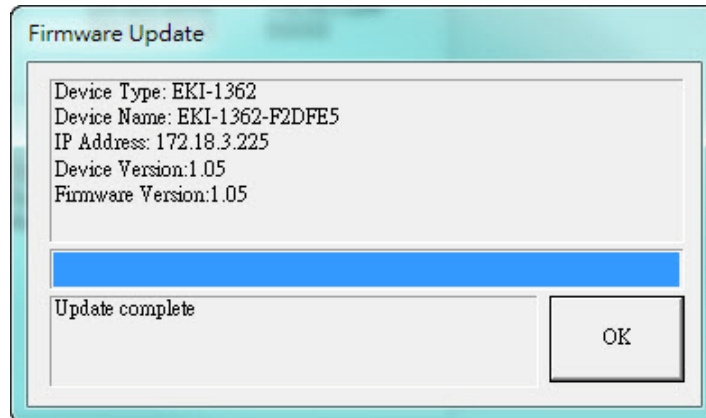

Note! *Be sure that the host PC Ethernet network domain is as same as the serial device server or the host PC can establish the TCP connection with the serial device server while doing the updating firmware process.*



Chapter 4

Setting COM
Redirector

4.1 Setting COM Redirector (Virtual COM port)

Advantech COM port mapping software is a serial COM port redirector that creates virtual COM ports and provides access to serial devices connected to Advantech serial device servers. Your serial device applications can communicate with serial devices connected to Advantech serial device servers without software changes. Since the virtual COM ports work like standard Windows COM ports, your application software sees no difference between a local serial device and one connected to a Advantech serial device server.

COM redirector utility and Virtual COM port Management utility are integrated into one utility with same GUI. Advantech Serial Device Server Configuration Utility can create all Virtual COM ports using “Auto Mapping” function. You can map the Virtual COM port by yourself.

4.1.1 Auto Mapping

Right click the serial device name on the sub-tree of Device Server List area and select the “Auto Mapping” function.

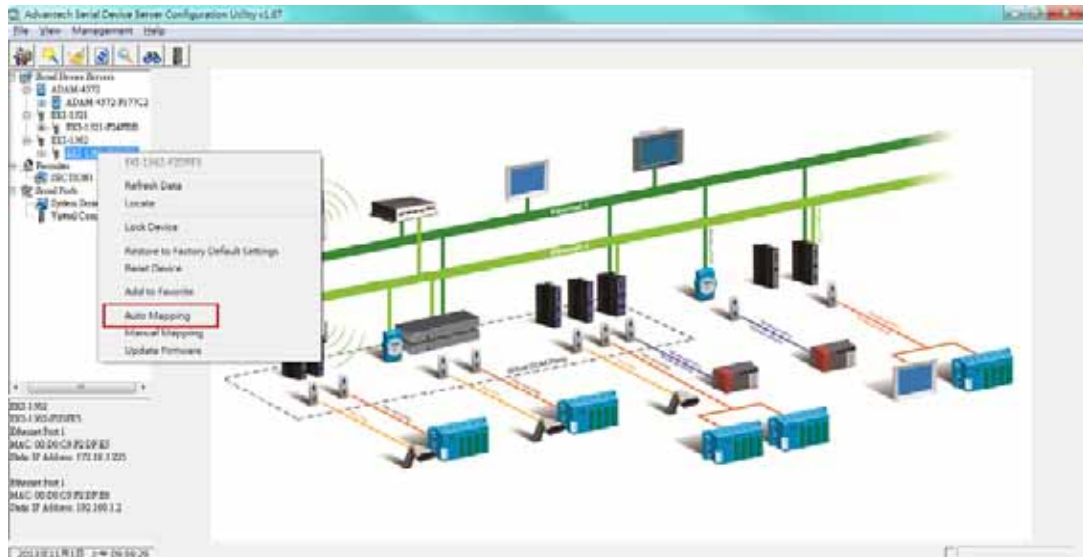

The serial ports that can be assigned to virtual COM will be shown in this window. Select the serial ports you wish to map or click the <Select All> button and press <Map Selected Ports> button. The selected serial ports will be mapped to virtual COM ports in sequential order.

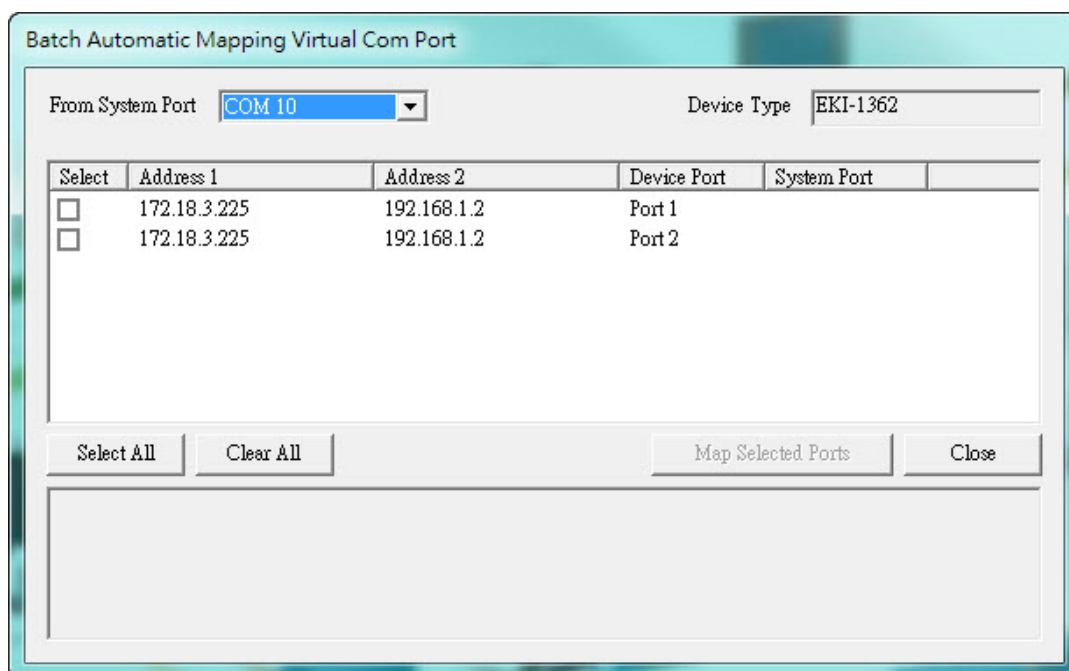

The COM ports in the “Virtual Com Ports” listing are now available for use by Windows applications.

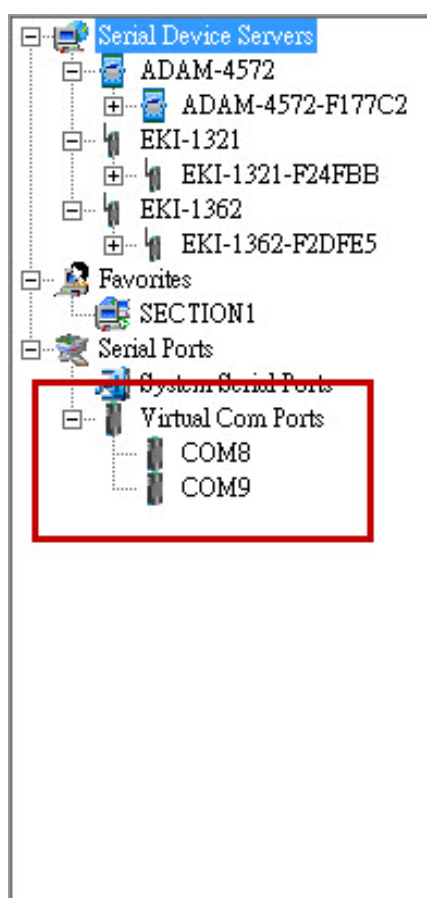

4.1.2 Manual Mapping

Right click the serial device name on the sub-tree of Device Server List area and select the “Manual Mapping” function.

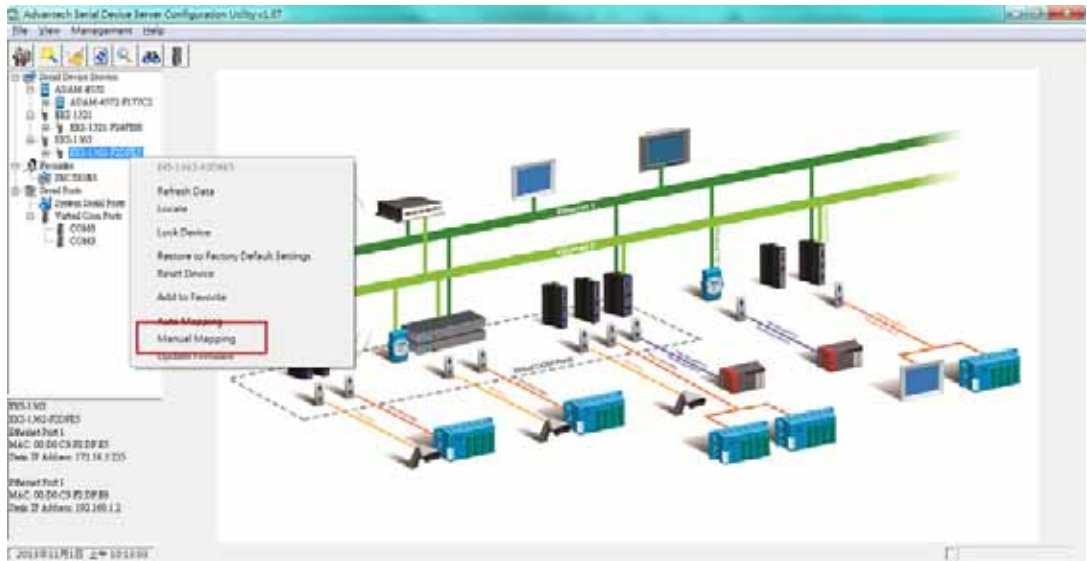

ADAM series, EDG series, and EKI wireless series have only one IP address. Select the serial port on the device server and the host COM that you want to set. Press <Map it> to establish the virtual COM port on the host.

Manual Mapping Virtual Com Port

Device Type	EKI-1362
Device	
Address 1	172.18.3.225
Address 2	192.168.1.2
Serial Port	Port 1
Host	
COM Port	COM 1
<input checked="" type="checkbox"/> Auto Reconnect	
Map it	Close

Auto Reconnect Property

Sometimes, the connection between Advantech serial device server and HOST is interrupted by network traffic or powered-off by accident. In such a situation, the host has to reconnect to Advantech serial device server. The function "Auto Reconnect" is for this purpose, if the Advantech serial server loses the connection to its host, the COM redirector will try to re-establish the connection while the host's AP access the virtual COM port. The COM redirector DOES NOT re-establish the connection automatically. When the connection is working again, the host's commands will be automatically received by the Advantech serial device server again. Reconfiguration is not necessary, so this function enhances the reliability of the system.

If the function is disabled, the connection can not be re-established again unless the COM redirector or host is restarted.

Serial device server has two Ethernet ports. You can select two Ethernet port to establish two Ethernet connections with one virtual COM port. It means that COM redirector will use one connection with the COM port on device server to communicate. If this connection failed, COM redirector will establish another Ethernet connection to communicate with device. The switch time will be 3 seconds ~ 5 seconds depending on the network traffic and host status.

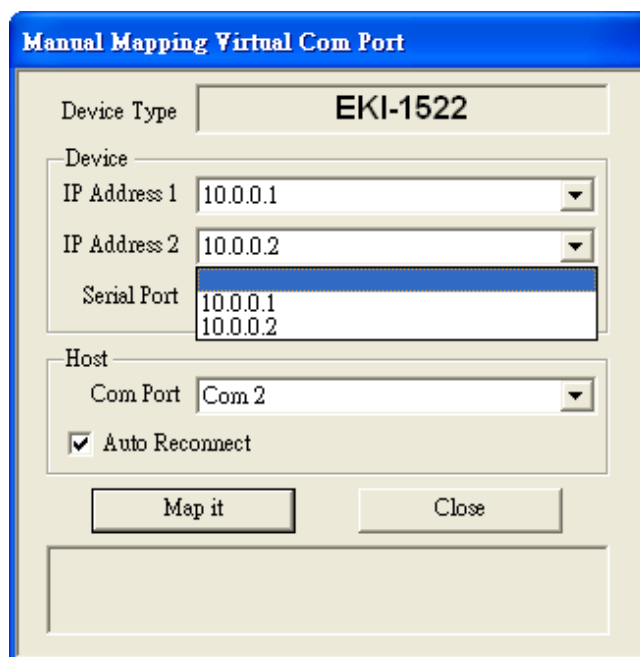

If you don't use the redundant function, just select the correct IP address in the IP address 1 field.

Note If you set the wrong IP address, COM redirector will still try to connect the device. It might cause the system performance low or other issue.

4.1.3 Manual Direct Mapping Virtual COM Port

Click the  button on the Quick Took area, you can add a target by selecting the Device Type and inputting the IP address without physically connecting the serial device server to the network.

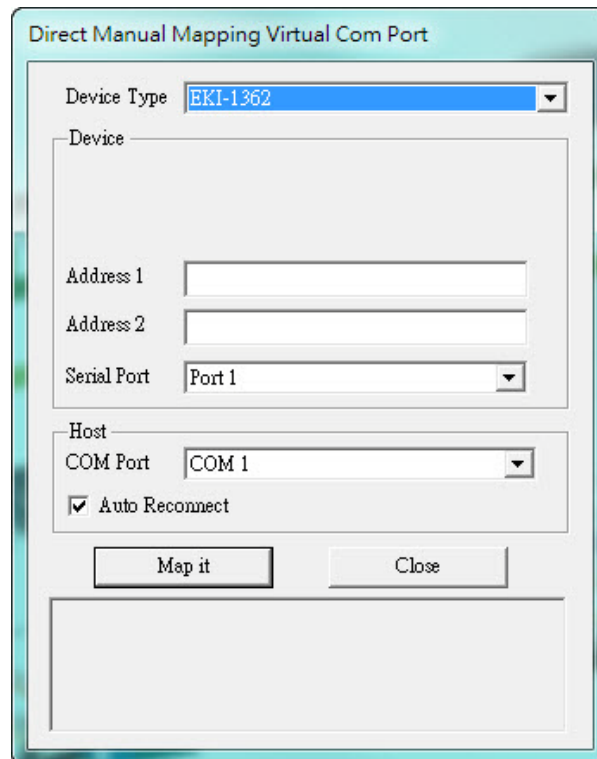

The dialog box titled "Direct Manual Mapping Virtual Com Port" contains the following fields and controls:

- Device Type: A dropdown menu with "EKI-1362" selected.
- Device: A large empty text area.
- Address 1: An empty text input field.
- Address 2: An empty text input field.
- Serial Port: A dropdown menu with "Port 1" selected.
- Host: A section containing a "COM Port" dropdown menu with "COM 1" selected.
- Auto Reconnect: A checked checkbox.
- Map it: A button.
- Close: A button.

4.1.4 Remove the Virtual COM Port

If you want to remove the virtual COM port, you can remove them one by one or group remove ports.

- Individually Remove
Right click on COM port you have mapped and select "Remove This Port".

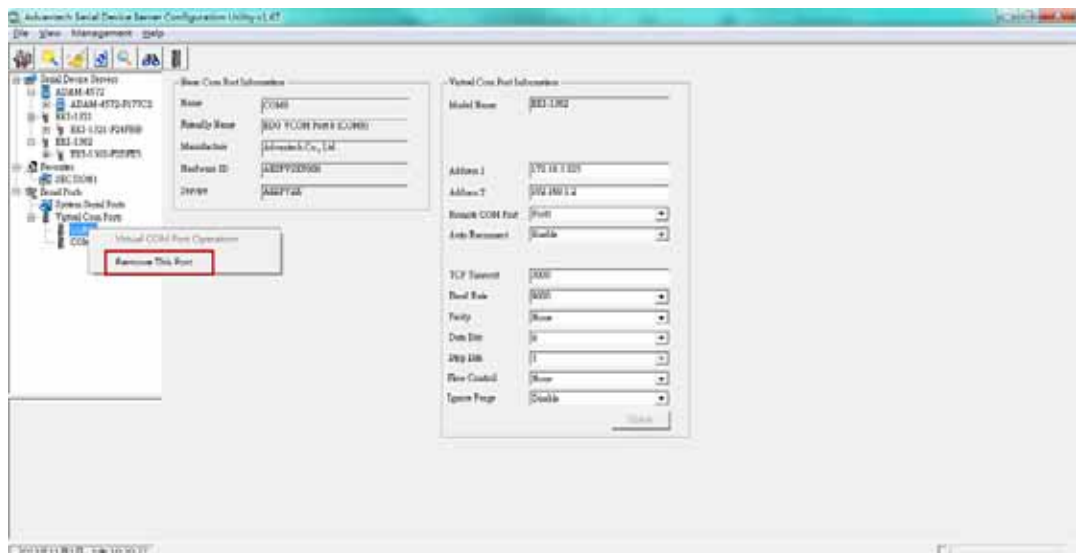

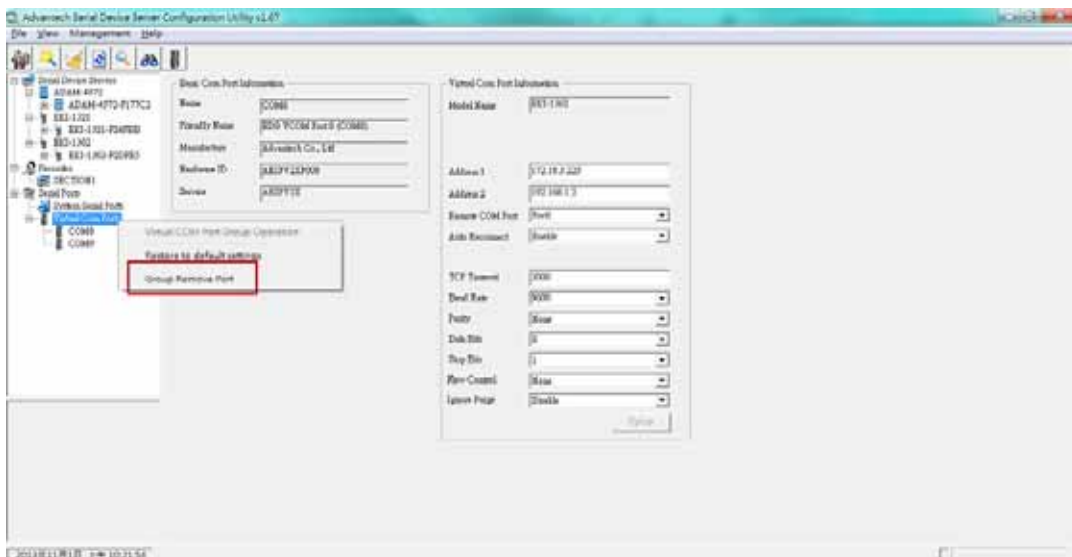

- **Group Remove Port**
 Right click on Virtual Com Ports on Device Server List Area and select “Group Remove Port”, you can choose which ports you want to remove.

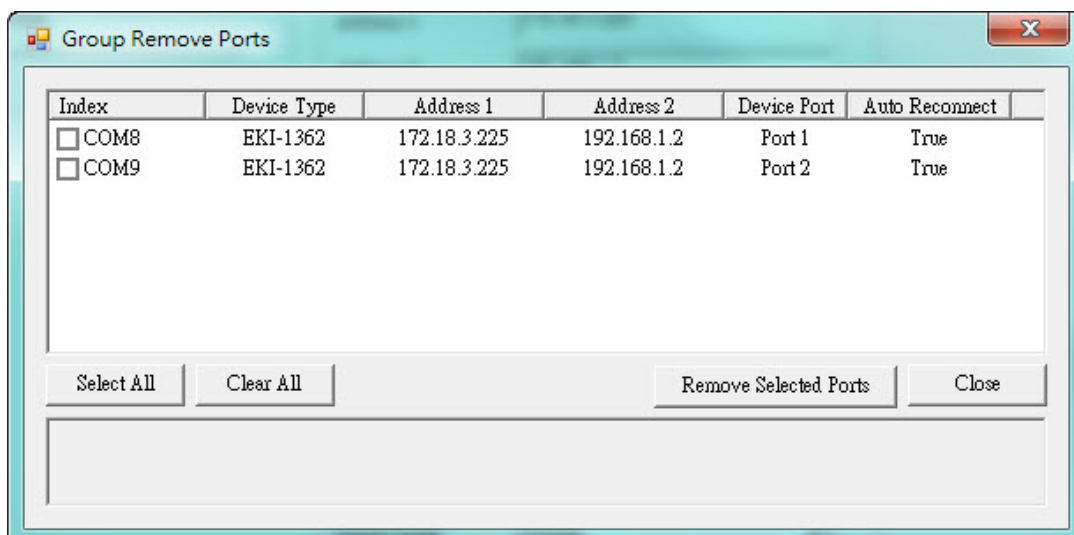

Chapter 5

Web-Based
Configuration

5.1 Overview

EKI series serial device server provides web interface configuration. You can configure EKI device with most popular standard browsers. can be configured through a web interface. By using a standard web browser, you can configure EKI device with the same procedure as with the Windows configuration utility can be used. In the browser's address field, enter the IP Address of your EKI-152X series serial device server. The default IP setting is 10.0.0.1, but you should use the IP which you have previously assigned for this device. Once the IP is entered, you will be presented with the following windows.

Note! Before using the web-based configuration, make sure your host PC Ethernet network IP domain is as same as the serial device server, or it can establish the TCP connection with the serial device server.



5.2 Accessing the Web Page

By configuration utility

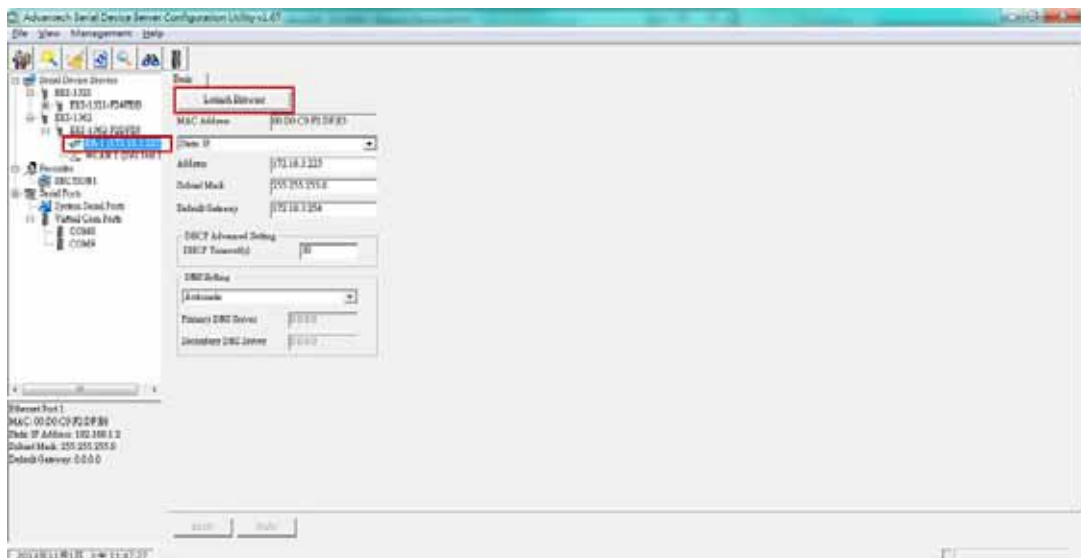

By Windows Internet Explorer



5.3 System

You can change the Device Name and Device Description on this page. You can also enable or disable the Web, Telnet, and SNMP functions. Moreover, you can set the Timezone related setting.

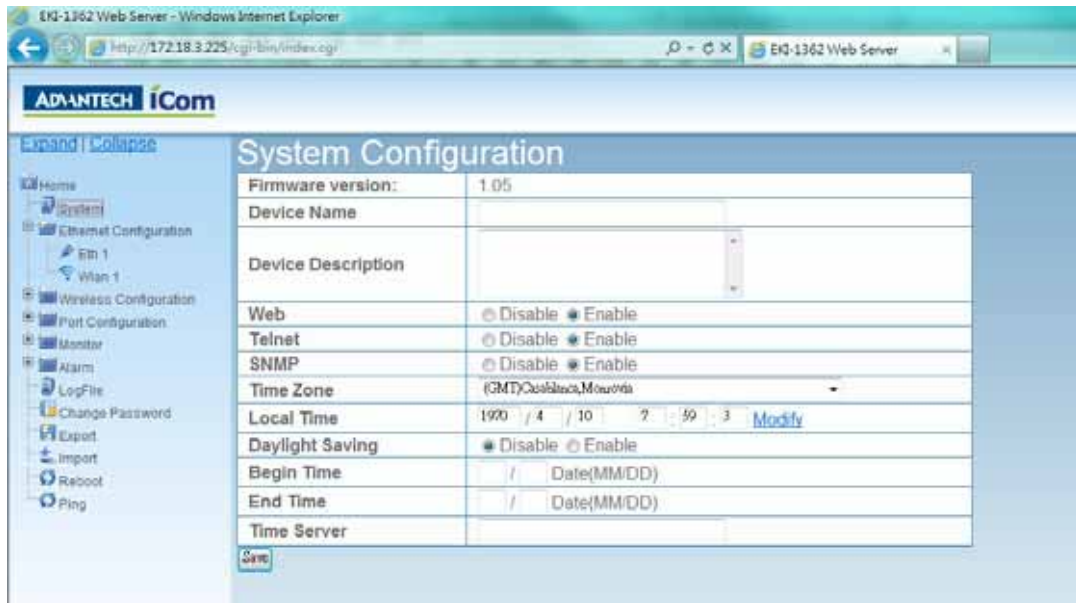

- **Device Name**
User can change the default device name to a meaningful name for easy identification.
- **Device Description**
User can place a note about the device in this field for tracking, remind, and etc.
- **Device Services**
User can disable the default services to avoid unauthorized access about the device settings.
- **Device Time**
User can set the device time for the SNMP trap, mail alarm and etc. That can help identify the time when the event happened. User can set the Time Server to use the NTP function to sync the device time with time server automatically. Or user can set the time manually. Device will keep the time setting even power off.

5.4 Network Configuration

Click the Net Configuration and chose either Net 1 or Net 2, there are Net Mode, IP Address, Subnet Mask, Default Gateway and DNS. Enter the corresponding values for your network environment. Remember press “Save” after fill in all values.



- **MAC address:**
The MAC address is for the local system to identify and locate each serial device servers. This MAC address is already set before delivery from factory, hence no need for further configuration.
- **IP address, Subnet Mask, Default Gateway:**
You can choose from four possible IP Configuration modes --- Static, DHCP, BOOTP, and DHCP/BOOTP.

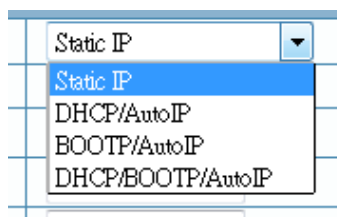
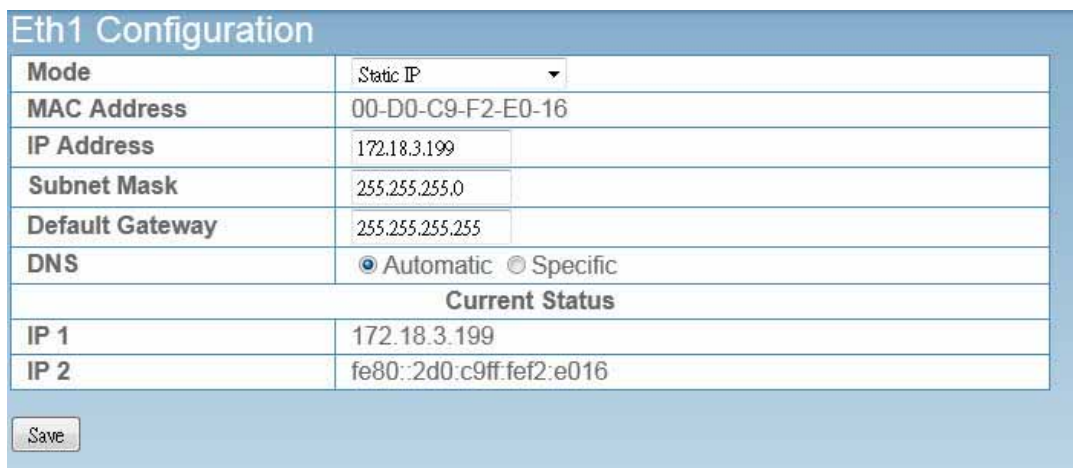

- **Static IP**
User defined IP address, Subnet Mask, and Default Gateway.
- **DHCP + Auto-IP**
DHCP Server assigned IP address, Subnet Mask, Default Gateway, and DNS.
- **BOOTP + Auto-IP**
BOOTP Server assigned IP address.
- **DHCP + BOOTP + Auto-IP**
DHCP Server assigned IP address, Subnet Mask, Default Gateway, and DNS, or BOOTP Server assigned IP address. (If the DHCP Server does not respond)
- **DHCP Timeout**
When EKI device doesn't get response from DHCP server within specific time-out, the EKI device will give up the request and take next action.\
- **DNS Setting**
In order to use DNS feature, you need to set the IP address of the DNS server to be able to access the host with the domain name. The EKI-152X series serial device server provides Primary DNS Server and Secondary DNS Server configuration items to set the IP address of the DNS server. Secondary DNS Server is included for use when Primary DNS server is unavailable.
- **DHCP Advanced Setting**
When you enabling DHCP protocol to get IP address, it will be waited DHCP server to give IP within DHCP timeout. The default value is 30 seconds.

Note! All new configurations will take effect after rebooting. The reboot function is located on the main menu of the Web Configuration.



5.5 Wireless Configuration

You may onfigure the detail wireless configuration in this page.

The screenshot shows the web-based configuration interface for an EKI-1362 Web Server. The browser address bar shows the URL `http://172.18.3.225/cgi-bin/index.cgi`. The page title is "EKI-1362 Web Server". The main content area is titled "Wireless Configuration" and includes a "Save" button at the bottom.

Wireless Configuration

Mode	<input checked="" type="radio"/> Client <input type="radio"/> Ad-hoc
SSID	advantech Site survey
Country code	United States
Channel	
Encryption	None

Advanced Wireless Setting

RTS threshold	2347
Fragment threshold	2346
Preamble	<input checked="" type="radio"/> Short <input type="radio"/> Long
Roaming	<input type="radio"/> Enable <input checked="" type="radio"/> Disable

The left sidebar contains a navigation menu with the following items: Home, System, Ethernet Configuration (Eth 1, Wan 1), Wireless Configuration (Wlan 1), Port Configuration, Monitor, Alarm, LogFile, Change Password, Export, Import, Reboot, and Ping.

- **Mode**

User can set EKI as Client mode to connect EKI device to a wireless access point or set EKI as Ad-hoc mode to connect with other wireless device directly without wireless access point.

SSID	BSSID	Channel	Signal Level	Encryption
<input type="radio"/> OPLK345678926	C8:3A:35:1F:AC:78	1	-71 dBm	WPA-personal
<input type="radio"/>	00:3A:9A:21:57:15	1	-33 dBm	WPA-personal
<input type="radio"/>	00:3A:9A:21:57:16	1	-32 dBm	WPA-personal
<input type="radio"/> wireless_2	12:D0:C9:F2:77:5F	1	-40 dBm	none
<input type="radio"/> Advantecher	00:3A:9A:21:57:19	1	-35 dBm	WPA-enterprise
<input type="radio"/>	00:3A:9A:21:57:14	1	-32 dBm	WPA-personal
<input type="radio"/> wireless_2	12:D0:C9:F2:77:59	1	-37 dBm	none
<input type="radio"/> wireless_2	00:D0:C9:F2:77:65	1	-51 dBm	none
<input type="radio"/> OPLINK2970934921	C8:3A:35:1F:BF:B8	1	-72 dBm	WPA-personal
<input type="radio"/> Advantech-Guest	00:3A:9A:21:57:13	1	-33 dBm	none
<input type="radio"/> WiFi Phone	00:3A:9A:21:57:12	1	-34 dBm	none
<input type="radio"/> Employee-NF	00:3A:9A:21:57:10	1	-33 dBm	WEP
<input type="radio"/> Signage	00:3A:9A:21:57:17	1	-32 dBm	none
<input type="radio"/> Cell Phone	00:3A:9A:21:57:18	1	-33 dBm	none
<input type="radio"/> oplinkjy	C8:3A:35:33:22:68	1	-81 dBm	WPA-personal
<input type="radio"/> OPLINK9394110245	C8:3A:35:31:C8:B8	1	-80 dBm	WPA-personal

- **Site survey**

User can use this function to discovery the wirelees access point near EKI device. Sometimes, due to the wireless access point setting and environment issue, the specific wireless access point may not be listed in the result. User can try to refresh the list several times.

- **SSID**

When using Client mode, user can specify the SSID that EKI device should connect to; When using Ad-hoc mode, user can specify the SSID and channel that forms a ad-hoc network.



- **Country code**

Differet country code specify different selectable channels. User should choose the correct corresponding country code to avoid breaking the local law.

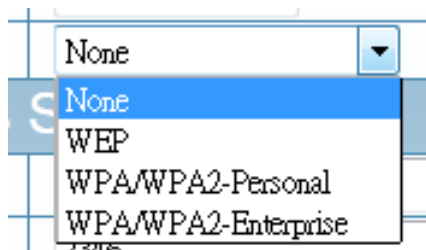

- Encryption**
 User can choose using wireless communication without encryption, or choose with "WEP", "WPA/WPA2-Personal", or "WPA/WPA2-Enterprise" that can use standard encryption method to protect the data.

Encryption	WEP
WEP authentication algorithm	<input checked="" type="radio"/> Open <input type="radio"/> Shared
WEP key index	1
WEP key format	<input checked="" type="radio"/> Ascii <input type="radio"/> Hex
WEP key	00000000

- WEP**
 Wired Equivalent Privacy (WEP) is a security algorithm for IEEE 802.11 wireless networks. When using WEP encryption, user should also choose the authentication algorithm, key index, key format and fill in the key content respectively.

Wireless Configuration	
Mode	<input checked="" type="radio"/> Client <input type="radio"/> Ad-hoc
SSID	Cell Phone Site survey
Country code	China
Channel	11 - 2.462 GHz
Encryption	WPA/WPA2-Enterprise
EAP method	EAP-TLS
Management frame protection	Disable
Identity	
Password	
Advanced Wireless Setting	
RTS threshold	2347
Fragment threshold	2346
Preamble	<input checked="" type="radio"/> Short <input type="radio"/> Long
Roaming	<input checked="" type="radio"/> Enable <input type="radio"/> Disable
RSSI threshold	70
Beacon interval	100
CA/Certificates center	
CA certification	<input type="button" value="瀏覽..."/> 未選擇檔案。 <input type="button" value="Upload"/>
Client certification	<input type="button" value="瀏覽..."/> 未選擇檔案。 <input type="button" value="Upload"/>
Private Key	<input type="button" value="瀏覽..."/> 未選擇檔案。 <input type="button" value="Upload"/>
Private key password	
<input type="button" value="Save"/>	

- WPA/WPA2-Personal, WPA/WPA2-Enterprise
The main difference between WPA/WPA2-Personal and WPA/WPA2-Enterprise is the authentication method. WPA/WPA2-Enterprise uses additional certification to identify the specific device. User should provide the extra certification and private key files.

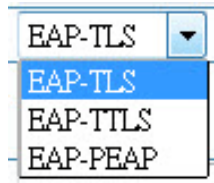

If using WPA/WPA2 encryption, user should also choose which EAP method is using with: TLS, TTLS, or PEAP. User should also provide the relative parameters: Management frame protection, Identity, Password, Inner Authentication.

5.6 Port Configuration

There are Basic, Operation Mode, and Advanced Setting in the serial port configuration. For more detailed information for setting, please refer to chapter 3.4 and chapter 3.5.



5.6.1 Basic Port Configuration

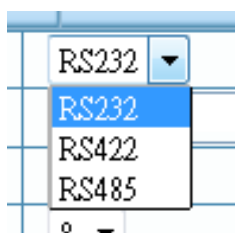

- Type**
 The EKI-152X series serial device server offers three kinds of serial interfaces, RS-232, RS-485 and RS-422. User can use any of the three serial interfaces according to user's requirements.

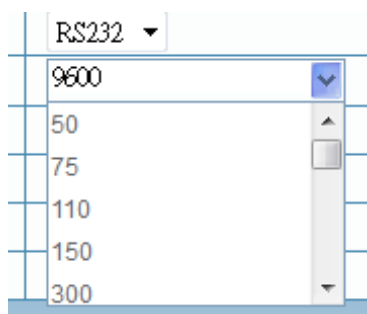

- Baud Rate**
 User can choose the regular baud rate from the drop down list or key in any particular baud rate manually.
- Parity**
 The EKI serial device server provides five options for parity: None, Odd, Even, Space, and Mark.
- Data Bits**
 The EKI serial device server provides four options for data bits: 5, 6, 7, and 8.
- Stop Bits**
 The EKI serial device server provides three options for stop bits: 1, 1.5, and 2.
- Flow Control**
 The EKI serial device server provides four options for flow control: None, XON/XOFF, RTS/CTS, and DTR/DSR.

5.6.2 Operation Mode

5.6.2.1 Virtual COM Mode

The EKI serial device server extends traditional COM ports of a PC to Ethernet access. Through Ethernet networking, users can control and monitor remote serial devices and equipment over LAN or WAN. The EKI device server comes with a COM port redirector (Virtual COM driver) that transmits all serial signals intact. This means that your existing COM-based software can be preserved, without modifying to fulfill the needs. The Virtual COM mode allows user to continue using RS-232/422/485 serial communications software that was written for pure serial communication applications.

The EKI series comes with COM port redirector (virtual COM driver) that work with Window 2000/XP/Vista(X86) systems. The driver establishes a transparent con-

nection between host and serial device by mapping the IP of the EKI-152X series serial device server serial port to a local COM port on the host computer.

The EKI series provides Multi-access function through Ethernet connection path. Allow the maximum of 5 connections to open one serial port simultaneously. In this mode, all connection has to use the same serial setting. If one serial setting of these connections is different from others, the data communication may operate incorrectly.

Port 1 configuration		
Basic	Operation	Advanced
Mode		Virtual COM Mode ▾
Host Idle Timeout(s)		60
Response Timeout(ms)		0
Frame Break(ms)		0
Pack conditions (Pack sent immediately when reach 1024 Bytes)		
<input type="checkbox"/> By size		Bytes(1 ~ 1024 Bytes)
<input type="checkbox"/> By interval		ms(1 ~ 60000 ms)
<input type="checkbox"/> By end-character	Char Format	ASCII ▾
	Char Value	
RVCOM Extra Options		
RVcom Number		5 ▾
1	IP address 1	
2	IP address 2	
3	IP address 3	
4	IP address 4	
5	IP address 5	
Port Data Buffering		
Media		NONE ▾
When Data Full		Stop ▾
Maximum Buffer Size		0 (Max: 1024, Unit: MiB)
Save		

- **Host Idle Timeout**
The “Host Idle Timeout” setting monitors the connection between the host and the device. If the “Host Idle Timeout” setting time is reached, the device server will release the resources allocated to the port mapping. This prevents a stalled host from affecting the connective device.
The EKI device provides Multi-access function through Ethernet connection path. Allow the maximum of 5 connections to open one serial port simultaneously. In the mode, all connection has to use the same serial setting. If one serial setting of these connections is different from others, the data communication may operate incorrectly.
There are two operating mode of Multi-access function. One is Normal mode; another is Round-Robin mode.
- **Normal mode**
Disabling “Response Timeout” parameter, the EKI device will operate in “normal mode”. When multiple hosts open the serial port simultaneously, the EKI device only offers control ability for the first connected host and provides data communication function for others. Each serial port supports up to five simultaneous connections, so multiple hosts can transmit/receive data to/from the same serial port simultaneously. Every host can transmit data to the same serial port, and the EKI device will also transmit data to every hosts. When the multiple hosts transmit data to the same serial port at the same time, the received data from

Ethernet and the outputs of serial port are mixed. When the EKI device receives data from serial port, the data will also be transmitted to the connected hosts simultaneously.

- **Round-Robin mode:**

Enabling “Response Timeout” parameter, the EKI device will operate in “Round-Robin mode”. Each serial port supports up to five simultaneous connections, so multiple hosts can transmit/receive data to/from the same serial port simultaneously. Every host can transmit data to the same serial port simultaneously, but the EKI device will process the data communication in order. The EKI device will process the first host’s request and reply the response to the first host. The EKI device serial device server can determine the end of the serial acknowledgment via response timeout. When EKI device serial device server receives nothing from serial port after the setting of response timeout, the device will reply the acknowledgement to the host and then process the next host’s request. While the connected hosts are more and “Response Timeout” is long, the process time is much longer.

Frame Break is a very import parameter for Round Robin mode. This parameter is the smart way to reduce inefficient waiting time and the EKI device can transmit data more efficiently. Disabling the Frame Break function, the EKI device will wait “Response Timeout” period, whether the device have transmitted the data. During this period, the commands from hosts will be queued and the EKI device just processes this command. Enabling “Frame Break”, if the serial port idle is longer than the “Frame Break” period, the EKI device will assume the communication is completed and continue the next host’s query. This is an efficient way to reduce the waiting time and improve the performance.

5.6.2.2 Data Mode (USDG Mode)

The EKI device can be Data server or Data client either. Both operations support TCP and UDP protocol. The EKI device makes your serial devices behave just like networking devices. You can issue commands or transmit data from serial devices, which connected to the EKI device, to any devices that are connected to the Internet.

The EKI device allows most 5 host PCs accessing data simultaneously via polling networking architecture. You can use it according to your application. If you want to access the EKI device, you must ascertain your application software supports standard networking application programming interface (API) such as: WinSock Socket.

You might select “USDG Mode” as the following figure to change the mode of the port to TCP server/client or UDP mode.

Port 1 configuration		
Basic	Operation	Advanced
Mode	USDG Data Mode ▾	
Protocol	TCP ▾	
Data Idle Timeout(s)	60	
Data Listen Port	4000	
Command Listen Port	5400	
Response Timeout(ms)	0	
Frame Break(ms)	0	
TCP Mode Extra Options		
Auto Connect To Peer IP	<input type="checkbox"/>	
Port Data Buffering		
Media	NONE ▾	
When Data Full	Stop ▾	
Maximum Buffer Size	0 (Max: 1024, Unit: MiB)	
Pack conditions (Packet sent immediately when reach 1024 Bytes)		
<input type="checkbox"/> By size	Bytes(1 ~ 1024 Bytes)	
<input type="checkbox"/> By interval	ms(1 ~ 60000 ms)	
<input type="checkbox"/> By end-character	Char Format ASCII ▾ Char Value <input type="text"/>	
<input type="checkbox"/> By character-timeout		
	Peer for Receiving Data	
Peer Number	0 ▾	
<input type="button" value="Save"/>		

- **Protocol**
The EKI device provides TCP/IP and UDP two protocols. In settings, you can choose either TCP mode or UDP mode according to your application.
- **Data Listen Port**
The TCP/UDP port number represents the source port number, and the number is used to identify the channel for remote initiating connections. Range: 1024-65533. If an unknown caller wants to connect to the system and asks for some services, they need to define the TCP/UDP port to carry a long-term conversation. Each node on a TCP/IP network has an IP address, and each IP address can allow connections on one or more TCP port. The well known TCP ports are those that have been defined; for example, port 23 is used for Telnet connections. There are also custom sockets that users and developers define for their specific needs. The default TCP/UDP port of the EKI device is 5300. The example initial 5300 is System Port, and 5301 is Data Port. But users can adjust them by one's preference or application.
Each port has its own data listen port to accept connected request of other network device. So, the data listen port can't be set the same value. You can transmit/receive data to/from device via the data listen port.
- **Command Listen Port**
Each port has its own command listen port to accept connected request of other network device. So, the command listen port can't be set the same value. You can use 'AT command' to change the port setting via the command listen port. The Command Listen Port should be different from the Data Listen port.
- **Data Idle Timeout**
The default is 60 seconds. If you want to keep connection continually, you can disable the Data Idle Timeout. Data idle Time is the time period in which the device waits for data. If the EKI device does not receive data over an established idle time, the EKI device will disconnect temporarily. When the data

comes to the EKI device, it will reconnect automatically. Users do not need to reconnect.

- **Enable Time Sharing**
The EKI device provides Multi-access function through Ethernet connection path. Allow the maximum of 5 connections to open one serial port simultaneously. In the mode, all connection has to use the same serial setting. If one serial setting of these connections is different from others, the data communication may operate incorrectly.
There are two operating mode of Multi-access function. One is Normal mode; another is Round-Robin mode.
- **Normal Mode**
Disabling “Response Timeout” parameter, the EKI device will operate in “normal mode”. When multiple hosts open the serial port simultaneously, the EKI device only offers control ability for the first connected host and provides data communication function for others. Each serial port supports up to five simultaneous connections, so multiple hosts can transmit/receive data to/from the same serial port simultaneously. Every host can transmit data to the same serial port, and the EKI device will also transmit data to every hosts. When the multiple hosts transmit data to the same serial port at the same time, the received data from Ethernet and the outputs of serial port are mixed. When the EKI device receives data from serial port, the data will also be transmitted to the connected hosts simultaneously.
- **Round-Robin Mode**
Enabling “Response Timeout” parameter, the EKI device will operate in “Round-Robin mode”. Each serial port supports up to five simultaneous connections, so multiple hosts can transmit/receive data to/from the same serial port simultaneously. Every host can transmit data to the same serial port simultaneously, but the EKI device will process the data communication in order. The EKI device will process the first host’s request and reply the response to the first host. The EKI device serial device server can determine the end of the serial acknowledgement via response timeout. When EKI device serial device server receives nothing from serial port after the setting of response timeout, the device will reply the acknowledgement to the host and then process the next host’s request. While the connected hosts are more and “Response Timeout” is long, the process time is much longer.
Frame Break is a very import parameter for Round Robin mode. This parameter is the smart way to reduce inefficient waiting time and the EKI device can transmit data more efficiently. Disabling the Frame Break function, the EKI device will wait “Response Timeout” period, whether the device have transmitted the data. During this period, the commands from hosts will be queued and the EKI device just processes this command. Enabling “Frame Break”, if the serial port idle is longer than the “Frame Break” period, the EKI device will assume the communication is completed and continue the next host’s query. This is an efficient way to reduce the waiting time and improve the performance.
- **Auto Connect Peer IP**
If enabling this option, EKI device will connect to TCP/IP which are set at Peers page automatically after boot up.
- **Peer Number**
Set the number of network device which you want to connect. You can set maximum sixteen network devices which you want to connect. You need to fill out the IP Address and Port (including local port and peer port) of network devices which you want to connect.

Pack conditions (Packet sent immediately when reach 1024 Bytes)	
<input type="checkbox"/> By size	<input type="text"/> Bytes(1 ~ 1024 Bytes)
<input type="checkbox"/> By interval	<input type="text"/> ms(1 ~ 60000 ms)
<input type="checkbox"/> By end-character	Char Format <input type="text" value="ASCII"/> Char Value <input type="text"/>
<input type="checkbox"/> By character-timeout	

- Data Pack
Data pack means you can set condition of receiving data from serial port to be a package according to your application. There are four options to set the data packing: by data size (Byte), by time interval (ms), by character timeout (4 Bytes), or by end of character.

5.6.2.3 USDG Control Mode

In controlling mode, the EKI device presents a modem interface to the attached serial device: it accepts AT-style modem commands to connect/disconnect to other networking device. If you want serial device running application program to connect/disconnect to different devices dynamically, you can use controlling mode.

The “Control mode” provides three kinds of modem AT-style commands. The serial devices can use these commands to control the EKI device to connect/disconnect to remote networking device. Thus, intelligent serial devices such as standalone PLC will send/receive data to/from devices one by one via Ethernet.

Port 1 configuration		
Basic	Operation	Advanced
Mode	USDG Control Mode ▾	
Protocol	TCP	
Data Idle Timeout(s)	<input type="text" value="60"/>	
Data Listen Port	<input type="text" value="4000"/>	
Command Listen Port	<input type="text" value="5400"/>	
Hangup Character	<input type="text" value="+"/>	
Guard Time(ms)	<input type="text" value="1000"/>	
<input type="button" value="Save"/>		

Please refer to the USDG Data Mode to setup the Data Listen Port, Command Listen Port, and Data Idle Timeout.

- Hangup Character
The default character is “+”. After you have connected to another serial device via EKI device, you may need to disconnect. Then you can use the command “+++” to disconnect. To do this leaves your keyboard idle (don't press any keys) for at least several seconds, then press “+” three times. You can set “Guard Time” to define the idle time. Be sure that you have to press “+” over the idle time.
- Guard Time
The default value is 1000 ms.
Example: <Guard Time>+++<Guard Time>

Control Mode is designed for use with legacy operating systems, such as MS-DOS, that do not support TCP/IP Ethernet. By connecting one of EKI's serial ports to the MS-DOS computer's serial port, it is possible to use legacy software originally designed to transmit data via modem, but now transmit the data over the Ethernet.

- **Dial-in (Use TCP connect to serial port of EKI)**
EKI listens for a TCP/IP connection request from the remote host. when a TCP connection is coming, there will have prompt string "RING" shows on serial port site. After the system prompting the "RING" string, user can use "ATA" command to accept the connection or just ignore it. After accepted the connection, EKI will enter data mode.
- **Dial-out (From serial port connect to specific TCP host target)**
User can use the AT Comand "ATD <IP>#<TCP port>" to connect to a specific TCP target host from serial port. when the TCP connection is accepted by the remote host, EKI will show "CONNECT" string to serial port and enter data mode.
- **Disconnect from serial port**
When EKI is in data mode, user can type the hangup character triple times, such as "+++". EKI will shut down the TCP connection and back to command mode, and shows "NO CARRIER" to indicate the connection has been shut down.
- **Disconnect from remote TCP connection**
- **When EKI shows "NO CARRIER" on serial port, it means the TCP connection has been shut down. EKI will back to command mode automatically.**

Note!  The "+++" command cannot be divided. The "+" character can be changed in Hang-up Character, and the guard time, which prefixes and suffixes the "+++" in order to protect the raw data, can be changed in Guard Time (ms). See picture.

AT Commands

EKI supports the following common AT commands used with a typical modem:

AT command	Description
ATA	Answer
ATD	Dial up the IP address#Port No.
ATE	ATE0=Echo OFF ATE1=Echo ON (default)
ATH	On-hook
ATZ	Reset and Recall user's settings
AT&F	Restore factory's Default settings

Example 1 (Local connect to remote)

```
AT↵  
OK↵  
↵  
ATD192.168.1.100#5300↵  
↵  
CONNECT↵  
↵  
/// Data ...↵  
NO CARRIER /// Remote disconnects or send "+++"↵
```

Example 2 (Remote connect to local)

```
AT  
OK  
  
RING  
  
RING  
  
RING  
ATA /// Answer  
  
CONNECT  
  
/// Data ...  
  
NO CARRIER /// Remote disconnect or Send "+++"
```

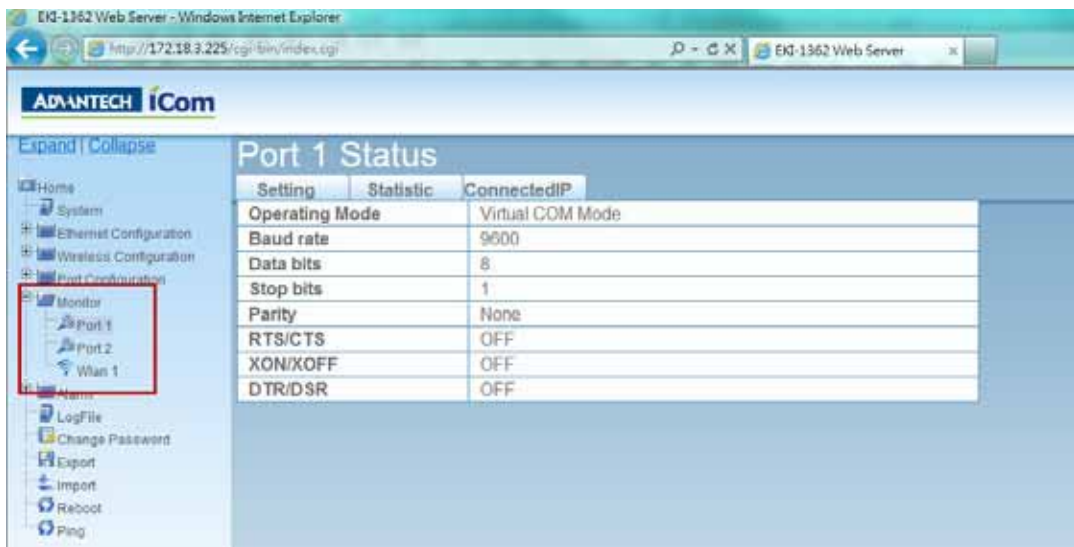

5.7 Monitor

You can monitor the serial ports settings, statistic, and the connected IP address by click on Monitor function on the main menu.

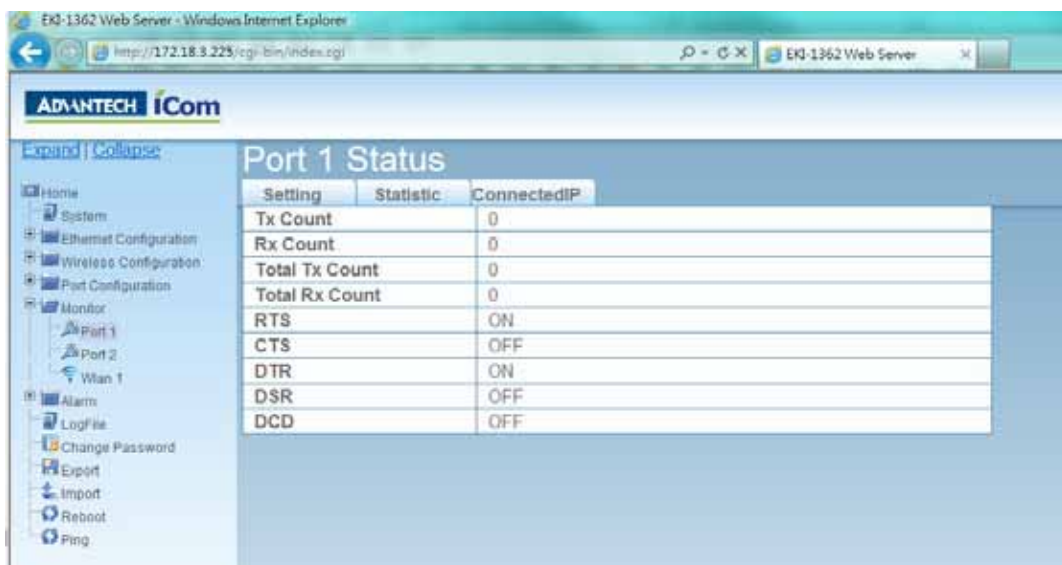

The screenshot shows the 'Port 1 Status' page. The left navigation menu has 'Monitor' selected. The main content area displays a table with the following data:

Setting	Statistic	ConnectedIP
Operating Mode		Virtual COM Mode
Baud rate		9600
Data bits		8
Stop bits		1
Parity		None
RTS/CTS		OFF
XON/XOFF		OFF
DTR/DSR		OFF



The screenshot shows the 'Port 1 Status' page. The left navigation menu has 'Monitor' selected. The main content area displays a table with the following data:

Setting	Statistic	ConnectedIP
Tx Count		0
Rx Count		0
Total Tx Count		0
Total Rx Count		0
RTS		ON
CTS		OFF
DTR		ON
DSR		OFF
DCD		OFF

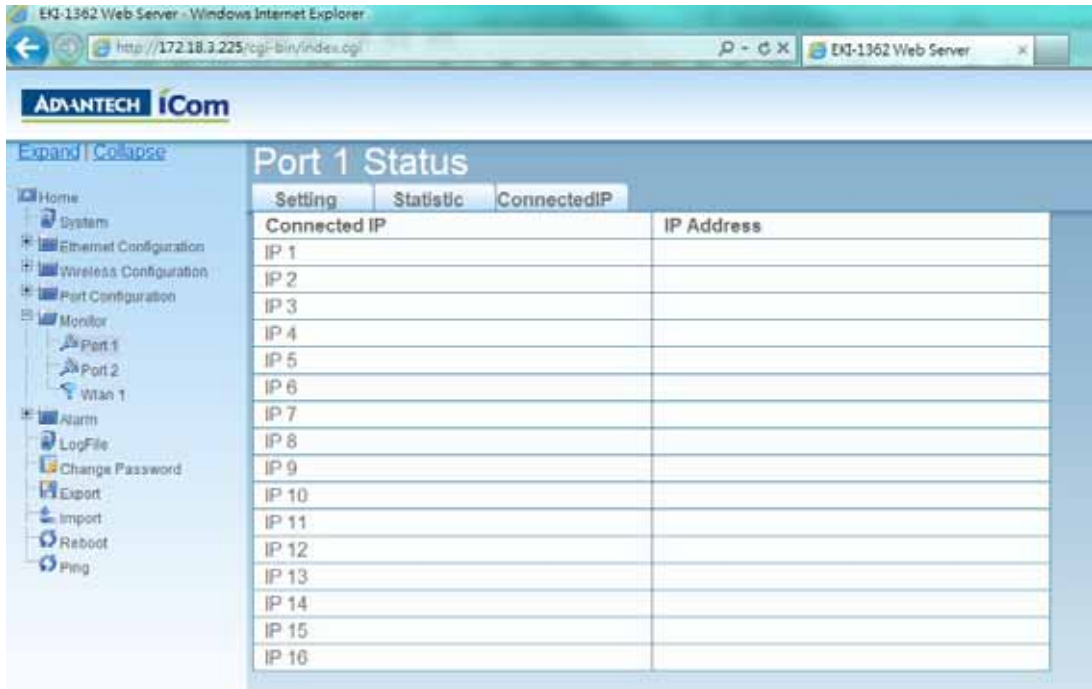

5.8 Auto Warning (Alarm)

You can set the e-mail server and SNMP Trap server in the Setting page, and set the event type in the Event page.

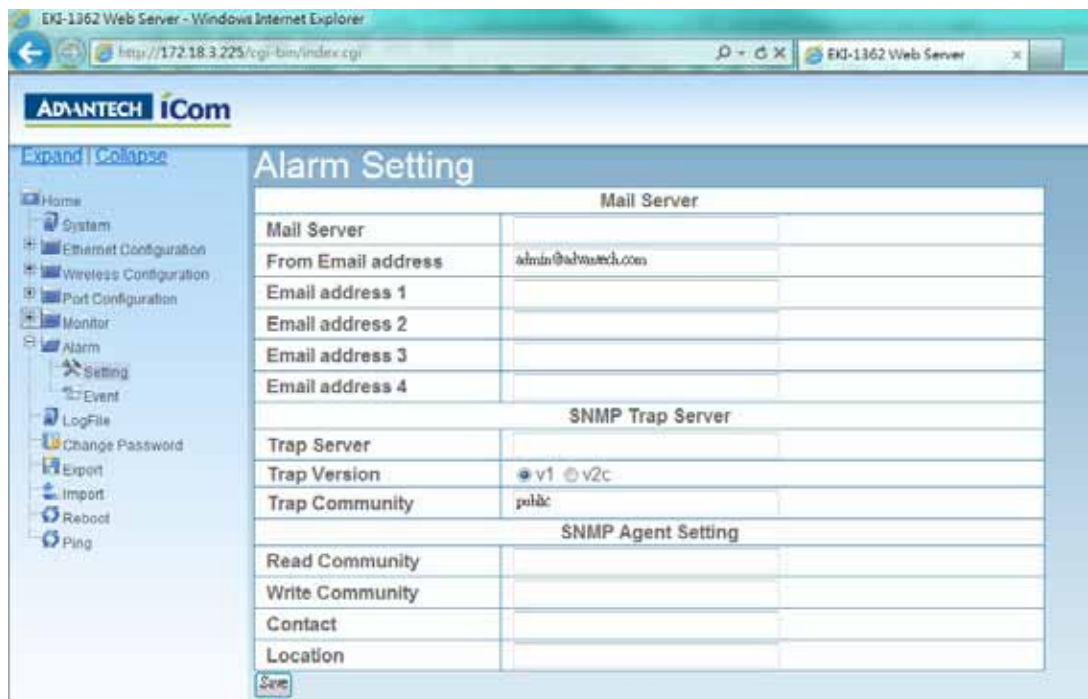

5.8.1 Email Alert

Consult your ISP or Network Administrator for the proper SMTP mail server settings. The auto warning functions may not work properly without proper settings.

5.8.2 SNMP Trap

You need to set the proper IP address of SNMP Trap Server. And choose the Trap Version; there are “SNMP v1” and “SNMP v2c” options.

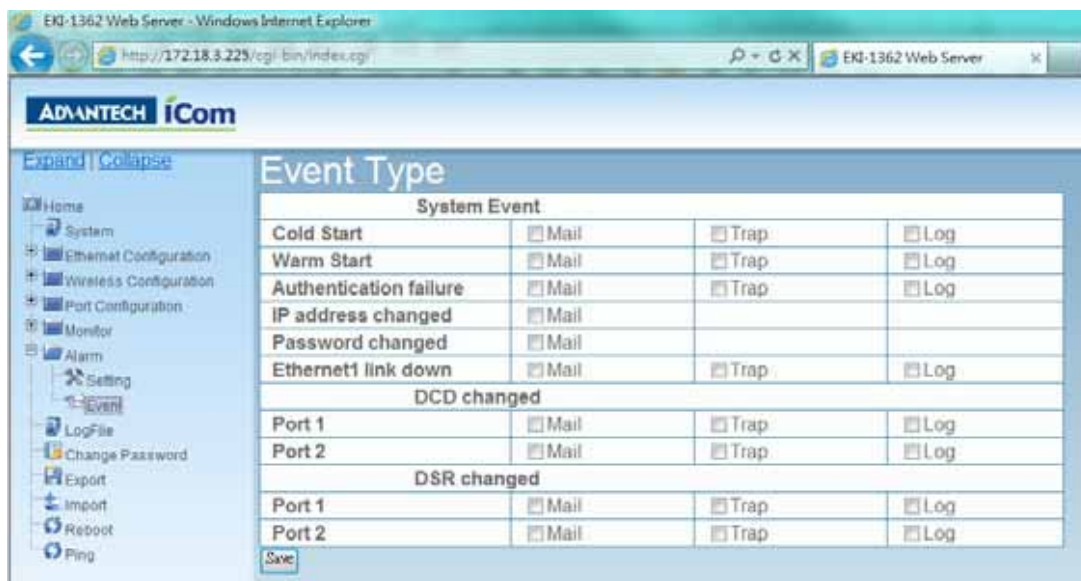

5.8.3 System Event

- **Cold Start**
This refers to starting the system from power off. When performing a cold start, the EKI device will send an e-mail, or send a SNMP trap after success rebooting.
- **Warm Start**
This refers to restarting the system without turning the power off. When performing a warm start, the EKI device will send an e-mail, or send a SNMP trap after restarting the system.
- **Authentication failure**
The user types a wrong password from Console or Administrator. When authentication failure occurs, the EKI device will send an e-mail, or send a SNMP trap.
- **IP Change**
The user changes the EKI device's IP address. When the IP address changes, the EKI device will send an e-mail, or send a SNMP trap after restarting the system.
- **Password Change**
The user changes the EKI device's password. When the password changes, the EKI device will send an e-mail, or send a SNMP trap after restarting the system.
- **Ethernet 1 Down**
The Ethernet 1 port has link failure condition. When the Ethernet 1 links fail, the EKI device will send an e-mail, or send a SNMP trap immediately.
- **Ethernet 2 Down**
The Ethernet 2 port has link failure condition. When the Ethernet 2 links fail, the EKI device will send an e-mail, or send a SNMP trap immediately.

5.8.4 Serial Port Event

- DCD Change
The DCD (Data Carrier Detect) signal has changed, also indicating that the modem connection status has changed. For example, a DCD change to high also means “Connected” between local modem and remote modem. If the DCD signal changes to low, it also means that the connection line is down. When the DCD signal changes, the EKI device will send an e-mail, or send a SNMP trap.
- DSR Change
The DSR (Data Set Ready) signal has changed, also indicating that the data communication equipment’s power is off. For example, a DSR change to high also means that the DCE is powered ON. If the DSR signal changes to low, it also means that the DCE is powered off. When the DSR signal changes, the EKI device will send an e-mail, or send a SNMP trap.

Note! All new configurations will take effect after rebooting. The reboot function is located on the main menu of the Web Configuration.



5.9 Change Password

You can change the serial device server password on here:



If you have set a password via the configuration utility or Telnet or serial console, when you access the web configuration, you need to key in the password. Do not need to enter the user name in the dialog.

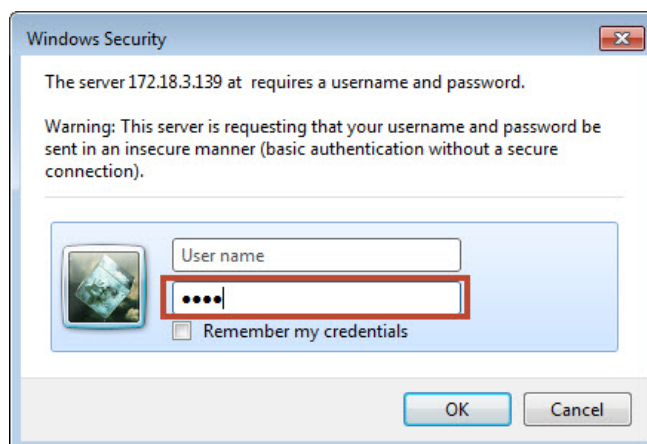

If you want to disable the password protection, just change the password to the default “None” (leave the new password column blank), Be sure to press the “Save” button and reboot the serial device server to make the change effective.



5.10 Import/Export Device Settings

You can Import or Export the serial device server all setting as the “.conf” file format.

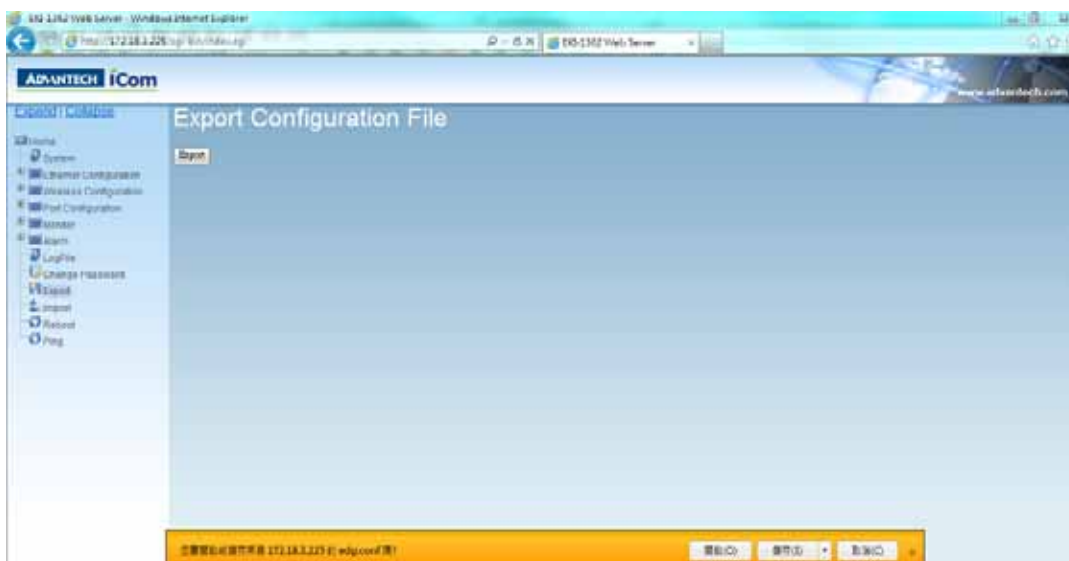

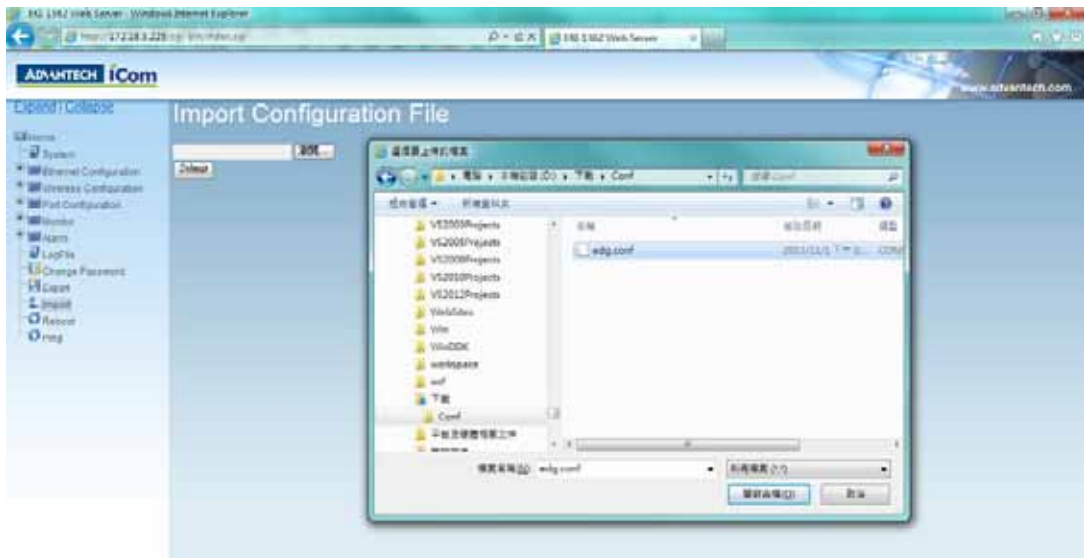

5.11 Reboot

The configuration will take effect after clicking “Save” button. But all configurations will save to flash memory after this reboot step. Press the “Reboot” button and the system will give a reset response. It will take a few seconds to reconnect with the new values.

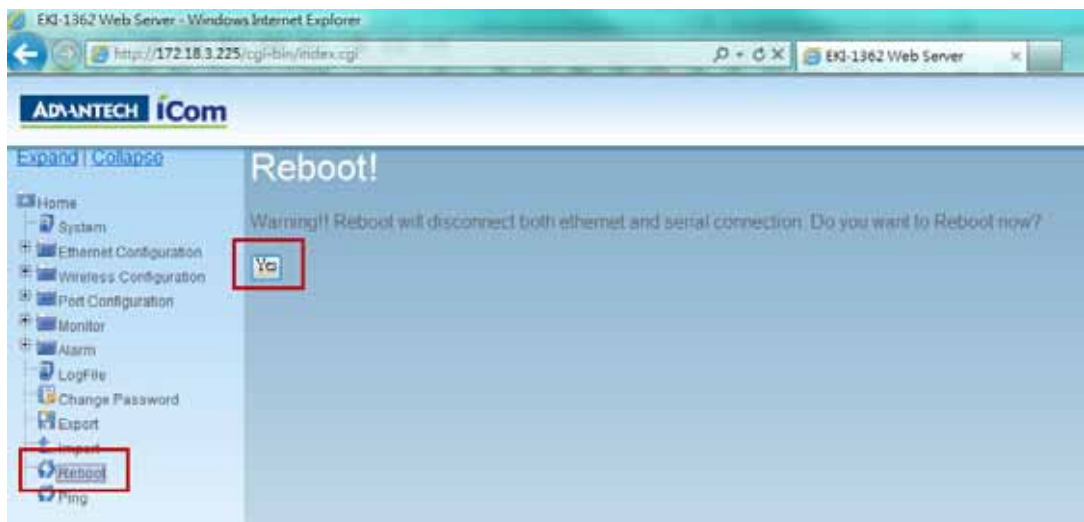

Chapter 6

Telnet Configuration

6.1 Overview

The purpose of the Console Configuration is to help you manage your device in console mode. One of the main functions of the console mode is to change the web configuration login password. You can use terminal software like Hyper Terminal, Telix and other related terminal software.

6.2 Telnet Console

Create a new connection

You can create a new Telnet connection and assign a connection name for the console configuration.

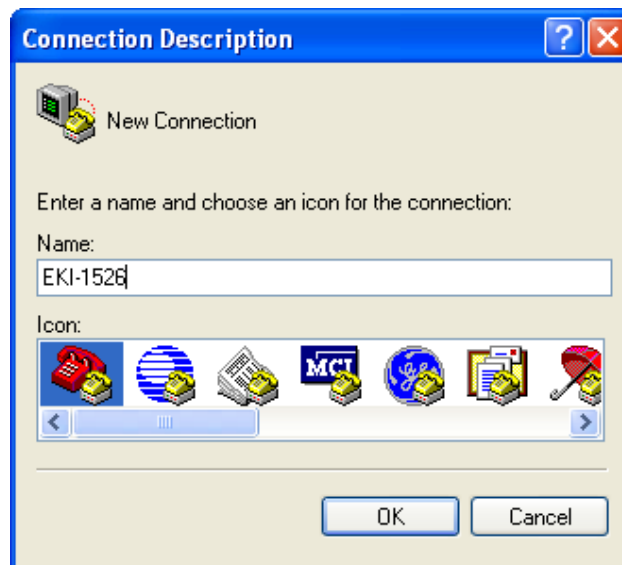

Input the IP address

Confirm that the Telnet console configuration works ok. Be sure that your host PC Ethernet network IP domain is as same as the EKI-152X series serial device server, and the Telnet TCP port number is "23".

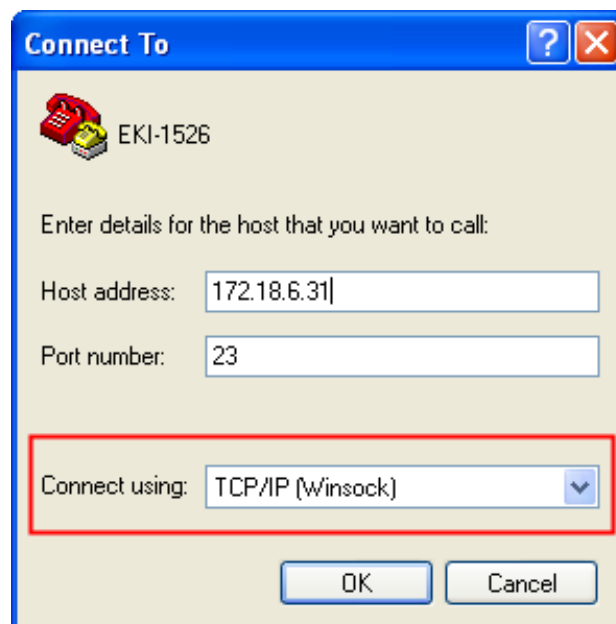

Connecting Success

After connection the serial device server in Telnet console mode, you can see the welcome message in the Hyper Terminal Windows.

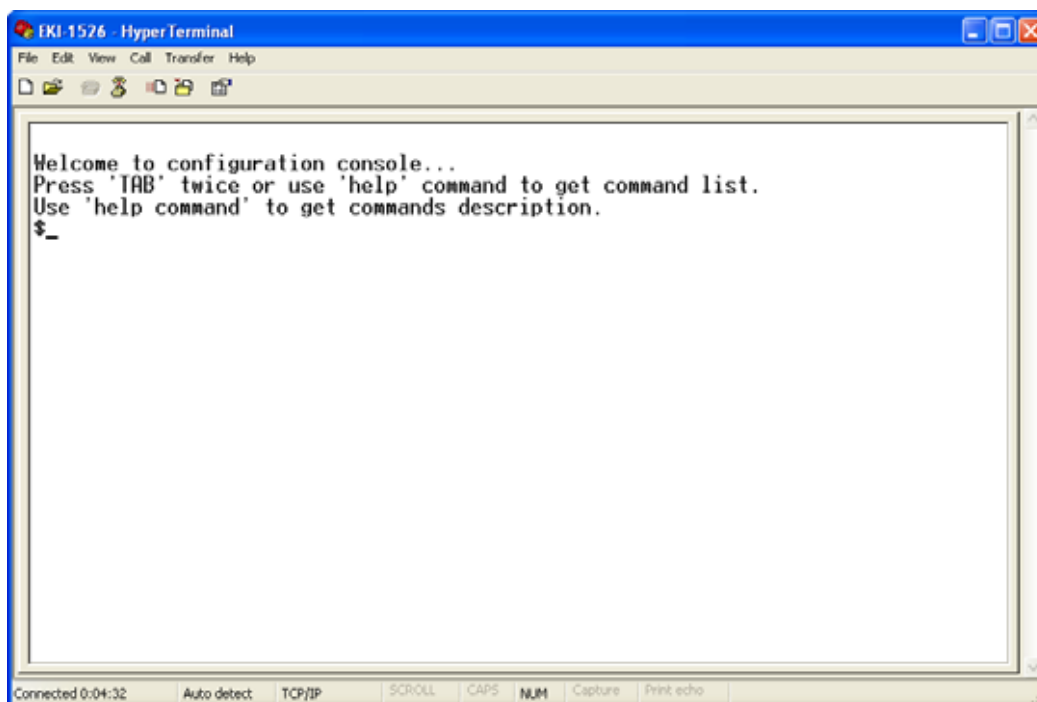

6.3 Command List

Table 6.1: Console Command List

Command	Function Description
system	Show or configure the system information
port	Show or configure the serial ports information
portadv	Show or configure the serial ports advanced settings
mvcom	Show or configure the serial ports in Virtual COM mode
mctrl	Show or configure the serial ports in Control mode (USDG)
mdata	Show or configure the serial ports in Data mode (USDG)
net	Show or configure the Ethernet ports settings
password	Set or change the password
apply	Write settings to the flash memory and reboot the system immediately
exit	Terminate the shell session
help	Display help information of command list
<Tab> <Tab>	Display help information of command list
import	Import the serial device server all settings
export	Export the serial device server all settings
monitor	Monitor the serial ports status
alarm	Show or configure the auto warning functions including mail alarm and SNMP alarm
time	Show or configure the time information
service	Enable or disable the web, Telnet and SNMP functions
wireless	Show or configure the wireless settings or informations

Help

You might type the “help” command or press <Tab> twice to show the supported command list.

[Usage] help

[Function] Display help information of command list



The screenshot shows a HyperTerminal window titled "EKI-1526_Serial Console - HyperTerminal". The terminal displays the output of the "\$help" command, which lists supported commands in a grid format. The "\$help" command is highlighted with a red box. The status bar at the bottom shows "Connected 0:00:58", "Auto detect", "38400 8-N-1", "SCROLL", "CAPS", "NUM", "Capture", and "Print echo".

```
$help
Supported commands:
system          port          portadv       mvcom
mctrl           mdata        net           password
apply          exit         help         import
export         monitor      alarm        time
service
$-
```

You might use “help” command to show the usage of all commands.

[Usage] help [command]

[Function] Show the usage of command

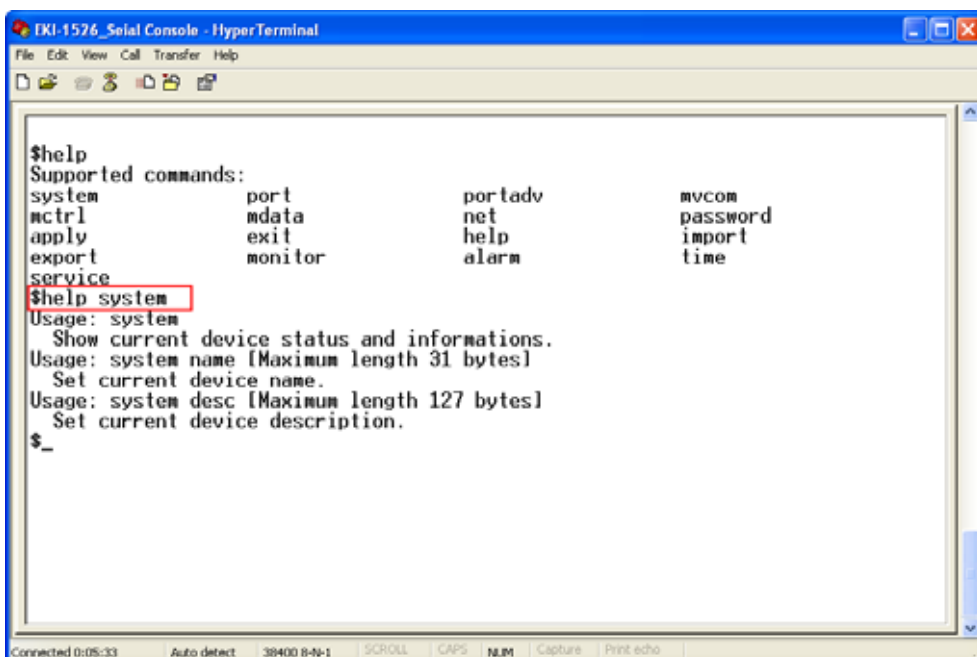

The screenshot shows a HyperTerminal window titled "EKI-1526_Serial Console - HyperTerminal". The terminal displays the output of the "\$help system" command. The "\$help system" command is highlighted with a red box. The status bar at the bottom shows "Connected 0:05:33", "Auto detect", "38400 8-N-1", "SCROLL", "CAPS", "NUM", "Capture", and "Print echo".

```
$help
Supported commands:
system          port          portadv       mvcom
mctrl           mdata        net           password
apply          exit         help         import
export         monitor      alarm        time
service
$help system
Usage: system
  Show current device status and informations.
Usage: system name [Maximum length 31 bytes]
  Set current device name.
Usage: system desc [Maximum length 127 bytes]
  Set current device description.
$-
```

System

[Usage] system

[Function] Show firmware version, device name and description

```

EKI-1526 Serial Console - HyperTerminal
File Edit View Call Transfer Help
$system
Firmware Version :1.40
Device Name :'EKI-00D0C9A6A25A'
Device Description :''
$help system
Usage: system
  Show current device status and informations.
Usage: system name [Maximum length 31 bytes]
  Set current device name.
Usage: system desc [Maximum length 127 bytes]
  Set current device description.
$

```

[Usage] system

[Function] Show current device status and information

[Usage] system name XXXX

[Function] Set current device name [XXXX: maximum length 31 bytes]

[Usage] system desc XXXX

[Function] Set current device description [XXXX: maximum length 127 bytes]

Port

“Port” is the command to show all serial ports information and configure the serial ports settings.

```

EKI-1526_Seial Console - HyperTerminal
File Edit View Call Transfer Help
$help port
Usage: port [nn|all]
Show port status and informations.
Usage: port [nn] desc [Maximum length 127 bytes]
Set serial port description.
Usage: port [nn|all] type [232|422|485] flow []
flow 0:None.
flow 1:XOn/XOff.
flow 2:RTS/CTS.
flow 3:DTR/DSR.
Set serial port type and flow control.
Usage: port [nn|all] baud [50-230400] parity [] data [5-8] stop [1|1.5|2]
acceptable baud: 50 75 110 150 300 600 1200 1800 2400 4800 7200 9600
14400 19200 38400 57600 115200 230400
parity n: None Parity.
parity e: Even Parity.
parity o: Odd Parity.
parity m: Mark Parity.
parity s: Space Parity.
Set serial baud rate, parity and numbers of data bits, numbers of stop bits.
Usage: port [nn|all] mode [vcom|ctrl|data]
Set serial port as virtual COM port or control mode or data mode.
Press any key for continue...
_
Connected 0:07:52 Auto detect 30400 8-N-1 SCROLL CAPS NUM Capture Print echo

```

- [Usage] port nn or port all
- [Function] Show the “nn”th port or all ports information

```

EKI-1526_Seial Console - HyperTerminal
File Edit View Call Transfer Help
Set serial port type and flow control.
Usage: port [nn|all] baud [50-230400] parity [] data [5-8] stop [1|1.5|2]
acceptable baud: 50 75 110 150 300 600 1200 1800 2400 4800 7200 9600
14400 19200 38400 57600 115200 230400
parity n: None Parity.
parity e: Even Parity.
parity o: Odd Parity.
parity m: Mark Parity.
parity s: Space Parity.
Set serial baud rate, parity and numbers of data bits, numbers of stop bits.
Usage: port [nn|all] mode [vcom|ctrl|data]
Set serial port as virtual COM port or control mode or data mode.
Press any key for continue...
$port 13
*****
Serial Port 13 Information
Description :
Type       : RS-232           Baudrate   : 9600
Flow Control: None          Data Bits  : 8
Stop Bits  : 1              Parity     : None
Mode       : Virtual COM Port

Host Idle TimeOut(s) : 60
$_
Connected 0:10:19 Auto detect 30400 8-N-1 SCROLL CAPS NUM Capture Print echo

```

- [Usage] port nn desc XXXX
- [Function] Set the “nn”th port’s description [XXXX: maximum length 127 bytes]

[Usage] port nn|all type 232|422|485 flow 0|1|2|3
 [Function] Set serial ports' type and flow control

Flow 0: None
 Flow 1: XOn/XOff
 Flow2: RTS/CTS
 Flow3: DTR/DSR

[Usage] port nn|all baud XXXX parity n|e|o|m|s data 5|6|7|8 stop 1|1.5|2
 [Function] Set the serial ports' baud rate, parity, data bits, and stop bits.

Acceptable baud rate: 50, 75, 110, 150, 300, 600, 1200, 1800, 2400, 4800, 7200, 9600, 14400, 19200, 38400, 57600, 115200, 230400, 460800, and 921600

Parity n: None
 Parity e: Even
 Parity o: Odd
 Parity m: Mark
 Parity s: Space

[Usage] port nn|all mode vcom|ctrl|data
 [Function] Set the serial ports as virtual COM mode, control mode, or data mode

mvcom

Show and setup the VCOM mode

The screenshot shows a HyperTerminal window titled "EKI-1526 Serial Console - HyperTerminal". The window contains a series of dollar signs (\$) representing a command prompt. The command "\$help mvcom" has been entered and is highlighted with a red box. Below the command, the following help text is displayed:

```

Usage: mvcom
  Show all port mode and mode informations.
Usage: mvcom [nn|all]
  Set port [nn|all] as virtual COM port mode.
Usage: mvcom [nn|all] idleto []
  Set host idle timeout(s).
Usage: mvcom [nn|all] respto [] framebk []
  Set response timeout(ms) and frame break(ms).
$
  
```

At the bottom of the window, a status bar shows "Connected 0:31:01", "Auto detect", "38400 8-N-1", "SCROLL", "CAPS", "NUM", "Capture", and "Print echo".

[Usage] mvcom

[Function] Show all serial ports mode and related information

[Usage] mvcom nn|all

[Function] Set the “nn”th or all serial ports as the Virtual COM mode

[Usage] mvcom nn|all idleto XX

[Function] Set the “nn”th or all serial ports host idle timeout (S)

[Usage] mvcom nn|all respto XX framebk XX

[Function] Set the “nn”th or all serial ports response timeout and frame break

mctrl

Show and setup the Control mode

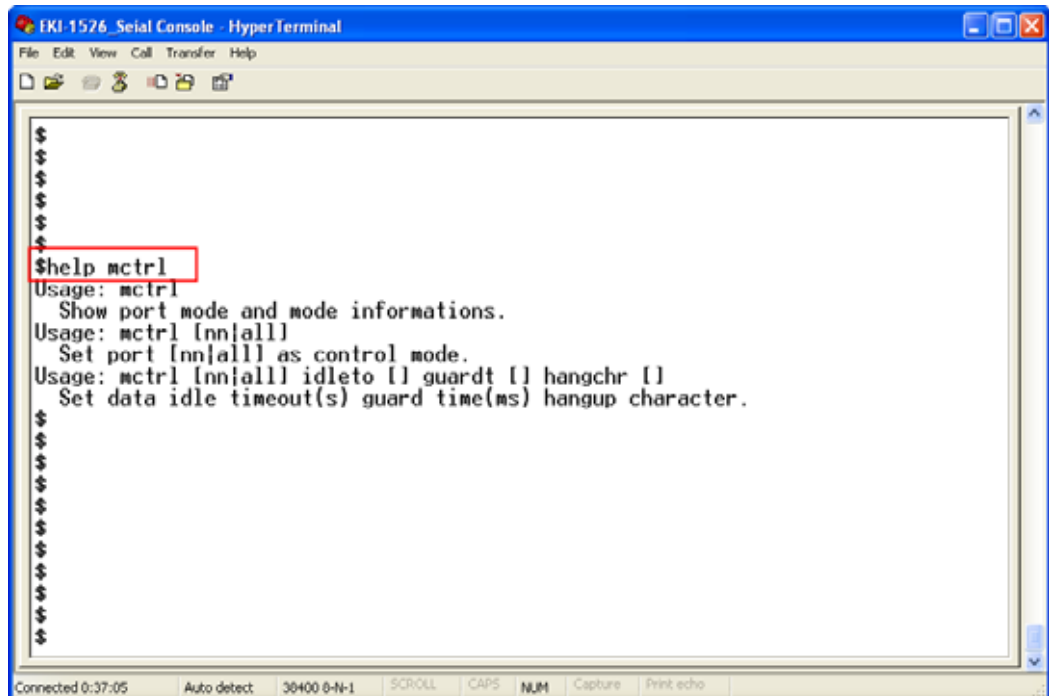

[Usage] mctrl

[Function] Show all serial ports mode and related information

[Usage] mctrl nn|all

[Function] Set the “nn”th or all serial ports as the Control mode

[Usage] mctrl nn|all idleto XX guardt XX hangchr XX

[Function] Set the “nn”th or all serial ports data idle timeout, guard time and hang character

mdata

Show and setup the Data mode

```

EKI-1526_Serial Console - HyperTerminal
File Edit View Call Transfer Help
$
$
$
$
$
$
$
$
$
$
$help mdata
Usage: mdata
  Show port mode and mode informations.
Usage: mdata [nn|all]
  Set port [nn|all] as data mode.
Usage: mdata [nn|all] protocol [TCP|UDP]
  Set transmit protocol as TCP or UDP.
Usage: mdata [nn|all] idletime [l] lsport [l] atport [l]
  Set data idle timeout(s) listen port and AT command port.
Usage: mdata [nn|all] respto [l] framebk [l]
  Set response timeout(ms) and frame break(ms).
Usage: mdata [nn|all] peernum [1-16] peer [d.d.d.d:d] ...
  Set peer IP address and port for receive data.
$

```

[Usage] mdata

[Function] Show all serial ports mode and related information

[Usage] mdata nn|all

[Function] Set the “nn”th or all serial ports as the Data mode

[Usage] mdata nn|all protocol TCP|UDP

[Function] Set the “nn”th or all serial ports’ transmit protocol as TCP or UDP

[Usage] mdata nn|all idletime XX lsport XXXX atport XXXX

[Function] Set the “nn”th or all serial ports data idle timeout, listen port, and AT command port

[Usage] mdata nn|all respto XX framebk XX

[Function] Set the “nn”th or all serial ports response timeout and frame break

[Usage] mdata nn|all peernum 1|2|3|4|5|6|7|8|9|10|11|12|13|14|15|16 peer
XX.XX.XX.XX:ppp

[Function] Set the peer IP address and port for receive data

net

Show and setup the Ethernet port configuration

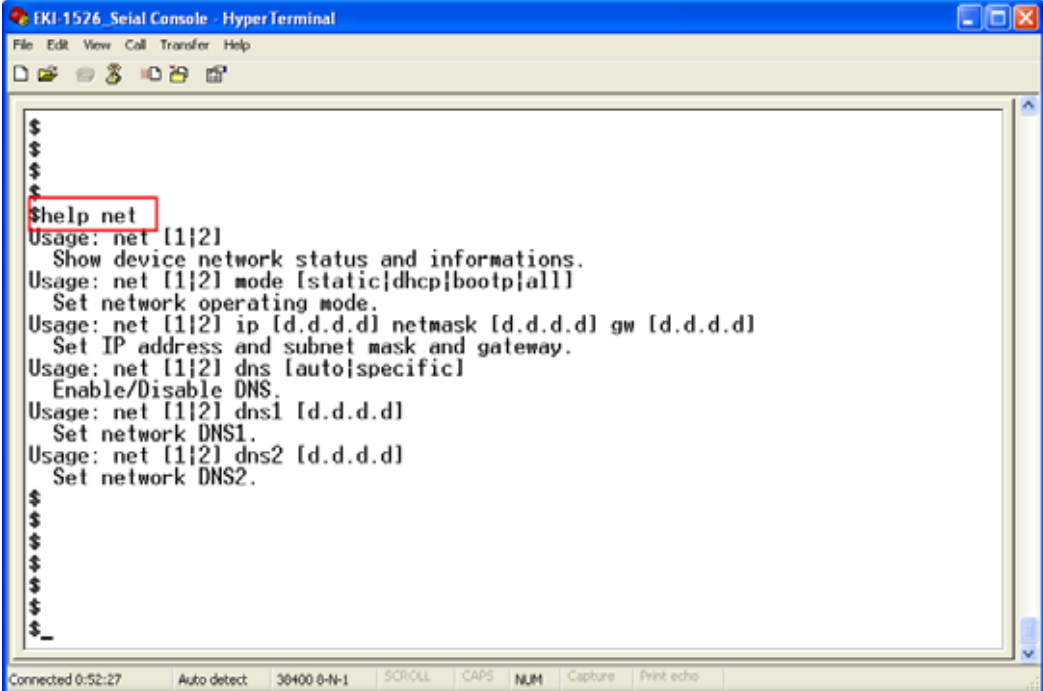

```
$
$
$
$
$help net
Usage: net [1|2]
  Show device network status and informations.
Usage: net [1|2] mode [static|dhcp|bootp|all]
  Set network operating mode.
Usage: net [1|2] ip [d.d.d.d] netmask [d.d.d.d] gw [d.d.d.d]
  Set IP address and subnet mask and gateway.
Usage: net [1|2] dns [auto|specific]
  Enable/Disable DNS.
Usage: net [1|2] dns1 [d.d.d.d]
  Set network DNS1.
Usage: net [1|2] dns2 [d.d.d.d]
  Set network DNS2.
$
$
$
$
$
$
$
$
```

[Usage] net 1|2

[Function] Show the first or second Ethernet port status and information

[Usage] net 1|2 mode static|dhcp|boot|all

[Function] Set the network operating mode

[Usage] net 1|2 ip XX.XX.XX.XX netmask XX.XX.XX.XX gw XX.XX.XX.XX

[Function] Set IP address, subnet mask, and default gateway

[Usage] net 1|2 dns auto|specific

[Usage] net 1|2 dns1 XX.XX.XX.XX

[Usage] net 1|2 dns2 XX.XX.XX.XX

[Function] Set the DNS function

password

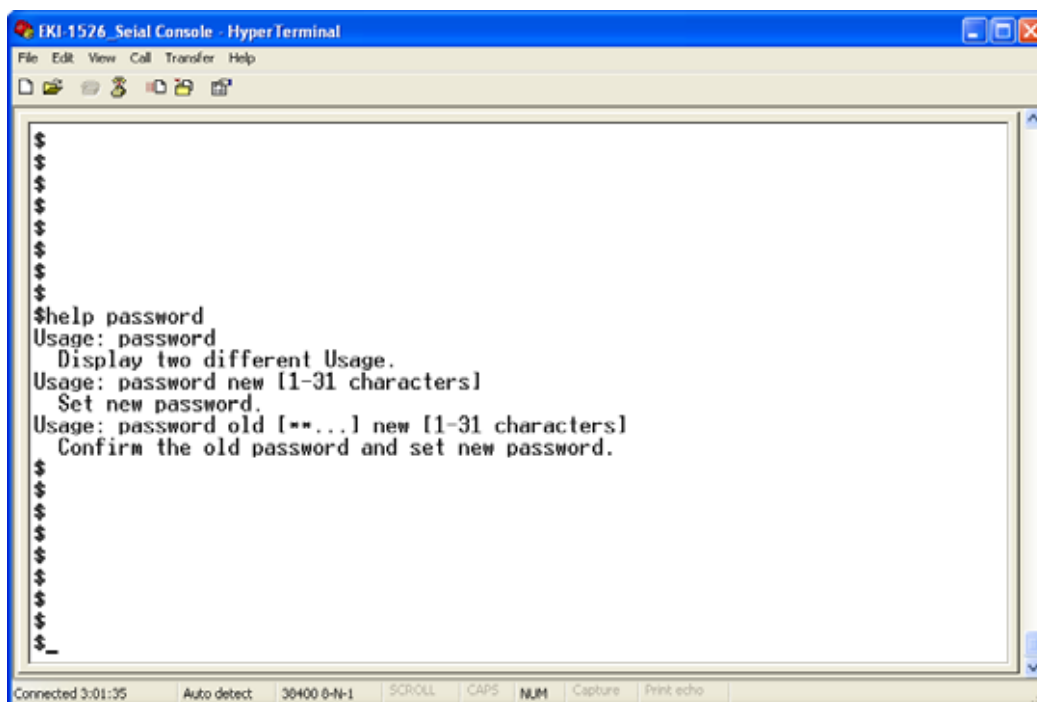

```

EKI-1576 Serial Console - Hyper Terminal
File Edit View Call Transfer Help
$
$
$
$
$
$
$
$
$
$help password
Usage: password
  Display two different Usage.
Usage: password new [1-31 characters]
  Set new password.
Usage: password old [*..] new [1-31 characters]
  Confirm the old password and set new password.
$
$
$
$
$
$
$
$
$
$
Connected 3:01:35  Auto detect  38400 8-N-1  SCROLL  CAPS  NUM  Capture  Print echo
    
```

[Usage] password new XXXX

[Function] Set new password [XXXX: maximum 31 characters]

[Usage] password old XXXX new XXXX

[Function] Confirm the old password and set a new password

apply

[Usage] apply

[Function] Save the settings to the flash memory and reboot the system immediately

exit

[Usage] exit

[Function] Terminate the shell session

import/export

[Usage] import

[Function] Import the serial device server settings' file

[Usage] export

[Function] Export the serial device server settings' file

monitor

Show the serial ports settings, statistic, and connected IP address

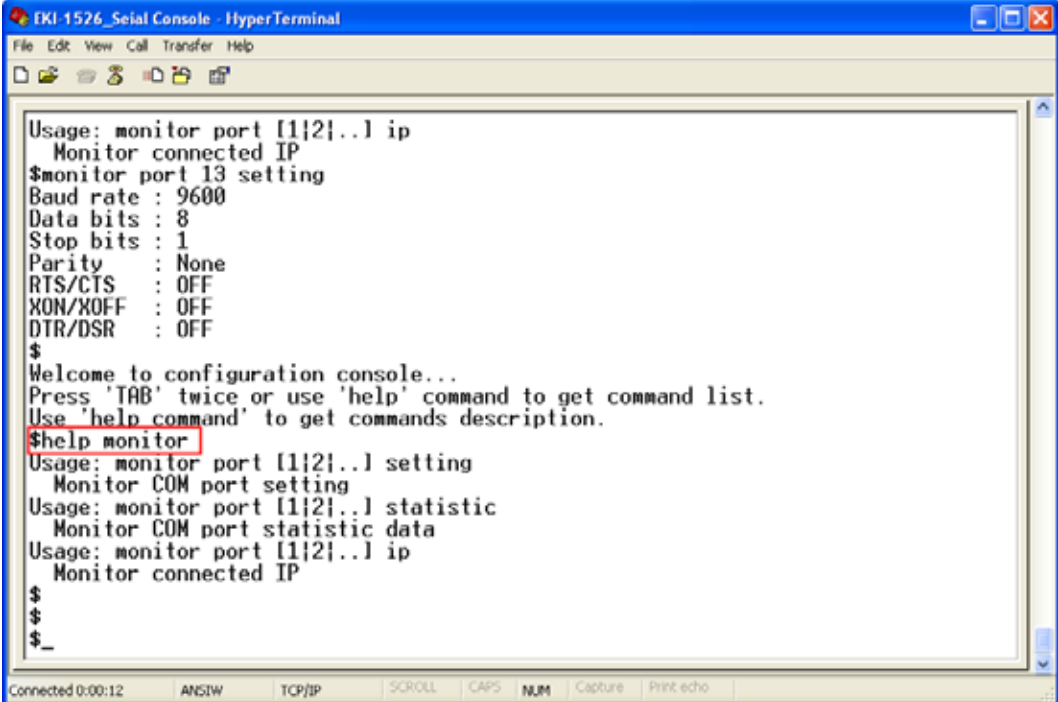

```
EKI-1526_Serial Console - HyperTerminal
File Edit View Call Transfer Help
Usage: monitor port [1|2|...] ip
Monitor connected IP
$monitor port 13 setting
Baud rate : 9600
Data bits : 8
Stop bits : 1
Parity : None
RTS/CTS : OFF
XON/XOFF : OFF
DTR/DSR : OFF
$
Welcome to configuration console...
Press 'TAB' twice or use 'help' command to get command list.
Use 'help command' to get commands description.
$help monitor
Usage: monitor port [1|2|...] setting
Monitor COM port setting
Usage: monitor port [1|2|...] statistic
Monitor COM port statistic data
Usage: monitor port [1|2|...] ip
Monitor connected IP
$
$
$
$ _
Connected 0:00:12 ANSIW TCP/IP SCROLL CAPS NUM Capture Print echo
```

[Usage] monitor port 1|2|...|16 setting

[Function] Monitor the serial ports settings

[Usage] monitor port 1|2|...|16 statistic

[Function] Monitor the serial ports statistic

[Usage] monitor port 1|2|...|16 ip

[Function] Monitor the serial ports connected IP address

alarm

Show or configure the auto warning function

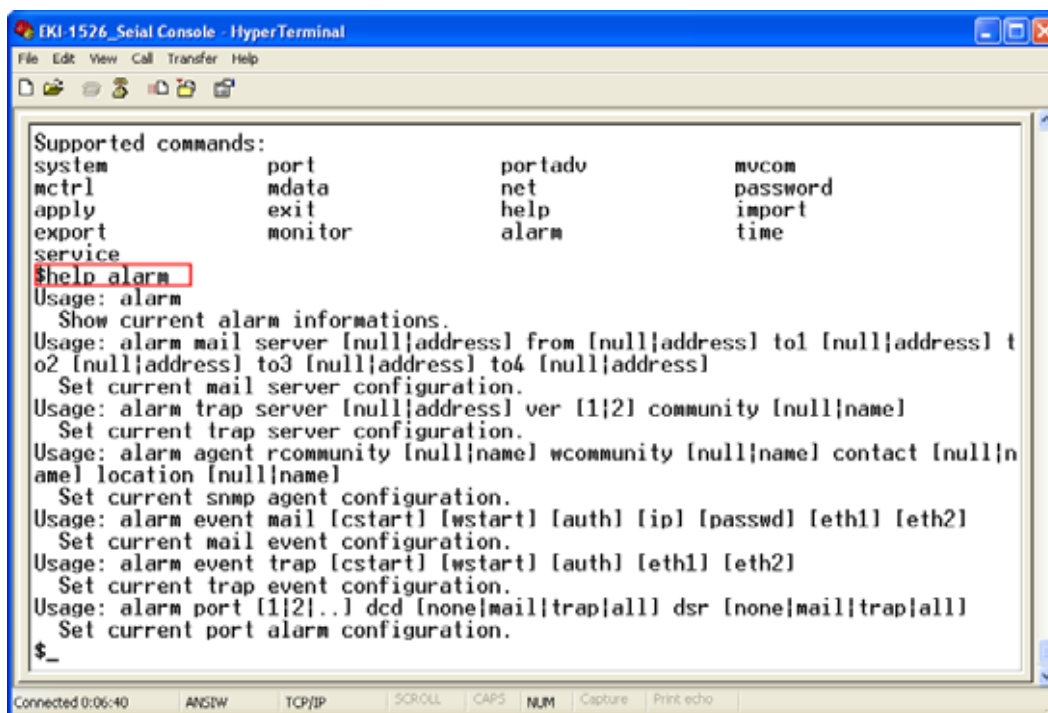

```

EKI-1526_Seial Console - HyperTerminal
File Edit View Call Transfer Help

Supported commands:
system          port          portadv        mvcom
mctrl          mdata         net            password
apply          exit          help           import
export         monitor       alarm          time
service

$help alarm
Usage: alarm
  Show current alarm informations.
Usage: alarm mail server [null|address] from [null|address] to1 [null|address] to2 [null|address] to3 [null|address] to4 [null|address]
  Set current mail server configuration.
Usage: alarm trap server [null|address] ver [1|2] community [null|name]
  Set current trap server configuration.
Usage: alarm agent rcommunity [null|name] wcommunity [null|name] contact [null|name] location [null|name]
  Set current snmp agent configuration.
Usage: alarm event mail [cstart] [wstart] [auth] [ip] [passwd] [eth1] [eth2]
  Set current mail event configuration.
Usage: alarm event trap [cstart] [wstart] [auth] [eth1] [eth2]
  Set current trap event configuration.
Usage: alarm port [1|2]..] dcd [none|mail|trap|all] dsr [none|mail|trap|all]
  Set current port alarm configuration.
$

```

For more detailed setting for auto warning, please refer to chapter 3.7

time

Show or configure the time information

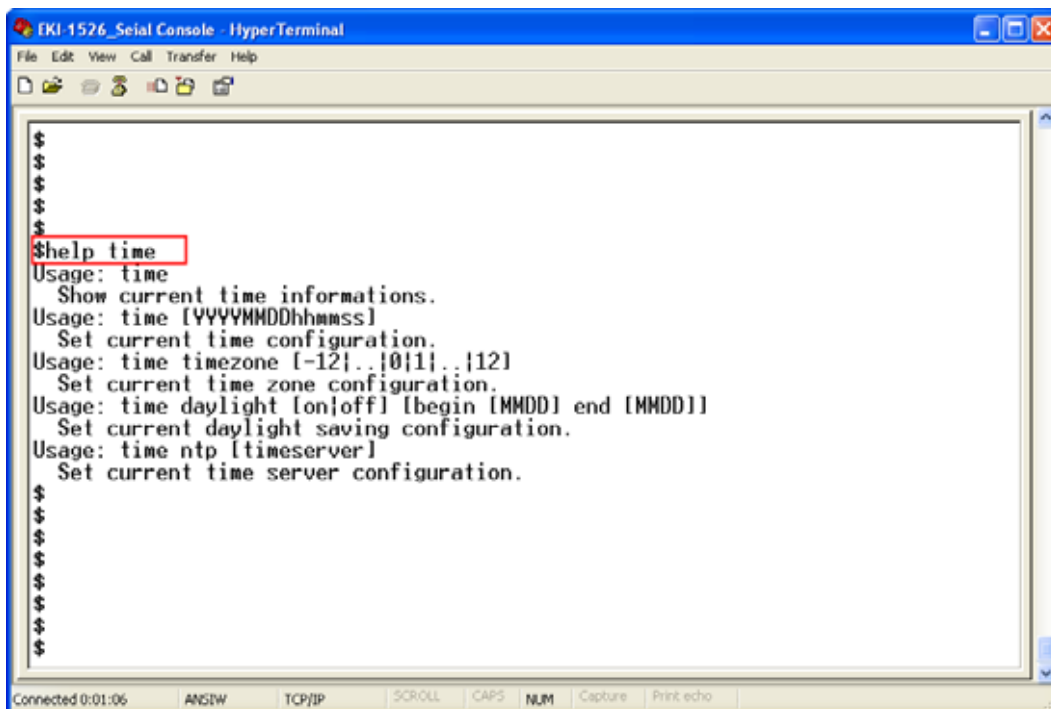

```

EKI-1526_Seial Console - HyperTerminal
File Edit View Call Transfer Help

$
$
$
$
$
$
$help time
Usage: time
  Show current time informations.
Usage: time [YYYYMMDDhhmmss]
  Set current time configuration.
Usage: time timezone [-12|..|0|1|..|12]
  Set current time zone configuration.
Usage: time daylight [on|off] [begin [MMDD]] end [MMDD]]
  Set current daylight saving configuration.
Usage: time ntp [timeserver]
  Set current time server configuration.
$
$
$
$
$
$
$
$
$
$

```

[Usage] time

[Function] Show the current time information

[Usage] time YYYYMMDDhhmmss

[Function] Modify the current time information

[Usage] time timezone -12|...|0|1|...|12

[Function] Set the current timezone configuration

[Usage] time daylight on|off begin MMDD end MMDD

[Function] Set the current time daylight saving configuration

[Usage] time ntp XXXX

[Function] Set the NTP timeserver [XXXX: time server]

service

Enable or disable some extra service

```
EKI-1526_Serial Console - HyperTerminal
File Edit View Call Transfer Help
$
$
$
$
$help service
Usage: service web [enable|disable]
  Enable/Disable web function
Usage: service telnet [enable|disable]
  Enable/Disable telnet function
Usage: service snmp [enable|disable]
  Enable/Disable SNMP function
$
$
$
$
$
$
$
$
$
$
$
$
```

Connected 0:04:21 ANSIIW TCP/IP SCROLL CAPS NUM Capture Print echo

[Usage] service web enable|disable

[Function] Enable or disable the web-based configuration

[Usage] service telnet enable|disable

[Function] Enable or disable the telnet console

[Usage] service SNMP enable|disable

[Function] Enable or disable the SNMP function

wireless

Show or configure the wireless settings or informations

[Usage] wireless

[Function] Show or configure the wireless settings or informations

[Usage] wireless ssid XXXX

[Function] Set SSID as XXXX

[Usage] wireless country us|de|fr|es|jp|kr|cn channel 0|1|...|14

[Function] Set country code and channel.

us - United States

de – Germany

fr – France

es - Spain

jp – Japan

kr – Korea

cn - China

channel 0 - Auto

[Usage] wireless encryption none|wep|wpa-psk|wpa-enterprise

[Function] Set encryption type.

[Usage] wireless wepauth on|off

[Function] Set WEP authentication algorithm.

[Usage] wireless wepidx 0|1|2|3

[Function] Set WEP key index.

[Usage] wireless wepkey asc|hex XXXX

[Function] Set WEP key as XXXX in specific format

[Usage] wireless wpakey XXXX

[Function] Set WPA-PSK key as XXXX

[Usage] wireless wpaep tls|ttls|peap

[Function] Set WPA-Enterprise EAP method.

[Usage] wirelesswpa11w 0|1|2

[Function] Set WPA-Enterprise management frame protected.

0 – Disable

1 – Optional

2 – Required

[Usage] wireless wpaid XXXX

[Function] Set WPA-Enterprise identity as XXXX.

[Usage] wireless wpapw XXXX
[Function] Set WPA-Enterprise as XXXX.

[Usage] wireless wpaphase mschapv2|md5
[Function] Set WPA-Enterprise inner authentication.

[Usage] wireless capw XXXX
[Function] Set private key as XXXX.

[Usage] wireless cacert
[Function] import the CA certification from host PC to device.

[Usage] wireless caclient
[Function] import the Client certification from host PC to device.

[Usage] wireless cakey
[Function] import the private key from host PC to device.

wirelessadv

Show or configure the wireless advanced settings or information

[Usage] wirelessadv
[Function] Show device wireless advance informations.

[Usage] wirelessadv rts 256|...|2347
[Function] Set RTS threshold.

[Usage] wirelessadv frag 256|...|2346
[Function] Set fragmentation threshold.

[Usage] wirelessadv roaming on|off
[Function] Enable/disable Roaming.

[Usage] wirelessadv rssi 10|...|95
[Function] Set connection quality monitor RSSI threshold.

[Usage] wirelessadv preamble short|long
[Function] Set preamble.

[Usage] wirelessadv scanint_high 10|...|600
[Function] Set scan interval when received signal strength is better than RSSI threshold.

[Usage] wirelessadv scanint_low 10|...|600
[Function] Set scan interval when received signal strength is worse than RSSI threshold.

Appendix **A**

Pin Assignments

A.1 Pin Assignments

A.1.1 RS-232 Pin Assignments

Pin #	Description
1	DCD
2	Rx
3	Tx
4	DTR
5	GND
6	DSR
7	RTS
8	CTS
9	RI

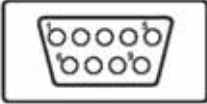
A diagram of a 9-pin D-sub connector, showing a trapezoidal shape with two rows of pins. The top row has five pins and the bottom row has four pins.

A.1.2 RS-422/485 Pin Assignments

A.1.2.1 1. RS-422

Pin #.	Description
1	Tx-
4	Tx+
5	GND
7	Rx+
9	Rx-

A.1.2.2 2. RS-485

Pin #	Description
1	Data-
4	Data+
5	GND

Appendix **B**

List of Known TCP and
UDP Port Numbers

B.1 List of Known TCP and UDP Port Numbers

Port	Protocol	Service
5048	(TCP/UDP)	Configuration Utility
5058	(TCP/UDP)	Configuration Utility
5202	(TCP)	VCOM/RVCOM
9999	(TCP)	Firmware Download
22	(TCP)	SSH
23	(TCP)	Telnet
25	(TCP)	SMTP(Mail Client)
53	(TCP/UDP)	DNS
67	(UDP)	BOOTP Server/DHCP
68	(UDP)	BOOTP Client/DHCP
80	(TCP)	Web Interface/HTTP
123	(TCP)	NTP
161	(UDP)	SNMP
162	(TCP/UDP)	SNMP Trap
443	(TCP)	HTTPS
502	(TCP)	Modbus/TCP(Default)
514	(UDP)	Syslog
546	(TCP/UDP)	DHCPv6 Client
547	(TCP/UDP)	DHCPv6 Server

www.advantech.com

Please verify specifications before quoting. This guide is intended for reference purposes only.

All product specifications are subject to change without notice.

No part of this publication may be reproduced in any form or by any means, electronic, photocopying, recording or otherwise, without prior written permission of the publisher.

All brand and product names are trademarks or registered trademarks of their respective companies.

© Advantech Co., Ltd. 2013

Federal Communication Commission Interference Statement

This equipment has been tested and found to comply with the limits for a Class B digital device, pursuant to Part 15 of the FCC Rules. These limits are designed to provide reasonable protection against harmful interference in a residential installation. This equipment generates, uses and can radiate radio frequency energy and, if not installed and used in accordance with the instructions, may cause harmful interference to radio communications. However, there is no guarantee that interference will not occur in a particular installation. If this equipment does cause harmful interference to radio or television reception, which can be determined by turning the equipment off and on, the user is encouraged to try to correct the interference by one of the following measures:

- Reorient or relocate the receiving antenna.
- Increase the separation between the equipment and receiver.
- Connect the equipment into an outlet on a circuit different from that to which the receiver is connected.
- Consult the dealer or an experienced radio/TV technician for help.

15.21

FCC Caution: Any changes or modifications not expressly approved by the party responsible for compliance could void the user's authority to operate this equipment.

15.19

This device complies with Part 15 of the FCC Rules. Operation is subject to the following two conditions: (1) This device may not cause harmful interference, and (2) this device must accept any interference received, including interference that may cause undesired operation.

FCC RF Radiation Exposure Statement:

1. This Transmitter must not be co-located or operating in conjunction with any other antenna or transmitter.
2. This equipment complies with FCC RF radiation exposure limits set forth for an uncontrolled environment. This equipment should be installed and operated with a minimum distance of 20 centimeters between the radiator and your body.