

User Manual

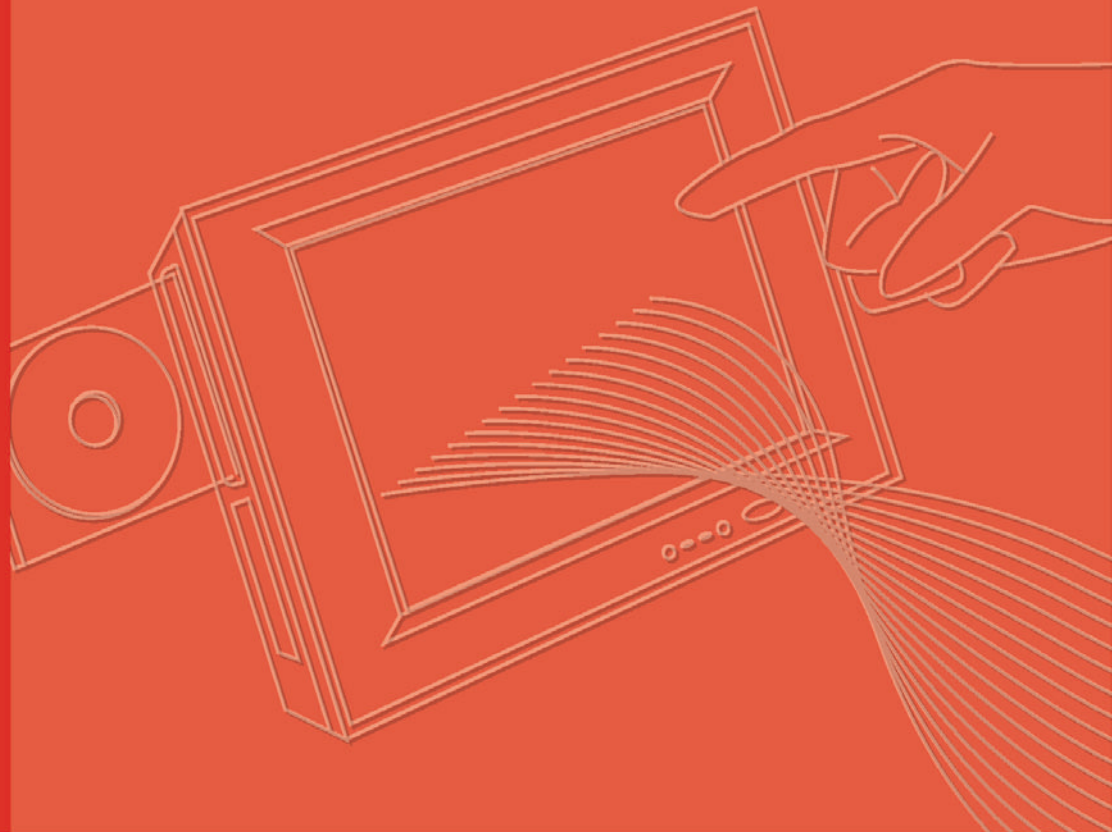

MARS-3100R/S

Industrial Tablet PC

Trusted ePlatform Services

ADVANTECH

Copyright

The documentation and the software included with this product are copyrighted 2007 by Advantech Co., Ltd. All rights are reserved. Advantech Co., Ltd. reserves the right to make improvements in the products described in this manual at any time without notice. No part of this manual may be reproduced, copied, translated or transmitted in any form or by any means without the prior written permission of Advantech Co., Ltd. Information provided in this manual is intended to be accurate and reliable. However, Advantech Co., Ltd. assumes no responsibility for its use, nor for any infringements of the rights of third parties, which may result from its use.

Acknowledgements

Intel and Pentium are trademarks of Intel Corporation.

Microsoft Windows and MS-DOS are registered trademarks of Microsoft Corp.

All other product names or trademarks are properties of their respective owners.

Product Warranty (2 years)

Advantech warrants to you, the original purchaser, that each of its products will be free from defects in materials and workmanship for two years from the date of purchase.

This warranty does not apply to any products which have been repaired or altered by persons other than repair personnel authorized by Advantech, or which have been subject to misuse, abuse, accident or improper installation. Advantech assumes no liability under the terms of this warranty as a consequence of such events.

Because of Advantech's high quality-control standards and rigorous testing, most of our customers never need to use our repair service. If an Advantech product is defective, it will be repaired or replaced at no charge during the warranty period. For out-of-warranty repairs, you will be billed according to the cost of replacement materials, service time and freight. Please consult your dealer for more details.

If you think you have a defective product, follow these steps:

1. Collect all the information about the problem encountered. (For example, CPU speed, Advantech products used, other hardware and software used, etc.) Note anything abnormal and list any onscreen messages you get when the problem occurs.
2. Call your dealer and describe the problem. Please have your manual, product, and any helpful information readily available.
3. If your product is diagnosed as defective, obtain an RMA (return merchandise authorization) number from your dealer. This allows us to process your return more quickly.
4. Carefully pack the defective product, a fully-completed Repair and Replacement Order Card and a photocopy proof of purchase date (such as your sales receipt) in a shippable container. A product returned without proof of the purchase date is not eligible for warranty service.
5. Write the RMA number visibly on the outside of the package and ship it prepaid to your dealer.

Part No. 2006310000

Printed in Taiwan

Edition 1

December 2007

Declaration of Conformity

FCC Class A

Note: This equipment has been tested and found to comply with the limits for a Class A digital device, pursuant to part 15 of the FCC Rules. These limits are designed to provide reasonable protection against harmful interference when the equipment is operated in a commercial environment. This equipment generates, uses, and can radiate radio frequency energy and, if not installed and used in accordance with the instruction manual, may cause harmful interference to radio communications. Operation of this equipment in a residential area is likely to cause harmful interference in which case the user will be required to correct the interference at his own expense.

FCC Class B

Note: This equipment has been tested and found to comply with the limits for a Class B digital device, pursuant to part 15 of the FCC Rules. These limits are designed to provide reasonable protection against harmful interference in a residential installation. This equipment generates, uses and can radiate radio frequency energy and, if not installed and used in accordance with the instructions, may cause harmful interference to radio communications. However, there is no guarantee that interference will not occur in a particular installation. If this equipment does cause harmful interference to radio or television reception, which can be determined by turning the equipment off and on, the user is encouraged to try to correct the interference by one or more of the following measures:

- Reorient or relocate the receiving antenna.
- Increase the separation between the equipment and receiver.
- Connect the equipment into an outlet on a circuit different from that to which the receiver is connected.
- Consult the dealer or an experienced radio/TV technician for help.

FM

This equipment has passed the FM certification. According to the National Fire Protection Association, work sites are classified into different classes, divisions and groups, based on hazard considerations. This equipment is compliant with the specifications of Class I, Division 2, Groups A, B, C and D indoor hazards.

This equipment complies with FCC radiation exposure limits set forth for an uncontrolled environment. End users must follow the specific operating instructions for satisfying RF exposure compliance. SAR compliance has been established, Maximum reported SAR: 1.112 W/kg (Body).
--

Europe – EU Declaration of Conformity

This device complies with the essential requirements of the R&TTE Directive 1999/5/EC. The following test methods have been applied in order to prove presumption of conformity with the essential requirements of the R&TTE Directive 1999/5/EC:

- EN 60950-1: 2001
Safety of information technology equipment
- IEEE Std. 1528: 2003
Recommended practice for determining the peak spatial-average specific absorption rate (SAR) in the human head from wireless communications devices: Measurement Techniques.
- ANSI/IEEE C95.3: 2002
IEEE recommended practice for the measurement and computations of radio frequency electromagnetic fields with respect to human exposure to such fields, 100kHz-300GHz.
- EN 300 328 V1.7.1 (2006-10)
Electromagnetic compatibility and Radio spectrum Matters (ERM); Wideband transmission systems; Data transmission equipment operating in the 2,4 GHz ISM band and using wide band modulation techniques; Harmonized EN covering essential requirements under article 3.2 of the R&TTE Directive
- EN 301 893 V1.2.3 (2003-08)
Broadband Radio Access Networks (BRAN); 5 GHz high performance RLAN; Harmonized EN covering essential requirements of article 3.2 of the R&TTE Directive
- 2005/513/EC, Commission Decision of 11 July 2005 on the harmonised use of radio spectrum in the 5 GHz frequency band for the implementation of wireless access systems including radio local area networks (WAS/RLANs)
- EN 301 489-17 V1.2.1 (2002-08) and EN 301 489-1 V1.4.1 (2002-08)
Electromagnetic compatibility and Radio spectrum Matters (ERM); ElectroMagnetic Compatibility (EMC) standard for radio equipment and services; Part 17: Specific conditions for 2,4 GHz wideband transmission systems and 5 GHz high performance RLAN equipment

This device is a 2.4 GHz wideband transmission system (transceiver), intended for use in all EU member states and EFTA countries under the following conditions and/or with the following restrictions:

- In Italy the end-user should apply for a license at the national spectrum authorities in order to obtain authorization to use the device for setting up outdoor radio links and/or for supplying public access to telecommunications and/or network services.
- This device may not be used for setting up outdoor radio links in France and in some areas the RF output power may be limited to 10 mW EIRP in the frequency range of 2454 – 2483.5 MHz. For detailed information the end-user should contact the national spectrum authority in France.







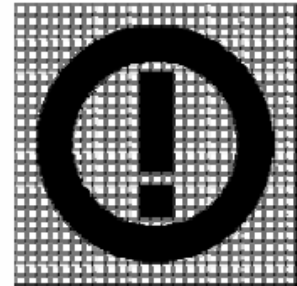

This device is a 5 GHz wideband transmission system (transceiver), intended for use in all EU member states and EFTA countries under the following conditions and/or with the following restrictions:

- This device may only be used indoors in the frequency bands 5150 – 5250 MHz and 5250 – 5350 MHz.
- In France and Luxembourg a limited implementation of the frequency bands 5150 – 5250 MHz and 5250 – 5350 MHz. In Luxembourg it is not allowed to make use of the frequency band 5470 – 5725 MHz. End-users are encouraged to contact the national spectrum authorities in France and Luxembourg in order to obtain the latest information about any restrictions in the 5 GHz frequency band(s).

CE 0560



Český [Czech]	<i>[Advantech]</i> tímto prohlašuje, že tento <i>[MARS-3100S]</i> je ve shodě se základními požadavky a dalšími příslušnými ustanoveními směrnice 1999/5/ES.
Dansk [Danish]	Undertegnede <i>[Advantech]</i> erklærer herved, at følgende udstyr <i>[MARS-3100S]</i> overholder de væsentlige krav og øvrige relevante krav i direktiv 1999/5/EF.
Deutsch [German]	Hiermit erkläre <i>[Advantech]</i> , dass sich das Gerät <i>[MARS-3100S]</i> in Übereinstimmung mit den grundlegenden Anforderungen und den übrigen einschlägigen Bestimmungen der Richtlinie 1999/5/EG befindet.
Eesti [Estonian]	Käesolevaga kinnitab <i>[Advantech]</i> seadme <i>[MARS-3100S]</i> vastavust direktiivi 1999/5/EÜ põhinõuetele ja nimetatud direktiivist tulenevatele teistele asjakohastele sätetele.
English	Hereby, <i>[Advantech]</i> , declares that this <i>[MARS-3100S]</i> is in compliance with the essential requirements and other relevant provisions of Directive 1999/5/EC.
Español [Spanish]	Por medio de la presente <i>[Advantech]</i> declara que el <i>[MARS-3100S]</i> cumple con los requisitos esenciales y cualesquiera otras disposiciones aplicables o exigibles de la Directiva 1999/5/CE.
Ελληνική [Greek]	ΜΕ ΤΗΝ ΠΑΡΟΥΣΑ <i>[Advantech]</i> ΔΗΛΩΝΕΙ ΟΤΙ <i>[MARS-3100S]</i> ΣΥΜΜΟΡΦΩΝΕΤΑΙ ΠΡΟΣ ΤΙΣ ΟΥΣΙΩΔΕΙΣ ΑΠΑΙΤΗΣΕΙΣ ΚΑΙ ΤΙΣ ΛΟΙΠΕΣ ΣΧΕΤΙΚΕΣ ΔΙΑΤΑΞΕΙΣ ΤΗΣ ΟΔΗΓΙΑΣ 1999/5/ΕΚ.
Français [French]	Par la présente <i>[Advantech]</i> déclare que l'appareil <i>[MARS-3100S]</i> est conforme aux exigences essentielles et aux autres dispositions pertinentes de la directive 1999/5/CE.
Italiano [Italian]	Con la presente <i>[Advantech]</i> dichiara che questo <i>[MARS-3100S]</i> è conforme ai requisiti essenziali ed alle altre disposizioni pertinenti stabilite dalla direttiva 1999/5/CE.
Latviski	Ar šo <i>[Advantech]</i> deklarē, ka <i>[MARS-3100S]</i> atbilst Direktīvas 1999/5/EK būtiskajām prasībām

[Latvian]	un citiem ar to saistītajiem noteikumiem.
Lietuvių [Lithuanian]	Šiuo <i>[Advantech]</i> deklaruoja, kad šis <i>[MARS-3100S]</i> atitinka esminius reikalavimus ir kitas 1999/5/EB Direktyvos nuostatas.
 Nederlands [Dutch]	Hierbij verklaart <i>[Advantech]</i> dat het toestel <i>[MARS-3100S]</i> in overeenstemming is met de essentiële eisen en de andere relevante bepalingen van richtlijn 1999/5/EG.
 Malti [Maltese]	Hawnhekk, <i>[Advantech]</i> , jiddikjara li dan <i>[MARS-3100S]</i> jikkonforma mal-ħtiġijiet essenzjali u ma provvedimenti oħrajn relevanti li hemm fid-Dirrettiva 1999/5/EC.
 Magyar [Hungarian]	Alulírott, <i>[Advantech]</i> nyilatkozom, hogy a <i>[MARS-3100S]</i> megfelel a vonatkozó alapvető követelményeknek és az 1999/5/EC irányelv egyéb előírásainak.
 Polski [Polish]	Niniejszym <i>[Advantech]</i> oświadcza, że <i>[MARS-3100S]</i> jest zgodny z zasadniczymi wymogami oraz pozostałymi stosownymi postanowieniami Dyrektywy 1999/5/EC.
 Português [Portuguese]	<i>[Advantech]</i> declara que este <i>[MARS-3100S]</i> está conforme com os requisitos essenciais e outras disposições da Directiva 1999/5/CE.
 Slovensko [Slovenian]	<i>[Advantech]</i> izjavlja, da je ta <i>[tip opreme]</i> v skladu z bistvenimi zahtevami in ostalimi relevantnimi določili direktive 1999/5/ES.
Slovensky [Slovak]	<i>[Advantech]</i> týmto vyhlasuje, že <i>[tip opreme]</i> spĺňa základné požiadavky a všetky príslušné ustanovenia Smernice 1999/5/ES.
 Suomi [Finnish]	<i>[Advantech]</i> vakuuttaa täten että <i>[tip opreme]</i> tyyppinen laite on direktiivin 1999/5/EY oleellisten vaatimusten ja sitä koskevien direktiivin muiden ehtojen mukainen.
 Svenska [Swedish]	Härmed intygar <i>[Advantech]</i> att denna <i>[tip opreme]</i> står i överensstämmelse med de väsentliga egenskapskrav och övriga relevanta bestämmelser som framgår av direktiv 1999/5/EG.

Technical Support and Assistance

1. Visit the Advantech web site at www.advantech.com/support where you can find the latest information about the product.
2. Contact your distributor, sales representative, or Advantech's customer service center for technical support if you need additional assistance. Please have the following information ready before you call:
 - Product name and serial number
 - Description of your peripheral attachments
 - Description of your software (operating system, version, application software, etc.)
 - A complete description of the problem
 - The exact wording of any error messages

Warnings, Cautions and Notes

Warning! *Warnings indicate conditions, which if not observed, can cause personal injury!*



Caution! *Cautions are included to help you avoid damaging hardware or losing data. e.g.*



There is a danger of a new battery exploding if it is incorrectly installed. Do not attempt to recharge, force open, or heat the battery. Replace the battery only with the same or equivalent type recommended by the manufacturer. Discard used batteries according to the manufacturer's instructions.

Note! *Notes provide optional additional information.*



Document Feedback

To assist us in making improvements to this manual, we would welcome comments and constructive criticism.

Please send all such - in writing to: support@advantech.com

Safety Instructions

1. Read these safety instructions carefully.
2. Keep this User Manual for later reference.
3. Disconnect this equipment from any AC outlet before cleaning. Use a damp cloth. Do not use liquid or spray detergents for cleaning.
4. For plug-in equipment, the power outlet socket must be located near the equipment and must be easily accessible.
5. Keep this equipment away from humidity.
6. Put this equipment on a reliable surface during installation. Dropping it or letting it fall may cause damage.
7. The openings on the enclosure are for air convection. Protect the equipment from overheating. **DO NOT COVER THE OPENINGS.**
8. Make sure the voltage of the power source is correct before connecting the equipment to the power outlet.
9. Position the power cord so that people cannot step on it. Do not place anything over the power cord.
10. All cautions and warnings on the equipment should be noted.
11. If the equipment is not used for a long time, disconnect it from the power source to avoid damage by transient over-voltage.
12. Never pour any liquid into an opening. This may cause fire or electrical shock.
13. Never open the equipment. For safety reasons, the equipment should be opened only by qualified service personnel.
14. If one of the following situations arises, get the equipment checked by service personnel:
 15. The power cord or plug is damaged.
 16. Liquid has penetrated into the equipment.
 17. The equipment has been exposed to moisture.
 18. The equipment does not work well, or you cannot get it to work according to the user's manual.
 19. The equipment has been dropped and damaged.
 20. The equipment has obvious signs of breakage.
21. **DO NOT LEAVE THIS EQUIPMENT IN AN ENVIRONMENT WHERE THE STORAGE TEMPERATURE MAY GO BELOW -10° C (-4° F) OR ABOVE 55° C (140° F). THIS COULD DAMAGE THE EQUIPMENT. THE EQUIPMENT SHOULD BE IN A CONTROLLED ENVIRONMENT.**
22. **CAUTION: DANGER OF EXPLOSION IF BATTERY IS INCORRECTLY REPLACED. REPLACE ONLY WITH THE SAME OR EQUIVALENT TYPE RECOMMENDED BY THE MANUFACTURER, DISCARD USED BATTERIES ACCORDING TO THE MANUFACTURER'S INSTRUCTIONS.**
23. The sound pressure level at the operator's position according to IEC 704-1:1982 is no more than 70 dB (A).

DISCLAIMER: This set of instructions is given according to IEC 704-1. Advantech disclaims all responsibility for the accuracy of any statements contained herein.

Wichtige Sicherheitshinweise

1. Bitte lesen sie sich diese Hinweise sorgfältig durch.
2. Heben Sie diese Anleitung für den späteren Gebrauch auf.
3. Vor jedem Reinigen ist das Gerät vom Stromnetz zu trennen. Verwenden Sie keine Flüssig- oder Aerosolreiniger. Am besten dient ein angefeuchtetes Tuch zur Reinigung.
4. Die Netzanschlusssteckdose soll nahe dem Gerät angebracht und leicht zugänglich sein.
5. Das Gerät ist vor Feuchtigkeit zu schützen.
6. Bei der Aufstellung des Gerätes ist auf sicheren Stand zu achten. Ein Kippen oder Fallen könnte Verletzungen hervorrufen.
7. Die Belüftungsöffnungen dienen zur Luftzirkulation die das Gerät vor Überhitzung schützt. Sorgen Sie dafür, daß diese Öffnungen nicht abgedeckt werden.
8. Beachten Sie beim Anschluß an das Stromnetz die Anschlußwerte.
9. Verlegen Sie die Netzanschlusbleitung so, daß niemand darüber fallen kann. Es sollte auch nichts auf der Leitung abgestellt werden.
10. Alle Hinweise und Warnungen die sich am Geräten befinden sind zu beachten.
11. Wird das Gerät über einen längeren Zeitraum nicht benutzt, sollten Sie es vom Stromnetz trennen. Somit wird im Falle einer Überspannung eine Beschädigung vermieden.
12. Durch die Lüftungsöffnungen dürfen niemals Gegenstände oder Flüssigkeiten in das Gerät gelangen. Dies könnte einen Brand bzw. elektrischen Schlag auslösen.
13. Öffnen Sie niemals das Gerät. Das Gerät darf aus Gründen der elektrischen Sicherheit nur von autorisiertem Servicepersonal geöffnet werden.
14. Wenn folgende Situationen auftreten ist das Gerät vom Stromnetz zu trennen und von einer qualifizierten Servicestelle zu überprüfen:
 15. Netzkabel oder Netzstecker sind beschädigt.
 16. Flüssigkeit ist in das Gerät eingedrungen.
 17. Das Gerät war Feuchtigkeit ausgesetzt.
 18. Wenn das Gerät nicht der Bedienungsanleitung entsprechend funktioniert oder Sie mit Hilfe dieser Anleitung keine Verbesserung erzielen.
 19. Das Gerät ist gefallen und/oder das Gehäuse ist beschädigt.
 20. Wenn das Gerät deutliche Anzeichen eines Defektes aufweist.
21. **VORSICHT:** Explosionsgefahr bei unsachgemäßen Austausch der Batterie. Ersatz nur durch denselben oder einem vom Hersteller empfohlene-männlichen Typ. Entsorgung gebrauchter Batterien nach Angaben des Herstellers.
22. **ACHTUNG:** Es besteht die Explosionsgefahr, falls die Batterie auf nicht fachmännische Weise gewechselt wird. Verfangen Sie die Batterie nur gleicher oder entsprechender Type, wie vom Hersteller empfohlen. Entsorgen Sie Batterien nach Anweisung des Herstellers.
23. Der arbeitsplatzbezogene Schalldruckpegel nach DIN 45 635 Teil 1000 beträgt 70dB(A) oder weniger.

Haftungsausschluss: Die Bedienungsanleitungen wurden entsprechend der IEC-704-1 erstellt. Advantech lehnt jegliche Verantwortung für die Richtigkeit der in diesem Zusammenhang getätigten Aussagen ab.

Safety Precaution - Static Electricity

Follow these simple precautions to protect yourself from harm and the products from damage.

- To avoid electrical shock, always disconnect the power from your PC chassis before you work on it. Don't touch any components on the CPU card or other cards while the PC is on.
- Disconnect power before making any configuration changes. The sudden rush of power as you connect a jumper or install a card may damage sensitive electronic components.

Product Labelling



Contents

Chapter 1	Introduction.....	1
1.1	Welcome	2
1.2	About this Manual	2
1.3	System Specifications	3
	Table 1.1: System Specifications	3
1.4	Environmental Standards.....	4
	Table 1.2: Environmental Standards	4
Chapter 2	Getting Started.....	5
2.1	Check the Package	6
	Figure 2.1 Mars 3100R/S and Accessories	6
2.2	General Views of the Tablet PC	7
2.2.1	Tablet front view.....	7
	Figure 2.2 Front view	7
2.2.2	Tablet back view	7
	Figure 2.3 Back view	7
2.2.3	Tablet front edge view.....	8
	Figure 2.4 Front edge view	8
2.2.4	Tablet back edge view	8
	Figure 2.5 Rear edge view.....	8
2.2.5	Tablet right edge view.....	8
	Figure 2.6 Right edge view	8
2.2.6	Tablet left edge view	8
	Figure 2.7 Left edge view	8
2.3	LED Signals	9
	Figure 2.8 Status LEDs.....	9
2.3.1	Power ON/OFF LED	9
2.3.2	Battery status LED:	9
2.3.3	HDD status LED:.....	10
2.3.4	Wireless LAN ON/OFF LED:.....	10
2.4	Buttons	11
	Figure 2.9 Buttons on the front bezel.....	11
2.4.1	Key button.....	11
2.4.2	Display rotation button	11
2.4.3	5-way navigation button	11
2.4.4	Hotkey buttons	11
2.5	Powering the tablet PC	12
2.5.1	Battery Power	12
	Figure 2.10 Inserting the battery pack	12
	Figure 2.11 Replacing the screws	12
	Figure 2.12 Inserting the DC jack	13
2.5.2	AC Power.....	14
2.6	Starting the tablet PC.....	14
	Figure 2.13 Auto touchscreen calibration	14
2.7	Manual Touchscreen Calibration	15
	Figure 2.14 Accessing the Configuration Utility	15
	Figure 2.15 Calibrating the touchscreen.....	15
	Figure 2.16 4 points calibration.....	15
	Figure 2.17 Draw test	16
2.8	Using the Pen.....	17
	Figure 2.18 Using the pen	17
2.9	Connecting Peripherals.....	18
2.9.1	USB ports.....	18

	Figure 2.19	USB port.....	18
2.9.2	COM ports		18
	Figure 2.20	COM port.....	18
2.9.3	Audio jacks		19
	Figure 2.21	Audio Jacks (Red: input and Green: output)	19
2.9.4	VGA port.....		19
	Figure 2.22	VGA port.....	19
2.9.5	LAN port.....		20
	Figure 2.23	LAN port	20
2.10	Setting the Time and Date		20
2.11	Power Management.....		20
	2.11.1	Suspend.....	20
	2.11.2	Resuming.....	21

Chapter 3 Advantech Central Manager 23

3.1	Overview		24
	Figure 3.1	Central manager icons	24
	Figure 3.2	Copyright page	24
3.2	Display		25
3.2.1	Rotation		25
	Figure 3.3	Display menu.....	25
	Figure 3.4	Vertical display mode	25
	Figure 3.5	Horizontal display mode	26
3.2.2	Rotation button		26
3.2.3	Properties		26
	Figure 3.6	Display properties menu.....	26
3.2.4	Brightness adjustments (MARS-3100R only)		27
	Figure 3.7	Brightness adjustment.....	27
3.3	Using Hotkey Buttons		28
	Figure 3.8	Three hotkey buttons.....	28
	Figure 3.9	Hotkey menu	28
3.4	Power.....		29
	Figure 3.10	Power menu	29
3.4.1	Power button settings		29
3.4.2	Advanced Power settings		31
	Figure 3.11	Advanced power settings	31
	Figure 3.12	Six power schemes	31
	Figure 3.13	Power alarm options.....	33
	Figure 3.14	Low battery alarm options	33
	Figure 3.15	Run a program configuration dialog boxes.....	34
	Figure 3.16	Critical battery alarm options.....	34
	Figure 3.17	Power meter	35
	Figure 3.18	Detailed battery information	35
	Figure 3.19	Advanced power-saving	36
	Figure 3.20	Hibernate.....	37
3.5	Image Version.....		38
	Figure 3.21	Image version.....	38
3.6	Audio.....		39
	Figure 3.22	Main audio menu.....	39
3.6.1	Sounds and Audio Devices Properties		39
	Figure 3.23	Audio menu	40
	Figure 3.24	Volume and advanced buttons.....	40
	Figure 3.25	Playback volume control	40
	Figure 3.26	Speaker properties	41
	Figure 3.27	Performance properties.....	41
	Figure 3.28	Sound recording menu	42
	Figure 3.29	Recording controls	42
	Figure 3.30	Advanced controls for microphone.....	42

	Figure 3.31	MIDI music playback	42
	Figure 3.32	Volume menu	43
	Figure 3.33	Speaker volume.....	43
	Figure 3.34	Sounds menu	44
	Figure 3.35	Voice menu.....	45
	Figure 3.36	Hardware test for microphone level.....	45
	Figure 3.37	Hardware menu	46
	Figure 3.38	General menu.....	46
	Figure 3.39	Properties menu	47
	Figure 3.40	Driver menu	47
	Figure 3.41	Driver details.....	47
3.7	Touch		48
	Figure 3.42	Touch menu.....	48
3.7.1	Touchscreen		48
	Figure 3.43	Touchscreen calibration	48
	Figure 3.44	Digitizer Calibration Step 1	49
	Figure 3.45	Digitizer Calibration Step 2.....	49
	Figure 3.46	Digitizer Calibration Step 3.....	49
	Figure 3.47	Digitizer Calibration Step 4	49
	Figure 3.48	Touchkit USB controller.....	50
	Figure 3.49	Pen tablet properties menu	50
3.7.2	Mouse		51
	Figure 3.50	Buttons menu	51
	Figure 3.51	Pointers menu	52
	Figure 3.52	Pointer options menu.....	52
	Figure 3.53	Mouse hardware menu.....	53
	Figure 3.54	General USB properties	53
	Figure 3.55	USB driver properties	54
	Figure 3.56	USB power management	54
3.8	LAN		55
3.8.1	Properties.....		55
	Figure 3.57	Network connections	55
3.9	Security		56
	Figure 3.58	Security menu.....	56
	Figure 3.59	Security center.....	56

Chapter 4 Maintenance and Troubleshooting ..57

4.1	Care, Storage and Cleaning.....	58	
4.1.1	Protect the computer from damage	58	
4.1.2	Maintain good connections	58	
4.1.3	Prevent thermal stress	58	
4.1.4	Storing the computer.....	58	
4.1.5	Caring for the touchscreen display	58	
4.1.6	Cleaning the computer.....	59	
4.2	Replacing Components.....	60	
4.2.1	Battery.....	60	
	Figure 4.1	Removing the battery pack.....	60
4.2.2	HDD (or CF card).....	61	
	Figure 4.2	HD / CF Card Port	61
	Figure 4.3	Hard Disk Drive	61
	Figure 4.4	CF card.....	61
	Figure 4.5	Correct Removal of the HDD.....	62
	Figure 4.6	Incorrect removal of the HDD	62
	Figure 4.7	Unplugging the cable connector	62
	Figure 4.8	Removing the CF card.....	63
4.3	Troubleshooting	64	
4.3.1	Computer will not start	64	
4.3.2	Computer does not resume operation after suspension	64	

4.3.3	Computer will not enter into suspension mode.....	64
4.3.4	Computer will not shut down.....	64
4.3.5	Display remains off, or is not bright	64
4.3.6	Computer touchscreen does not respond to the pen.....	64
4.3.7	Headphones do not emit, or volume is too low.....	64
4.3.8	Peripherals do not respond.....	64
4.3.9	The amber battery status LED is always on	65
4.3.10	The amber battery status LED is blinking	65
4.3.11	The amber battery status LED is blinking quickly	65
4.4	OS System Maintenance and Re-Installation	66
4.4.1	MARS-3100S.....	66
4.4.2	MARS-3100R.....	66
	Figure 4.9 Welcome to Windows XP	66
	Figure 4.10 XP setup icon	67
	Figure 4.11 Install Windows XP.....	67

Appendix A GPRS Setting..... 69

A.1	Setting Up the Modem	70
A.2	Setting Up an Internet Connection.....	74
A.3	Connect to the Internet by GPRS	78

INDEX

Chapter 1

Introduction

This chapter gives basic data about the specifications and use of the MARS-3100R/S Tablet PC.

Sections include:

- Welcome
- About this Manual
- System Specifications
- Environmental Standards

1.1 Welcome

Congratulations on selecting the MARS-3100R/S Rugged Tablet PC, supported by Microsoft Windows® XP Embedded. This unique tablet PC offers a special combination of features that make it an ideal partner for a wide range of applications.

The main features of the MARS-3100R/S are:

- AMD® LX800, 500MHz, or Intel® Pentium Duo® Core Ultra Low Voltage U2500 1.2Ghz
- Graphical performance: AMD LX800 built-in, or Intel 945GME
- 10.4" SVGA / XGA TFT monitor built-in
- 2.5" shock mounted HDD or Industrial CF card for storage
- Internal mini-PCI and SmartBay (optional GSM/GPRS)
- 5-way navigation key and 3 programmable function keys
- Multiple I/O ports: 2x USB2.0, (1x USB 2.0 for MARS-3100S), 1x COM, 1x LAN and 1x VGA
- Full-featured Hi-resolution audio support with audio jacks and an integrated speaker

1.2 About this Manual

The following chapters contained in this manual are:

- **Chapter 1: Introduction** - General information about the tablet PC.
- **Chapter 2: Getting Started** - Basic functions of the tablet PC.
- **Chapter 3: The Central Manager** - Using the system management software included with the tablet PC.
- **Chapter 4: Maintenance and Troubleshooting** - How to maintain, calibrate and replace components; a troubleshooting FAQ details how to diagnose and correct typical problems.
- **Appendix A: GPRS Setting** - How to set up the GPRS software connection for the MARS-3100R/S.

1.3 System Specifications

The MARS-3100R/S meets the following specifications. Unless otherwise noted, all the specifications listed below are subject to change without prior notification.

Table 1.1: System Specifications		
Features	MARS-3100S	MARS-3100R
OS	MS XP Embedded	MS XP Professional
Dimension W × D × H	293 x 210 x 38mm	
Weight	2.1 kg	
Panel	10.4" SVGA TFT	10.4" XGA TFT (Sunlight readable option)
Touchscreen	Resistant touchscreen	Digitizer / Resistant touchscreen
CPU	AMD LX800 500MHz	Intel Pentium Duo Core Ultra Low Voltage U2500 1.2Ghz
DRAM	256/512MB DDR400 (One memory module support)	1GB DDRII533 (One memory module support)
L2 cache	128 K	1 MB
Chipset	AMD CS5536	Intel 945GME
Graphic	AMD LX800 with shared memory	Intel 945GME with shared memory
Storage	4G CF (2.5" shock mounted HDD option)	2.5" shock mounted HDD (CF stor- age option)
Keypad	5-way navigation key; 3x function key (programmable)	
Communication and Navigation		
Wireless	802.11 a/b/g	
WAN	SmartBay option GSM/GPRS/EDGE	
PAN	Bluetooth V2.0/EDR (optional)	Bluetooth V2.0/EDR (default)
I/O		
Microphone Jack	Yes	
Headset Jack	Yes	
RS232	Yes (COM 3)	
USB	USB2.0 x 1	USB2.0 x 2
RJ-45	10/100 Base-T	
DC-in	Yes	
VGA D_sub connector	Yes	
Docking / Port Replicator	Yes	
Audio		
AC97 Audio I/F	AC97 Audio I/F	HD Audio I/F
Speaker	One integrated speaker	
Power		
Battery	Removable 11.1V@3600mAh Li-ion battery pack; warm swap- pable	
Battery Life	3 hour battery life	
Charging Time	2.5 hours to 90%	
Backup Battery	7.2V, 120mAh	
Adapter	Auto-switching 100-240V, 50 ~60 Hz; supplies 19VDC at 3.42A	

1.4 Environmental Standards

Table 1.2: Environmental Standards

Environmental Operational Parameters		
Operation Temperature	0° C to 50° C (MIL-STD 810F Methods 501.4 and 502.4)	-10° C to 55° C* * Battery mode: 0° C @ 50% Battery capacity. * Adapter mode: Any
Storage Temperature	-20° C to 60° C (MIL-STD 810F Methods 501.4 and 502.4)	-40° C to 75° C
Thermal Shock	1.5° C < 5° C / minute over 0° C to 50° C verified during MILSTD810F testing	1.5° C < 5° C / minute over -10° C to 55° C verified during MILSTD810F testing
Operational Humidity	0% to 95% non-condensing MIL-STD810F Method 507.4	
Storage Humidity	0% to 95% non-condensing MIL-STD810F Method 507.4	
IP Rating	IP-54	
Drop	3 foot high free drop survival limit, (test surface: concrete, base unit only). According to MIL-STD-810F, Method 516.5	
Shock and Pressure		
Mechanical Shock	20g, 11ms, Terminal sawtooth, operating. 40g, 11ms, Terminal sawtooth, non-operating MIL-STD-810F method 516.5	
Vibration	- Operation By CF: MIL-STD 810F Methods 514.5C-3 By HDD: MIL-STD 810F Methods 514.5C-1 - Non-operation 0.04g ² /Hz, 20Hz - 1000Hz, -6dB/octave 1000Hz - 2000Hz, MIL- STD-810F method 514.5C-17	
Low Pressure	-15,000 ft.: in accordance with MIL-STD810F; Method 500.4, Procedure I	
Agency Approvals		
EMC	- EN55022 Class B - EN55011 Class A - FCC Part15 Class B - DOC Class B	
EMS	- Contact: 4Kv/ Air: 8Kv, EN55024	
Safety	- UL / cUL, UL60950-1 - CB, IEC/EN60950-1	

Chapter 2

Getting Started

This chapter details basic functions of the tablet PC and how to use it for the first time.

Sections include:

- Check the Package
- General Views of the Tablet PC
- LED Indicator Signal Table
- Powering the tablet PC
- Starting the tablet PC
- Manual Touchscreen Calibration
- Using the Pen
- Connecting Peripherals
- Setting the Time and Date
- Power Management
- Resetting System Defaults
- Disposing of Used Batteries

2.1 Check the Package

Each new MARS-3100R/S comes equipped with a range of product accessories and materials.

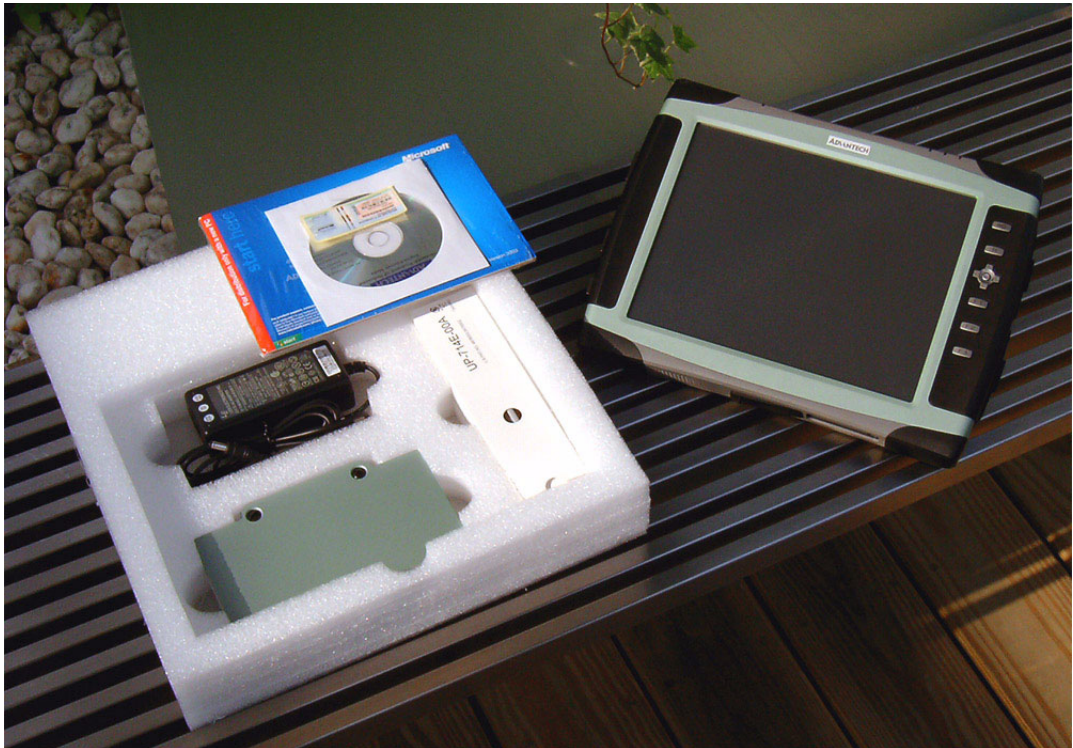

Figure 2.1 Mars 3100R/S and Accessories

A summary of the package contents:

- MARS-3100R/S
- Battery pack
- Adapter
- Pen (for MARS-3100S) or Digitizer Pen (for MARS-3100R)
- Windows XP Professional Recovery Media CD (for MARS-3100R)
- Quick start guide

2.2 General Views of the Tablet PC

2.2.1 Tablet front view

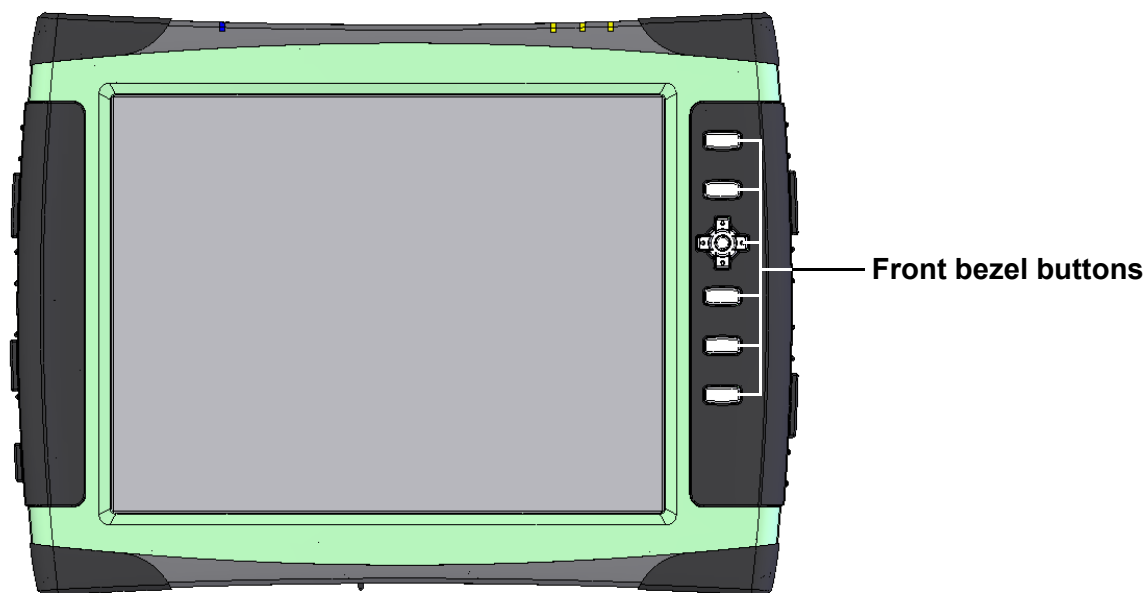

Figure 2.2 Front view

2.2.2 Tablet back view

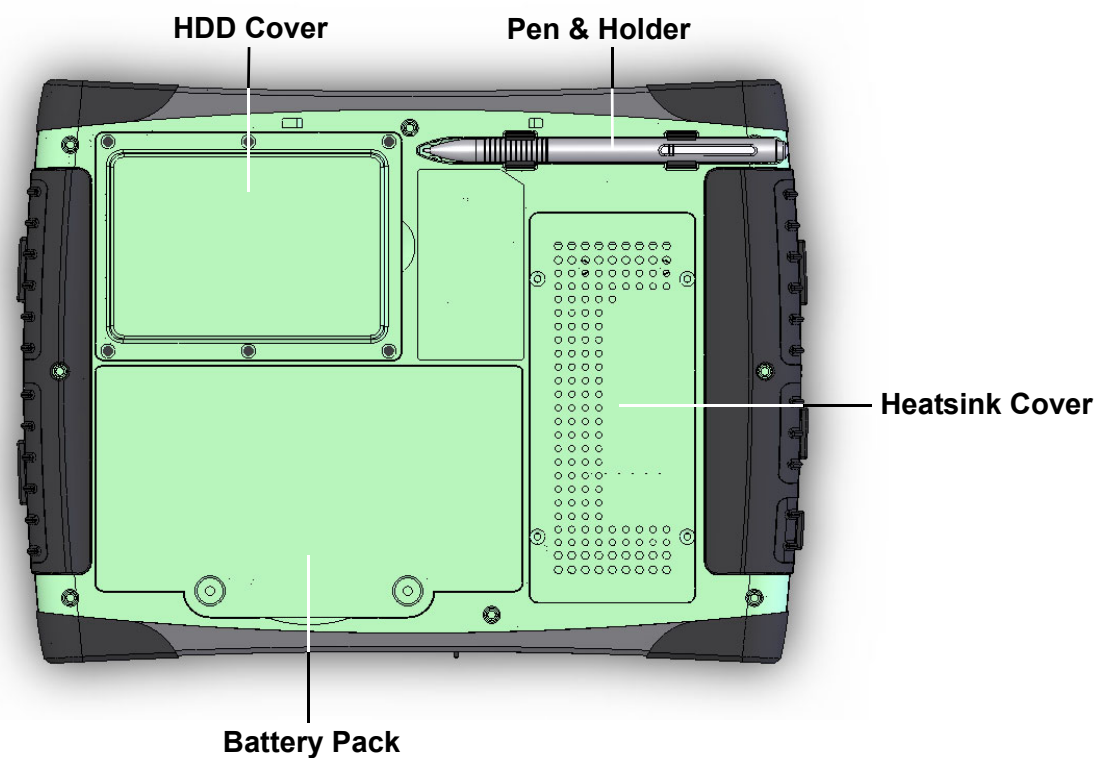

Figure 2.3 Back view

2.2.3 Tablet front edge view

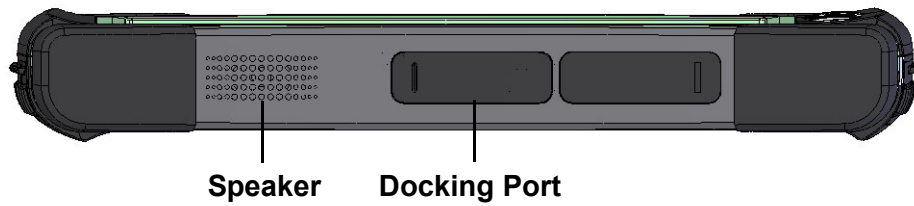

Figure 2.4 Front edge view

2.2.4 Tablet back edge view

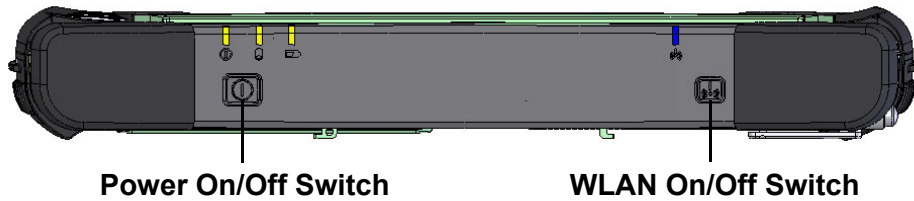

Figure 2.5 Rear edge view

2.2.5 Tablet right edge view

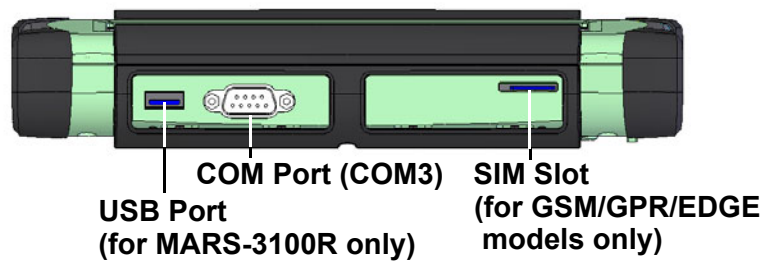

Figure 2.6 Right edge view

2.2.6 Tablet left edge view

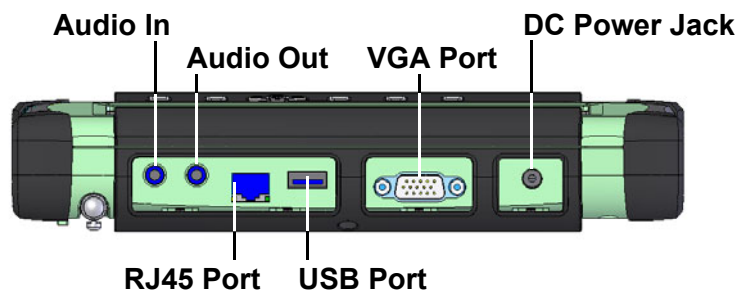

Figure 2.7 Left edge view

2.3 LED Signals

The MARS-3100R/S is equipped with a set of Light Emitting Diodes (LEDs) located along the top edge of the front bezel.

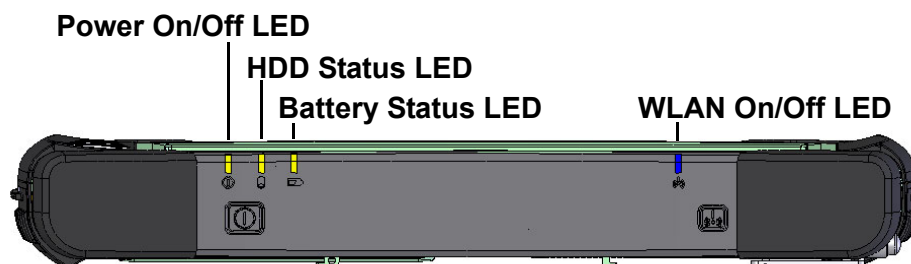

Figure 2.8 Status LEDs

2.3.1 Power ON/OFF LED

- **Dark:** System is turned OFF
- **Static Green:** System is turned ON.
- **Blinking Green:** System is in standby mode.

Note! See section 2.11.1 for more information about using Suspend Function.



2.3.2 Battery status LED:

- **Dark:**
 - Battery is fully charged (if the system is powered by adapter).
 - Battery capacity is sufficient and above the “Low Battery Alarm” (if the system is powered by battery).
(Default for the “Low Battery Alarm” is less than 10% of normal capacity.)
- **Static Amber:**
 - Battery is under-charging (if the system is powered by adapter).

Note! The Battery status LED will go off and become dark when the battery is fully charged (100%).



- **Blinking Amber:**
 - Battery is under 10% of normal capacity.

Note! 10% of total available battery power is the default value for triggering the low battery alarm. Users can change this value; refer to Chapter 3.4.2.2.



- **Quick Blinking Amber:**
 - Battery error. Replace the battery.

Note!

1. Battery errors indicate the temperature of the battery is out of acceptable range. Place the MARS-3100 in a normal environment.
2. The battery may be defective. Contact technical support office.



2.3.3 HDD status LED:

- **Dark:** HDD is idle.
- **Blinking:** HDD is active.

Note! *Prevent any shocks or vibrations whenever the HDD status LED is blinking. Violent shocks may cause damage to the HDD, and data loss.*



2.3.4 Wireless LAN ON/OFF LED:

- **Dark:** Wireless LAN is disabled
- **Static Green:** Wireless LAN is enabled

2.4 Buttons

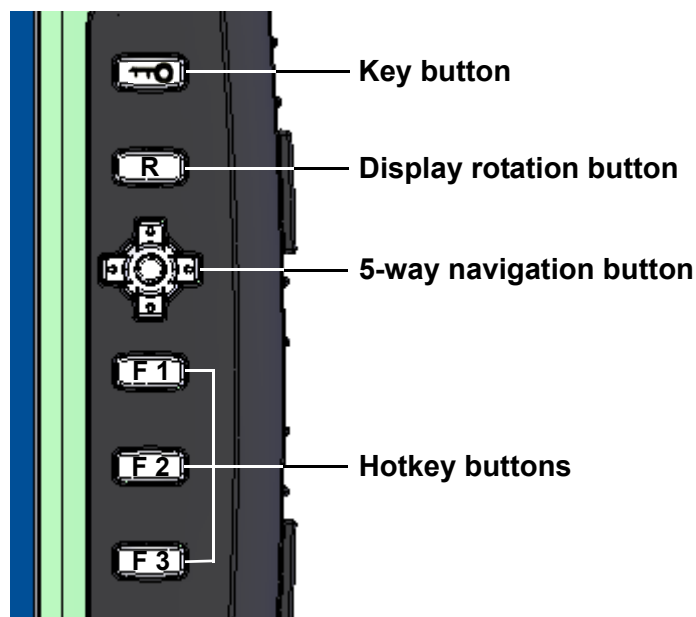

Figure 2.9 Buttons on the front bezel

2.4.1 Key button

The Key button functions as equivalent to the “Ctrl + Alt + Del” key combination under the MARS-3100S/R default OS environment, Windows XP Embedded or Windows XP Professional.

2.4.2 Display rotation button

The rotation button is the hotkey for rotating the display on the screen.

2.4.3 5-way navigation button

The 5-way navigation button function as directional arrow keys: “Up,” “Down,” “Right,” and “Left.” The navigation button is useful for navigating controls in various applications. Pressing the center part of the button is equivalent to hitting the “Enter” key.

2.4.4 Hotkey buttons

The F1 to F3 buttons are programmable hotkeys.

Note! See Chapter 3.2.2, 3.3 for more information about setting up hotkeys and using buttons.



2.5 Powering the tablet PC

2.5.1 Battery Power

The MARS-3100R/S tablet PC is supplied with a powerful rechargeable battery. To install and maintain the battery, or if it needs to be replaced, follow the instructions in this section.

Caution! Do not attempt to replace the battery with any others than the models recommended and manufactured specifically for this tablet PC.



Note! Before using MARS-3100 Tablet PC, please connect the adapter into MARS-3100R/S to charge the battery and backup battery at least 24Hrs.



2.5.1.1 Installing a Battery

The battery is designed specifically for installation with the MARS-3100R/S tablet PC. It fits exactly into the back of the PC and delivers precisely the exact voltage required to power the unit. Under normal conditions, a fully charged battery will power the PC for up to **3 hours**. Normally, it requires **2.5 hours** to fully charge a new battery.

- To install or replace the battery:
 1. Turn off the MARS-3100R/S
 2. Disconnect any peripheral devices from the MARS-3100R/S.
 3. Unfasten the two large flathead screws and remove the battery.
 4. Insert the new battery pack.

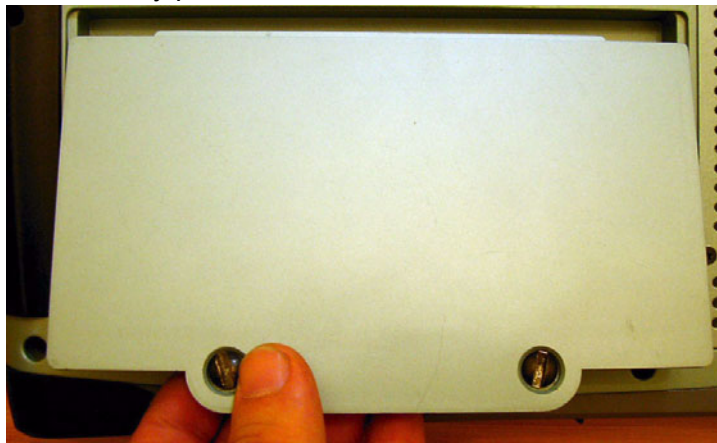

Figure 2.10 Inserting the battery pack

5. Fasten the two flathead battery cover screws.



Figure 2.11 Replacing the screws

2.5.1.2 Charging the battery using a power adapter

1. Connect the AC cord to a power source.
2. Plug the AC power cord into the receptacle on the DC power adapter.
3. Insert the DC jack into the receptacle on the left side of the tablet PC.

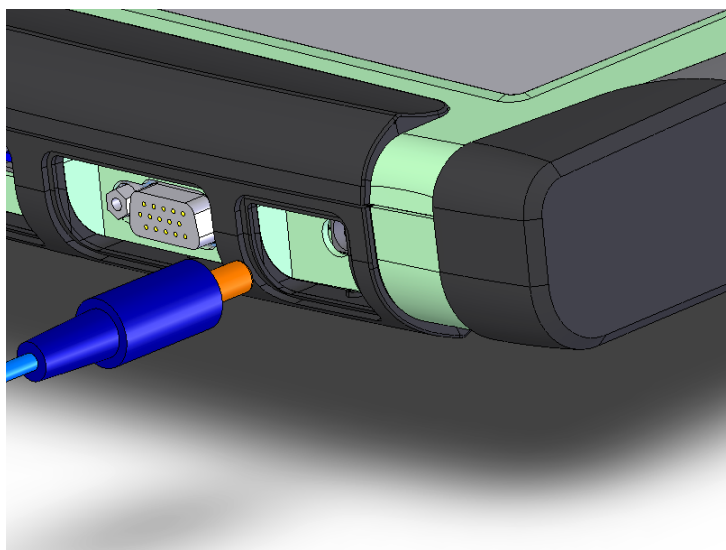

Figure 2.12 Inserting the DC jack

4. After inserting the DC jack, the LED indicator will light (RED) indicating that battery charging is functional and normal.

2.5.1.3 Swapping the battery pack

If the battery is exhausted, it can be hot-swapped for a fully charged battery without interrupting current work.

1. Get another fully charged battery on hand.
2. Save all current files and data.
3. Put the MARS-3100 into Standby Mode. (See 2.11.1)
4. Release the two large flathead screws and remove the battery.
5. Replace the battery and refasten the two large flathead screws.
6. Resume operation of the system. (See 2.11.2)

- Note!**
1. After removing the battery, the system will still be powered by an internal backup battery. It can maintain system power for only **3 minutes**.
 2. Before using the hot-swapped battery function, plug the adapter into MARS-3100R/S to charge the internal backup battery at least 24 hrs.

Caution! If more than 3 minutes duration elapses between Step 4 and Step 5, removing and replacing the battery, any unsaved data will be lost.



2.5.1.4 Disposing of Used Batteries

The battery supplied with the MARS-3100RS is a rechargeable, **Lithium Ion** dry cell. Dispose of used batteries in accordance with local government regulations. Under Federal, state, or local law, it may be illegal to put batteries in the trash. Contact your system administrator or the municipal solid waste disposal department for info. The battery should be delivered to a reputable recycler or governmental agency, which are adequately equipped to recycle the chemicals inside the battery. If the battery wears out, order a new one.

2.5.2 AC Power

The MARS-3100R/S can be powered exclusively with the supplied AC 19V adapter. It is not recommended to use any other adapter than the one supplied with the tablet PC.

2.6 Starting the tablet PC

1. Press the power button once to turn on the tablet PC.
2. After powering up for the first time, the system prompts the user to engage the touchscreen calibration.
3. Follow the onscreen instructions to calibrate the touchscreen.

Note! *The user may need to press the power button longer than 1 second for battery only mode.*



- Caution!**
1. *Don't press the button longer than 4 seconds; it will cause the MARS-3100R/S to shutdown immediately and crash data on the HDD.*
 2. *The Power LED will illuminate (Green) if the system is powered.*



Figure 2.13 Auto touchscreen calibration

2.7 Manual Touchscreen Calibration

1. To initiate touchscreen calibration manually, navigate via the *start* command and click on the icon, *Configuration Utility*.

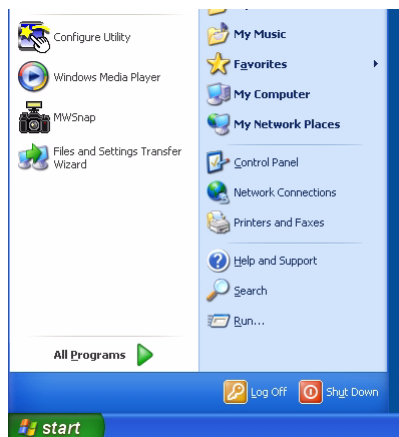

Figure 2.14 Accessing the Configuration Utility

2. In the *Tools* dialog, click on *4 Points Calibration* to align the touchscreen.

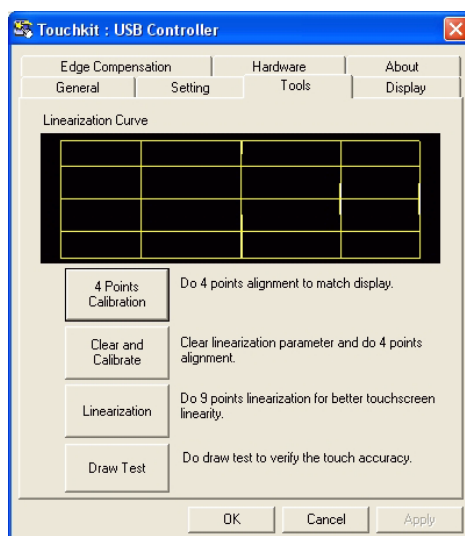

Figure 2.15 Calibrating the touchscreen

3. Follow the onscreen instructions to calibrate the touchscreen.



Figure 2.16 4 points calibration

- Return to the *Tools* dialog; select *Linearization for 9 points linearization*, and follow the onscreen instructions; then, return to the *Tools* dialog again and try the *Draw Test*.

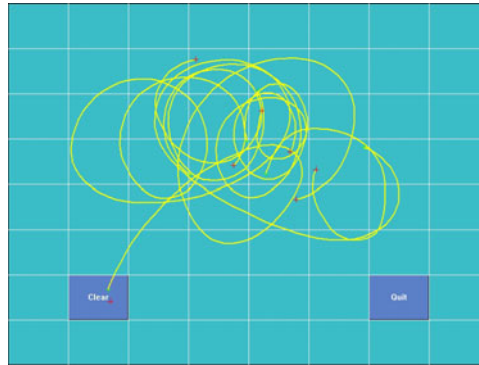

Figure 2.17 Draw test

2.8 Using the Pen

The touchscreen pen is a tool supplied with the MARS-3100R/S. It is used exclusively as a control device for the touchscreen. It resembles a regular ballpoint pen.

Instead of a regular onscreen cursor, the pen contacts the surface of the screen. Onscreen objects may be activated or moved with the pen. Whenever using the pen, do not press too hard on the touchscreen. Only moderate pressure is required to activate touchscreen sensors. The pen is configured to function much like an ordinary PC mouse.

- **Touch, hold and drag:** To move an object from one part of the screen to another, or to copy an object from the desktop to another memory device, place the tip of the pen onto the object and hold it while dragging the object across the screen to the desired location.
- **Double-click:** Tap the pen twice on an onscreen object to activate a program, or to open a selected folder.



Figure 2.18 Using the pen

2.9 Connecting Peripherals

The MARS-3100R/S supports several peripheral connections.

2.9.1 USB ports

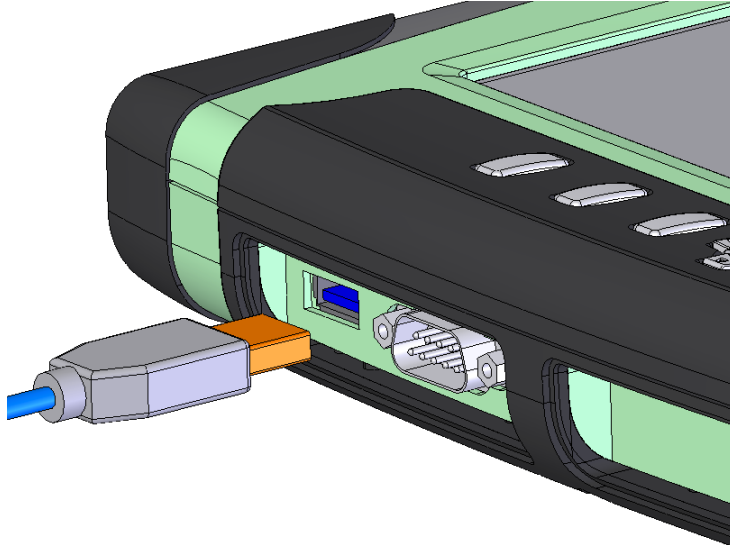

Figure 2.19 USB port

2.9.2 COM ports

The COM port of MARS-3100R/S is “COM3.”

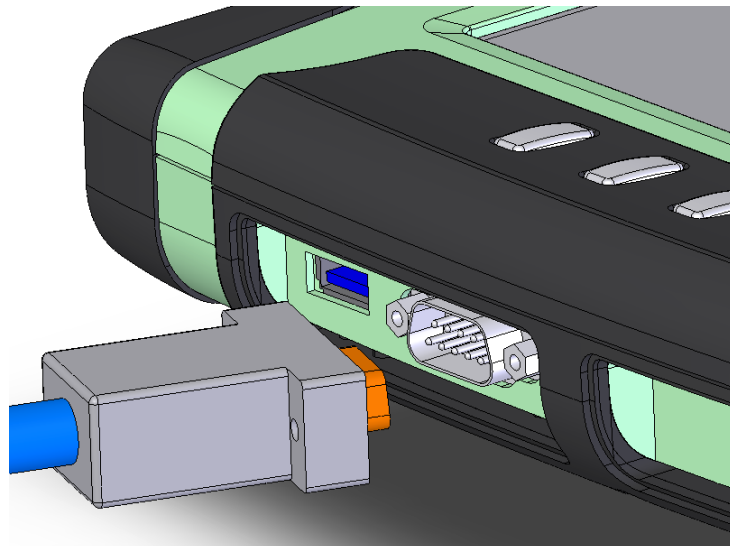

Figure 2.20 COM port

2.9.3 Audio jacks

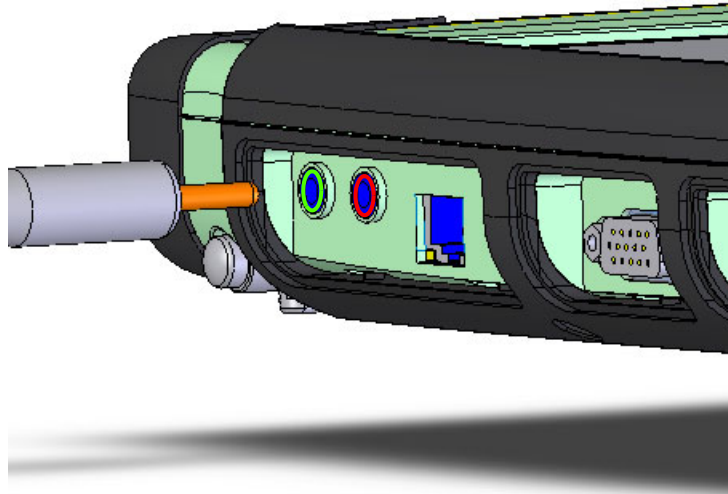

Figure 2.21 Audio Jacks (Red: input and Green: output)

2.9.4 VGA port

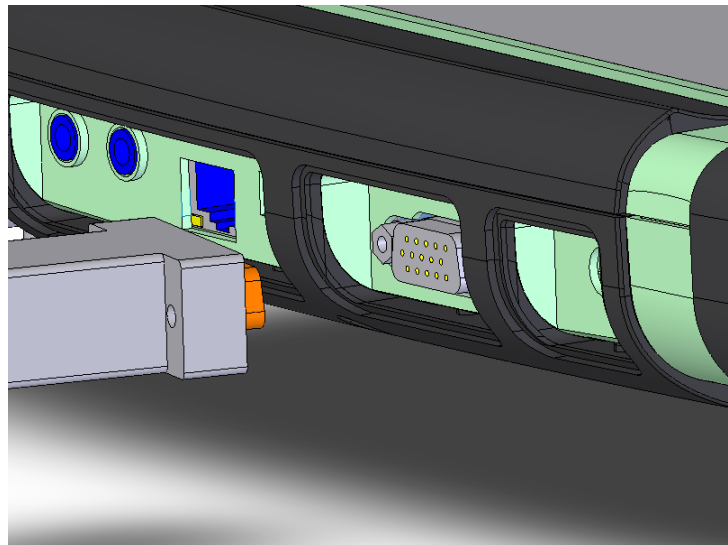

Figure 2.22 VGA port

2.9.5 LAN port

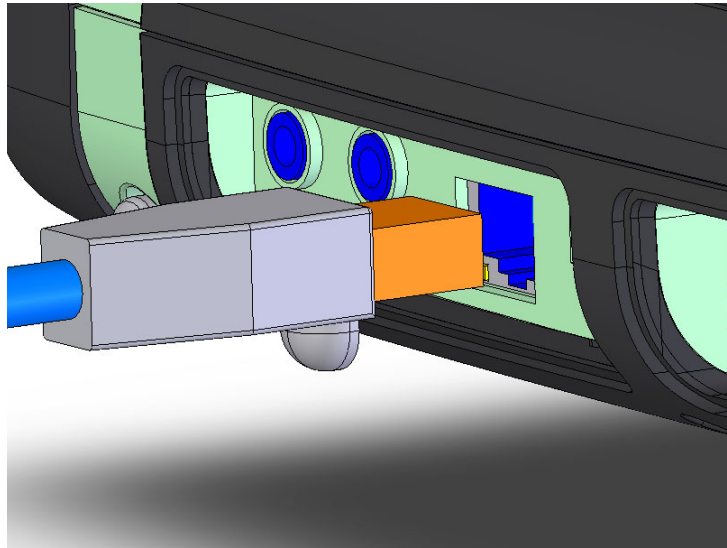

Figure 2.23 LAN port

2.10 Setting the Time and Date

Whenever the system timer is not matched with your location or time zone, please reset the time and date by following step:

1. Click **START > Control Panel**, or **START > Settings > Control panel**
2. Double click the **Date and Time Properties**.
3. Select the correct day, month and year.
4. Click **OK** to save and exit.

2.11 Power Management

2.11.1 Suspend

To save battery power, or when swapping battery packs, put the MARS-3100R/S into Suspend Mode. There are two suspend modes: Suspend-to-RAM (Standby mode) and Suspend to HDD (Hibernation mode).

1. Suspend-to-RAM (Standby mode)

Suspend-to-RAM occurs when a system enters a low-power state. Information on system configuration, open applications and active files are stored in the main memory. Most other system components are shut-off.

In this mode, although power consumption is very low, the battery may drain and cause data loss. If the MARS-3100R/S is stored for durations longer than a few hours or overnight, it is best simply to turn off the computer instead of using Suspend-to-RAM mode.

Note! *The Power LED blinks green. (See chapter 2.3.1)*



2. Suspend-to-Disk (Hibernation mode)

Instead of saving data temporarily to RAM, Suspend-to-Disk mode saves data on the hard disk. Also, power consumption is the same as the system is turn off. In this mode, all data will store in hard disk, so there is no risk to loss data if the battery is exhausted.

- Note!**
- *The Power LED will shut off.*
 - *Suspend to Disk mode will take much time to finish the data saving than Suspend to RAM. System will auto shutdown after all data is saved.*



2.11.2 Resuming

When the system is in suspend mode, press the power button once, and the system will resume to normal operation again.

- Note!** *It may be necessary to log-on again after the system has resumed.*



Chapter 3

Advantech Central Manager

This chapter explains how to use the Advantech Central Manager program application.

Sections include:

- Overview
- Display
- Hotkeys
- Power
- Image Version
- Audio
- Touch
- LAN
- Security

3.1 Overview

The **Advantech Central Manager** utility is configured settings, operate devices and adjust the MARS-3100R/S. The **Central Manager** provides user-friendly functions.

- **Display settings**
- **Screen resolutions**
- **Hotkey assignments**
- **Power management**
- **Audio & touchscreen controls**
- **LANs**
- **Network security**

The **Central Manager** utility is available from the **taskbar** in the bottom right corner of the **Windows** desktop. Double click the white and blue **A** icon. Access is also available from the **Control Panel**. (See *figure 3.1*)



System tray: double click

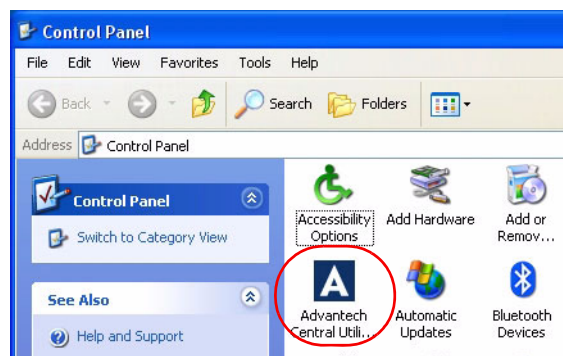

Figure 3.1 Central manager icons

The **Advantech Central Manager** displays a menu with several tabs, including the software **Copyright** page.

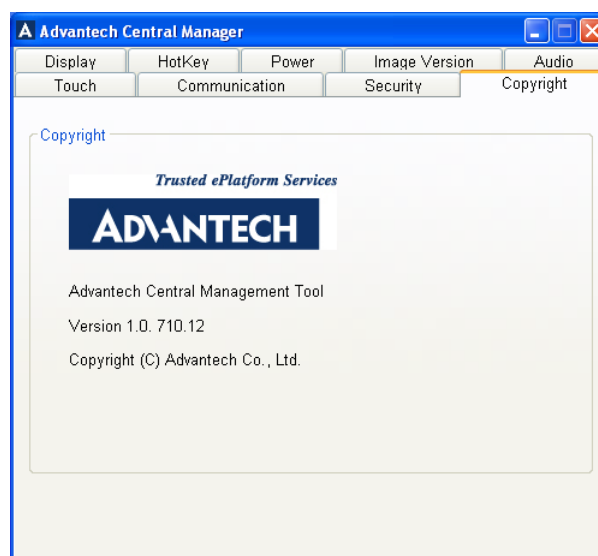

Figure 3.2 Copyright page

3.2 Display

3.2.1 Rotation

Users may change the orientation of the desktop display on MARS-3100R/S. In the **Display** menu, the **Rotation** control toggles *horizontal* (“landscape”) or *vertical* (“portrait”) display modes. The orientation of the display switches relative to the horizontal and vertical axis of the tablet PC.

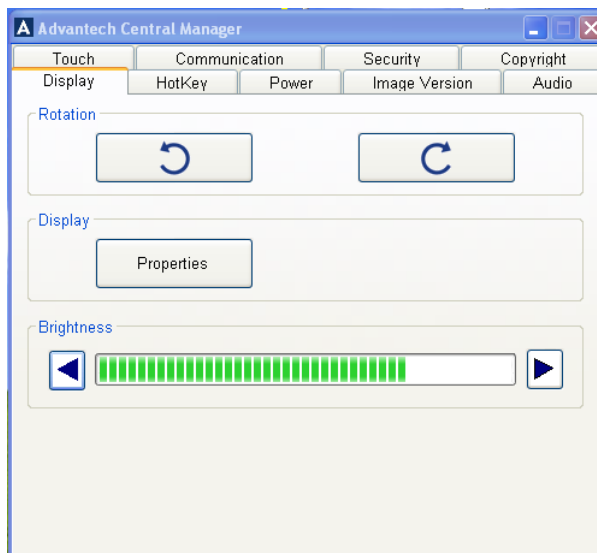



Figure 3.3 Display menu

Click **Left Rotation**  to switch the display to the vertical axis (portrait display mode). If the left rotation button is clicked again, the orientation rotates again in a counter-clockwise direction: vertical to horizontal to vertical to horizontal.

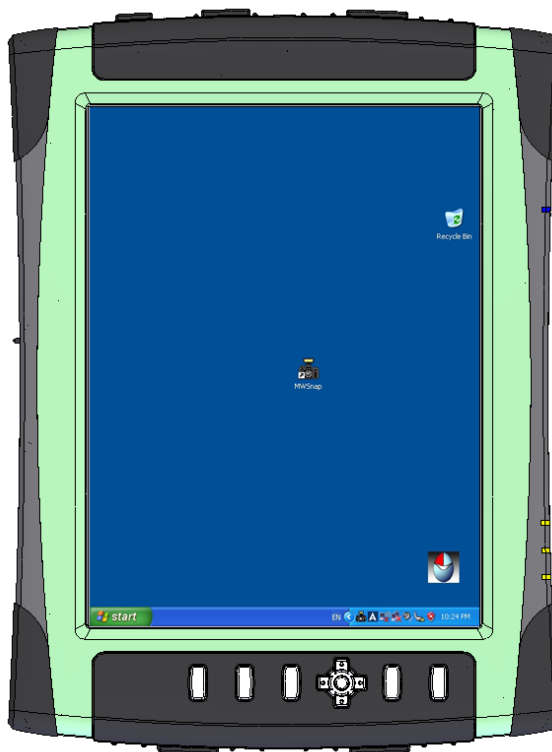

Figure 3.4 Vertical display mode

Click **Right Rotation**  to switch the display to the horizontal axis (landscape display mode). If the right rotation button is clicked again, the orientation rotates again in a clockwise direction: vertical to horizontal to vertical to horizontal.



Figure 3.5 Horizontal display mode

3.2.2 Rotation button

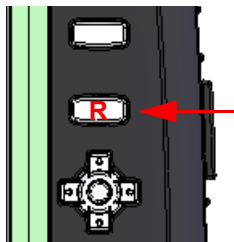

Users may quickly change the orientation of the display by clicking the **R** key, located on the upper right side of the bezel, second from the top.

3.2.3 Properties

Click **Properties** menu.



to open the **Windows Display Properties** menu.

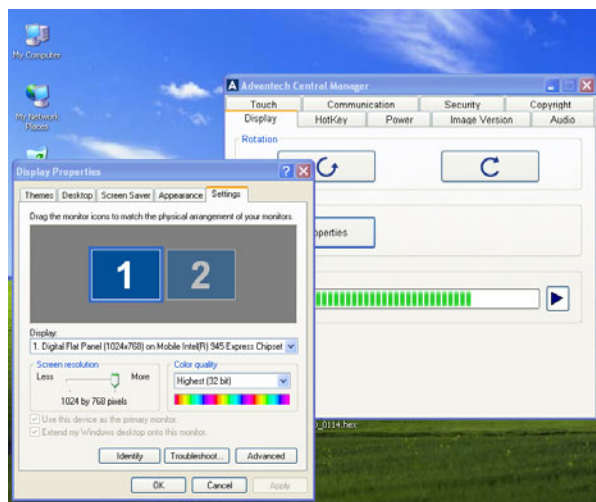

Figure 3.6 Display properties menu

3.2.4 Brightness adjustments (MARS-3100R only)

MARS-3100R has a brightness adjustment control feature. To adjust the intensity of the display, use the pen to **click right** for **brighter**, or **click left** for **darker**.

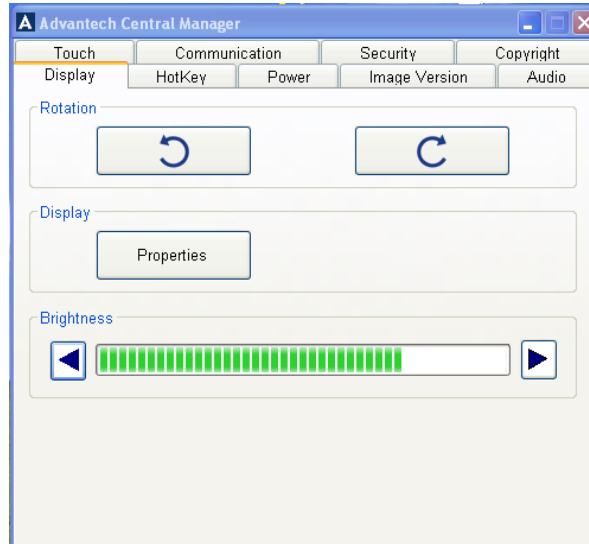
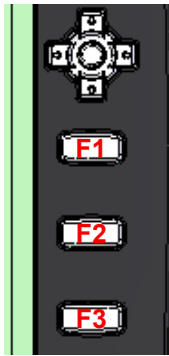

Figure 3.7 Brightness adjustment

3.3 Using Hotkey Buttons



The MARS-3100R/S features a handy hotkey command control system. Three F hotkey buttons are available on the front bezel. These keys may be set to open software applications instantly.

Figure 3.8 Three hotkey buttons

Select the **Hotkey** menu to configure hotkey-activated software applications.

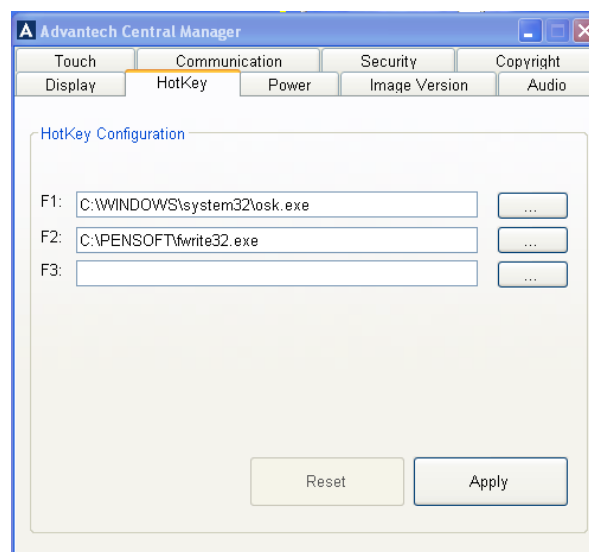
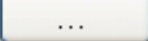



Figure 3.9 Hotkey menu

Click  to open a browser window. Search for, and select the required executable file, for example: "**osk.exe**." Then click **OK**.

Then press  to accept the change and load the hotkey assignments and software.

- Note!**
- The acceptable file format is **.exe**.
 - The default setting of F1 hotkey is **OSK (On Screen Keyboard)**. Users can reconfigure the F1 hotkey to other functions.
 - Pressing  restores the previous settings for the F1, F2 and F3 hotkeys.

3.4 Power

The **Power** menu sets up a variety of convenient power schemes, including precise configuration of the **power button** and low battery alarms.

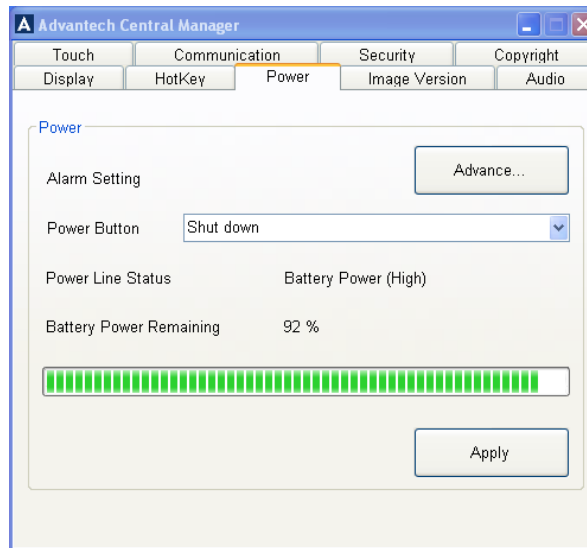
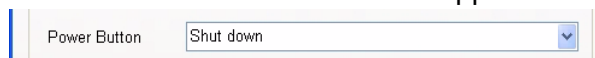

Figure 3.10 Power menu

3.4.1 Power button settings

The main **power button**, located on the top right side of the MARS-3100R/S, may be set to carry out four commands.

The **Power Button** command on the **Power** menu supports four options.



- **Do nothing**
- **Ask me what to do**
- **Standby**
- **Shut down** (the default setting)

3.4.1.1 Shut down

When **Shut down** is selected, pressing the main **power button** once results in an automatic system shut down. All applications are closed automatically and the unit powers off.

Note! *If **Shut down** is selected, all unsaved data will be lost when the system powers off.*



3.4.1.2 Do nothing

When **Do nothing** is selected, pressing the **power button** once has no effect on the operation of the computer.

In order to power off, return to the **Power** menu and reset the **Power Button** field to **Shut down**. Then, the MARS-3100R/S powers down using the **power button**.

Even if **Do nothing** is selected, it is always possible to shut down the computer by clicking **Shut Down** from the **Windows Start** menu.

3.4.1.3 Ask me what to do

When **Ask me what to do** is selected, the computer presents a **Shut Down Windows** menu and four command choices. Selecting the desired option and the command is carried out after **<Enter>** is pressed.

- **Log-off Administrator**
- **Shut down**
- **Restart**
- **Stand by**

3.4.1.4 Standby

When **Standby** is selected, pressing the **power button** places the computer into temporary hibernation and power-saving mode. In **Standby**, the screen goes blank, but all applications and current data are preserved in a steady-state. Pressing the **power button** again reactivates all systems, and restores the display and applications to the same state as they were before **Standby** was selected. By default, the user will be asked to re-enter log-on data to protect the security and integrity of the system.

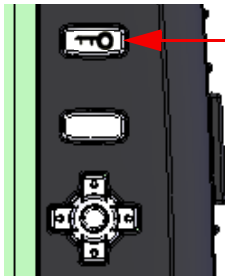

Pressing the **Key button** or the **Ctl-Alt-Del** key combo presents the **Sign-on** menu and the user must key-in log-on data.

3.4.2 Advanced Power settings

The MARS-3100R/S supports a variety of precise power settings.

- **Power Schemes**
- **Alarms**
- **Power Meter**
- **Advanced**
- **Hibernate**

Click **Advanced** on the main **Power** menu to open the **Power Options Properties** menu of the **Central Manager**.

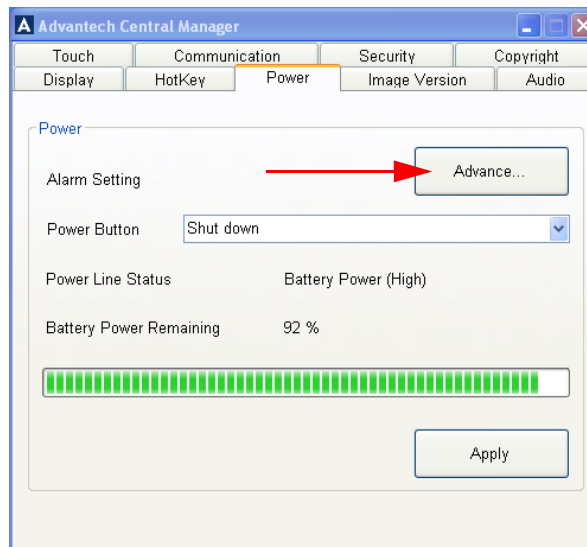

Figure 3.11 Advanced power settings

3.4.2.1 Power schemes

The first tab in **Power Options Properties** menu displays the **Power schemes** menu, which offers a selection of power options that are intended to conserve electricity or battery life whenever the computer is idle, but not completely shut-down.

Six **Power scheme** options are available; it is possible to modify and save the default settings of each scheme from these menus.

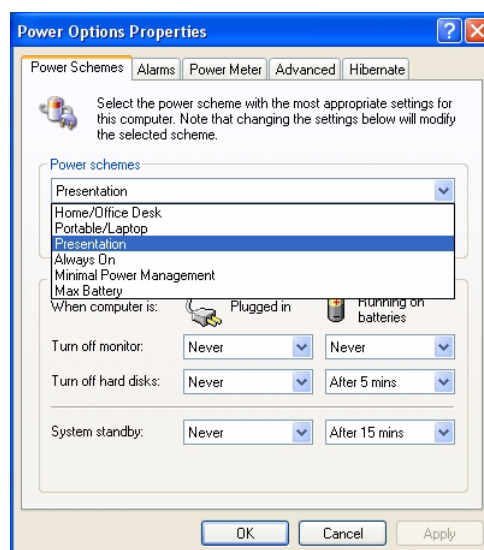

Figure 3.12 Six power schemes

3.4.2.1.1 Home/Office Desk

Selection defaults for this setting.

- **Turns off monitor:** After **20** minutes (Plugged in); After **5** minutes (Batteries)
- **Turns off hard disks:** **Never** (Plugged in); After **10** minutes (Batteries)
- **System Standby:** **Never** (Plugged in); After **5** minutes (Batteries)

3.4.2.1.2 Portable/Laptop

Selection defaults for this setting.

- **Turns off monitor:** After **15** minutes (Plugged in); After **5** minutes (Batteries)
- **Turns off hard disks:** After **30** minutes (Plugged in); After **5** minutes (Batteries)
- **System Standby:** After **20** minutes (Plugged in); After **5** minutes (Batteries)

3.4.2.1.3 Presentation

Selection defaults for this setting.

- **Turns off monitor:** **Never** (Plugged in); **Never** (Batteries)
- **Turns off hard disks:** **Never** (Plugged in); After **5** minutes (Batteries)
- **System Standby:** **Never** (Plugged in); After **15** minutes (Batteries)

3.4.2.1.4 Always on

Selection defaults for this setting.

- **Turns off monitor:** After **20** minutes (Plugged in); After **15** minutes (Batteries)
- **Turns off hard disks:** **Never** (Plugged in); After **30** minutes (Batteries)
- **System Standby:** **Never** (Plugged in); **Never** (Batteries)

3.4.2.1.5 Minimal power management

Selection defaults for this setting.

- **Turns off monitor:** After **15** minutes (Plugged in); After **5** minutes (Batteries)
- **Turns off hard disks:** **Never** (Plugged in); After **15** minutes (Batteries)
- **System Standby:** **Never** (Plugged in); After **5** minutes (Batteries)

3.4.2.1.6 Max battery

Selection defaults for this setting.

- **Turns off monitor:** After **15** minutes (Plugged in); After **1** minute (Batteries)
- **Turns off hard disks:** **Never** (Plugged in); After **3** minutes (Batteries)
- **System Standby:** After **20** minutes (Plugged in); After **2** minutes (Batteries)

3.4.2.2 Alarms

The second tab on the **Power Options Properties** menu displays the **Alarms** menu, which offers a selection of alarm options according to two basic categories.

- **Low battery alarm;** (default setting is 10%.)
- **Critical battery alarm;** (default setting is 3%.)

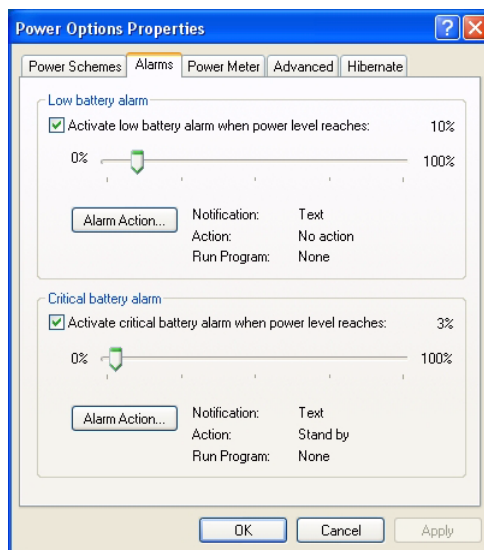

Figure 3.13 Power alarm options

3.4.2.2.1 Low battery alarm

By default, the low battery alarm is set to trigger when the battery reaches **10%** of its normal capacity. The alarm can be set to trigger according to any percentage of available battery power between 0% and 100%.

Selecting **Alarm action** summons the **Low battery alarm actions** sub-menu. The default action displays a message notifying of the low power condition.

- **Notification:** The user may change the alarm notification settings, choosing between **Sound alarm** or **Display message**, which is the system default.
- **Alarm action:** The user may select the **Alarm action** check box to instruct the system what to do when the low battery alarm sounds, which is either **Standby** or **Shut down**.

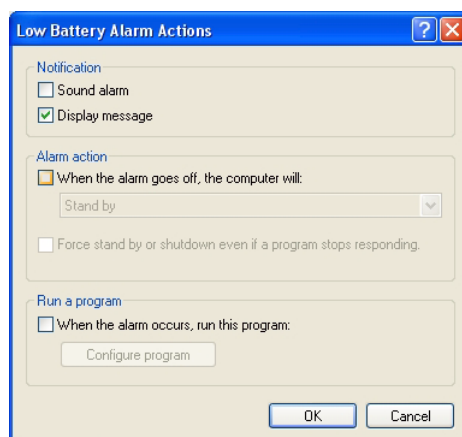

Figure 3.14 Low battery alarm options

- **Run a program:** Select the checkbox, **When the alarm occurs, run this program**. Then, users may choose **Configure program** automatically.
 - Three sub-menus are available for setting precise commands to manage the program.
 - **Task:** Select a program to activate when the low battery alarm triggers.
 - **Schedule:** Task programs may be activated according to the schedule required; from the **Advanced** sub-menu task programs may be reactivated instantly and configured to run for precise durations.
 - **Settings:** Three commands are available to refine the operation of task programs. These commands set-up what the computer will do after tasks are completed, or if the computer is idle, or if the unit is under battery power. The three settings include, **Scheduled Tasks Completed**, **Idle Time**, and **Power Management**.

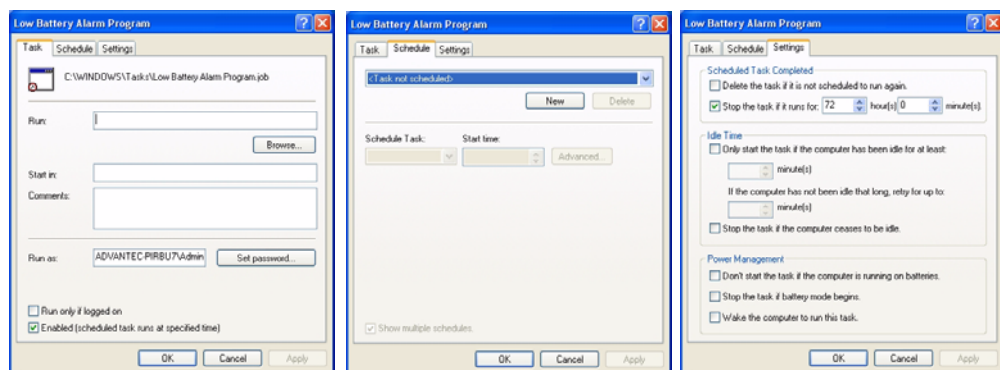

Figure 3.15 Run a program configuration dialog boxes

3.4.2.2.2 Critical battery alarm

By default, the critical battery alarm is set to trigger when the battery reaches 3% of its normal capacity. The alarm trigger may be changed to any percentage of available battery power between 0% and 100%.

- **Notification:** The user may change the alarm notification settings, choosing between **Sound alarm** or **Display message**, the system default.
- **Alarm Action:** The user may activate the **Alarm action** checkbox to instruct the system what to do when the low battery alarm sounds, which is either **Standby** or **Shut down**.

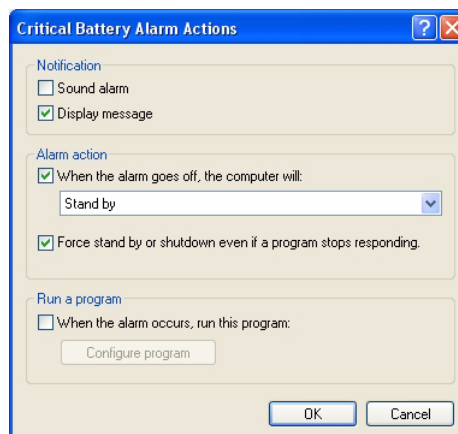

Figure 3.16 Critical battery alarm options

Run a program: By selecting the checkbox, *When the alarm occurs, run this program*, users may choose to *Configure program* automatically. (See section 3.4.2.2.1 above.)

3.4.2.3 Power Meter

The third tab on the **Power Options Properties** menu displays the advanced **Power Meter** menu, and provides information about the present status of the power system.

- **Current power source:** displays whether the computer is powered by AC or DC electricity.
- **Battery number:** Normally battery #1 is displayed.

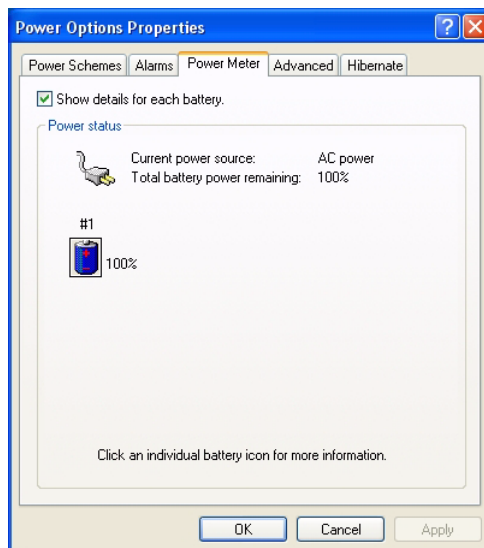



Figure 3.17 Power meter

Click **Battery number**,  to open a new dialog box: **Detailed information for Battery # 1** to access precise data about the type and status of the battery currently active in the unit.

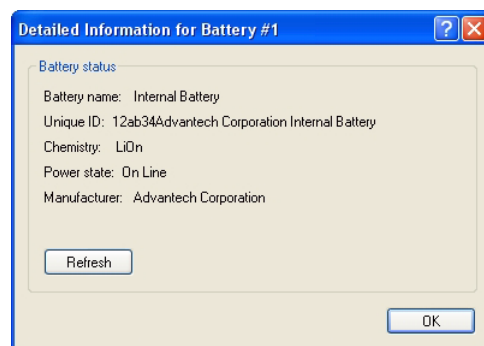

Figure 3.18 Detailed battery information

3.4.2.4 Advanced

The fourth tab on the **Power Options Properties** menu displays the **Advanced** power configuration options, which offer two main power-saving settings.

- **Options**
- **Power buttons**

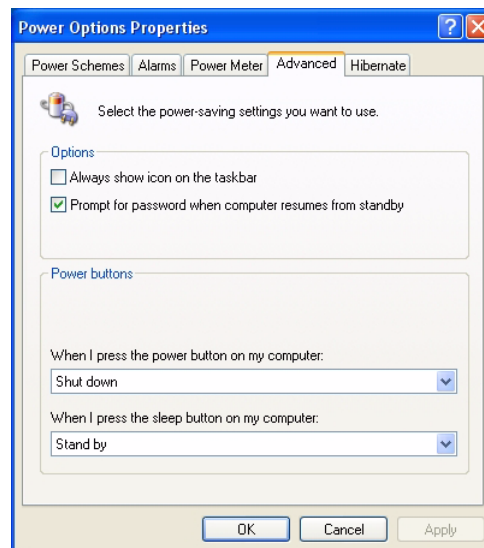



Figure 3.19 Advanced power-saving

3.4.2.4.1 Options

- Select the **Always show icon on the taskbar** check box to activate the **Power Meter** icon on the taskbar. 
 - Double-clicking the icon opens the **Power Meter** menu box, (See section 3.4.2.3 above.)
- By default, **Prompt for password when computer resumes from standby** is selected. This command ensures that unauthorized users cannot access the computer or its data.

3.4.2.4.2 Power buttons

To configure the **Power** and **Sleep** buttons, click on the drop-down box to select a command option for the following two buttons.

- **Power Button** options: **When I press the power button on my computer.**
 - Do nothing
 - Ask me what to do
 - Standby
 - Shut down (*default setting*)
- **Sleep Button** options:
 - No support "Sleep mode" (*default setting*)

Note! Normally, the **Power button** setting is accessed through the main Power menu. (See section: 3.4.1, Power Button Settings.)

