

TREK-550

Computing Box

Trusted ePlatform Services

ADVANTECH

Copyright

The documentation and the software included with this product are copyrighted 2010 by Advantech Co., Ltd. All rights are reserved. Advantech Co., Ltd. reserves the right to make improvements in the products described in this manual at any time without notice. No part of this manual may be reproduced, copied, translated or transmitted in any form or by any means without the prior written permission of Advantech Co., Ltd. Information provided in this manual is intended to be accurate and reliable. However, Advantech Co., Ltd. assumes no responsibility for its use, nor for any infringements of the rights of third parties, which may result from its use.

Acknowledgements

Intel and Atom are trademarks of Intel Corporation. Microsoft Windows and MS-DOS are registered trademarks of Microsoft Corp. All other product names or trademarks are properties of their respective owners.

Product Warranty (2 years)

Advantech warrants to you, the original purchaser, that each of its products will be free from defects in materials and workmanship for two years from the date of purchase.

This warranty does not apply to any products which have been repaired or altered by persons other than repair personnel authorized by Advantech, or which have been subject to misuse, abuse, accident or improper installation. Advantech assumes no liability under the terms of this warranty as a consequence of such events.

Because of Advantech's high quality-control standards and rigorous testing, most of our customers never need to use our repair service. If an Advantech product is defective, it will be repaired or replaced at no charge during the warranty period. For out-of-warranty repairs, you will be billed according to the cost of replacement materials, service time and freight. Please consult your dealer for more details.

If you think you have a defective product, follow these steps:

1. Collect all the information about the problem encountered. (For example, CPU speed, Advantech products used, other hardware and software used, etc.) Note anything abnormal and list any onscreen messages you get when the problem occurs.
2. Call your dealer and describe the problem. Please have your manual, product, and any helpful information readily available.
3. If your product is diagnosed as defective, obtain an RMA (return merchandise authorization) number from your dealer. This allows us to process your return more quickly.
4. Carefully pack the defective product, a fully-completed Repair and Replacement Order Card and a photocopy proof of purchase date (such as your sales receipt) in a shippable container. A product returned without proof of the purchase date is not eligible for warranty service.
5. Write the RMA number visibly on the outside of the package and ship it prepaid to your dealer.

Part No. 2010055001
Printed in Taiwan

Edition 1
May 2010

Declaration of Conformity

This product has passed the CE test for environmental specifications. Test conditions for passing included the equipment being operated within an industrial enclosure. In order to protect the product from being damaged by ESD (Electrostatic Discharge) and EMI leakage, we strongly recommend the use of CE-compliant industrial enclosure products.

FCC Class B

Note: This equipment has been tested and found to comply with the limits for a Class B digital device, pursuant to part 15 of the FCC Rules. These limits are designed to provide reasonable protection against harmful interference in a residential installation. This equipment generates uses and can radiate radio frequency energy and, if not installed and used in accordance with the instructions, may cause harmful interference to radio communications. However, there is no guarantee that interference will not occur in a particular installation. If this equipment does cause harmful interference to radio or television reception, which can be determined by turning the equipment off and on, the user is encouraged to try to correct the interference by one or more of the following measures:

- ! Reorient or relocate the receiving antenna.
- ! Increase the separation between the equipment and receiver.
- ! Connect the equipment into an outlet on a circuit different from that to which the receiver is connected.
- ! Consult the dealer or an experienced radio/TV technician for help.

FM

This equipment has passed the FM certification. According to the National Fire Protection Association, work sites are classified into different classes, divisions and groups, based on hazard considerations. This equipment is compliant with the specifications of Class I, Division 2, Groups A, B, C and D indoor hazards.

Technical Support and Assistance

1. Visit the Advantech web site at www.advantech.com/support for the latest information about the product.
2. Contact the distributor, sales representative, or Advantech's customer service center for technical support if you need additional assistance. Please have the following information ready before you call:
 - Product name and serial number
 - Description of your peripheral attachments
 - Description of your software (operating system, version, application software, etc.)
 - A complete description of the problem
 - The exact wording of any error messages

Warnings, Cautions and Notes

Warning! Warnings indicate conditions, which if not observed, can cause personal injury!



Caution! Cautions are included to help you avoid damaging hardware or losing data. e.g.



There is a danger of a new battery exploding if it is incorrectly installed. Do not attempt to recharge, force open, or heat the battery. Replace the battery only with the same or equivalent type recommended by the manufacturer. Discard used batteries according to the manufacturer's instructions.

Note! Notes provide optional additional information.



Document Feedback

To assist us in making improvements to this manual, we would welcome comments and constructive criticism. Send all such in writing to: support@advantech.com

Packing List

Before setting up, check that the items listed below are included, in good condition. If any item does not accord with the table, please contact your dealer immediately.

- ! TREK-550 series Computing Box
- ! Accessories for TREK-550
- ! Warranty card
- ! Power cord: DC power inlet cable (180 cm - for TREK-550 only)
- ! Video in/CAN cable
- ! "Drivers, Utilities and User Manual" CD-ROM
- ! End User License Agreement (XPE and WinCE model)

Ordering information

Part Number	Description
TREK-550-A00E	Intel Atom 1.1 GHz (Option: GPRS)
TREK-550-A20E	Intel Atom 1.1 GHz (Option: HSDPA/CDMA)
TREK-550-A40E	Intel Atom 1.3 GHz (Option: GPRS)
TREK-550-A60E	Intel Atom 1.3 GHz (Option: HSDPA/CDMA)
TREK-303R-HA0E	7" vehicle display system, 800 x 480 resolution, with 4wire resistive touchscreen, 2-watt speaker

Safety Instructions

1. Read these safety instructions carefully.
2. Keep this User Manual for later reference.
3. Disconnect this equipment from any AC outlet before cleaning. Use a damp cloth. Do not use liquid or spray detergents for cleaning.
4. For plug-in equipment, the power outlet socket must be located near the equipment and must be easily accessible.
5. Keep this equipment away from humidity.
6. Put this equipment on a reliable surface during installation. Dropping it or letting it fall may cause damage.
7. The openings on the enclosure are for air convection. Protect the equipment from overheating. **DO NOT COVER THE OPENINGS.**
8. Make sure the voltage of the power source is correct before connecting the equipment to the power outlet.
9. Position the power cord so that people cannot step on it. Do not place anything over the power cord.
10. All cautions and warnings on the equipment should be noted.
11. If the equipment is not used for a long time, disconnect it from the power source to avoid damage by transient overvoltage.
12. Never pour any liquid into an opening. This may cause fire or electrical shock.
13. Never open the equipment. For safety reasons, the equipment should be opened only by qualified service personnel.
14. If one of the following situations arises, get the equipment checked by service personnel:
 15. The power cord or plug is damaged.
 16. Liquid has penetrated into the equipment.
 17. The equipment has been exposed to moisture.
 18. The equipment does not work well, or you cannot get it to work according to the user's manual.
 19. The equipment has been dropped and damaged.
 20. The equipment has obvious signs of breakage.
21. **DO NOT LEAVE THIS EQUIPMENT IN AN ENVIRONMENT WHERE THE STORAGE TEMPERATURE MAY GO BELOW -30° C (-22° F) OR ABOVE 70° C (158° F). THIS COULD DAMAGE THE EQUIPMENT. THE EQUIPMENT SHOULD BE IN A CONTROLLED ENVIRONMENT.**
Operating temperature: 50° C
22. **CAUTION: DANGER OF EXPLOSION IF BATTERY IS INCORRECTLY REPLACED. REPLACE ONLY WITH THE SAME OR EQUIVALENT TYPE RECOMMENDED BY THE MANUFACTURER, DISCARD USED BATTERIES ACCORDING TO THE MANUFACTURER'S INSTRUCTIONS.**
23. The sound pressure level at the operator's position according to IEC 704-1:1982 is no more than 70 dB (A).

DISCLAIMER: This set of instructions is given according to IEC 704-1. Advantech disclaims all responsibility for the accuracy of any statements contained herein.

Wichtige Sicherheitshinweise

1. Bitte lesen sie Sich diese Hinweise sorgfältig durch.
2. Heben Sie diese Anleitung für den späteren Gebrauch auf.
3. Vor jedem Reinigen ist das Gerät vom Stromnetz zu trennen. Verwenden Sie Keine Flüssig-oder Aerosolreiniger. Am besten dient ein angefeuchtetes Tuch zur Reinigung.
4. Die NetzanschlusBsteckdose soll nahe dem Gerät angebracht und leicht zugänglich sein.
5. Das Gerät ist vor Feuchtigkeit zu schützen.
6. Bei der Aufstellung des Gerätes ist auf sicheren Stand zu achten. Ein Kippen oder Fallen könnte Verletzungen hervorrufen.
7. Die Belüftungsöffnungen dienen zur Luftzirkulation die das Gerät vor überhit-zung schützt. Sorgen Sie dafür, daB diese Öffnungen nicht abgedeckt werden.
8. Beachten Sie beim. AnschluB an das Stromnetz die AnschluBwerte.
9. Verlegen Sie die NetzanschlusBleitung so, daB niemand darüber fallen kann. Es sollte auch nichts auf der Leitung abgestellt werden.
10. Alle Hinweise und Warnungen die sich am Geräten befinden sind zu beachten.
11. Wird das Gerät über einen längeren Zeitraum nicht benutzt, sollten Sie es vom Stromnetz trennen. Somit wird im Falle einer Überspannung eine Beschädigung vermieden.
12. Durch die Lüftungsöffnungen dürfen niemals Gegenstände oder Flüssigkeiten in das Gerät gelangen. Dies könnte einen Brand bzw. elektrischen Schlag auslösen.
13. Öffnen Sie niemals das Gerät. Das Gerät darf aus Gründen der elektrischen Sicherheit nur von autorisiertem Servicepersonal geöffnet werden.
14. Wenn folgende Situationen auftreten ist das Gerät vom Stromnetz zu trennen und von einer qualifizierten Servicestelle zu überprüfen:
 15. Netzkabel oder Netzstecker sind beschädigt.
 16. Flüssigkeit ist in das Gerät eingedrungen.
 17. Das Gerät war Feuchtigkeit ausgesetzt.
 18. Wenn das Gerät nicht der Bedienungsanleitung entsprechend funktioniert oder Sie mit Hilfe dieser Anleitung keine Verbesserung erzielen.
 19. Das Gerät ist gefallen und/oder das Gehäuse ist beschädigt.
 20. Wenn das Gerät deutliche Anzeichen eines Defektes aufweist.
21. **VORSICHT:** Explosionsgefahr bei unsachgemaben Austausch der Batterie.Ersatz nur durch denselben oder einem vom Hersteller empfohlene-mahnlichen Typ. Entsorgung gebrauchter Batterien navh Angaben des Herstellers.
22. **ACHTUNG:** Es besteht die Explosionsgefahr, falls die Batterie auf nicht fach-männische Weise gewechselt wird. Verfangen Sie die Batterie nur gleicher oder entsprechender Type, wie vom Hersteller empfohlen. Entsorgen Sie Batterien nach Anweisung des Herstellers.
23. Der arbeitsplatzbezogene Schalldruckpegel nach DIN 45 635 Teil 1000 beträgt 70dB(A) oder weiger.

Haftungsausschluss: Die Bedienungsanleitungen wurden entsprechend der IEC-704-1 erstellt. Advantech lehnt jegliche Verantwortung für die Richtigkeit der in diesem Zusammenhang getätigten Aussagen ab.

Safety Precaution - Static Electricity

Follow these simple precautions to protect yourself from harm and the products from damage.

- ! To avoid electrical shock, always disconnect the power from your PC chassis before you work on it. Don't touch any components on the CPU card or other cards while the PC is on.
- ! Disconnect power before making any configuration changes. The sudden rush of power as you connect a jumper or install a card may damage sensitive electronic components.

Warning!



1. *Input voltage rated: 9-36 Vdc.*
2. *Transport: carry the unit with both hands and handle with care.*
3. *Maintenance: to properly maintain and clean the surfaces, use only approved products or clean with a dry applicator.*
4. *CompactFlash: Turn off the power before inserting or removing CompactFlash storage cards.*

ropean Contact information:

Advantech Europe GmbH
Kolberger Straße 7
D-40599 Düsseldorf, Germany
Tel: 49-211-97477350
Fax: 49-211-97477300

This device complies with Part 15 of the FCC Rules. Operation is subject to the following two conditions: (1) this device may not cause harmful interference and (2) this device must accept any interference received, including interference that may cause undesired operation. "Complies with CANADA RSS-210

This equipment has been tested and found to comply with the limits for a Class B digital device, pursuant to part 15 of the FCC rules.

These limits are designed to provide reasonable protection against harmful interference in a residential installation. This equipment generates, uses and can radiate radio frequency energy and, if not installed and used in accordance with the instructions, may cause harmful interference to radio communications. However, there is no guarantee that interference will not occur in a particular installation. If this equipment does cause harmful interference to radio or television reception, which can be determined by turning the equipment off and on, the user is encouraged to try to correct the interference by one or more of the following measures: -Reorient or relocate the receiving antenna. -Increase the separation between the equipment and receiver. -Connect the equipment into an outlet on a circuit different from that to which the receiver is connected. -Consult the dealer or an experienced radio/TV technician for help.

b. FCC Part 15.21 information for user

You are cautioned that changes or modifications not expressly approved by the party responsible for compliance could void your authority to operate the equipment.

This device complies with Part 15 of the FCC Rules. Operation is subject to the following two conditions: (1) this device may not cause harmful interference and (2) this device must accept any interference received, including interference that may cause undesired operation

Notes and Warnings to the User and Installer:

Caution:

This Installation Guide is intended for use by the professional wireless LAN system installer.

The device cannot be sold retail, to the general public or by mail order. It must be sold to dealers or have strict marketing control.

Warning: It is the responsibility of the professional installer to ensure that the system is used exclusively for fixed, point-to-point operations.

Warning: When using the device in the United States (or where FCC rules apply), it is the responsibility of the professional installer to ensure to control the output power not greater than the application.

Who Should Use this Guide:

Installation of this device should be accomplished only by a qualified wireless LAN system installer who is: -Knowledgeable of the use, installation and configuration procedures and associated networking

components. -Knowledgeable of each system component's equipment User and Installation Guide. -Knowledgeable of the installation and configuration procedures for the site's network infrastructure system and wiring.

-Knowledgeable of the installation procedures, safety, and code requirements for the site's antenna, antenna mast, antenna cabling, and installation. We highly recommend that the antenna installation be performed by a qualified antenna installation professional.

Users should not attempt to make such connections themselves, but should contact the appropriate electrical inspection authority, or electrician, as appropriate.

for mobile devices without co-location condition (the transmitting antenna is installed or located more than 20cm away from the body of user and near by person)

FCC RF Radiation Exposure Statement:

1. This Transmitter must not be co-located or operating in conjunction with any other antenna or transmitter.
2. This equipment complies with FCC RF radiation exposure limits set forth for an uncontrolled environment

This equipment should be installed and operated with a minimum distance of 20 centimeters between the radiator and your body.

Contents

Contents ix

Chapter 1	General Information	1
1.1	Introduction	2
1.2	General Specifications	2
1.2.1	General	2
1.2.2	Standard PC Functions.....	3
1.2.3	PCI Bus Ethernet Interface	3
1.2.4	Touchscreen	3
1.2.5	Environment.....	4
1.3	LCD Specifications.....	4
	Table 1.1: LCD Specifications	4
1.4	Dimensions	4
	Figure 1.1 TREK-550 dimensions.....	4
Chapter 2	System Setup.....	5
2.1	A Quick Tour of the Mounted	6
	Figure 2.1 Front view of the TREK-550	6
	Figure 2.2 Left side of the TREK-550	6
	Figure 2.3 Rear view of the TREK-550.....	7
	Figure 2.4 Computing Box I/O	7
2.2	Installation Procedures.....	8
2.2.1	Connecting the Power Cord.....	8
	Table 2.1: Pin Definition of Power Cord	8
2.2.2	Connecting the Keyboard or Mouse	8
2.2.3	Switching on the Power	8
2.3	Running the BIOS Setup Program	9
2.4	Installing System Software.....	9
2.5	Installing the Drivers.....	10
2.6	Programming Function Keys and GPIO/CAN BUS.....	10

Chapter 4 Jumper Settings and Connectors ... 19

4.1	Setting Jumpers and Switches.....	20
4.1.1	Locating Jumpers and Switches.....	20
	Table 4.1: Jumpers & LEDS on the Motherboard	20
4.1.2	Locating Jumpers and LEDs on the Motherboard	21
	Figure 4.1 Locating Jumpers / LEDs	21
4.1.3	Connectors on the Motherboard.....	22
	Table 4.2: Connectors on the Motherboard.....	22
4.1.4	Locating Connectors on the Motherboard	23
	Figure 4.2 Locating Connectors on the front side.....	23
	Figure 4.3 Locating Connectors on the back side	23
4.2	CPU Installation	24
4.3	Jumper Settings.....	24
4.3.1	CMOS Clear for External RTC (JP1).....	24
	Table 4.3: Clear CMOS / External RTC (JP1).....	24
4.3.2	Power Feature Setting (JP3)	24
	Table 4.4: Ignition Input Switch Setting (JP3)	24
	Table 4.5: Power off / Hard off Delay Setting (JP3)	25
	Table 4.6: Low Battery Monitor (JP3).....	26
4.4	COM Port Interface.....	27
	Table 4.7: Serial Port Default Settings	27
4.4.1	COM Port Pin 9 Power Output Setting (CN27).....	28
	Table 4.8: COM Port Pin 9 Power Output Setting (CN27)	28
4.4.2	COM Port Pin 9 Power Output Value Setting (JP2).....	28
	Table 4.9: COM Port Pin 9 Power Output Value Setting (JP2) .	28

Chapter 5 Pin Assignments43

A.1	Internal Speaker Connector (CN2 on PCM-028)	44
	Table A.1: Internal Speaker Connector (CN2 on PCM-028).....	44
A.2	COM1, 2 (CN17,19)	44
	Table A.2: COM1, 2 (CN17,19).....	44
A.3	GPIO / CAN BUS Connector (CN31).....	45
	Table A.3: GPIO / CAN BUS Connector (CN31)	45
A.4	Inverter / Touch / USB Connector (CN18)	46
	Table A.4: Inverter / Touch / USB Connector (CN18).....	46
A.5	Power Inlet	47
	Table A.5: Power inlet.....	47

Chapter 6 SW demo application set Up.....43

A.1	J1939/CAN.....	44
	Table A.1:	44
A.2	RTC.....	44
	Table A.2:	44
A.3	Power management	45
	Table A.3: GPIO / CAN BUS Connector (CN31)	45
A.4	GPIO	46
A.5	Video	44
	Table A.2:	44
A.6	Dead reckoning	45
	Table A.3:	45
A.7	G-sensor	46

Appendix A TREK-30349

B.1	TREK-303 spec	50
B.1.1	50
B.2	Other Information	65

Chapter 1

General Information

This chapter gives background information on the TREK-550 Computing Box.

Sections include:

- ! Introduction
- ! General Specifications
- ! Dimensions

1.1 Introduction

The TREK-550 is a dedicated box computer for industrial, transport trucks, buses and taxis. TREK-550 combined with variety of I/O connectors can be connected to devices like OBD-II or TPMS (Tire Pressure Monitoring System). Dual display/dual audio interfaces supporting different resolutions can deliver different applications to different displays; eg: one application to a driver and another to a digital signage application.

Built-in wireless communications (WWAN, WLAN, BT) enable TREK-550 to send important driver/ location/cargo information back to the control center. TREK-550 can also operate in extreme environments with features like a wide working temperature range (-30 to 70 degrees). TREK-550 also uses a special design to handle the critical issue of in power. Special power protection (ISO7637-2/SAE J1455 Class A/ SAE J1113) and power management software (Ignition on/off, delay on/off, low battery monitor) prevent electrical noise and surges from impacting the system, guarding against damage from transient power. TREK-550 also support rear view monitor through connecting video in port. With this feature, driver can real time monitor the environment on two sides of the truck for driving safety. TREK-550 can also support dead-reckoning feature, which means the truck can still be traced even the driver is driving in a tunnel.

Rear-Side Connectors

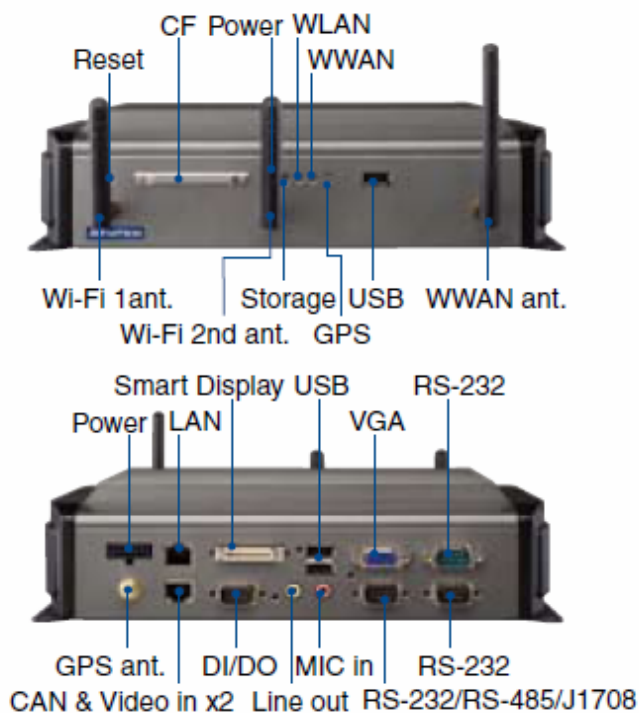

1.2 General Specifications

Key features

- Supports Win CE 6.0, XPE, XP and Linux
- Automotive grade working temperature range (-30° C to 70° C)
- Rich I/O including CAN, LAN, RS-232, RS-485, J1708, isolation 4DI/4DO, Line out, Mic in, USB, and Video-in
- Built-in communication modules, including GSM/GPRS/HSDPA/CDMA, WLAN & Bluetooth
- GPS with AGPS and dead reckoning technology (Gyro & speed line)
- Certifications: CE/FCC/e-mark, MIL-SD810F, ISO 7637-2, SAE J1455, SAE J1113 regulations
- Dual display/audio output for both driver and passenger
- Ignition on/off delay; SW detectable/controllable for power management

1.2.1 General

! **Dimensions:** (W x H x D): 271 x 149 x 69.7 mm.

! **Weight:** 2 kg.

! **Power supply:**

- **Input voltage:** 6 ~ 36Vdc, support ignition cold crank
- **Ignition on/off**
- **Low battery shut-down protection threshold (optional):** When the battery voltage level drops below 11V for more than 30 seconds, TREK-550 will automatically shut down in order to prevent “deep discharge” situations and TREK-550 can be re-activated only when the voltage is > 11V.
- **Power on delay:** Default 2 seconds. When the TREK-550 is powered on via ignition key, the system will delay 2 seconds to power on.
- **Power off delay:** Default 5 seconds. When TREK-550 power is controlled by ignition key and turns off by the key (ignition=off), the TREK-550 will start the shut procedure after 5 seconds.
- **Hard off delay:** Default 30 seconds. When TREK-550 power is controlled by ignition key and turns off by the key (ignition=off), the TREK-550 will cut off the 5VSB power after 30 seconds. In this event when the shutdown process is longer than 30 seconds, the power will be shut down hard, turning off the TREK-550's power and 5VSB.

Note! For more detail of function please refer to Chapter 4, Section 4.3.2 of this manual.



! **Power consumption:** The maximum current consumption is about 32.4 watts. The power consumption is 12 watts in normal mode (with only XPE running; no I/O device and modules connected to the TREK-550).

! **Front panel and back cover:** IP65 Sealed; NEMA4 compliant (Not including the I/O ports).

! **Enclosure:** Ruggedized aluminum without ventilation holes.

1.2.2 Standard PC Functions

- ! **CPU:** Intel Atom Z510PT 1.1Ghz/ Z520PT 1.3Ghz
- ! **Chipset:** Integrated in LE82US15EE
- ! **BIOS:** Award 256 KB Flash BIOS, ACPI 2.0 Compliant.
- ! **System chipset:.**
- ! **System memory:** One 200-pin SODIMM sockets, accepts up to 2 GB DDR667 DDR
- ! **Solid state disk:** Supports one 50-pin socket for Compact-Flash type I/II (True PATA mode).
- ! **Serial ports:** Two RS-232, 5V@500mA, 12V@ 250mA, ping9, by jumper selected. One 4-wire RS232, 1 x RS485, 1 x J1708 ports.
- ! **Universal serial bus (USB) port:** Supports up to three USB2.0. One from smart display port.
- ! **LAN port:** 1 x 10/100/1000 Ethernet (with LEDs) by RJ45.
- ! **Video output:** 1 x VGA output by DB-15 (independent display).
- ! **Video in:** 2 x composite video input selection supported format (for rear view monitor) by RJ-45 connector
- ! **Mini PCI express bus expansion slot:** Accepts half size mini PCI bus card.
- ! **Bluetooth:** One Class2 Bluetooth V2.0 + EDR module.
- ! **Watchdog timer:** 63-level timer intervals automatically generate system reset when the system stops due to a program error or EMI. Jumper selection and software enabled/disabled.
- ! **RTC Battery:** 3.0 V @ 195 mA lithium battery.
- ! **Power management:** Supports power saving modes including Normal/ Standby/Suspend modes. APM 1.2 compliant.
- ! **Digital I/O:** Optically isolated 4 digital input and 4 digital output
- ! **CAN bus:** RS-232 baud rate up to 115.2K bps.
- ! **Audio controller:** AC97 Ver. 2.0 compliant interface, Multi stream Direct sound and Direct Sound 3D acceleration.
- ! **Stereo sound:** 18-bit full-duplex codec.
- ! **Audio interface:** One 2W speaker, one microphone. One line out.
- ! **Optional modules:** 12 channels GPS, quad-band GSM/GPRS, MiniPCI WLAN card.

1.2.3 PCI Bus Ethernet Interface

- ! **Chipset:** Realtek RTL8100CL PCI local bus Ethernet controller.
- ! **Ethernet interface:** Full compliance with IEEE 802.3u 100Base-T and 10 Base-T specifications. Includes software drivers and boot ROM that supports both RPL and PXE.
- ! **100/10Base-T** auto-sensing capability.

1.2.4 Touchscreen

- ! **Type:** Analog Resistive
- ! **Light transmission:** 80%
- ! **Controller:** RS-232 interface
- ! **Power consumption:** <5.5 V@ 20 mA
- ! **Durability:** > 10 million depressions
- ! **Software driver:** Supports Windows XP/XP Embedded, WinCE

1.2.5 Environment

- ! **High/low temperature:** -30 ~ 70° C
- ! **Relative humidity:** 10 ~ 95% @ 40° C (non-condensing)
- ! **Shock:** 30 G peak acceleration (11 msec duration)
- ! **Certifications:** CE, FCC, CCC, Emark, CB.
- ! **Vibration:** 5 ~ 500 Hz SAE J1455 4.9.4.2, MIL-STD-810F 514.5

1.4 Dimensions

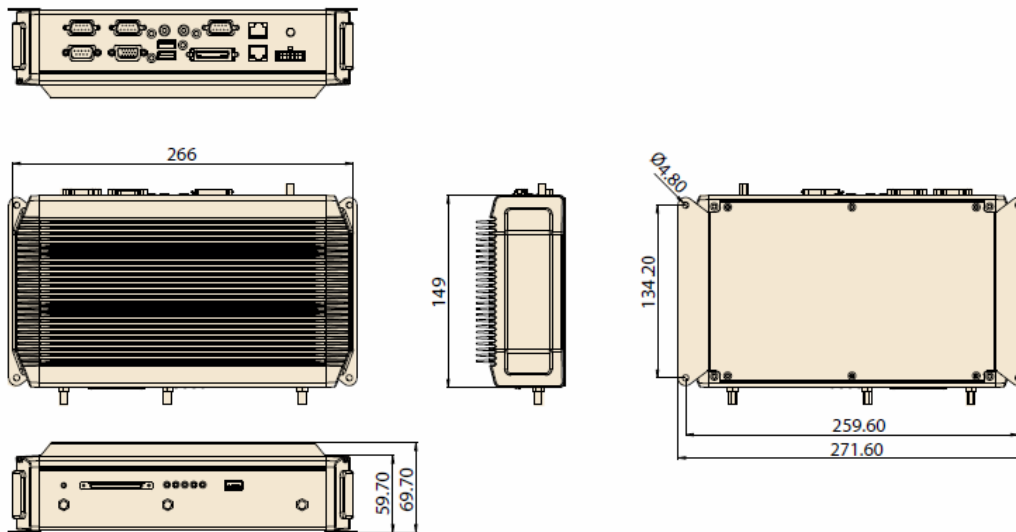

Figure 1.1 TREK-550 dimensions

Chapter 2

System Setup

This chapter details system setup on TREK-550.

Sections include:

- ! A Quick Tour of the computer box
- ! Installation Procedures
- ! Running the BIOS Setup Program

2.1 A Quick Tour of the TREK-550 Computing box.

Before starting to set up the Computing Box, take a moment to become familiar with the locations and purposes of the controls, drives, connectors and ports, which are illustrated in the figures below. When the Computer box is placed inside truck glove cabinet or under the passenger's seat next to the driver, its front appears as shown in Figure 2.1.

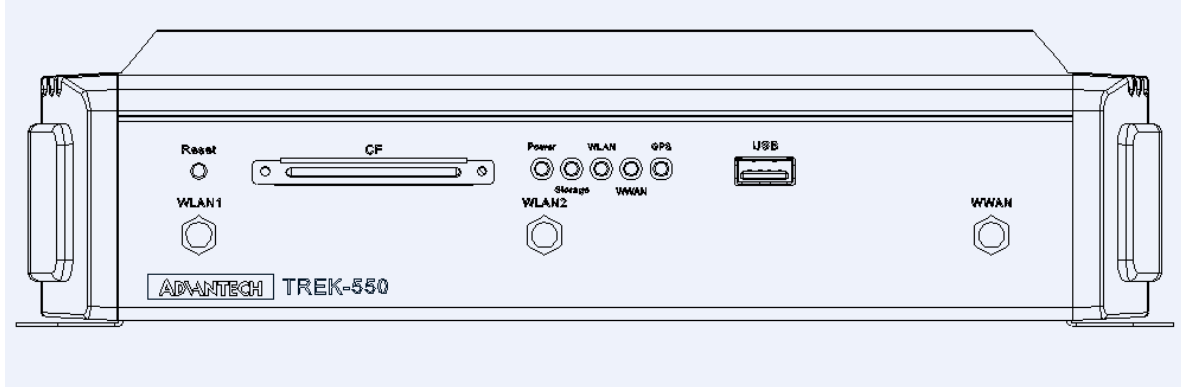

Figure 2.1. front view of TREK-550

Figure 2.1.fdsadf

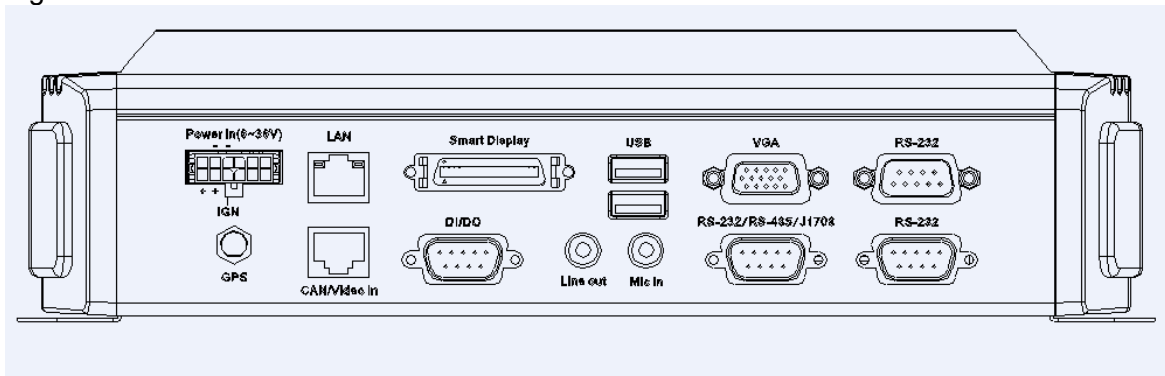
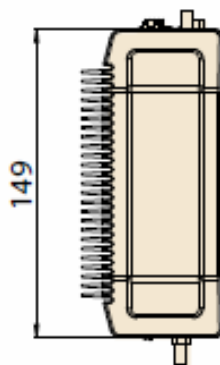
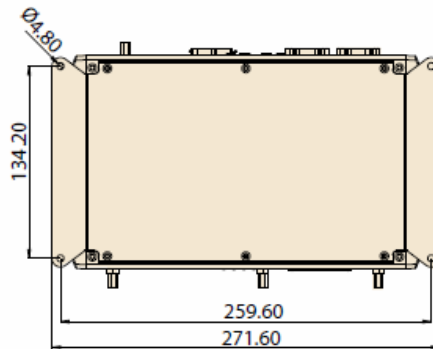

Figure 2.2. Rear view of TREK-550



Unit: mm

Figure 2.3. Side view of TREK-550



Unit: mm

Figure 2.4. Bottom view of TREK-550

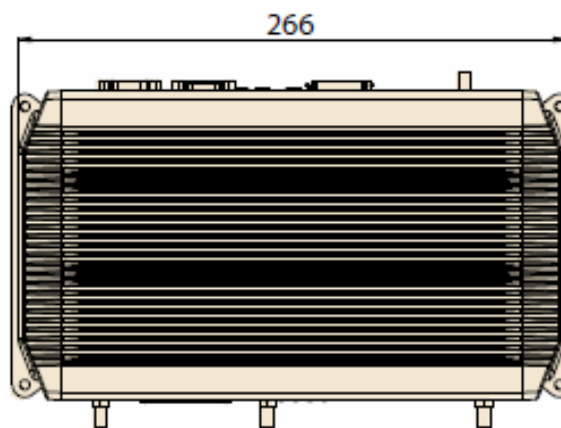

Unit: mm

Figure 2.5. Top view of TREK-550

2.2 Installation Procedures

2.2.1 Connecting the Power Cord

Connect the three pin waterproof power cord to the DC inlet of the Computing Box. On the open-wire end, one pin is reserved for positive voltage and is marked, "+"; one pin is reserved for ground and is marked, "-"; and, one pin is reserved for the ignition signal with an "ignition" mark.

Note! Power on/off the TREK-550 via the TREK-550's power switch. Please connect its "+" and "ignition" pins together with the power source's "+".



Or change the JP3 jumper setting. (For JP3 jumper setting please see section 4.3.2.1)

Note! Ignition on/off setting : The TREK-550 supports an ignition on/off function so that you can power on/off the TREK-550 via the ignition signal/



voltage. Either connect the TREK-550's "ignition" pin to ignition and the TREK-550 "+" to "+"; or connect the TREK-550's "ignition & +" pins together with power source's "+", and "-" to "-". Please also set the "power on after power failure" function to "always on" in BIOS.(for BIOS settings, please see Appendix D). The delay on/off will be active once the ignition on/off is selected.

Table 2.1: Pin Definition of Power Cord

Pin	Definition	Color
1	+	yellow
3	-	black
4	Ignition	white

Power Connector

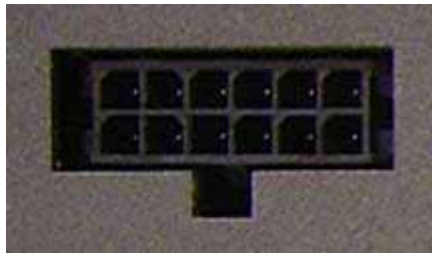
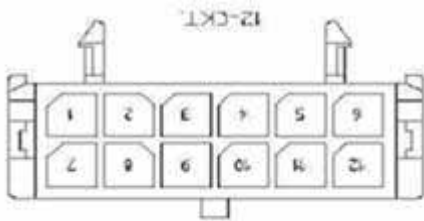

Molex Manufacturer part no. 0430451200

Power Connector			
Pin	Signal	Pin	Signal
1	Chassis Ground	2	Ground
3	Ground	4	(Reserved)
5	(Reserved)	6	(Reserved)
7	Power Input (6~36 VDC)	8	Power Input (6~36 VDC)
9	Acc Ignition Input	10	Ground
11	(Reserved)	12	Power Button Input

Mating power cable

**Advantech p/n : 1700018306 A Cable 2*6P-3.0/fuse 180cm TREK
Manufacturer p/n: Best Technology Enterprise 900-1200-180R**

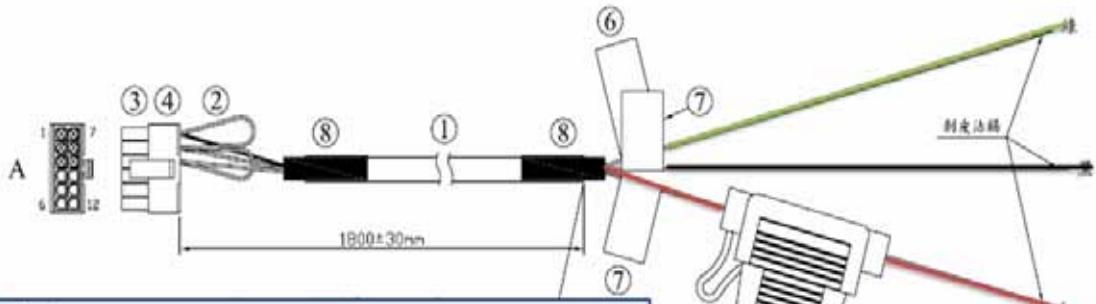

- Note
- Material
1. UL2464 22A WG 3C+ AEB black L-1985mm – 1pc
 2. UL 1007 22AWG black, red wire L= 50mm – 2pcs
 3. Housing CH3025-2 * 6P (PH3.0) – 1pc
 4. Terminal C3004TOP-2 – 6pcs
 5. Vehicle fuse (5A) -1pc
 6. Label Sticker 10 * 50mm (printing: Ignition) – 1pc
 7. Label Sticker 10 * 25mm (printing: +, -) – 2pcs
 8. Heat shrinkable Tube – 3pcs

- A _____ Sticker Label _____ B
- GND 1 _____
- Black 2 _____ --
- Black 3 _____
- Red 7 _____ + _____ fuse
- Red 8 _____
- Green 9 _____ Ignition

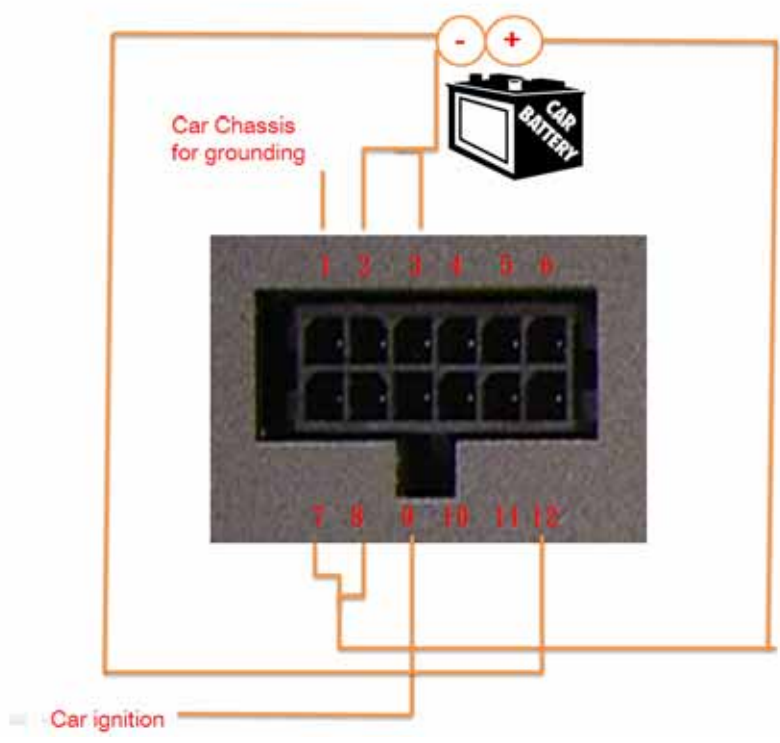

2.3 Running the BIOS Setup Program

In most cases, the computer will have been properly set up and configured by the dealer or SI prior to delivery. However, it may still be necessary to adjust some of the computer's BIOS (Basic Input-Output System) setup programs to change the system configuration data, like the current date and time, or the specific type of hard drive currently installed.

The setup program is stored in read-only memory (ROM). It can be accessed either when turning on or resetting the computer, by pressing the "Del" key on the keyboard immediately after powering up the computer.

The settings that are specified with the setup program are recorded in a special area of the memory called CMOS RAM. This memory is backed up by a battery so that it will not be erased when turning off or resetting the system. Whenever the power is turned on, the system reads the settings stored in CMOS RAM and compares them to the equipment check conducted during the "power on self-test" (POST). If an error occurs, an error message is displayed on screen, and the user is prompted to run the setup program.

2.4 Installing System Software

Recent releases of operating systems from major vendors include setup programs which load automatically and guide users through the entire process of operating system installation. The guidelines below help to determine the steps necessary to install your operating system on the computer hard drive.

Note! *Some distributors and system integrators may have already pre-installed system software prior to shipment of your Mounted Computer.*



The BIOS of the computer supports system boots-up directly from the CD-ROM drive whenever it is connected using a USB interface. Insert the system installation CD-ROM into the CD-ROM drive.

Power on the computer, or reset the system by pressing the "Ctrl" + "Alt" + "Del" keys simultaneously. The computer will automatically load the operating system from the diskette or CD-ROM.

When presented with the opening screen of a setup / installation program, simply follow the onscreen instructions. The setup program guides users through preparations of the hard drive, and installation of the operating system.

When presented with an operating system command prompt, like, A:\>, then it is necessary to partition and format the hard drive, and manually copy the operating system files to it. Refer to the operating system user instructions about partitioning and formatting the hard drive.

2.5 Installing the Drivers

After installing system software, the computer is ready to set up the AMD chipset, VGA, audio, LAN, and touch screen functions. All the pre-requisite drivers are stored on a CD-ROM disc entitled “Drivers and Utilities” (Check the correct wording on the CD, which can be found in the accessory box.)

The utility directory includes multimedia programs. Some drivers and utilities in the CD-ROM disc have their own text files which help users install the drivers and understand their functions.

These files are a very useful supplement to the information in this manual. For more details of driver installation please refer to Chapter 5 to 10 of this manual.

Note! *The drivers and utilities used for the TREK-550 are subject to change without notice. If in doubt, check Advantech's website or contact our application engineers for the latest information regarding drivers and utilities.*



2.6 Programming Function Keys and GPIO/CAN BUS

The Mount Computer provides five function keys, GPIO and CAN bus as shown in section 2.1. These functions must be activated with the correct software, that's why we provide an AP library for customers to design their own software. Refer to Appendix C for more detail.

Chapter 4

Jumper Settings and Connectors

This chapter explains how to set up the Computing Box hardware, including instructions on setting jumpers and connecting peripherals, and how to set switches and read indicators. Be sure to read all the safety precautions before beginning the installation procedure.

Sections include:

- ! Setting Jumpers

4.1 Setting Jumpers and Switches

It is possible to configure the Computing Box to match the needs of the application by resetting the jumpers. A jumper is the simplest kind of electrical switch. It consists of two metal pins and a small metal clip, often protected by a plastic cover that slides over the pins to connect them. To “close” a jumper, connect the pins with the clip. To “open” a jumper, remove the clip. Sometimes a jumper has three pins, labeled 1, 2, and 3. In this case, connect either pins 1 and 2, or pins 2 and 3.

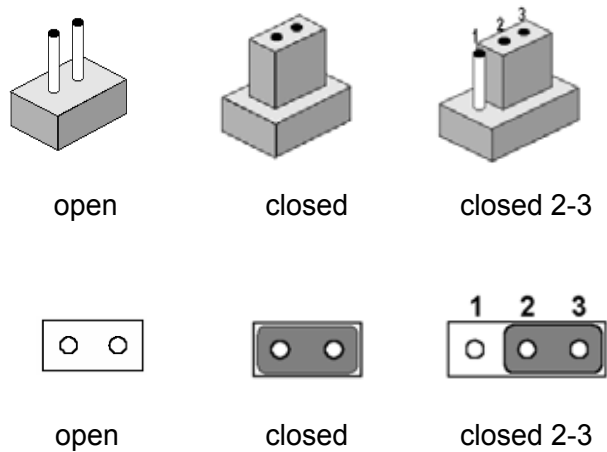

A pair of needle-nose pliers may be helpful when working with jumpers. If there are any doubts about the best hardware configuration for the application, contact the local distributor or sales representative before making any changes.

An arrow is used on the motherboard to indicate the first pin of each jumper.

4.1.1 Locations of the Jumpers and Connector

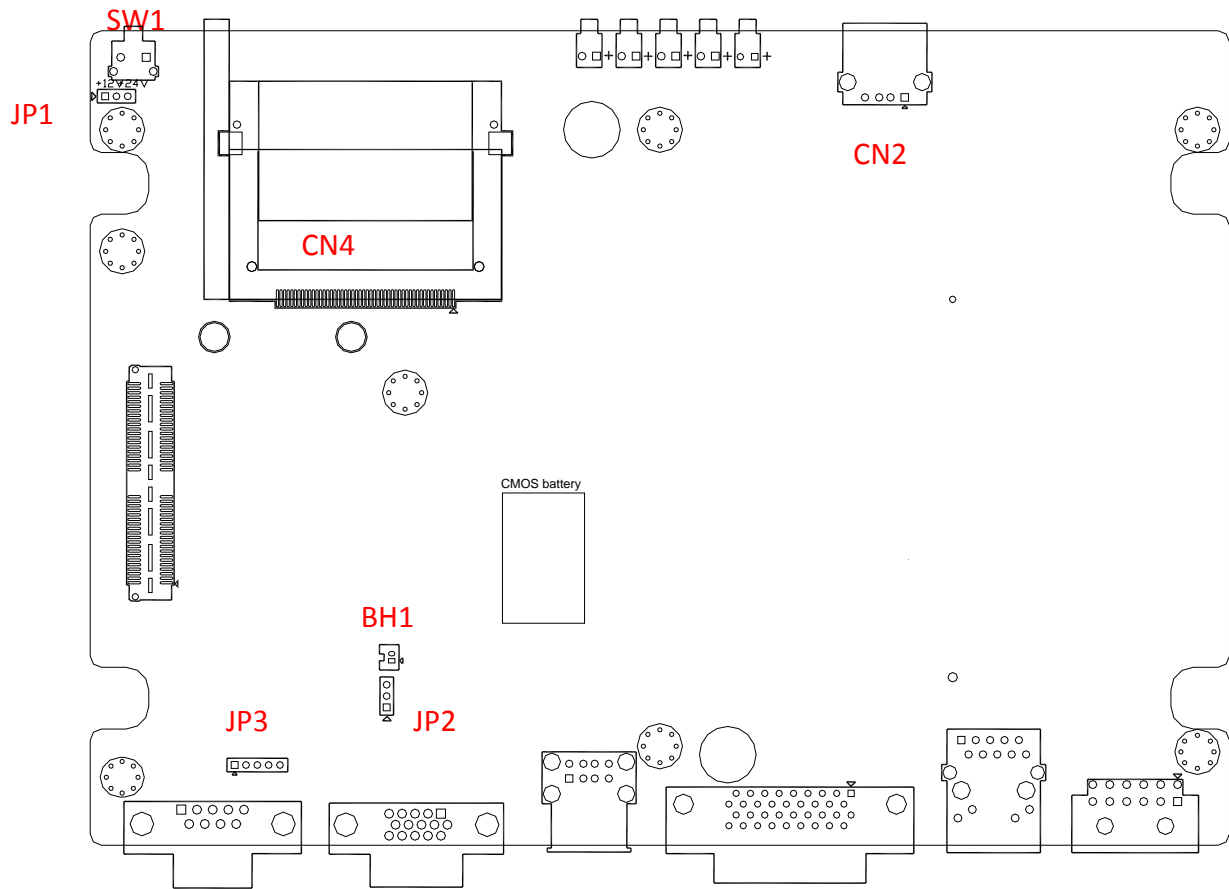

Figure 4.1 Locations of jumpers and connectors on top side the motherboard.

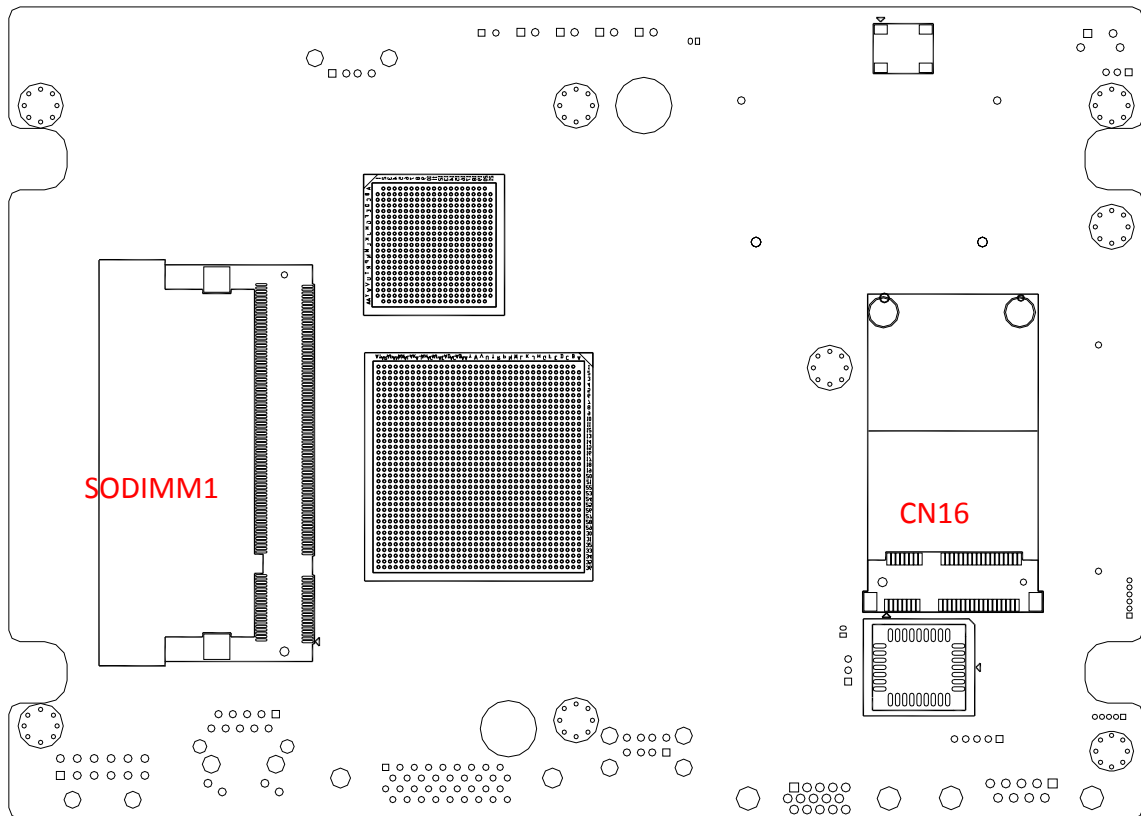

Figure 4.2 Locations of jumpers and connectors on bottom side of the motherboard.

The figures below show the locations of the jumpers and connectors on daughter board used in TREK-550.

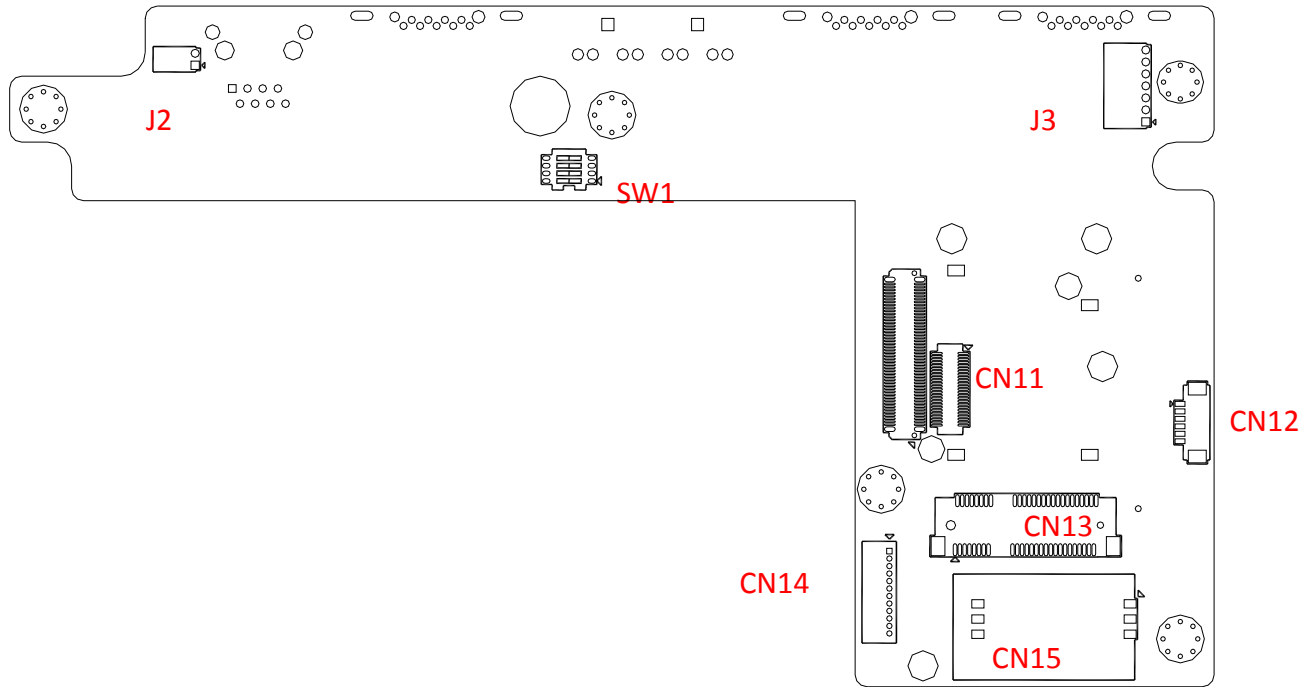

Figure 4.4 Locations of jumpers and connectors on bottom side of the daughter board.

4.1.2 Jumpers

Table 4.1: Jumpers on motherboard

Location	Function
JP1	input voltage selection
JP2	CMOS clear for external RTC
JP3	Pin9 of COM3 function selection

Table 4.2: Jumpers on daughter board

Location	Function
J2	CAN bus termination selection
J3	Pin9 of COM8 function selection
SW2	DI/GPS Function selection

4.1.3 Connectors

On-board connectors link the Computing Box to external devices such as hard disk drives. The table below lists the function of each connector.

Table 4.1: Connectors on motherboard

Location	Function
SW1	RESET
CN2	USB connector
CN4	CF connector
CN10	LAN connector
CN11	USB connector
CN12	Power input connector
CN13	Smart Display Connector
CN14	RS-232 connector (COM3)
CN15	VGA connector
CN16	Mini-PCIe Socket (USB + PCIe interface)
BH1	RTC battery
SODIMM1	SODIMM connector for DDR2 SDRAM

Table 4.2: Connectors on daughter board

Label	Function
CN1	RS-232 connector
CN2	4-wire RS-232 + RS-485 + RS-1708 connector
CN3	Isolated Digital I/O connector
CN4	Line-Out phone jack
CN5	Mic-In phone jack
CN8	Video-In and CAN bus connector
CN11	WWAN module connector
CN12	Bluetooth module connector
CN13	Mini-PCIe Socket (USB interface, for WWAN module)
CN14	GPS module connector
CN15	SIM holder

4.3 Jumper Settings

4.3.1 CMOS Clear for External RTC (JP2)

- Warning!**
1. To avoid damaging the computer, always turn off the power supply before setting "Clear CMOS."
 2. Set the jumper back to "Normal Operation" before turning on the power supply!



Table 4.3: Clear CMOS / External RTC (JP1)

Normal Operation (Default)	Clear CMOS

4.3.2 Power Input Voltage Setting (JP1)

TREK-550 must be configured properly according the power input range.

Table 4.4: Power Input Voltage Selection (JP1)

12V Input (Default)	24V Input

4.3.3 Pin 9 of COM3 Function Selection (JP3)

Pin 9 on COM3 port can be configured as RI, 5V or 12V output.

Table 4.7: Pin 9 of COM3 Function Selection (JP3)

RI	+5VDC (max. 500mA)	+12VDC (max. 250mA)

4.3.4 Pin 9 of COM8 Function Selection (J3)

Pin 9 on COM8 port can be configured as RI, 5V or 12V output.

Table 4.7: Pin 9 of COM8 Function Selection (J3)

RI	+5VDC (max. 500mA)	+12VDC (max. 250mA)

4.3.5 DI/GPS Function Selection (SW2)

If the GPS module with Dead Reckoning function is used, the digital inputs 3/4 will be used as inputs of GPS module. DIP switch (SW2) is used to select the function on DI 3/4 (Digital Input 3/4).

Table 4.7: Pin 9 of COM8 Function Selection (J3)

	Digital Input	GPS (for Dead-Reckoning)
SW2.1	OFF	ON
SW2.2	ON	OFF
SW2.3	OFF	ON
SW2.4	ON	OFF

4.4 COM Port Interface

The computer provides totally ten serial ports for difference uses. Six of ten serial ports (COM1~COM6) are implemented with Super I/O chip and their physical address are fixed. And the other four serial ports are done by a USB serial converter, and need driver support to work. In Advantech provided WES (Windows Embedded Standard) and Win CE 6.0 OS, the four USB-to-Serial serial ports are fixed from COM8 to COM11).

Table 4.7: Serial Port Function

Port	Function
COM1	2-wire RS-232 (TXD/RXD) for TREK-303
COM2	3-wire RS-232 (TXD/RXD/RTS) for Touch on TREK-303
COM3	Full functional RS-232
COM4	For power management control
COM5	RS-485
COM6	J1708
COM8	Full functional RS-232
COM9	4-wire RS-232 (TXD/RXD/RTS/CTS)
COM10	For WWAN module
COM11	For WWAN module

Table 4.7: Serial Port Settings

Port	Address Range	Interrupt
COM1	3F8 ~ 3FF	4
COM2	2F8 ~ 2FF	3
COM3	2E8 ~ 2EF	5
COM4	2D8 ~ 2DF	7
COM5	2E0 ~ 2E7	10
COM6		11

Chapter 5

Pin Assignments

This appendix explains pin assignments on the TREK-550.

Sections include:

! Internal Speaker Connector

! COM1, 2

! GPIO / CAN BUS connector
(CN31)

! Inverter / Touch / USB connector
(CN18)

! Power Inlet

5.1 Front Side Connectors

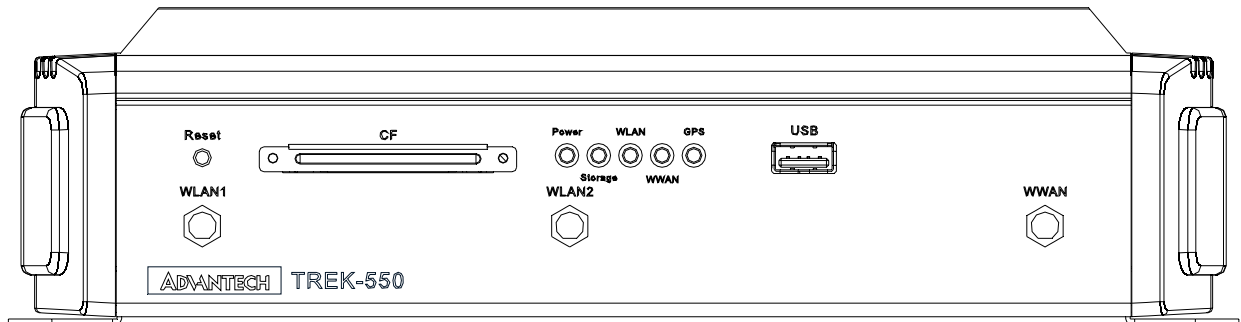

5.2 Rear Side Connectors

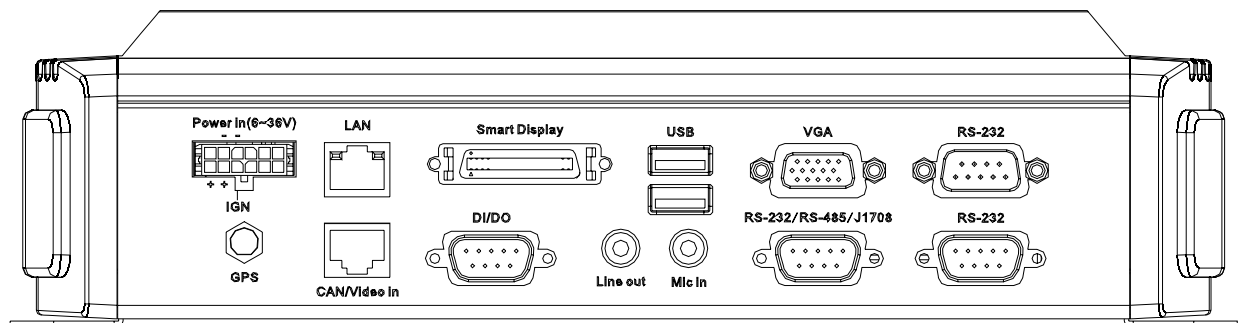

5.3 Power Connector (12/ 24V; 6 ~ 36V)

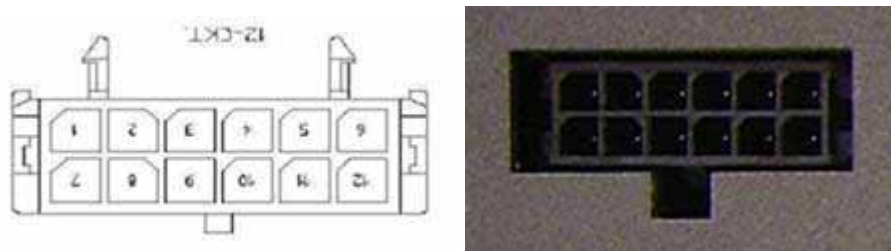

Molex Manufacturer part no. 0430451200

Power Connector			
Pin	Signal	Pin	Signal
1	Chassis Ground	2	Ground
3	Ground	4	(Reserved)
5	(Reserved)	6	(Reserved)
7	Power Input (6~36 VDC)	8	Power Input (6~36 VDC)
9	Acc Ignition Input	10	Ground
11	(Reserved)	12	Power Button Input

5.4 Smart Display Connector



Smart Display Connector			
Pin	Signal	Pin	Signal
1	Backlight Enable output	2	Panel Power Enable output
3	LVDS Ground	4	Reset Button Input
5	LVDS Clock +	6	LVDS Clock -
7	LVDS Ground	8	LVDS Ground
9	LVDS Data2 +	10	LVDS Data2 -
11	RS232 TXD1	12	RS232 RXD1
13	LVDS Data1 +	14	LVDS Data1 -
15	LVDS Ground	16	LVDS Ground
17	LVDS Data0 +	18	LVDS Data0 -
19	USB D+	20	USB D-
21	USB Ground	22	USB Ground
23	+12VDC output	24	+12VDC output
25	+12VDC output	26	+12VDC output
27	Power Ground	28	Power Ground
29	Power Ground	30	Power Ground
31	RS232 TXD2	32	RS232 RXD2
33	RS232 RTS2	34	Power Button Input
35	Audio Ground	36	Mono. Line-out

5.5 RS-232 Connector

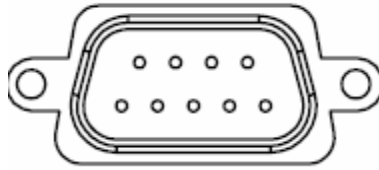

RS-232/RS-485/J1708 Connector

Pin	Signal	Pin	Signal
1	RS-232 DCD	2	RS-232 RXD
3	RS-232 TXD	4	RS-232 DTR
5	RS-232 Ground	6	RS-232 DSR
7	RS-232 RTS	8	RS-232 CTS
9	RS-232 RI / +5V / +V12		

5.6 RS-232 / RS-485 / J1708 Connector

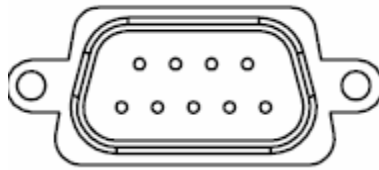

RS-232/RS-485/J1708 Connector

Pin	Signal	Pin	Signal
1	RS-232 RTS9	2	RS-232 RXD9
3	RS-232 TXD9	4	RS-232 CTS9
5	RS-232 Ground	6	RS-485 D-
7	RS-485 D+	8	J1708 D-
9	J1708 D+		

5.7 DI / DO Connector

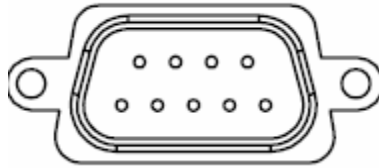

DI/DO Connector			
Pin	Signal	Pin	Signal
1	Isolated Dry Contact Input 1	2	Isolated Dry Contact Input 2
3	Isolated Dry Contact Input 3	4	Isolated Dry Contact Input 4
5	Isolation Ground	6	Isolated Relay Driver Output 1
7	Isolated Relay Driver Output 2	8	Isolated Relay Driver Output 3
9	Isolated Relay Driver Output 4		

5.8 CAN / Video-In Connector

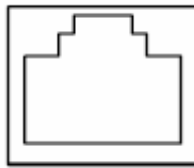

CAN/Video-In Connector			
Pin	Signal	Pin	Signal
1	CAN_H	2	CAN_L
3	CAN_SHIELD	4	CAN_SHIELD
5	Video In 2	6	Video Ground
7	Video In 1	8	Video Ground

5.9 LED indicator

System Indicators

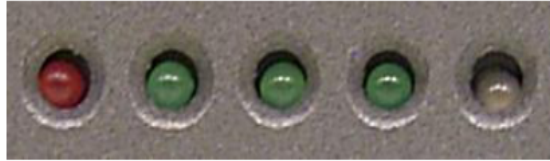

System power indicator	This system power indicator is a red LED, controlled by hardware. When the system is in NORMAL mode, this LED will be lit on. In other modes, this LED will be lit off.
GPS activity indicator	This GPS activity indicator, a blue LED, is used to show the GPS activity. This LED is controlled directly by GPS chips.
WLAN activity indicator	This WLAN activity indicator, a green LED, is used to show the activity of installed WLAN module. This LED is controlled directly by WLAN module.
WWAN activity indicator	This WWAN activity indicator, a green LED, is used to show the activity of installed WWAN module. This LED is controlled directly by WWAN module.
User-defined indicator	This user-defined indicator, a green LED, is used for customization. This LED is controlled by Software.

Chapter 6

Software demo application setup

This appendix explains the software demo application for TREK-550.

Sections include:

- ! Introduction

- ! How to set up demo application

6.1 Introduction

To make the hardware easier to access for programmers, Advantech has developed an demo program in order to let customer test the functions on TREK-550. This document describes detailed information for each Advantech demo program so that application developers can become more familiar with using them.

For technical support, contact Advantech application engineers worldwide.

For news updates, visit our website: www.advantech.com

6.1.1 Execute J1939 demo program

This section explains how to install the Advantech demo program in Windows XP Pro / Embedded.

1. Execute the test program called "IMC_Demo"



Figure 6. 1

2. Click J1939: customer may connect directly to the truck; we use a simulator board below to explain how J1939 protocol can be executed. First, connect to the simulator board to TREK-550 CAN port and console PC, once the simulator is powered on (connect to the truck), you can start getting the data, just click [Read], you may get the data you need from the simulator, click [Read], you may transfer the data to Console

Smulator vendor name:



Figure 6.2 J1939 truck simulator

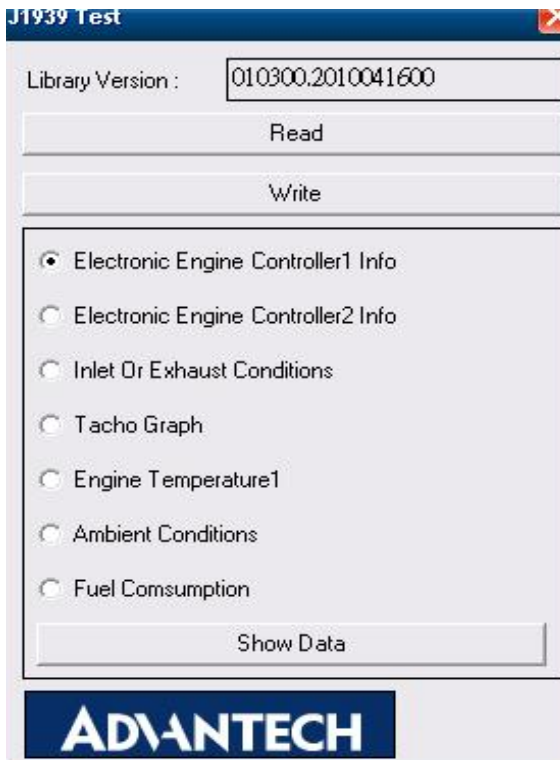

Figure 6.3

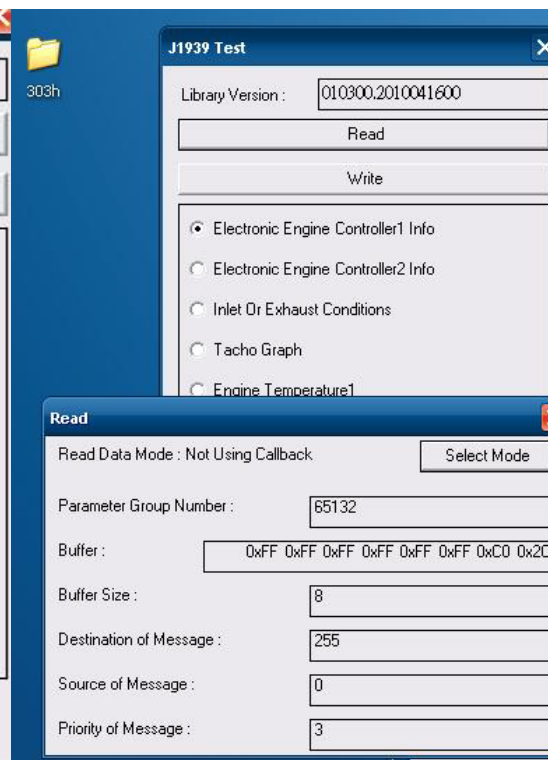

Figure 6.4

6.1.2 CAN Test

1. **CAN:** Console PC, install [PCAN_USB-to-CAN] test program, and use USB to CAN fixture to connect to TREK-550 CAN port.
2. Execute PCAN-View USB→ Set Baud rate 250kBit/s→ Select [Extended]→OK→ Transmit → New → ID(Hex) key in number → Data key in any number→[Period] key in 100ms→Click [Extended Frame]→OK. See below figure 6.

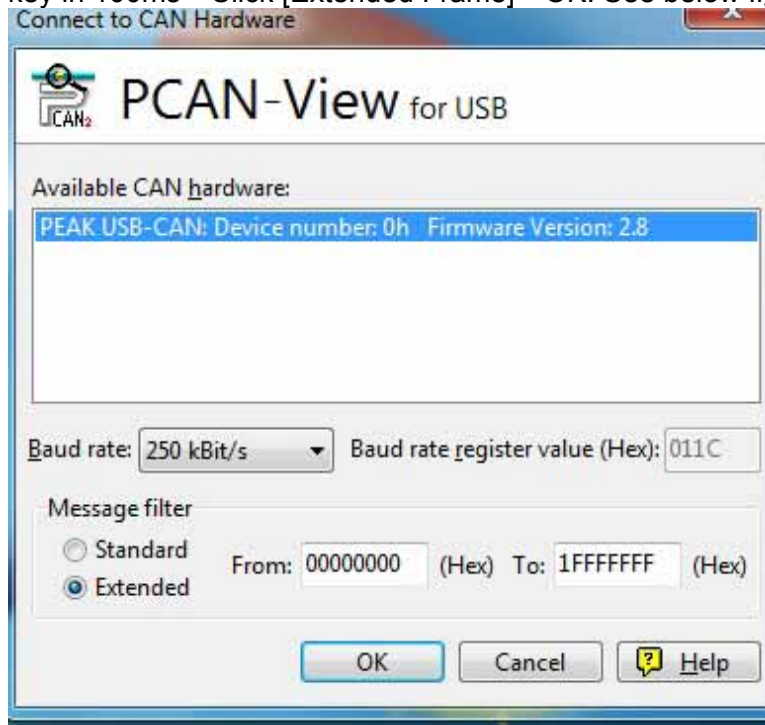

Figure 6. 11



Figure 6. 12

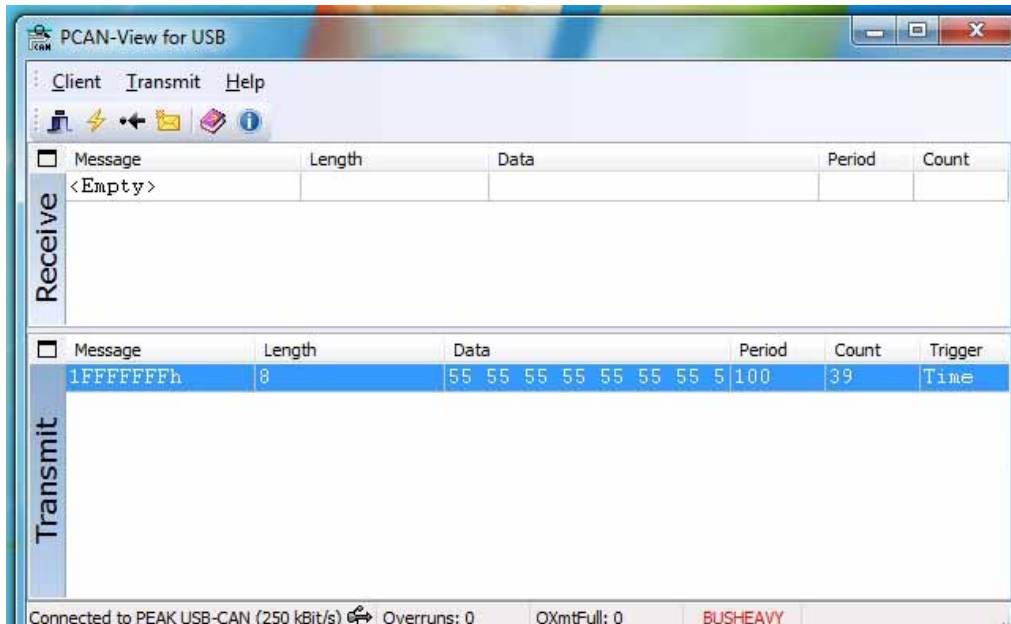

Figure 6. 13

3. Then you may read the data of TREK-550 from Console PC, in the same time, you may also press [Write Data] to write to Console PC. As for Filter Message, it can filter out the message you don't need, and keep the message you need. See below Figure 6.

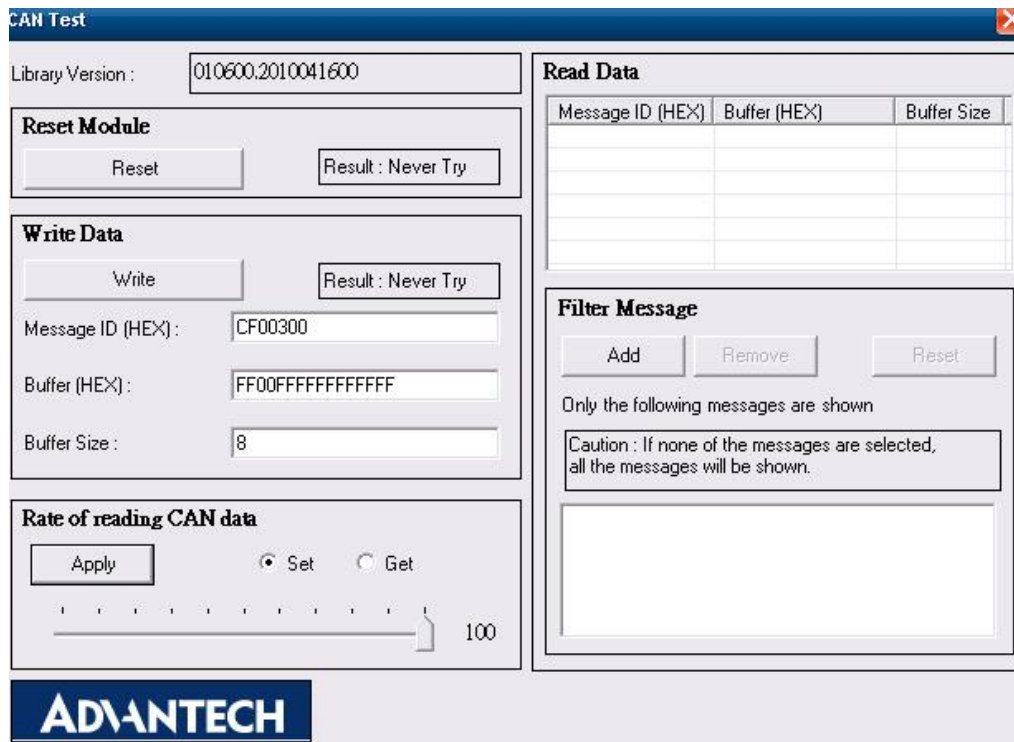

Figure 6. 14

6.2 RTC test

Execute “RTC test”

1. **For RTC Time setting:** You may set year, month, date, and time show as below.

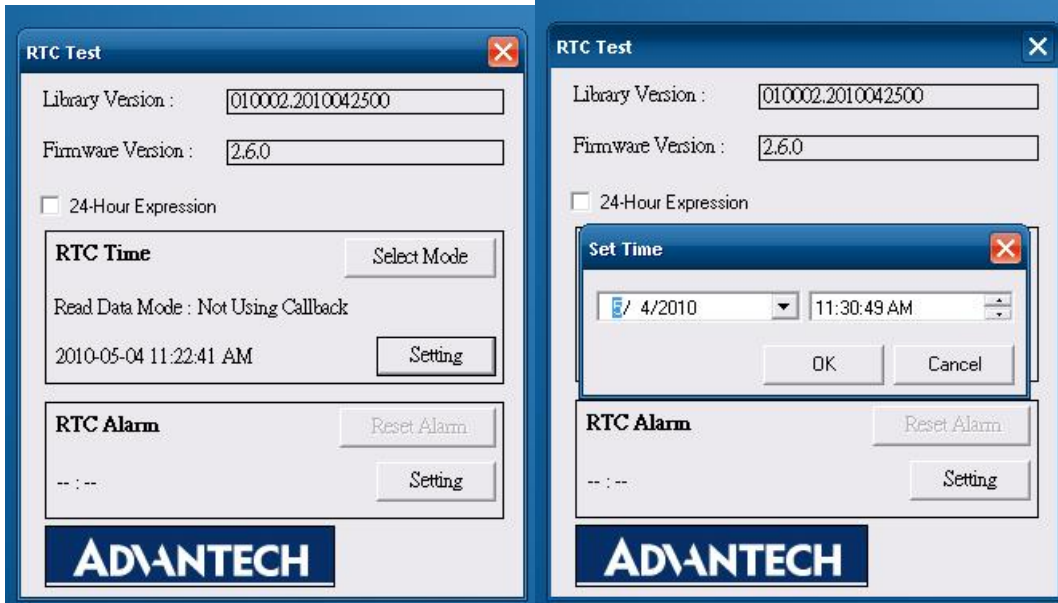

Figure 6.5

Figure 6.6

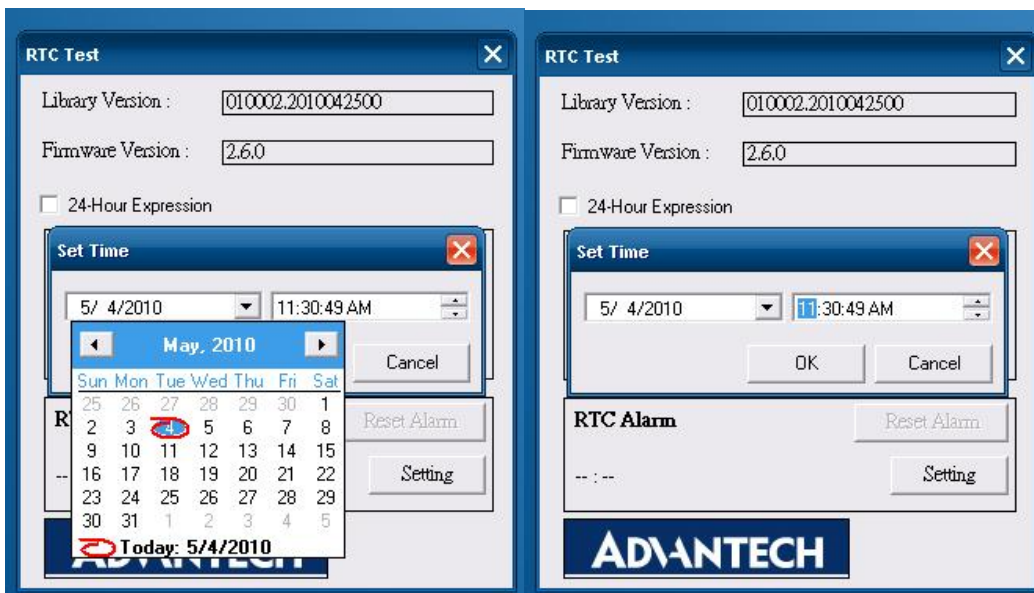

Figure 6.7

Figure 6.8

2. **RTC Alarm Setting:** You may also set Alarm time; you may wake up the system by the time you have set. Please refer to below figure 6.

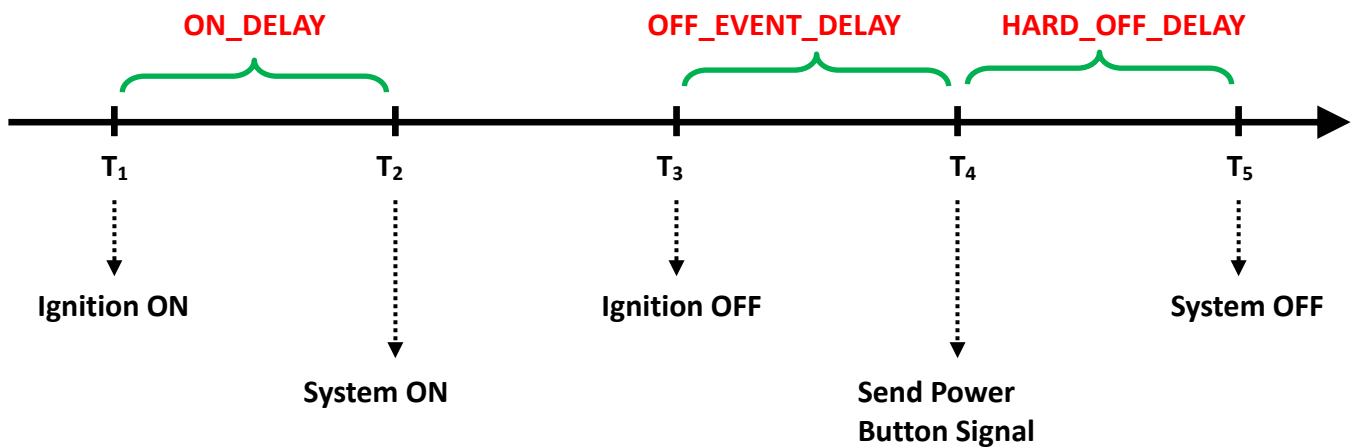

Figure 6.9

6.3 Power Management

6.3.1 Power management Mechanism

Normal Power Management Flow



Low Battery Protection

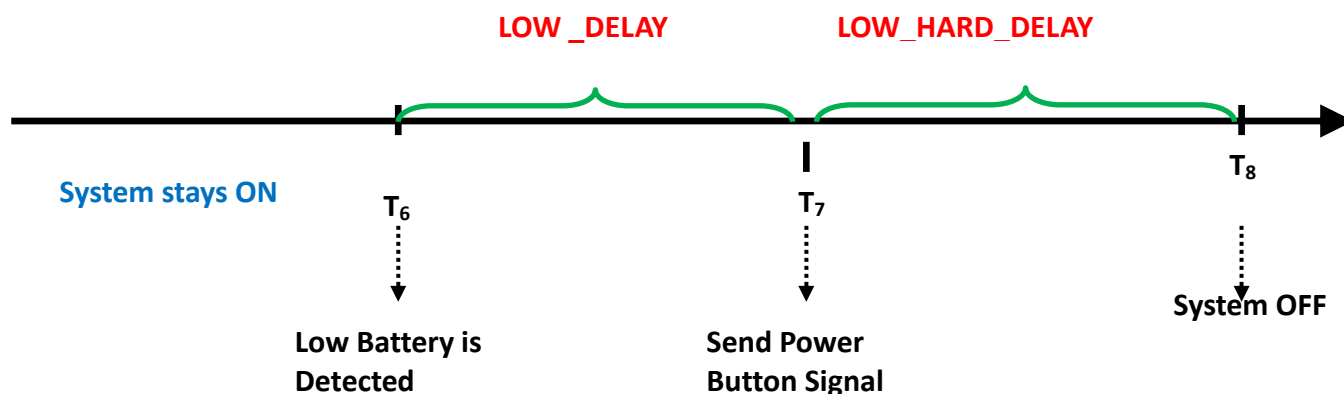

When the system is ON, and

(1) The battery voltage (DC input) is lower than **LOW_THRESHOLD** (at T₆)

(2) and this situation lasts for **LOW_DELAY**,

, then the system will send Power Button signal to OS (at T₇) to start the shutdown process.

At this time (T₇), the **LOW_HARD_DELAY** is starting to countdown.

Once **LOW_HARD_DELAY** is over, the system power is removed abruptly.

Before T ₁	The system stays off. power is fed in, but Ignition is OFF.
T ₁	Ignition is ON and the ON_DELAY is starting to count down.
T ₁ ~ T ₂	This duration is and it is ranged from 1 to 18000 seconds.
T ₂	Once the ON_DELAY is over, the system will stay On or OFF, depending on the BIOS setting "POWER-ON after Power Fail". If "POWER-ON after Power Fail" is set as ON, the system will be powered ON. If "POWER-ON after Power Fail" is set as OF, the system will stay OFF and you could press the power button to turn on system.
T ₂ ~ T ₃	The system is under normal operation.
T ₃	At this time, the Ignition is OFF, and OFF_EVENT_DELAY is starting to count down.
T ₃ ~ T ₄	This duration is OFF_EVENT_DELAY and it is ranged from 1 to 18000 seconds.
T ₄	When the OFF_EVENT_DELAY is over, the system will send a power button signal to the OS and the user application should prepare the shutdown process. The HARD_OFF_DELAY is starting to count down.
T ₄ ~ T ₅	This duration is HARD_OFF_DELAY and it is ranged from 1 to 18000 seconds.
T ₅	When the HARD_OFF_DELAY is count to zero, the system power is removed abruptly to avoid extra and abnormal power drain from battery. This parameter is fixed with a value of 60 seconds.
After T ₅	The system stays off.

LOW_DELAY is ranged from 1 to 3600 seconds.

LOW_HARD_DELAY is fixed with a value of 60 seconds.

Note:

Q1: How is the low-battery event raised or canceled?

A1: The minimum value on LOW_DELAY parameter is 1 second. If the voltage remains lower than the LOW_THRESHOLD in the duration of LOW_DELAY, the low-battery event will be raised and immediately send a power button press signal to OS.

During the duration of LOW_DELAY, if the battery voltage is back to be higher than LOW_THRESHOLD, the LOW_DELAY will be reset to predetermined value and stop count down.

Therefore, the LOW_DELAY parameter acts as a filter to prevent incorrect low-battery-event from happening.

6.3.2 Power Management demo program

A. Check the files.

Make sure that there are two components include in TREK-550 Power Management Tool. One is "AdvXP_CAN.dll", another one is "TREK-550 Power Manager.exe".



B. Start up the program

Execute Power Management tool and you will see a message box shows "Connect OK".



Then Click OK button and you will see the main page as below.

6.3.3 Power Management Parameter settings

The parameters for power management on TREK-550 could be set by Demo program (see the image below) or SDK/API.

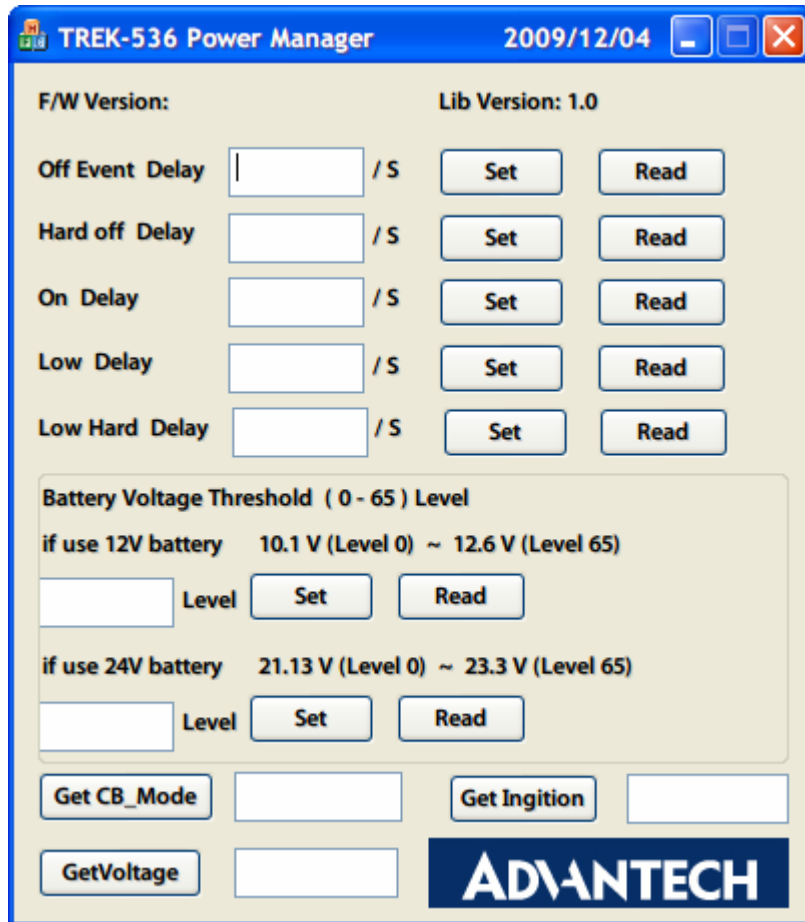

Figure 6.9 power management demo utility

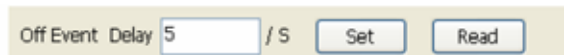

Figure 6.9 Off event delay

Off Event Delay – it means after 5 seconds delay from receiving of ignition OFF signal, EC controller will send a shutdown event to make system start shutdown process

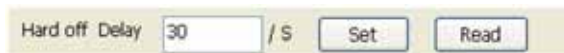

Figure 6.9 Hard Off delay

Hard off Delay – it means after 30 seconds from shutdown event, EC controller will force power cut off at the same time.

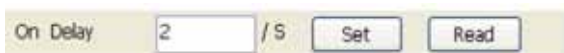

Figure 6.9 On delay

On Delay – it means after 2 seconds from receiving of ignition ON signal, EC controller will send a power-on event to make system start booting process.

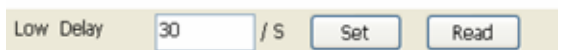

Figure 6.9 Low delay

Low Delay – it means after 30 seconds delay from receiving of Battery Voltage LOW signal, EC controller will send a shutdown event to make system start shutdown process.



Figure 6.9 Low hard delay

Low Hard Delay – it means after 60 seconds from Low Voltage shutdown event, EC controller will force power cut off at the same time

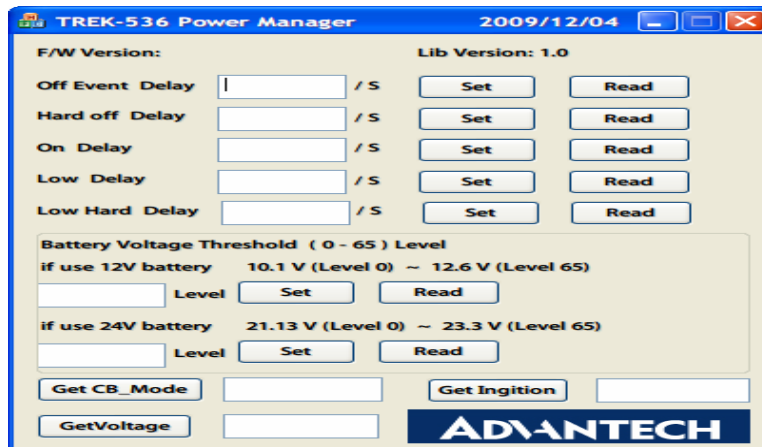

Figure 6.9 Battery voltage Threshold level setting

You could set the LOW battery voltage value by changing level 0 to 65. For example, if you're using 12V battery, and you set level as 50, it means the LOW battery voltage value is $10.147 + 50 \times 0.0146 = 10.877$ V.

Checks which source you're connecting. DC supply or 12V or 24V battery.



Figure 6.9 check 12 or 24 battery

Check the ignition signal and see if it's ON or OFF.

C. Read current status

The buttons which indicates by red squares can READ the current status of the system.

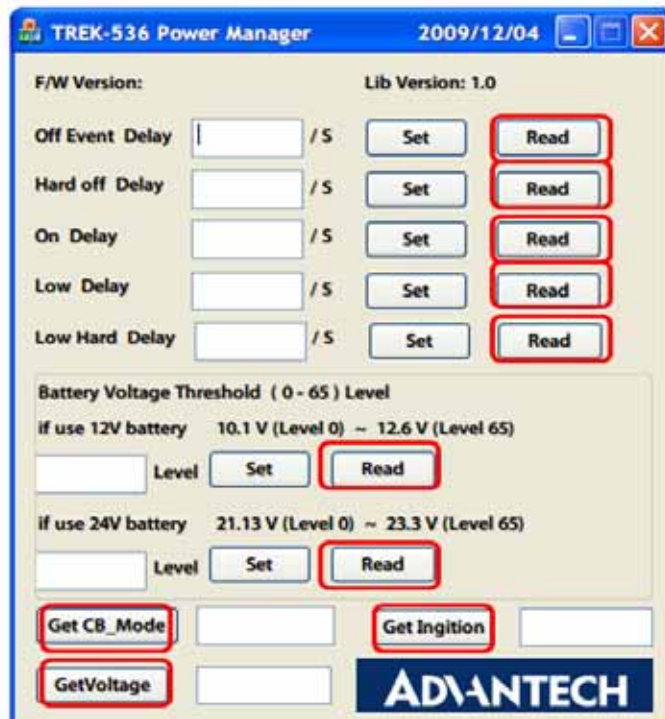
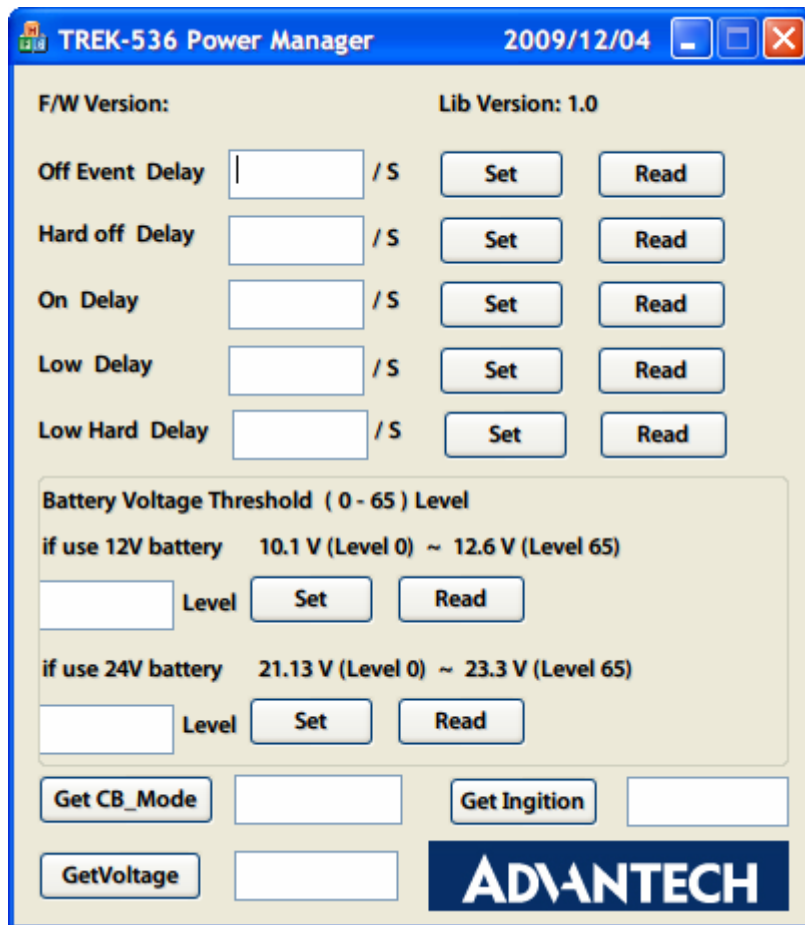

Figure 6.9 Read the value

D. Set the value

The buttons which indicates by blue squares can SET the value you want to the system.

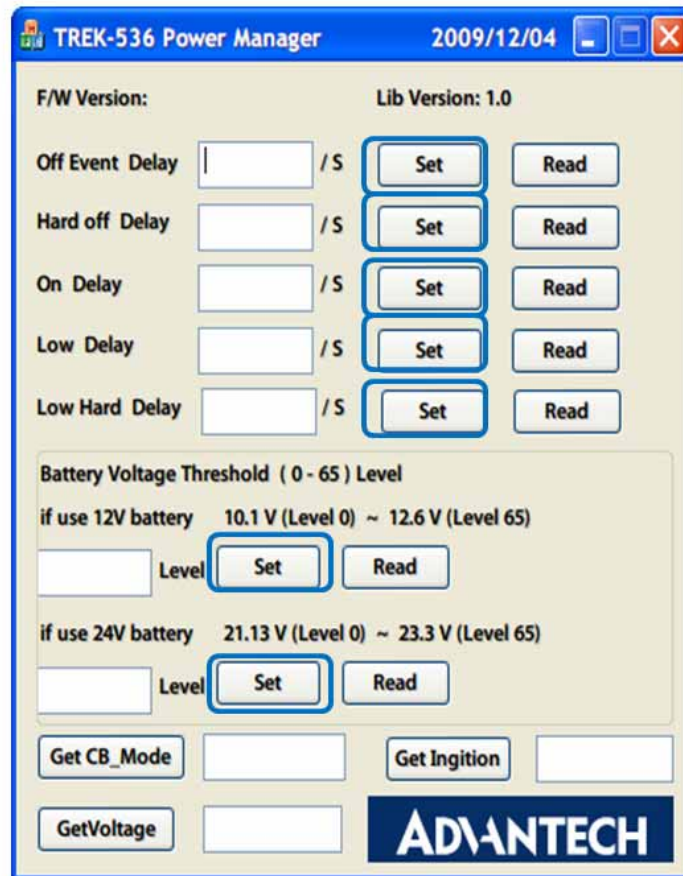

Figure 6.9 Set value

Execute “Power management test”, the Battery Voltage Level has 12V and 24V, you may set from 0~65 levels, press “Get” to know the value you set.

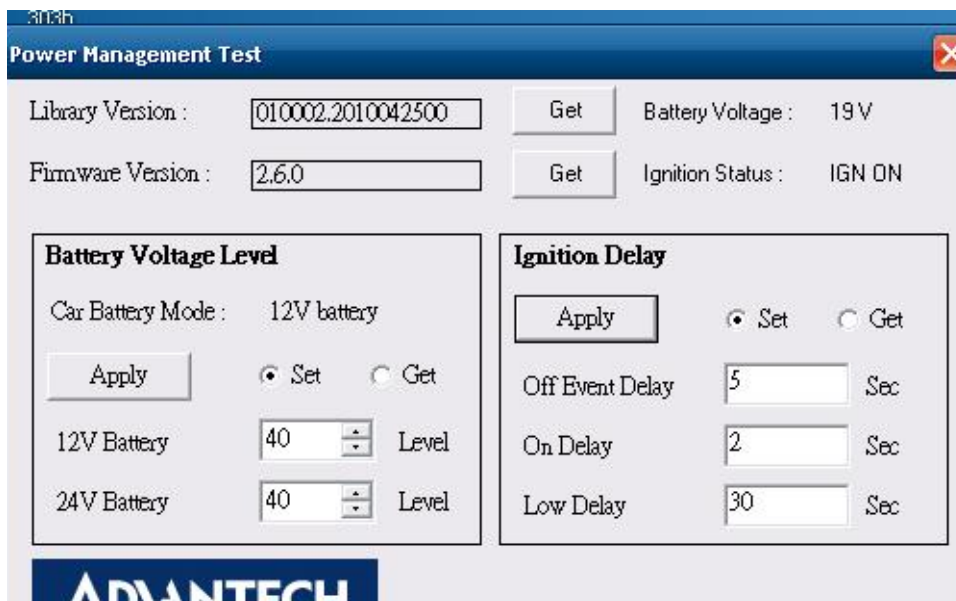

Figure 6.10

1. **Off Event Delay:** You may set how many seconds you want system auto shut down after ignition off.
2. **On Delay:** You may set how many seconds you want the system to auto power on.
3. **Low Delay:** When the battery voltage is below certain value you set, it will automatically shut down to prevent the system will consume the battery.

6.3.4 TREK-550 power consumption

OS: Windows Embedded Standard
Burn-in test V6.0

	Idle Mode	100% Burn-in Test Mode	Off mode (S5)
w/o TREK-303H	12V / 1.04A	12V / 1.20A	12V / 1.75mA
w/ TREK-303H	12V / 1.51A	12V / 1.94A	

*Doesn't support S1, S3, S4

6.4 GPIO Test

1. Execute I/O Test, connect GPIO loopback, click Pin0→Set, the end which Read the signal, the bulb will be light up, like wise to Pin1~Pin3. Next pick Digital output to execute the same procedure. See **figure 6**.

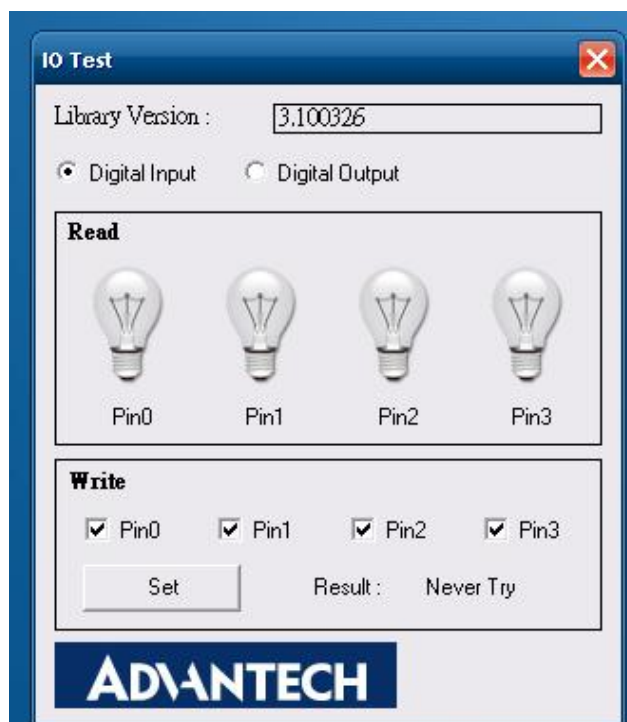

Figure 6.15

- a. Digital Output → isolated relay driver output
- b. Digital Input → isolated dry contact input

For Digital In

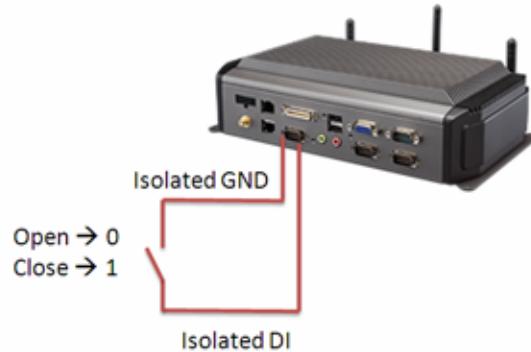

Figure 6.15 Digital in

For Digital Out



DO could control 12/24/48 Vdc @ 150mA relay without over wheeling diode

Figure 6.15 Digital out

6.5 Video in Test

There are two video in, please connect camera on each port, CAM1 & CAM2, choose Channel 1 on [Switch to], then panel will show the image which camera1 has taken, it will recover to the same status after 10 sec, then change to Channel 2, Panel will show what appears on camera2, and come back to the same status after 10 sec.

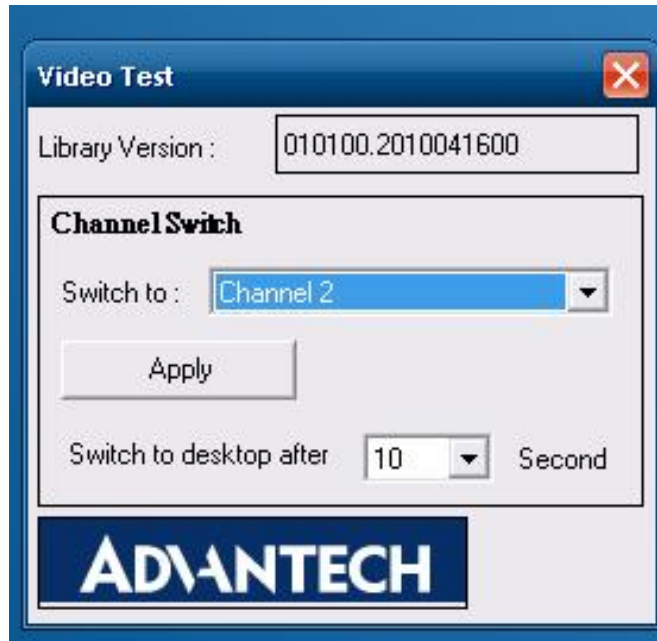

Figure 6.16

6.6 Dead reckoning

We will need a 3-axis accelerometer that our software can talk to. We use this to characterize driver behavior such as hard accelerations, braking, and cornering. This also can tell us other significant information that can be used in accident reconstruction, etc... This one of the crucial items that we asked for in our specification and our customers' expectations are making this a definite must have in our system. We won't be needing any dead reckoning functionality at this point in time... this is something we may want to include in the future but in order to get cost down we have decided to forgo this at this time. Please confirm that we will have access to this or another accelerometer.

6.7 G- sensor

We currently, we don't have documents about G-sensor, but a code example is ready for customer reference. This code example ONLY introduces how to access the G-sensor under Windows XP/XPe, but users must control the G-sensor and develop their SW application by themselves. Therefore, customer can decide how to set the sensitivity value when to trigger G-sensor to send signal to CPU and to back end server through WWAN module. G-sensor is located on the motherboard inside the TREK-550. Please refer the link (http://www.analog.com/static/imported-files/data_sheets/ADXL345.pdf) for the G-sensor datasheet.

Appendix **A**

TREK-303

This appendix explains the
TREK-303 detailed information.

Appendix A Paired with TREK-303 Specifications

Table 1.1: TREK-303 Specifications

Definition	Detail
	Display type:
	7" TFT LCD Max.
resolution:	800 x 480
Colors:	262K
Dot size (mm)	0.0635 x 0.1905
Luminance:	500 cd/m2
Viewing Angle (R/L/B/T)	70° / 70° / 60° / 60°

- Note!** 1. *The Brightness control is adjusted by the auto light sensor in the front panel as default; it is also defined by button on the front panel by manual.*



2. *The color LCD display*



- A. USB Host
 B. 5 programmable hotkeys
 C. D. Brightness control
 E. Power LED
 F. Light sensor
 G. Speaker

Note: Backlight off: Press C button to the lowest level



Power button LVDS connector

TREK-303 Specification

Display	Models	TREK-303R-LA0E	TREK-303R-HA0E
	Design Compatible Models	paired with TREK-510	paired with TREK-550
	Resolution(pixel)	480 x 234	800 x 480
	Number of Colors	262 K (supports 18-bit)	262K (supports 24-bit)
	Pixel Pitch	0.107 (W) x 0.37 (H)	0.2168 (H) x 0.2168 (V)
	Brightness (cd/m ²)	500 (typical) without touchscreen	500 (typical) without touchscreen
	View Angle (R/L/B/T)	70° / 70° / 60° / 60°	70° / 70° / 60° / 60°
	Contrast Ratio	300	500
	Lamp Life (hrs)	10,000 (min)	50,000 (min)
	Lamp Type	CCFL	LED
Touchscreen	Touchscreen	4-wire resistive (GFG 4-wire design reserve)	
Front plane	Speaker	2 watts	
	Hotkey	Supports 5 hotkeys (user defined)	
	Brightness Control	Light sensing (default), manually controlled by button (optional)	
Back plane	USB Host	x 1	
	Power /Wake Up Button	Yes	
	Reset Button	Yes	
Power	DC Input	12V + 5%	
	Power Consumption	~8W (Max.)	~7W (Max.)
Mechanical	Mounting	Design compatible with RAM mount	
	Material	PC	
	Weight	1 kg	
	Dimensions	244 x 160 x 41 mm	
	IP rating	IP54 (without I/O connector)	
Environment	Operating Temperature	-30 to + 70° C	
	Storage Temperature	-40 to + 80° C	
	Vibration	MIL-STD-810F, SAE J1455 4.9.4.2	

TREK-303 demo SW application program

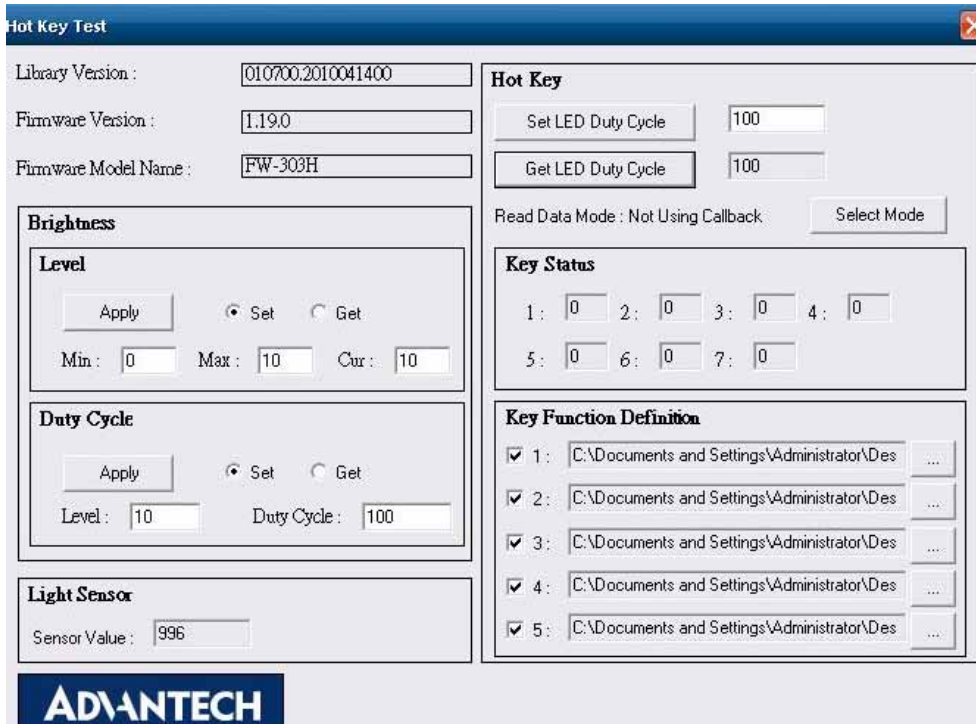

Figure 6. 17

1. Execute “**Hot Key test**” program →
2. **Brightness level:** You may set panel’s brightness from level 0 ~10, total 10 levels, when you finish setting the brightness level you want, please click “Apply”. If you want to check the current brightness level of TREK-303, please click “Get”.
3. **Duty cycle:** You may set every level’s brightness strength, total 10 levels, when you finish setting the brightness strength for each level, please click “Apply”. If you want to check the current brightness strength on certain level of TREK-303, please click “Get”.
4. **Light sensor:** When the sensor has detected the change of the brightness in the environment, the value will change. The lowest level of brightness, the lowest value it is presented. On the contrary, the highest level of brightness, the highest value it is presented.
5. **Hotkey:** You may set the hotkey LED light brightness, the value is from 0 ~100.
6. **Key Status:** When you press Hot key, the status will change from 0 to 1.
7. **Key function Definition:** You may set the parameter to connect the application program of the hot key.

www.advantech.com

Please verify specifications before quoting. This guide is intended for reference purposes only.

All product specifications are subject to change without notice.

No part of this publication may be reproduced in any form or by any means, electronic, photocopying, recording or otherwise, without prior written permission of the publisher.

All brand and product names are trademarks or registered trademarks of their respective companies.

© Advantech Co., Ltd. 2010