

User Manual

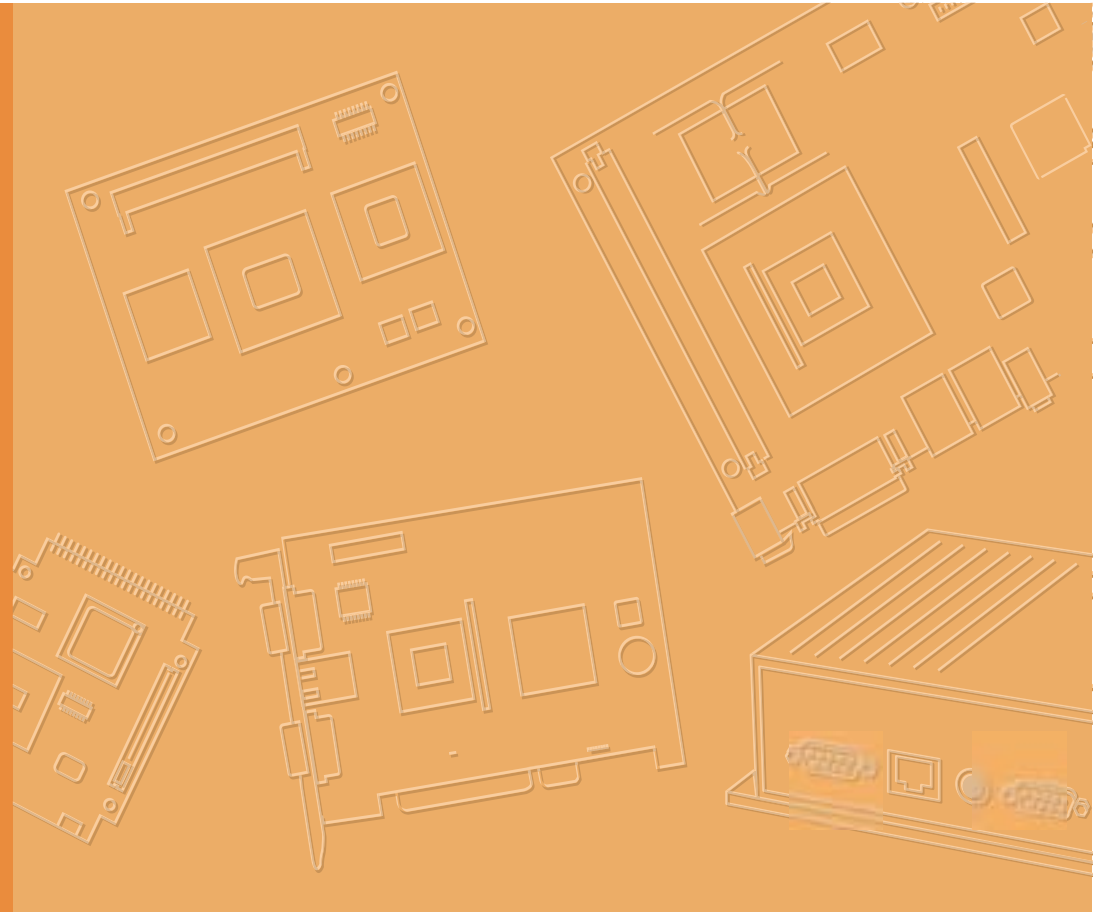

# TREK-753 Computer



---

## Copyright

The documentation and the software included with this product are copyrighted 2010 by Advantech Co., Ltd. All rights are reserved. Advantech Co., Ltd. reserves the right to make improvements in the products described in this manual at any time without notice. No part of this manual may be reproduced, copied, translated or transmitted in any form or by any means without the prior written permission of Advantech Co., Ltd. Information provided in this manual is intended to be accurate and reliable. However, Advantech Co., Ltd. assumes no responsibility for its use, nor for any infringements of the rights of third parties, which may result from its use.

## Acknowledgements

Intel and Atom are trademarks of Intel Corporation.

Microsoft Windows and MS-DOS are registered trademarks of Microsoft Corp.

All other product names or trademarks are properties of their respective owners.

## Product Warranty (2 years)

Advantech warrants to you, the original purchaser, that each of its products will be free from defects in materials and workmanship for two years from the date of purchase.

This warranty does not apply to any products which have been repaired or altered by persons other than repair personnel authorized by Advantech, or which have been subject to misuse, abuse, accident or improper installation. Advantech assumes no liability under the terms of this warranty as a consequence of such events.

Because of Advantech's high quality-control standards and rigorous testing, most of our customers never need to use our repair service. If an Advantech product is defective, it will be repaired or replaced at no charge during the warranty period. For out-of-warranty repairs, you will be billed according to the cost of replacement materials, service time and freight. Please consult your dealer for more details.

If you think you have a defective product, follow these steps:

1. Collect all the information about the problem encountered. (For example, CPU speed, Advantech products used, other hardware and software used, etc.) Note anything abnormal and list any onscreen messages you get when the problem occurs.
2. Call your dealer and describe the problem. Please have your manual, product, and any helpful information readily available.
3. If your product is diagnosed as defective, obtain an RMA (return merchandise authorization) number from your dealer. This allows us to process your return more quickly.
4. Carefully pack the defective product, a fully-completed Repair and Replacement Order Card and a photocopy proof of purchase date (such as your sales receipt) in a shippable container. A product returned without proof of the purchase date is not eligible for warranty service.
5. Write the RMA number visibly on the outside of the package and ship it prepaid to your dealer.

Part No.  
Printed in Taiwan

Edition 1  
August 2011

# Declaration of Conformity

## CE

This product has passed the CE test for environmental specifications. Test conditions for passing included the equipment being operated within an industrial enclosure. In order to protect the product from being damaged by ESD (Electrostatic Discharge) and EMI leakage, we strongly recommend the use of CE-compliant industrial enclosure products.

## FCC Class B

Note: This equipment has been tested and found to comply with the limits for a Class B digital device, pursuant to part 15 of the FCC Rules. These limits are designed to provide reasonable protection against harmful interference in a residential installation. This equipment generates, uses and can radiate radio frequency energy and, if not installed and used in accordance with the instructions, may cause harmful interference to radio communications. However, there is no guarantee that interference will not occur in a particular installation. If this equipment does cause harmful interference to radio or television reception, which can be determined by turning the equipment off and on, the user is encouraged to try to correct the interference by one or more of the following measures:

- Reorient or relocate the receiving antenna.
- Increase the separation between the equipment and receiver.
- Connect the equipment into an outlet on a circuit different from that to which the receiver is connected.
- Consult the dealer or an experienced radio/TV technician for help.

## Technical Support and Assistance

1. Visit the Advantech web site at <http://support.advantech.com> where you can find the latest information about the product.
2. Contact your distributor, sales representative, or Advantech's customer service center for technical support if you need additional assistance. Please have the following information ready before you call:
  - Product name and serial number
  - Description of your peripheral attachments
  - Description of your software (operating system, version, application software, etc.)
  - A complete description of the problem
  - The exact wording of any error messages

You are cautioned that changes or modifications not expressly approved by the party responsible for compliance could void your authority to operate the equipment.

According to FCC 15.407(e), the device is intended to operate in the frequency band of 5.15GHz to 5.25GHz under all conditions of normal operation. Normal operation of this device is restricted to indoor used only to reduce any potential for harmful interference to co-channel MSS operations.

---

## Warnings, Cautions and Notes

**Warning!** Warnings indicate conditions, which if not observed, can cause personal injury!



**Caution!** Cautions are included to help you avoid damaging hardware or losing data. e.g.



There is a danger of a new battery exploding if it is incorrectly installed. Do not attempt to recharge, force open, or heat the battery. Replace the battery only with the same or equivalent type recommended by the manufacturer. Discard used batteries according to the manufacturer's instructions.

**Note!** Notes provide optional additional information.



## Document Feedback

To assist us in making improvements to this manual, we would welcome comments and constructive criticism. Please send all such - in writing to: [support@advantech.com](mailto:support@advantech.com)

## Packing List

Before setting up the system, check that the items listed below are included and in good condition. If any item does not accord with the table, please contact your dealer immediately.

- TREK-753 series Computer
- USB/LAN cable clip
- Warranty card
- Power cord: DC power inlet cable (200 cm - for TREK-753 only)
- WLAN Antennas (by options)
- "Drivers, Utilities and User Manual" CD-ROM
- End User License Agreement (WES and WinCE model), please download driver and related document from <http://support.advantech.com>

# Ordering Information

Part Number	Description
TREK-753R-0A0E	TREK-753R Bare bone with Z510PT 1.1GHz CPU
TREK-753R-1A0E	TREK-753R Bare bone with Z520PT 1.3GHz CPU
TREK-753S-0A0E	TREK-753R Bare bone with 1.1G CPU/Sunlight readable touch screen

## Safety Instructions

1. Read these safety instructions carefully.
2. Keep this User Manual for later reference.
3. Disconnect this equipment from any AC outlet before cleaning. Use a damp cloth. Do not use liquid or spray detergents for cleaning.
4. For plug-in equipment, the power outlet socket must be located near the equipment and must be easily accessible.
5. Keep this equipment away from humidity.
6. Put this equipment on a reliable surface during installation. Dropping it or letting it fall may cause damage.
7. Do not leave this equipment in an environment unconditioned where the storage temperature under  $-30^{\circ}\text{C}$  ( $-22^{\circ}\text{F}$ ) or above  $60^{\circ}\text{C}$  ( $140^{\circ}\text{F}$ ), it may damage the equipment.
8. Do not operate this equipment in an environment temperature may over  $50^{\circ}\text{C}$  ( $122^{\circ}\text{F}$ ). The surface temperature of metal chassis may be scorch and hot.
9. Make sure the voltage of the power source is correct before connecting the equipment to the power outlet.
10. Position the power cord so that people cannot step on it. Do not place anything over the power cord. The voltage and current rating of the cord should be greater than the voltage and current rating marked on the product.
11. All cautions and warnings on the equipment should be noted.
12. If the equipment is not used for a long time, disconnect it from the power source to avoid damage by transient overvoltage.
13. Never open the equipment. For safety reasons, the equipment should be opened only by qualified service personnel.
14. If one of the following situations arises, get the equipment checked by service personnel:
  - The power cord or plug is damaged.
  - Liquid has penetrated into the equipment.
  - The equipment has been exposed to moisture.
  - The equipment does not work well, or you cannot get it to work according to the user's manual.
  - The equipment has been dropped and damaged.
  - The equipment has obvious signs of breakage.
15. This device complies with Part 15 of the FCC rules. Operation is subject to the following two conditions:
  - (1) this device may not cause harmful interference, and

- 
- (2) this device must accept any interference received, including interference that may cause undesired operation.
16. CAUTION: Always completely disconnect the power cord from your chassis whenever you work with the hardware. Do not make connections while the power is on. Sensitive electronic components can be damaged by sudden power surges.
  17. CAUTION: Always ground yourself to remove any static charge before touching the motherboard, backplane, or add-on cards. Modern electronic devices are very sensitive to static electric charges. As a safety precaution, use a grounding wrist strap at all times. Place all electronic components on a static-dissipative surface or in a static-shielded bag when they are not in the chassis.
  18. CAUTION: Any unverified component could cause unexpected damage. To ensure the correct installation, please always use the components (ex. screws) provided with the accessory box.

## Safety Precaution - Static Electricity

Follow these simple precautions to protect yourself from harm and the products from damage.

- To avoid electrical shock, always disconnect the power from your system chassis before you work on it. Don't touch any components on the main board or other cards while the system is on.
- Disconnect power before making any configuration changes. The sudden rush of power as you connect a jumper or install a card may damage sensitive electronic components.

- Warning!**
- 
1. *Input voltage rated: 6 ~ 36 Vdc (12/24V power) or 18 ~ 58 Vdc (48V power, option).*
  2. *Transport: carry the unit with both hands and handle with care.*
  3. *Maintenance: to properly maintain and clean the surfaces, use only approved products or clean with a dry applicator.*
  4. *CF/SD/SIM card: Turn off the power before inserting or removing CompactFlash storage cards.*

# Contents

<b>Chapter 1</b>	<b>General Information .....</b>	<b>1</b>
1.1	Introduction .....	2
1.2	General Specifications .....	3
1.3	Dimensions .....	5
	Figure 1.1 TREK-753 dimensions.....	5
<b>Chapter 2</b>	<b>System Setup .....</b>	<b>7</b>
2.1	A Quick Tour of the TREK-753 Computer .....	8
	Figure 2.1 Front view of TREK-753 .....	8
	Figure 2.2 Rear view of TREK-753 .....	8
	Figure 2.3 Side view of TREK-753 .....	9
	Figure 2.4 Bottom view of TREK-753 .....	9
2.2	Installation Procedures.....	10
2.2.1	Connecting the Power Cord.....	10
	Figure 2.5 Power connector photo.....	10
	Table 2.1: Pin Definition of Power Cord .....	11
2.2.2	Power Connector .....	11
	Figure 2.6 Power connector outlook .....	11
	Table 2.2: Power Connector.....	11
2.3	Running the BIOS Setup Program .....	12
2.4	Installing the Drivers for Win XP .....	12
<b>Chapter 3</b>	<b>Hardware &amp; Peripheral Installation ..</b>	<b>13</b>
3.1	Overview of Hardware Installation & Upgrading .....	14
3.2	Installing the Storage Device and SIM Card .....	14
3.3	Installing System Memory .....	15
3.4	Installing Optional Accessories .....	15
3.5	Installing IO Cover.....	16
3.6	Installing Wireless options.....	19
3.6.1	WLAN.....	19
	Figure 3.1 Top view of TREK-753 .....	19
3.6.2	GPS .....	29
	Figure 3.4 Bottom view of TREK-753 .....	29
<b>Chapter 4</b>	<b>Pin Assignments .....</b>	<b>31</b>
4.1	Rear Side Connectors.....	32
4.2	Power Connector .....	32
	Table 4.1: Power Connector.....	32
4.3	High density Connector.....	33
	Table 4.2: High Density Connector.....	33
4.4	RS-232 Connector (COM8).....	34
	Table 4.3: Table 5.5: RS-232 / RS-485 / J1708 Connector.....	34
4.5	LED Indicator .....	34

## Chapter 5 Software Demo Utility Setup ..... 35

5.1	Introduction .....	36
5.1.1	Execute J1939 Demo Utility.....	36
	Figure 5.1 IMC demo utility.....	36
	Figure 5.2 J1939 test - 1 & 2 .....	37
5.2	Hoy Key Test .....	37
	Figure 5.3 Hot Key .bmp.....	37
5.3	RTC Test.....	38
	Figure 5.4 RTC test - 1 & 2.....	38
	Figure 5.5 RTC test - 3 & 4.....	39
	Figure 5.9 RTC test - 5 .....	39
5.4	Vehicle Power Management .....	40
5.4.1	Power Management Mechanism .....	40
5.4.2	Power Management Utility Program .....	41
5.4.3	Power Management Parameter Settings.....	42
	Figure 5.10Power management test utility .....	42
5.4.4	TREK-753 Power Consumption.....	42
5.5	Execute CAN Demo Utility .....	43
	Figure 5.11CAN test .....	43
5.6	GPIO Test.....	44
	Figure 5.12DI/O test .....	44
	Figure 5.13Digital in.....	44
	Figure 5.14Digital out .....	45
5.7	Video in Test.....	45
	Figure 5.15 Video test utility .....	45
5.8	Audio Test.....	46

## Appendix A High Density Cable Pin Assignment 47

A.1	Standard USB A type female connector .....	48	
	Table A.1: Standard USB A type female connector.....	48	
A.2	Video input, BNC female connector .....	48	
	Table A.2: Video input, BNC female connector .....	48	
A.3	RS-232 connector (DB9 male).....	49	
	Table A.3: RS-232 connector (DB9 male) .....	49	
A.4	4DI /4DO & RS-485 (DB15 male type) .....	49	
	Table A.4: 4DI /4DO & RS-485 (DB15 male type).....	49	
A.5	CAN Bus & J1708 (Terminal Block 6P, 5.08mm pitch).....	50	
	Table A.5: CAN Bus & J1708 (Terminal Block 6P, 5.08mm pitch)	50	
A.6	Power extension connector (Terminal Block 3P, 5.08mm pitch) .....	50	
	Table A.6: Power extension connector (Terminal Block 3P,	5.08mm pitch).....	50
A.7	High Density & Connector Pin List.....	51	

## Appendix B EWF(Enhanced Write Filter)Manager SOP 53

B.1	EWF(Enhanced Write Filter)Manager SOP .....	54
-----	---	----



# Chapter 1

## General Information

This chapter gives background information on the TREK-753 Computer

Sections include:

- Introduction
- General Specifications
- Dimensions

# 1.1 Introduction

Advantech-DLoG's TREK-753 is a new generation, all-in-one 7" Computer with touchscreen. Its compact and rugged industrial design is perfect for in-vehicle use where space, vibration, transient power, and temperature fluctuations will damage most computer equipment. TREK-753 is the higher performing cousin of the award-winning TREK-743 with its Intel® Atom™ Z510PT/US15 processor, increased memory, the addition of an analog video input port, GbE LAN, and a rich complement of I/O ports (additional COM ports, audio, CAN bus, and J1708). TREK-753 has also been re-engineered to optimize internal space, gained by its full-flat panel touchscreen; and it has moved the CF/SD/SIM card slot to make it externally accessible, allowing easy access without having to open the unit.

TREK-753 is built tough. It has an EN 60721-3-5 certification, and meets military standards for vibration and shock. This ruggedness allows TREK to boldly go where others dare not, opening a wide range of vertical market applications. TREK-753 is suitable for taxi and bus transport, in vehicle fleets of all types, in long-haul trucking, and as an affordable solution to heavy duty vehicle applications. TREK-753 is designed to operate flawlessly in transient power conditions. It supports 12/24 V options, operating from 6 ~ 36 volts, and it is ISO7637-2 and SAEJ1113 compliant. With power-on/power-off delay features which are software configurable, TREK holds its own in unstable power conditions. And TREK can operate in the temperature extremes found in vehicle environments.

## I/O Connectors

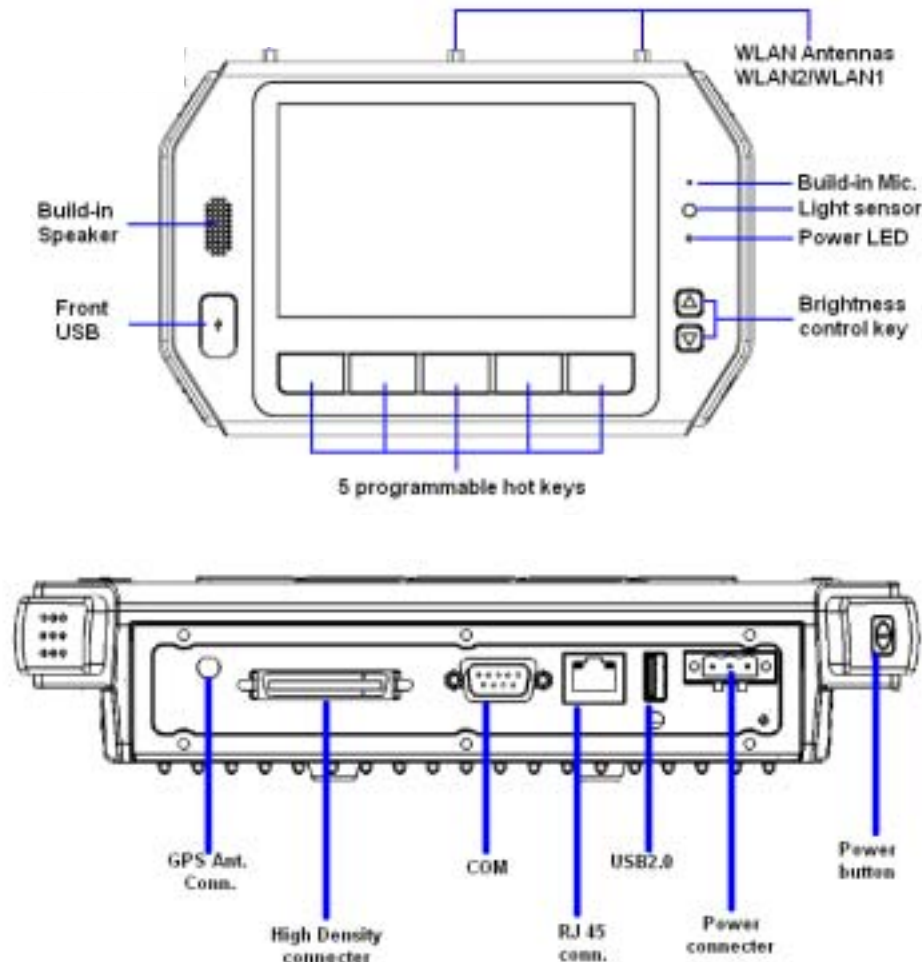

## 1.2 General Specifications

### Key features

- 7" WVGA LCD with 5 programmable adjustable brightness hot key
- Support Windows Embedded System(W.E.S.) & WinCE6.0 & Linux Ubuntu
- Analog video input, J1708 & CAN2.0b with J1939 protocol supported
- 
- 12V/24V option: 6~36V input range compliant to IOS7637-2 & SAE J1113
- 48V option: 18~58V input range for specific applications
- Fan-less and ruggedized chassis with aluminum able to work under -30° C ~ 60° C
- IP54 rating with whole system protection in harsh environment under shock & vibration (Passed EN60721-3-5 5M3 Shock/vibration 100G/4G test.)

### Specifications

- **Dimensions:** (W x H x D) - 255.7 x 161 x 56 mm (10.04" x 6.30"x2.20")
- **Weight:** 2.2 kg (max.)
- **Vehicle power feature:**
  - Input voltage: 6 ~ 36 Vdc, support ignition cold crank
  - Supports Ignition on/off
  - Supports low battery shut-down protection threshold (optional)
  - Supports power off event delay
  - Supports power on delay
  - Supports power low delay
  - Supports power low hard delay
  - Supports hard off delay
- **CPU/Chipset:** Intel industrial Atom (eMenlow) 1.1GHz /1.33GHz (optional)
- **Chipset:** On board Intel LE82US15EE
- **OS:** Windows Embedded System(W.E.S.) & WinCE6.0 & Linux Ubuntu
- **RAM:** One 200-pin SODIMM socket, Supports up to 2 GB DDR2 400/533
- **Storage:**
  - 1 x SD card with external access (not for boot device)
  - 1 x external accessible type II Compact Flash memory card only (boot device)
  - 1 x SIM card socket for GPRS/HSDPA
- **LCD:** Display Type 7" 16:9 industrial degree TFT LCD, 800x480 resolution LED backlight.
- **Touch screen:** Type 4 wires Analog resistive type, continuous resolution, optional to support sunlight readable TS
- **IO Function:**
  - 1 x video input port for rear view monitor (Note: bypass video to screen, not support video recording)
  - 1 x RS-232 COM port from rear IO; 1 x RS-232 COM port & 1x RS-485 port from high density connector.
  - 1 x USB 2.0 port from front panel; 1 x USB 2.0 port from rear IO; 1x USB 2.0 from high density connector
  - 1 x 100/1000-T Gb LAN by RJ45 connector
  - 1 x CAN 2.0B with J1939 protocol by High density connector
  - 1 x J1708 by High density connector
  - 1 x built-in 2.0w speaker & 1 x built-in microphone in front panel

- 
- 1 x Line-in/Line-out/Mic.in I/F by High density connector or switch to high density connector (by software)
  - 5 x green lighted, programmable function keys, 2 x for LCD brightness control
  - 1x light sensor on front cover for auto LCD brightness control
  - 4 x isolated DI & 4 x isolated DO
  - **RF Function:**
  - GPS: Built-in uBlox LEA-5S GPS module with external antenna in IO plate
  - Bluetooth: Built-in Class 2 Bluetooth V2.0 + EDR module
  - WWAN:
    - GPRS module by Cinterion MC55i with SMA type antenna
  - **WLAN:** Built-in 802.11b/g/n module with SMA type connector
  - **Power Supply:**
    - Input Voltage 12V/24V option support 6~36V car power design with ISO7637-2 & SAE J1113 compliant
    - 48v option support 18~58V input for specific application (Option)
  - **Mechanical Design:**
    - Aluminum chassis with Optional to support whole system IP54 by extended IO cover
    - Weight- under 2.2 kg (~4.85 lbs)
    - Dimensions (W x H x D) - 255.7 x 161 x 56 mm (10.04" x 6.30" x 2.20")
  - **Environmental Specifications:**
    - Operating Temperature : -30° C ~ 60° C
    - Relative Humidity 95% @ 40° C (No condensing)
    - Vibration & Shock: MIL-STD-810G (US highway truck), Method 516.5,
    - SAE J1455, Class 5M3 according DIN EN 60721-3-5 (Lv.2 100G, 6ms, shock)

### 1.3 Dimensions

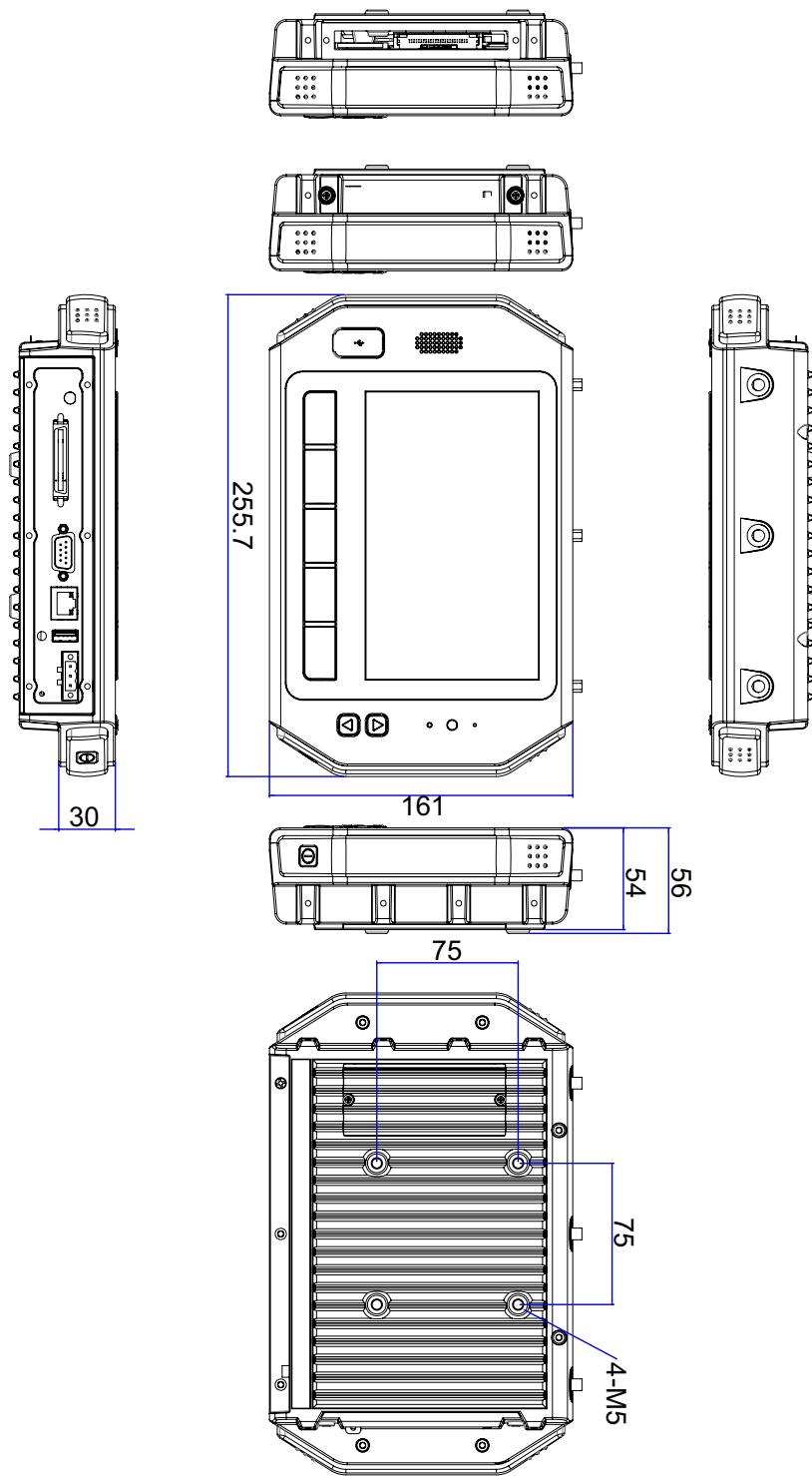

Figure 1.1 TREK-753 dimensions



# Chapter 2

## System Setup

This chapter details system setup on TREK-753.

Sections include:

- A Quick Tour of the Computer
- Installation Procedures
- Running the BIOS Setup Program
- Installing the Drivers for Win XP

## 2.1 A Quick Tour of the TREK-753 Computer

Before starting to set up the Computer, take a moment to become familiar with the locations and functions of the controls, drives, connectors and ports, which are illustrated in the figures below. When the Computer is placed inside truck glove cabinet or under the passenger's seat next to the driver, its front appears as shown in Figure 2.1.







**Figure 2.3 Side view of TREK-753**



**Figure 2.4 Bottom view of TREK-753**

## 2.2 Installation Procedures

When you installing TREK-753, the first step will be connect the car power and ignition correctly. TREK-753 power cable is designed to connect car battery directly. TREK-753 can be switched ON/OFF by the car ignition signal or its power button both.

**Note!** *TREK-753 power input support 12V/24V & 48V DC input. The default setting is for 12V or 48V (option board) only. If customer needs 24V DC input, please contact regional sales or distributors to customized in advance.*



**Note!** *The Fuse for 12V/24V (10A) system and for 48V (5A) in power cable are different. Please check the fuse in your power cable before system power on.*



### 2.2.1 Connecting the Power Cord

Connect the three pin waterproof power cord to the DC inlet of TREK-753. On the open-wire end, one pin is reserved for positive voltage and is marked "+" which needs to be connected to the car power "+" side; one pin is reserved for ground and is marked "-"; which needs to be connected to the car power "-" side. And, one pin is reserved for the ignition signal with an "ignition" mark. There's independent "Shield" pin in power cable, please fixed its O-ring which besides of power connector of TREK-753.

**Note!** *Ignition on/off setting: The TREK-753 supports an ignition on/off function so that you can power on/off the TREK-753 via the ignition signal/voltage and connect the TREK-753 vehicle ignition switch.*



Connector : DECA Switchlab ME050-50803

Mating connector: MC101-50803-3Y



**Figure 2.5 Power connector photo**

**Table 2.1: Pin Definition of Power Cord**

Pin	Definition	Color
1	+	Red
2	Shield	Black
3	-	Black
4	Ignition	Orange

## 2.2.2 Power Connector

TREK-753 can be powered on/off by power button or Acc ignition directly. Ignition on/off will have 5sec (default) delay when power on/off. It can avoid the floating car power supply impact or damage system operation. For more detail of power management, please see Power management in Chapter 5.

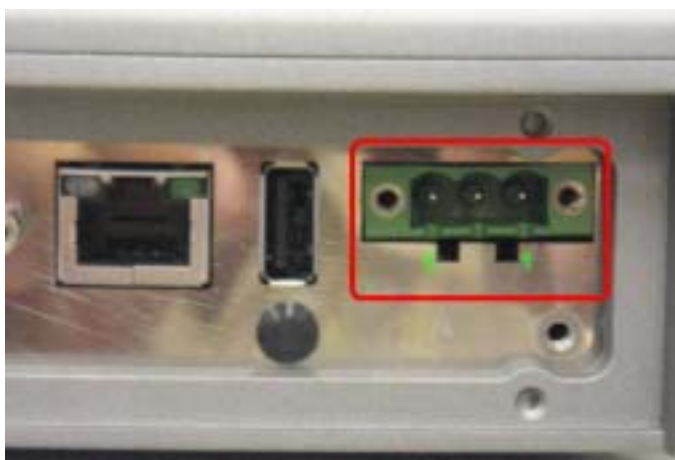
**Figure 2.6 Power connector outlook****Table 2.2: Power Connector**

Pin	Signal	Pin	Signal
1	Ground	2	Power input (6~36VDC;18~58VDC)
3	Acc Ignition Input		

## 2.3 Running the BIOS Setup Program

In most cases, the computer will have been properly set up and configured by the dealer or SI prior to delivery. However, it may still be necessary to adjust some of the computer's BIOS (Basic Input-Output System) setup programs to change the system configuration data, like the current date and time, or the specific type of hard drive currently installed.

The setup program is stored in read-only memory (ROM). It can be accessed either when turning on or resetting the computer, by pressing the "Del" key on the keyboard immediately after powering up the computer.

The settings that are specified with the setup program are recorded in a special area of the memory called CMOS RAM. This memory is backed up by a battery so that it will not be erased when turning off or resetting the system. Whenever the power is turned on, the system reads the settings stored in CMOS RAM and compares them to the equipment check conducted during the power on self-test (POST). If an error occurs, an error message is displayed on screen, and the user is prompted to run the setup program.

## 2.4 Installing the Drivers for Win XP

After installing system software, the computer is ready to set up the Intel® chipset, VGA, audio, LAN, and touch screen functions. All the pre-requisite drivers are stored on a CD-ROM disc entitled "Drivers and Utilities" (Check the correct wording on the CD, which can be found in the accessory box.)

The utility directory includes multimedia programs. Some drivers and utilities in the CD-ROM disc have their own text files which help users install the drivers and understand their functions.

These files are a very useful supplement to the information in this manual. For more updated driver please refers to Advantech website, [www.advantech.com/support](http://www.advantech.com/support)

The drivers for TREK-753 are listed as below, please just execute the drivers for installation.

Device	Version
Intel SCH INF Update	8.8.0.1011
Intel US15 GMA500 Graphic Driver	6.14.11.1018
PenMount Universal Driver	2.1.1.0
Realtek RTL8111DL 10/100/1000 PCI-E NIC	5.728.604.2009
Realtek ALC892 High Definition Audio	5.10.0.5804
FTDI FT4232 BUS USB Driver	2.6.0.0
Wireless LAN Card (SDC-PE15E)	1.4.2.1
BT-203B Utility BlueSoleil (Optional)	2.1.3.0

**Note!** *The drivers and utilities used for the TREK-753 are subject to change without notice. If you are in doubt, check Advantech's website or contact our application engineers for the latest information regarding drivers and utilities.*



# Chapter 3

## Hardware & Peripheral Installation

This chapter details the installation of hardware for TREK-753.

Sections include:

- Overview of Hardware Installation and Upgrading
- Installing the Storage Device and SIM Card
- Installing System Memory
- Installing the Drivers for Win XP

## 3.1 Overview of Hardware Installation & Upgrading

The Computer consists of a industrial computer that is housed in a ruggedized aluminum enclosure. Any memory module or storage maintenance or hardware upgrades can be completed after removing the rear side RAM door/ Side cover, or remove the front panel to install.

## 3.2 Installing the Storage Device and SIM Card

TREK-753 has a side door and user can install SIM card and storages (CF or SD card) easily. CF card is the main bootable storage which has OS pre-installed from Advantech. CF slot with a ejector (on the top side) then you can press and CF ejected from socket. SD card as a secondary storage in TREK-753, system is NOT allowed boot up from SD.

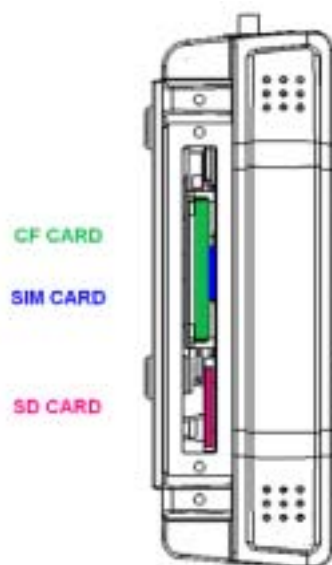

**Note!** Please do NOT paste any sticker or label on CF and SD , it might be jammed and not able to ejected from slot/socket.



### 3.3 Installing System Memory

TREK-753 support 200-pin SO DIMM type DDRII DRAM. There's a door can be open for RAM installation. It is very easy to open to install memory. But, we suggest this change performed by our service center to avoid any possible damage (like ESD or wrong position inserted).



**Note!** For system thermal design, please make sure the thermal pad on RAM door (Block in black) is always needs to be assembled before the door re-covered. (To bare bone system, thermal pad will be placed in the accessory box).



### 3.4 Installing Optional Accessories

Optional accessories, like RAM mount kits or other functional modules are available for purchase to complement TREK-753. All of standard 75mm type mounting with M5 type screws only.



## 3.5 Installing IO Cover

For TREK-753 whole system IP54 ability, here is a IP54 IO cover kit to mask all the connectors of bottom side. It's a rubber-metal kit includes a rubber cover, a screws mounting frame, batten & batten with boss.



From left to right: Rubber cover; mounting frame, batten with boss & batten, screws. Put the frame on the rubber cover, and lead all cables across the cover out side in.





Connect all cables to system and fix in tie before the cover installed.



There're 6 screws holes designed for extra mechanic part installation. The mounting frame needs to be fixed with these holes.



Install the cover by 6 screws installed. It will be easy to install rear side first (3 screws) first.



Then install frame with other 3 screws at top side.



Insert the batten with boss to the rubber cover. Please place all cables in the right position before another batten fixed in tight.



Installation complete.



## 3.6 Installing Wireless options

TREK-753 is a highly integrated all-in-one terminal, all wireless options are able to be installed at once and works by independent connection. In the standard OS companioned with TREK-753, all the wireless connections have been setup in advance and users will not have to setup again. These information provided for those who needs to build new wireless connections if necessary. RF options include:

Bluetooth

Wireless LAN(WLAN)

GPS

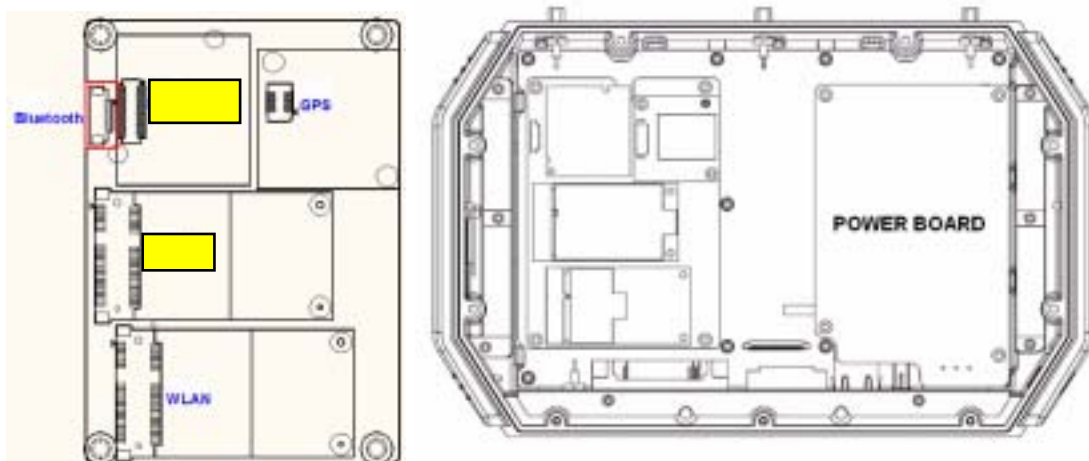

**Note!** All of hardware or reconfiguration changes should be performed by service center or authorized institutions of ADVANTECH.



### 3.6.1 WLAN

#### Driver installation

1. Make sure the Wi-Fi module has install to the TREK-753.



op view

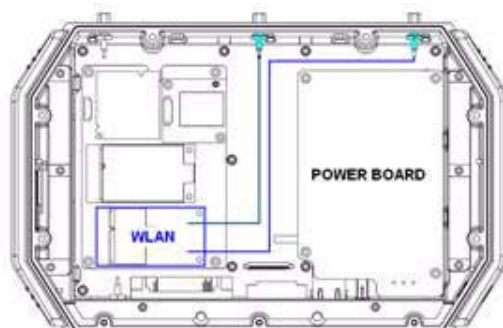

2. Make sure there is/are wireless router/AP working in same circumstance which TREK-753 is able to connect with.
3. Turn on the TREK-753, booting into OS.
4. Double click the "Setup.exe" in driver CD (WLAN\_AW-NE768\_090714) to install driver

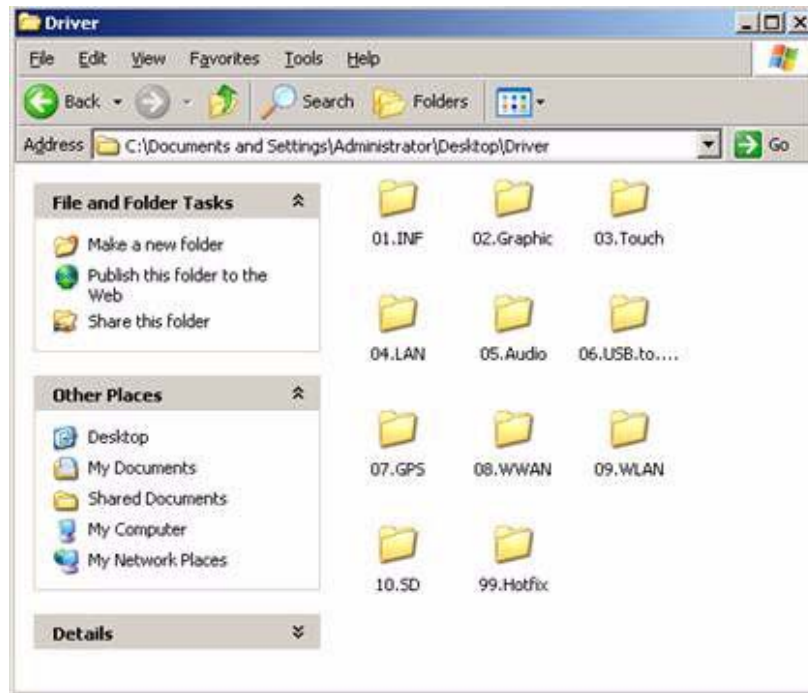

### Setup connection

1. Press Start - Control panel - Network connections - Press right button of mouse and select properties in Wireless Network connection, then click "View Available Wireless Networks".

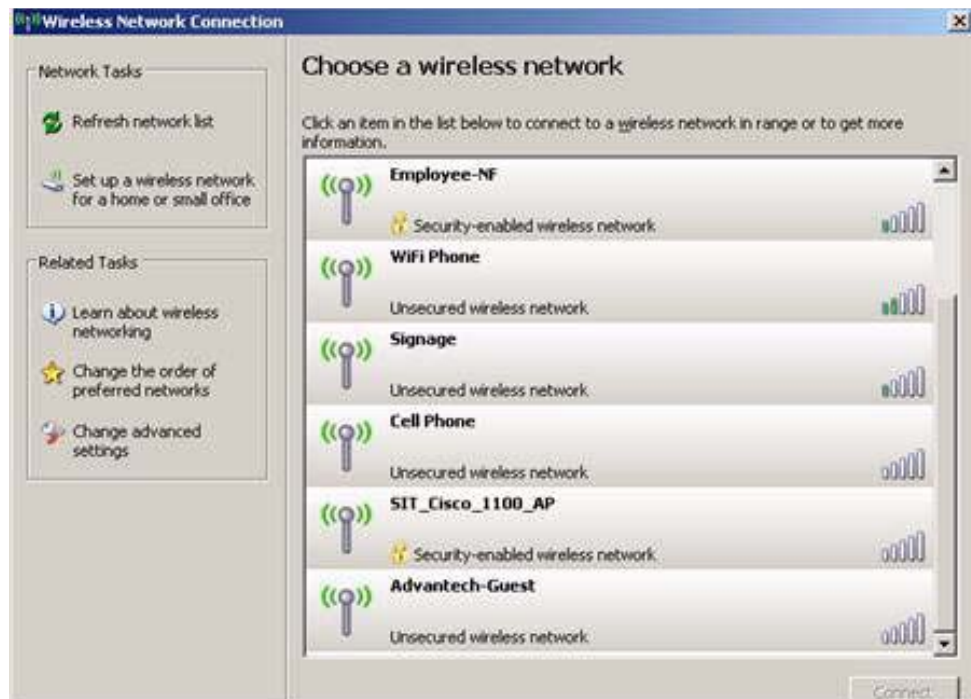

2. Double click the available wireless LAN icon on the down-right corner and search for AP devices.
3. There might have some APs devices appear with different SSID, choice the available one and connect with (might need to input user's ID & password)



4. Click "Connect" to connect with wireless AP. Open the web browser and TREK-753 will connect to internet.

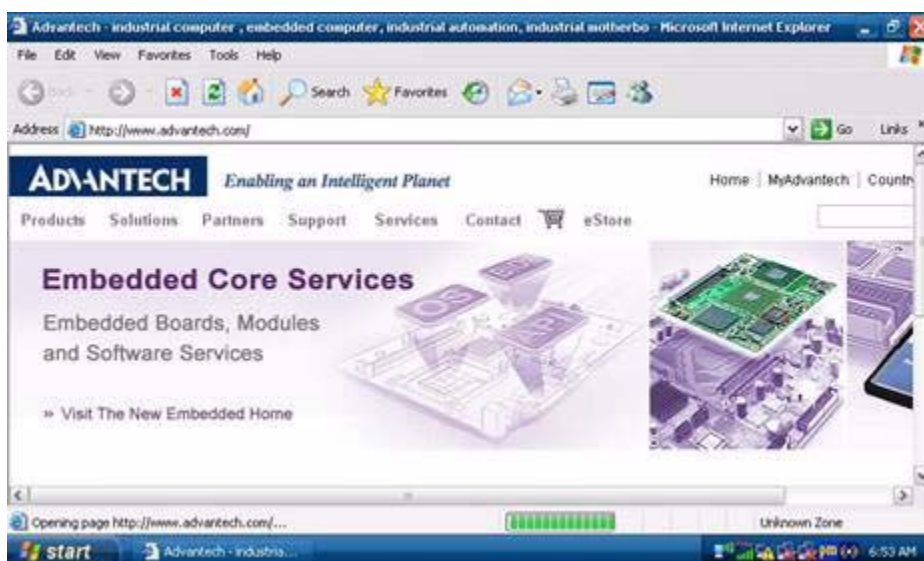
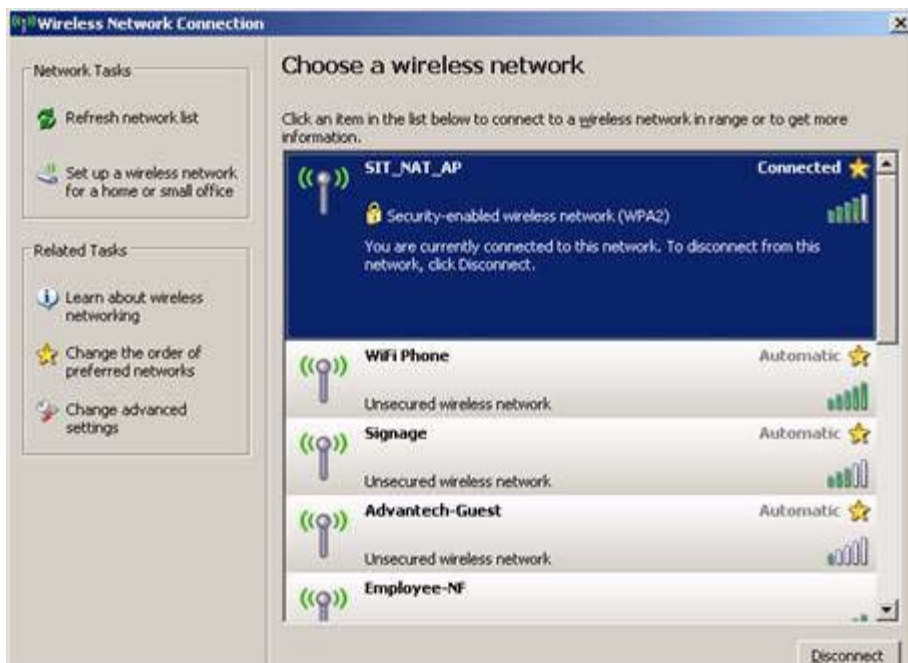

## 3.6.2 GPRS

### Driver installation

1. Make sure the Criterion MC55i GPRS module has install to the TREK-753.

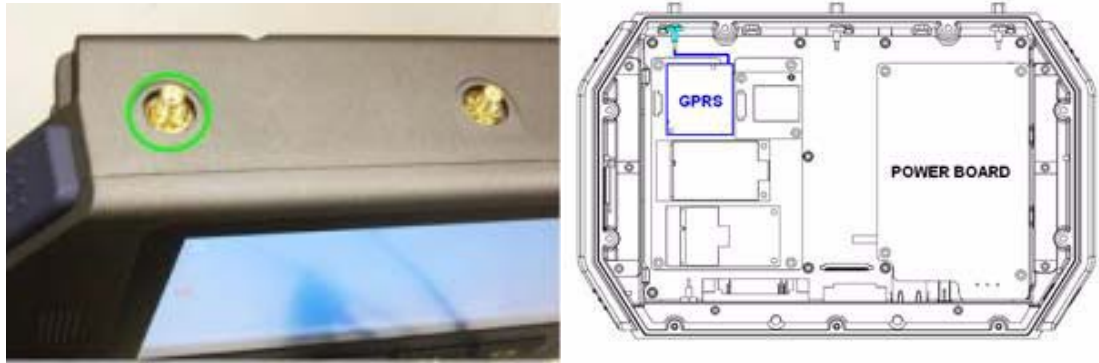

Figure 3.2 Top view of TREK-753

2. Insert the User's SIM card to slot of TREK-753, make sure the User's SIM card has applied the GSM and data transmit/receive service in advance.



3. Turn on the TREK-753, booting into OS.
4. GPRS(MC55i) connected with system by COM port interface, it don't have to install driver. But, please check the device manager without any question mark in advance.

### Setup connection

1. Press Start - Control Panel - Phone and Modem options.
2. Switch to Dialing rules tab, press button "New", input GPRS to the Location name, input "00" to Area code.



3. Switch to Modems tab, press button "Add", select the "Don't detect my modem; select it from a list" - Next.
4. Choose "Standard 19200 bps Modem" - Next.
5. Select COM port - Next - Finish, the screen will display the "standard 19200 bps Modem" item.
6. Press button "Properties", switch to Modem tap and select "Maximum Port Speed" change speed from 19200 to 115200 - press ok.
7. Switch to advanced tap, in extra setting textbox, input:at+cgdcont=1,"IP","internet" - press ok.
8. In the Network Connections Panel, Select Make New Connection.
9. In the Make New Connection Dialogue, choose "Connect to the Internet" , then click next.
10. Choose "Set up my connection manually", then click next.
11. Choose "Connect using a dial up modem", then click next.
12. Input ISP Name (ex: GPRS) then click next.
13. Do NOT input Phone number, User name and Password.
14. In completing the new connection wizard textbox, select "Add a shortcut to this connection to my desktop", then click Finish.
15. In the Network Connections Panel, press right button of mouse then select properties.
16. In the "Phone number textbox, input:\*99\*\*\*1#, then click Configure.



17. Change "Maximum speed (bps) to 115200, then click OK.
18. Once complete previous steps, the new connection will be created.
19. Double Click the new connection and Click Button "Dial", then the TREK-753 will connect to the internet.





### 3.6.5 GPS

#### Installation

1. Make sure the GPS module & antenna has install to the TREK-753.

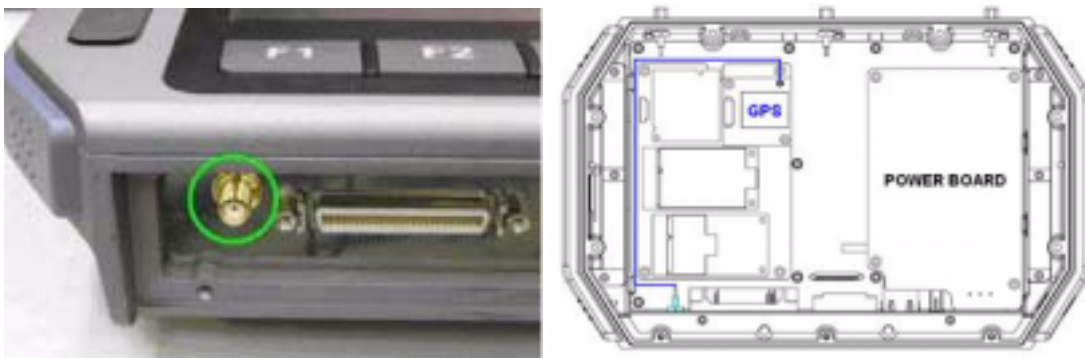

Figure 3.4 Bottom view of TREK-753

2. Turn on the TREK-753, booting into OS.
3. Double click the "ublox\_A4\_U5\_USB\_drv3264\_install\_UI.exe" application program in driver CD and install to TREK-753 OS.



## Setup connection

1. Install the "u-Center" for setup and test.



2. Start test in "u-Center", setting COM port (COM7) and baud rate (9600bps) use for GPS module.

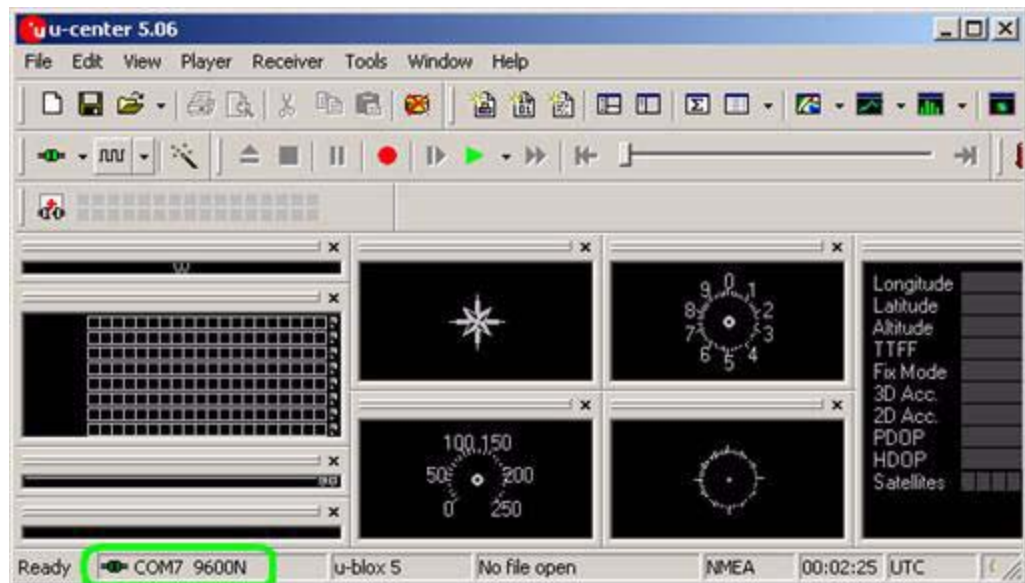

3. After start test, the NMEA output messages are display on the Development Data View setup connection.

# Chapter 4

## Pin Assignments

This chapter explains pin assignments on the TREK-753.

## 4.1 Rear Side Connectors

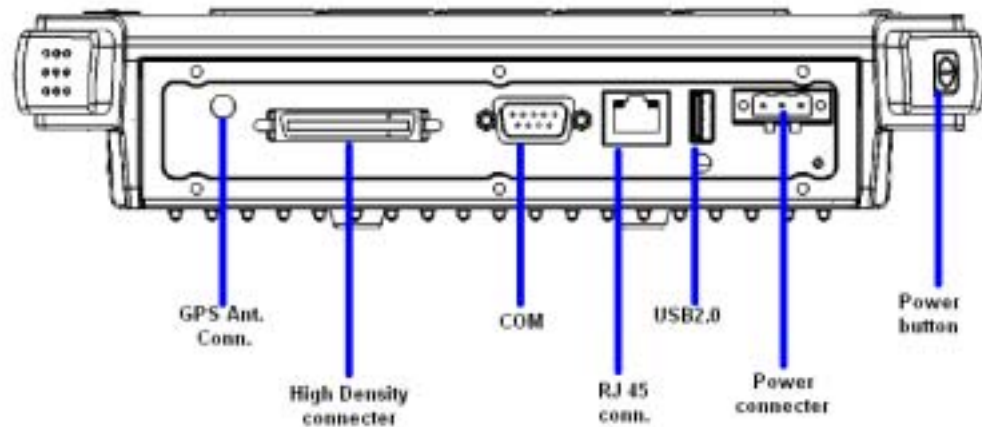

## 4.2 Power Connector

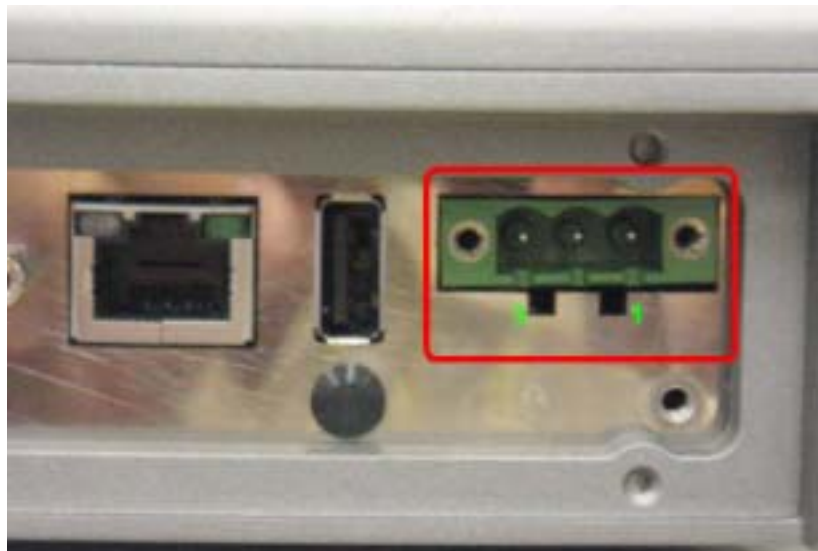

**Table 4.1: Power Connector**

Pin	Signal	Pin	Signal
1	Ground	2	Power input
3	Acc Ignition Input		

**Note!** *TREK-753 has 2 power options for different vehicle:*



- *Input Voltage 12 V/24 V option support 6~36 V car power design with ISO7637-2 & SAE J1113 compliant (default)*
- *48 V option support 18~58 V input for specific application (Option)*

## 4.3 High density Connector

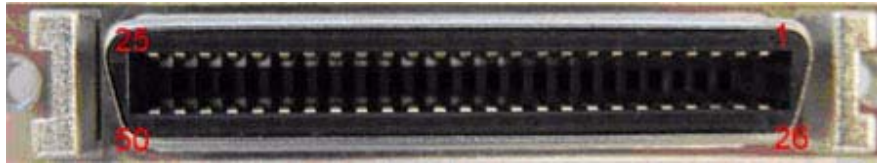

**Table 4.2: High Density Connector**

Pin	Signal	Pin	Signal
1	+5VDC output (+/- 5%, max 0.5A)	2	+5VDC output (+/- 5%, max 0.5A)
3	USB Ground	4	USB D+
5	USB D-	6	CVBS Ground
7	CVBS IN	8	RSVD
9	Audio Ground	10	LINE OUT L
11	LINE OUT R	12	LINE IN R
13	LINE IN L	14	MIC IN
15	RS-485 Ground	16	COM5 485-
17	COM5 485+	18	J1708 Ground
19	COM6 J1708-	20	COM6 J1708+
21	Isolation CAN Ground	22	CAN L
23	CAN H	24	RSVD.
25	RSVD.	26	+12VDC output
27	+12VDC output	28	+12VDC output
29	Power Ground	30	Power Ground
31	Power Ground	32	COM9 RS232 RI#
33	COM9 RS232 CTS#	34	COM9 RS232 RTS#
35	COM9 RS232 DSR#	36	RS232 Ground
37	COM9 RS232 DTR#	38	COM9 RS232 TXD
39	COM9 RS232 RXD	40	COM9 RS232 DCD#
41	RSVD.	42	Isolated Relay Driver Output 4#
43	Isolated Relay Driver Output 3#	44	Isolated Relay Driver Output 2#
45	Isolated Relay Driver Output 1#	46	Isolated Dry Contact Input 4
47	Isolated Dry Contact Input 3	48	Isolated Dry Contact Input 2
49	Isolated Dry Contact Input 1	50	Isolation DIO Ground

## 4.4 RS-232 Connector (COM8)

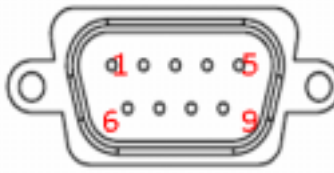

**Table 4.3: Table 5.5: RS-232 / RS-485 / J1708 Connector**

Pin	Signal	Pin	Signal
1	RS-232 DCD	2	RS-232 RXD
3	RS-232 TXD	4	RS-232 DTR
5	RS-232 Ground	6	RS-232 DSR
7	RS-232 RTS	8	RS-232 CTS
9	RS-232 RI / +12 VDC (max. 2500 mA)		

## 4.5 LED Indicator

This system power indicator is an orange LED, controlled by hardware. This LED will be lit on when the system is in NORMAL mode. When system is off, this LED will be lit off.



# Chapter 5

## Software Demo Utility Setup

This appendix explains the software demo utility for TREK-753.

Sections include:

- Introduction
- How to Set up Demo Utility
- Installing the Drivers for Win XP

## 5.1 Introduction

To make the hardware easier to access for programmers, Advantech has developed a demo utility in order to let customer test the functions on TREK-753. This document describes detailed information for each Advantech demo utility so that application developers can become more familiar with using them.

For technical support, contact Advantech application engineers worldwide. For news updates, visit our website: [www.advantech.com](http://www.advantech.com)

### 5.1.1 Execute J1939 Demo Utility

This section explains how to install the Advantech demo utility in Windows XP Pro / Embedded.

1. Execute the test program called "IMC\_Demo"



Figure 5.1 IMC demo utility

2. Click J1939: customer may connect directly to the truck; we use a car simulator board below to explain how J1939 protocol can be executed. First, connect to the simulator board to TREK-753 CAN port and console PC, once the simulator is powered on (connect to the truck), you can start getting the data, just click [Read], you may get the data you need from the car simulator, click [Read], you may transfer the data to Console.



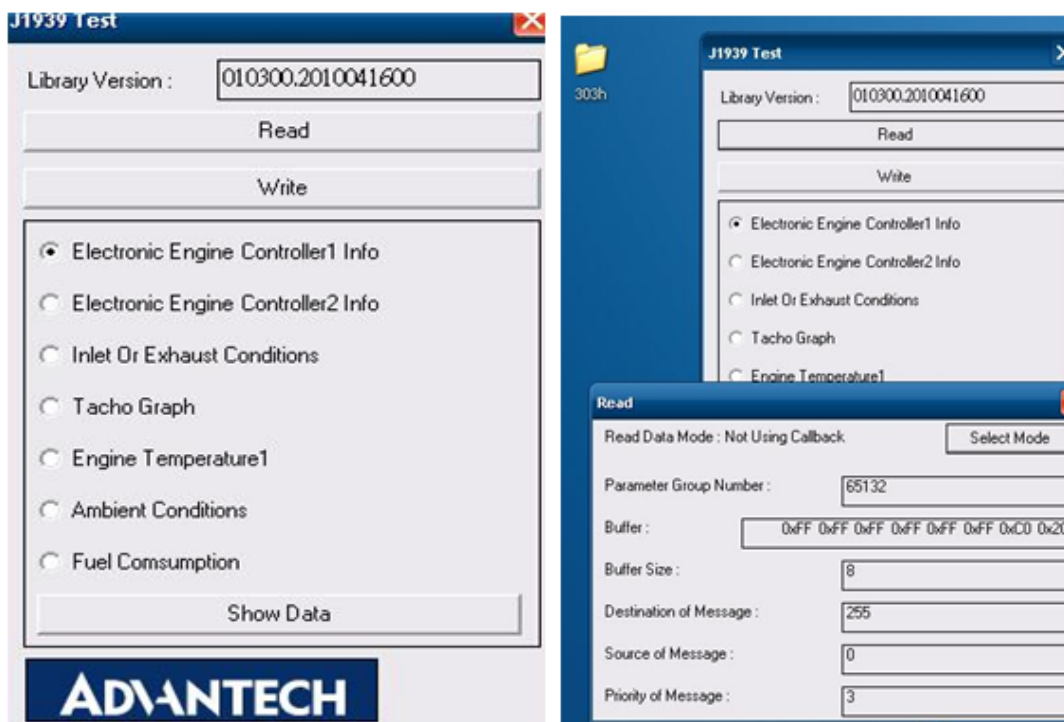

Figure 5.2 J1939 test - 1 &amp; 2

## 5.2 Hoy Key Test

Click "Hot Key test" program in IMC demo main menu.

If check "Auto Brightness"; TREK-753 will adjust the panel brightness automatically by build in Light sensor input. Or user can set the brightness of panel and hot key manually.

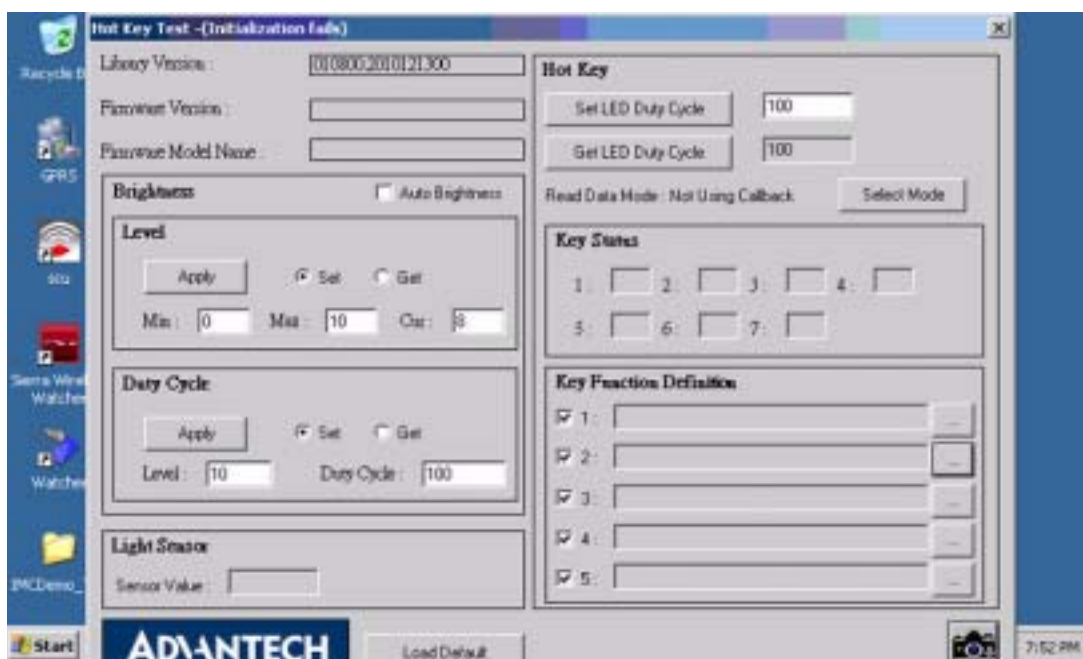

Figure 5.3 Hot Key .bmp

**Brightness level:** Check "Set" option then key in brightness from level 0 ~10 in "Cur" column.

The number bigger, the panel is brighter.

When you finish setting the brightness level you want, please click "Apply".

If you want to check the current brightness level, please click "Get".

**Duty cycle:** You may set every level's brightness strength, to every levels,

After you finish setting the "Level" and "Duty Cycle" vaule for each level, click "Apply".

If you want to check the current brightness strength on certain level, please click "Get".

**Light sensor:** When the sensor has detected the change of the brightness in the environment, the value will change. The lowest level of brightness, the lowest value it is presented. On the contrary, the highest level of brightness, the highest value it is presented.

**Hotkey:** the backlight brightness of hotkeys could be adjusted by setting the value from 0 ~100.

**Key Status:** When you press Hot key, the status will change from 0 to 1.

**Key function Definition:** Set the parameters to connect to the application program function of the hot key.

## 5.3 RTC Test

Execute "RTC test"

1. **For RTC Time setting:** You may set year, month, date, and time show as below.

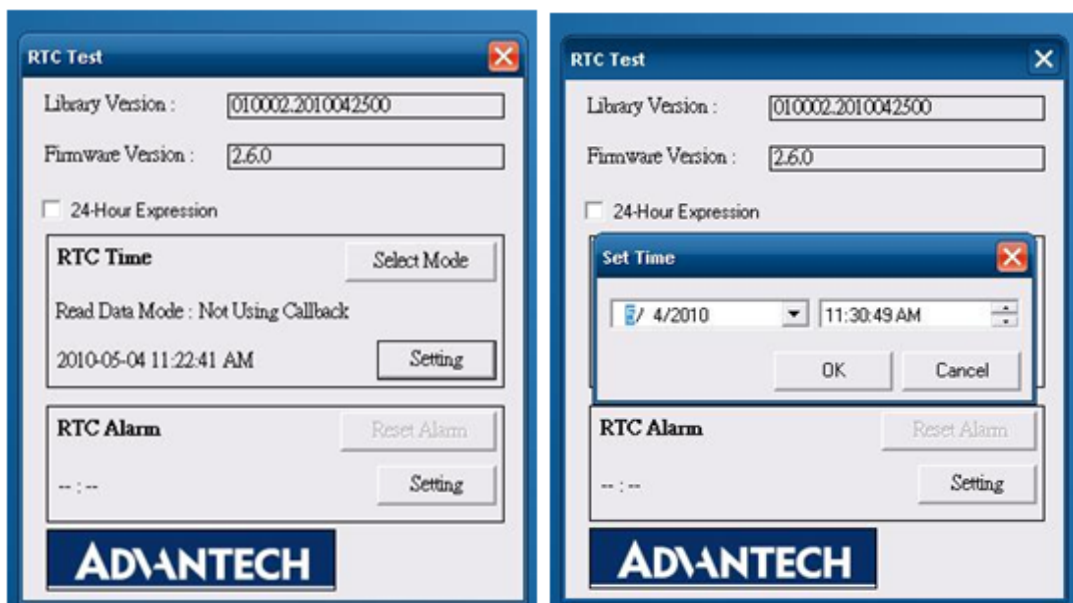

Figure 5.4 RTC test - 1 & 2

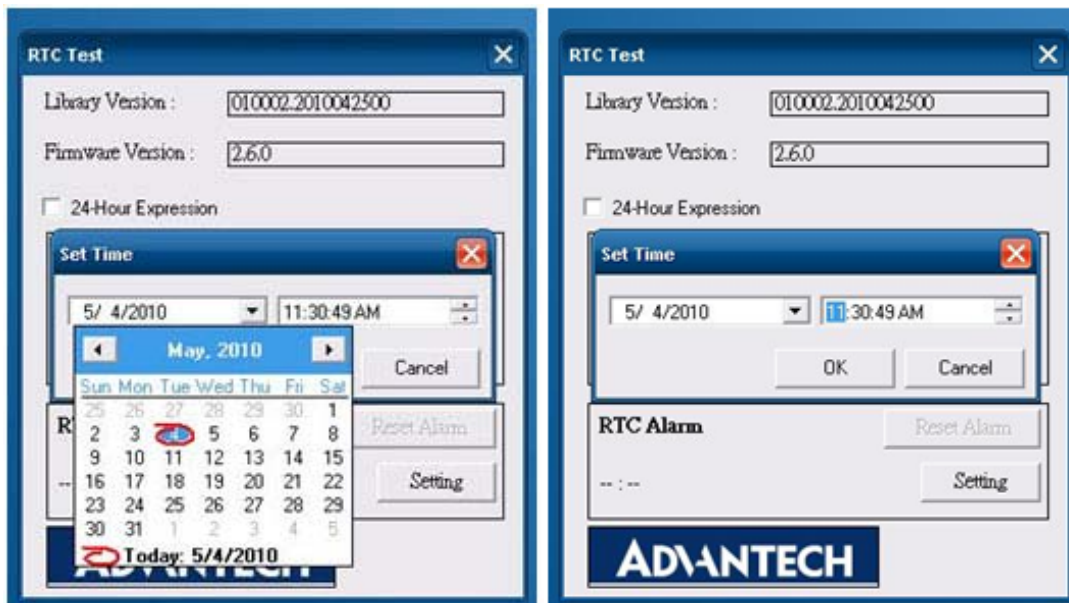

Figure 5.5 RTC test - 3 &amp; 4

2. RTC Alarm Setting: You may also set Alarm time; you may wake up the system by the time you have set. Please refer to the below figure.



Figure 5.9 RTC test - 5

## 5.4 Vehicle Power Management

### 5.4.1 Power Management Mechanism

The feature of Vehicle Power Management (VPM) is provided for users to fulfill the special requirements on in-vehicle applications.

- Ignition on/off

- Turn on the system by ignition

For the cases of in-vehicle applications, an ignition signal is often used to turn on or shutdown the system. When the system is in an OFF state and ignition is turn ON, the VPM controller will countdown ON\_DELAY; once it counts to zero, the system will be turned on.

- Shutdown the system by ignition

When the system is powered on and the ignition is turn off, the OFF\_EVENT\_DELAY will start to count down. During this stage, if the ignition is back to ON, the VPM controller will stop countdown and reset the OFF\_EVENT\_DELAY value. If OFF\_EVENT\_DELAY counts to zero, the VPM controller will send an event (power button press) to the system and start to count HARD\_OFF\_DELAY. Application programs could watch this event to do pre-defined tasks, like storing data and preparing to turn off the system.

Once going into the HARD\_OFF\_DELAY stage, this process will be irreversible. And if HARD\_OFF\_DELAY counts to zero, the system power will be cut off abruptly.

- Low battery protection

To avoid draining out the car battery, low-battery protection is involved to ensure the car battery is capable to start the vehicle. When the system is ON, the VPM controller will monitor the car battery voltage. If the battery voltage is lower than a programmable threshold (LOW\_THRESHOLD), the VPM controller will go into LOW\_DELAY stage and start to count down. During the stage of LOW\_DELAY countdown, if battery voltage is back above LOW\_THRESHOLD, the VPM controller will stop counting down and exit. If LOW\_DELAY counts to zero, the VPM controller will send an event (power button press) to notify the system, go into LOW\_HARD\_DELAY stage and start to count down. Once LOW\_HARD\_DELAY counts to zero, the VPM controller will cut off the system power abruptly to avoid draining out the car battery.

The table below lists the user programmable parameters for VPM features:

	Default value	Acceptable range
ON_DELAY	2 seconds	1 ~ 18000 seconds
OFF_EVENT_DELAY	5 seconds	1 ~ 18000 seconds
HARD_OFF_DELAY	60 seconds	1 ~ 18000 seconds
LOW_THRESHOLD (12V mode)	11.42 V	10.09 ~ 12.25 V
LOW_THRESHOLD (24V mode)	22.44 V	21.11 ~ 23.28 V
LOW_DELAY	30 seconds	1 ~ 3600 seconds
LOW_HARD_DELAY	60 seconds	1 ~ 3600 seconds

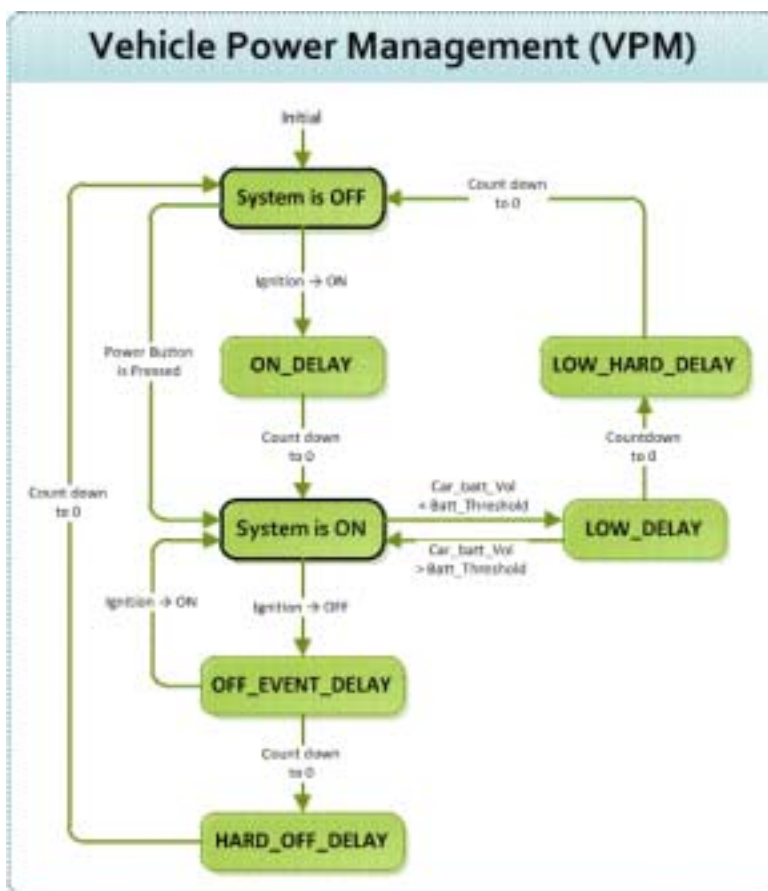

## 5.4.2 Power Management Utility Program

Execute IMCDemo.exe file, see the icon below.



### 5.4.3 Power Management Parameter Settings

The parameters for power management on TREK-753 could be read or modified by Demo utility (see the image below) or SDK/API.

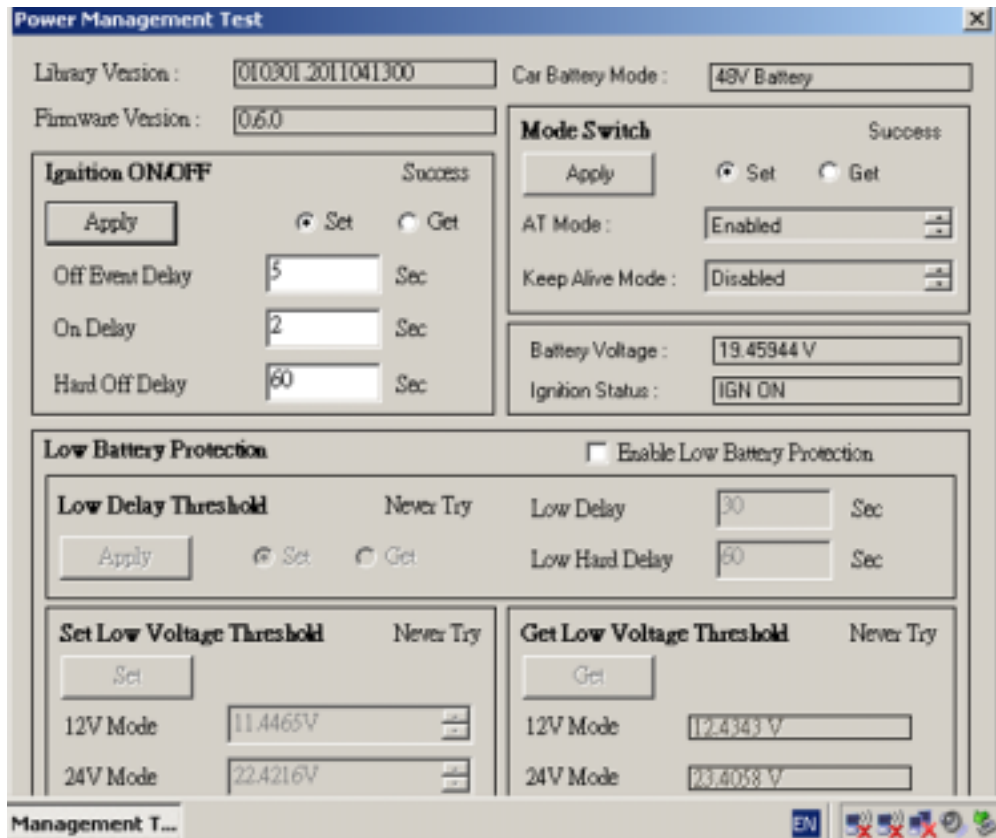

Figure 5.10 Power management test utility

### 5.4.4 TREK-753 Power Consumption

OS: Windows Embedded Standard  
Burn-in test V6.0

Power mode	Power input range	Power consumption(Typical)
12V/24V	6V~36V/6A(max)	36 Watt
48V	18V~58V/2A(max)	36 Watt

\*Doesn't support S1, S3, S4

## 5.5 Execute CAN Demo Utility

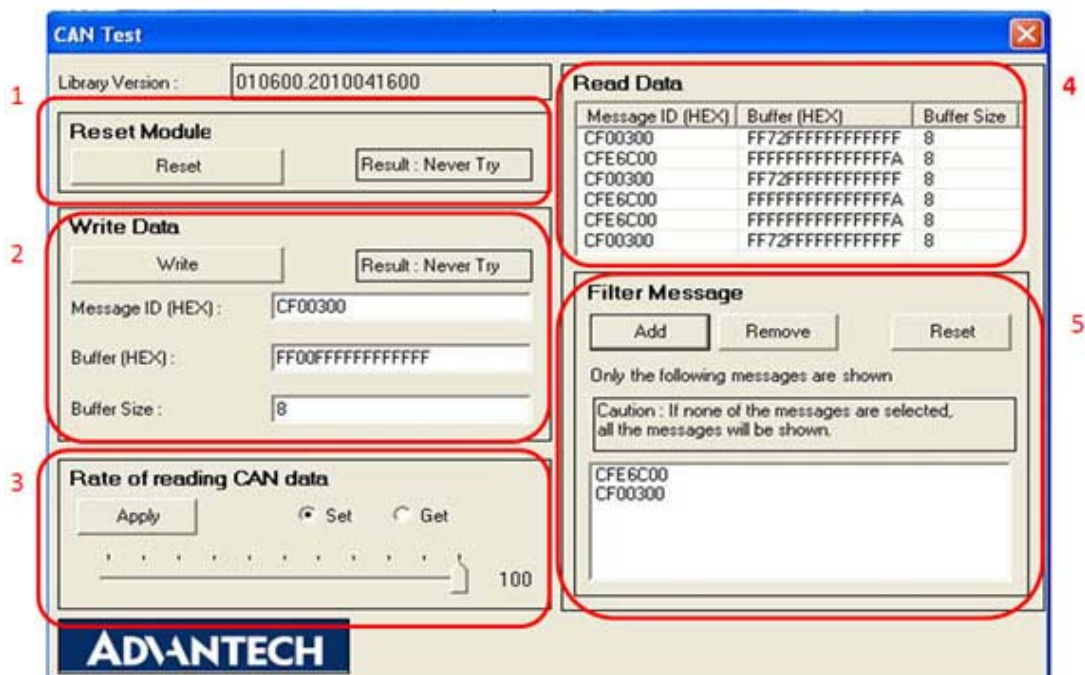

Figure 5.11 CAN test

1. Reset the module
2. Transmit CAN message
3. Set the polling rate of CAN message reception
4. Received CAN message.
5. Set up the filter of CAN message (only show the message ID)

## 5.6 GPIO Test

1. To execute the I/O Test, connect GPIO loopback, click Pin0, connect the end which reads the signal, the bulb should light up, like wise to Pin1~Pin3. Next check the Digital output box to execute the same procedure. See figure 6.



Figure 5.12 DI/O test

- a. Digital Output ==> isolated relay driver output
- b. Digital Input ==> isolated dry contact input



Figure 5.13 Digital in





Figure 5.14 Digital out

## 5.7 Video in Test

There are one video input, please connect camera to the port, CAM1. Choose Channel 1 on [Switch to], then the panel will show the image which camera1 has taken, and it will recover to the same status after 10 sec.

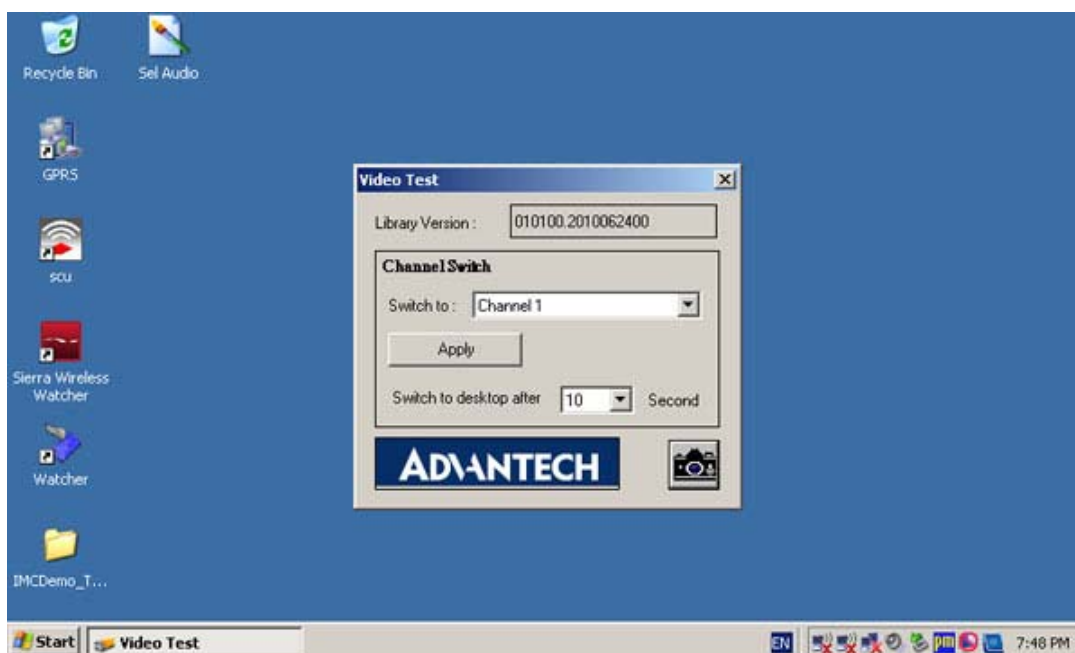

Figure 5.15 Video test utility

## 5.8 Audio Test

TREK-753 has a build-in microphone on front panel, and audio functions (Line out and Line-in & Mic.in) can be extended to remote site by High Density Cable. Both of Line out & Line in function are work directly when High Density cable connected. Mic, in is able to works either front panel or from high density cable.



# Appendix **A**

## High Density Cable Pin Assignment

High Density connector of TREK-753 includes 48 wires in a 2-meter cable. It extends many kinds and numbers IO port with standard type connectors for users.

At the host side, it builds a 3M 10150-3000 PE series 50 pin connector with able to connected with TREK-753. At the connector side, there are

## A.1 Standard USB A type female connector

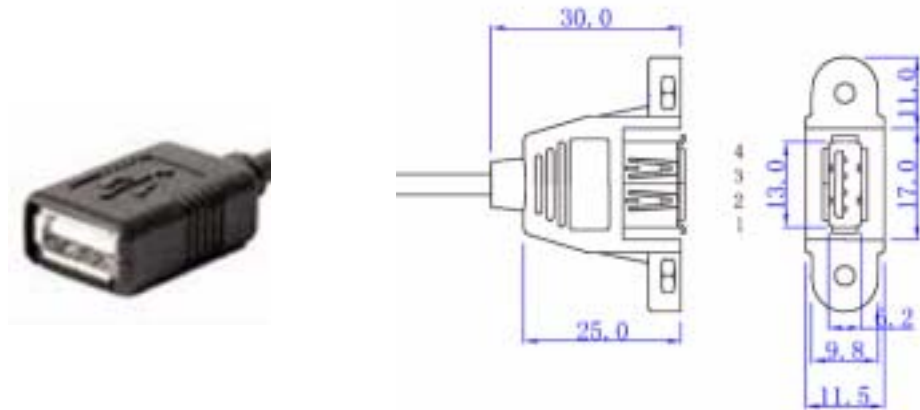

**Table A.1: Standard USB A type female connector**

Pin Number	Definition
1	+V5_USB
2	USB_D-
3	USB_D+
4	GND(Drain wire)

## A.2 Video input, BNC female connector

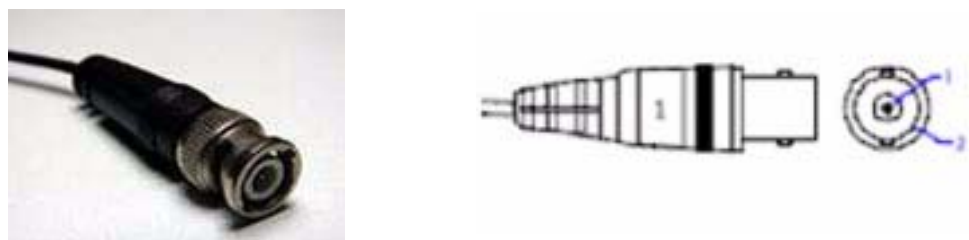

**Table A.2: Video input, BNC female connector**

Pin Number	Definition
1	CVBS_IN
2	GND(Drain wire)

### A.3 RS-232 connector (DB9 male)

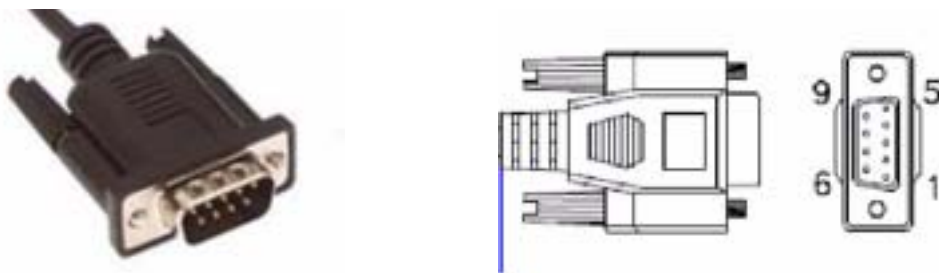

**Table A.3: RS-232 connector (DB9 male)**

Pin Number	Definition
1	RS232_DCD
2	RS232_RXD#
3	RS232_TXD#
4	RS232_DTR
5	GND(Drain wire)
6	RS232_DSR
7	RS232_RTS
8	RS232_CTS
9	RS232_RI

### A.4 4DI /4DO & RS-485 (DB15 male type)

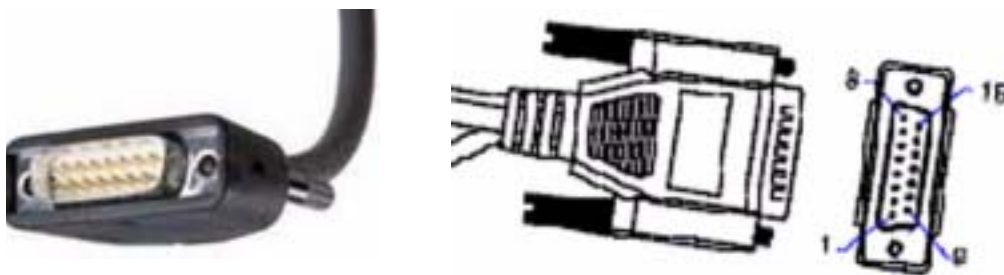

**Table A.4: 4DI /4DO & RS-485 (DB15 male type)**

Pin Number	Definition
1	ISO_DI1
2	ISO_DI2
3	ISO_DI3
4	ISO_DI4
5	GND_ISO
9	ISO_DO1
10	ISO_DO2
11	ISO_DO3
12	ISO_DO4
13	RS485+
14	RS485-
15	GND(Drain wire)

## A.5 CAN Bus & J1708 (Terminal Block 6P, 5.08mm pitch)

Pitch: 5.00mm(0.197inch)



**Table A.5: CAN Bus & J1708 (Terminal Block 6P, 5.08mm pitch)**

Pin Number	Definition
1	CAN_H (H)
2	CAN_L (L)
3	GND (G)
4	J1708+ (J+)
5	J1708- (J-)
6	GND (G)

## A.6 Power extension connector (Terminal Block 3P, 5.08mm pitch)

Pitch: 5.00mm(0.197inch)



**Table A.6: Power extension connector (Terminal Block 3P, 5.08mm pitch)**

Pin Number	Definition
1	+V12(26AWG)
2	GND(26AWG)
3	+V5(26AWG)

## A.7 High Density & Connector Pin List

High Density(50pin) connector		Jacks & IO conn./pin	
No.	Signal Name	Function / Conn.	No.
1	+V5(26AWG)	Extended Power Terminal Block 3P, 5.08mm pitch	3
2	+V5_USB	USB tpye A female connector	1
3	GND(Drain wire)		4
4	USB_D+		3
5	USB_D-		2
6	GND(Drain wire)	Video input BNC Connector	2
7	CVBS_IN		1
8	N/A		
9	GND(Drain wire)	Line out jack	
10	LINEOUT_Left		
11	LINEOUT_Right		
12	LINEIN_Right	Line in jack	
13	LINEIN_Left		
14	MICIN	Mic. In jack	
15	GND(Drain wire)	DIO & RS-485 DB15 female	15
16	RS485-		14
17	RS485+		13
18	GND(Drain wire)	CAN Bus & J1708 Terminal Block 6P, 5.08mm pitch connector	6
19	J1708-		5
20	J1708+		4
21	GND(Drain wire)		3
22	CAN_L		2
23	CAN_H		1
24	N/A		
25	N/A		
26	+V12(26AWG)	Extended Power Terminal Block 3P, 5.08mm pitch	1
27	+V12(26AWG)		
28	+V12(26AWG)		
29	GND(26AWG)		2
30	GND(26AWG)		
31	GND(26AWG)		

32	RS232_RI	RS-232 male Connector	9
33	RS232_CTS		8
34	RS232_RTS		7
35	RS232_DSR		6
36	GND(Drain wire)		5
37	RS232_DTR		4
38	RS232_TXD#		3
39	RS232_RXD#		2
40	RS232_DCD		1
41	N/A		
42	ISO_DO4	DIO & RS-485 DB15 female connector	12
43	ISO_DO3		11
44	ISO_DO2		10
45	ISO_DO1		9
46	ISO_DI4		4
47	ISO_DI3		3
48	ISO_DI2		2
49	ISO_DI1		1
50	GND_ISO (26AWG)		5



# Appendix **B**

**EWF(Enhanced Write  
Filter)Manager SOP**

## B.1 EWF(Enhanced Write Filter)Manager SOP

1. Open Start -> All Programs -> Advantech -> Advantech EWF Manager.



2. You will get a user interface as the following picture.



**A. EWF function:** If you want to protect your OS you can use the function. It will recovery your OS after restarting OS.

**Note!** Please check "C" volume is not protected.



### EWF enable method:

1. Click Enable and UI will request restart OS

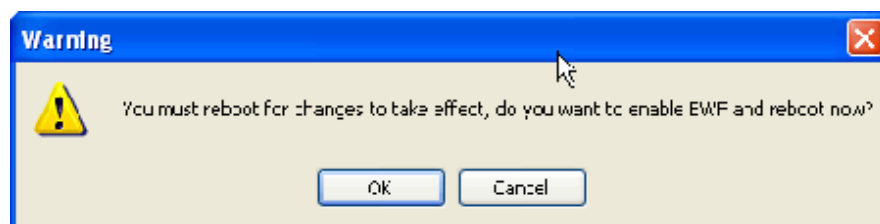

2. After restarting OS you will discover EWF state become "Enable"

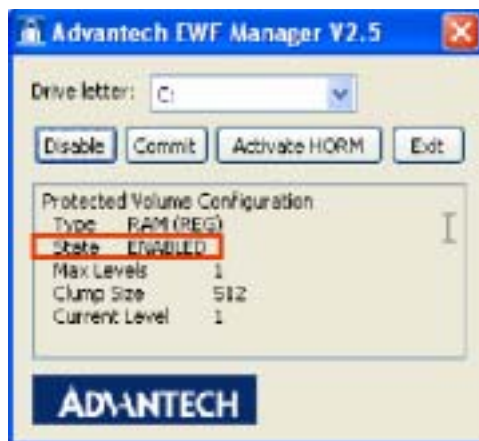

3. At this time, you can try to create folder or file and restart OS. You will discover you can't modify data under C volume.

**Note!** *If you want to write data at EWF enable state you can click Commit to write data under C volume.*



**HORM(Hibernate Once and Resume Many):** The function can always resume your OS after hibernating, even shutdown or crash.

- I Before using HORM you should set EWF "disable"
- II Check "Enable hibernate"
1. Right-Click on desktop and click "Properties"



2. Choose "Screen Saver" panel and click "Power".



3. Check "Enable hibernate".



### III Activate HORM

1. Open Start -> All Programs -> Advantech -> Advantech EWF Manager.
2. Click "Activate HORM".



3. Click "OK" to reboot OS.

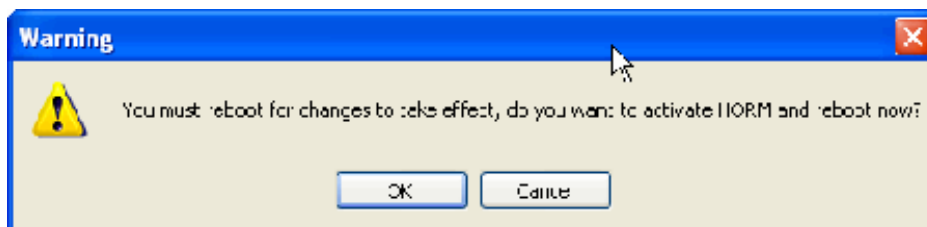

### IV Check "Use the Welcome screen".

1. Open Start -> Control Panel.



2. Click "Network and Internet Connections".



3. Click "Network Connection".

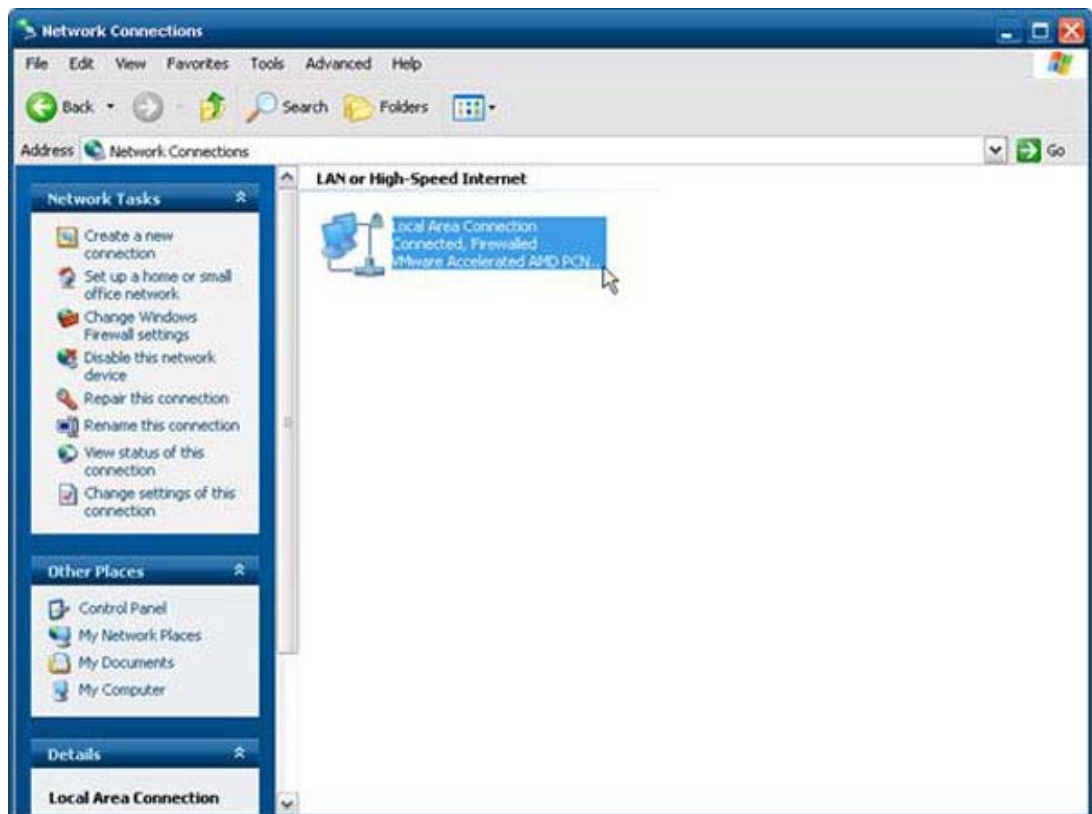

4. Right-Click on "Local Area Connection" and click properties.



5. Uninstall "Client Service for NetWare".

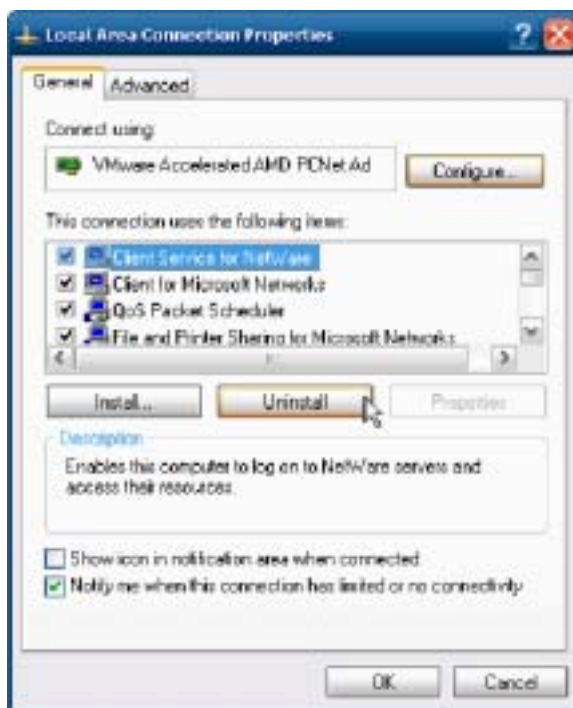

6. Click "Yes" to remove "Client Service for NetWare" and reboot OS.
7. Open Start -> Control Panel.



8. Click "User Accounts"

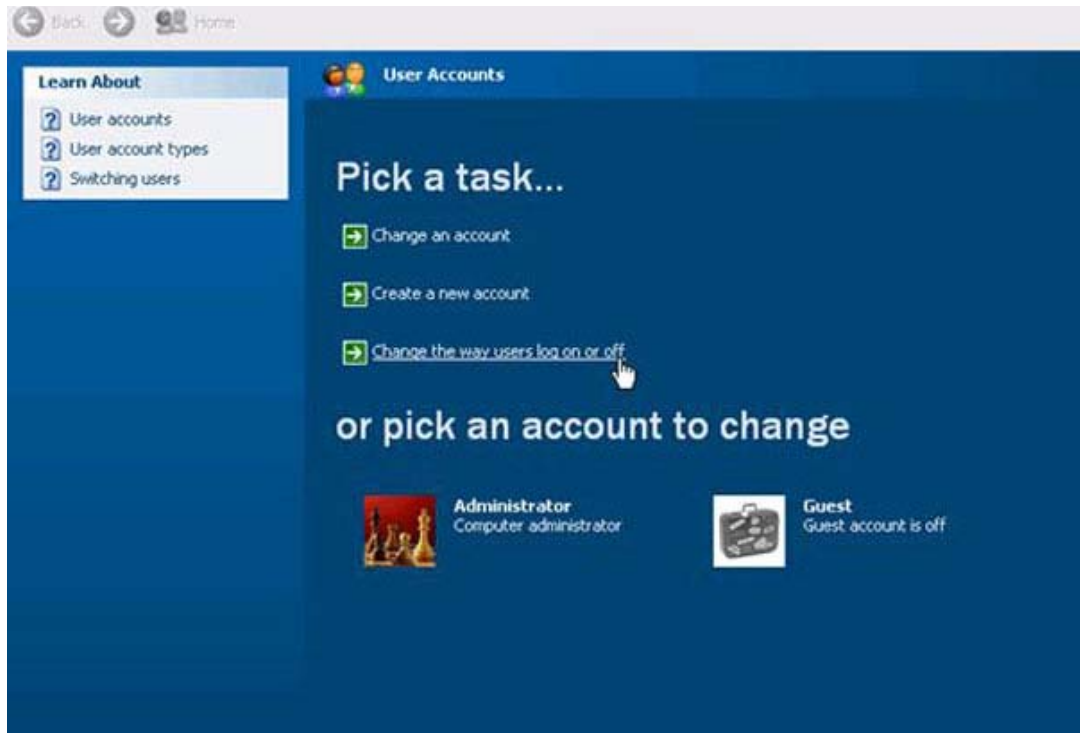

9. Click "Cancel".

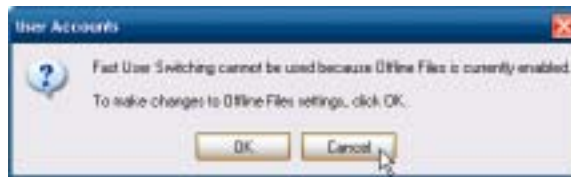

10. Check "Use the Welcome screen" and Click "Apply Options"





- V Enable EWF
  1. Open Start -> All Programs -> Advantech -> Advantech EWF Manager.
  2. Click "Enable".



3. Click "OK" to reboot OS.

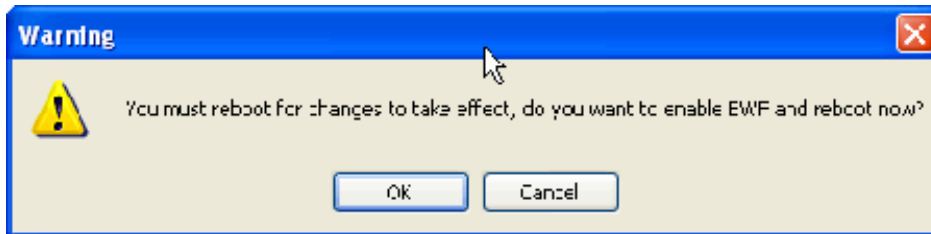

- VI Run "Hibernate"

  1. Open Start -> Shut Down



2. When you press "Shift" Standby will become Hibernate



---

VII Enable HORM finish

VIII You can try to pull power cord after resuming. You will discover the OS always been resuming



*Trusted ePlatform Services*

**ADVANTECH**

[www.advantech.com](http://www.advantech.com)

Please verify specifications before quoting. This guide is intended for reference purposes only.

All product specifications are subject to change without notice.

No part of this publication may be reproduced in any form or by any means, electronic, photocopying, recording or otherwise, without prior written permission of the publisher.

All brand and product names are trademarks or registered trademarks of their respective companies.

© Advantech Co., Ltd. 2011

