

User's Manual

LAVATHERM T76280AC Condensation Dryer -

User's Manual



 **AEG**

perfekt in form und funktion

CONTENTS

1. SAFETY INSTRUCTIONS	3
2. PRODUCT DESCRIPTION	5
3. ACCESSORIES	6
4. CONTROL PANEL	7
5. BEFORE FIRST USE	8
6. PROGRAMMES	8
7. USING THE APPLIANCE	10
8. HINTS AND TIPS	13
9. CARE AND CLEANING	14
10. TROUBLE SHOOTER AND SERVICE	17
11. TECHNICAL INFORMATION	19
12. INSTALLATION	20
13. ENVIRONMENT CONCERNS	22

FOR PERFECT RESULTS

Thank you for choosing this AEG product. We have created it to give you impeccable performance for many years, with innovative technologies that help make life simpler – features you might not find on ordinary appliances. Please spend a few minutes reading to get the very best from it.

Visit our website for:



Get usage advice, brochures, trouble shooter, service information:
www.aeg.com



Register your product for better service:
www.aeg.com/productregistration



Buy Accessories, Consumables and Original spare parts for your appliance:
www.aeg.com/shop

CUSTOMER CARE AND SERVICE

We recommend the use of original spare parts.
When contacting Service, ensure that you have the following data available.
The information can be found on the rating plate. Model, PNC, Serial Number.



Warning / Caution-Safety information



General information and tips



Environmental information

Subject to change without notice.

1. SAFETY INSTRUCTIONS

In the interest of your safety and to ensure the correct use, before installing and first using the appliance, read this user manual carefully, including its hints and warnings. To avoid unnecessary mistakes and accidents, it is important to ensure that all people using the appliance are thoroughly familiar with its operation and safety features. Save these instructions and make sure that they remain with the appliance if it is moved or sold, so that everyone using it through its life will be properly informed on appliance use and safety.



- Read the instruction manual before the appliance use.

1.1 General safety

- It is dangerous to alter the specifications or attempt to modify this product in any way.
- This appliance is not intended for use by persons (including children) with reduced physical and sensory conditions or lack of experience and knowledge, unless they have been given supervision or instruction concerning use of the appliance by a person responsible for their safety.
- Make sure that small children and pets do not climb inside the drum. To avoid this, please check into the drum before using.
- Any objects such as coins, safety pins, nails, screws, stones or any other hard, sharp material can cause extensive damage and must not be placed into the machine.
- Items such as foam rubber (latex foam), shower caps, waterproof textiles (if there is no special drying programme), rubber backed articles and clothes or pillows fitted with foam rubber pads must not be dried in the tumble dryer.
- Make sure that there is access to the mains plug after the installation.
- Always unplug the appliance after use, cleaning and maintenance.
- Under no circumstances should you attempt to repair the machine yourself. Repairs carried out by inexperienced persons may cause injury or serious malfunctioning. Contact your local Service Centre. Always insist on genuine spare parts.
- Items that have been soiled with substances such as cooking oil acetone, petrol, kerosene, spot removers, turpentine, waxes and wax removers should be washed in hot water with an extra amount of detergent before being dried in the tumble dryer.
- **Danger of explosion:** Never tumble dry items that have been in contact with inflammable solvents (petrol, methylated spirits, dry cleaning fluid and the like). As these substances are volatile, they could cause an explosion. Only tumble dry items washed with water.
- **Risk of fire:** items that have been spotted or soaked with vegetable or cooking oil constitute a fire hazard and should not be placed in the tumble dryer.
- If you have washed your laundry with stain remover you must execute an extra rinse cycle before loading your tumble dryer.
- Please make sure that no gas lighters or matches have accidentally been left in pockets of garments in case they are loaded into appliance
- The condensed water is not applicable to drink or to prepare food. It can cause health problems to people and pets.
- Do not seat or lean on the load door. The appliance can tilt.



WARNING!

- **Risk of fire! To prevent from the risk of self combustion do not stop a tumble dryer before the end of the drying cycle unless all items are quickly removed and spread out so that the heat is dissipated.**
- **Lint must not be allowed to accumulate around the tumble dryer.**
- **Risk of electric shock!** Do not spray down the appliance with jets of water.
- The final part of a tumble dryer cycle occurs without heat (cool down cycle) to ensure that the items are left at a temperature that ensures that items will not be damaged.
- The tumble dryer is not to be used if industrial chemicals have been used for cleaning.
- Ensure you have good ventilation in the installation room to avoid the back flow of gases into the room from appliances burning other fuels, including open fires.

1.2 Installation

- This appliance is heavy. Be careful when you move the appliance.
- When unpacking the appliance, check that it is not damaged. If in doubt, do not use it and contact the Service Centre.
- All packaging must be removed before use. Dangerous damage can occur to the product and to property if this is not adhered to. See relevant section in the user manual.
- Each electrical work necessary to install this appliance must be done by a qualified electrician or competent person.
- The rear surface of the appliance must be put against the wall
- If the appliance is installed on the carpet or equivalent, adjust the feet. Air must flow freely below the appliance.
- After the appliance installation, check that it is not squeeze or stay on the electrical supply cable.

- If the tumble dryer is put on top of a washing machine, it is mandatory to use the stacking kit (optional accessory - see chapter: "ACCESSORIES").

1.3 Use

- This appliance is for domestic use only. It must not be used for other functions.
- Only dry fabrics which are applicable to dry in the tumble dryer. Follow the instructions on each piece of clothing label.
- Do not dry not washed items in the tumble dryer.
- Do not put more load than recommended. Obey the maximum load volume. See the related chapter in the user manual.
- Clothes which are dripping wet must not be put in the tumble dryer.
- Garments which have been in contact with volatile petroleum products should not be machine dried. If volatile cleaning fluids are used, care should be taken to ensure that the fluid is removed from the garment before placing in the appliance.
- Do not use the tumble dryer if the power supply cable, the control panel, the working surface or the base are damaged so that the inside of the tumble dryer is accessible.
- Fabric softener or equivalent products must be used as specified by the fabric softener manufacturer.
- Risk of fire! Do not dry the damaged items which contain padding or fillings (pillows, jackets, duvets, etc.). The padding or fillings can get out and cause the fire.

1.4 Child safety

- This machine is not intended for use by young children or infirm persons without supervision.
- Children often do not recognise the hazards associated with electrical appliances. Children should be supervised to ensure that they do not play with the appliance.

**WARNING!**

- Danger of suffocation! The packaging components (e.g. plastic film, polystyrene) can be dangerous to children - Keep them out of children's reach.
- Keep all detergents in a safe place out of children's reach.
- Make sure that children or pets do not climb inside the drum.

1.5 Discard the appliance

- Disconnect the mains plug from the mains socket.

- Cut off the mains cable and discard it.
- Discard the door catch. This prevents children or pets to be closed in the appliance. There is a risk of suffocation.

1.6 Packaging materials

Recycle the materials with the symbol . Put the packaging in applicable containers to recycle it.

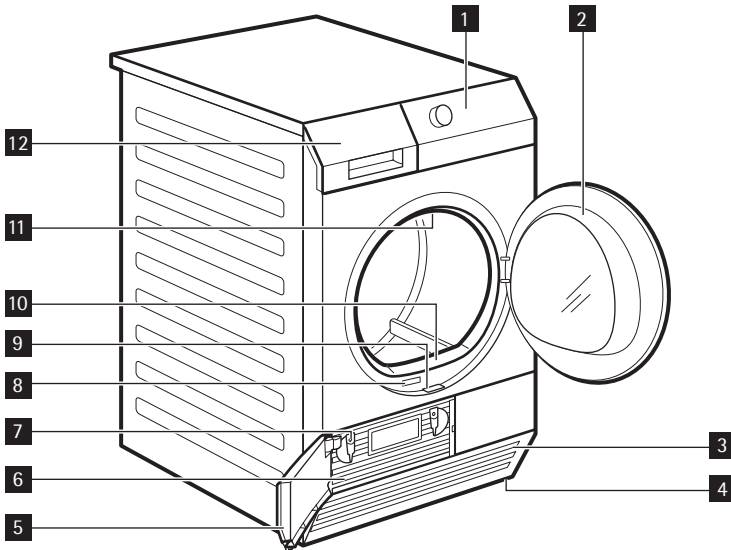
2. PRODUCT DESCRIPTION

- | | |
|---------------------------------|--|
| 1 Control panel | 8 Rating plate |
| 2 Load door (reversible) | 9 Sliding button to open the condenser door |
| 3 Airflow slots | 10 Filter |
| 4 Adjustable feet | 11 Drum light |
| 5 Condenser door | 12 Water container |
| 6 Condenser cover | |
| 7 Lock knobs | |

3. ACCESSORIES

3.1 Stacking kit

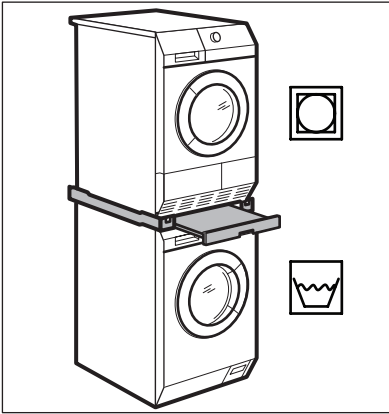

Accessory name: SKP11, STA8, STA9
Available from your authorized vendor.
Stacking kit can be used only with the washing machines specified in the leaflet. See the leaflet attached.
Read carefully the instructions supplied with the accessory.

3.2 Draining kit

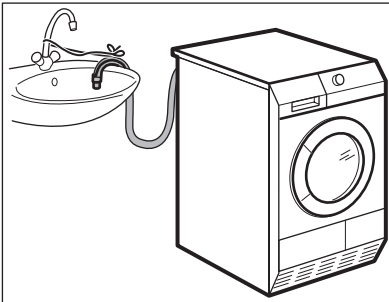

Accessory name: DK11.
It is available from your authorized vendor (can be attached to some types of the tumble dryers)
The accessory for through draining of the condensed water into a basin, siphon, gully, etc. After the installation, the water container is drained automatically. The water container must stay in the appliance.
The installed hose must be on the height from minimum of 50 cm to maximum of 1 m from floor level. The hose cannot be

in loop. Decrease the length of the hose if necessary.
Read carefully the instructions supplied with the accessory.

3.3 Pedestal with the drawer

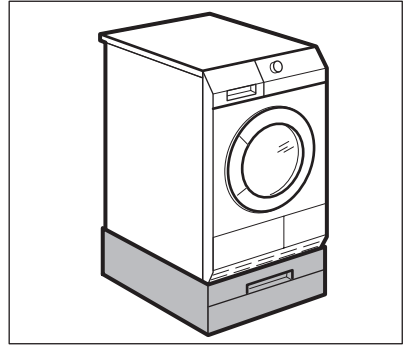

Accessory name: PDSTP10.
It is available from your authorized vendor.
To put the appliance higher at the level which helps to easy load and remove the laundry.
The drawer can be used for laundry storage e.g. : towels, cleaning products and more.
Read carefully the instructions supplied with the accessory.

3.4 Drying rack

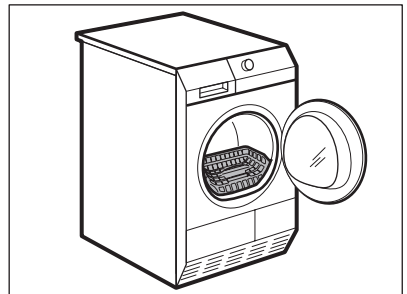

Accessory name: RA5, RA6, RA11, RA12
It is available from your authorized vendor (can be attached to some types of the tumble dryers). Do the check with the vendor or on the web site if the accessory is compatible with your appliance.

Drying rack accessory let to dry safely in the tumble dryer:

- sport shoes
- wool

- soft toys
- lingerie

Read carefully the instructions supplied with the accessory.

4. CONTROL PANEL

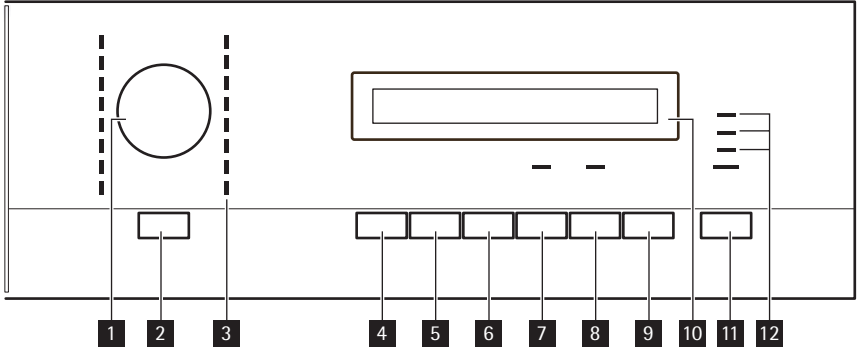

- 1** The programme dial
- 2** The On/Off
- 3** The programme indicators
- 4** The Dry Plus push button
- 5** The Delicate push button
- 6** The Anticrease push button
- 7** The Buzzer push button
- 8** The Time Drying push button
- 9** The Delay Start push button
- 10** The display
- 11** The Start/Pause push button
- 12** The indication lamps: drain the water container, clean the filter, clean the condenser

4.1 Display

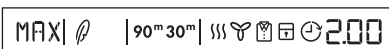

Symbol	Description
MIN	default dryness level
MED	moderate extra dryness

































Symbol	Description
MAX	maximum extra dryness
	delicate
	delay start
30m / 90m	anti-crease time
	drying cycle phase indicator
	cooling cycle phase indicator
	crease guard cycle phase indicator
	child lock activated
2.00	cycle time indication
10' - 2.00	time programme selection (10 min. - 2h.)
30' - 20h	delay start selection (30 min. - 20h.)













5. BEFORE FIRST USE









Clean the tumble dryer drum with a moist cloth or set a short programme

(e.g. 30 minutes time programme) with the load of moist cloths.

6. PROGRAMMES

Pro-grammes	Load 1)	Properties	Available functions	Fab-ric mark
 Cottons				
 Extra Dry	8 kg	To dry cotton pieces of clothing. Drying level: extra dry.	all except ⏪ Time Drying	 
 Cup-board Dry 2)	8 kg	To dry cotton pieces of clothing. Drying level: cupboard dry.	all except ⏪ Time Drying	 
 Iron Dry 2)	8 kg	To dry cotton pieces of clothing. Drying level: applicable to iron.	all except ⏪ Time Drying	 
 Jeans	8 kg	To dry leisure clothing such as jeans, sweat-shirts of different material thicknesses (e.g. at the neck, cuffs and seams).	all except ⏪ Time Drying	 
 Bed Linen	3 kg	To dry bed linen such as: single and double sheet, pillowcase, bed-spread.	all except ⏪ Time Drying	  
 Du-vets	3 kg	To dry single or double duvet and pillows (with feather, down or synthetic fillings).	all except  Anticrease and ⏪ Time Drying ³⁾	  
 Time	8 kg	To dry laundry with the time set by the user.	all except  Dry Plus	  
 Extra Quick Mixed	3 kg	To dry cotton and synthetic fabrics, uses low temperature.	all except:  Delicate and ⏪ Time Drying	  
 Synthetics				

Pro-grammes	Load 1)	Properties	Available functions	Fab-ric mark
 Extra Dry	3,5 kg	To dry synthetic pieces of clothing. Drying level: extra dry.	all except ⌚ Time Drying	
 Cup-board Dry 2)	3,5 kg	To dry synthetic pieces of clothing. Drying level: cupboard dry.	all except ⌚ Time Drying	
 Iron Dry	3,5 kg	To dry synthetic pieces of clothing. Drying level: applicable to iron.	all except ⌚ Time Drying	
 Easy Iron	1 kg (or 5 shirts)	To dry easy care fabrics such shirts and blouses; for minimum ironing effort. The results can be different for to the different types of fabric and its finish. Put fabrics in the tumble dryer straight. After the cycle, immediately remove dried fabrics and put on a cloths hanger.	all except ⌚ Time Drying 3)	
 Active Wear	2 kg	To dry outdoor pieces of clothing, technical, sports, pile fabrics, water-proof and breathable jackets, shell jacket teamed with a removable fleece or inner insulation.	all except  Anticrease and ⌚ Time Drying 3)	
 Sports	2 kg	To dry sportswear, thin and light fabrics, microfiber, polyester, which are not ironed.	all except ⌚ Time Drying	
 Delicates	3 kg	To dry delicate fabrics.	all except ⌚ Time Drying 3)	

Pro-grammes	Load 1)	Properties	Available functions	Fab-ric mark
 Wool	1 kg	<p>To dry the cloths made of wool . The cloths become soft and cosy. We recommend to remove the cloths immediately after the programme end. To increase or to decrease the level of the remaining moisture of the laundry you can use the function  Dry Plus . The wool drying cycle of this machine has been approved by The Woolmark Company for the drying of machine washable wool products provided that the products are washed and dried according to the instructions on the garment label and those issued by the manufacturer of this machine. M1221. In UK, Eire, Hong Kong and India the Woolmark symbol is a certification trademark. ©The Woolmark Company Pty Ltd.</p>	 Dry Plus ,  Buzzer ,  Time Drying 4),  Delay Start 3)	
		 		

1) maximal weight of dry clothes

2) For test institutes only:

To make a performance test use the standard programmes which are specified in the EN 61121 document. If the remaining moisture level of the laundry, is out of tolerance, adjust the programme with the  Dry Plus function .

3)  Delicate activated by default



4) Only with the drying rack RA11 — see chapter ACCESSORIES



7. USING THE APPLIANCE

7.1 Preparing the laundry



Dry only the laundry applicable to dry in the tumble dryer. Make sure if the laundry is applicable to dry in the tumble dryer. Do the check of the fabric mark on the clothes.

Fabric mark	Property
	Applicable to dry in the tumble dryer
	Applicable to dry in the tumble dryer at standard temperature

Fabric mark	Property
	Applicable to dry in the tumble dryer at decreased temperature
	Not applicable to dry in the tumble dryer

Correctly prepare the laundry:

- close zips, button up duvet covers and attach loose ties or ribbons (e.g. ribbons of aprons) - laundry can tangle
- make sure the pockets are empty - remove metal items (paper clips, safety pins, etc.).
- turn items with 2 fabric layers inside out (e.g. cotton lined anoraks, the cotton fabric layer must be external).

Dry only:

- cotton and linen with Cottons programmes
- synthetic and mixtures with Synthetic programmes
- separately the strong coloured textiles and the light coloured textiles - colours can bleed
- cotton jersey and knitwear only with the applicable programmes - items can shrink



Do not put more laundry than the maximum load which is **8kg**.

7.2 Loading the laundry

1. Pull the appliance door
2. Load loosely the laundry.
3. Close the appliance door.











CAUTION!

Do not lock the laundry in between the appliance door and rubber seal.

7.3 Switching on the appliance

Push the On/Off button to activate or to deactivate the appliance. When the appliance is on, some indications come in to the view on the display.

The function push button symbols list	
	On/Off
	Dry Plus
	Delicate
	Anticrease
	Buzzer
	Time Drying
	Delay Start
	Start/Pause

7.4 Auto stand-by function

To decrease the energy consumption, the automatic stand-by function deactivates the appliance:

- if the Start/Pause button was not pushed in the time of 5 minutes.
- after 5 minutes from the programme end.

Push the On/Off button to activate the appliance.

7.5 Setting a programme

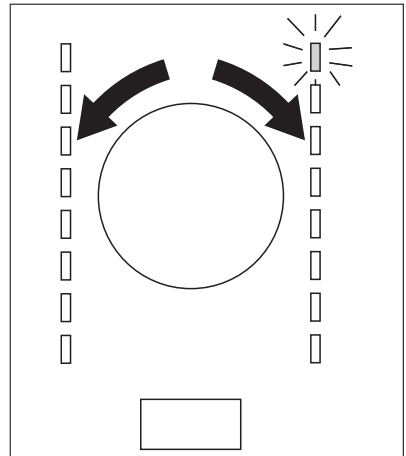

Use the programme dial to set the programme. The possible time to complete the programme come into view on the display.



The drying time you see is related to the load of 5 kg for cotton and jeans programmes. For the other programmes the drying time is related to the recommended loads. The drying time of the cotton and jeans programmes with the load more than 5 kg is longer.

7.6 Special functions

Together with the programme you can set 1 or more special functions.

To activate or deactivate the function push the applicable push button.

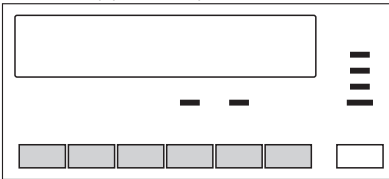

When the function is activated the LED above the push button or symbol on the display comes into view.

7.7 The Dry Plus function

This function helps to get the laundry more dried. There are 3 possible selections:

MIN - the default selection which is related to the programme.

MED — the selection to get the laundry lightly dried.

MAX — the selection to get the laundry more dried.

7.8 The Delicate function

To dry more lightly the sensitive and temperature sensitive textiles (e.g. acrylic, viscose). For fabrics with the symbol

 on the fabric label. Programme operates with decreased heat.

7.9 The Anticrease function

Extends anticrease phase (30 minutes) at the end of the drying cycle to 90 minutes. This function prevents laundry from creases. Laundry can be removed during the anticrease phase.

7.10 The Buzzer function

When the buzzer function is activated you can hear the buzzer at the:

- cycle end
- anti-crease phase start and end
- cycle interruption

The buzzer function is by default always on. You can use this function to activate or deactivate the sound.

7.11 The Time Drying function

Operates only with the Time programme. Lets the user to set special time of drying programme from minimum 10 min. to maximum of 2 hours (in 10 min. steps).

7.12 The Delay Start function



Let to delay the start of a drying programme from minimum of 30 minutes to maximum of 20 hours.

1. Set the drying programme and functions.
2. Push the Delay start button again and again until the necessary time of the delay come into the view on the display (e.g. 12h if the programme has to start after 12 hours.)
3. To activate the Delay start function, push the Start/Pause button. The time to start decreases on the display.

7.13 Child lock function

The child lock can be set to prevent the children to play with the appliance. The child lock function locks all push buttons and the programme dial (this function does not lock On/Off button). To activate the child lock function push the Dry Plus and Delicate buttons at the same time until the symbol  come into view on the display. To deactivate push again the above buttons until the symbol go out of view.

You can activate the child lock function:

- before you push the Start/Pause button - the appliance cannot start

- after you push the Start/Pause button - all the push buttons and the programme dial are deactivated

7.14 Starting a programme

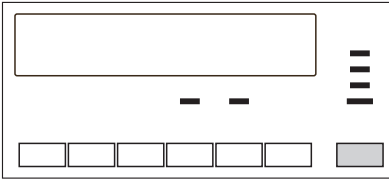

To activate the programme push the Start/Pause button. The LED above the push button changes the colour to red.

7.15 Change a programme

To change a programme, push the On/Off button to deactivate appliance. Push the On/Off to activate the appliance and then set the programme again.

7.16 At the end of programme

When the drying cycle is completed, the  symbol flashes on the display. If the Buzzer function is on, an acoustic signal sounds intermittently for one minute. To remove the laundry:

1. Push the On/Off button for 2 seconds to deactivate the appliance.
2. Open the appliance door.
3. Remove the laundry.
4. Close the appliance door.



After each drying cycle:

- clean the filter
- drain the water container (See chapter *CARE AND CLEANING*.)

8. HINTS AND TIPS

8.1 Ecological hints



- Do not use fabric softener to wash and then dry. In the tumble dryer laundry becomes soft automatically.
- Use the condensate as distilled water, e.g. for steam ironing. If necessary clean the condensate before (e.g. with a coffee filter) to remove possible small pieces of fluff.
- Always keep the airflow slots on the bottom of the appliance clear.
- Use the load volumes specified in the programmes chapter.
- Make sure that is good airflow in the appliance installation position.
- Clean the filter after each drying cycle.
- Spin good the laundry before drying.

8.2 Water hardness and conductivity

Water hardness can be different for different locations. Water hardness has an effect on the water conductivity and the operation of the conductivity sensor in the appliance. If you know the value of

the water conductivity you can adjust the sensor to dry with the better results.

To change the sensor conductivity:



1. Turn the programme dial to available programme.
2. Push at the same time the Dry Plus and the Antcrease buttons. Hold down until one of the symbols go into view on the display:
 -  low conductivity <300 $\mu\text{S}/\text{cm}$
 -  moderate conductivity 300-600 $\mu\text{S}/\text{cm}$
 -  high conductivity >600 $\mu\text{S}/\text{cm}$
3. Push the Start Pause button again and again until you set necessary level.
4. To memorise the setting push at the same time the Dry Plus and the Antcrease buttons.

8.3 Water container full — indication

By default the indication LED is always on. It comes into the view at the end of the cycle or when the water container is full. When you use an external equipment to drain the container, the LED can be off.

To activate or deactivate the indication:

1. Turn the programme dial to available programme.

2. Push at the same time the Dry Plus and Buzzer buttons and hold down until you see the correct setting:
 - the LED is off and the symbol  goes into the view - The LED is permanently off
 - the LED is on and the symbol  goes into the view - The LED is activated

9. CARE AND CLEANING

9.1 Cleaning the filter

At the end of each cycle the *filter* LED is on to tell you that the filter must be cleaned.



The filter collects the fluff. The fluff occurs while the cloths are dried in the tumble dryer.

To clean the filter:

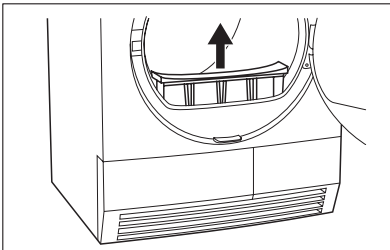

1. Open the door.
2. Pull the filter.

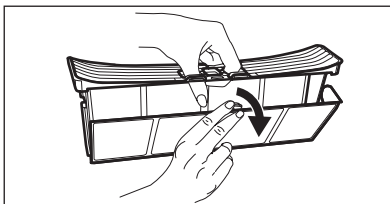

3. Open the filter.

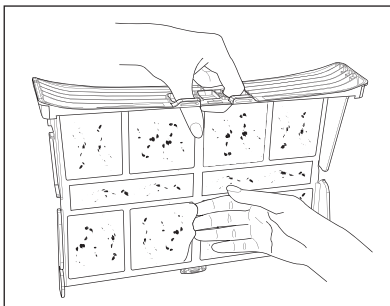

4. Use a moist hand to clean the filter.

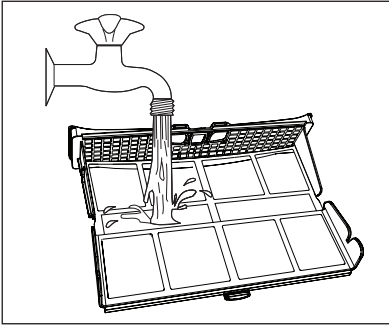

5. If necessary clean the filter with warm water using a brush.
Close the filter.

6. Remove fluff from the filter socket.
For this a vacuum cleaner can be used.
7. Put the filter inside the filter socket.

**CAUTION!**

Do not operate the tumble dryer without the filter or with damaged or blocked filter.



Clean the filter after each drying cycle. Clogged filter increases the cycle time and causes higher energy consumption.

If the condensed water container is full, the programme breaks off automatically and the *drain the condensed water container* LED is on. To continue the programme, drain the condensed water container and press the start button.



To drain the condensed water container automatically you can install draining accessory (see chapter: *ACCESSORIES*)

9.2 Draining the condensed water container

Drain the condensed water container after each drying cycle.

To drain the condensed water container:

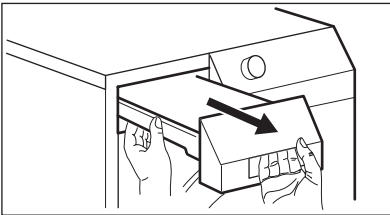

1. Pull the condensed water container and keep it in horizontal position.

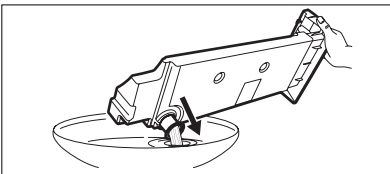

2. Move the plastic connection out and drain the condensed water container into a sink or equivalent receptacle.
3. Move plastic connection in and install water container.

**WARNING!**

Risk of poisoning. The condensed water is not applicable to drink or to prepare food.



The condensed water can be used as distilled water, e.g. for steam ironing. If necessary filter the condensed water (e.g. with a coffee filter) to remove possible residue and small pieces of fluff.

9.3 Cleaning the condenser

If the *condenser* LED is on, the condenser must be cleaned.

To clean the condenser:

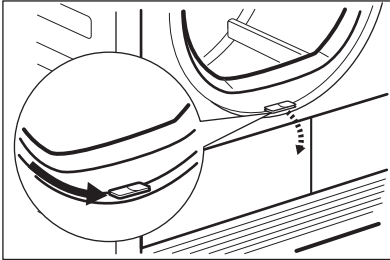

1. Open the loading door.
2. Move the release button on the bottom of the door opening and open the condenser door.

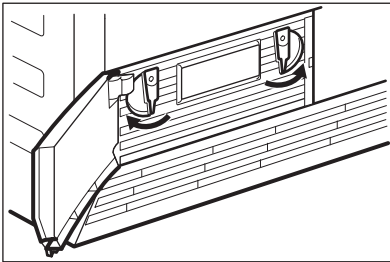

3. Turn the 2 blockages to unlock the condenser lid.

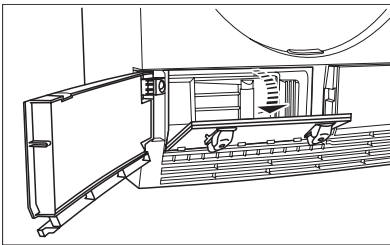

4. Lower the condenser lid.

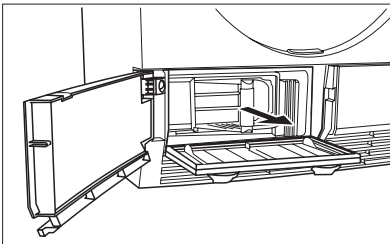

5. Catch the handle and pull the condenser out from the bottom compartment. Move condenser horizontally to do not spill remaining water.

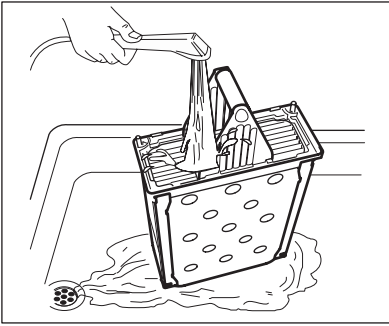

6. Clean the condenser in vertical position over a basin or paddling. Rinse through with a hand shower.
7. Put the condenser back inside the bottom compartment.
8. Close the condenser lid.
9. Lock the 2 blockages until they snap.
10. Close the condenser door.

**CAUTION!**

Do not operate the tumble dryer when the condenser is blocked with fluff. This could cause the damage to the tumble dryer. This also increases energy consumption.

Do not use sharp objects to clean the condenser. The damaged condenser could cause leaks.

Do not operate the tumble dryer without the condenser.

9.4 Cleaning the drum

**WARNING!**

Disconnect the appliance before you clean it.

Use a standard neutral soap detergent to clean the inner surface of the drum

**CAUTION!**

Do not use abrasive materials or steel wool to clean the drum.

9.5 Cleaning the control panel and housing

Use a standard neutral soap detergent to clean the control panel and housing. Use a moist cloth to clean. Dry the cleaned surfaces with a soft cloth.

**CAUTION!**

Do not use furniture cleaning agents or cleaning agents which can cause corrosion to clean the appliance.

10. TROUBLE SHOOTER AND SERVICE

10.1 Troubleshooting

Problem ¹⁾	Possible cause	Remedy
The tumble dryer does not operate.	The tumble dryer is not connected to mains supply.	Connect in at mains socket. Check fuse in fuse box (domestic installation).

Problem¹⁾	Possible cause	Remedy
	The loading door is opened.	Close the loading door.
	The On/Off button was not pushed.	Push the On/Off button.
	The Start/Pause button was not pushed.	Push the Start/Pause button.
	The appliance is in the standby mode.	Push the On/Off button.
Unsatisfactory drying results.	Incorrect programme selection.	Do the selection of the applicable programme. 2)
	The filter is clogged.	Clean the filter. 3)
	The Dry Plus function was in minimum mode.	Change the Dry Plus function to the moderate or maximum mode.
	The condenser is clogged.	Clean the condenser. 3)
	Too high volume of the load.	Obey the maximum load volume.
	The airflow grill is clogged.	Clean the airflow grill in the bottom of the appliance.
	Dirt on the inner surface of the drum.	Clean the inner surface of the drum.
	Too high water hardness.	Set applicable water hardness ⁴⁾ .
The door does not close.	The filter not locked in the position.	Put the filter in the correct position.
	The laundry is locked between the door and the seal.	Put the load correctly in the drum.
Err (Error) on the display.	You try to change the programme or the function after the start of the cycle.	Turn the tumble dryer off and on. Make the new selection.
	The function you try to activate is not applicable with the selected programme.	Turn the tumble dryer off and on. Make the new selection.
No drum light 5)	Defective drum light.	Contact the service centre to replace the drum light.
Abnormally elapsing time on the display.)	The time to end is calculated on the basis of the volume and dampness of the laundry.	The automatic procedure — this is not the appliance malfunction.
Programme inactive.	The water container is full.	Drain the water container ³⁾ , push the Start/Pause button.

Problem ¹⁾	Possible cause	Remedy
Drying cycle too short.	Too small laundry volume.	Do the selection of time programme. The time value must be related to the load. To dry one item or small quantities of the laundry we recommend to use short times.
	The laundry is too dry.	Do the selection of time programme or higher drying level (e.g. Extra Dry)
Drying cycle too long ⁶⁾	The filter is clogged.	Clean the filter.
	Too high volume of the load.	Obey the maximum load volume.
	The laundry not spun sufficiently.	Spin correctly the laundry.
	Very high room temperature - this is not the appliance malfunction.	If possible, lower the room temperature.

¹⁾ If there is an error message on the display (e.g. **E51**): Turn the tumble dryer off and on. Make a selection of the new programme. Push the Start/Pause button. Does not operate? - contact the service centre and give the error code.

²⁾ follow the programme description — see *PROGRAMMES* chapter

³⁾ see *CARE AND CLEANING* chapter

⁴⁾ see section *WATER HARDNESS* in *HINTS AND TIPS* chapter

⁵⁾ Only the tumble dryers with drum light.

⁶⁾ Note: After maximum 5 hours the drying cycle ends automatically (see *Drying cycle complete* section).

10.2 Drum internal lamp

This appliance has an internal lamp that comes on when you open the door and goes off when the door is closed.



WARNING!

Do not look directly into the beam of the lamp.



To replace the internal lamp, contact the service centre. Disconnect the mains plug from the mains socket before the replacement of the internal lamp.

11. TECHNICAL INFORMATION



height x width x depth	850 x 600 x 600 mm (maximal 640 mm)
drum volume	118 l
maximum depth with the load door opened	1090 mm

maximum width with the load door opened	950 mm
adjustable height	850 mm (+ 15 mm - feet regulation)
the appliance weight	41 kg
maximum load volume	8 kg
voltage	230 V
frequency	50 Hz
necessary fuse	10 A
total power	2250 W
energy efficiency class	B
energy consumption kWh/cycle ¹⁾	4,48 kWh
annual energy consumption ²⁾	268,8 kWh
type of use	Domestic
permitted ambient temperature	+ 5°C to + 35°C

1) 8 kg of cotton, centrifuged at 1000 rpm with reference to EN 61121

2) The sum of approximate energy consumption to dry:

150 kg of the cotton laundry with *cupboard dry* programme

+ 280 kg with *iron dry* programme

+ 150 kg of synthetic laundry with *cupboard dry* programme.

This is approximate consumption for the 4 person household which correctly use the tumble dryer.

12. INSTALLATION

12.1 Appliance positioning

- The tumble dryer must be installed in a clean position, where dirt does not collect.
- Air must flow freely around the appliance. Make sure that the front airflow slots in the bottom of the appliance are not blocked .
- To keep vibration and noise at the minimum, when the tumble dryer operates, it must be put on a stable and flat surface.
- When the appliance is put in its permanent position, check if is fully level with the aid of a spirit level. If it is not, adjust the feet until it is.
- Do not remove the feet. Do not decrease the floor clearance through thick carpets, bar of wood or equivalent. This can increase the heat which

can cause interference with the operation of the appliance.



- The temperature of the hot air which occurs in the tumble dryer can increase to 60 °C. The appliance must not be installed on the floor which is not resistant to high temperatures.
- When the tumble dryer operates, the room temperature must not be lower than +5 °C and higher than +35 °C. This can cause unwanted effect on the performance of the appliance.
- If it is necessary to move the appliance, it must be moved vertically.
- The appliance must not be installed behind a lockable door, a sliding door, a door with a hinge on the opposite side to that of the appliance in such a way that a full opening of the tumble dryer is restricted.

It is possible to adjust the height of the tumble dryer. To do that adjust the feet (see picture).

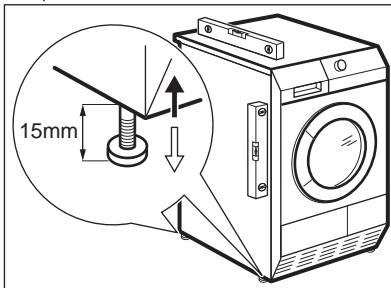

12.2 Unpacking



CAUTION!

Before use all parts of the transport packaging must be removed. To remove the polystyrene blockages:

1. Open the load door.
2. Pull plastic hose with the polystyrene blockages out from the drum.

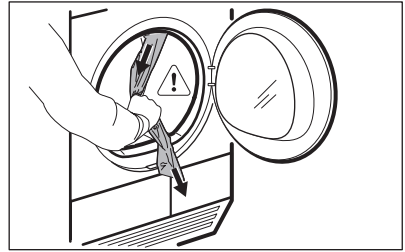

12.3 Installation under a counter

The appliance can be installed as free-standing or below the kitchen counter with correct space (see picture).

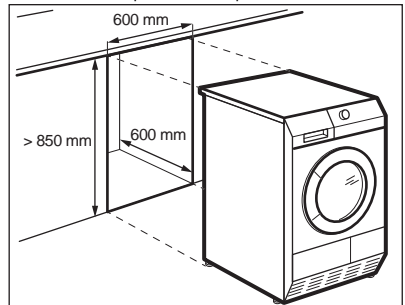

12.4 The load door reversal

The load door can be installed by the user in the opposite side. It can help to easily put and remove the laundry or if there is a limit to install the appliance. (see separate leaflet).

12.5 Electrical connection

- Connect the machine to an earthed socket, in accordance with current wiring regulations.
- Make sure that the electrical data on the rating plate agrees with the power supply.
- Always use a correctly installed shock-proof socket.
- Do not use multiple plugs and extension cables. There is a risk of fire.
- Should the appliance power supply cable need to be replaced, this must be carried out by our Service Centre.

Q - Warranty

AEG products are designed and built to the highest standards.
We expect your appliances to provide many years of trouble free enjoyment.
In the event of an appliance requiring attention, each appliance is covered by a 2 year warranty from the date of purchase.

Refer to warranty policy for complete terms and conditions.

Coverage is for costs of parts and labor for appliances in capital cities & metropolitan areas. We reserve the right to charge directly for handling expenses outside the metropolitan region.

AEG products are supported by a national service support system.
Call our customer service department for attention.

Please retain your invoice **AEG to quote should you require service assistance. This will identify your product for our priority service back-up. Please attach your invoice to this manual for easy future reference.**

AEG Canada
871 Cranberry Court
Oakville, Ontario L6L 6J7
Canada

Tel 905-829.3980
Fax 905-829.3985
email marketing@euro-line-appliances.com

For Service & Spares:
EURO-PARTS
1.800.678.8352

Important: Please record details of your purchase below and mail or fax to AEG

-----cut along line-----



Name: _____ TEL No _____
Address: _____
City : _____ State: _____ Zip Code: _____
Where purchased: _____ Purchase date: _____
Items purchased: _____
Serial No. (s): _____

AEG appliances are imported and distributed in North America by Euro-Line Appliances Inc.
For more information visit
www.euro-line-appliances.com / www.elawest.com

EURO-LINE APPLIANCES INC.

871 Cranberry Court
Oakville, ON L6L 6J7
Canada
Toll Free: 1.800.421.6332
Showroom: 905.829.3980
marketing@euro-line-appliances.com

EURO-LINE APPLIANCES WEST INC.

2912 West 4th Ave
Vancouver, BC V6K 1R2
Canada
Toll Free: 1.855.352-9378
Showroom: 604.235.3980
info@elawest.com