

Drystar 5300

User manual



Point of > Knowledge

AGFA 

For more information on Agfa products and Agfa HealthCare products, please visit www.agfa.com, your Point of Knowledge.

© Agfa-Gevaert N.V. 2003.

No parts of this document may be reproduced, copied, adapted or transmitted in any form or by any means without the written permission of Agfa-Gevaert N.V.

Agfa-Gevaert N.V. makes no warranties or representation, expressed or implied, with respect to the accuracy, completeness or usefulness of the information contained in this document and specifically disclaims warranties of suitability for any particular purpose. Agfa-Gevaert N.V. shall under no circumstances be liable for any damage arising from the use or inability to use any information, apparatus, method or process disclosed in this document.

Agfa-Gevaert N.V. reserves the right to make changes to this document without prior notice.

Agfa-Gevaert N.V., Septestraat 27, B-2640 Mortsel, Belgium.

Drystar 5300 is a trademark of Agfa-Gevaert N.V., Belgium.

Agfa and Agfa-Rhombus are trademarks of Agfa-Gevaert AG, Germany.

Table of contents

Chapter 1: Introducing the Drystar 5300	5
Drystar 5300 features	6
Safety precautions	8
Security precautions.....	12
Safety compliance	13
Operating modes	16
Control modes (local and remote).....	17
The user interface	18
Switching on the Drystar 5300.....	28
Switching off the Drystar 5300.....	30
Chapter 2: Basic operation (operator mode)	31
Overview of operator functions	32
Managing the print queue.....	33
About Drystar 5300 consumables.....	35
Loading films.....	36
Chapter 3: Advanced operation (key-operator mode)	43
Overview of key-operator functions	44
Quality control procedure	45
Preventive maintenance schedule	58
Cleaning the exterior	59
Cleaning the print head resistor line	60
Troubleshooting checklist.....	64
Appendix A: Equipment information sheet	65
Specifications.....	66
Options and accessories	69
Appendix B: Quality Control Charts	71

Introducing the Drystar 5300

This chapter introduces the Drystar 5300 to the user and draws attention to important safety precautions.

- [Drystar 5300 features](#)
- [Safety precautions](#)
- [Security precautions](#)
- [Safety compliance](#)
- [Privacy and security](#)
- [Operating modes](#)
- [Control modes \(local and remote\)](#)
- [The user interface](#)
- [Switching on the Drystar 5300](#)
- [Switching off the Drystar 5300](#)

Drystar 5300 features

The Drystar 5300 is a **dry digital tabletop printer** for producing medical diagnostic images. It can print two formats (11x14" or 14x17") blue-based and clear-based film and offers crisp, dense grayscale images.

❖ *The Drystar 5300 is a Dicom-only network printer.*

The Drystar 5300 offers the following features:

- Dry technology for printing diagnostic quality hardcopies in full daylight offers important advantages: no chemistry, no wet processing, simple cleaning procedures, no time-consuming adjustments, no darkroom and no chemical disposal costs. The consumables can be loaded in full daylight.
- With its compact design, the Drystar 5300 needs little work space and allows easy customer access. Maintenance and service activities are reduced to a minimum.
- The direct thermal printing system provides grayscale images with high quality: 320 pixels per inch resolution, each pixel with 12 bit contrast resolution and an optical density ranging from 0.2 up to 3.1 (if an X-Rite 310 densitometer is used).
- Two film formats (11x14" or 14x17") can be used.
- The input tray of the Drystar 5300 is equipped with an RF-tag reader, which automatically traces the films used in the printer and protects the printer when detecting non-identified media.
- Number of input trays.
The Drystar 5300 is delivered with 1 input tray, which can use two film formats (11x14" or 14x17").
- Number of output trays.
The Drystar 5300 is equipped with 1 output tray, which can be adjusted to receive two film formats (11x14" or 14x17").

Network features

- The modular design offers optimal application functionality for your specific networking requirements.

In a network configuration, the Drystar 5300 is fully compatible with Agfa's diagnostic imaging systems, including the ADC Compact and ADC Quality System software, the Paxport and the entire line of Impax Review Systems, Storage Stations and Transmitting Stations.

- The functionality of the Drystar 5300 is completely controlled via the network.
- You can control the working of the Drystar 5300 via the local keypad or via a remote PC with a functioning web browser.

Customizable features

- Consumables.

The Drystar 5300 can handle Drystar DT 2B and Drystar DT 2C consumables, both in two formats (11x14" or 14x17").

Software license information

- The Drystar 5300 uses software developed by the Apache Software Foundation (<http://www.apache.org/licenses/LICENSE>).







Safety precautions



- ❖ *The Drystar 5300 must only be operated according to its specifications and its intended use. Any operation not corresponding to the specifications or intended use may result in hazards, which in turn may lead to serious injuries or fatal accidents (for example electric shocks). AGFA will not assume any liability whatsoever in these cases.*
- ❖ *All images created using any image technology can show artifacts which could be mixed up with diagnostic relevant information. If there is any doubt that the diagnostic information could not be absolutely true, additional investigations must be performed to get a clear diagnostic.*

When operating or maintaining the Drystar 5300, always observe the following safety guidelines:

- Have electrical or mechanical defects repaired by qualified personnel only!
- Do not override or disconnect the integrated safety features.
- Ventilation openings should not be covered.
- Always switch off the Drystar 5300 and disconnect the power cord from the outlet before carrying out any maintenance work.
- ❖ *Film jam removal or cleaning the printer thermal head can be done without switching the power off. Nevertheless, care should be taken and the following instructions should be respected:*

Always take into account the markings provided on the inside and outside of the printer. A brief overview of these markings and their meaning is given below.

	<p>Safety warning, indicating that the Drystar 5300 manuals should be consulted before making any connections to other equipment. The use of accessory equipment not complying with the equivalent safety requirements of this printer may lead to a reduced level of safety of the resulting system. Consideration relating to the choice of accessory equipment shall include:</p> <ul style="list-style-type: none"> • Use of the accessory equipment in the patient vicinity, • Evidence that the safety certification of the accessory equipment has been performed in accordance with the appropriate IEC 601-1 and IEC 601-1-2 harmonized national standard. <p>In addition all configurations must comply with the medical electrical systems standard IEC 601-1-2. The party that makes the connections acts as system configurator and is responsible for complying with the systems standard.</p> <p>If required contact your local service organization.</p>
	<p>Caution hot: Keep hands clear from the thermal print head.</p>
	<p>In order to reduce the risk of electric shock, do not remove any covers.</p>
	<p>Type B equipment: Indicates that the Drystar 5300 complies with the limits for type B equipment.</p>
	<p>Supplementary protective earth connector: Provides a connection between the Drystar 5300 and the potential equalization busbar of the electrical system as found in medical environments. This plug should never be unplugged before the power is turned off and the power plug has been removed.</p>
	<p>Intergrounding connector: Provides a connection between the printer and other equipment which might exhibit minor ground potential differences. These differences may degrade the quality of communication between different equipment. Never remove connections to this terminal.</p>
	<p>Protective earth (ground): Provides a connection between the printer and the protective earth of the mains. Do not remove this connection, because this will have a negative influence on the leakage current.</p>

	<p>Power button: Note that the power cord has to be disconnected from the wall outlet in order to disconnect the unit entirely from the mains.</p>
	<p>Precautions for use in USA only: Make sure that the circuit is single-phase center-tapped, if the printer is connected to a 240 V/60 Hz source instead of a 120 V/60 Hz source.</p>

Transport after installation

Before moving the printer, always switch off the machine. The Drystar 5300 should always be transported by 2 persons. When doing this, the stability and the structure of the table top have to be taken into account. The printer should not be placed on a soft surface, since this might prevent appropriate ventilation and cause overheating. The printer must only be transported with all covers closed. The appliance may not be transported continuously from one location to the other. Do not lift the printer by the output tray.

Waste disposal and environmental regulations

In most countries Drystar film is considered industrial waste and consequently it is not allowed to be disposed as household waste. Please consult your local waste disposal regulations. Agfa recommends having waste Drystar film collected by a licensed company.

After its life span, do not dispose of the Drystar 5300 without consideration of local waste disposal regulations. Please consult your local service organization.

Security precautions



CAUTION: U.S. Law restricts this device to sale to or on the order of a licensed physician.



Printed images should be treated as patient records and should only be viewed by authorized personnel.



If the power to the printer is unexpectedly interrupted, ensure that unprinted images are not deleted from the modality prior to printing. To avoid loss of images in such conditions, a UPS (Uninterruptable Power Supply) needs to be supplied to the printer.

Safety compliance

EMC issues

- USA: This equipment has been tested and found to comply with the limits for a class A digital device, pursuant to part 15 of the FCC rules. These limits are designed to provide reasonable protection against harmful interference when the equipment is operated in a commercial environment. This equipment generates, uses, and can radiate radio frequency energy and, if not installed and used in accordance with the Reference manual, may cause harmful interference to radio communications. Operation of this equipment in a residential area is likely to cause harmful interference, in which case the user will be required to correct the interference at its own expense.

If required, contact your local service organization.

- Canada: This class A digital apparatus meets all requirements of the Canadian Interference-Causing Equipment Regulations.
- EC: This is a class A product. In a domestic environment this product may cause radio interference in which case the user may be required to take adequate measures.

Compliances

This equipment complies with:

- the Medical Devices Directive 93/42/EEC
 - the standards UL2601-1 of Underwriters Laboratories
 - CSA 22.2 No. 601.1-M90 of the Canadian Standards Association
 - FDA 510k
 - FDA Part 820 Good Manufacturing Practice for Medical devices
 - IEC 601-1 and IEC 601-1-2
 - EN 60601-1:1990 + A1:1993 + A2:1995
 - EN 60601-1-2:2001
- ❖ *The Drystar 5300 carries the CE, TÜV and CUL labels.*

Privacy and security

Within the healthcare industry, several standardization efforts are ongoing as a response to Privacy and Security legislation and regulations. The purpose of this standardization for hospitals and vendors is to enable information sharing, interoperability and to support the workflow of hospitals in a multiple vendor environment.

In order to allow hospitals to comply with HIPAA regulations (Health Insurance Portability and Accountability Act) and to meet the IHE standards (Integrated Healthcare Enterprise) some security features are included in the user interface of the Drystar 5300 (available via the web pages only: under 'Security tools'. Refer to [Chapter 4, 'Controlling the Drystar 5300 via a remote PC \(with browser\)'](#) of the Drystar 5300 Reference manual):

- User authentication. The administrator can configure different user accounts. Each account consists of a user name and a password.
- Audit logging. This implies logging to a central log server of specific Drystar 5300 'actions', e.g. startup/shutdown, user authentication (failures), received print job ID information, etc.
- Node authentication, using certificates. Working with SSL (Secure Sockets Layer) allows secure communications over an insecure network. SSL is the security layer on top of TCP/IP.

The first two functions are available when access to the Administrator is granted (i.e. when the Administrator password has been correctly entered). To activate the SSL, please contact your Agfa representative.

Node authentication, certificates and Certification Authority

Each device, connected to a network, will receive a unique identifier: the X.509 certificate, a digital passport. Any device on the network is only allowed to communicate with another node of which it is holding the certificate in a 'communication allowed' table.

A Certification Authority (CA) is responsible for creating a certificate. The CA can be the hospital, Agfa or a third party.

This CA distributes the certificate to the hospital security responsible or service technician, who for his part:

- Imports the device certificate, created by the CA.
- Imports the certificates of all peer devices with which communication is authorized, i.e. creates the list of 'communication allowed' device certificates.

Operating modes

The Drystar 5300 can be operated in four modes: Operator mode, Key-operator mode, Service mode and Administrator mode.

Operator mode

The Operator mode groups all basic functions that are intended for radiographers without special technical skills:

- Producing diagnostic usable hardcopies,
- Loading consumables,
- Ensuring normal operation of the printer.

All functions of the Operator mode are described in both User and Reference manuals. Refer to [Chapter 2, 'Basic operation \(operator mode\)'](#).

Key-operator mode

The Key-operator mode groups advanced functions that are intended for technically skilled operators such as X-ray operators, network managers and service and hospital technicians.

The Key-operator mode can be accessed via the Key-operator key on the keypad and is menu-driven. The Key-operator functions are described in the Reference manual only. Refer to [Chapter 3, 'Advanced operation \(key-operator mode\)'](#).

Service mode

The Service mode functions are reserved for trained Service personnel. The Service mode is password protected and is only accessible by browser via a remote PC.

Administrator mode

The Administrator mode functions are reserved for the System Administrator. The Administrator mode is password protected and is only accessible by browser via a remote PC.

Control modes (local and remote)

You can control the working of the Drystar 5300 via the local keypad or via a network remote PC.

The table below gives an overview of the operating modes you can access locally and/or via the remote PC.

Local	Password protected	Remote	Password protected
Operator mode	No	—	—
Key-operator mode	No	Key-operator mode	Yes
—	—	Service mode	Yes
—	—	Administrator	Yes

The manual describes the controlling of the Drystar 5300 via the keypad. The menus for controlling the Drystar 5300 via a remote PC are structured in the same way, and sometimes they offer even more possibilities. Refer to [Chapter 4, 'Controlling the Drystar 5300 via a remote PC \(with browser\)'](#) of the Drystar 5300 Reference manual.

The user interface

The Drystar 5300 interfaces with the user via the following controls:

- Power/Reset button,
- a keypad and a display,
- a status indicator LED,
- audio signals.

Overview of user interface controls

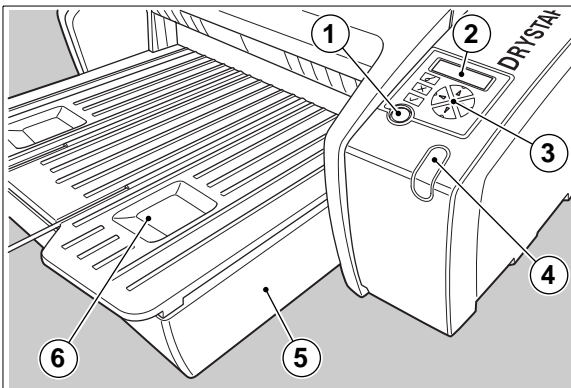

1	Power/Reset button
2	Display
3	Keypad
4	Status indicator LED
5	Film input tray
6	Film output tray



Never try to open the printer when the Drystar 5300 is printing a film. Always follow the instructions on the display!

The status indicator LED

On the right side of the display, an LED indicates the status of the Drystar 5300.

Color / Light		Status	Action
Green	Constant	Ready (stand-by)	Proceed
	Blinking	Busy or in key-operator mode	Wait
Red	Blinking	Warning status	Check the display for messages. Refer to ' Checking the status indicator LED ' on page 171 of the Drystar 5300 Reference manual.
	Constant	Error status	

The control buttons

One control button has been provided:

	Power/Reset button	<ul style="list-style-type: none">• To power on or off the printer.• To reset the printer.
---	------------------------------	---



Do NOT press the Power/Reset button without first following the procedure to stop printing when the Drystar 5300 is printing a film. Refer to '[Switching off the Drystar 5300](#)' on page 30.

Rear panel

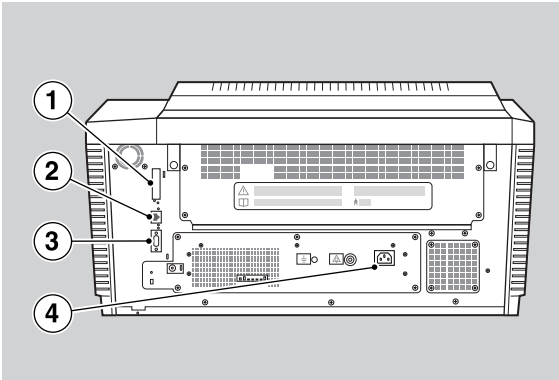

At the rear side of the printer, one slot and three connectors are available:

1	CF-card slot	<ul style="list-style-type: none">To insert an external CF-card for software installation, backup, etc.
2	Network connector	<ul style="list-style-type: none">To connect a remote PC (used for access via the web browser pages).
3	Input/output connector	<ul style="list-style-type: none">To connect a terminal PC (used by the Service engineer).
4	Power connector	<ul style="list-style-type: none">To connect the printer power cord.

Working with Compact flash cards (CF-card)

The Drystar 5300 is equipped with an external CF-card slot.

A CF-card has the following physical characteristics:

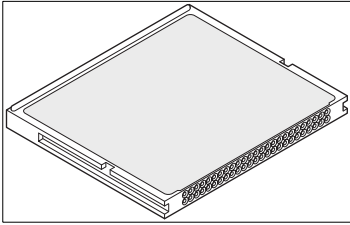

- a flat surface on one side (there is also often a label present),
- a small rim on the other side,
- connector holes on the opposite side of the rim side.

Inserting a CF-card

To insert a CF-card in the Drystar 5300 (the slot is located at the rear side):

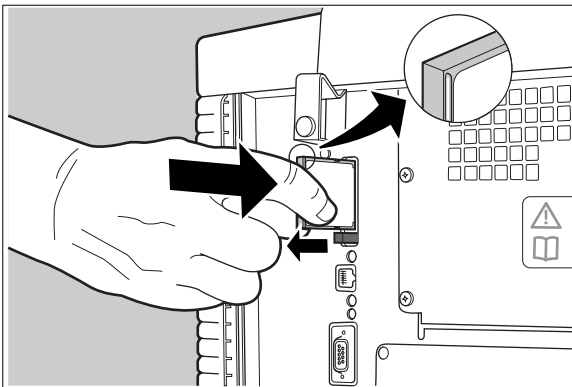

- 1 Hold the CF-card vertically with the connector holes in front of the slot, and with the flat surface pointing to the left.
 - 2 Insert the CF-card gently into the slot, and push it until the unlocking lever underneath the slot comes out.
- ❖ *If you cannot push the CF-card completely into its position, this means that you have to turn it 180 degrees (while keeping the connector holes faced to the slot).*

Removing a CF-card

To remove a CF-card from the Drystar 5300 slot:

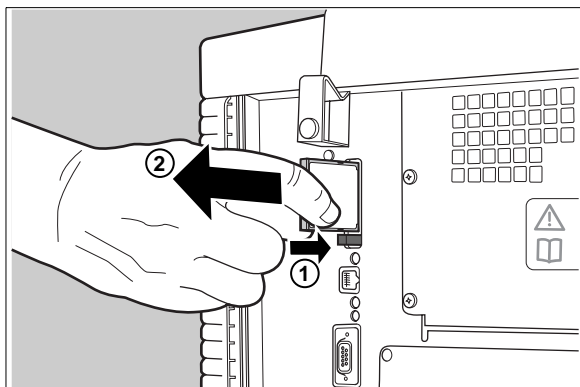

- 1** Push the unlocking lever underneath the CF-card slot.
The CF-card is pushed slightly outward.
- 2** Remove the CF-card gently from the slot.

Audio signals

The Drystar 5300 gives status information via beeps. The length of the beep indicates the response of the system to a key command.



- A **short** beep means that Drystar 5300 has accepted the key command and is starting the operation.
 - A **long** beep means that you have pressed a non-active key or that the Drystar 5300 has rejected the key command.
- ❖ *Certain conditions can cause an **interval** beep. An **interval** beep accompanies an error or warning message. Refer to [‘Troubleshooting checklist’](#) on page 64.*





The keypad

The keypad is located below the display panel.



The Drystar 5300 keypad features the following keys:

	Key-operator key	To access the advanced functions of the key-operator mode. Refer to Chapter 3, ‘Advanced operation (key-operator mode)’ .
	Escape key	To quit the current function or exit a menu without saving modifications.

	Confirm key	(In key-operator mode) <ul style="list-style-type: none"> • To select a menu. • To accept an entry in a menu.
	Up key	<ul style="list-style-type: none"> • To move the cursor to the previous entry field. • To scroll upwards. • To increment the number in a(n) (alpha)numerical entry field.
	Down key	<ul style="list-style-type: none"> • To move the cursor to the next entry field. • To scroll downwards. • To decrement the number in a(n) (alpha)numerical entry field.
	Left key	<ul style="list-style-type: none"> • To scroll backwards through multiple choices within a field. • To move the entry position in a(n) (alpha)numerical entry field from right to left. • To toggle between values in a field.
	Right key	<ul style="list-style-type: none"> • To scroll forwards through multiple choices within a field. • To move the entry position in a(n) (alpha)numerical entry field from left to right. • To toggle between values in a field.

- ❖ *All keys (except the key-operator key) have an LED that is on when the key is valid in a certain situation.*
- ❖ *You can press and hold down an arrow key to scroll quickly through a list or a menu.*

The display

The Drystar 5300 control panel has a backlit LCD display with 4 lines of 20 characters each (2 lines of 7 characters for Greek or Asian languages). Its lay-out depends on the operating mode.

General display features

The figure below shows how the display is illustrated in this manual:

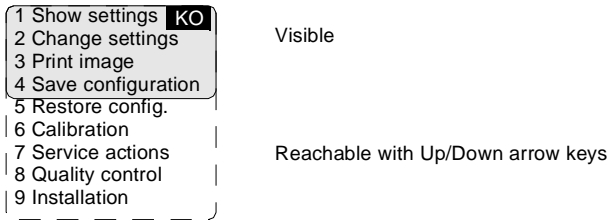

The visible display lines are indicated in the grey zone. The other possible lines are shown in the white area, and can be reached by scrolling using the Up/Down arrow keys on the Keypad.

In the upper right corner, the current printer status is displayed:

- In Operator mode, two characters display the print queue status. Refer to [‘Managing the print queue’](#) on page 33.
- In Key-operator mode, two characters are displayed in reverse video to indicate the current menu- or submenu level (e.g. ‘KO’ for Key-operator main level).

Operator mode

In **operator mode**, appropriate information is displayed in accordance with the status of the printer.

The operator basic screen looks as follows, indicating that the Drystar 5300 is ready for operation and that no job is currently being executed.



When the printer is busy with at least one print job, the print queue screen is displayed:

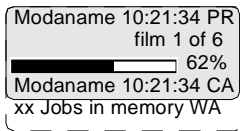

- The **progress indicator** keeps the user informed of the progress of a process (e.g., calculation of a bitmap, printing of a film). The line is gradually filled from left to right, from 0% to 100% as the process proceeds.
- ❖ *On the print queue screen the modality name defined during installation will be used to refer to the corresponding modality. In case a nickname (daily used name) has been defined during installation, this nickname will be used.*

Refer to '[Managing the print queue](#)' on page 33.

Key-operator mode

In **key-operator mode**, operation is menu driven. The menu displays the key-operator functions.

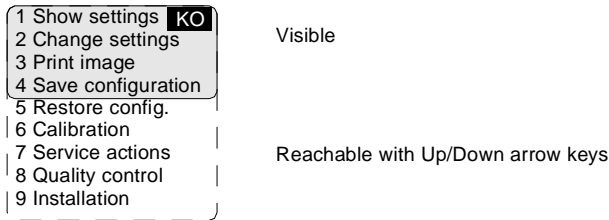

The display shows only four lines. In the above figure, they are indicated in the grey zone. The other possible lines are shown in the white area, and can be reached by scrolling using the Up/Down arrow keys on the Keypad.

The active keys are indicated by their respective LEDs.

Data entry

When entering numerical or alphanumeric data, always adhere to the following principles:

- Only (alpha)numerical data can be entered.
- During data entry, the field is displayed in reverse mode.
- Increment the number in a(n) (alpha)numerical entry field by pressing the Up key. Transition from 9 to 0 of one figure will also increment the next figure to the left, respecting the valid limits of the range.
- Decrement the number in a(n) (alpha)numerical entry field by pressing the Down key. Transition from 0 to 9 of one figure will also decrement the next figure to the left, respecting the valid limits of the range.
- Move the entry position in a(n) (alpha)numerical entry field from right to left by pressing the Left key.
- Move the entry position in a(n) (alpha)numerical entry field from left to right by pressing the Right key.
- Press and hold down a key to repeat arrow key actions.
- To accept an entry in a menu, press the Confirm key.
- A short beep acknowledges and terminates the entry.
- The Drystar 5300 will sound a long beep if you press a key that is not to be used at that moment.

Switching on the Drystar 5300

- ❖ *Before switching on the Drystar 5300, read the safety instructions. Refer to 'Safety precautions' on page 8.*

Follow the procedure below to ensure proper startup of the Drystar 5300 and to check that everything is working correctly.

- 1 Check that the power cord is plugged in and then switch on the printer by pressing the **Power/Reset** button.



On the display, the following message is displayed. After a short while, a progress indicator will show the proceeding of the self-test.

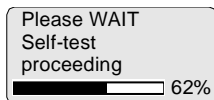

- If anything goes wrong during the self-test, refer to '*Startup errors*' on page 185 of the Drystar 5300 Reference manual.

- 2 The printer is ready for operation:

- If, on the front panel display, the READY message is shown, *the status indicator LED is constantly green.*

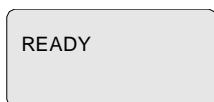

- ❖ *It takes 13 minutes (starting up of the Drystar 5300 and heating up of the thermal print head) before you can start printing. The display will inform you that the printer is warming up:*

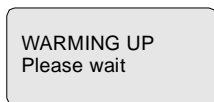

-
- If, on the front panel display, the print queue screen is shown, *the status indicator LED is green and blinking.*

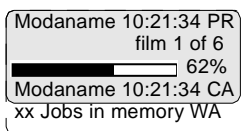

- 3 Make sure that the printer is loaded with appropriate consumables.
 - ❖ Refer to page 36 for detailed information on loading films.
 - ❖ If the job status displays a warning or error indication, refer to *'Troubleshooting checklist'* on page 64.

Switching off the Drystar 5300

When you want to switch off the printer, it is recommended to follow the procedure as described below, to make sure that any pending print jobs have finished printing.

- 1 Make sure that pending jobs are correctly finished. If necessary, follow the procedure to stop printing.
- 2 Press the **Power/Reset** button to switch off the Drystar 5300.



- *If the printer is ready, it shuts down immediately:*

Power off initiated
Please wait

- *If the printer is busy printing images, it will first print all images in the memory before shutting down:*

Power off after
finishing images in
memory
Please wait

- *If there is an error/warning/incident during power off and there are still unprinted images in the memory, the following message is displayed:*

Are you sure to
power off the
printer
YES (v) NO (x)

Press the Confirm button (YES) to proceed with the power-off, or the Escape button (NO) to quit.



Powering off the printer with unprinted images in memory may result in image loss!

Basic operation (operator mode)

This chapter will inform on how to manage the print queue, how to print films with priority and how to load new films.

- [Overview of operator functions](#)
- [Managing the print queue](#)
- [About Drystar 5300 consumables](#)
- [Loading films](#)

Overview of operator functions

This section focuses on the basic operating principles of the Drystar 5300. After reading this chapter, the operator should be able to produce diagnostic usable hardcopies. No special technical skills are required.

All basic operator functions can be activated directly by pressing a single key on the keypad.

Function / Task	Description	Page
<i>'Managing the print queue'</i>	Jobs that have been received are put in a print queue, waiting to be printed.	33
<i>'Loading films'</i>	Instructions for loading new films on the printer.	36

Managing the print queue

You can always check the status of the print jobs.

- ❖ *Keep in mind that one print job can hold several films to be printed. In accordance with the acquisition modality used and with the actual settings, films can be grouped in a folder to be submitted as one print job for the Drystar 5300. Refer to the User manual of the acquisition modality for more information.*

Checking the print queue

If jobs have been transmitted from the network to the Drystar 5300, they are put in the print queue on a first in, first out schedule. New jobs that are added to the queue get the 'waiting' status.

As soon as the last film of a job is ejected in the output tray, the next job that has been calculated will be put in printing status.

Example of the print queue screen:

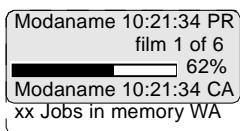

- The first line shows information on the job that is currently being printed: the modality name, the time of receipt of the job and the job status (refer to the table below).
- The second line shows how many films are to be printed for the current job and also which film from that total is currently being printed.
- The **progress indicator** keeps the user informed of the progress of a process (e.g., calculation of a bitmap, printing of a film). The line is gradually filled from left to right, from 0% to 100% as the process proceeds.
- The last line (reachable by using the down arrow key) displays the number (xx) of print jobs that are in the Waiting (WA) status. These jobs have been loaded into the print queue and they are waiting to be printed.

A description of the possible status of the jobs is listed in the table below:

Status		Description
PR	Printing	Printing of this job is in progress.
CA	Calculating	The necessary calculations are already being made before printing of the job can be started.
WA	Waiting	Jobs are queued in the printer memory.

- ❖ *On the print queue screen the modality name defined during installation will be used to refer to the corresponding modality. If there is also a nickname (daily used name) defined during installation, the nickname is used.*

About Drystar 5300 consumables

The Drystar 5300 can handle blue-transparent and clear-transparent films. Available film formats are 11x14" and 14x17".

When a new film pack is loaded, the Film Identification tag is read and the printer settings are automatically adjusted.

The key-operator can overrule the film settings for the input tray. Refer to *'Changing the configuration settings'* on page 58 of the Drystar 5300 Reference manual.

The following film types can be used:

Film type	Film format
Drystar DT2 B	11x14" or 14x17"
Drystar DT2 C	11x14" or 14x17"

- ❖ *If you want to change the film format, the tray configuration must be modified. Refer to *'Changing the film format of the trays'* on page 152 of the Drystar 5300 Reference manual for more information.*

Loading films

This section describes how to load the Drystar 5300 with appropriate films.

The Drystar 5300 can be loaded with 11x14" or 14x17" films.

❖ *The Drystar 5300 can be loaded with new films in full daylight. Loading films is easy and can be done very quickly. Follow the procedures as described in this section.*

The Drystar 5300 will inform you in several ways when a film tray is empty:

- an audible signal,
 - the status indicator LED is flashing (red color),
 - the display screen shows a message informing you that the input tray is empty.
- ❖ *The procedure is slightly different, depending on the fact whether the Drystar 5300 is printing/calculating or in the ready state.*
- ❖ *When the printer is in the ready state, go to Step 3.*



Make sure not to load more than one film pack in an input tray. Loading more than one film pack in the input tray may damage the Drystar 5300.

When the Drystar 5300 is printing or calculating and the input tray is empty:

- 1 The display shows the following message:

Empty input tray	
Do not open tray yet	Flashing
Get new film pack	Flashing

- 2 Wait while the printer finishes printing any current jobs.
When the film path is cleared, proceed with step 3.

When the Drystar 5300 is in the ready state and the input tray is empty:

- 3 The display shows the following message:

Empty input tray	
OK to open the input tray	Flashing
	Flashing

- 4 Open the input tray.

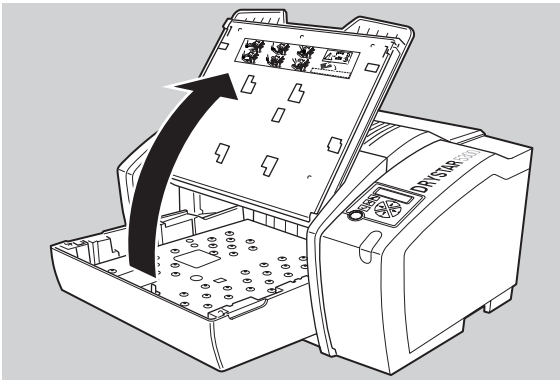

To avoid possible film jams, make sure to open input tray all the way.

5 The printer is ready to receive a new film when the following message appears:

- Remove cover sheet from tray
- Load new film
- Close tray

6 Remove the white (protective) film sheet.

7 Take film pack and slide it into the input tray.

- ❖ *Do not slide the film pack completely into the input tray, otherwise you cannot reach the sticker anymore.*
- ❖ *Verify that the film type on the film pack corresponds with the sticker on the tray! If you use an other film type, you are advised to change the labels (inside and outside) on the tray.*

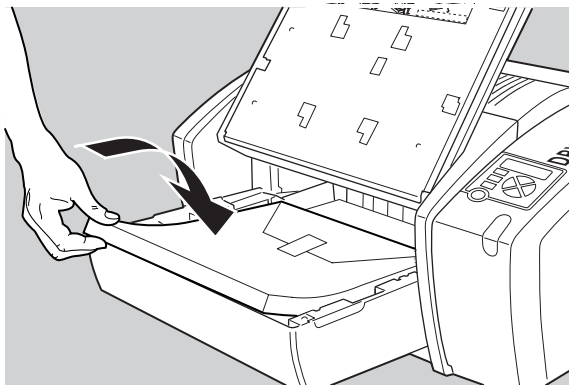

-
- 8** Either remove the sticker completely, or leave it on the film bag; **DO NOT** leave it on the triangular flap!

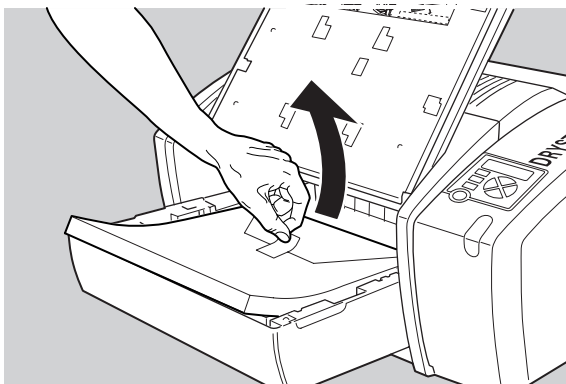

- 9** Slide the film pack completely into the input tray.

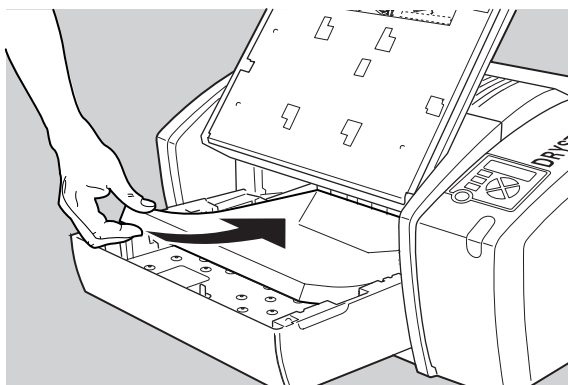

10 Remove the plastic film bag.

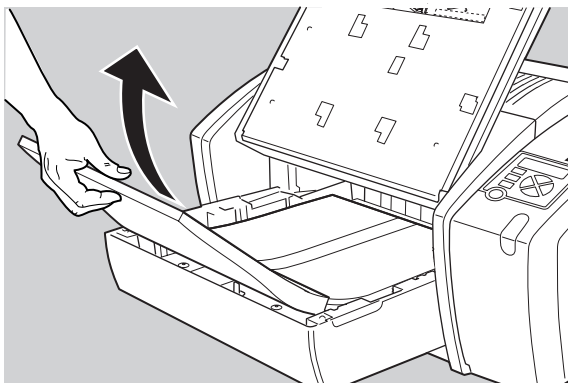

11 Tear the plastic tape from around the film pack.

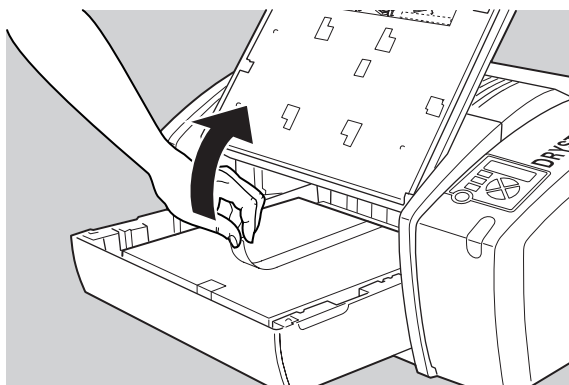

12 Close the input tray.

- ❖ *The Drystar 5300 resumes printing as soon as the tray is closed.*
- ❖ *Loading instructions are also available inside the input tray cover.*

Loading a single film in the input tray

- ❖ When you load a single film sheet (e.g. after removing it from the input tray, or after film jam), make sure that it is correctly positioned. Refer to [‘Checking the correct position of a film in the input tray’](#) on page 42.
- ❖ Also make sure to position the film sheet under both the retainers at the back of the input tray, as shown in the figure:

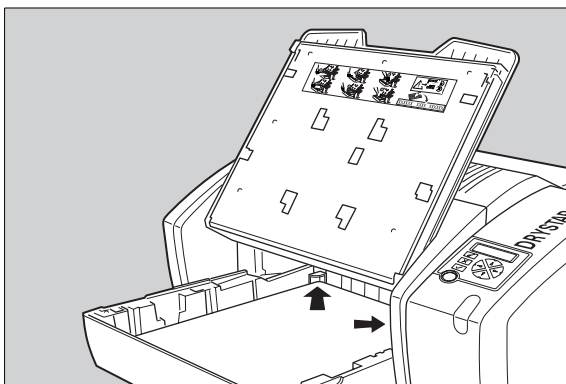

Checking the correct position of a film in the input tray

- ❖ You can verify that the film is properly loaded by watching the lower right corner of the films in the input tray. The rounding of this corner should be smaller than the other three corners. This is also indicated on the sticker at the right side of the input tray cover.

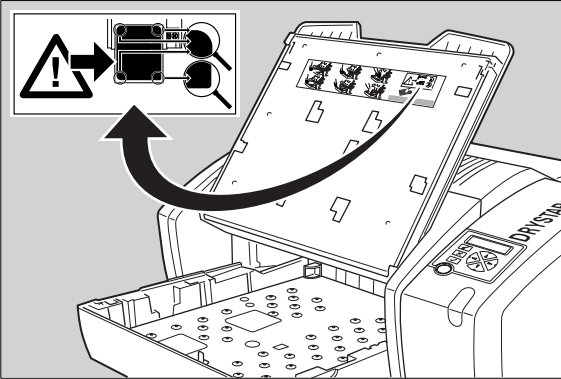

- ❖ When a new film is loaded, the Film Identification tag is read and the printer settings are automatically adjusted. The Film Identification tag is located on the protective sheet on the backside of the film pack. The figure below shows the film pack upside down.

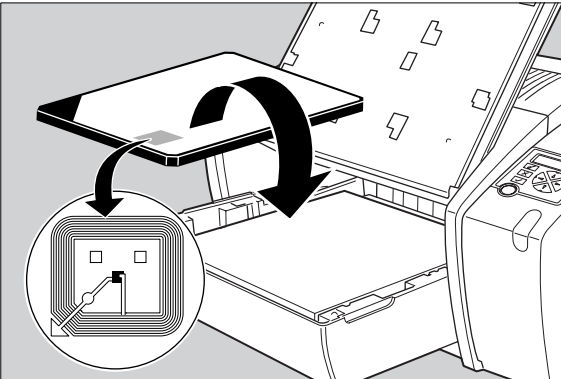

Advanced operation (key-operator mode)

This chapter gives an overview of functions for the advanced user:

- [Overview of key-operator functions](#)
- [Quality control procedure](#)
- [Preventive maintenance schedule](#)
- [Cleaning the exterior](#)
- [Cleaning the print head resistor line](#)
- [Troubleshooting checklist](#)

Overview of key-operator functions

The key-operator menus make it possible to use the Drystar 5300 advanced functions.

- ❖ *These functions are described in detail in the **Drystar 5300 Reference manual**.*

For general information on the key functions of the Drystar 5300, refer to '[The user interface](#)' on page [18](#).

Overview

The Drystar 5300 features the following functions on the main menu level of the key-operator mode:

Menu item	Function	Page
Show settings	To consult the current settings of the printer.	48
Change settings	To change the current settings of the printer.	58
Print image	To print one of the Drystar 5300 test images. To load and print images from an external CF-card.	91
Save configuration	To make a backup of the printer settings.	95
Restore configuration	To restore the backup of the printer settings.	97
Calibration	To maintain optimal image quality.	101
Service actions	To view error, repair and maintenance data.	122
Quality control	To perform the QC procedure.	45
Installation	To install or update the Drystar 5300 software.	122

Refer to the indicated page of the Drystar 5300 Reference manual for an explanation of the function and the appropriate procedures.

Quality control procedure

In order to establish and maintain constant image quality, a regular evaluation of the image quality is advised.

The Drystar 5300 Imager contains an automatic QC feature designed to maintain optimum image quality. The QC procedure consists of two main steps:

- Before initial use, establishing a number of reference values that will be used for further follow-up and verifying initial image quality.
- After establishing these values, performing regular daily, weekly and annual quality tests.

The results of these tests are registered on Quality Control Charts.

The QC image (see page [52](#)) has several additional fields where the QC data can be filled in. This image should be filed as part of the QC procedure.

For more info on QC charts, please refer to Appendix C *'Quality Control Charts'* on page [71](#).

Establishing the reference values and verifying image quality

After installation of a new Drystar 5300 Imager and before initial use you must establish Quality Control aim values. These values will be used as the base line for comparison when daily Quality Control is done. These values should be determined again after major service or repair.

The following Quality Control aim values must be determined:

- The daily operating density levels. Refer to *'Establishing the daily operating reference density levels'* on page 47.
- Drystar 5300 image geometry. Refer to *'Establishing the image geometry reference values'* on page 52.

Once Quality Control aim values are established you must evaluate the Spatial Resolution and the Artifact Levels to determine if the image quality is acceptable. Refer to *'Establishing the image geometry reference values'* on page 52.

The Quality Control aim values, the Spatial Resolution and Artifact levels and the Image Geometry values are all recorded on the Quality Control charts. Refer to Appendix B *'Quality Control Charts'* on page 71.

On these charts, the following test conditions are also recorded:

- The type and serial number of the Drystar 5300 Imager,
- Type and emulsion number of the film used to determine the reference values,
- The type of densitometer used, e.g. internal (in printer) or external,
- If an external densitometer is used: the type and the serial number of the densitometer,
- The time (day, month, year) that the values were established.



Before you can establish the daily operating levels, the Drystar 5300 Imager must be switched on for at least 15 minutes and it must be calibrated as well. Refer to *'Switching on the Drystar 5300'* on page 28 and *'Film calibration'* on page 104 of the Drystar 5300 Reference manual.

Establishing the daily operating reference density levels

This procedure enables you to establish the base line values for:

- Base+Fog density,
- Mid density,
- DD (Density Difference),
- MaxD (Maximum Density).



By default, the internal densitometer of the Drystar 5300 will be used. The internal densitometer of the Drystar 5300 is calibrated at installation. Authorized service personnel should recalibrate the internal densitometer annually or after major service or repair.

Do not change the 'default' internal densitometer during the entire QC procedure!

To establish the daily operating density levels, proceed as follows:

- 1 Press the Key-operator key to enter the key-operator mode.
- 2 Press the Down key seven times, followed by the Confirm key to select 'Quality control'.

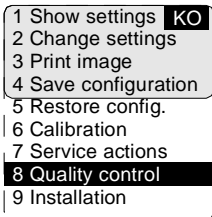

A confirmation screen appears:

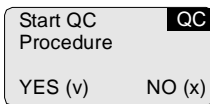

- 3 Press the Confirm key (YES) to start the QC procedure or the Escape key (NO) to quit.

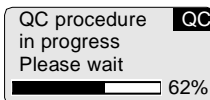

The Drystar 5300 will automatically print the QC test image.

-
- 4 After the image is printed, the Drystar 5300 will display the optical density values:

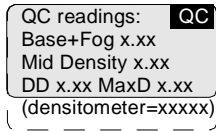

The displayed values represent the following steps on the test film:

- Base+Fog -The density value of the Base + Fog step.
This value should be less than 0.25.
- Mid Density -The density value of the Mid density step.
This value should be greater than 1.20.
- DD - Density Difference, i.e. the density value of the high-density step minus the density value of the low-density step. This value should be greater than 1.30.
- MaxD - The density value of the 100% step.
- (densitometer = xxxxx) - indicates the default densitometer used to measure the density values. It should not be changed during the entire QC procedure.



If the Mid Density and DD values do not meet or exceed the recommended values, the reason must be found and the problem solved before any further clinical films can be printed.

Refer to 'Maintaining optimal image quality' on page 101 and 'Preventive maintenance' on page 161, or call your local Agfa service organization.

- 5 Record the density levels on the Drystar 5300 Chart 1 (Drystar 5300 'Determination of Operating Levels'). Refer to Appendix C '[Quality Control Charts](#)' on page 71.
- 6 Press the Confirm key to return to the main menu.
- 7 Repeat steps 1 through 6 once a day for five consecutive days, as indicated on the Drystar 5300 Chart 1.
- 8 Calculate the average value of the densities from the five (5) images. These values represent operating levels, or aim values, for each density.
- 9 Record the respective aim (average) values as the 'Operating levels' on the Drystar 5300 Charts 2A and 2B (Drystar 5300 'Daily Density Control Chart'). Refer to Appendix B '[Quality Control Charts](#)' on page 71.

-
- ❖ *The calculated 'Operating levels' should respect the following tolerances:*

Operating level	Tolerance
Base + Fog	- 0.03 / + 0.05
Mid Density	+/- 0.20
DD (Density Difference)	+/- 0.20
MaxD	+/- 0.25

- ❖ *The tolerances may be different according to local regulations.*

10 These charts will be used for the daily quality test. For more information, refer to *'Performing the daily QC test'* on page 54.

Verifying Acceptable Spatial Resolution and Artifact Levels

To establish the image geometry reference values, proceed as follows:

- 1 Print the 'QC' test image or use the previously printed QC test image used to establish the daily operating density levels.

You should obtain an image looking like this:

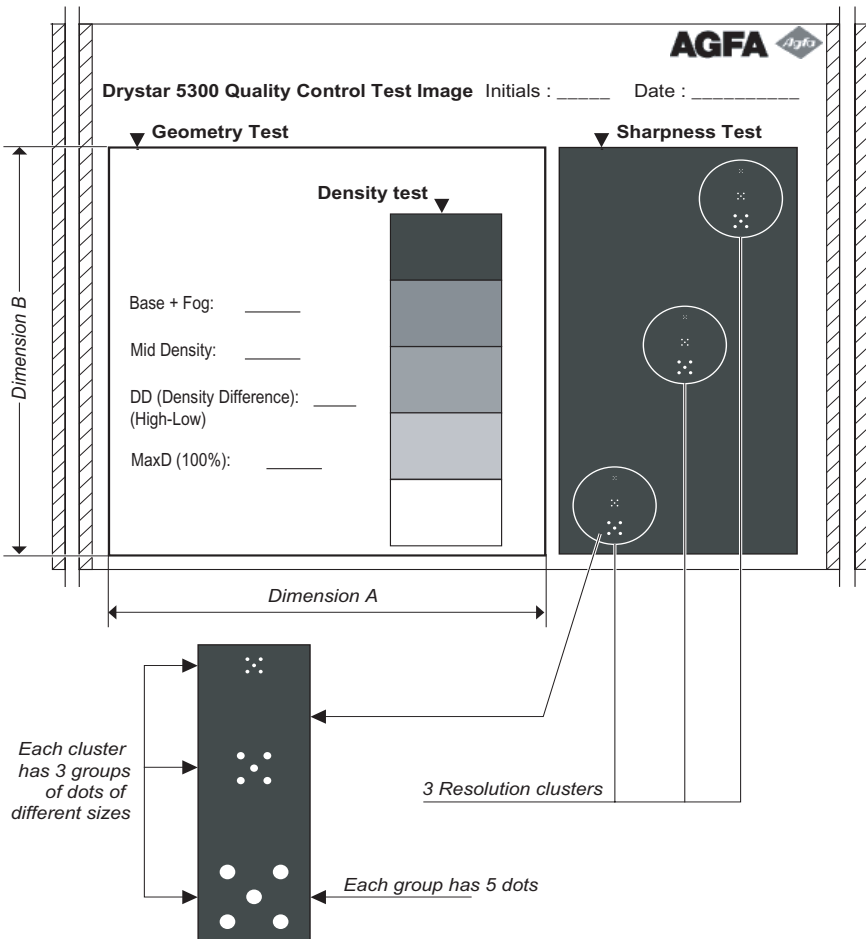

-
- 2 Visually check the 'QC ' test image for artifacts: no significant disturbing artifacts should be visible.
 - 3 Check the spatial resolution by examining the three squares, each of which contains an oval. Within each oval are three groups, each having five dots. All five dots of each group must be visible (use a magnifying glass and optimize viewing conditions).
 - 4 Record these values at the top of the Drystar 5300 Chart 3 ('Drystar 5300 Artifacts and Spatial Resolution Control Chart'). Refer to Appendix B '[Quality Control Charts](#)' on page 71.
 - 5 These charts will be used for the weekly quality test. For more information, refer to '[Performing the weekly QC test \(Spatial Resolution and Artifact Test\)](#)' on page 56.



In case of significant artifacts or insufficient spatial resolution, the reason must be found and the problem solved before any further clinical films can be printed.

Refer to '[Maintaining optimal image quality](#)' on page 101 and '[Preventive maintenance](#)' on page 161 of the Drystar 5300 Reference manual, or call your local Agfa service organization.

Establishing the image geometry reference values

To establish the image geometry reference values, proceed as follows:

- 1 Print the 'QC' test image or use the previously printed QC test image.

You should obtain an image looking like this:

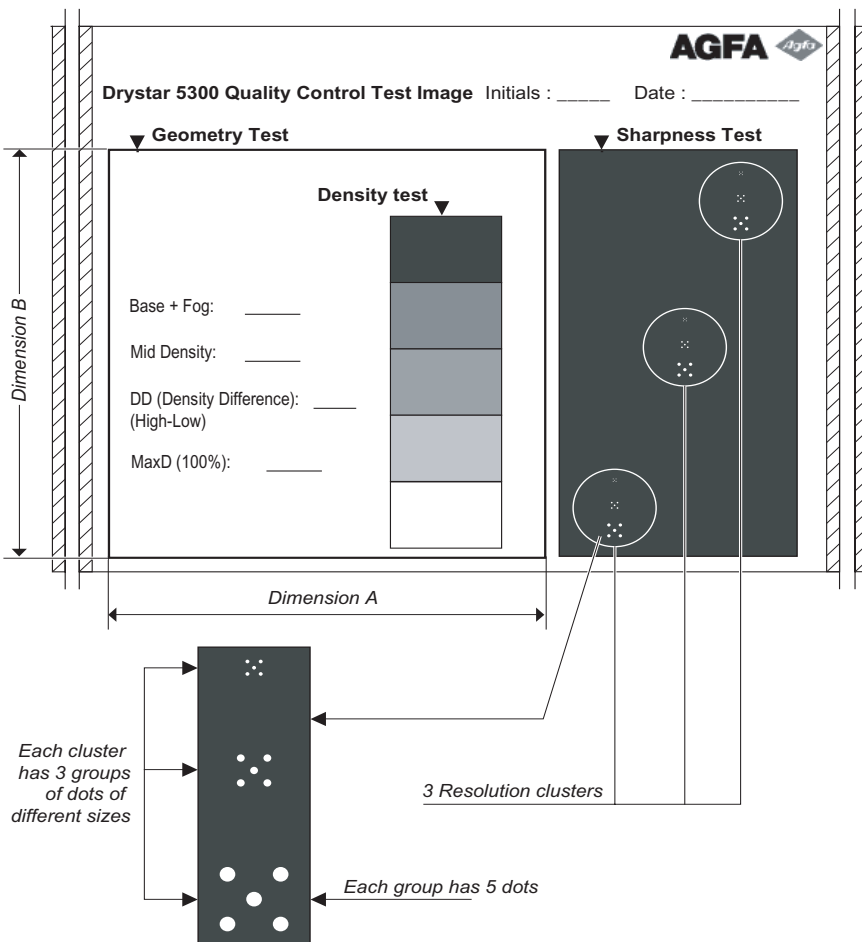

-
- 2 To determine the reference values for geometry, measure the dimensions A and B of the geometry square on the test image.



Make sure to measure distance A from the left edge of the left line to the right edge of the right line and distance B from the upper edge of the upper line to the lower edge of the lower line.

We strongly recommend using a 30-cm (12-inch) machinist scale with 0.5 mm divisions (1/64 inch).

- 3 Record these values as reference dimensions A_{ref} and B_{ref} on the Drystar 5300 Chart 4 ('Drystar 5300 Geometric Consistency Control Chart'). Refer to Appendix C '[Quality Control Charts](#)' on page 71.

These charts will be used for the annual quality test. For more information, refer to '[Performing the annual QC test \(Geometric Consistency Test\)](#)' on page 57.

- 4 Save this film for future reference.

Performing quality control (QC) tests

The following procedures must be performed daily, weekly or annually as indicated.

The reason for performing quality control tests is to determine if any significant image quality variation or deterioration has occurred which may require corrective action. Comparing the results of the tests with the reference values previously established does this.

This procedure allows the operator to take the necessary preventive actions before any image quality loss can take place.

Performing the daily QC test

 **This test must be performed every day before any clinical film can be processed.**

- 1 Switch on the Drystar 5300 and wait for at least 15 minutes. Refer to [‘Switching on the Drystar 5300’](#) on page 28.
- 2 Press the Key-operator key to enter the key-operator mode.
- 3 Press the Down key seven times, followed by the Confirm key to select ‘Quality control’.

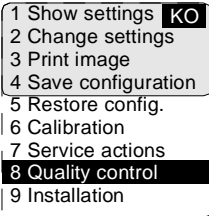

A confirmation screen appears:

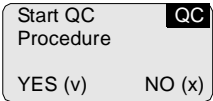

-
- 4 Press the Confirm key (YES) to start the QC procedure or the Escape key (NO) to quit.

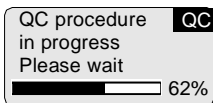

The Drystar 5300 will automatically print the QC test image.

After the QC test image is printed, the Drystar 5300 will display the optical density values:

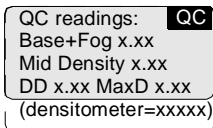

- 5 Report the density levels on the Drystar 5300 Control Charts 2A and 2B (Drystar 5300 'Daily Density Control Chart'). Also record the date and time of the test on the charts and on the QC test image. Refer to Appendix B '[Quality Control Charts](#)' on page 71.
- 6 Press the Confirm key to return to the main menu.



In case the measure results are not within the aim values, the reason for the unacceptable density variations must be identified and resolved before any further clinical films can be processed. This may include repeating the film calibration procedure.

For possible causes of non-compliance and the respective actions, refer to '[Maintaining optimal image quality](#)' on page 101 and '[Preventive maintenance](#)' on page 161 of the Drystar 5300 Reference manual.

Performing the weekly QC test (Spatial Resolution and Artifact Test)

To identify artifacts and verify spatial resolution you must perform the following test weekly or as needed to troubleshoot image quality problems.

- 1** Check the QC test image visually for artifacts: no significant disturbing artifacts should be visible.
- 2** Check the spatial resolution.
The test film also shows three squares which each contains an oval. These 3 ovals contain 3 groups, each having 5 dots. All five dots of each group must be visible (use a magnifying glass and optimize viewing conditions).
- 3** Record the results on Drystar 5300 Chart 3 (Drystar 5300 'Artifacts and Spatial Resolution Control Chart'). Refer to Appendix B '[Quality Control Charts](#)' on page 71.



In case of significant artifacts, insufficient spatial resolution or failure of any other recommended QC tests, the cause of the problem must be identified, and corrective action must be taken before the Drystar 5300 can be used for any further clinical imaging.

Refer to '[Maintaining optimal image quality](#)' on page 101 and '[Preventive maintenance](#)' on page 161 of the Drystar 5300 Reference manual, or call your local Agfa service organization for assistance.

Performing the annual QC test (Geometric Consistency Test)

To be able to notice fluctuations in image size and aspect ratio, you must perform this procedure once a year.

- 1 First, perform the daily test.
- 2 Use the QC test image of the weekly test and measure the dimensions A and B of the geometric square. Refer to *'Establishing the image geometry reference values'* on page 52.



Make sure to measure distance A from the left edge of the left line to the right edge of the right line and distance B from the upper edge of the upper line to the lower edge of the lower line.

We strongly recommend using a 30-cm (12-inch) machinist scale with 0.5 mm divisions (1/64 inch).

- 3 Record these values as measured dimensions A and B on the Drystar 5300 Chart 4 ('Drystar 5300 Geometric Consistency Control Chart'). Refer to Appendix B *'Quality Control Charts'* on page 71.
- 4 Compare the A and B values with the reference values A_{ref} and B_{ref} on the Chart 4 ('Drystar 5300 Geometric Consistency Control Chart').
The differences between measured dimensions A and B and the reference values A_{ref} and B_{ref} should be less than or equal to 1.0%.
- 5 Check for image distortion.
- 6 Calculate the aspect ratio by dividing A by B.
The result must be 1 ± 0.01 .



If the image size or distortion values are outside of limits, contact Agfa service to solve the problem.

Preventive maintenance schedule

The Drystar 5300 is designed for trouble-free service. Maintenance and cleaning involve only some minor user tasks.

Interval	What to do?	Page
Ad hoc	<i>'Cleaning the exterior'</i>	59
Ad hoc	<i>'Cleaning the print head resistor line'</i>	60

Safety guidelines



To prevent damage to the printer while performing maintenance, observe the following safety precautions:

- Do not lubricate the printer.
- Do not attempt to disassemble the printer.
- Do not touch the resistor line of the print head.
- Always switch off the Drystar 5300 and disconnect the power cord from the outlet before carrying out any maintenance work inside the printer.
- ❖ *Film jam removal or cleaning the printer head can be done without switching the power off. Nevertheless, care should be taken and the 'Safety precautions' on page 8 should be respected.*

Cleaning the exterior

- 1** Switch off the Drystar 5300 by following the procedure as described in *'Switching off the Drystar 5300'* on page 30.
- 2** Remove the power plug from the socket.
- 3** Wipe the exterior of the printer with a clean, soft, damp cloth.
Use a mild soap or detergent if required but never use an ammonia-based cleaner.
Be careful not to get any liquid in the power cord port.
- 4** Plug in the printer and switch it on by following the procedure as described in *'Switching on the Drystar 5300'* on page 28.

Cleaning the print head resistor line



Print head cleaning must be done when image quality problems occur. For more information on maintaining image quality, refer to 'Image quality problems' on page 186 of the Drystar 5300 Reference manual.

To clean the print head:

- 1 Press the Key-operator key to enter the key-operator mode.
- 2 On the key-operator main menu, press the Down key five times, followed by the Confirm key to select 'Calibration'.

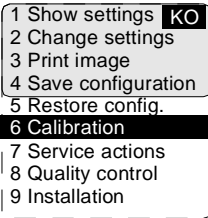

- 3 On the Calibration menu, press the Down key, followed by the Confirm key to select 'Therm. Head clean.'.

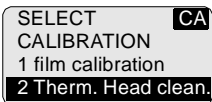

The printer will automatically shut down:

- 4 The 'Thermal head cleaning' screen will give step by step instructions on what to do:

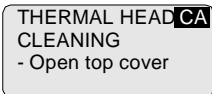

- 5 Open the top cover.

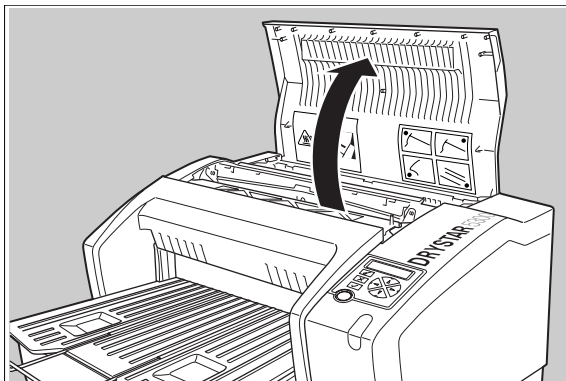

- 6 As soon as the top cover is opened, the 'Thermal head cleaning' screen continues giving the following instructions:

THERMAL HEAD CA
CLEANING
- Clean thermal head
- Close top cover

- 7 Open the hold-down bracket.

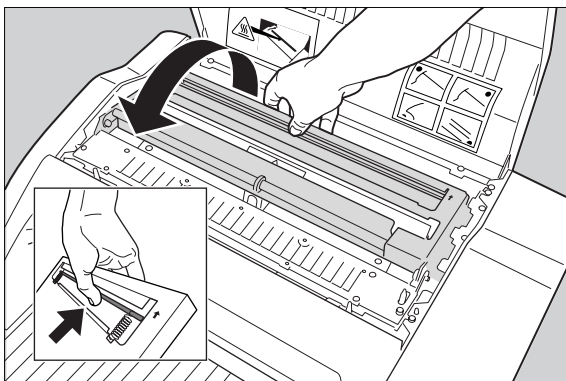

8 Open the print head unit.

! *The print head unit can be warm.*

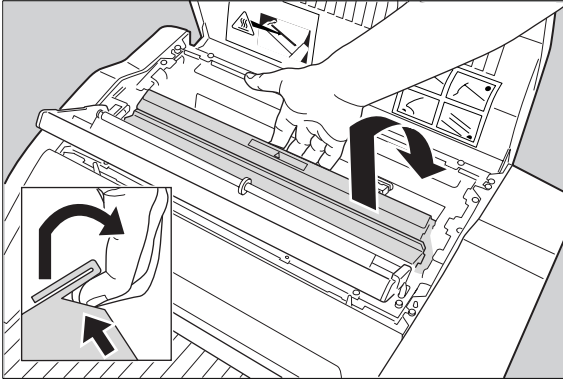

9 Locate and check on sight the print head resistor line.

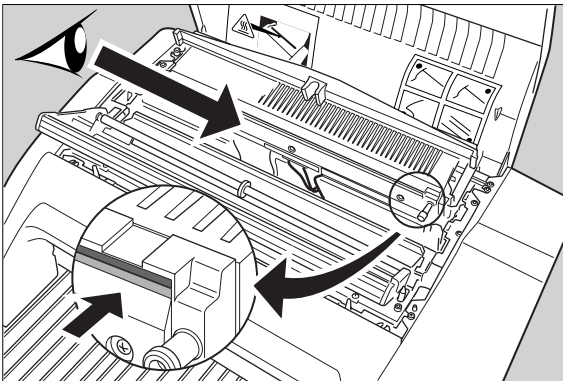

❖ *Be careful not to touch the print head resistor line with your fingers.*

10 Clean the print head resistor line.

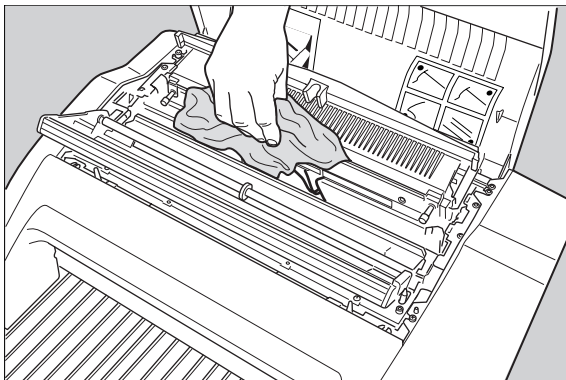

Gently pass over the resistor line a few times with a lint free cloth, slightly moistened with Isopropyl alcohol or Ethanol. **Do this only in one direction, i.e. from left to right, without lifting the cloth.**

- ❖ *Do not apply any pressure on the print head because this pressure may cause damage on the interconnections underneath the print head.*

11 Close the top cover.

After you have cleaned the print head resistor line and you have closed the top cover, the printer will restart automatically.

- ❖ *If residue dust is present as part of the cleaning procedure it will disappear after a few prints.*

Troubleshooting checklist

The table below lists some general problems which can occur when working with the Drystar 5300. Refer to the appropriate pages of the **Drystar 5300 Reference manual**.

- The Drystar 5300 does not print.

Action	Refer to	Page
Check the Drystar 5300	<i>'Checking the status indicator LED'</i>	171
	<i>'Checking the connections'</i>	172
	<i>'Checking the print queue'</i>	174
Remove a jammed film	<i>'Film input tray jams'</i>	176
	<i>'Film transport jams (clearing from the top)'</i>	179
	<i>'Unauthorized opening of the printer'</i>	181
Resolve error messages	<i>'Checking error messages'</i>	173
Handle CF-card errors	<i>'Checking CF-card error messages'</i>	173
Resolve film identification problems	<i>'Film identification problems'</i>	182

- The quality of the printed images is bad (printing remains possible).

Action	Refer to	Page
Resolve film quality problems	<i>'White dots or lines appear in the transport direction'</i>	186
Resolve warning messages	<i>'Maintenance messages'</i>	188



Have electrical or mechanical defects repaired by skilled personnel only!

Appendix

A

.....

Equipment information sheet

Specifications

Product description	
Type of product	Printer
Commercial name	Drystar 5300
Original seller/manufacturer	Agfa-Gevaert N.V.
Labeling	
TÜV-Certification Mark	
cUL-Certification Mark, CE-marking	
Dimensions	
Dimensions (approx. values in cm)	<ul style="list-style-type: none">• Unpacked: width 67, length 80, height 36• Packed: width 80, length 106, height 61
Weight	<ul style="list-style-type: none">• Unpacked: approx. 52 kg• Packed: approx. 82 kg
RAM memory	512 Mb
Mass storage media (internal/external)	Compact Flash Type II
Electrical connection	
Operating voltage	100-127 V; 220-240 V AC
No external mains fuses	
Mains frequency	50/60 Hz

Network connectivity	
Ethernet / connectors	RJ45 twisted pair for 100Base-TX; Serial RS232 connection
Network protocols (TCP/IP services)	FTP, Telnet, HTTP, SMTP
Image formats	DICOM (Default) TIFF
Postscript	Not available
Power consumption	
During operation	250 W
In standby	40 W
Protection against	
Electrical shocks	Class 1 (grounded)
Ingress of water	IPXØ
Environmental conditions (operation)	
Room temperature	Between +15°C and +30°C
Relative humidity	Between 10% and 80% <u>Note:</u> Films may not become wet!
Atmospheric pressure	70 kPa - 106 kPa
Environmental conditions (transport and storage)	
Room temperature	Between -25°C and 55°C (storage) Between -25°C and 70°C (transport)
Relative humidity	Between 10% and 100%
Atmospheric pressure	70 kPa - 106 kPa
Noise emission (method of measurement in accordance with DIN 45635 part 19)	
During operation	Max. 56 dBA
In standby	Max. 47 dBA

Consumables	
Drystar DT 2B and Drystar DT 2C	11x14" and 14x17" film sizes
Print technology	
Direct thermal printing	
Reliability	
Estimated product life (if regularly serviced and maintained according to Agfa instructions)	> 5 years and > 125,000 films
Service interventions	Max. 2 interventions / 3 years
Earthquake kit (standard)	Meets the CA requirements

Options and accessories

Mobile / Earthquake provisions

Hardware

The OPTIONAL mobile/earthquake installation kit allows you to use the Drystar 5300 in a van, or to use it in unstable environment.

It contains the necessary equipment to fix the printer onto a table.

The mobile/earthquake installation kit is delivered with the necessary mounting instructions.

Software

No additional software for mobile/earthquake use is required. Separate saving and restoring of the network settings is provided to facilitate mobile configuration of the printer. Refer to '[Save configuration procedure](#)' on page 95, and to '[Accessing the restore configuration menu](#)' on page 97 of the Drystar 5300 Reference manual for more information.

Connectivity with Agfa equipment

- Paxport
- MG3000
- ADC 70
- ADC Compact
- ADC Compact Plus
- ADC Solo
- Impax
- DR-Thorax

Connectivity with non-Agfa equipment

From a connectivity point of view, every connection to a modality supporting "DICOM print" is released per default (Generic Release). At market launch, the most important modalities (depending on the printers main market, e.g. CR/DR) of the OEM's will have been covered. In a later stage, more connectivity testing will take place depending on the specified requests. The most actual listing of verified modalities can be found in the Interface Status Report.

Appendix

B

.....

Quality Control Charts

Drystar 5300 Imager: Determination of Operating Levels

Imager Type: _____ Serial #: _____ Date _____

Film Type: _____ Emulsion #: _____

Densitometer (Internal or External)

If External: Type _____ Serial #: _____

Step 1: Print QC Test images on five consecutive days. Record the optical densities measurements in the tables below. After five days, average the values to determine the operating (aim) levels for each of the parameters.

	Day 1	Day 2	Day 3	Day 4	Day 5
Month					
Day					
Initials					

Base + Fog					
<i>Average of 5 Values = operating (aim) level <input type="checkbox"/> Base + Fog <input type="checkbox"/></i>					

Mid Density					
<i>Average of 5 Values = operating (aim) level "Mid Density"</i>					

Dens. Difference					
<i>Average of 5 Values = operating (aim) level <input type="checkbox"/> Density Difference <input type="checkbox"/></i>					

Dmax					
<i>Average of 5 Values = operating (aim) level <input type="checkbox"/> Dmax <input type="checkbox"/></i>					

Step 2: Copy the operating (aim) levels to Charts 2A/B ('Daily Density Control Chart')

Drystar 5300 Imager Daily Density Control Chart

Imager Type: _____ Serial #: _____ Film Type: _____ Emul #: _____

Densitometer (Internal or External) If External: Type _____ Serial #: _____

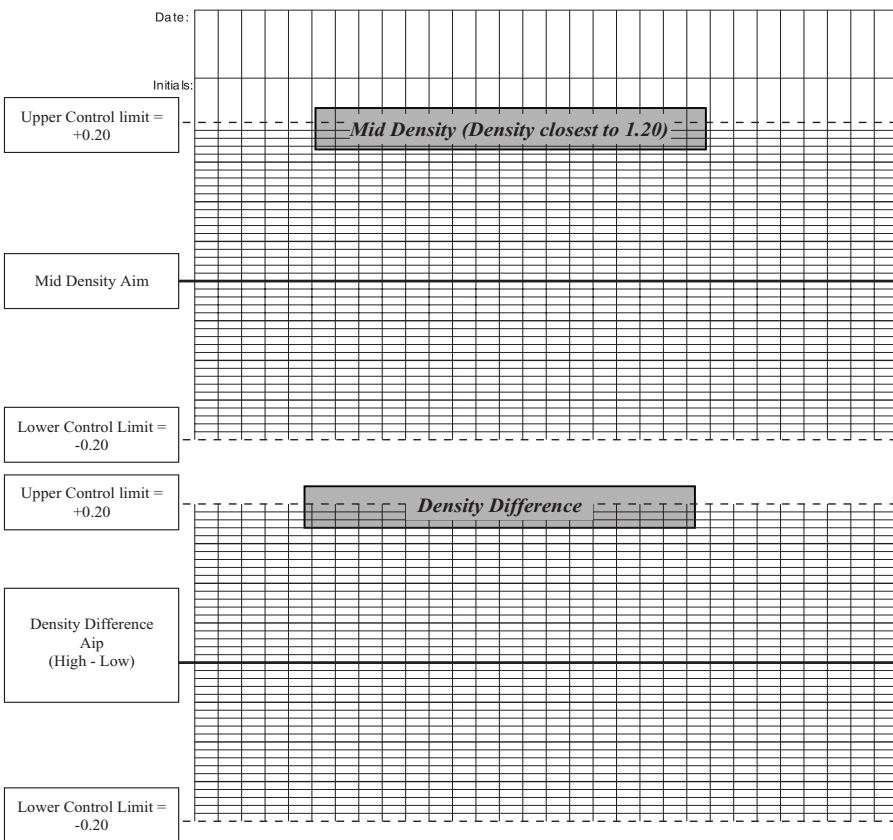

Drystar 5300 Imager Daily Density Control Chart

Imager Type: _____ Serial #: _____ Film Type: _____ Emul #: _____

Densitometer (Internal or External) If External: Type _____ Serial #: _____

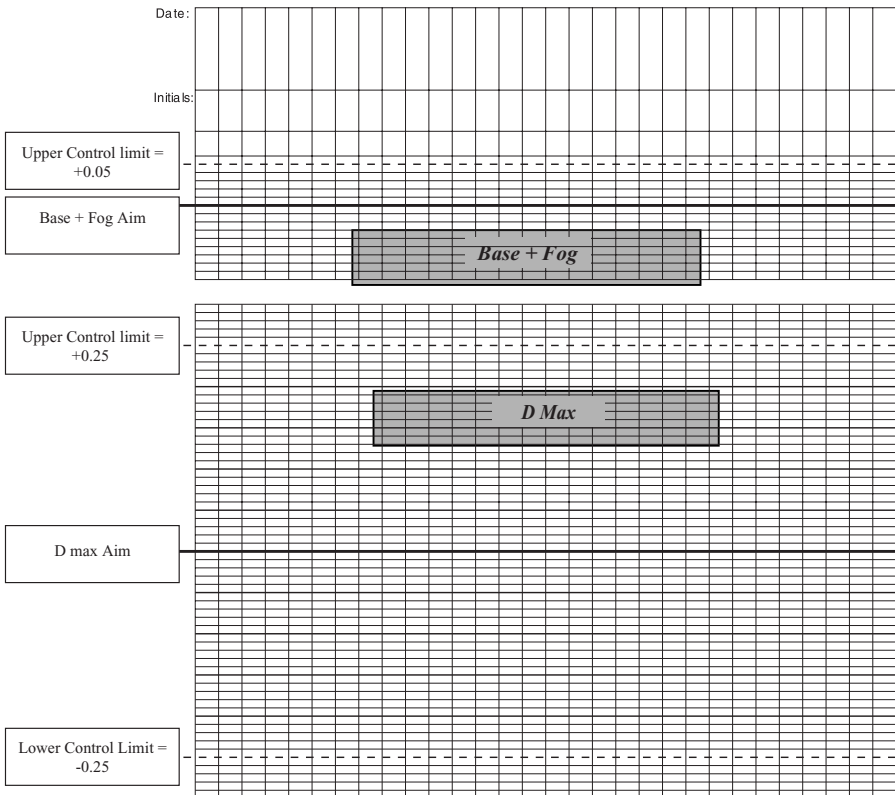

Drystar 5300 Imager Artifacts and Spatial Resolution Control Chart

Test Frequency: Weekly

Drystar 5300 Serial # _____

Initial Reference Test Date	
Initial Reference Artifacts	
Initial Reference Dot Visibility	

Month					
Day					
Artifacts					
Visibility of all Dots					

Month					
Day					
Artifacts					
Visibility of all Dots					

Month					
Day					
Artifacts					
Visibility of all Dots					

Month					
Day					
Artifacts					
Visibility of all Dots					

Month					
Day					
Artifacts					
Visibility of all Dots					

Drystar 5300 Imager Geometric Consistency Control Chart

Test Frequency: Annually or as required

Drystar 5300 Serial # _____

Reference Dimensions Date:		Measured Dimensions Date:		Consistency		Aspect Ratio	
A_{ref}		A:		A/A_{ref}		A/B	
B_{ref}		B:		B/B_{ref}			

Reference Dimensions Date:		Measured Dimensions Date:		Consistency		Aspect Ratio	
A_{ref}		A:		A/A_{ref}		A/B	
B_{ref}		B:		B/B_{ref}			



Printed in Belgium

Published by Agfa-Gevaert N.V., B-2640 Mortsel-Belgium

2921B EN 20031206

