



**Agrident GmbH, Steinklippenstr. 10, D-30890 Barsinghausen
Phone +49 5105 520614 - Fax +49 5105 520616**

ASR700 Reader Operation Manual

V29/05/07

© Copyright 2007 by Agrident GmbH

All rights reserved. No part of this publication may be reproduced, stored in a retrieval system, or transmitted, in any form or by any means, electronic, mechanical, photocopying, recording or otherwise, without prior written permission of Agrident GmbH.

Agrident GmbH reserves the right to make changes to any and all parts of this documentation without obligation to notify any person or entity of such changes.

May 2007 (BUS/JR)

Agrident GmbH
Steinklippenstr. 10
30890 Barsinghausen
Germany
Phone +49 (0) 51 05 520614
Fax +49 (0) 51 05 520616
E-Mail: mail@agrident.com
www.agrident.com

Contents

1. Introduction.....	6
1.1 Definition of terms	6
2. ASR700 Hardware	7
2.1 Application.....	7
2.1.1 Description	7
2.1.2 Contact less identification with RFID	7
2.1.3 Transponder types supported	7
2.2 Installing and connecting the ASR700 and antenna.....	8
2.2.1 Installing the housing	8
2.2.2 Fitting the antenna	9
2.2.3 Electrical connection	10
2.2.4 Auto tuning	16
2.3 Operation	24
2.3.1 Basic settings	24
2.3.2 First-time use of the ASR700 – an example.....	24
2.3.3 Read function	24
2.3.4 Displaying the read function.....	24
2.3.5 Output of the transponder data	25
2.3.6 Connecting the reader to a control computer	26
3. Operating modes.....	27
3.1 Operating in slave request mode (Cfg_mode register 0x02).....	27
3.2 Operating in slave continuous mode (Cfg_mode register 0x01).....	28
3.3 Operating in master mode (Cfg_mode register 0x00)	29
4. Configuration of the ASR700 reader	30
4.1 Factory configuration.....	30
4.2 Configuration possibilities.....	30
4.3 Description of the individual registers.....	31
4.3.1 Cfg_Delaytime.....	31
4.3.2 Cfg_Format	31
4.3.3 Cfg_Mode.....	32
4.3.4 Cfg_Node	32
4.3.5 Cfg_RF.....	32
4.3.6 Cfg_Timeout.....	32
4.3.7 Cfg_Optimisations.....	33

5.	Protocol description	34
5.1	Interface parameter	34
5.2	Frame	34
5.3	Control codes	34
5.4	Escape sequence	34
5.5	Addresses	34
5.5.1	Destination address DST	34
5.5.2	Source address SRC	34
5.5.3	Address ranges	34
5.5.4	Device type addresses	35
5.6	Message commands and acknowledgements	36
5.7	Description of the individual messages	37
5.7.1	Connect_RQ	37
5.7.2	Get_Amplitude	37
5.7.3	Get_Config	37
5.7.4	Get_HDX_Sample	37
5.7.5	Get_Last_ID	38
5.7.6	Get_Phase	38
5.7.7	Get_PhaseAmplitude	38
5.7.8	Get_RSSI	38
5.7.9	Get_Single_ID	39
5.7.10	Get_SNR	39
5.7.11	Get_TuningResult	39
5.7.12	Get_Tuning	40
5.7.13	Get_Version	40
5.7.14	Reset_All	40
5.7.15	Retransmit_Request	41
5.7.16	Save_Config	41
5.7.17	Set_Config	41
5.7.18	Set_TuningData	41
5.7.19	Start_AutoTuning	42
5.8	Description of the acknowledgements	42
5.8.1	ACK	42
5.8.2	NAK	42
5.9	ID-Format	42
5.9.1	Format of ID	42
5.9.2	ID-without time stamp	42

5.9.3	ID- with time stamp	43
5.9.4	Example ID- without time stamp Format ASCII	43
5.9.5	Example ID- without time stamp Format ASCII and SCP format.....	43
5.9.6	Example ID- without time stamp Format ASCII short format.....	43
5.9.7	Example ID- without time stamp Format ASCII short format 16.....	44
5.10	CRC Calculation.....	45
5.10.1	CRC-Algorithm	45
6.	Clock synchronisation of ASR 700 readers	46
6.1	Installation	46
6.2	Setting at the ASR700.....	46
7.	Technical data	48
8.	Influence of noise, Interference and metal objects on the reading range	49
8.1	Computer monitors.....	49
8.2	Other electronic equipment	49
8.3	Data cables	49
8.4	Mains cables	49
8.5	Fluorescent and Low Voltage Lighting	50
8.6	Other readers	50
8.7	Effects of metal near readers	50
9.	FCC digital device limitations	51
10.	CE MARKING	51
11.	Safety and care.....	51
12.	Warranty	52
13.	Appendix.....	53
13.1	RF synchronisation.....	53
13.2	Description of commands and acknowledgements	53
13.3	Description of the registers.....	54
13.4	Factory configuration.....	55
14.	Trouble shooting	56

1. Introduction

Before attempting to use the product for the first time read through the user manual carefully. The functional description of the ASR700 reader will help you make best use of the full capabilities of the system. The protocol description in chapter 5 provides you with all the information you need to integrate the reader into your own application software.

1.1 Definition of terms

Explanation of abbreviations used in this user manual

RF:	Radio Frequency (in this case the long-wave band)
RFID:	Radio Frequency Identification. Method to transmit data without contact using transponders.
Reader:	A device which is able to communicate with transponders using an internal or external antenna. The reader generates a high frequency field in order to get the data of a transponder. The received data is transmitted by an interface to an external controller (e.g. PC etc.).
Transponder:	Data carrier for RFID applications, available in various models and types.
Raw data:	Complete data contents of a transponder, which means ID and additional information (for example header or trailer).
ID:	Identification number of a transponder.
ISO 11784/85:	International standard regarding the use of RFID technology in the identification of animals; it defines the transponder types to be supported and the ID notation.
FDX:	Transponder type, which transmits its data while the HF field, is on (full duplex).
FDX-B:	FDX transponder with 128 bits of raw data, ID notation in compliance with ISO 11784/85.
HDX:	Transponder type, which transmits its data directly after HF field, goes off (half duplex). 104 bits of raw data, ID notation in compliance with ISO 11784/85.
Master mode:	Read mode in which the reader works as master. The reader makes field on and off permanently and transmits received transponder data automatically.
Slave request:	Read mode in which the field is normally off. The reader makes field on and off only after a request by the controller. If a transponder was read during activation time the ID is transmitted to the controller.
Slave continuous:	Read mode in which the reader makes field on and off permanently. The reader transmits received transponder data only after a request from an external controller.

2. ASR700 Hardware

2.1 Application

2.1.1 Description

The ASR700 is a stationary reader, which is used for contact less identification in combination with passive transponders. The hardware of the ASR700 reader is designed for noisy environments. With the on board signal processor it is possible to read transponders where other readers could not detect them (for example in slaughterhouses).

It has been developed for stationary use. Combined with one of our antennas it provides a flexible and universal RFID system.

Antennas with various dimensions and read ranges are available to closely match individual requirements.

The ASR700 reader is compatible with the ISO 11784/5 standard and can read HDX- or FDX-B compatible transponders. The transponders are registered within an extremely short time and over a wide detection area. Individual parameters of the read function can be configured.

It can be run using a computer, but application software is then required to drive the reader and to further process the transponder data supplied.

The message format of the transmitted transponder data is configurable. For description of the data protocol see chapter 5.

2.1.2 Contact less identification with RFID

How RF identification works.

The items to be identified are fitted with passive transponders, which contain the identification data. A reader is required for communication with the transponders. The reader generates a high frequency field using an antenna. This high frequency field activates each transponder, which is inside the reading range. The high frequency field is used for supplying the transponder with energy and for transmitting the transponder data to the reader. From the received data, the reader generates a data block (ID message). This ID message is sent out by an interface to a controller for further processing.

The reading range depends on the antenna and the environment.

The following things may influence the reading range (see also chapter 8):

- Mounting antenna on or near metal
- Noisy environment (for example electrical machines, screens etc.)
- Antenna mistuned (see chapter 2.2.4 auto tuning for details)

The demonstration software Asrdemo.exe includes tools for checking the tuning state of the antenna and the noise of the environment.

2.1.3 Transponder types supported

The ASR700 reader is compatible with the ISO 11784/5 standard and can read HDX- or FDX-B compatible transponders.

2.2 Installing and connecting the ASR700 and antenna

2.2.1 Installing the housing

A mounting hole is provided at each of the four corners of the bottom part of the housing to allow installation of the ASR700 reader. The holes are accessible after removal of the housing cover. Four suitable screws are needed to mount the unit at the place of installation. We recommend flat head screws.

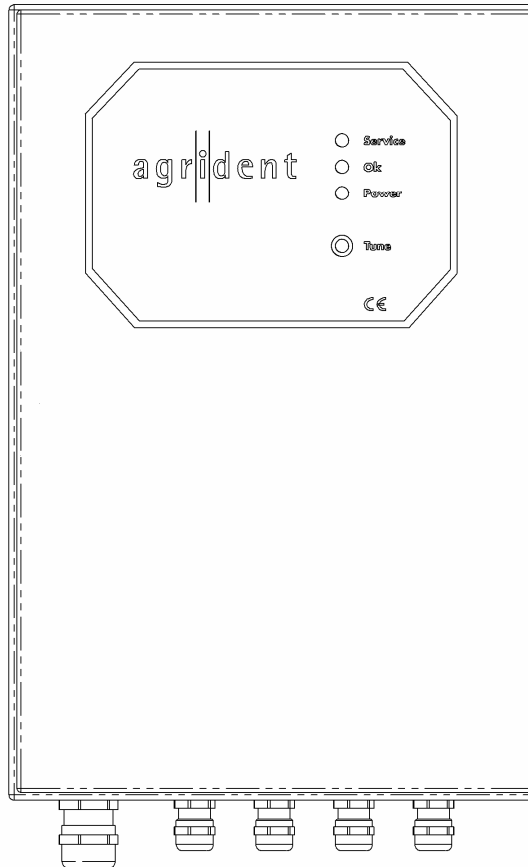

Figure 1: Installing the housing

2.2.2 Fitting the antenna

If at all possible the antenna should not be permanently exposed to direct sunlight; installing the device in an area sheltered from ultraviolet light will extend its service life.

Installing in the immediate vicinity of metallic objects may lead to detuning of the antenna. For this reason do not tune the antenna before the antenna has been installed. Avoid fitting to metallic surfaces since this may result in severe reduction of the reading distance.

To fasten the antenna to the base, use flat head screws with a thread diameter not greater than 5 mm as well as suitable washers. Do not use dish-head screws for this purpose as this could lead to the plastic frame being damaged.

The connecting cable to the reader should be fastened in place with cable clips or similar in such a way that the cable does not project and thus become a potential danger.

Important! For advice regarding choosing a suitable antenna, contact the ASR700 dealer. Under no circumstances is it permitted, for functional reasons or in connection with equipment approvals, to lengthen the cable of the antenna.

For information on tuning see chapter 2.2.4.

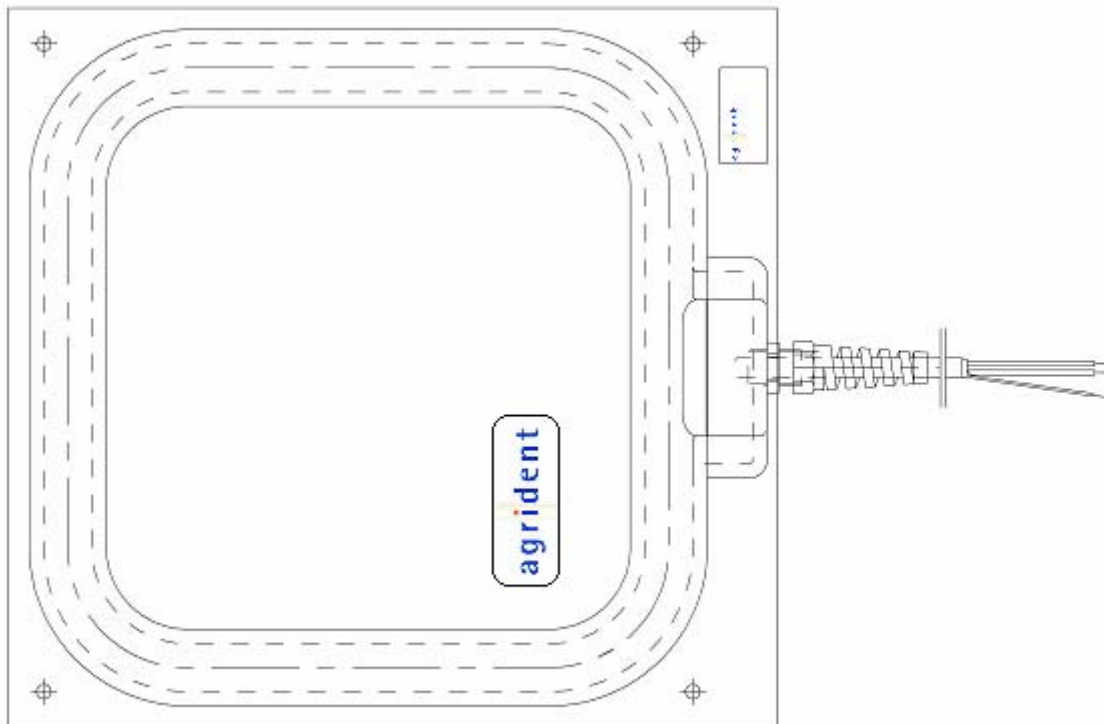

Figure 2: Antenna

2.2.3 Electrical connection

The electrical connections for the power supply, the communication interfaces with the controller (RS232 or RS485), and for connecting the antenna are made via terminal strips st2 and st7 on the printed circuit board.

The corresponding cables are routed through the watertight screwed conduit cable entries. We recommended that the interface cable be routed through the screwed conduit entry PG3, the power supply cable through PG4 and the antenna cable through PG5.

Connections for synchronization should be routed through PG1 and PG2.

Important! Please close the unused screwed conduit entries with the enclosed blind plugs. Please use only round cables, otherwise the protection class cannot be guaranteed. To ensure the water tightness thoroughly tightens the screwed conduit entries.

ST1	Additional tuning capacitors
ST2	Antenna
ST7	Power supply, communication interface and synchronization
ST4,ST5	LED's D1 (red) ,D2 (green) and D9 (yellow) and tuning switch
ST3,ST6,ST10,ST11,ST12,ST13	Reserved for internal use
ST8,ST9	Reserved for future use
LED1,2,3	Tuning indicators, power on (yellow) and good read (green)
LED22	Indicator for polyswitch
LED12,18,20,26,27,28,29,30	Reserved for service
J13	Master/Slave selection if synchronisation is needed
J14,15,16	Communication interface selection
Switch S1,S2	Reserved for internal use

Their function is described in the next sections.

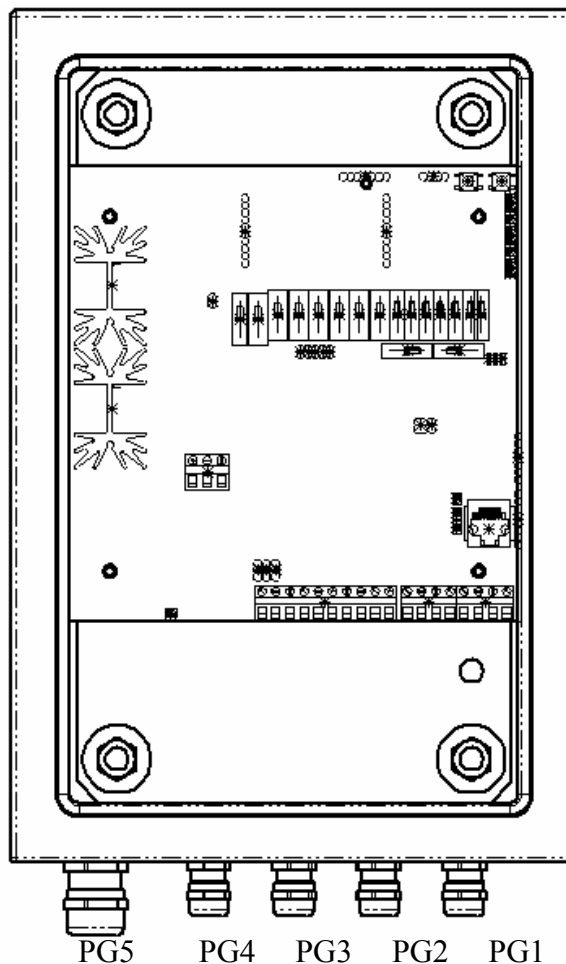

Communication interfaces

To select and activate the required communication interface the jumpers J4, J5 and J6 must be set as follows:

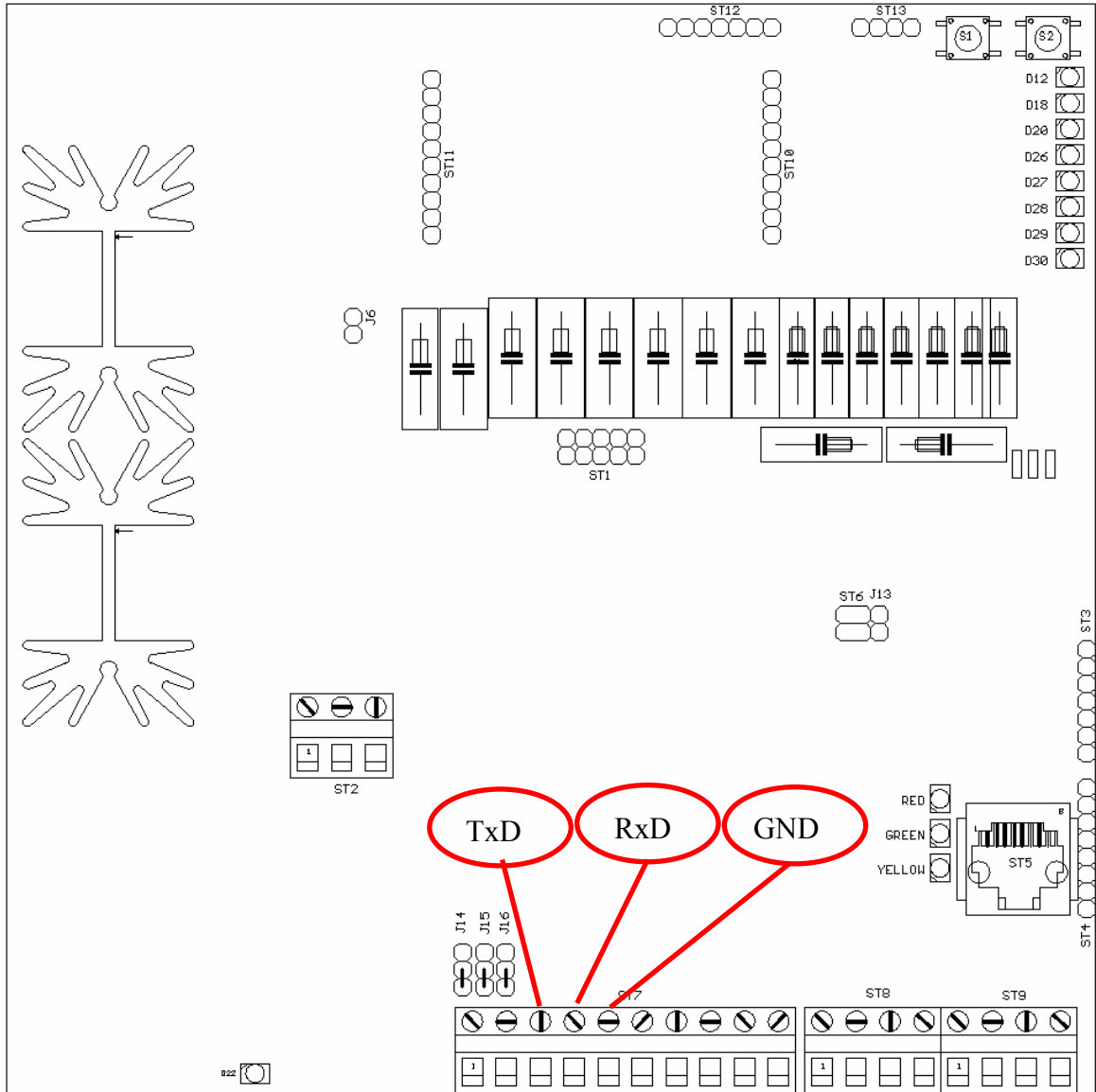

Figure 3: Jumper settings for RS232

Interface connection RS232		
Terminal block ST7	Meaning	J4 J5 J6
3	TxD	See Figure 3
4	RxD	
5	GND	

An RS232 interface needs three wires (TxD, RxD and GND)

- TxD: Where a device transmits data
- RxD: Where a device receives data
- GND: Ground

ASR700 Reader Operation



To use the RS232 interface, connect TxD of the PC to RxD of the ASR700/766, RxD of the PC to TxD of the ASR700/766 and both Ground signals.

ASR700/766 ST7	Connection	PC SUB-D 9 pole
Pin 3 TxD	_____	Pin 2 RxD
Pin 4 RxD	_____	Pin 3 TxD
Pin 5 GND	_____	Pin 5 GND

To detect TxD and RxD disconnect the data lines (TxD and RxD).
 Do Voltage measurement between Ground and one of the lines.
 The TxD line should be approximately -12V (could be less)
 The RxD line should be approximately 0V.

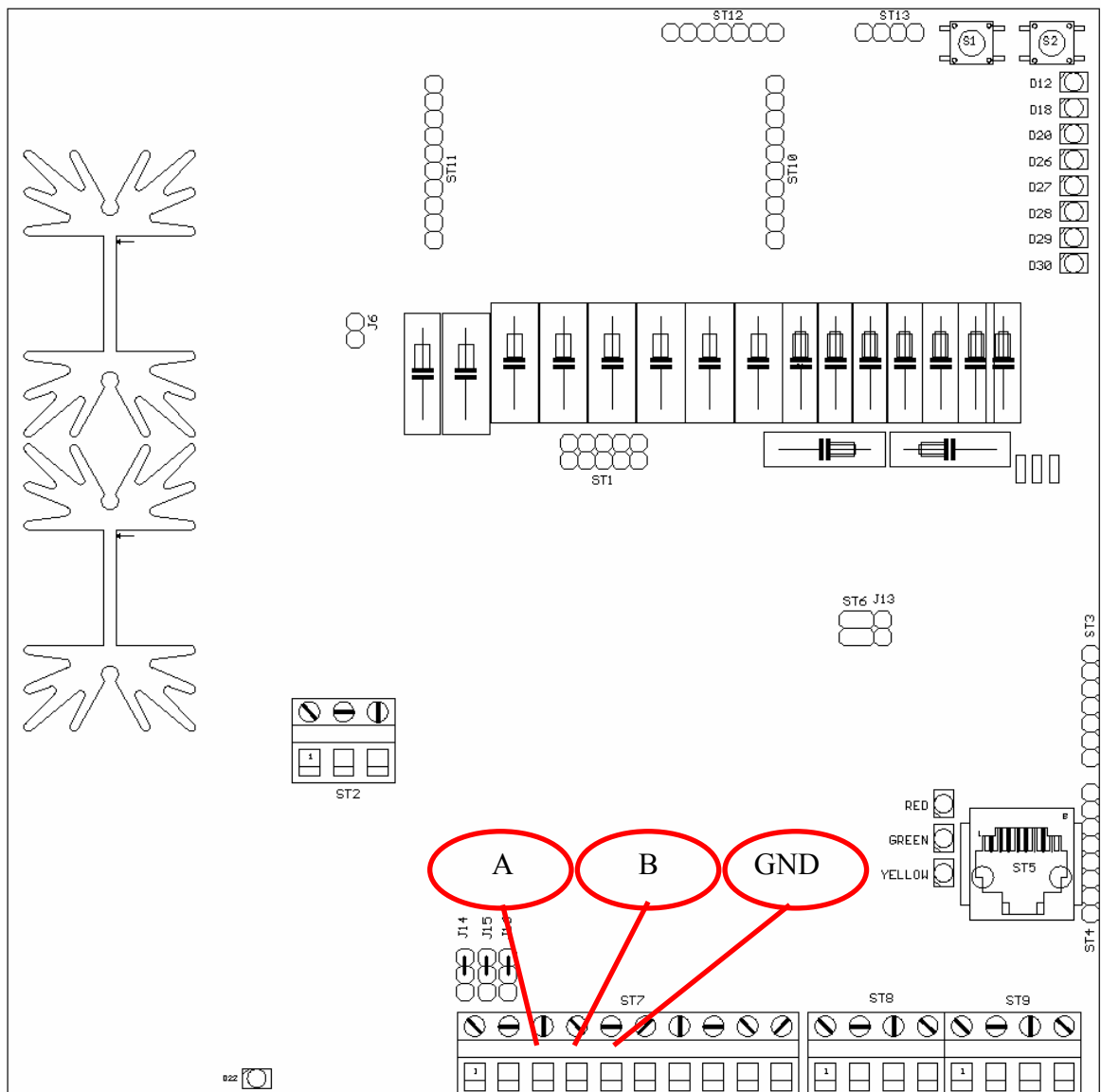

Figure 4: Jumper settings for RS485

Interface connection RS485		
Terminal block ST7	Meaning	J4 J5 J6
3	A / T+ / R+	See Figure 4
4	B / T- / R-	
5	GND	

Power supply

Connecting terminals 1 (+) and 2 (-) are available on terminal block ST4.

A linear regulated power supply of 13,8V is recommended (ripple must be smaller than 50mV). Maximum current is 1A. Typical current is 700mA.

Power supply	
Terminal block ST7	Meaning
1	Power supply +13,8V
2	Power supply -

After connecting the power supply to the ASR700, the yellow LED lights, indicating the ASR700 is ready for work. The green LED is on after a transponder was read. If the red LED is on, a tuning procedure for the antenna is necessary.

During the tuning process the LED's have different meanings (see chapter 2.2.4).

Important! The chassis ground (GND) of the reader must be connected to the protective conductor of the supply network.

If the antenna is integrated into a metal structure this structure should also be connected to the protective conductor of the supply network.

External signals and auto tuning

The following schematic figures show how to connect external LEDs and the auto-tuning switch.

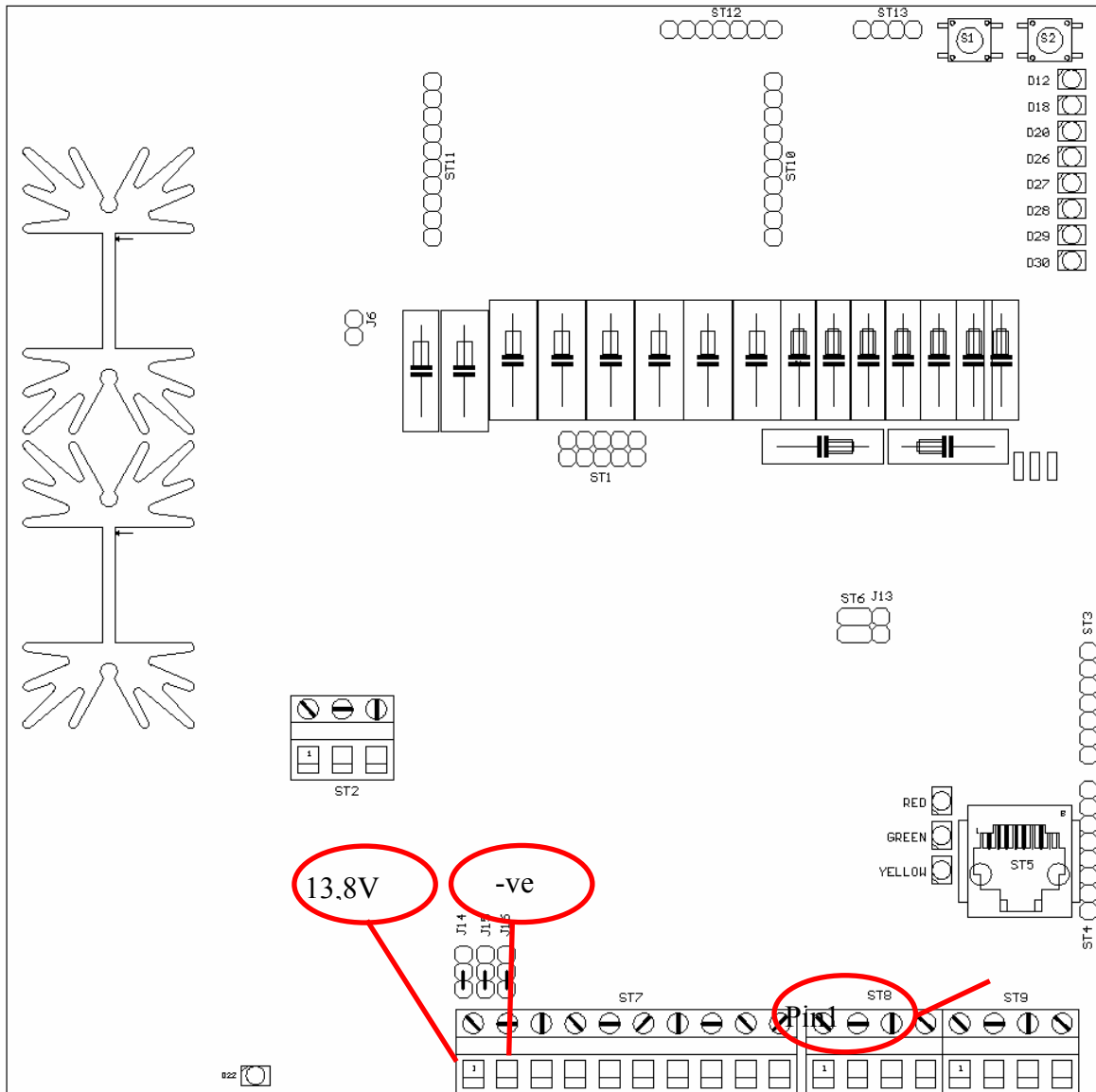

Figure 5: Connection diagram ASR700/766

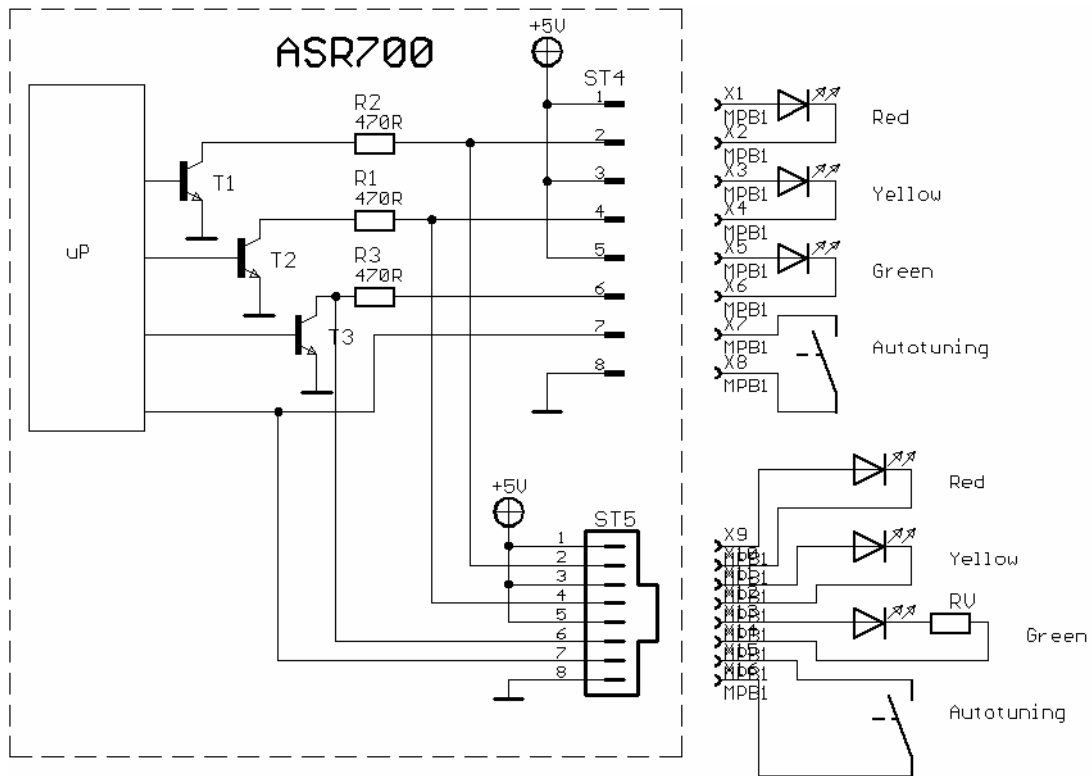

Figure 6: Connection diagram for LEDs and auto tuning switch

LEDs and auto tuning switch	
Terminal block ST4	Meaning
1	+5V
2	Output Red LED (open collector with R = 470Ω)
3	+5V
4	Output Yellow LED (open collector with R = 470Ω)
5	+5V
6	Output Green LED (open collector with R = 470Ω)
7	Input for auto tuning switch
8	GND

LEDs and auto tuning switch	
Terminal block ST5	Meaning
1	+5V
2	Output Red LED (open collector with R = 470Ω)
3	+5V
4	Output Yellow LED (open collector with R = 470Ω)
5	+5V
6	Output Green LED (open collector without R)
7	Input for auto tuning switch
8	GND

Important! If using terminal block ST5 (RJ45 connector), there is no built in resistor on the open collector output pin 6. An external resistor (RV) has to be connected.

Antennas

The antenna is connected to terminal block ST2

Antenna connection	
Terminal block ST2	Meaning
1	Antenna A1 (transparent white)
2	Antenna A2 (transparent pink)
3	Shield G

2.2.4 Auto tuning

Every individual antenna will have an inductivity, which deviates slightly from the reference value. Another important tuning criteria are the environment of the mounting place (metal near the antenna, temperature drift etc.).

The environment will influence the inductance and the Q factor of the antenna. For example metal near the antenna reduces the Q factor and the inductance of the antenna.

The inductivity of the externally connected antenna together with the capacitors on the board forms a resonant circuit. It should be tuned to the nominal frequency of 134 kHz.

To get the optimum reading range it's necessary to adapt the capacitor to the antenna.

To find the optimal tuning for each antenna and each environment, an auto tuning function is implemented in the ASR700.

Auto tuning means to automatically get the optimal tuning (which means the optimal reading range) for the combination of reader, antenna and environment.

If one of the parameters changes (for example the antenna is mounted in another place), a new auto tuning procedure has to be done, in order to adapt the reader antenna combination to the new environment.

Auto tuning is done by a few switch able capacitors on board the ASR700. The auto tuning works only in a certain area (fine tuning). If the maximum peak is outside this area, there are two additional capacitors which can be switch on or off by setting or removing the jumpers on ST1.

For to start the auto tuning function it's necessary to connect pin 7 and pin 8 of terminal block ST4 or ST5 or send an auto tuning command from the controller to the ASR700 (see chapter 5.7.19).

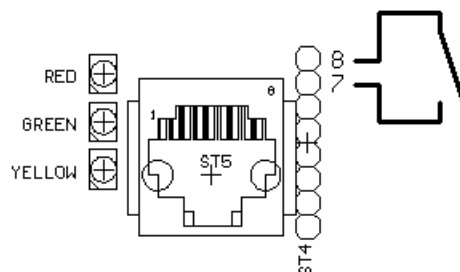

Activating the Tune button on the front of the reader starts auto tuning.

After starting the auto tuning the yellow LED and the red LED are on.

The reader now measures the voltage of the antenna for all capacitor combinations.

After measuring the tuning cycle is represented optically. All LED's switch off. The optical representation starts with the yellow LED, followed by the green LED and finishes with the red LED. Flashing of one or two of the LED's shows the final result of the auto tuning procedure:

Signalisation	Meaning
Red LED is flashing	Capacitance too low, set one of the jumpers on terminal block ST1 and repeat auto tuning
Red and green LED's are flashing	Capacitance a bit too low, set one of the jumpers on terminal block ST1 and repeat auto tuning
Green LED is flashing	Auto tuning successful
Yellow and green LED's are flashing	Capacitance a bit too high, remove one of the jumpers on terminal block ST1 and repeat auto tuning
Yellow LED is flashing	Capacitance too high, remove one of the jumpers on terminal block ST1 and repeat auto tuning

Table 1: LED meaning of auto tuning result

Important! Do not hold a transponder into the antenna field during the auto tuning process or during the request of tuning status.

The auto tuning procedure should be repeated until only the green LED is flashing. If necessary, remove or set one of the jumpers on terminal block ST1 (see Table 1). If it is not possible, the inductance of the antenna used might be too low or too high.

After auto tuning is finished, the yellow LED is on and the red LED is off. If the red LED is on, there were some changes in the environment (e.g.: temperature drift or metal is placed near the antenna etc.). In this case a new auto tuning procedure is recommended to get the optimum reading range.

Note: The red LED does not mean, that the reader is not able to read transponders. The red LED only means, that the combination of reader, antenna and environment is not optimally tuned.

The green LED represents the top of the tuning curve (see the following examples). The yellow LED represents the area left from the top of the tuning curve and the red LED represents the area right from the top of the tuning curve.

That means if the yellow LED is on for approximately the same time as the red LED, the top of the tuning curve is in the middle, which is optimal.

Example: Optimal tuning curve

In this example as a result only the green LED is flashing.
The time of the yellow LED is approximately the same time of the red LED.
Don't care about additional peaks.

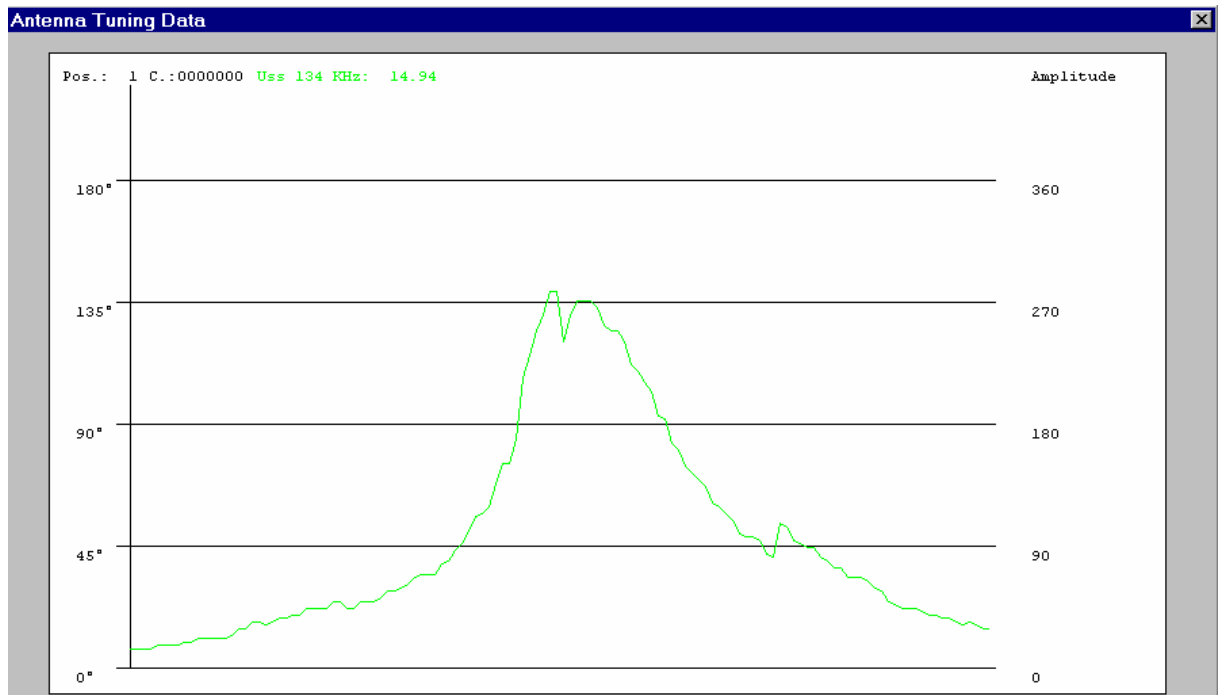

Figure 7: Example for optimal tuning curve

Example: Tuning curve ok

In this example as a result only the green LED is flashing.
The time of the yellow LED is longer then the time of the red LED, which means the top of the tuning curve, is on the right but still ok.

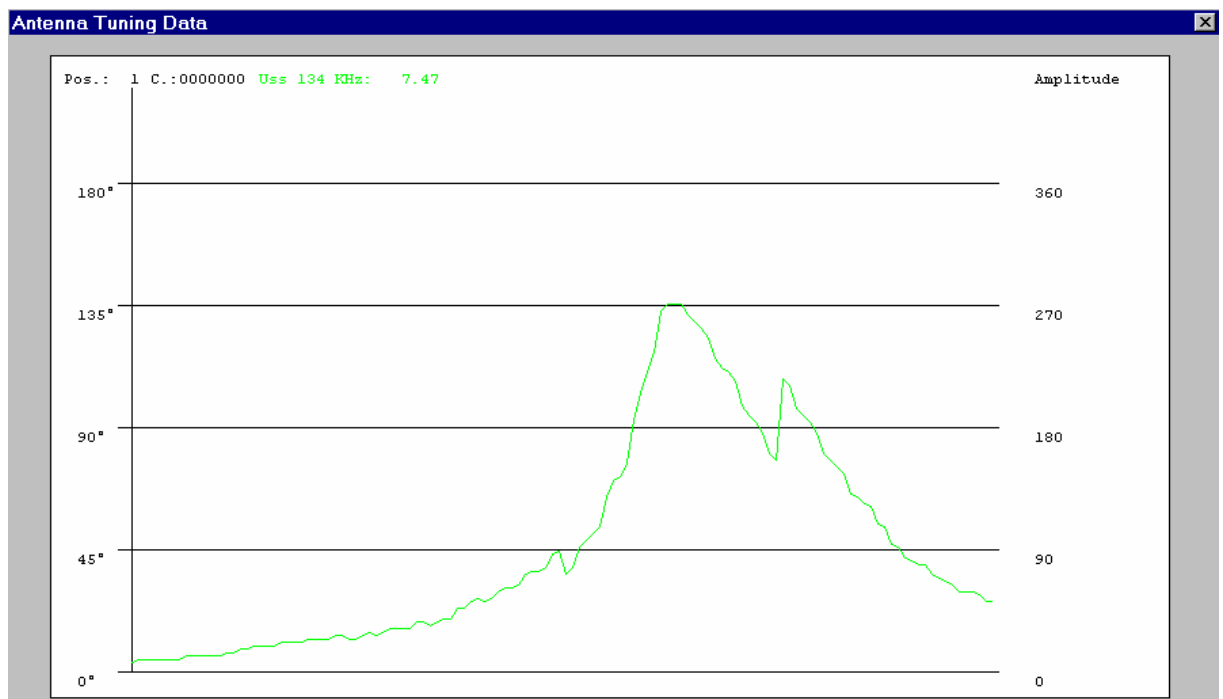

Figure 8: Example for tuning curve ok

Example: Top of tuning curve on right border

In this example as a result the green LED and the red LED are flashing.

The time of the yellow LED is much longer than the time of the red LED (the red LED might be not visible), that means the top of the tuning curve is on the right border. The cause of this problem is, that the inductance of the antenna is too low for the capacitor set which is used by the auto-tune function.

In this case it is recommended to set one of the jumpers on ST1 and repeat the auto tuning procedure.

If all are jumpers set, and the maximum is still on the right border, the inductance of the used antenna is on the lower limit for the reader. That means that changing's in the environment may reduce the inductance of the antenna, so the maximum is outside the right border.

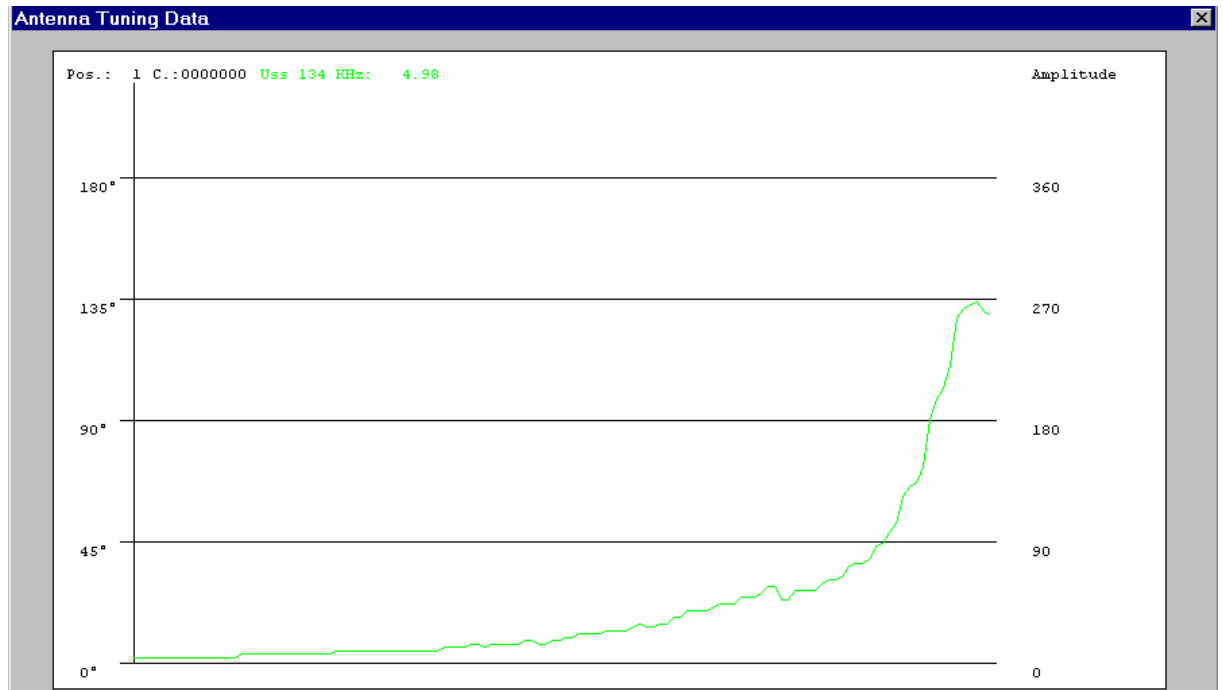

Figure 9: Example for top of tuning curve on right border

Example: Top of tuning curve outside the right border

In this example as a result the red LED is flashing.

The time of the yellow LED is much longer than the time of the red LED (the red LED might be not visible), that means the top of the tuning curve is outside of the right border

The cause of this problem is, that the inductance of the antenna is too low for the capacitor set which is used by the auto-tune function.

In this case it is recommended to set one of the jumpers on ST1 and repeat the auto tuning procedure.

If all jumpers are set, and the maximum is still outside the right border, the inductance of the used antenna is too low for the reader. That means with this antenna the full reading range could not be reached.

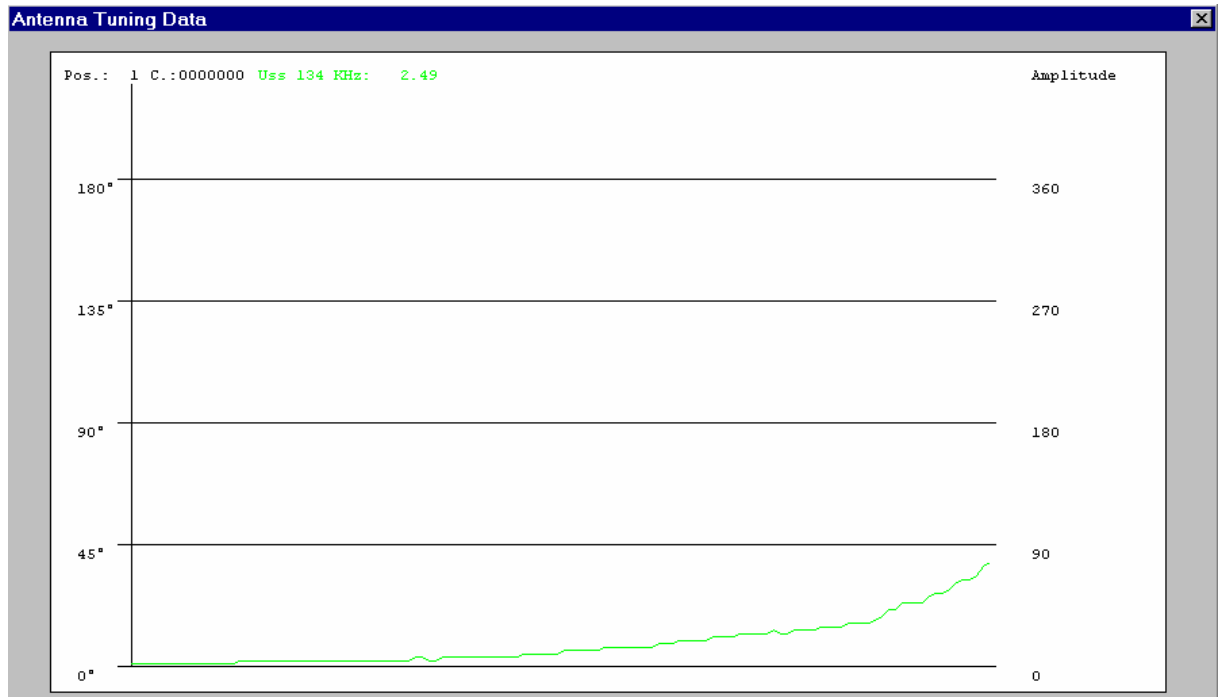

Figure 10: Example for top of tuning curve outside the right border

Example: Top of tuning curve on left border

In this example as a result the green LED and the yellow LED are flashing.

The time of the yellow LED is much shorter than the time of the red LED (the yellow LED might be not visible), that means the top of the tuning curve is on the left border.

The cause of this problem is, that the inductance of the antenna is too high for the capacitor set, which is used by the auto-tune function.

In this case it is recommended to remove one of the jumpers on ST1 and repeat the auto tuning procedure.

If all jumpers are removed, and the maximum is still on the left border, the inductance of the used antenna is on the higher limit for the reader. That means that changing's in the environment might increase the inductance of the antenna, so the maximum is outside the left border.

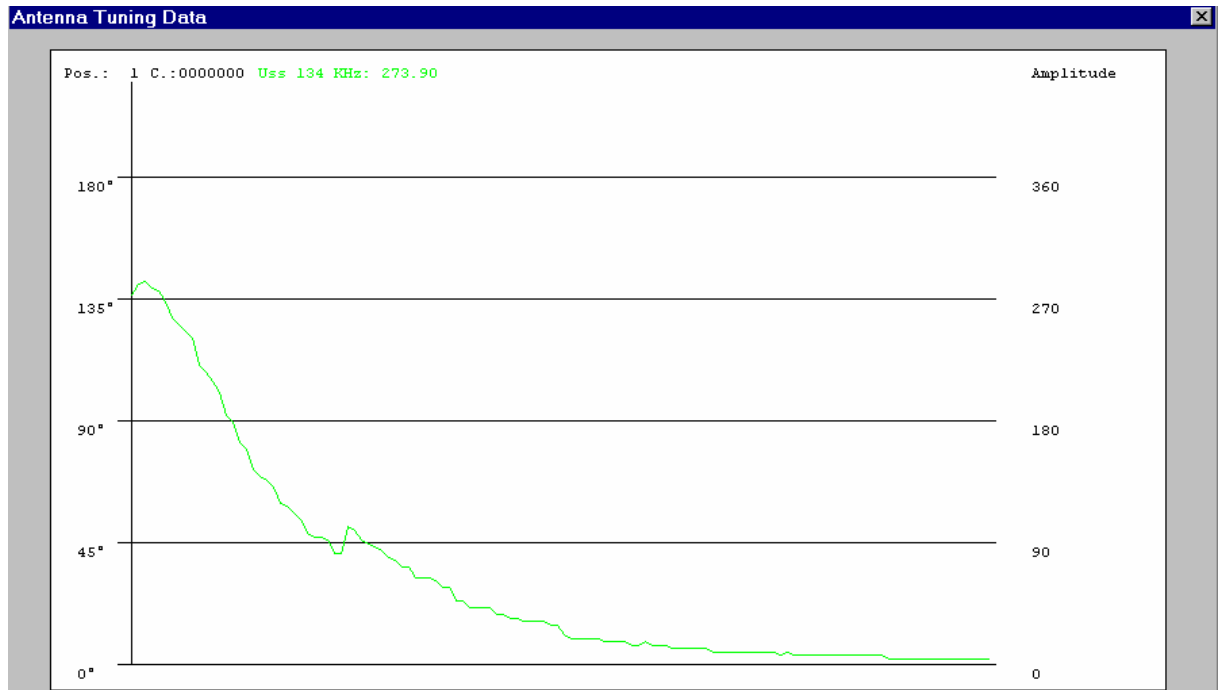

Figure 11: Example for top of tuning curve on left border

Example: Top of tuning curve outside the left border

In this example as a result the yellow LED is flashing.

The time of the yellow LED is much shorter than the time of the red LED (the yellow LED might be not visible), that means the top of the tuning curve is outside of the left border.

The cause of this problem is, that the inductance of the antenna is too high for the capacitor set, which is used by the auto-tune function.

In this case it is recommended to remove one of the jumpers on ST1 and repeat the auto tuning procedure.

If all jumpers are removed, and the maximum is still outside the left border, the inductance of the used antenna is too high for the reader. That means with this antenna the full reading range could not be reached.

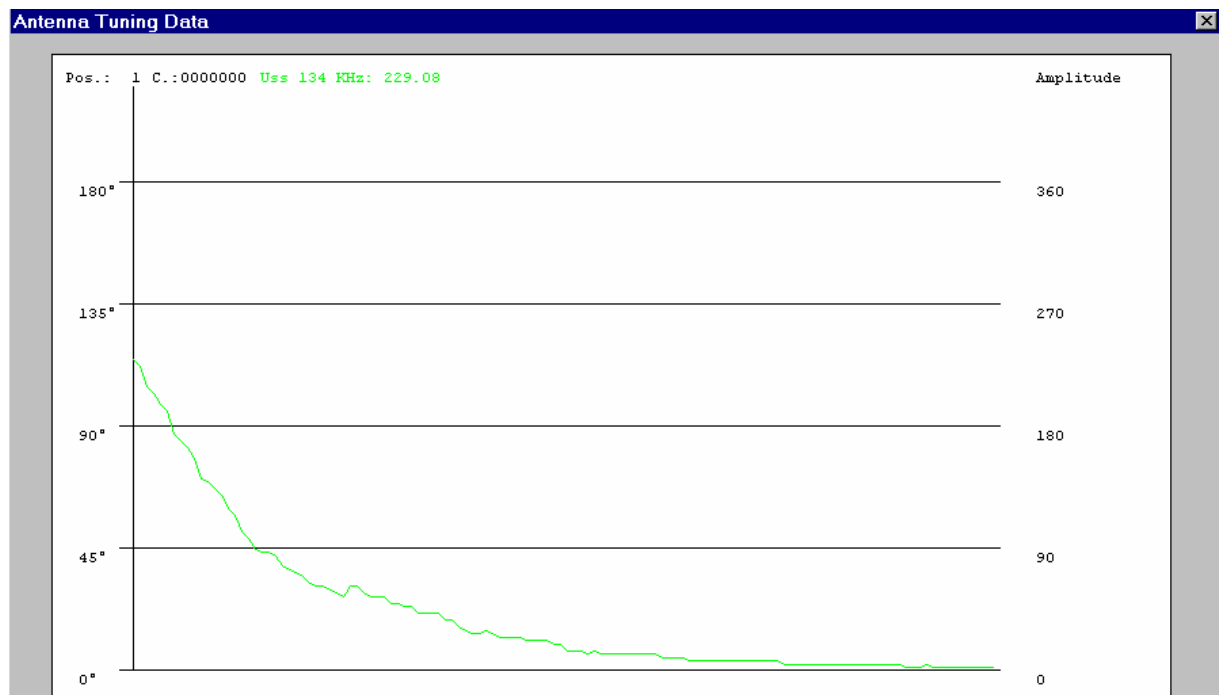

Figure 12: Example for top of tuning curve outside the left border

Auto tuning tools

All tuning curves are taken by using the auto tuning tools of the demo software Asrdemo.exe:

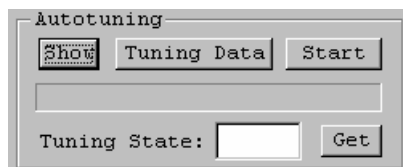

Figure 13: Auto tuning tool

For getting the tuning curve of an antenna, press "Tuning Data" and wait until the progress bar has finished. After the progress bar has finished, click on "Show". The dialog "Antenna Tuning Data" appears with the tuning curve of the antenna.

It's also possible to get the tuning state of the reader by pressing the "Get" button.

If the result is 0x00, the combination of reader, antenna and environment is optimal; otherwise (0xFE, 0xFF, 0x01 or 0x02) the combination of reader, antenna and environment is not optimal. For starting an auto tuning procedure, press "Start".

Saving and sending tuning data

It's possible to store the tuning curve in a file named "*.dat".

This can be done by pressing the "Save" button in the "Antenna Tuning Data" dialog.

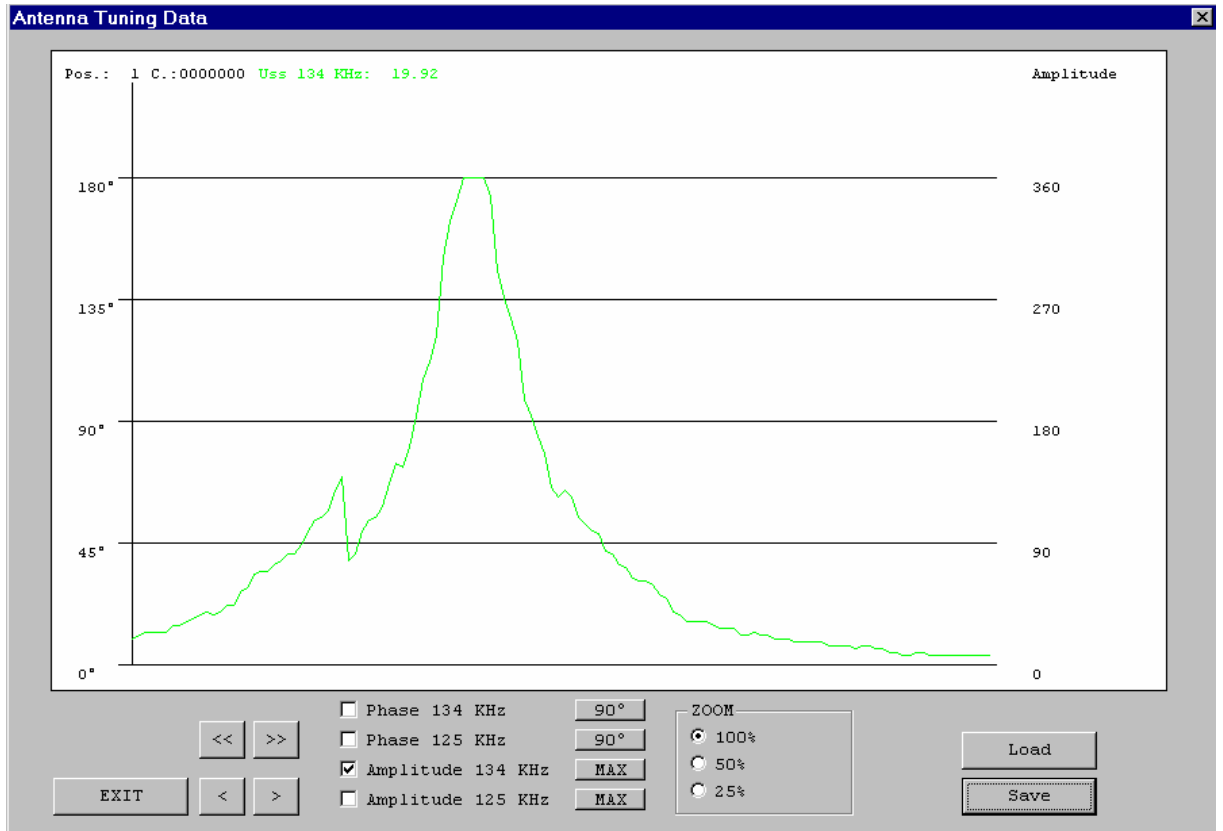

Figure 14: Example of tuning curve

2.3 Operation

2.3.1 Basic settings

The ASR700 reader comes preset with a factory configuration. Following installation of the reader and an antenna, and the reader has been tuned; the reader is ready for operation in combination with suitable application software.

2.3.2 First-time use of the ASR700 – an example

Requirements:

- The power supply is connected
- The RS232 interface is selected
- An antenna has been connected and tuned

Objective:

To set the so-called master mode. This is a read mode in which the RF field is permanently activated. As soon as a transponder is detected, an ID message is put out by the specified interface.

Start-up:

Once the RS232 interface has been connected to one of the serial interfaces of the computer (COM1, COM2,...), start the demo software *Asrdemo.exe* that should already be installed on the computer.

For more detailed information on *Asrdemo.exe* please refer to the corresponding manual.

2.3.3 Read function

Once the read function has been activated (different operating modes) a transponder brought into the detection area is quickly registered.

Note that the following factors may reduce the reading range:

- Alignment of the transponder to the antenna: the transponder axis (disk transponder: central axis standing vertically on the plane of the circular face; glass transponder: longitudinal axis corresponds to the central axis) is parallel to the antenna axis (corresponds to the central axis standing vertically on the antenna surface); the larger the angle between transponder and antenna axis, the shorter the range will be.
- Temperature range / environmental conditions: best results will be achieved within the temperature range approved for operation and the environmental conditions described in chapter 8.
- Installing the transponder on metal surfaces can have a negative effect on the read distance.
- Size of the transponder: the larger the transponder the larger the read distance with the same reader.
- Running multiple RFID systems simultaneously: these can be sources of interference for each other.

Important! Please note that there should be no more than one transponder of the same type in the detection area of the reader at any time since multiple transponders of the same type can under certain circumstances make reliable detection impossible. Also avoid the simultaneous presence of two different transponders in off mode (see chapter 1, register *Cfg_Format*) since this could lead to problems with processing the transponder data.

2.3.4 Displaying the read function

The ASR700 confirms when a transponder has been read successfully by giving a visual signal: the green LED (Read LED, see chapter 2.2.1) on the top of the housing lights up for a short time.

2.3.5 Output of the transponder data

The transponder data, which are read in by the ASR700, can be made sent in various data formats as ID messages to the communication interface.

The ID message data formats can be selected during configuration (for example: ASCII or binary) and this means that the user can have optimum integration into an application. For example the advantage of ASCII is its good legibility although displaying it requires a large number of characters; while binary means a short and effective display, but one, which is difficult to read.

The contents of the raw data and the ID message will vary according to the transponder type. The raw data is displayed as follows:

Transponder type	Raw data without checksum
HDX as per ISO 11784/85	13 bytes (104 bits, without 16 prebits / 8-bit header)
FDX-B as per ISO 11784/85	16 bytes (128 bits)

This raw data can now be output as follows:

Transponder type	HDX as per ISO 11784/85	FDX-B as per ISO 11784/85
ID message ASCII*	16 characters (decimal, as per ISO)	16 characters (decimal, as per ISO)
ID message Binary* (Compact coding)	8 bytes	8 bytes
ID message Transponder byte structure*	13 bytes	13 bytes
ID message Raw data*	13 bytes	16 bytes
ID message Short ASCII 15*	15 bytes	15 bytes
ID message Short ASCII 16*	16 bytes	16 bytes
ID message ASCII + SCP Format*	10 bytes	10 bytes

*For the complete frame structure see chapter 5.

2.3.6 Connecting the reader to a control computer

Point-to-point connection

This structure is particularly suited to applications with just a few (or even a single) readers. Each reader is connected to the control computer by its own interface. To reduce sensitivity to interference and to increase the possible length of the line, the RS485 interface can also be used instead of the RS232.

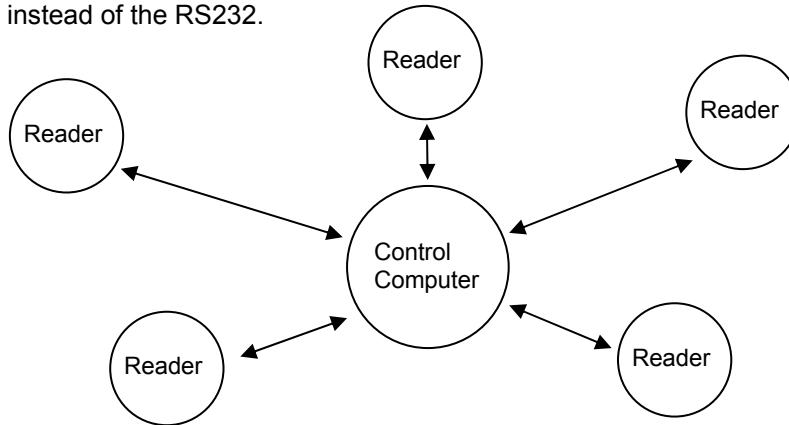

Each reader can be addressed by the control computer using suitable addresses (broadcast addresses, individually assigned network or device addresses) and by its own interface (for example, the COM port in PCs: Reader 1 = COM1, Reader 2 = COM2,...).

Single master bus system

This structure is particularly suited to applications with several readers (a maximum of 32 per control computer interface).

An RS485 bus interface is used as interface and this networks multiple readers with the control computer by a 2-wire bus. It allows a network to be set up at no great expense.

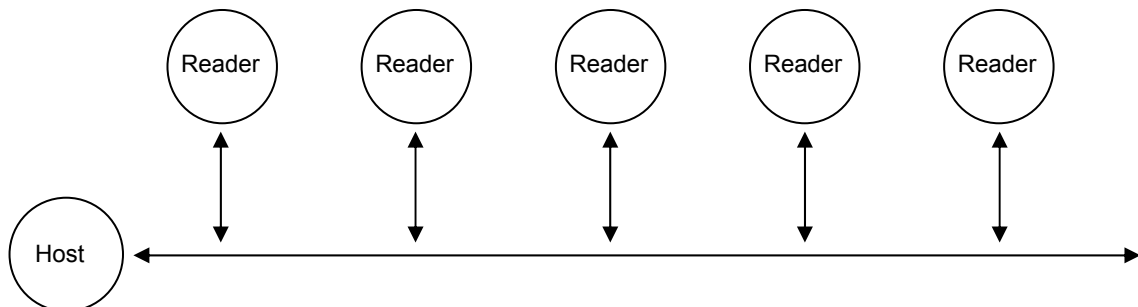

Each reader can be addressed by the control computer of the shared bus interface using the individually assigned network or equipment address. This can be, for example, by an RS232/RS485 converter at a COM port of a PC.

In order to organize access to the bus the control computer is declared sole master (single master network). Each reader connected to the bus must have its own individual network address.

Before installing a reader in a bus structure, the reader must be assigned as a yet unassigned network address by point-to-point connection. Configuration of the network address is effected using, for example, the ASR700 demo software.

3. Operating modes

The ASR700 supports three operating modes, which can be configured.

If changing the operation mode, the reader will not accept a mode change command until it has finished processing/transmitting a response, (see chapter 5) any command it has already received. Using bus systems (see chapter 2.3.6) avoid changing from slave modes (see chapter 3.1, 3.2) into master mode (see chapter 3.3) since this could result in data collisions on the lines.

The data buffers are cleared when there is a change of operating mode.

3.1 Operating in slave request mode (Cfg_mode register 0x02)

In slave request mode the read function is not activated until reception of a command ('Get_Single_ID'; for description see chapter 5.7.9) - in other words a request. The user software on the control computer can look after controlling the read function. The ID message of an acquired transponder is transmitted once in the appropriate format at the interface. After the detection of a transponder and the transmission of the ID message – or after a timeout has elapsed – the read function terminates. If a transponder is not detected before the timeout elapses a blank ID message will be transmitted. Switching the RF field on and off is handled automatically by the ASR700.

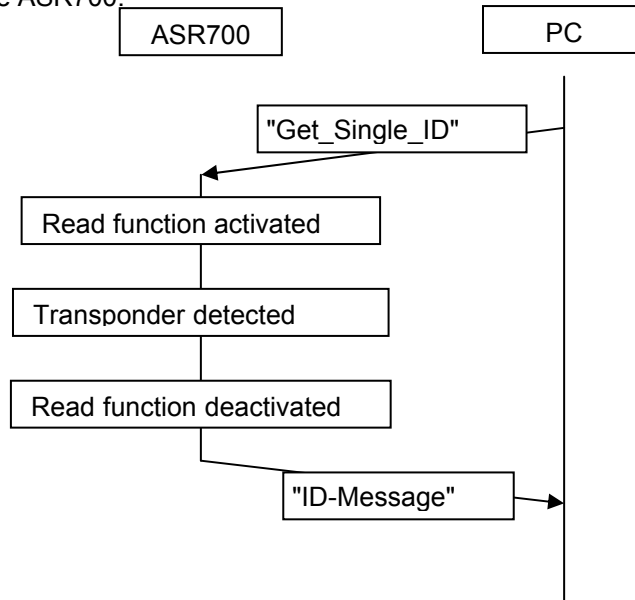

A fresh transmission of the 'Get_Single_ID' command causes the read procedure to be repeated.

When 'Get_Last_ID' is transmitted (see chapter 5.7.5) a new read cycle is not started but instead the last registered transponder ID is transmitted.

In this mode the interface protocol is bi-directional. The control computer here functions as a command transmitter and the reader as the responding partner. The receiver confirms commands.

Note: In the case of a bus set-up using RS485 connection, data collision is possible on the bus if several readers are addressed simultaneously with 'Get_Single_ID' or 'Get_Last_ID'.

Possible applications

Point-to-point connection with RS232/RS485: only one reader is connected by computer serial interface.

Bus system with RS485: several readers are connected to a computer, configured with different network addresses and are interrogated in sequence by the computer; for example,

'Get_Single_ID' to reader 1, reply from reader 1, 'Get_Single_ID' to reader 2, reply from reader 2, and so on.

3.2 Operating in slave continuous mode (Cfg_mode register 0x01)

In slave continuous mode the read function or the RF field is continuously activated. It autonomously detects a transponder, which is present and sends the transponder data to an internal ring buffer memory (two IDs in size). Repeated addition of the same ID entry to the buffer can be blocked with the aid of the configurable 'Delay time'. Every time an ID is added to the buffer the 'Delay time' is restarted. The contents of the buffer can be read out (output of the oldest ID) by the control computer with the command 'Get_Last_ID'. The response comes after max. 120 ms. If the buffer memory is empty a blank ID message will be transmitted. Repetition of the command is a way of emptying the buffer.

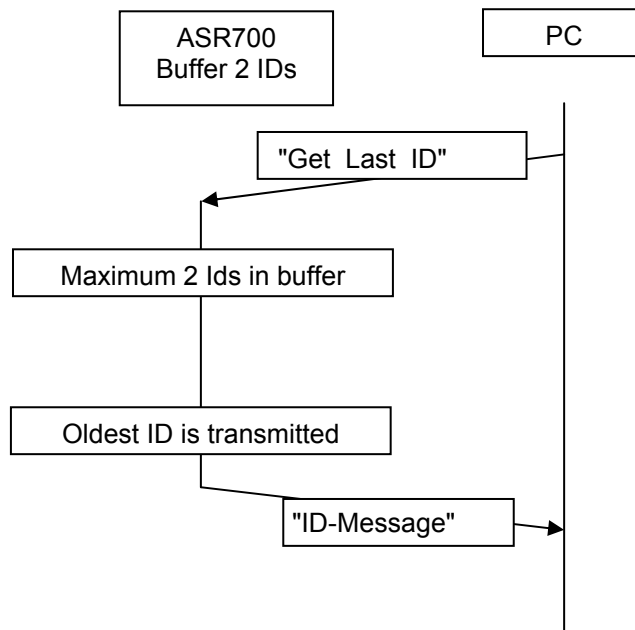

Interrogation by 'Get_Single_ID' starts a new read cycle.
 After a request with 'Get_Single_ID', if a transponder is detected within the configured time-out period, the ID will be transmitted (a blank ID in the case of failure to pick up a transponder).

Note: In the case of a bus set-up using RS485 connection, data collision is possible on the bus if several readers are addressed simultaneously with 'Get_Single_ID' or 'Get_Last_ID'.

Possible applications

Point-to-point connection with RS232/RS485: only one reader is connected by computer serial interface.

Bus system with RS485: several readers are connected to a computer, configured with different network addresses and are interrogated in sequence by the computer; for example, 'Get_Last_ID' to reader 1, reply from reader 1, 'Get_Last_ID' to reader 2, reply from reader 2, and so on.

3.3 Operating in master mode (Cfg_mode register 0x00)

In master mode the read function or the RF field is continuously activated. After a transponder was detected, its transponder data are transmitted as ID message at the serial interface. Before transmitting, the transponder data are prepared in compliance with the chosen output format. Repeated output of the same ID can be configured with the 'Cfg_Delaytime' register.

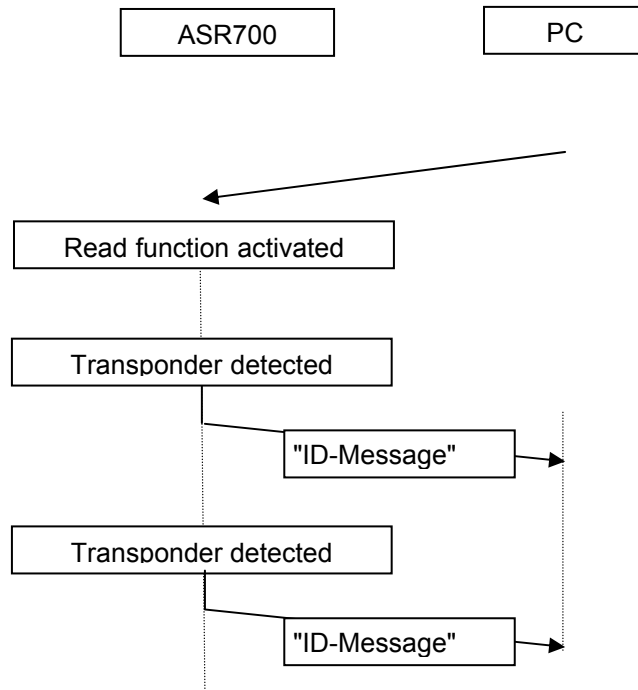

Communication is unidirectional from the reader to the control computer; no response is required. The complete protocol (see chapter 5) of the reader doesn't need to be implemented in the user software if only master mode is used.

It only makes sense to use master mode in conjunction with point-to-point communication (see chapter 2.3.6) since data collisions at the bus interface could result.

Possible applications

Point-to-point connection with RS232/RS485: only one reader is connected by computer serial interface.

4. Configuration of the ASR700 reader

For information on programming the configuration described below, please refer to the corresponding parts of chapter 5.

Note on notation of addresses, data and commands:

Single quotation marks designate ASCII values, for example '0' (zero).

If a date is preceded by the designation '0x', this indicates that the date is in hexadecimal notation; for example, 0x30 (hex notation of the ASCII zero).

Binary data are shown as bit patterns consisting of '0' and '1'; for example, 00110000 (binary notation of the ASCII zero).

4.1 Factory configuration

The ASR700 reader comes preset with a factory configuration.

Parameter	Setting
Mode (Cfg_Mode*)	Slave request mode (0x02)
Data output format (Cfg_Format*)	ASCII output of the ID (0x02)
Transponder types (Cfg_RF*)	All transponder types (0x0E)
Time out (Cfg_Timeout*)	100ms (0x01)
Delay time (Cfg_Delaytime*)	50ms (0x01)
Network address (Cfg_Node*)	0x01
Interface (fixed)	9600 Baud, 1 Start bit, 8 Data bits, No Parity, 1 Stop bit

*For register details see the following chapters

4.2 Configuration possibilities

The ASR700 reader can be configured on the application-specific basis by means of configuration commands. Here special registers – listed in the following table – are addressed.

Register	Cfg_Adr	Bits to set	Hex value of Settings	Significance of the registers or their configuration
Cfg_Delay time	0x35		0x01*	Time interval for repeated ID message. Repetition blockage for time 't' of an already transmitted/saved ID message: Time 't' = register value * approx. 50 ms (0x00 results in no repetition)
Cfg_Format	0x32		0x01*	Format of the ID message
		0	0x01	ASCII notation
		1	0x02	Transponder byte structure
		0,1	0x03	Compact coding
		1,2	0x06	Output of raw data without CRC
		0,1,2	0x07	ASCII short format 15
		0,1,2,4	0x17	ASCII short format 15
	5**	0x20	Use SCP format	
Cfg_Mode	0x31		0x00*	Operation mode
			0x01	Slave continuous mode
			0x02	Slave request mode
			0x00	Master mode
Cfg_Node	0x36		0x01*	Individual network address of a reader; range of values: 0x00 to 0xEF, except 0x02,0x03,0x10
Cfg_RF	0x33		0x0E*	Configuration of the RF interface
		1	0x02	FDX-B reception activated
		2	0x04	HDX reception activated
		1,2	0x06	FDX-B and HDX activated
Cfg_Time-out	0x34		0x01*	Time in which the field is active. After the time-out period the field activated with Get_single_ID is switched off unless a transponder is detected within the time interval (after this the field

Register	Cfg_Adr	Bits to set	Hex value of Settings	Significance of the registers or their configuration
				is switched off immediately); Time = register value x approx. 100 ms (Value 0x00 also yields approx. 100 ms)

* Default values specified.

** Combinations with other mentioned bit combinations for Cfg_Format are possible.

Note: Configuration of bits not described above will not be accepted and this results in the response 'NAK'.

Following a 'Save_Cfg' command the configuration data are saved in the EEPROM where they will be retained even in the absence of the power supply.

Important! If no 'Save_Cfg' command is given the new configuration data will be lost when the power supply is switched off and will have to be redone after switching on again.

4.3 Description of the individual registers

4.3.1 Cfg_Delaytime

The repeat rate of the ID message of the same transponder can be defined by using the configuration register Cfg_Delaytime. It can be set to any interval between 50ms and approximately 13 seconds.

If Cfg_Delaytime is set to 0x00, the transponder ID will be transmitted only once on serial interface until another transponder has been read.

If the transponder is read again after this time (Delay time), in master mode the ID will be output once more at the serial interface, independent of how often it is detected within the time interval. In slave continuous mode, renewed addition to the internal buffer will not take place until the delay time has elapsed, independent of how often it is detected within the time interval. In slave request mode the delay time is ignored.

4.3.2 Cfg_Format

ID message:

The configuration register Cfg_Format is used for setting the output format of the transponder ID. The transponder data decoded as per ISO 11784 can be displayed in ASCII format directly on simple output terminals. For special application three further ASCII formats are available which are transmitted without any checksum. CR LF finishes them. With the raw data format however the complete transponder data, including control and back-up data, are provided with CRC or parity check components. In addition, intermediate steps during data conversion can also be selected, such as the 'transponder byte structure' or the binary notation for transponder data decoded as specified in ISO 11784. For a detailed description of ID message, see chapter 5.9.

In slave request mode an ID is always output only at the moment of detection, not at the time when the transponder leaves the detection area.

4.3.3 Cfg_Mode

Configuration register Cfg_Mode defines the operating mode.

Operating Mode	Register Value	Data output by command from host	RF field
Slave request Mode	0x02	'Get_Single_ID' New ID* is send to host 'Get_Last_ID' The ID* last registered is sent to the host	Is switched on only by command 'Get_Single_ID' and switched off after time-out or transponder detection
Slave continuous mode	0x01	'Get_Last_ID' Oldest ID* is sent to the host 'Get_Single_ID' New ID* is send to host	Is activated at all times
Master mode	0x00	Reader transmit autonomously with valid new ID 'Get_Single_ID' New ID* is send to host 'Get_Last_ID' The ID* last registered is sent to the host	Is activated at all times

*ID can mean either a blank ID or a read transponder number

4.3.4 Cfg_Node

If the reader is used in a network with several readers, it is possible to give the reader an individual network address by using the Cfg_Node register.

4.3.5 Cfg_RF

In applications where for example only one transponder type is used, the configuration register Cfg_RF can be used to hide other types supported by the reader (FDX-B, HDX) and thus speed up acquisition.

4.3.6 Cfg_Timeout

The switch off time of the RF field for a single read cycle in slave request mode can be defined with the configuration register Cfg_Timeout. Once the time-out period has elapsed and no transponder has been registered, the read cycle is terminated and a blank ID sent to the control computer.

The configuration data stored in the EEPROM become effective at switch-on. The command 'Set_Config' causes the configuration to be changed temporarily in RAM. With the 'Save_Config' command the modified configuration data are saved in the EEPROM where they remain, even when the power supply is off.

The default values can be restored with the 'Reset_All' command.

Important! Following 'Reset_All' the host program must be able to communicate with the default values (network address: 0x01)

Note: If a 'Set_Config' command accesses an undefined register, 'NAK' will be returned.

The reader can be configured and individual functions demonstrated with the Asrdemo.exe demo program, which is supplied as standard. This program has its own user manual.

4.3.7 Cfg_Optimisations

The ASR700 reader is optimised for noise reduction. In most applications there is no need to change the optimisations.

Optimised for noise reduction means that a certain time is need to calculate out parts of the noise. This time might be to long for some applications (e.g. pass troughs, gates or raceways) For this reason three optimisations for the reading speed are possible.

The ASR700 is delivered with optimisation High noise setting (see below).

The used optimisation for the application is depending on the size of the antenna, the speed of the transponder and the noise of the environment.

Four optimisations are available at software version 3.16:

- **High noise setting**
 In this time step the ASR700 reader works with longest possible reading cycles (in compliance with ISO 11784/85), to offer a maximum of noise reduction.
 It is recommended to use this time step mode in noisy environments (e.g. in a slaughterhouse).
 This is the default time step mode of the ASR700.
- **High speed setting**
 In this time step the ASR700 reader works with shortest possible reading cycles (in compliance with ISO 11784/85), to offer a high reading speed but may be with minor noise reduction (depending on the speed of the transponder).
 It is recommended to use this time step mode in noiseless environments, were high reading speed is necessary (e.g. on trucks, pass troughs, gates or raceways).
- **Median setting**
 This time step is a compromise between Low speed time step and Fast speed time step. It offers a higher reading speed than Low speed operating mode and more noise reduction than High speed operating mode.
- **Variable timing**
 This time step combines high reading speed with noise reduction. If no transponder is in the field, the reader operates with shortest possible reading cycles (in compliance with ISO 11784/85). If a transponder signal is detected, the reading cycle will be stretched if necessary (in compliance with ISO 11784/85). Noise reduction is less than with High noise setting, because of the variable timing.

Register	Cfg_Adr	Bits to set	Hex value of Settings	Significance of the registers or their configuration
Cfg_Optimisations	0x39		0x00*	Optimisations
			0x00	High noise setting
		1	0x01	High speed setting
		2	0x02	Median setting
		1,2	0x03	Variable timing setting

* Default values specified.

Send 'Save_Cfg' command after configuration of Cfg_Optimisations, otherwise the new configuration data will be lost when the power supply is switched off and will have to be redone after switching on again.

5. Protocol description

5.1 Interface parameter

9600 Baud
 1 Start bit
 8 Data bits
 No Parity
 1 Stop bit

5.2 Frame

STX	DST	SRC	Message	CRC	ETX
0x02	0xFF	0xF0	n Bytes Data	8 Bit CRC	0x03

STX Start of a frame
 DST Destination address (Example Broadcast).
 SRC Source address (Example 0xF0 = HOST address)
 Message n Byte Data (see also ID-Output in section 1.6)
 CRC 8 Bit CRC concerning CCITT ($x^8+x^4+x^3+x^2+1$)
 ETX End of frame

5.3 Control codes

Name	Value	Description
STX	0x02	Start of frame
ETX	0x03	End of frame
DLE	0x10	ESCAPE: the control code after the ESCAPE character will be interpreted as data and not as control code

5.4 Escape sequence

If in a data frame a character or codes is equivalent a control code it will be replaced by:

Sequence	Replace
DLE-STX	STX
DLE-ETX	ETX
DLE-DLE	DLE

In the frame of the ASR700 a CRC comes always behind a DLE!

5.5 Addresses

5.5.1 Destination address DST

The destination address denotes the receiver of a message frame. There are individual addresses and broadcast addresses available. The broadcast address is useful to send a message to several readers at the same time or to communicate with a reader where the individual address is not known.

5.5.2 Source address SRC

The destination address denotes the transmitter of a message frame.

The ASR responds with its individual network address, independent if the request was a broadcast request or not.

5.5.3 Address ranges

A broadcast address allows each and every reader to be addressed irrespective of the device type or individual address. Avoid broadcast addresses on bus systems because of the possible data collision during the response. If the individual address of the reader is unknown use a point-to-point connection and configure the individual network address with a broadcast request (Set_Config) or get the individual network address (Get_Config).

Each reader type has an individual device specific address.

Therefore, on a bus system with different device types it is possible to address them by using the device type address.

In point-to-point connection all address types can be used without restriction.

In bus systems it's recommended to use an individual network address for each reader.

The 8-bit address field allows 256 addresses.

The control characters (STX, ETX and DLE) are not allowed.

The valid addresses are shown in the following table:

Address	Description
0x00	Reserved for future address expansion
0x01	Default address as shipped
0x04...0x0F	Network addresses (device addresses)
0x11...0xEF	Network addresses (device addresses)
0xF0	Computer address (host address)
0xF1...0xFE	Fixed device type addresses
0xFF	Broadcast address

5.5.4 Device type addresses

Device type address	Description
0xF1...0xF2	Reserved
0xF3	Mobile reader
0xF4	ASR reader (stationary reader)
0xF5...0xFE	Reserved

5.6 Message commands and acknowledgements

The reader supports the following commands

Command / Request	Cod. Hex	Addnl. Data	Description
Connect_RQ	0x01	-	Interrogate connection status
Get_Amplitude	0x83	-	Output the amplitude of the antenna
Get_Config	0x29	Address	Output the current configuration
Get_HDX_Sample	0x91	-	Output 512 byte RSSI after field of approximately over the length of a HDX transponder telegram
Get_Last_ID	0x24	-	Interrogate the oldest ID in the buffer
Get_Phase	0x82	Frequency	Output phase difference of antenna
Get_PhaseAmplitude	0x86	C-pattern, Frequency	Output phase difference and amplitude of the antenna
Get_RSSI	0x85	-	Output RSSI after field off is transmitted
Get_Single_ID	0x22	-	Start a read cycle, field is switched on before and off after acquisition
Get_SNR	0x0A	-	Output the reader serial number
Get_TuningResult	0x89	-	Output result of last auto trim
Get_Tuning	0x43	-	Interrogation of the state of antenna tuning (corresponds to what is displayed by the antenna tuning LEDs), see chapter 2.2.4
Get_Version	0x09	-	Output of the reader and software version
Reset_All	0x18	-	Copy default configuration from ROM to RAM
Retransmit_Request	0x30	-	Repetition of the last output
Save_Config	0x2A	-	Copy configuration from RAM into EEPROM
Set_Config	0x28	Address, cfg_new	Set new configuration temporarily (RAM)
Set_TuningData	0x8A	Trim data	Set temporarily trim data
Start_AutoTuning	0x87	-	Starts auto tuning process

Response/ Acknowledgements	Cod. Hex	Addnl. Data	Description
ACK	0x06	cmd, Data	Last command has been executed, following data
NAK	0x15	cmd	Last command has not been executed

Output	Cod. Hex	Addnl. Data	Description
ID_message	0x23	ID,...	Transponder ID

5.7 Description of the individual messages

5.7.1 Connect_RQ

The reader sends an acknowledgement when it is operationally ready.

Request:

STX	DST	SRC	CMD	CRC 8	ETX
0x02	0xFF	0xF0	0x01	0xFB	0x03

Answer:

STX	DST	SRC	ACK	CMD	DLE	CRC 8	ETX
0x02	0xF0	0x01	0x06	0x01	0x10	0x16	0x03

5.7.2 Get_Amplitude

Request:

STX	DST	SRC	CMD	CRC 8	ETX
0x02	0x01	0xF0	0x83	0xFB	0x03

Answer:

STX	DST	SRC	ACK	CMD	RES	AMP	DLE	CRC 8	ETX
0x02	0xF0	0x01	0x06	0x83	0x00	0x66	0x10	0x40	0x03

RES: Reserved for future use

AMP: Amplitude value of the antenna (in this example 0x66)

5.7.3 Get_Config

The content of the selected configuration register (RAM) is output.

Request:

STX	DST	SRC	CMD	ADR	CRC 8	ETX
0x02	0x01	0xF0	0x29	0x31	0x63	0x03

ADR: Address to read (in this example 0x31 = mode register)

Answer:

STX	DST	SRC	ACK	CMD	CNT	DLE	CRC 8	ETX
0x02	0xF0	0x01	0x06	0x29	0x02	0x10	0xD3	0x03

CNT: Contents of selected configuration register (in this example 0x02)

5.7.4 Get_HDX_Sample

The reader outputs 512 Bytes RSSI data after field of approximately over the length of a HDX transponder telegram.

Request:

STX	DST	SRC	CMD	CRC 8	ETX
0x02	0x01	0xF0	0x91	0x24	0x03

Answer:

STX	DST	SRC	ACK	CMD	D511	...	D0	DLE	CRC 8	ETX
0x02	0xF0	0x01	0x06	0x91	xx	...	xx	0x10	xx	0x03

D511...D0: 512 Byte RSSI data.

5.7.5 Get_Last_ID

In slave continuous mode a 'Get_Last_ID' command transmits the oldest ID from the buffer. The ID message is transmitted immediately. If the buffer memory is empty, a blank ID will be transmitted at once. The RF field remains switched on.

In slave request and in master mode the ID last registered is transmitted.

Request:

STX	DST	SRC	CMD	CRC 8	ETX
0x02	0xFF	0xF0	0x24	0x53	0x03

Answer: ID message

5.7.6 Get_Phase

The phase shift of the antenna is transmitted.

Request:

STX	DST	SRC	CMD	RES	CRC 8	ETX
0x02	0x01	0xF0	0x82	0x3A	0x13	0x03

RES: Reserved for future use, must be set to 0x3A

Answer:

STX	DST	SRC	ACK	CMD	PHI	DLE	CRC 8	ETX
0x02	0xF0	0x01	0x06	0x82	0x17	0x10	0xB7	0x03

PHI: Phase shift of the antenna (in this example 0x17)

5.7.7 Get_PhaseAmplitude

The phase shift and the amplitude of the antenna are transmitted.

Request:

STX	DST	SRC	CMD	CP	RES	CRC 8	ETX
0x02	0x01	0xF0	0x86	0x3F	0x3A	0xC8	0x03

CP: Capacitor pattern used for measurement (in this example 0x3F)

RES: Reserved for future use, must be set to 0x3A

Answer:

STX	DST	SRC	ACK	CMD	PHI	RES	AMP	DLE	CRC 8	ETX
0x02	0xF0	0x01	0x06	0x86	0x17	0x00	0x67	0x10	0xD5	0x03

PHI: Phase shift of the antenna (in this example 0x17)

RES: Reserved for future use

AMP: Amplitude value of the antenna (in this example 0x67)

5.7.8 Get_RSSI

The RSSI after field off is transmitted.

Request:

STX	DST	SRC	CMD	CRC 8	ETX
0x02	0xFF	0xF0	0x85	0xA1	0x03

Answer:

STX	DST	SRC	ACK	CMD	RSSI	DLE	CRC 8	ETX
0x02	0xF0	0x01	0x06	0x29	0x02	0x10	0xD3	0x03

RSSI: Value of the RSSI (in this example 0x02)

5.7.9 Get_Single_ID

Starts a single read cycle by activating the RF field. The response with the ID message will not be given, until a transponder has been registered. If a transponder is not detected within the configured time-out period, a blank ID will be returned.

In the slave request mode after detection of a transponder - or after a time-out has elapsed – the read function terminates and the RF field is switched off. In the other modes the ASR700 returns to its previous state.

Request:

STX	DST	SRC	CMD	CRC 8	ETX
0x02	0xFF	0xF0	0x22	0x7A	0x03

Answer: ID message

5.7.10 Get_SNR

Returns the reader serial number.

Request:

STX	DST	SRC	CMD	CRC 8	ETX
0x02	0xFF	0xF0	0x0A	0xE7	0x03

Answer:

STX	DST	SRC	ACK	CMD	SNR5	SNR4
0x02	0xF0	0x01	0x06	0x94	0x30	0x30
SNR3	SNR2	SNR1	SNR0	DLE	CRC 8	ETX
0x30	0x31	0x30	0x31	0x10	0x68	0x03

SNR5...SNR0: Six byte serial number in ASCII notation (in this example '000101')

5.7.11 Get_TuningResult

Returns the result of last auto trim.

Request:

STX	DST	SRC	CMD	CRC 8	ETX
0x02	0xFF	0xF0	0x89	0xF3	0x03

Answer:

STX	DST	SRC	ACK	CMD	CP1	CP0	PHI	DLE	CRC 8	ETX
0x02	0xF0	0x01	0x06	0x89	0x43	0x5C	0x16	0x10	0x13	0x03

CP1: Capacitor pattern 1 (in this example 0x43)

CP0: Capacitor pattern 0 (in this example 0x5C)

PHI: Phase shift of the antenna (in this example 0x16)

5.7.12 Get_Tuning

The tuning status is automatically measured on a cyclical basis – every time the RF field is switched on. The Get_Tuning request does not initiate measurement of the tuning status but simply delivers an already measured (frozen) status.

Request:

STX	DST	SRC	CMD	CRC 8	ETX
0x02	0xFF	0xF0	0x43	0x6C	0x03

Answer:

STX	DST	SRC	ACK	CMD	STATUS	PHI	DLE	CRC 8	ETX
0x02	0xF0	0x01	0x06	0x43	0x00	0x1A	0x10	0x69	0x03

Status: Tuning status (in this example 0x00)

PHI: Phase shift of the antenna (in this example 0x1A)

A status unequal 0x00 means a new auto tuning should be initiated.

5.7.13 Get_Version

Returns the reader and software version.

Request:

STX	DST	SRC	CMD	CRC 8	ETX
0x02	0xFF	0xF0	0x09	0x4B	0x03

Answer:

STX	DST	SRC	ACK	CMD	VER10	VER9	VER8
0x02	0xF0	0x01	0x06	0x09	0x41	0x53	0x52
VER7	VER6	VER5	VER4	VER3	VER2	VER1	VER0
0x37	0x30	0x30	0x56	0x33	0x2E	0x31	0x32
SEP	DVER3	DVER2	DVER1	DVER0	DLE	CRC 8	ETX
0x2F	0x31	0x2E	0x30	0x35	0x10	0x01	0x03

VER10...VER0: Eleven-byte version string (in this example 'ASR700V3.12').

SEP: Separator '/'

DVER3...DVER0: Three-byte version string signal processing software (in this example 1.05)

5.7.14 Reset_All

This restores the default configuration (factory-set values in ROM) by overwriting all of the configuration registers in RAM.

The network address is set to 0x01.

Request:

STX	DST	SRC	CMD	CRC 8	ETX
0x02	0xFF	0xF0	0x18	0x38	0x03

Answer:

STX	DST	SRC	ACK	CMD	DLE	CRC 8	ETX
0x02	0xF0	0x01	0x06	0x18	0x10	0xF2	0x03

5.7.15 Retransmit_Request

The reader returns the last output (ID message, version, serial number, ACK, NAK etc.).
Request:

STX	DST	SRC	CMD	CRC 8	ETX
0x02	0xFF	0xF0	0x30	0xA5	0x03

Answer: Last output

5.7.16 Save_Config

Saves the current configuration from RAM to the EEPROM. The user configuration saved in the EEPROM is copied to RAM after Power on.

Request:

STX	DST	SRC	CMD	CRC 8	ETX
0x02	0xFF	0xF0	0x2A	0xC9	0x03

Answer:

STX	DST	SRC	ACK	CMD	DLE	CRC 8	ETX
0x02	0xF0	0x01	0x06	0x2A	0x10	0x4B	0x03

5.7.17 Set_Config

The 'Set_Config' request programs a configuration register (in RAM) with the following new values. The corresponding configuration determines how the device will currently work. When the device is switched off, the changes made with 'Set_Config' will be lost unless they are saved with 'Save_Config'.

If the configuration address is not found, or the format of the following configuration value is invalid or a configuration is not supported, a NAK will be sent.

Request:

STX	DST	SRC	CMD	ADR	CFG	CRC 8	ETX
0x02	0xFF	0xF0	0x28	0x31	0x00	0xEE	0x03

ADR: Address of the configuration register (in this example 0x31 => mode)

CFG: Configuration data to program into selected configuration register (in this example 0x00)

Answer:

STX	DST	SRC	ACK	CMD	DLE	CRC 8	ETX
0x02	0xF0	0x01	0x06	0x28	0x10	0x1C	0x03

5.7.18 Set_TuningData

This command is used to set temporarily the tuning data.

Example: The antenna was moved quickly between two reading positions or the environment changes between two states (metal present or not). For both situations an auto tuning could be done by 'Start_AutoTuning' and the result could be got using 'Get_TuningResult'.

For each situation the optimal tuning parameters could be set with 'Set_TuningData'.

Request:

STX	DST	SRC	CMD	CP1	CP0	PHI	CRC 8	ETX
0x02	0xFF	0xF0	0x8A	0x47	0x5F	0x1B	0x24	0x03

CP1: Capacitor pattern 1 (in this example 0x47)

CP0: Capacitor pattern 0 (in this example 0x5F)

PHI: Phase shift of the antenna (in this example 0x1B)

Answer:

STX	DST	SRC	ACK	CMD	DLE	CRC 8	ETX
0x02	0xF0	0x01	0x06	0x8A	0x10	0xCD	0x03

5.7.19 Start_AutoTuning

Starts the auto tuning process (see chapter 2.2.4)

The auto tuning will take about 10.5 Seconds. After it is done, the ASR700 sends the Telegram for receipt.

Request:

STX	DST	SRC	CMD	CRC 8	ETX
0x02	0xFF	0xF0	0x87	0x69	0x03

Answer:

STX	DST	SRC	ACK	CMD	DLE	CRC 8	ETX
0x02	0xF0	0x01	0x06	0x87	0x10	0xDD	0x03

5.8 Description of the acknowledgements

5.8.1 ACK

Correctly received data and executed commands are acknowledged with an ACK.

Answer:

STX	DST	SRC	ACK	CMD	DATn	...	DAT0	DLE	CRC 8	ETX
0x02	0xF0	0x01	0x06	0x87	xx	xx	xx	0x10	xx	0x03

DATn...DAT0: Possible further data.

5.8.2 NAK

If the frame is valid, unrecognised commands or commands which cannot be executed because of wrong data, will be acknowledged with NAK.

Answer:

STX	DST	SRC	ACK	CMD	DLE	CRC 8	ETX
0x02	0xF0	0x01	0x15	xx	0x10	xx	0x03

5.9 ID-Format

5.9.1 Format of ID

Name	Position	Description
0x23	0	Identification of ID-output
Ptr1	1	Length of ID-Field incl. Ptr1
ID-Field	2	n Bytes ID
Ptr2	2+n	Length of Type-Field incl. Ptr2
Type-Field	3+n	n Byte Transpondertyp
Ptr3	3+n+m	Length of time field
Timestamp	4+n+m	Time stamp: hh.mm.ss.aa (optional)
0x00	5+n+m+p	0-Ptr Stop Character (time field only)

Table 1: Format of ID

This format is not valid for ASCII format combined with SCP format (see chapter 5.9.5), ASCII short format (see chapter 5.9.6) and ASCII short format 16 (see chapter 5.9.7).

5.9.2 ID-without time stamp

0x23	Ptr1	ID 0...n	Ptr2	Type 0...m	0x00
------	------	----------	------	------------	------

Table 2: ID-without time stamp

5.9.3 ID- with time stamp

0x23	Ptr1	ID 0...n	Ptr2	Type 0...m	Ptr3	Time 0...p	0x00
------	------	----------	------	------------	------	------------	------

Table 3: ID- with time stamp

5.9.4 Example ID- without time stamp Format ASCII

Examples of ID- telegram without time stamp.

STX	DST	SRC	Id_Out	Ptr1	ID0	ID1	ID2	ID3	ID4
0x02	0xF0	0xF4	0x23	0x11	'0'	'9'	'8'	'2'	'0'
ID5	ID6	ID7	ID8	ID9	ID10	ID11	ID12	ID13	ID14
'0'	'0'	'0'	'0'	'9'	'1'	'8'	'4'	'1'	'9'
ID15	DLE	Ptr2	Typ0	Typ1	Ptr3	DLE	CRC 8	ETX	
'5'	0x10	0x03	'0'	'1'	0x00	0x10	0xBA	0x03	

STX	Start of Text	=> Start of Telegram
DST	0xF0	=> HOST
SRC	Source = 0xF4	=> ASR700
Code	0x23	=> ID-Output
Ptr1	0x11	=> 1 Byte Length + 16 Byte ID
ID0...ID15	'0982000009184195'	
DLE	0x10	
Ptr2	0x03	=> 1 Byte Length + 2 Byte Transpondertyp
Typ0...Typ1	'01'	=> HDX Transponder regarding ISO
Ptr3	0x00	=> No time stamp (Identification of STOP)
DLE	0x10	=> Before CRC always DLE
CRC	0xBA	
ETX	0x03	=> End of Telegram

5.9.5 Example ID- without time stamp Format ASCII and SCP format

ID0	ID1	ID2	ID3	ID4	ID5	ID6	ID7	ID8	ID9
'0'	'9'	'0'	'0'	'3'	'1'	'6'	'3'	'6'	'0'
CR	LF								
0x0D	0x0A								

ID0...ID15	'0900316360'
CR	0x0D
LF	0x0A

If in addition to the ID format the Format Option Short is activated (see chapter 4.3.2), the data will be transmitted without frame. The last characters of the telegram will be <CR> (0x0D) <LF> (0x0A).

5.9.6 Example ID- without time stamp Format ASCII short format

ID0	ID1	ID2	ID3	ID4	ID5	ID6	ID7	ID8	ID9
'9'	'8'	'4'	'0'	'1'	'0'	'9'	'0'	'0'	'3'
ID10	ID11	ID12	ID13	ID14	CR	LF			
'1'	'6'	'3'	'6'	'0'	0x0D	0x0A			

ID0...ID15	'984010900316360'
CR	0x0D
LF	0x0A

If Short ASCII is activated (see chapter 4.3.2), 15 data bytes will be transmitted in ASCII notation without frame. The leading zero is not transmitted. The last characters of the telegram will be <CR> (0x0D) <LF> (0x0A).

5.9.7 Example ID- without time stamp Format ASCII short format 16

ID0	ID1	ID2	ID3	ID4	ID5	ID6	ID7	ID8	ID9
'0'	'9'	'8'	'4'	'0'	'1'	'0'	'9'	'0'	'0'
ID10	ID11	ID12	ID13	ID14	ID15	CR	LF		
'3'	'1'	'6'	'3'	'6'	'0'	0x0D	0x0A		

ID0...ID15 '0984010900316360'
CR 0x0D
LF 0x0A

If Short ASCII 16 is activated (see chapter 4.3.2), 16 data bytes will be transmitted in ASCII notation without frame. The leading zero is transmitted. The last characters of the telegram will be <CR> (0x0D) <LF> (0x0A).

5.10 CRC Calculation

The 8 Bit CRC will be calculated with the CCITT-CRC-8 Polygon $x^8+x^4+x^3+x^2+1$ with all Bytes including STX without the Checksum itself. An ESCAPE before the checksum has to be calculated as well.

A frame from the ASR700 to the Host always has a DLE in front of a CRC.

5.10.1 CRC-Algorithm

CRC-Algorithm

```
char CalcCRC8 (char CRC, char byte)
{
    unsigned char count;
    for (count = 0; count < 8; ++count)
    {
        if (((CRC & 0x01) ^ (byte & 0x01)) != 0)
        {
            CRC ^= 0x70;
            CRC >>= 1;
            CRC |= 0x80;
        }
        else
        {
            CRC >>= 1;
            CRC &= 0x7F;
        }
        byte >>= 1;
    }
    return (CRC);
}
```

6. Clock synchronisation of ASR 700 readers

When two or more antenna fields are overlapping there might be some interferences with FDX transponders. This is due to the very small differences of the frequency generated by the oscillator (clock) of the readers.

To prevent this interference it is possible to synchronize the readers, this means that the clock generated by the oscillator of one reader is used for the additional readers. The reader, which generates the oscillator clock, is called clock master and the readers that receive the oscillator clock are called clock slave.

6.1 Installation

- The total length of the cables for the synchronization should not exceed 4 meters.
- Recommended types of cable for the connection are shielded twisted pair or coaxial cable RG58 or coaxial cable RG174.

A connection between –UB (ST7 pin2) and G (e.g. ST7 pin5 or ST7 pin7) influences and may improve the reading range.

If the Agrident power supply is used, it's possible to connect earth and ground of the power supply (fuse, F2), which also influences the reading range of the devices.

6.2 Setting at the ASR700

Clock master Jumper 3 open, that means to use the reader's own oscillator for generating the frequency.

Clock slave Jumper 3 closed, that means use the clock coming in at ST7 pin 9 (Clock In). If the connection (from ST7 pin 8 Clock Out of the master) is not made, the slave will not work.

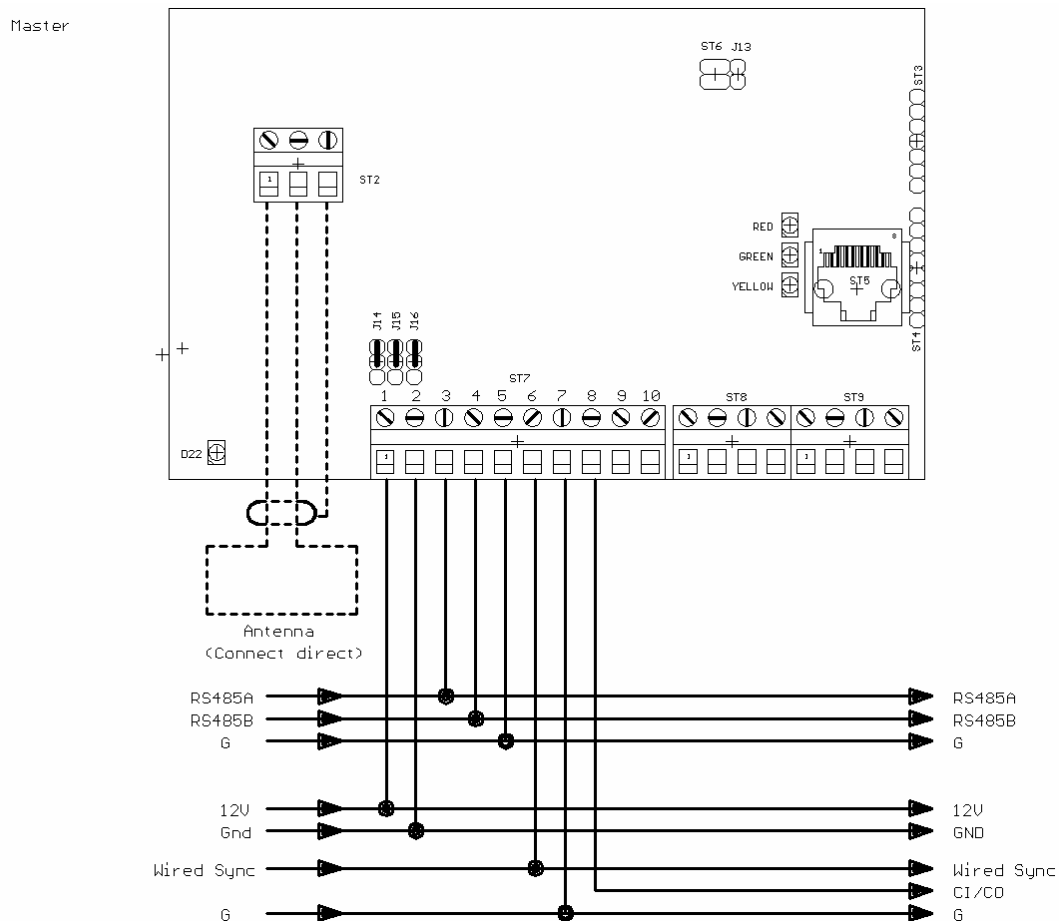

Figure 15: Connection diagram ASR700 as master

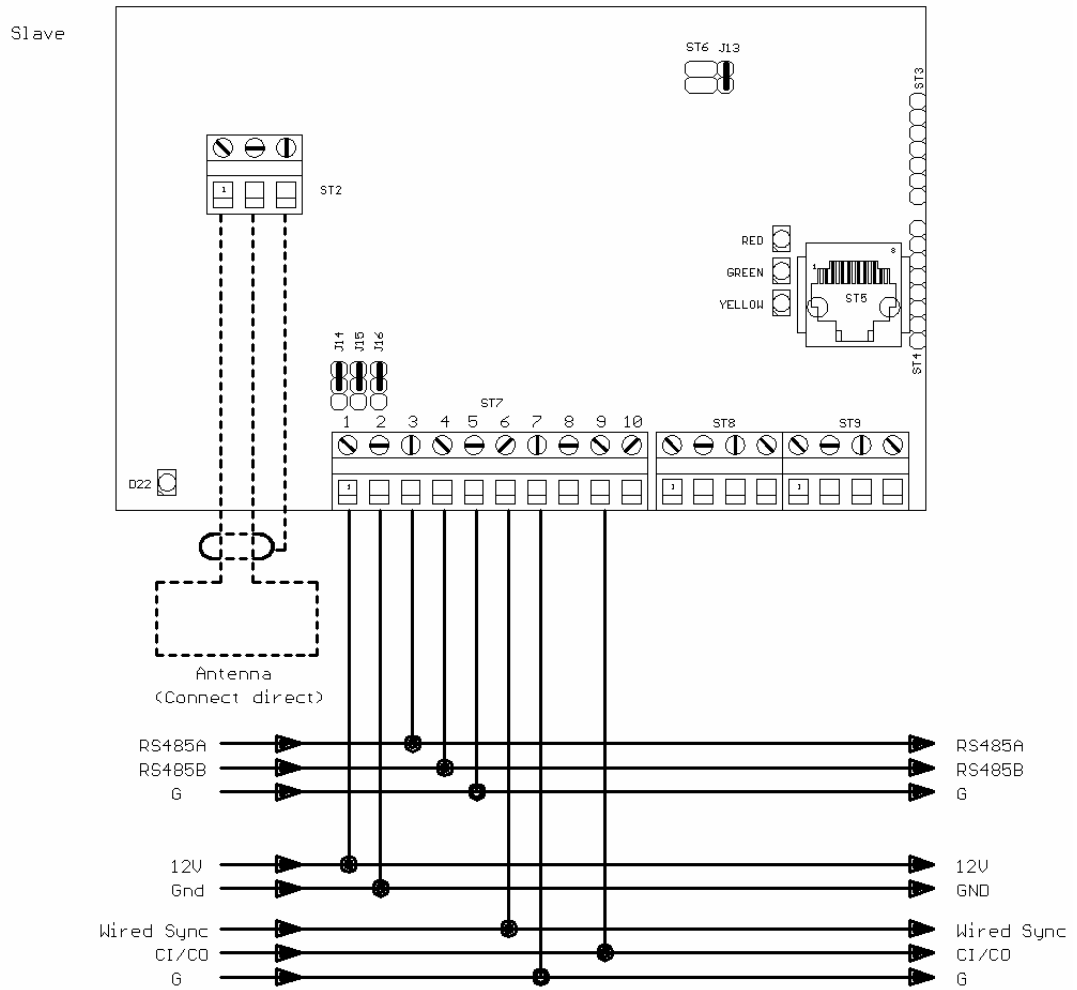

Figure 16: Connection diagram ASR700 as slave

7. Technical data

Frequency of the RF carrier generated	134,2 KHz
Transponder types supported	-HDX-compatible (ISO 11784/5) -FDX-B-compatible (ISO 11784/5)
Environmental conditions	Operation: 0-60 °C Storage: -25° - 80 °C Air humidity: 5 – 90 % (non-condensing)
Dimensions	L x B x H: ASR766: 345x 200 x 150 mm
Safety class	ASR700: - ASR754: IP54 ASR766: IP67
Power supply	13,8V DC, max. 1A, typical 700mA
Interface	RS232, RS485 Configuration: 9600 baud, 8, N, 1
Weight	ASR700: appr. 210 g ASR754: appr. 1600 g ASR766: appr. 3000 g

8. Influence of noise, Interference and metal objects on the reading range¹

Most of what affects ISO RFID readers is actually electrical interference, although it is often more commonly referred as "noise".

Tag reading is a 2-way process, but most interference problems affect the much weaker transmissions from tag to reader. The tag to reader transmission is at a frequency of 134,2 kHz.

There are many interference sources that have been identified. Some are rarely seen, but as a result are not easily diagnosed. Anything that can produce magnetic fields at around 100 kHz is a potential source of interference. The effect of noise and interference increases over proportionally. Therefore these effects are much more severe on stationary readers with larger antennas.

8.1 Computer monitors

All computer monitors produce magnetic fields from their scan coils. By far the worst are those whose line scan frequency has a harmonic around 100 kHz. Modern monitors often change their scan frequency depending on how they are being used. The other variable is how well screened the monitor is.

Some monitors will reduce the reading range of a stationary reader at a distance of 3 meters (10 feet) or more. Others make no difference at a distance of 1 meter. **When we quote distances in such cases, they are taken from the centre of the reader's antenna.**

We advise that users are warned that any computer monitor may have a serious effect, and if necessary you should do a Site Survey. If you get the result that a monitor isn't making a lot of difference, ask them to take it through all the video modes they might use. For instance operate under DOS and Windows, and if any high-resolution graphics packages are used, get the user to load them. Only after all of this can you be reasonably confident.

Other CRT (cathode-ray tube) products such as televisions and oscilloscopes can also produce interference, but they rarely present a real problem.

8.2 Other electronic equipment

All electronic equipment should be suspect, although very rarely does it cause significant interference. (The tendency towards better control of EMC should help, but few standards limit unintentional emission at 134.2 kHz.)

8.3 Data cables

There are cases where computer data cables can cause interference, which affects readers. This is unusual, and most network cables are very good. However, you should nevertheless be aware of the possibility.

As with so many interference sources, data cables don't create interference until the building is fully functional. **Beware of doing a Site Survey on an empty building.**

8.4 Mains cables

It is more common to see some interference from mains cables. The most usual situation is close to the main distribution board for a building. The reason for this is that this may be where there is a separate earth connection, for instance to ground gas and water pipes. Normally the interference currents in the mains conductors are balanced. The current flows along one core of the cable and back down another, giving only a small net current to create interference. The other connections at a distribution board destroy the balance, hence the problem.

It is best to avoid putting readers close to high power cables, sub-stations etc. unless you are sure. This is another case where the interference will go up once the building is occupied.

¹ Identec Ltd. – Cryptag Census Site Manual

8.5 Fluorescent and Low Voltage Lighting

Both types of lighting can on rare occasions produce interference.

Some fluorescent lights generate radio frequencies, but the emission levels are generally small.

We have come across Low Voltage lighting systems that generate high emission levels in their "transformer" module, which actually contains a switch-mode converter. These do not meet current EMC regulations, but may have been legal when installed.

8.6 Other readers

One potential source of interference that is easily overlooked is other readers, and other products that use the same frequency band. Low power products are restricted to a few frequency bands, so there may be cases where two legitimate products are trying to use the same band. An ISO HDX tag will not read properly if it is picking up transmissions from two different ISO readers that are not synchronised. Nearly always it won't respond at all, but if it has started responding to one it may give peculiar responses to both.

(ISO tags do not respond to signals from tagging systems such as shop-door systems, but the reading range may be affected by their signals.)

8.7 Effects of metal near readers

Usually metal near the antenna of a reader which reduces performance, but it is possible to use the effects of metal to advantage.

Metal close to an aerial loop can act as a short circuit, sucking energy out of the reader. It will affect the tuning of the antenna, but even if the antenna is returned there could still be a loss of range. The reading zone will change its shape, with the range behind the metal reduced.

The effect on the reading range is greater when the metal is closer to the antenna loop. Many factors affect the range, but typically a complete sheet of metal, 100 mm (4 inches) behind the antenna loop, reduces the reading range by about 25%. (If the metal is ferrous, it will have slightly more effect.) This is after the antenna loop has been retuned.

When the metal is only close to part of the loop, the effect is reduced. If the metal is only close to one side of the loop the effect is minimal.

As metal affects tuning, metal doors can pose a problem. If the antenna loop is too close, it's tuning will change when the doors are open. If the tuning is optimised when the doors are open, the range will drop when the doors close (or vice versa).

Ferrous metal (e.g. steel) introduces new considerations. A sheet of ferrous metal reduces the reading range by more than non-ferrous metal. It also acts as a better screen, with the range behind the metal reduced to around 50% of the range in front. The shape of the reading zone behind the metal is distorted, making the region where tags will be read less predictable.

Ferrous metal (of any shape) can concentrate magnetic fields, and this has been known to give an unexpected increase in range. On the other hand, it can also concentrate interference signals towards a reader. What you should be on the lookout for is a situation where a relatively long and thin ferrous metal structure has one end close to the antenna loop.

9. FCC digital device limitations

Radio and Television Interference

This equipment has been tested and found to comply with the limits for a digital device, pursuant to Part 15 of the FCC rules. These limits are designed to provide reasonable protection against harmful interference when the equipment is operated in a commercial environment. This equipment generates, uses, and can radiate radio frequency energy and, if not installed and used in accordance with the instruction manual, may cause harmful interference to radio communications. Operation of this equipment in a residential area is likely to cause harmful interference, in which case the user will be required to correct the interference at his own expense.

This device complies with Part 15 of the FCC rules. Operation is subject to the following two conditions: (1) This device may not cause harmful interference, and (2) this device must accept any interference received, including interference that may cause undesired operation.

In order to maintain compliance with FCC regulations, shielded cables must be used with this equipment. Operation with non-approved equipment or unshielded cables is likely to result in interference to radio and television reception.

Caution! Changes or modifications not expressly approved by the manufacturer could void the user's authority to operate this equipment.

10. CE MARKING

Hereby, Agrident BV declares that this equipment, if used according to the instructions, is in compliance with the essential requirements and other relevant provisions of the RTTE Directive 1999/5/EC. For use in all countries of the EU.

To obtain a copy, contact Agrident BV and request the "Declaration of Conformity" document for Multi-technology readers.

Agrident BV
mail@agrident.com

In case of alteration of the product, not agreed to by us, this declaration will lose its validity.

This symbol indicates proof of conformity to applicable European Economic Community Council directives and harmonized standards published in the official journal of the European Communities.



11. Safety and care

The manufacturer accepts no liability for damage resulting from improper use or use not consistent with that described in these operating instructions.

- The ASR700 reader contains no parts that can be repaired by the user. For this reason the Reader may only be repaired by authorised customer service personnel.
- In both operation and storage of the reader please ensure compliance with the environment conditions specified in the technical data.
- Clean the ASR700 reader only with a damp cloth. Use only water and any commercially available cleaning agent.

Any modification to the ASR700 reader will render the warranty null and void.

12. Warranty

The manufacturer of the ASR700 reader Electronic will provide a warranty of

12 months

from the day the device is shipped and subject to the following conditions:

- a. Without submission of proof of purchase no warranty can be given.
- b. In the event that defects are detected the manufacturer is entitled to choose between up to two attempts at repair or a one time replacement of the faulty device. The warranty period for the repaired item or replacement item is 3 months, but will always extend to the end of the original warranty period. No further claims can be entertained, especially claims for compensation for consequential losses. This exclusion of liability does not apply to claims made on the basis of the Product Liability Act.
- c. Warranty claims cannot be entertained unless the Agrident system was installed properly and used properly and for the purpose intended.

No warranty obligations exist in particular when:

1. Damage is attributable to improper use of the device, to an incorrect connection or incorrect operator action;
2. The device was not cared for and maintained in accordance with the manufacturer's recommendations and this is the cause of the damage;
3. The damage is due to any modification to the device;
4. The damage is due to force majeure, for example, lightning strike;
5. The damage is due to wear resulting from overstressing mechanical parts.

13. Appendix

13.1 RF synchronisation

If only one reader is to be accessed at any one time by the control computer – in other words, only that reader's RF field is activated – then wire-based synchronisation will not be necessary. If several readers are operated in the immediate vicinity of each other (in other words, closer together than 3 m) and the readers have been configured for HDX acquisition, it is possible that the corresponding synchronisation will be necessary. This is described in chapter 6.

13.2 Description of commands and acknowledgements

Command / Request	Cod. Hex	Addnl. Data	Description
Connect_RQ	0x01	-	Interrogate connection status
Get_Amplitude	0x83	-	Output the amplitude of the antenna
Get_Config	0x29	Address	Output the current configuration
Get_HDX_Sample	0x91	-	Output 512 byte RSSI after field of approximately over the length of a HDX transponder telegram
Get_Last_ID	0x24	-	Interrogate the oldest ID in the buffer
Get_Phase	0x82	Frequency	Output phase difference of antenna
Get_PhaseAmplitude	0x86	C-pattern, Frequency	Output phase difference and amplitude of the antenna
Get_RSSI	0x85	-	Output RSSI after field off is transmitted
Get_Single_ID	0x22	-	Start a read cycle, field is switched on before and off after acquisition
Get_SNR	0x0A	-	Output the reader serial number
Get_TuningResult	0x89	-	Output result of last auto trim
Get_Tuning	0x43	-	Interrogation of the state of antenna tuning (corresponds to what is displayed by the antenna tuning LEDs), see chapter 2.2.4
Get_Version	0x09	-	Output of the reader and software version
Reset_All	0x18	-	Copy default configuration from ROM to RAM
Retransmit_Request	0x30	-	Repetition of the last output
Save_Config	0x2A	-	Copy configuration from RAM into EEPROM
Set_Config	0x28	Address, cfg_new	Set new configuration temporarily (RAM)
Set_TuningData	0x8A	trim data	Set temporarily trim data
Start_AutoTuning	0x87	-	Starts auto tuning process

Response/ Acknowledgements	Cod. Hex	Addnl. Data	Description
ACK	0x06	cmd, data	Last command has been executed, following data
NAK	0x15	cmd	Last command has not been executed

Output	Cod. Hex	Addnl. Data	Description
ID_message	0x23	ID,...	Transponder ID

13.3 Description of the registers

Register	Cfg_Adr	Bits to Set	Hex value of settings	Significance of the registers or their configuration
Cfg_Delaytime	0x35		0x01*	Time interval for repeated ID message Repetition blockage for time 't' of an already transmitted/saved ID message: Time 't' = register value * approx. 50 ms (0x00 results in no repetition)
Cfg_Format	0x32		0x01*	Format of the ID message
		0	0x01	ASCII notation
		1	0x02	Transponder byte structure
		0,1	0x03	Compact coding
		1,2	0x06	Output of raw data without CRC
		0,1,2	0x07	ASCII short format
		5**	0x20	Use SCP format
Cfg_Mode	0x31		0x00*	Operation mode
			0x01	Slave continuous mode
			0x02	Slave request mode
			0x00	Master mode
Cfg_Node	0x36		0x01*	Individual network address of a reader; Range of values: 0x00 to 0xEF, except 0x02,0x03,0x10
Cfg_RF	0x33		0x0E*	Configuration of the RF interface
		1	0x02	FDX-B reception activated
		2	0x04	HDX reception activated
		1,2	0x06	FDX-B and HDX activated
		5	0bxx1x100x	Use 125 kHz (this option is possible if only H4002 transponders activated) available at version 1.61 or later
Cfg_Time-out	0x34		0x01*	Time in which the field is active After the time-out period the field activated with Get_single_ID is switched off unless a transponder is detected within the time interval (after this the field is switched off immediately); Time = register value x approx. 100 ms (Value 0x00 also yields approx. 100 ms)

* Default values specified.

** Combinations with other mentioned bit combinations for Cfg_Format are possible.

13.4 Factory configuration

Parameter	Setting
Mode (Cfg_Mode*)	Master mode (0x00)
Data output format (Cfg_Format*)	ASCII output of the ID (0x02)
Transponder types (Cfg_RF*)	All transponder types (0x0E)
Time out (Cfg_Timeout*)	100ms (0x01)
Delay time (Cfg_Delaytime*)	50ms (0x01)
Network address (Cfg_Node*)	0x01
Interface (fixed)	9600 Baud, 1 Start bit, 8 Data bits, No Parity, 1 Stop bit

14. Trouble shooting

For any undescribed problem please contact us:

Agrident GmbH
Steinklippenstr. 10
30890 Barsinghausen
Germany

Telephone +49 5105 520614
FAX +49 5105 520616
e-mail mail@agrident.com