

1.1 Installation Guide

1 LOCATE CORRECT SITING POINT

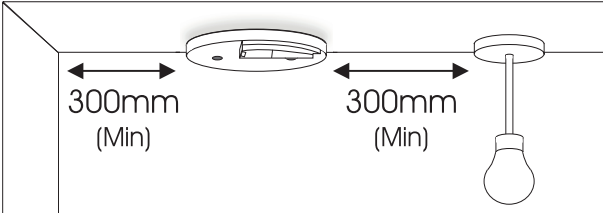

300mm (Min) 300mm (Min)

ALARM SHOULD BE CEILING MOUNTED AT LEAST 300mm FROM WALLS & OBSTRUCTIONS, IDEALLY CENTRALLY IN ROOM/AREA

2 FIX & WIRE BASEPLATE

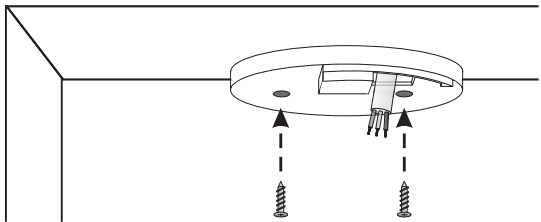

WIRE TO TERMINALS ON BASEPLATE AND FIX BASEPLATE TO CEILING USING THE FIXINGS PROVIDED

3 SLIDE ON ALARM

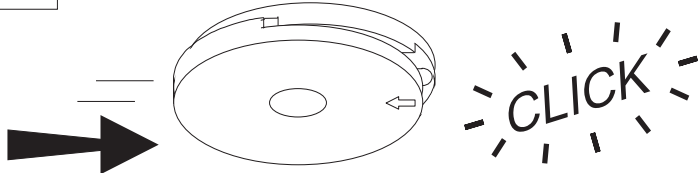

CLICK

SLIDE ALARM ONTO BASEPLATE. A CLICK SHOULD BE HEARD AS THE TAMPER-PROOF CATCH ENGAGES.

4 TEST ALARMS

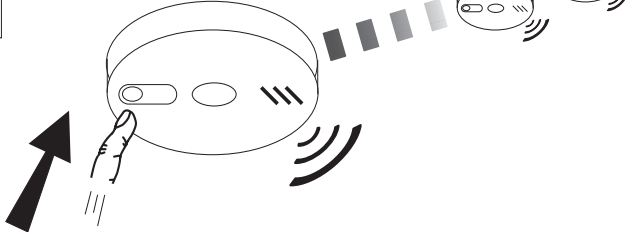

PRESS AND HOLD THE TEST BUTTON ON THE ALARM. THE ALARM AND ANY INTERCONNECTED UNITS SHOULD SOUND.

**ATTENTION: THIS SECTION IS ONLY A GUIDE.
PLEASE READ FULL INSTRUCTIONS BEFORE INSTALLATION**

2. ALARM REMOVAL

*** DISCONNECT MAINS BEFORE REMOVAL ***

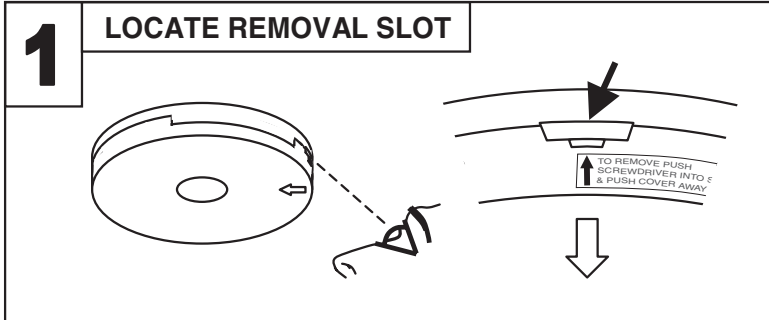

LOCATE THE ARROW ON THE FRONT FACE OF THE ALARM. THE SLOT IS LOCATED DIRECTLY ABOVE THE ARROW.

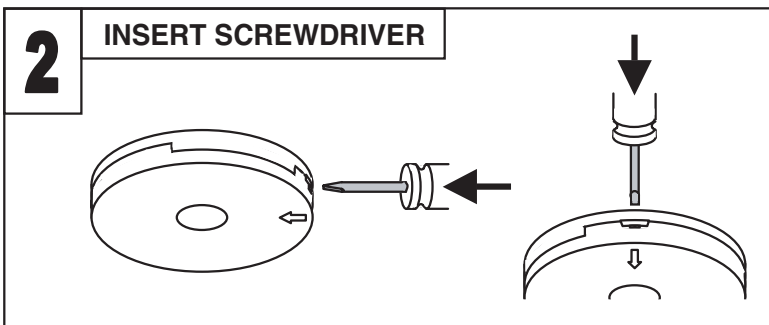

INSERT A FLAT-BLADED SCREWDRIVER HORIZONTALLY APPROX. 1cm INTO THE CENTRE OF THE REMOVAL SLOT

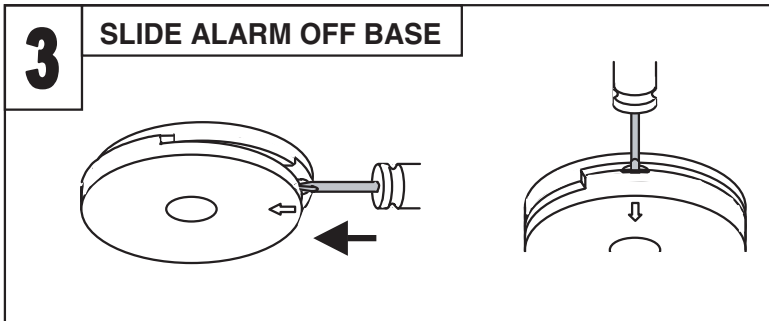

WITH THE SCREWDRIVER STILL INSERTED, PUSH THE LOWER HALF OF THE ALARM AWAY FROM THE SCREWDRIVER, IN THE DIRECTION OF THE ARROW ON THE COVER

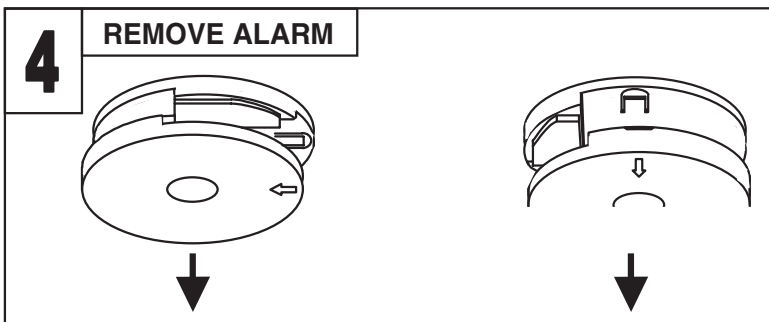

HOLD THE LOWER HALF OF THE ALARM AND REMOVE FROM THE BASE PLATE BY MOVING IT VERTICALLY DOWNWARDS, TOWARDS THE FLOOR.

2. HOW MANY ALARMS TO INSTALL - CATEGORIES & GRADES -

The advice here follows the guidance in British Standard BS 5839-Part 6: 2004 in general (for further information see the BS standard itself).

The main reason for fitting Smoke & Heat Alarms in dwellings is to ensure that when there is a fire, sufficient early warning is given so that everybody can escape safely.

This means that the fire alarms should ideally be located near all potential sources of fires and that the alarm should be heard throughout the house – particularly in the bedrooms.

It is also important that nuisance/false alarms are minimised to ensure the units are not disabled or ignored.

The BS standard gives guidance on:

- how many alarms to install
- what type of alarm to use
- where to position alarms

The above points will depend on the type of dwelling to be protected and the level of fire risk.

Fire Risk Assessment

The 'Grade' and 'Category' of system that should be installed depends on the fire risk. The risk assessment is based on a combination of probabilities:

- fire occurring
- injury or death to occupant
- system operating correctly with a fire
- early detection and warning to occupants in the event of a fire.

The greater the risks, the more comprehensive and reliable systems are needed.

2.1 Categories of System

There are three Categories of **LD** systems for **L**ife protection in **D**wellings that can be installed, depending on the fire risk and regulations.

Please see following pages for detailed information.

LD3 MINIMUM PROTECTION

for existing dwellings

Minimum Protection LD3: Smoke Alarms in all hallways, stairways and circulation areas that form part of the escape routes from the dwelling.
Interconnect all alarms

Smoke Alarms located:

- on each storey
- every 7.5 m of hallways and escape routes
- within 3m of all bedroom doors (apart from toilets & bathrooms ☒)

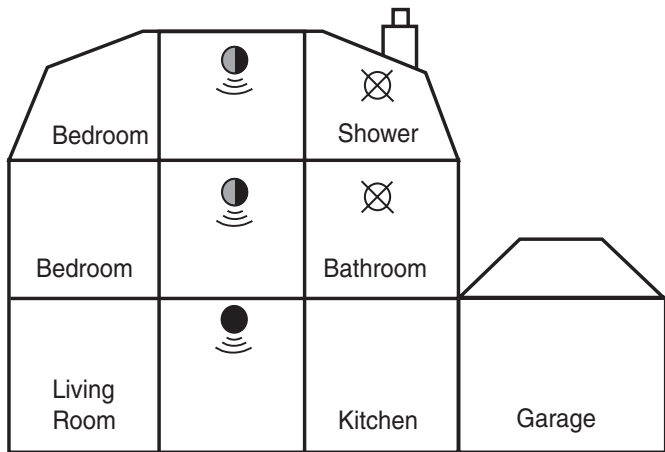

Multi Storey Dwelling LD3

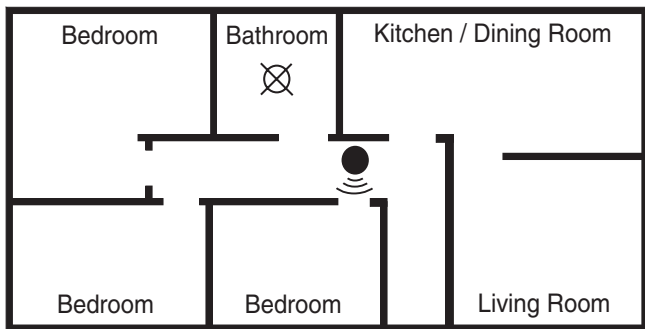

Single Storey Dwelling LD3

Ionisation or Optical Smoke Alarm	Optical Smoke Alarm
	do not fit alarm

LD2 ADDITIONAL PROTECTION

for new or materially altered dwellings or existing dwellings with poor structural fire precautions

Additional Protection LD2: As LD3, but in addition Smoke or Heat Alarms in all rooms or areas that present a high fire risk to occupants.

Interconnect all alarms

 **Smoke Alarms** located:

- on each storey
- every 7.5 m of hallways and escape routes
- within 3m of all bedroom doors (apart from toilets & bathrooms ☒)

 **Heat Alarms** located in:

- each Kitchen (Heat Alarms must be within 5.3m of potential fire sources)

 **Smoke or Heat Alarms** located in:



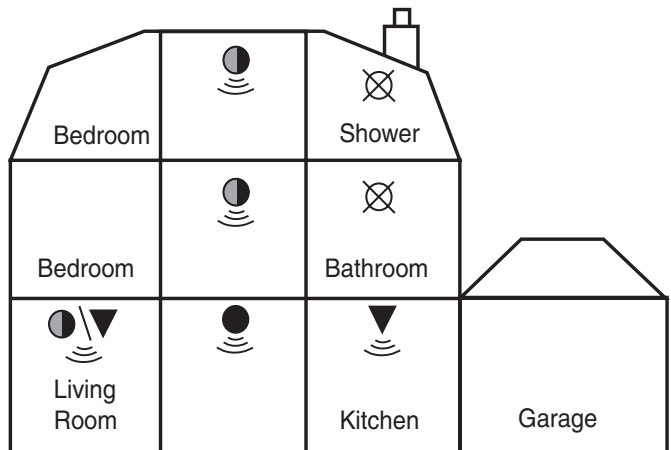

- each Living room (i.e. most frequently used daytime room)

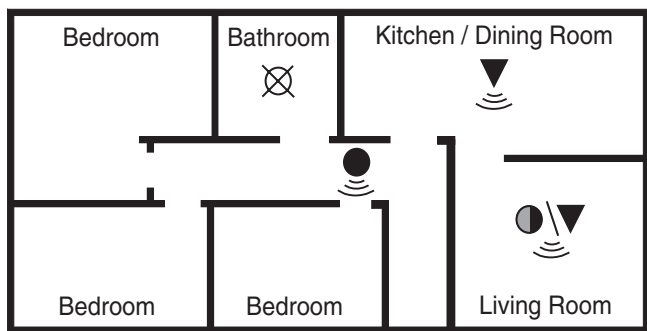

Multi Storey Dwelling LD2



Single Storey Dwelling LD2

 Ionisation or Optical Smoke Alarm	 Optical Smoke Alarm
 Heat Alarm	 do not fit alarm

LD1 OPTIMUM PROTECTION

for dwellings where occupants may be at high risk (e.g. elderly)

Optimum Protection LD1: As LD2, but in addition Smoke or Heat Alarms should be located in all rooms and other areas of the dwelling. (apart from toilets or bathroom)

Interconnect all alarms

 **Smoke Alarms** located:

- on each storey
- every 7.5 m of hallways and escape routes
- within 3m of all bedroom doors
- in all other rooms & areas other than listed below (apart from toilets & bathrooms ☒)

 **Heat Alarms** located in:

- each Kitchen
- garages

(Heat Alarms must be within 5.3m of potential fire sources)

 **Smoke or Heat Alarms** located in:



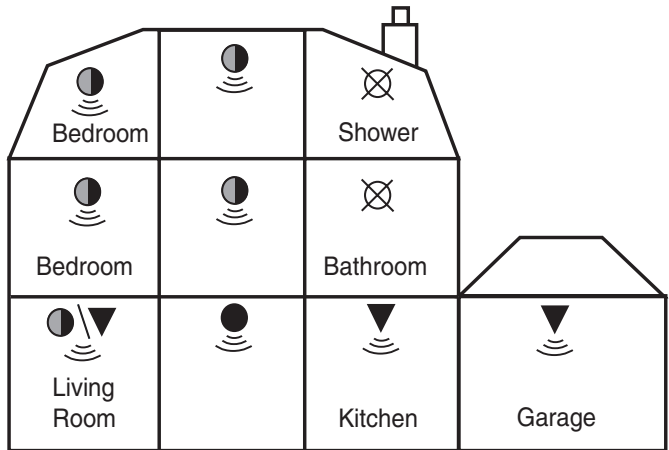

- each Living room (i.e. most frequently used daytime room)

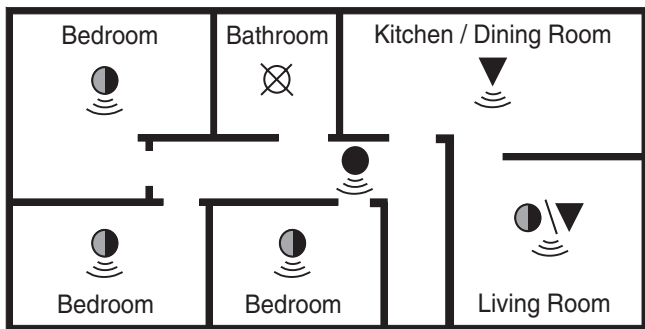

Multi Storey Dwelling LD1



Single Storey Dwelling LD1

	Ionisation or Optical Smoke Alarm		Optical Smoke Alarm
	Heat Alarm		do not fit alarm

2.2 Selecting Alarm Type

Optical/Ionisation/Heat Alarm Selection Locations & Performance			
	Alarm Type		
	Optical ¹	Ionisation ²	Heat
<u>Locations</u>			
Hall, Corridors, Escape Routes	✓✓✓	✓✓	X
Kitchens	X	X	✓✓✓
Living Rooms	✓✓✓	✓✓	✓ ³
Bedrooms	✓✓✓	✓✓	X
Shower / Bathroom	X	X	X
<u>Fire Response</u>			
Slow Smouldering Fires <small>(polyurethane foam, ignited bedding etc.)</small>	✓✓✓	✓✓	X
Fast Flaming Fires <small>(chip pans, flaming wood/plastic, oil, solvents etc.)</small>	✓✓	✓✓✓	X
Temperature >58°C <small>(only in areas with cooking fumes, steam, very dirty/dusty)</small>	X	X	✓✓✓ ⁴
<u>Nuisance Alarm Immunity</u>			
Cooking Fumes	✓✓	✓ ⁵	✓✓✓
Steam, Condensation & Dust Build-up	✓	✓✓	✓✓✓
✓✓✓ - Best ✓✓ - Good ✓ - Acceptable X - Not Suitable			

¹ Optical Smoke Alarms are recommended due to their excellent response to smouldering fires. If there is likely to be problems with steam, contamination or dust build-up, or if there is significant risk of a fast burning clean fire an Ionisation Smoke Alarm should be fitted.

² Some Fire Authorities recommend that both Ionisation and Optical Smoke Alarms should be fitted for the fastest response to all types of fires.

³ Some Fire authorities (concerned with the slow response of Heat Alarms) advise that Smoke Alarms should be fitted. This is acceptable according to BS 5839-6 provided there are clearly not going to be problems with nuisance alarms. Fit Heat Alarms only if nuisance alarms are very likely and it is acceptable that a warning will only be given by the Heat Alarm when there is a very significant flaming fire in the room. If the door(s) and windows are not closed to contain the fire and heat, it is extremely unlikely that the Heat Alarm would respond before a Smoke Alarm sited outside in the corridor.

⁴ In enclosed kitchens with doors closed.

⁵ Greatly depends on ventilation and distance from source of fumes.

Improved Audibility

The effectiveness of Category LD2 and LD3 systems can be significantly enhanced if an additional Smoke Alarm (interconnected) is installed in the master bedroom. This will help ensure that a responsible person will quickly be alerted to a fire and can arrange for an orderly evacuation of children and other vulnerable occupants.

2.3 Grade D, E & F Systems

The mains powered Smoke and Heat Alarms with battery back-up covered by these instructions are suitable for Grade D, E & F Systems.

A Grade D system is needed for:

- new or materially altered dwellings, up to three-storeys, with no floor over 200m²
- existing dwellings with poor structural fire precautions, up to three storeys, with no floor over 200m²
- Houses in Multiple Occupation (HMOs) of one or two-storeys, with no floor over 200m²
- Individual dwellings units of two or more rooms in HMOs

Check that a Grade D system is adequate for the dwelling into which the system is being installed.

3. POSITIONING ALARMS

The locations must comply with applicable building regulations.

Hot smoke rises and spreads out, so a central ceiling position is the preferred location. The air is “dead” and does not move in corners, therefore Smoke & Heat Alarms must be mounted away from corners. Place the unit:

- At least 0.3m away from walls. See **Figure 1**.
- At least 0.3m from any light fitting or decorative object which might obstruct smoke / heat entering the Alarm.

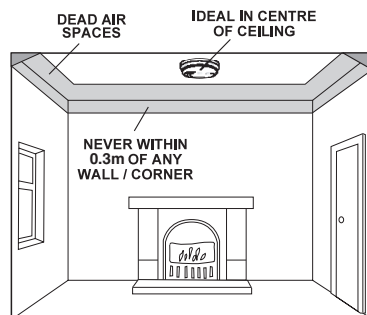

Figure 1

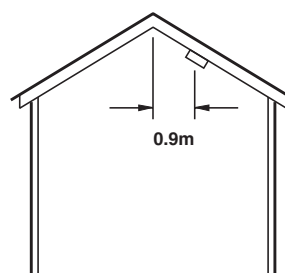

Figure 2

(Smoke Alarms should be located directly on the ceiling or, if not possible, up to 575mm below it. Heat Alarms should be located directly on the ceiling or, if not possible, up to 125mm below it).

Sloping Ceiling

In areas with sloping or peaked ceilings install the Smoke/Heat Alarm 90cm from the highest point measured horizontally (see **Figure 2**), because “dead air” at the apex may prevent smoke from reaching the unit.

3.1 Locations To Avoid

DON'T place Smoke Alarms in any of the following areas:

- *Bathrooms, kitchens, shower rooms, garages* or other rooms where the smoke alarm may be triggered by steam, condensation, normal smoke or fumes. Keep at least 6 metres away from sources of normal smoke/fumes.

DON'T place Heat Alarms in any of the following areas:

- *Bathrooms, shower rooms* or other rooms where the unit may be triggered by steam or condensation.

DON'T place Smoke or Heat Alarms in any of the following areas:

- Places where the normal temperature can exceed 40°C or be below 4°C (e.g. *attics, furnace rooms, directly above ovens or kettles* etc.) as the heat/steam could cause nuisance alarms.
- Near a *decorative object, door, light fitting, window moulding* etc., that may prevent smoke or heat from entering the Alarm.
- Surfaces that are normally warmer or colder than the rest of the room (e.g. *attic hatches*). Temperature differences might stop smoke or heat from reaching the unit.
- Next to or directly above *heaters or air conditioning vents, windows, wall vents* etc. that can change the direction of airflow.
- In very *high or awkward areas* (e.g. over stairwells) where it may be difficult to reach the alarm (for testing, hushing or battery replacement).
- Locate away from very *dusty or dirty areas* as dust build-up in the chamber can impair performance. It can also block the insect screen mesh and prevent smoke from entering the smoke detector chamber.
- Locate the unit at least 1m from *dimmer controlled lights and wiring* as some dimmers can cause interference.
- Locate unit at least 1.5m and route wiring at least 1m away from *fluorescent light fittings* as electrical "noise" and/or flickering may affect the unit. Do not wire into the same circuit as fluorescent lights or dimmers.
- Do not locate in *insect infested areas*. Small insects getting into the smoke detector chamber can cause intermittent alarms. Insects and contamination on the Heat Alarm sensor can increase its response time.

4. INSTALLATION

The Alarm is designed to be permanently mounted , using it's own built-in terminal block to connect it to the mains. The mounting plate can be screwed directly to the ceiling. Alternatively it can be screwed to a standard junction box. It requires a current of 40mA. The Alarm must not be exposed to dripping or splashing. There are important markings on the underside of the alarm.

IMPORTANT PRECAUTION: Do not install the Alarms in new or renovated buildings until all work is completed (including floor coverings) and the building has been fully cleaned. The wiring can be installed when

appropriate. (*Excessive dust and debris from building work can contaminate the smoke chamber or heat sensor and cause problems, it will also invalidate the guarantee*). If it must be installed, first cover it completely, particularly around the edges, with a dust cover (eg. with the elasticated cover supplied or a plastic bag), until all cleaning is finished.

The Alarm must not be connected when the house wiring insulation is being checked with high voltages.

i.e. Do not use a high voltage insulation tester on the alarm.

WARNING: Mains operated Alarms should be installed and interconnected by a qualified electrician in accordance with the Regulations for Electrical Installations published by the Institution of Electrical Engineers (BS7671). Failure to install this Alarm correctly may expose the user to shock or fire hazards.

WARNING: The Alarm must be continuously powered 24 hours a day so it is important that it is not on a circuit that can be turned off by a switch.

Note: BS 5839-6 2004 gives the following recommendations regarding the mains supply to be used in a Grade D system (The Ei141/146 /161RC/166RC Smoke Alarms and Ei144/164RC Heat Alarms can be used in a Grade D system). The power supply for the Alarms should be derived from the public electricity supply to the dwelling. The mains supply to the Alarms should take the form of either:

(a) an independent circuit at the dwelling's main distribution board, in which case no other electrical equipment should be connected to this circuit (other than a dedicated monitoring device installed to indicate failure of the mains supply to the Alarms); or

(b) a separately electrically protected, regularly used local lighting circuit.

Alarms should be connected on a single final circuit, unless the means of interconnection is by radio signals (e.g. RadioLINK).

(See BS 5839-6: 2004 for further information)

Note: The Ei Electronics RadioLINK Base Ei168RC (for use with Ei161RC/164RC/166RC models only) can be used to eliminate interconnect wiring, make system extensions and provide simple and cost effective compliance with BS 5839-6: 2004.

4.1 Mounting & Wiring Alarms

1. Select a location complying with the advice in previous sections (see pages 4-10).
2. Disconnect the AC mains supply from the circuit that is going to be used.
3. Lift off the wiring cover as shown in **Figure 3**.

The house wiring must be connected to the terminal block on the mounting plate as follows:

L: Live - connect to the house wires coloured brown or marked L.

N: Neutral - connect to the house wires coloured blue or marked N.

See page 14 for information on interconnection.

Note: Wiring must be installed in compliance with local regulations.

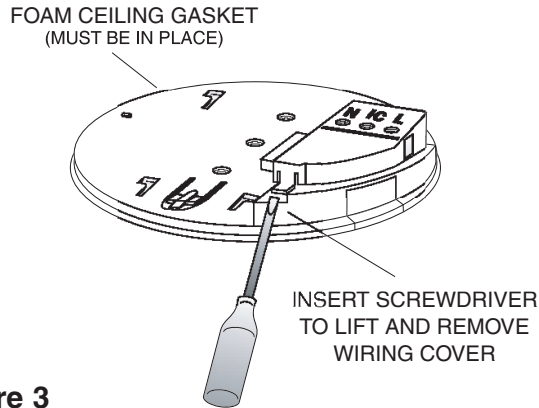

Figure 3

Warning: Mixing the Live and Neutral connections when interconnecting alarms will damage all the alarms - ensure that the same colours are used throughout the premises for Live, Neutral and Interconnect wires.

We strongly recommend that you check for the following **before connecting the alarm:**

- check for Live and Neutral using a two probe tester.
- check for Live using a neon tester.
- check that the Interconnect wire is NOT connected to Live, Neutral or Earth. **Do not use an Earth wire for the Interconnect line.**

N.B. The alarm does not need to be earthed. However the terminal marked is provided for the convenience of the installer so that any copper Earth wire or cable coloured green & yellow, can be safely terminated.

To interconnect the Alarms connect all the IC terminals together as shown in **Figure 4** (see “**Interconnecting Alarms**” section on page 14).

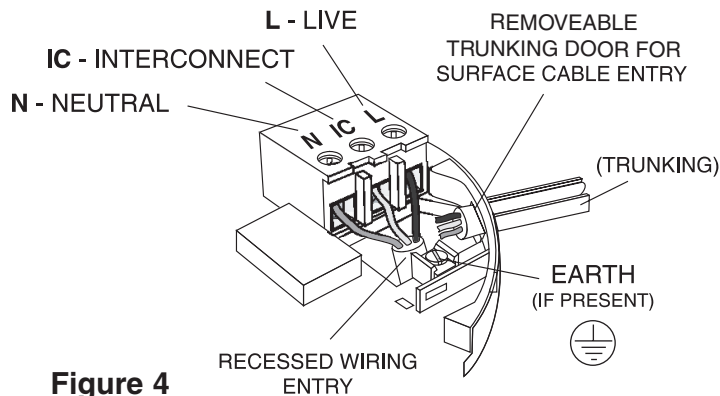

Figure 4

4. If the mains wires are recessed, bring the wires through the rear hole in the mounting plate as shown in **Figure 4**.

If the mains wires are being brought along the surface:

(a) position the mounting plate so the cable trunking is as shown in **Figure 4**.

(b) the mounting plate has a removable section, take it out to interface directly with 25 mm conduit as shown in **Figure 5**. If interfacing to 16 mm conduit carefully cut around the marked section, leaving the top intact and replace the section. (If you are not using surface wiring, the removable section must be left in place for electrical safety reasons).

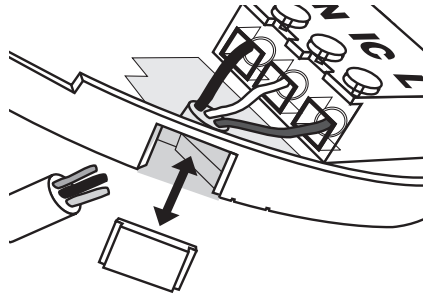

Figure 5

There are two other positions which are also suitable for the surface wiring to enter (and exit) the alarm, one next to the removable section and another directly opposite.

5. Carefully align the mounting plate and screw into place. Connect the wires to the terminal block. With recessed wiring, ensure the rear gasket seals around the edge of the hole in the ceiling or wall. This is to prevent air draughts affecting the smoke/heat entering the alarm. If the hole is too large or the alarm does not seal it, it should be sealed with silicone rubber or equivalent.

6. Replace the wiring cover. Check the alarm battery is connected (Ei141/144/146 only).

7. Carefully line up the unit on the base and slide on.

8. Press and hold the test/hush button for 10 seconds. The horn will sound. Check that any interconnected alarms also sound within this period.

9. Connect the mains power to the alarm circuit. Check the green light is on.

10. Attach the '*Smoke Alarm*' identification label provided to the distribution board to identify the alarm circuit.

11. Attach the '*Mains Smoke / Heat Alarms*' label provided on or near the distribution board and write in date installed and the number of alarms on the circuit.

Ensure the alarm operates correctly - see "**TESTING & MAINTAINING YOUR ALARM**" section on page 4 of the *USER INSTRUCTIONS*.

4.2 Interconnecting Alarms

Note: A maximum of twelve Ei141/144/146/161RC /164RC/166RC Smoke or Heat Alarms may be interconnected along with an Ei128R pattress with relay (see “**ACCESSORIES**” section on page 15).

If you wish to connect more than twelve alarms contact your local distributor (see page 16 for details).

Systems using more than 3 or 4 alarms must be very carefully planned to ensure nuisance alarms are not excessive. e.g. from cooking fumes or steam. The following is suggested:

- A Smoke Alarm Locator Switch (model Ei159 for use with Ei141/144/146) or a Smoke Alarm Control Switch (model Ei1529RC for use with Ei161RC/164RC/166RC) should be incorporated into the system and be readily accessible to all occupants so that the source of an alarm can be quickly identified.
- All alarms must be cleaned and maintained regularly.
- A qualified person must be on call to quickly remove any nuisance units (i.e. units with red light flashing rapidly) which are causing all the other alarms to sound.

WARNING: Do not connect these Alarms to any other type of Ei Alarm (apart from those listed above) or to any other model produced by another manufacturer. Doing so may damage the Alarms and could result in a shock or fire hazard.

Wiring must be installed in compliance with local regulations.

In the UK it is recommended that the following coloured cores are used (for example with triple flat 6243Y cable).

230V supply	Brown
Neutral	Grey - sleeved blue at terminations
Interconnect	Black

Figure 6

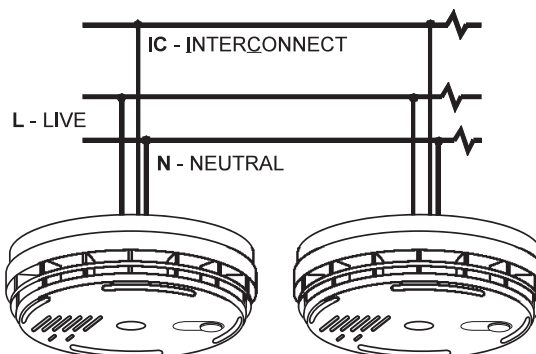

The interconnect wire (minimum 0.75mm² cable) must be treated as if it was Live. It should be insulated and sheathed. A maximum of 250 metres of wire can be used (maximum resistance between detectors 50 Ohms).

These Smoke/Heat Alarms should be interconnected only within the confines of a single family living unit. If they are connected between different units there may be excessive nuisance alarms. Everybody may not be aware that they are being tested or that it is a nuisance alarm caused by cooking etc.

Ensure the alarms operate correctly - see "**TESTING & MAINTAINING YOUR ALARM**" section on page 4 of the *USER INSTRUCTIONS*.

5. ACCESSORIES

Relay Module Ei128R:

The Ei128R module has a relay rated at 250V AC / 5 Amps. This is useful for remote signalling and turning on lights etc. Also available is the Ei128RBU Relay Module which has battery back-up.

Alarm Locator Ei159:

(for use with models Ei141/144/146 only)

The Smoke Alarm locator is recommended for systems with three or more Smoke / Heat Alarms as it helps quickly identify the unit in alarm and reduces the impact of nuisance alarms.

Pressing the Smoke Alarm Locator button will silence all interconnected alarms for 10 minutes, except those sensing fire. It is easily installed between the Interconnect and Neutral terminals.

Alarm System Control Switch Ei1529RC:

(for use with models Ei161RC/164RC/166RC only)

The System Control Switch is recommended for systems with three or more Smoke / Heat Alarms. It allows the user to perform the following functions from a remote location:

LOCATE - If alarms sound press *Locate* to allow source of alarm to be identified.

HUSH - Press *Hush* to silence nuisance alarms.

TEST - Operate weekly to *Test* the alarms.

MAINS CHECK - *Test* will not work with mains absent.

RadioLINK Base Ei168RC:

(For use with models Ei161RC/164RC/166RC only)

The RadioLINK Bases are used to eliminate interconnect wiring, make system extensions and provide simple and cost effective compliance with BS 5839-6: 2004.

An Ei168RC with Ei161RC, 164RC and 166RC Smoke/Heat Alarms allows the units to be remotely tested, silenced and the fire located using the optional Ei411H RadioLINK control switch.

INDEX

1. QUICK GUIDE	1
1.1 INSTALLATION GUIDE	2
1.2 ALARM REMOVAL	3
2. HOW MANY ALARMS TO INSTALL	4
2.1 CATEGORIES OF SYSTEM	4
2.2 SELECTING ALARM TYPE	8
2.3 GRADE D, E & F SYSTEMS	9
3. POSITIONING ALARMS	9
3.1 LOCATIONS TO AVOID	10
4. INSTALLATION	10
4.1 MOUNTING & WIRING ALARMS	11
4.2 INTERCONNECTING ALARMS	14
5. ACCESSORIES	15

Aico Ltd. Mile End Business Park, Maesbury Rd, Oswestry,
Shropshire SY10 8NN, U.K. Tel: 0870 758 4000

www.aico.co.uk

Ei Electronics. Shannon, Co Clare, Ireland. Tel: 061 471277

www.eielectronics.com



230V~ SMOKE & HEAT ALARMS

ALKALINE PRIMARY BATTERY BACK-UP

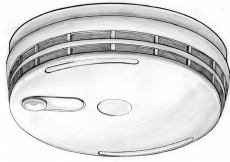

Ei141 - Ionisation

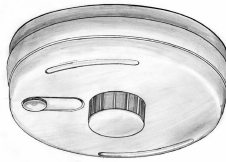

Ei144 - Heat



Ei146 - Optical

RECHARGEABLE LITHIUM CELL BACK-UP



Ei161RC - Ionisation

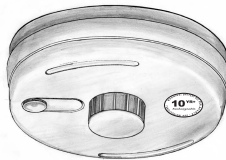

Ei164RC - Heat

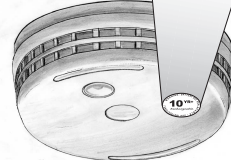

Ei166RC - Optical

INSTALLER INSTRUCTIONS

1. QUICK GUIDE

- ✓

IDEALLY INSTALL IN THE CENTRE OF CEILING AT LEAST 300mm FROM LIGHT FITTINGS
- ✓

LOCATE IONISATION ALARMS AWAY FROM KITCHENS TO PREVENT NUISANCE ALARMS
- ✓

INTERCONNECT ALL ALARMS
- ✓

ENSURE LIVE MAINS IS CORRECTLY CONNECTED TO L TERMINALS ON ALL INTERCONNECTED ALARMS - OTHERWISE UNITS WILL BE DAMAGED
- X

DO NOT FIT ACTUAL ALARM UNTIL ALL BUILDING WORK IS COMPLETED TO AVOID CONTAMINATION. AFTER CHECKING OPERATION, COVER SMOKE ALARM WITH DUST COVER UNTIL REQUIRED FOR USE
- X

DISCONNECT THE ALARM BEFORE APPLYING HIGH VOLTAGE INSULATION TESTS TO WIRING
- X

DO NOT ATTEMPT TO OPEN THE ALARM AS IT IS PERMANENTLY SEALED FOR SAFETY