

# AirTies

## Printing Colors

BACKGROUND'S COLOR



C:60,M:60,Y:40,K:100



C:0,M:85,Y:100,K:0



PANTONE  
432C



PANTONE  
871 C

## Air 4930 Multi Pack Generic QIG (Yellowish) (Printed Material Specification)

Dimension after binding	A6
Pages	12 pages
Cover Printing Color	colour printing
Inner Printing Color	colour printing
Cover page Material	128g copperplate paper
Inner pages Material	128g copperplate paper
Cover Pages Coating	varnishing
Inner pages Coating	varnishing
Binding & Folding Process	Booklet
Output lpi	200 Lpi
Tolerance	L*W:±1mm
PART NUMBER	MP-0000063434

# AirTies

Home **Wi-Fi**  
Solution Kit



**QUICK INSTALLATION  
GUIDE**



## PORTS and BUTTONS

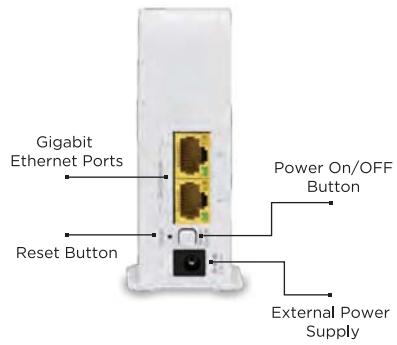

**!** Please remove protective plastic cover from the products before installation.

## TRIPLE and DUAL PACK INSTALLATION

1

Place one of the AirTies Wireless Units **1** close to your gateway / modem / router and connect with Ethernet cable **3**

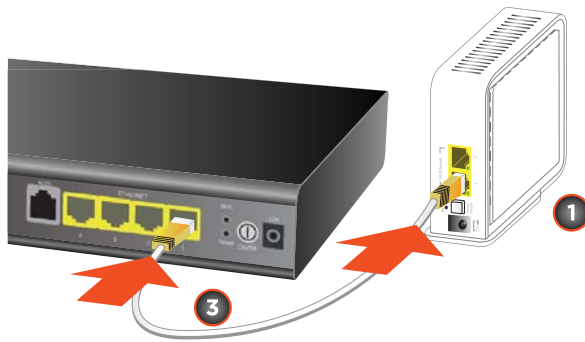

2

Plug one of the power adapters **2** first into the product and then to a power socket. Turn on the unit.

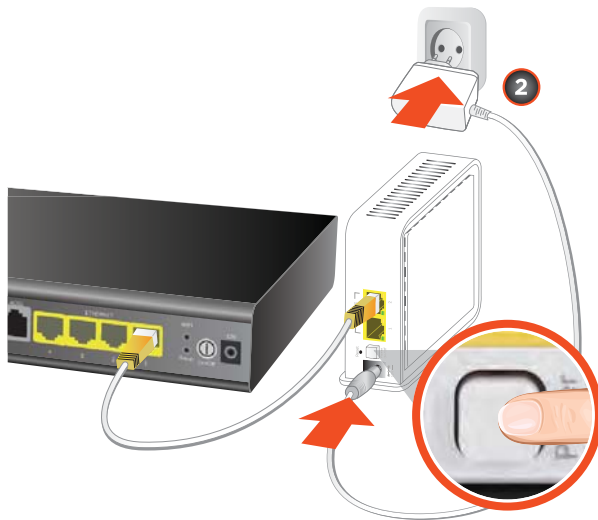

3

After few seconds Power LED will be blinking in white, wait until the power LED becomes solid white.



up to  
3 min.

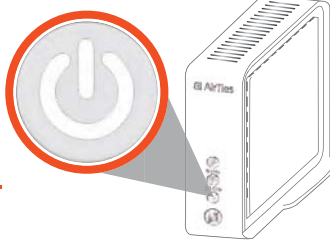

4

To complete the installation please download «**AirTiesWiFi**» application on your mobile device.



AirTiesWiFi



5

Please follow the instructions on your mobile application to complete your setup. This process should take only a couple of minutes.  
You are about to enjoy an amazing Wi-Fi network.

\* If prompted for password, please type in **Wi-Fi Password** printed on the bottom label of the AirTies Wireless Unit.

## ADDITIONAL PACK INSTALLATION

1

Please open «**AirTiesWiFi**» application on your mobile device.

Please follow the instructions on your mobile device to complete your setup. This process should take only a couple of minutes.

You are about to enjoy an amazing Wi-Fi network.



AirTiesWiFi



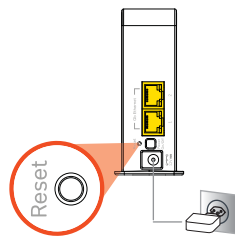

#### NOTES

- Returning to factory settings:

To return unit to factory settings, press down on the reset button (in a small opening on the back) for 5 seconds. A metal paperclip (with an extended tip) or strong toothpick are typically good choices for this task. When the reset process is triggered, the LEDs in the front will temporarily “shimmer” and the unit will reboot (in about 3 minutes) to factory settings.

- If you personalize the network settings, please record them here:

Network Name: .....

Network Password: .....

User Interface Password: .....

- Operational modes:

2.4 GHz: 802.11b, 802.11g, 802.11n (HT20), 802.11n (HT40),

5 GHz : 802.11a, 802.11n (HT20), 802.11n (HT40), 802.11ac (VHT20),  
802.11ac (VHT40), 802.11ac (VHT80)

Hereby, **[AirTies Wireless Networks]** declares that the radio equipment type **[Air 4930]** is in compliance with **Directive 2014/53/EU**.

The full text of the EU declaration of conformity is available at the following internet address:  
**<http://www.airties.com/declarations-of-conformity.html>**

## TIPS FOR BEST PERFORMANCE:

- Keep units away from:
  - Potential sources of electrical interference. Equipment that potentially cause interference include ceiling fans, home security systems, microwaves, PCs, and cordless phones (handset and base).
  - Large metal surfaces and objects. Large objects and wide surfaces such as glass, insulated walls, fish tanks, mirrors, brick, and concrete walls can also weaken wireless signals.
  - Sources and areas of heat such as ovens and sun rooms as well as direct sun light even if there is good air conditioning.
- Please make sure to remove the protective plastic covers used on the device before first use
- Please use device upright position. The openings are provided for ventilation, do not block or cover openings.
- Your device is designed to work indoors and under room temperature conditions only. Avoid placing the device to very cold, very hot, very humid or very dry locations inside your home.”
- Maximum power consumption of networked standby mode is 6.3 W.
- This product has an overheating protection mechanism which may be enabled automatically when the product overheats due to abnormal ambient conditions or use cases. In such cases 2.4 and 5 GHz LEDs will blink RED for about 20 seconds and the product will go to standby mode. The product will not be in use during this time and it will turn on automatically once the temperature goes down to regular operating temperatures.
- In such a case, please change the operating condition of the device based on the instructions above.

This product makes use of software developed by the open source community. Any such software is licensed under the specific license terms applicable to that particular software (like GPL, LGPL, etc). Detailed information on the applicable licenses and license terms can be found on the device's user interface.



By using this product, you acknowledge that you have reviewed such license terms and that you agree to be bound by them. Where such terms entitle you to the source code of said software, that source code will be made available at cost upon request from AirTies.

To obtain a copy of said source code, please send your request in writing via email to [osrb@airties.com](mailto:osrb@airties.com) or via snail mail to:

**AirTies Wireless Communications**  
Mimar Uluoğlu Sokak No. 23 Esentepe,  
P.K. 34394 Şişli İSTANBUL/Turkey

AirTies will mail to you a CD with the requested source code at the cost of CD preparation and shipping&handling. For details please contact [osrb@airties.com](mailto:osrb@airties.com)

## TROUBLESHOOTING

LED Indicators	Condition	LED Color	LED Behavior	Timing
 <b>Power</b>	Power OFF	(OFF/Dark)	-	
	Power ON	White	Solid (No blinking)	
	Device is not ready	White	Blinking	
 <b>5 GHz</b>	WLAN is active and the node has an active strong Mesh connection on the Radio	Green	Blinking	50ms OFF 5000ms ON
	WLAN is active and all Mesh links on the Radio are weak	Red	Solid (No blinking)	
	Radio is inactive or Searching for radar activity	(OFF/Dark)		
	WPS is in progress	Green	Blinking in sync	
	WPS is successful	Green	Solid (No blinking)	
 <b>2.4 GHz</b>	Unconfigured device	Green	Blinking in sync	4000ms OFF 4000ms ON
	WLAN active, Device configured, No Mesh link on the Radio	Green	Solid (No blinking)	
	There is configured Mesh connection on the radio, however connection is inactive (Can not connect)	Red	Blinking	1000msec OFF 1000msec ON
	WPS is not successful	Red		

State Identifier	Explanation	Recommended Action(s)
A		Power the device on if desired. No other action required.
B		No action required. If unit was just powered on, then please wait for at least 2 minutes for the unit to complete its boot process.
C		No action required. Please wait.
D		No action required.
E		Bring device closer to another device on the Mesh network.
F		No action required.
G		No action required.
H	This behavior is temporary and lasts for about 5 seconds, after which the LEDs go to one of the following states: 1) Mesh with strong signal (state D), 2) Mesh with poor signal (state E)	If LED is red (state E) then bring device closer to another device on the Mesh network.  If LED is green (state D), then no action is required.
I	Device has factory setting and is not connected to the home network in any way (e.g., the device is not wired to the router- gateway)	Configure device (refer to Quick Installation Guide)
J	First AP (wired to router-gateway)	No action required.
K	AP is part of Mesh but unable to find any of its Mesh partners.	Make sure other device(s) that are part of the Mesh network are powered on and close enough to connect.
L	This behavior is temporary and lasts for about 5 seconds, after which the LEDs go back to the state the device was in before the WPS attempt	On failure, repeat WPS attempt after bringing device near another device that is already on the Mesh network (i.e., in state D).

For more information:  
<http://www.airties.com/products>

AT	BE	BG	CH	CY	CZ	DE	DK
EE	ES	FI	FR	GB	HU	IE	IS
IT	LT	LU	NL	NO	PL	PT	SE
SI	SK	TR	US				

CE  
FCC  
FCC ID: Z3WAIR4930

MP-0000063434



REV28072017