



WipLL Radio Technology - Physical Layer

The WipLL system provides wireless, local-loop connectivity between the provider's IP-based backbone and the subscriber. This radio link is established between WipLL transceivers located at the Base Station and subscriber sites.

This chapter discusses the following radio frequency (RF) physical layer issues related to the WipLL system:

- Frequency Hopping Spread Spectrum
- Modulation
- Frequency Bands
- Standards Compliance
- WipLL RF Antennas
- Radio Planning

2.1. Frequency Hopping Spread Spectrum

The WipLL system implements frequency-hopping code division multiple access (FH-CDMA) spread spectrum modulation for digital signal transmission over the air between the Base Station and the subscriber site. The WipLL system's frequency hopping supports a channel bandwidth of 1 MHz or 1.33 MHz, and channel spacing of 1 MHz (or 1.75 MHz if operating in the 3.5 GHz band).

Frequency hopping is a basic modulation techniques used in spread spectrum signal transmission. Spread spectrum enables a signal to be transmitted across a frequency band that is much wider than the minimum bandwidth required by the information signal. The transmitter "spreads" the energy, originally concentrated in narrowband, across a number of frequency band channels on a wider electromagnetic spectrum.

In an FH-CDMA system, a transmitter "hops" between available frequencies according to a specified algorithm, which can either be random or predefined (see Figure 2-1). The transmitter operates in synchronization with a receiver, which remains tuned to the same center frequency as the transmitter. A short burst of data is transmitted on a narrowband signal. The transmitter then tunes to another frequency, and transmits again. Therefore, the receiver is capable of hopping its frequency over a given bandwidth several times a second (20 hops per second in the WipLL system), transmitting on one frequency for a certain period of time, then hopping to another frequency and transmitting again. The WipLL system supports a hopping speed of 50 msec hopping intervals.

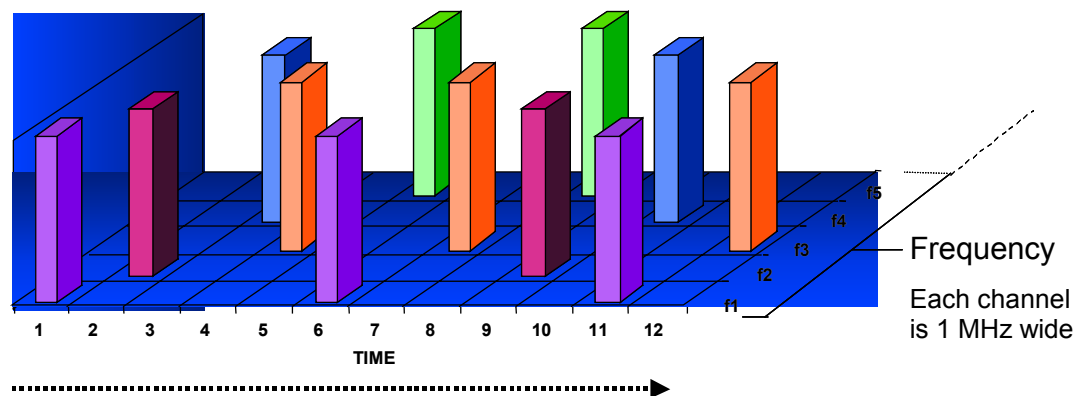

Figure 2-1: An example of Frequency Hopping Spread Spectrum

The advantages of implementing FH-CDMA in the WipLL system include the following:

- Frequency Hopping Spread Spectrum (FHSS) is based on interference avoidance. Narrow band interference that does not meet the SNR blocks only a few hops, decreasing the throughput only partially.
- The required spectrum for an FHSS system is flexible in that it does not have to be contiguous.
- FHSS can coexist with other systems in the same spectrum band.
- To intercept transmission, a receiver must “know” the hopping sequence therefore, FHSS ensures security.
- Frequency diversity copes with the frequency selective fading and multipath.

The RF channel obtained by the WipLL operator is divided into n 1-MHz sub-channels, with center frequencies located at integer multiples of 1 MHz (see Figure 2-2). These sub-channels are organized into a set of orthogonal hopping sequences. Several methodologies are available for creating these sequences, depending on available spectrum and local regulations.

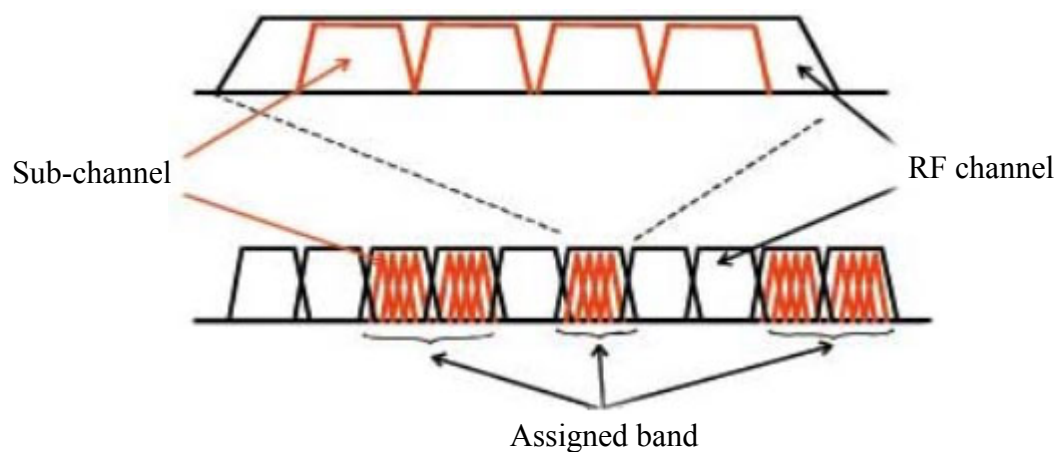

Figure 2-2: Relationship between “sub-channel”, “RF channel”, and “assigned channel”

Table 2-1 shows an example of six orthogonal sequences that can be derived from seven sub-channels.

Table 2-1: Example of six orthogonal FH sequences

Sequence No.	Sub-channels (frequencies)						
1	0	1	2	3	4	5	6
2	0	2	4	6	1	3	5
3	0	3	6	2	5	1	4
4	0	4	1	5	2	6	3
5	0	5	3	1	6	4	2
6	0	6	5	4	3	2	1

Up to 32 such sequences, each with up to 99 sub-channels can be pre-configured in the WipLL ROM. An additional 32 sequences can be configured by the WipLL operator in the RAM to provide further flexibility.

2.2. Modulation

The WipLL system is based on Continuous Phase Frequency Shift Keying (CPFSK) modulation. Frequency Shift Keying uses m different frequencies for m symbols. The simplest FSK is binary FSK, where 0 and 1 correspond to different frequencies:

$$S(t) = \begin{cases} A_c \cos(2\pi f_1 t) & m(nT_b) = 1 \\ A_c \cos(2\pi f_2 t) & m(nT_b) = 0 \end{cases}$$

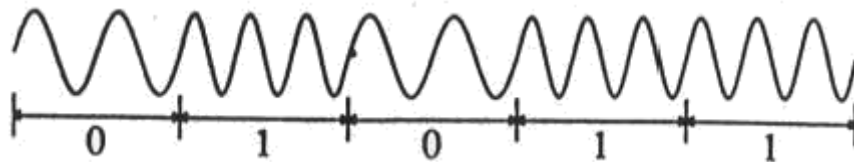

Figure 2-3: Graph displaying different frequencies for 0 and 1 bits

FSK is similar to non-linear analogue FM, but with digital modulation.

FSK provides the following benefits:

- Non-coherent detection is possible - no carrier synchronization is required.
- Immunities to non-linearity - the envelope contains no information and, therefore, can be hard-limited; information is carried by zero crossings:
 - Can be used with non-linear power amplifiers
 - Better efficiency

The FSK phase can be discontinuous or continuous, as displayed in Figure 2-4.

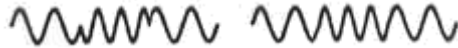

Figure 2-4: FSK phase: discontinuous (left wave); continuous (right wave)

Continuous wave is more natural than discontinuous and provides the following advantages:

- Smaller bandwidth (discontinuous wave causes high frequency components)
- Operates better when transmission link has non-linearities

2.3. Frequency Bands

WipLL provides a Wireless Local Loop (WLL) solution in the following frequency bands:

■ **Licensed bands:**

- 700 MHz (698 – 746 MHz)
- 2.5 GHz (MMDS)
- 2.8 GHz (TDD)
- 3.3 to 3.8 GHz TDD/FDD (50 or 100 MHz duplex separation)

■ **Unlicensed bands:**

- ISM 900 MHz (902 MHz to 928 MHz)
- ISM 2.4 GHz (TDD)
- 5.8 GHz (TDD)

For details on specific WipLL products, see Appendix B.

2.4. Standards Compliance

Table 2-2 lists standards to which WipLL complies.

Table 2-2: WipLL standards compliance

Standard	Compliance
EMC	<ul style="list-style-type: none">• 700 MHz: FCC part 27• 900 MHz: FCC part 15• 2.4 GHz: ETS 300 826; FCC part 15• MMDS: FCC part 21• 3.5 GHz: EN 300 385; EN 300 386-2; ETS 300 132-2• 5.8 GHz: FCC part 15
Radio	<ul style="list-style-type: none">• 700 MHz: FCC part 27• 900 MHz: FCC part 15• 2.4 GHz: EN 300 328-1; FCC part 15; RSS 139; Telec• MMDS: FCC part 21• 3.5 GHz: EN 301 253• 5.8 GHz: FCC part 15
Safety	UL 1950, EN 60950
Environmental	ETS 300 019

2.5. WipLL RF Antennas

WipLL provides a variety of internal antenna types as well as an option for connecting off-the-shelf, third-party external antennas. Table 2-3 provides a general description of the WipLL RF antenna parameters.

Table 2-3: WipLL RF antenna specification

Parameter	Description
Antenna type	<ul style="list-style-type: none"> • Integral flat-printed antenna: for BSR, PPR, SPR, and IDR devices: No RF cable is involved for connection between BSR and SPR. The interface between outdoor radio unit-to-indoor unit (ODU-to-IDU) is by CAT-5 cable. • Integral narrow-beam antenna: for the BSR device operating in the 3.5 GHz band. • Integral high-gain antenna: for SPR and PPR devices operating in the 3.5 GHz and 2.4 GHz bands.
Polarization	Vertical (Horizontal polarization is optional for SPR at 3.5 GHz)
ETSI compliant	EN 302 085, Class CS1 for the BSR, and TS2 for the SPR
Receive diversity	Supported in single BSR through dual integral antennas
External third-party antennas (optional)	<p>Connects to BSR, PPR, and SPR using an N-type connector. Connects to IDR using a TNC connector. Provides further flexibility for the WipLL operator to improve link budget or cost-effectiveness of the Base Station. For example, an omni-directional antenna for 360° coverage can be implemented by a single BSR.</p> <p>For BSRs operating in the 700 MHz or 900 MHz bands, two N-type connectors are provided for attaching two external third-party antennas for dual antenna diversity at the WipLL Base Station. When operating in the 700 MHz band, the BSR is supplied with a panel-type antenna; the SPR model with a yagi-type antenna</p>



Notes: Devices with external antennas do not contain built-in (internal) antennas.

2.5.1. WipLL Internal Antenna Specifications

Table 2-4, Table 2-5, Table 2-6, and Table 2-7 list the internal antenna specifications of the BSR, PPR, SPR, and IDR devices, respectively.

Table 2-4: BSR (Base Station) antenna specifications

BSR Type	Parameter						
	Frequency range (MHz)	Gain (dBi)	Beam width H X V (degrees)	Polarization	VSWR	Impedance (ohm)	Front-to-back ratio (dB)
900 MHz	902 - 928	8	60 x 60	Vertical	1:1.5	50	25
2.4 GHz	2,400 -2,500	11	60 x 25	Vertical	1:1.5	50	25
MMDS	2,500 - 2,690	11	65 x 22	Vertical	1:1.6	50	25
2.8 GHz	2,700 - 2,900	11	60 x 23	Vertical	1:1.5	50	25
3.x GHz	3,300 - 3,800	12	60 x 17	Vertical	1:1.5	50	25
Narrow-beam 3.x GHz	3,400 -3,700	18	16 x 18	Vertical	1:1.5	50	30
5.8 GHz	5,725 - 5,875	12	60 x 15	Vertical	1:1.5	50	25

Table 2-5: PPR (Base Station) antenna specifications

PPR Type	Parameter						
	Frequency range (MHz)	Gain (dBi)	Beam width H X V (degrees)	Polarization	VSWR	Impedance (ohm)	Front-to-back ratio (dB)
2.4 GHz	2,400 -2,500	18	19 x 25	Vertical	1:1.6	50	28
3.x GHz	3,400 -3,700	18	16 x 18	Vertical	1:1.5	50	30
5.8 GHz	5,725 - 5,875	12	60 x 15	Vertical	1:1.5	50	25

Table 2-6: SPR (CPE – outdoor unit) antenna specifications

SPR Type	Freq. range (MHz)	Gain (dBi)	Beam width H X V (deg.)	Polarization	VSWR	Impedance (ohm)	Front-to-back ratio (dB)
700 MHz	710 - 716 & 740- 746	8	60 x 60	Vertical	1:1.6	50	20
900 MHz	902 - 928	8	60 x 60	Vertical	1:1.9	50	23
2.4 GHz	2,400 - 2,500	15	24 x 33	Vertical	1:1.6	50	28
High-gain 2.4 GHz	2,400 - 2,500	18	19 x 25	Vertical	1:1.6	50	28
MMDS	2,500 - 2,690	15	21 x 29	Vertical	1:1.6	50	25
2.8 GHz	2,700 - 2,900	15	21 x 30	Vertical	1:1.6	50	25
3.5 GHz	3,400 - 3,600	15	18 x 28	Vertical/ Horizontal	1:1.6	50	25
High-gain 3.5 GHz	3,400 - 3,600	18	16 x 18	Vertical	1:1.6	50	25
5.8 GHz	5,725 - 5,875	16	21 X 12	Vertical	1:1.6	50	25

**Notes:**

- 1) The SPR 700 MHz and 900 MHz models have larger dimensions than the standard SPR models. Their dimensions are the same as that for the BSR.
- 2) The SPR 3.5 GHz and SPR 2.4 GHz models are available in large and standard (smaller) dimensions (chassis). The dimensions (i.e., large or small) affect the antenna gain.
- 3) The 700 MHz internal antenna covers only 710 - 716 MHz and 740 - 746 MHz (i.e. Band C). To cover the entire band of 698 – 746 MHz, an external antenna is used (see Section 2.5.2^{td}).

Table 2-7: IDR (CPE - indoor unit) antenna specifications

IDR Type	Freq. range (MHz)	Gain (dBi)	Beam width H X V (deg.)	Polarization	VSWR	Impedance (ohm)	Front-to-back ratio (dB)
900 MHz	902 - 928	8	67 x 93	Vertical	1:1.9	50	-17
2.4 GHz	2,400 to 2,500	10	65 x 32	Vertical	1:1.6	50	25
3.5 GHz	3,400 to 3,600	10	65 x 32	Vertical	1:1.6	50	25

2.5.2. WipLL External Antennas

WipLL provides options to attach external antennas when operating in the 700 and 900 MHz bands.

2.5.2.1. 900 MHz

The WipLL BSR and IDR devices operating in the 900 MHz band, provide N-type receptacles for connecting external antennas. The BSR provides two N-type receptacles (for antenna diversity), and the IDR provides one TNC-type receptacle.

This document lists the specifications of these external antennas intended for the BSR and IDR devices.

2.5.2.1.1. BSR External Antennas

Airspan provides the following external antennas for BSR devices operating in the 900 MHz band:

- Sector antenna
- Omnidirectional antenna

2.5.2.2. Sector Antenna

This antenna is designed for best non-line of sight performance with Airspan's BSR operating in the 900 MHz band. Advanced features include: high gain and mechanical downtilt.

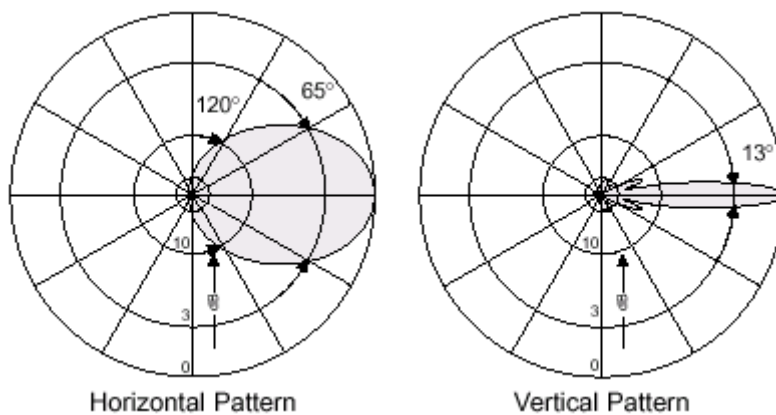

Electrical specifications	
Frequency range	870 –960 MHz
Polarization	Vertical
Gain	15.5 dBi
Half-power beam width	<ul style="list-style-type: none"> • H-plane:65° • E-plane:13°
Front-to-back ratio	>25 dB
Impedance	50 .
VSWR	<1.3
Intermodulation IM3 (2 x 43 dBm carrier)	<-150 dBc
Max.power	500 W (at 50 °C ambient temperature)
Mechanical specifications	
Input	7-16 female
Connector position	Bottom

Weight	6 kg
Wind load	<ul style="list-style-type: none"> • Frontal: 220 N (at 150 km/h) • Lateral: 140 N (at 150 km/h) • Rearside: 490 N (at 150 km/h)
Max.wind velocity	200 km/h
Packing size	1422 x 272 x 160 mm
Height/width/depth	1294 /258 /103 mm

2.5.2.2.1. Omnidirectional Antenna

This antenna is designed for best non-line of sight performance with Airspan's BSR operating in the 900 MHz band.

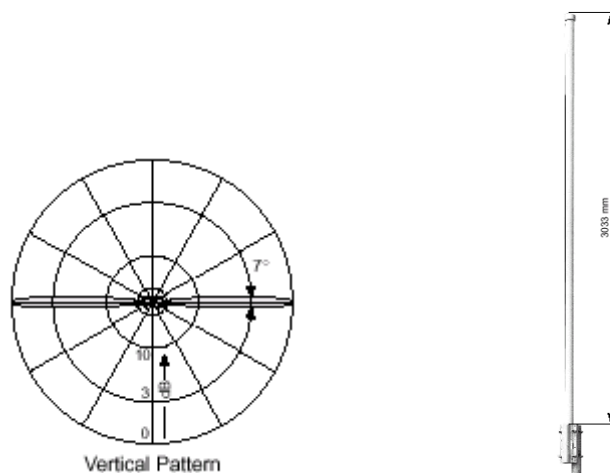

Electrical specifications	
Frequency range	870 – 960 MHz
Polarization	Vertical
Gain	11 dBi
Impedance	50Ω
VSWR	<1.5
Intermodulation IM3 (2 x 43 dBm carrier)	<-150 dBc
Max. power	500W (at 50 °C ambient temperature)

Mechanical specifications		
Model Type	736 347	736 348
Input	7-16 female	7-16 female
Connector position	Bottom	Top
Weight	8 kg	
Radome diameter	51 mm	
Wind load	210 N (at 150 km/h)	
Max.wind velocity	200 km/h	
Packing size	3316 x 148 x 112 mm	
Height/width/depth	3033 mm	3022 mm

2.5.2.3. IDR External Antennas

Airspan provides one of the following external antennas for the IDR device operating in the 900 MHz band:

- 10 dBi Panel antenna
- 6.5 dBi Panel antenna

2.5.2.3.1. 10 dBi Panel

Electrical				
Frequency range	902 - 928 MHz			
Gain	10 dBi (min)			
VSWR	1.5:1 (max)			
3 dB Beamwidth (related to vertical polarization)	<ul style="list-style-type: none"> • Azimuth: 65 (typ) • Elevation: 55 (typ) 			
Polarization	Linear (Vertical or Horizontal)			
Sidelobes level	-18dB (max) @ +/-90			
Cross polarization	-14dB (max)			
F/B ratio	-20dB (max)			
Input impedance	50 (ohm)			
Input power	6W (max)			
Lightning protection	Non			
Mechanical				
Dimensions (LxWxD)	305x305x25 mm (max)			
Weight	1.5 kg (max)			
Connector	N-Type Female			
Radome	Plastic			
Base plate	Aluminum with chemical conversion coating			
Mounting kit	MT-120018			
Environmental				
Test	Standard	Duration	Temperture	Notes
Low temperature	IEC 68-2-1	72 h	-55°C	-
High temperature	IEC 68-2-2	72 h	+71°C	-
Temp. cycling	IEC 68-2-14	1 h	-45°C +70°C	3 Cycles
Vibration	IEC 60721-3-4	30 min/axis	-	Random 4M3
Shock mechanical	IEC 60721-3-4	-	-	4M3
Humidity	ETSI EN300-2-4 T4.1E	144 h	-	95%
Water tightness	IEC 529	-	-	IP67

Solar radiation	ASTM G53	1000 h	-	-
Flammability	UL 94	-	-	CLASS HB
Salt spray	IEC 68-2-11 Ka	500 h	-	-
Ice and snow	-	-	-	25mm radial
Wind speed survival Operation	-	-	-	220 Km/h 160 Km/h
Wind load (survival):	-	-	-	<ul style="list-style-type: none"> • 26.8 kg • 2.2 kg
<ul style="list-style-type: none"> • Front thrust • Side thrust 				

2.5.2.3.2. 6.5 dBi Panel

Electrical	
Frequency range	902-928 MHz
Gain	6.5 dBi (min)
VSWR	1.5:1 (max)
3 dB Beamwidth	<ul style="list-style-type: none"> • Azimuth • Elevation
<ul style="list-style-type: none"> • 80° (typ) • 80° (typ) 	
polarization	Linear (Vertical or Horizontal)
Cross polarization	-14dB (max)
F/B ratio	-11dB (max)
Input impedance	50 (ohm)
Input power	6W (max)
Lightning protection	NON
Mechanical	
Dimensions (LxWxD)	190x190x30 mm (max)
Weight	0.7kg (max)
Connector	N-Type Female
Radome	Plastic
Base plate	Aluminum with chemical conversion coating
Outline drawing	RD41245600C
Mounting kit	MT-120018/A

Environmental				
Test	Standard	Duration	Temperture	Notes
Low temperature	IEC 68-2-1	72 h	-55°C	-
High temperature	IEC 68-2-2	72 h	+71°C	-
Temp. cycling	IEC 68-2-14	1 h	-45°C +70°C	3 Cycles
Vibration	IEC 60721-3-4	30 min/axis	-	Random 4M3
Shock mechanical	IEC 60721-3-4	-	-	4M3
Humidity	ETSI EN300-2-4 T4.1E	144 h	-	95%
Water tightness	IEC 529	-	-	IP67
Solar radiation	ASTM G53	1000 h	-	-
Flammability	UL 94	-	-	Class HB
Salt spray	IEC 68-2-11 Ka	500 h	-	-
Ice and snow	-	-	-	25mm radial
Wind speed survival Operation	-	-	-	220 Km/h 160 Km/h
Wind load (survival):	-	-	-	-
<ul style="list-style-type: none"> • Front thrust • Side thrust 				<ul style="list-style-type: none"> • 10 kg • 1.6 kg

2.5.2.4. Considerations for WipLL 700

For most of the frequency bands, WipLL products provide a variation of models consisting of internal and external antennas. The internal antennas of all WipLL products, except for WipLL 700, cover all frequency bands.

WipLL 700's internal antenna covers only Band C (i.e., 710 to 716 MHz, and 740 to 746 MHz) frequency band. Therefore, for WipLL 700, Airspan provides an external antenna, allowing coverage in the entire 700 MHz band (698 to 746 MHz), including the licensed A and B bands used in USA.

2.5.2.5. External Antennas

For most bands, WipLL products allow connection of a large variety of external antennas. However, WipLL 700 provides a limited variation of external antennas, including, amongst others, the following:

- 90° panel or omnidirectional (for BSR)
- 14-element yagi antenna (for SPR)

These external antennas can be supplied by Airspan. The external antennas connect to the WipLL devices by an N-type connector.

2.5.2.6. RF Planning Guidelines for Band C in FCC Market

Some operators (e.g., in the USA) have licenses for Band C (710 – 716 MHz and 740 – 746 MHz). When operating in Band C, WipLL 700 allows a maximum of four BSRs at a Base Station (according to FCC regulations). This is to reduce RF interference with other radio devices that may be operating in nearby frequencies.

With the **1 Msps** mode, the center frequencies are 711.5, 712.5, 713.5, 714.5, 741.5, 742.5, 743.5, and 744.5. Thus, the frequency allocation for four BSRs (i.e., sectors) is **711.5, 741.5, 714.5, and 744.5**.

With the **1.33 Msps** mode, the center frequencies are 712, 713, 714, 742, 743, and 744. Thus, the frequency allocation for four BSRs (i.e., sectors) is **712, 742, 714, and 744**.

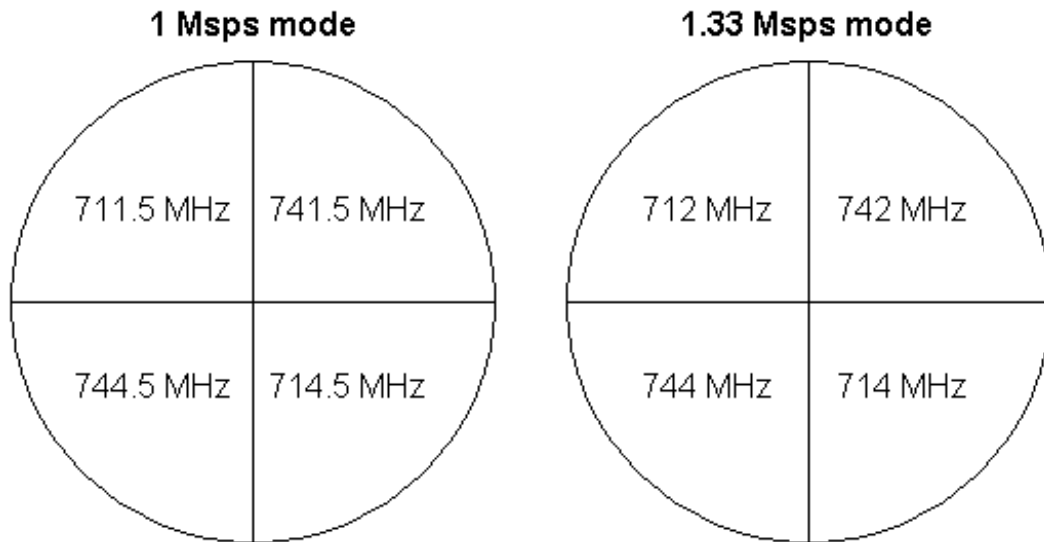

Figure 2-5: Frequency allocation in a four-sector Base Station

Radio interference may occur between the BSRs operating in the upper frequency range (i.e., 742 MHz and 744 MHz) and the lower frequency range (i.e., 712 MHz and 714 MHz). To overcome this interference, a **1-meter vertical separation** is recommended between the BSRs operating in the upper frequency and the BSRs operating in the lower frequency.

2.5.2.7. Specifications

Table 2-4 and Table 2-6 list the external antenna specifications for BSR and SPR devices operating in the 700 MHz band.

Table 2-8: BSR 700 MHz external antennas

External antenna type	Parameter	Value
90° panel	Frequency Range (MHz)	698 - 746
	Gain (dBi)	14
	Beam Width H X V (degrees)	90 x 20
	Polarization	Vertical
	VSWR	< 1.4
	Impedance (ohm)	50
	Front-to-Back Ratio (dB)	> 25
Omnidirectional	Frequency Range (MHz)	698 - 746
	Gain (dB)	7.5
	Beam Width H X V (degrees)	360 x 20
	Polarization	Vertical
	VSWR	1.5
	Impedance (ohm)	50

Table 2-9: SPR 700 MHz external yagi antenna

Parameter	SPR 700 MHz
Frequency Range (MHz)	698 - 746
Gain (dBi)	13
Beam Width H X V (degrees)	32 x 32
Polarization	Vertical/horizontal
VSWR	< 1.8
Impedance (ohm)	50
Front-to-Back Ratio (dB)	> 15

2.6. Radio Planning

WipLL radio planning can be divided into the following areas:

- Main technical parameters
- Coverage analysis
- Interference analysis: FDD vs. TDD
- Frequency allocation: Synchronized vs. Unsynchronized operation
- Capacity considerations
- Selecting appropriate mode of operation
- Radio Planning software tool

2.6.1. Main Technical Parameters

The main technical parameters required for RF planning for WipLL are summarized in Table 2-10.

Table 2-10: Radio specifications

Parameter	Value
Radio Technology	FH-CDMA
Multiple Access Method	Proprietary Adaptive TDMA protocol (Preemptive Polling Multiple Access – PPMA)
Output Power	27 dBm for all models, except for the following: <ul style="list-style-type: none"> • WipLL 700: 32 dBm • WipLL 900: 30 dBm (but when operating in countries complying with FCC, max. is 23 dBm)
Sub-Channel Spacing	1 MHz or 1.75 MHz (1.75 MHz is possible only for devices operating in the 3.5 GHz band)
Symbols per second (Mps)	Two modes are supported: <ul style="list-style-type: none"> • 1 Mps, or • 1.33 Mps
Sub-Channel bandwidth (measured at 20 dB attenuation point)	1 MHz or 1.33 MHz, depending on the selected mode
Modulation	Multilevel (2, 4, or 8) CPFSK ¹
Receiver Sensitivity (BER 1E-6 at 2/4/8 FSK)	-90/ -83/ -75 dBm
SNR Thresholds (BER 1E-6 at 2/4/8 FSK)	12/ 20/ 28 dB
Interference Rejection Factor for 1.33 Mps mode (1 Mps mode): <ul style="list-style-type: none"> • ± 1 MHz • ± 2 MHz • ± 3 MHz 	<ul style="list-style-type: none"> • 5 dB (7 dB) • 30 dB (40 dB) • 52 dB (53 dB)

¹ The intermediate 4-FSK modulation is not supported when 1.33 Mps mode is selected

Parameter	Value
<ul style="list-style-type: none">• ± 4 MHz• ± 5 MHz	<ul style="list-style-type: none">• 58 dB (60 dB)• 63 dB (64 dB)
Receiver Noise Figure	10 dB

2.6.2. System Coverage

System coverage includes the following:

- Line of sight (LOS)
- Link Budget

2.6.2.1. Line of Sight

Usually, WipLL requires the existence of a line of sight (LOS) between the base station transmitter and the subscriber's receiver (near line of sight [NLOS] may be possible to a limited extent for ranges of a few hundred meters). Therefore, the availability of LOS (clear first Fresnel Zone) should be estimated during CPE installation or preferably during network planning. Recommended propagation models used in coverage analysis are based on free-space propagation with compensation for ground and irregular terrain reflections and diffraction. Specific propagation model names vary between different software tools. The model should also include a certain level of fade margin, as discussed in the next section.

2.6.2.2. Link Budget

The coverage analysis of WipLL includes the analysis of the power balance between the transmitter and the receiver, threshold considerations, margins, reserves, and certain statistics of the system. Therefore, the lead-in reception level is measured by the following equation:

$$\mathbf{Rx} = \mathbf{T_x} - \mathbf{LossTx} + \mathbf{AntGainTx} - \mathbf{PathLoss} + \mathbf{AntGainRx} - \mathbf{LossRx}$$

Where,

Rx = Reception level in dBm

Tx = Transmitter power in dBm (27 dBm in the WipLL system)

LossTx = Transmitter losses in dB (0 dB in the WipLL system)

LossRx = Terminal receiver losses in dB (0 dB in the WipLL system)

AntGainTx = Transmitter antenna gain

AntGainRx = Receiver antenna gain in dBi (decibels referenced to isotropic radiator)

PathLoss = Propagation loss in dB



Note: Both the base station and the subscriber site can serve as transmitter or receiver. For downlink budget, the transmitter is the base station and the receiver is the subscriber; and vice versa for the uplink budget.

2.6.2.2.1. Propagation loss

Propagation is the dispersal of the signal into space as it leaves the antenna. The loss of this propagation depends on the signal path between the transmitter and the receiver. Obstructions in the signal path such as trees and buildings can cause signal degradation. Several models simulate signal attenuation along this path.

Propagation loss should incorporate fading margins to compensate different phenomenon such as multipath shadowing and climatic behavior of the waves. Based on this, the parameter path loss can be represented by

$$\text{PathLoss} = L + \text{Fade Margin.}$$

■ Free Space model:

Free space propagation loss is valid where the first Fresnel Zone is clear. In this case, free space propagation loss is given by the following equation:

$$L_{FS} = 32.44 + 20\log d_{[km]} + 20\log f_{[MHz]}$$

■ Fade Margin:

Fade margin further introduces fading factor to the propagation loss to cover the different signal fading and shadow effects, as well as the degradation caused by interferences. The fading factor depends on the time availability parameter defined by the operator, and should be calculated according to the ITU 530 model for 99.9% availability.

For simplicity purposes, the ITU model can be replaced by a 10 dB Flat fade margin as a rough estimation.

■ Rainfall:

Radio signals are attenuated by moisture in the atmosphere. The level of attenuation varies with carrier frequency, the quantity of rainfall, and the distance from the transmitter to the receiver. The variation of attenuation with frequency is particularly strong and highly non-linear. At 3 GHz, the highest attenuation is about 0.06 dB/Km; for a typical WLL path of, for example, 6 Km, the attenuation is only 0.36 dB. Therefore, for the purpose of link budget, we can assume that the impact of rainfall is negligible.

2.6.2.2.2. Link Budget Results

Based on the previous formulas mentioned in the above sections, the following link budget results can be obtained for 99.9% availability:

Modulation	Rate (Mbps)	Range (in km)					
		2.4 GHz ²	MMDS (2.5 GHz)	3.5 GHz	5.8 GHz	900 MHz	700 MHz
8 FSK	3 or 4	8	8	7	6	8	15
4 FSK	2	11	11	10	8	11	22
2 FSK	1 or 1.33	14	14	13	11	15	28



Note: Link budget is calculated for the standard integrated WipLL antennas. Where required, the range can be increased by the implementation of external antennas.

2.6.3. Interference Analysis

Interference analysis should be based on parameters defined in Section 2.6.1, “Main Technical Parameters” to determine the downlink and uplink carrier-to-interference ratio (C/I). The C/I is a key factor in determining the supported modulation for each link. Thresholds for C/I for the different modulations are mentioned in Section 2.6.1, “Main Technical Parameters”.

Interference analysis depends on the duplex scheme implemented in the system. Since WipLL supports both FDD and TDD, different considerations should be applied.

² Although the transmitter is capable of transmitting 27 dBm, in most cases the EIRP in the ISM band is limited by local regulations. For example, ETSI limits the EIRP to 20 dBm, FCC to 36 dBm, and TELEC to 27 dBm. The link budget calculated here assumes no limit.

2.6.3.1. FDD vs. TDD

Frequency Division Duplex (FDD) interference analysis is relatively simple. The frequency separation between downlink and uplink (50 to 100 MHz) enables Airspan to conduct downlink and uplink interference analysis independently.

However, in Time Division Duplex (TDD), since Tx and Rx are not synchronized, cross-link interference, for example, between a transmitting BSR and an adjacent receiving BSR, may result. It is expected that these interferences will be dominant in the TDD mode.

The major consequence of this are the different limitations imposed on frequency separation between adjacent BSRs:

- **FDD:** 2 MHz
- **TDD:** 4 MHz

The required separation is a function of the isolation between co-located antennas. The 4-MHz separation is based on 60 dB isolation. Based on this, a simple frequency allocation for a stand-alone cell is presented in Figure 2-6.

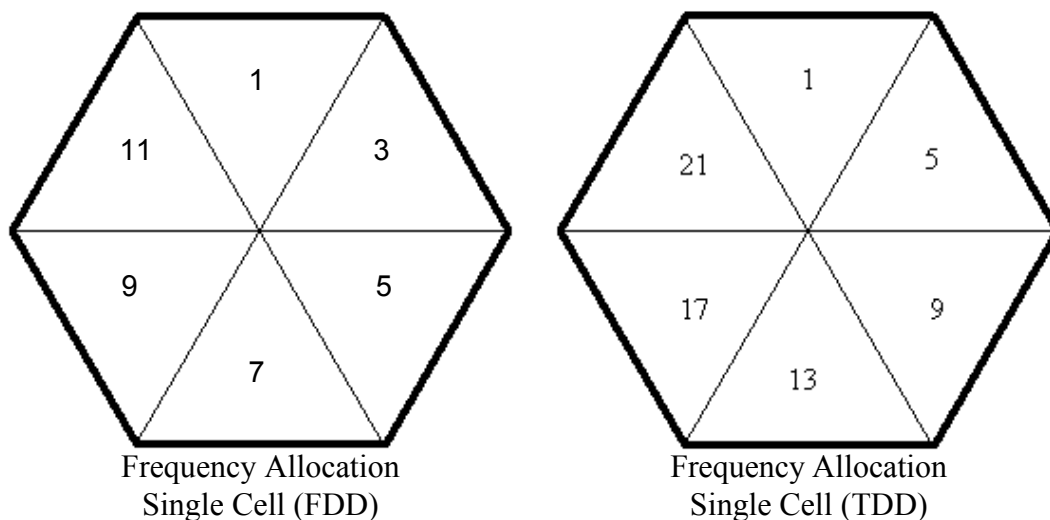

Figure 2-6: Frequency Allocation for a stand-alone cell: FDD (left) vs. TDD (right)

2.6.4. Frequency Allocation

Frequency allocation includes the following issues:

- Synchronized vs. Unsynchronized operation
- Frequency Reuse
- Frequency Allocation template

2.6.4.1. Synchronized vs. Unsynchronized Operation

The frequency allocation scheme in WipLL depends on the mode of operation. Three main options exist:

- Unsynchronized Frequency Hopping
- Synchronized Frequency Hopping
- Fix Sub-Channel Assignment

2.6.4.1.1. Unsynchronized Frequency Hopping

A scenario may exist whereby the operator does not want to synchronize base stations due to cost or regulatory issues. For example, the FCC prohibits synchronization between base stations when operating in the unlicensed band. In such a scenario, the BSRs (and SPRs) are assigned pseudo-random frequency tables, and, therefore, collisions between transceivers are possible, resulting in some level of retransmissions. However, implementing orthogonal frequency tables (hopping sequences) reduces collisions.

In this mode of operation, the available set of sub-channels, which must include a prime number of sub-channels, is organized into several different hopping sequences that are orthogonal to each other. Each BSR in the coverage area is assigned a different sequence (until there is a need to start reusing the tables). The degradation level in performance due to collisions will be a random number, depending on the length of the frequency tables (the number of available sub-channels).

Figure 2-7 displays a graph depicting the hit or blocking probability as a function of number of interferers for different table lengths (7, 23, and 79).

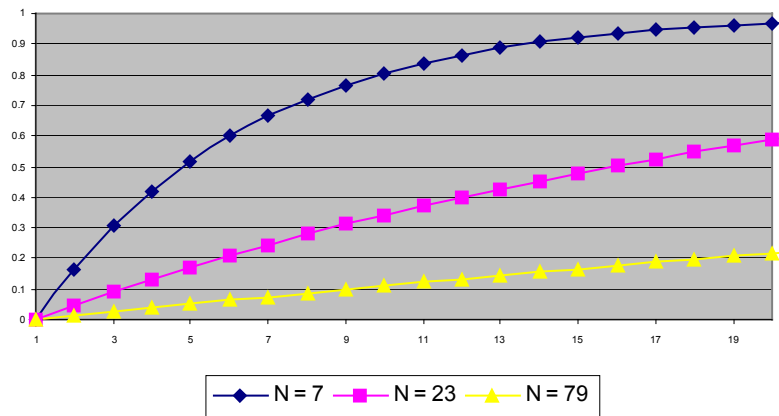

Figure 2-7: Hit probability as a function of active interferers



Note: The probability of collisions with 20 interferers and 79 sub-channels is only 20%.

2.6.4.1.2. Synchronized Frequency Hopping

In most scenarios, the operator synchronizes between WipLL base-stations located in the same coverage area. This option provides the best control over intra-system interferences.

In this mode of operation, the available set of sub-channels is arranged in a single hopping sequence, common to all transceivers (BSRs and SPRs) in the coverage area. Since the table ID is identical to all radios, the only parameter that needs to be assigned is the phase, that is, the starting point within the sequence.

By selecting the sequence appropriately, the relative frequency separation between the transceivers remains constant over time, so that interference analysis is quite similar to any Frequency Division Multiple Access (FDMA) system.

2.6.4.1.3. Fix Sub-Channel Assignment

In some scenarios—mainly licensed bands in which available spectrum is limited—it is possible to create a set of “hopping” tables, each based on a single sub-channel. Using this approach, the hopping nature of the system is actually disabled, so that synchronization is not required. The trade-off of this approach is loss of frequency diversity, discussed previously as a means to overcome frequency-selective fading.

Interference analysis in this mode is identical to any FDMA system.

2.6.4.2. Frequency Allocation

Figure 2-8 presents frequency allocation for three adjacent cells for the FDD and TDD schemes. This frequency allocation is relevant only for synchronized frequency hopping or fix sub-channel assignment options. For the unsynchronized frequency hopping option described previously, orthogonal frequency tables are assigned instead of specific sub-channels (or phases). As described in Section 2.6.3, “Interference Analysis”, 60-dB isolation between co-located BSRs is assumed for the TDD allocation.

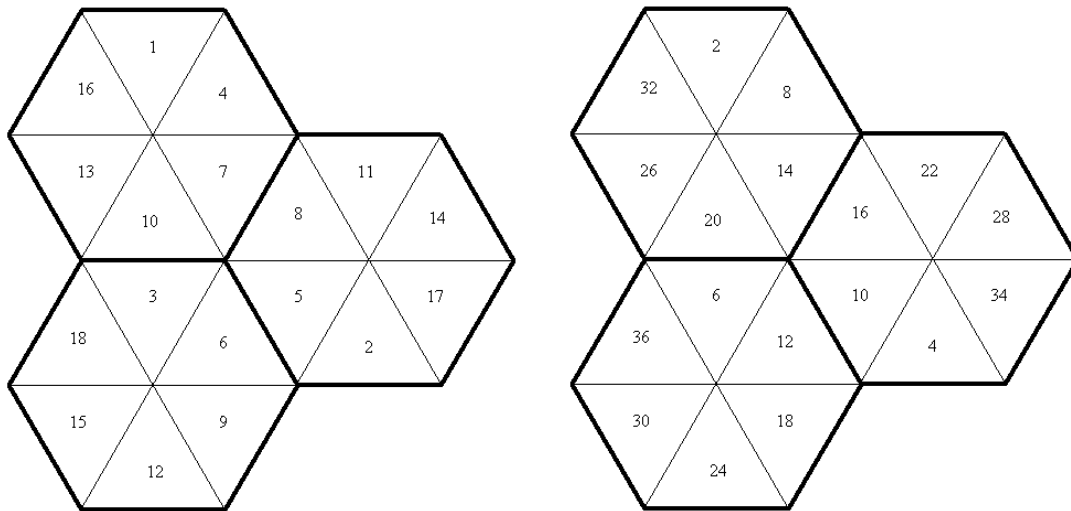

Figure 2-8: Frequency Allocation FDD (left) and TDD (right)

2.6.5. Capacity Considerations

This section provides high-level guidelines for evaluating WipLL capacity. This capacity relates to the number of subscribers supported by a single BSR according to a certain service mix. The methodology presented here provides a simplified approach for evaluating WipLL capacity capabilities. It can be used as an initial estimation; however, it cannot replace a more accurate capacity analysis performed by an RF planning team.

2.6.5.1. General

The general concept for determining the number of subscribers per BSR is presented in Figure 2-9.

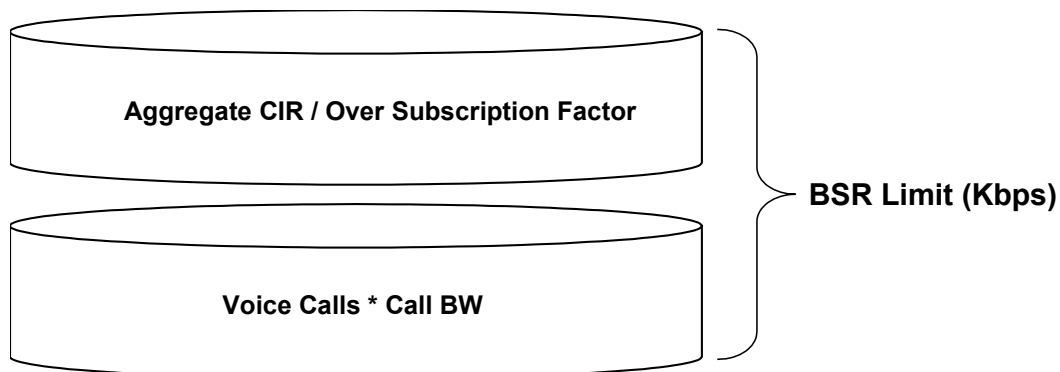

Figure 2-9: Determining number of subscribers per BSR

The BSR limit is 4 Mbps; therefore, the total voice and data bandwidth must be lower or equal to 4 Mbps.

The number of voice calls should be derived from Erlang B tables according to voice traffic per subscriber (in erlangs), and expected blocking probability (typically 1%) parameters. The VoIP bandwidth depends on the specific codec that will be used. Typical values are specified in the next section.

The data portion of the aggregated traffic is based on the sum of the committed information rate (CIR) for all subscribers assigned to the BSR, divided by the appropriate over subscription rate.

Since voice and data services differ by their packet size and their sensitivity to delay, their protocol efficiency can be substantially different. Therefore, when calculating bandwidth for different applications, the gross bandwidth should be used, which takes into account the protocol efficiency.

2.6.5.2. VoIP Bandwidth and Simultaneous Calls

The VoIP bandwidth and the number of supported simultaneous calls are a function of the selected codec and the sample interval. Assuming a 4 Mbps gross rate, the following numbers can be used:

Table 2-11: VoIP bandwidth (Kbps) for 4 Mbps gross rate

Codec	Sample Interval (msec)	Simultaneous Calls
G.711 (64 Kbps)	20	10
	40	15
G.729 (8 Kbps)	20	14
	40	28
G.723.1 (5.3 Kbps)	30	22
	60	42

If silence suppression is used, a factor of 65% should be applied on the call bandwidth.



Note: The selection of the appropriate codec should be based on a balance between the occupied bandwidth and the voice quality.

2.6.5.3. Data Bandwidth

It is assumed that packet size for data applications is relatively large (about 1,500 bytes), resulting in a protocol efficiency of 80%. Taking this into account, the sum of all data bandwidth should be divided by 80% to obtain the bandwidth over the air.

2.6.5.4. Calculation Example

This example assumes that the required services are based on voice traffic of 100 merlangs per subscriber and a CIR of 256 Kbps. In addition, in this example, a 1% blocking is expected for voice calls, and 1:10 over subscription is expected for data. The number of subscribers that can be supported by a single BSR (N) is equal to

$$Calls(traffic, Gos) \cdot \frac{4,000Kbps}{Sim_Calls(Codec)} + \frac{10\% \cdot N \cdot 256Kbps}{80\%} \leq 4,000Kbps$$

Assume that $N = 40$. Therefore, the aggregate voice traffic is equal to 4 erlangs. Using Erlang B tables with 1% blocking, 10 voice channels (calls) are required. For G.729 with 40 msec sample interval and silence suppression, the total capacity set for voice is obtained by $10 * 143 Kbps * 65\% = 930 Kbps$. The total capacity set for data is obtained by $40 * 256 Kbps * 10\% / 80\% = 1,280 Kbps$. This implies that more subscribers can be supported, since the aggregated capacity (2,210 Kbps) is lower than the 4 Mbps limit. If N (BSRs) increases, the limit of 4 Mbps will be reached for $N = 80$. (The process of finding N can be simplified by using an electronic spreadsheet).

2.6.6. Selecting an Appropriate Operation Mode

WipLL enables the operator the flexibility to choose between several modes of operation according to the operator's needs. One of the optional modes relates to the symbol rate of the modem. This section presents the main issues that should be considered when selecting an operation mode when deploying the WipLL system.

2.6.6.1. WipLL Multiple Modes

WipLL offers the capability to select between two operating modes in terms of symbol rate. The modem can operate in either 1 Mega symbols per second (MSPS) or 1.33 MSPS. The operating mode is software selectable for each BSR. The differences between the modes of operation are related to the bit rate and the channel bandwidth.

2.6.6.1.1. Bit Rate

The 1 Msps mode supports three levels of modulation, as presented in Table 2-12.

Table 2-12: WipLL bit rate at 1 Msps

Modulation	Bit/Symbol	Bit rate (Mbps)
8-level FSK	3	3
4-level FSK	2	2
2-level FSK	1	1

The 1.33 Msps mode supports two levels of modulation according to Table 2-13.

Table 2-13: WipLL bit rate at 1.33 Msps

Modulation	Bit/Symbol	Bit rate (Mbps)
8-level FSK	3	4
2-level FSK	1	1.33



Note: The differences in sensitivity and SNR values between the two modes are negligible.

2.6.6.1.2. Channel Bandwidth

The 1.33 Msps is based on shorter symbols, with the trade-off of a wider channel bandwidth. The 20 dB attenuation point for the 1 Msps mode and the 1.33 Msps mode is 1 MHz and 1.33 MHz, respectively.

2.6.6.2. System Range Considerations

System range depends on the maximum output power of the system. Different approaches exist, depending on region and frequency band.

2.6.6.2.1. Unlicensed Bands

FCC part 15 (paragraph 247) differentiates between three types of systems:

- Digital modulated
- Frequency hopping
- Hybrid

Limitations on Tx (transmit) power and EIRP differ on this basis. Table 2-14 summarizes the limitations for the different WipLL products.

Table 2-14: Tx power and EIRP limitations for WipLL products

Frequency band	Mode	Tx power	EIRP	System type
900 MHz	1 Msps	15 dBm	36 dBm	Hybrid
	1.33 Msps	18 dBm	36 dBm	Hybrid
2.4 GHz	1 Msps	--	36 dBm	Frequency hopping
	1.33 Msps	--	27 dBm	Frequency hopping
5.8 GHz	1 Msps	--	36 dBm	Frequency hopping
	1.33 Msps	18 dBm	36 dBm	Hybrid

Note: For WipLL 900, the BSR's external antenna must have a minimum cable loss of 2.5 dB to comply with FCC's EIRP limit of 36 dBm. EIRP is calculated as:

$$\text{Max. Power Output} + \text{Antenna Gain} + \text{Cable Loss} \leq 36 \text{ dBm (EIRP)}$$

The table below lists examples of cable loss per cable for maximum antenna gains, based on the formula above. Note that the EIRP is either equal to or less than 36 dBm.

Table 2-15: Example of cable loss per cable for maximum antenna gains

Cable type	Cable length (ft)	Tx power (dBm)	Cable loss (dB)	Max. antenna gain (dBi)	Max. EIRP (dBm)
BELDEN - 9913	10	18	0.6	18.6	36
	30	18.9	1.5	18.6	36
	100	21.8	4.4	18.6	36
BELDEN - 89907	10	19.3	1.9	18.6	36
	30	22.6	5.2	18.6	36
	100	23	16.3	18.6	25.3

Table 2-16, Table 2-17, and Table 2-18 present system ranges (in kilometers) for the different frequency bands (900 MHz, 2.4 GHz, and 5.8 GHz, respectively) and modes of operation (i.e., 1 Msps and 1.33 Msps).

Table 2-16: WipLL range at FCC limits for 900 MHz

Mode	Modulation	Rate (Mbps)	Range (Km)
1 Msps	8 FSK	3	4
	4 FSK	2	10
	2 FSK	1	24
1.33 Msps	8 FSK	4	6
	2 FSK	1.33	35

Table 2-17: WipLL range at FCC limits for 2.4 GHz

Mode	Modulation	Rate (Mbps)	Range (Km)
1 Msps	8 FSK	3	4
	4 FSK	2	10
	2 FSK	1	22
1.33 Msps	8 FSK	4	1

Mode	Modulation	Rate (Mbps)	Range (Km)
	2 FSK	1.33	8

Table 2-18: WipLL range at FCC limits for 5.8 GHz

Mode	Modulation	Rate (Mbps)	Range (Km)
1 Msps	8 FSK	3	2
	4 FSK	2	5
	2 FSK	1	10
1.33 Msps	8 FSK	4	1
	2 FSK	1.33	8



Note: Link budget is calculated for the uplink assuming free space propagation standard integrated antenna and 10 dB fade margin.

As shown in the tables, the system range for the 1 Msps mode is approximately three times higher than for the 1.33 Msps mode due to the 9 dB differences in Tx (transmit) power.

2.6.6.2.2. Licensed Bands (3.5 GHz)

No distinction exists between the two modes in terms of system range.

2.6.6.3. Interference Rejection

Two types of interference should be considered:

- **Intra-system interference:** caused by multiple WipLL transmitters
- **Inter-system interference:** caused by external transmitters, mainly in the unlicensed bands

2.6.6.3.1. Intra-system Interference

As mentioned previously, 1.33 Msps mode is achieved by using wider channel bandwidth. This results in a higher bit rate at the expense of increasing adjacent channel interference. This difference can become critical mainly for licensed bands in which the available spectrum might be very limited. It is beyond the scope of this document to provide specific rules regarding the preferred mode as a function of the available spectrum. This is due to the fact that such analysis depends on many parameters such as the cell layout and the topography of the coverage area. However, it should be evaluated during radio planning.

2.6.6.3.2. Inter-system Interference

The immunity of the WipLL system to external interference is due to its spread spectrum system. Exposure to external interference is highest when operating in the unlicensed band. Both FCC and ETSI set limits on the spreading level that is required by a frequency hopping spread spectrum system.

■ **ETSI:**

According to EN 300 328, FHSS modulation must use at least 20 well-defined, non-overlapping channels separated by the channel bandwidth as measured at 20 dB below peak power.

Since WipLL's carriers must be located at integer multiples of megahertz (MHz), the above statement limits the channel spacing to 1 MHz for the 1 Msps mode, and 2 MHz for the 1.33 Msps mode. This limits the number of possible hops in the WipLL system when operating under ETSI regulations to between 20 and 80 for the 1 Msps mode, and between 20 and 40 for the 1.33 Msps mode.

■ **FCC:**

Part 15 of the FCC sets the same requirement for non-overlapping channels.

For frequency hopping systems operating in the 902 MHz to 928 MHz band with a channel bandwidth greater than 250 KHz, the system shall use at least 25 hopping frequencies.

For frequency hopping systems operating in the 5725 MHz to 5850 MHz band, the system shall use at least 75 hopping frequencies.

For frequency hopping systems operating in the 2400 MHz to 2483.5 MHz band, the system shall use at least 15 non-overlapping channels.

In general, since the number of different hops is substantially lower, the capability of WipLL to overcome interferences is reduced. In practice, ETSI allows the operator the flexibility not to use the entire spectrum, in case, for example, a constant interference is identified in a portion of the spectrum. This makes the problem much less critical than in the FCC case, where the entire spectrum must be used.

2.6.6.4. System Capacity

The modulation for each link in the WipLL system is adaptively determined according to the signal strength and the BER. When evaluating system capacity, it should be taken into account that the intermediate 4-FSK modulation is not supported when operating at 1.33 Msps.

Assume a WipLL deployment where subscribers are located at various distances from the base stations. In general, three coverage circles can be expected around each base station:

- **Inner circle**—supporting 8-level FSK
- **Intermediate circle**—supporting 4-level FSK
- **Outer circle**—supporting 2-level FSK

Let p_i , p_m , and p_o represent the percentages of subscribers located at the inner, intermediate, and outer coverage circles, respectively. The average capacity of the system (without taking into account advanced features like fairness) for each of the possible modes can be given by the following formulas:

$$\begin{aligned} \text{Capacity}_{1\text{Msps}}[\text{Mbps}] &= p_i \cdot 3 + p_m \cdot 2 + p_o \cdot 1 \\ \text{Capacity}_{1.33\text{Msps}}[\text{Mbps}] &= p_i \cdot 4 + (p_m + p_o) \cdot 1.33 \end{aligned}$$

Radio planning can provide estimations for p_i , p_m , and p_o so that the WipLL operator can determine which option provides the highest system capacity.

2.6.6.5. Conclusion

The 1.33 Msps mode provides superior bit rate, but at the expense of a possible reduction in radio coverage (FCC), and/or increase in interference. A certain amount of radio planning is required to determine the preferable mode to maximize the overall capacity of the access network.

2.6.7. Radio Planning Software Tool

To design an optimal fixed wireless broadband network, the operator requires an RF design tool that includes features of a geographic information system (GIS) module, a propagation prediction module, and a fixed wireless module.

The GIS module should map data that contain or can be assigned geographic coordinates, for example, terrain elevation, land-use classification, site locations, design area boundaries, roads, and highways.

The propagation prediction module should provide RF propagation analysis and predictions. This module must support features that allow the propagation model to be calibrated using drive test measurements.

The fixed wireless module should support directional CPE antennas for coverage, capacity and interference analysis in LOS and NLOS conditions, and adaptive modulation.

2.6.7.1. Geographic Information Systems Database

To enable detailed and accurate propagation prediction, terrain information must be supplemented by a Geographic Information Systems (GIS) database. Clutter databases are typically based on Satellite or Aerial photography, depending on the resolution of the planning. Clutter databases should include Definition of Clutter Types and Clutter Height relative to the underlying DEM.

The resolution of data varies depending on the environment at which the planning is targeted. Airspan recommends the following:

- **Rural:** 10 to 30 meters
- **Urban:** 5 to 20 meters

The specific format of the database depends on the planning tool. The planning software provider or user's manual should be consulted to obtain the appropriate format.

This page is intentionally left blank.