



---

# AirSpeed 1050 Installation Guide

**Part Number: DUG01545**

System Release: 16.0

Revision: A

**Published: June 2019**

© Copyright by **Airspan Networks Inc.**, 2019 - 2019. All rights reserved worldwide.

### **Legal Notices**

The information contained within this document is proprietary, privileged and intended only for the recipient. As such, the information is subject to all relevant copyright, patent and other laws protecting intellectual property, as well as any specific agreements protecting Airspan Networks Ltd. rights in the aforesaid information. Neither this document nor the information contained herein may be published, reproduced, transmitted or disclosed to third parties, in whole or in part, without the express, prior, written permission of Airspan Networks Ltd. In addition, any use of this document or the information contained herein for the purposes other than those for which it is disclosed is strictly forbidden.

Airspan Networks Inc. reserves the right, without prior notice or liability, to make changes in equipment design or specifications.

Information supplied by Airspan Networks Ltd. is believed in good faith to be accurate and reliable, while every care has been taken in preparing these documents. However, Airspan Networks Ltd. does not make any representations and gives no warranties of whatever nature in respect of these documents, including without limitation, the accuracy or completeness of any information, facts and/or opinions contained therein. No responsibility is assumed by Airspan Networks Ltd. for the use of the documents nor for the rights of third parties which may be effected in any way by the use thereof. The provision of these documents (and the documents themselves) does not constitute professional advice of any kind. Any representation(s) in these documents concerning performance of Airspan Networks Ltd. product(s) are for informational purposes only and are not warranties of future performance, either expressed or implied. Airspan Networks Ltd., its affiliates, directors, employees and agents shall not be held liable for any damages or losses, of any nature whatsoever, arising from any use of and/or reliance on the documents.

These documents may contain flaws, omissions or typesetting errors; no warranty is granted nor liability assumed in relation thereto unless specifically undertaken in Airspan Networks Ltd. sales contract or order confirmation. Information contained herein is periodically updated and changes will be incorporated into subsequent editions. If you have encountered an error, please notify Airspan Networks Ltd.

Product performance figures quoted within this document are indicative and for information purposes only.

---

# Table of Contents

Document Information .....	1
Document Approvals.....	1
Revision History .....	1
Warnings and Cautions .....	2
Human Exposure to Radio Frequencies .....	2
Avertissement et Precautions d'Utilisation .....	2
Radio Interference.....	2
Modifications .....	2
General .....	2
Général .....	3
⚠ Important Safety Instructions .....	3
Safety.....	3
Securite.....	4
Warning of Hazardous Voltages .....	4
Attention aux Voltages Hasardeux.....	5
Adherence to European Directive 1999/5/EC .....	5
Warning Symbols .....	5
Service Information .....	5
UL Information .....	6
Lightning Protection .....	6
Outdoor Cabling.....	7
DECLARATION OF CONFORMITY.....	7
GPS Compliance.....	8
Maximum Output TX Total Power .....	9
Power Consumption.....	9
Product Variants .....	9
Antenna System.....	10
About This Document.....	11
Purpose.....	11

Intended Audience .....	11
Related Reading .....	11
<b>Customer Care Help Desk .....</b>	<b>12</b>
Airspan Encourages Comments .....	12
<b>1 Introduction .....</b>	<b>13</b>
1.1 AirSpeed 1050 .....	13
1.1.1 Deployment.....	13
<b>2 Verifying Prerequisites.....</b>	<b>15</b>
2.1 Verify the Tools .....	15
2.2 Verify the Parts and Kits.....	15
<b>3 Physical Description .....</b>	<b>17</b>
3.1 AirSpeed 1050 Physical Dimensions.....	17
3.2 Bottom View .....	18
3.3 Power 18	
3.3.1 Environmental .....	18
<b>4 Installation of AirSpeed 1050 .....</b>	<b>20</b>
4.1 Mounting .....	20
4.1.1 Pole Mount Assembly.....	21
4.1.2 Wall Mount Assembly .....	22
4.1.3 Securing the Unit to the Mounting Clamp Bracket .....	23
<b>5 Connect and Manage Cables .....</b>	<b>25</b>
5.1 Connecting the Ground Cable .....	25
5.2 Cable Connection.....	25
5.2.1 AC Cable Preparation .....	26
5.2.2 DC Cable Preparation .....	30
5.2.3 Fiber Ethernet (SFP) Cable Preparation.....	34
5.2.4 Copper Ethernet Cable Preparation.....	38
<b>A Job Sheet.....</b>	<b>42</b>
<b>B Abbreviations .....</b>	<b>43</b>

## Figures

Figure 1: AirSpeed 1050.....	10
Figure 2: AirSpeed 1050.....	14
Figure 3: AirSpeed 1050 Overall Dimensions.....	17
Figure 4: AirSpeed 1050 Bottom.....	18
Figure 5: Positioning Overview.....	20
Figure 6: Mounting Bracket on Wall.....	22
Figure 7: Assembly on Pole.....	23
Figure 8: AirSpeed 1050 on Pole (Shown Wired).....	23
Figure 9: AirSpeed 1050 on Top Pole - Example (Shown Wired).....	24
Figure 10: AirSpeed 1050 on Wall.....	24
Figure 11: Ground Connection.....	25
Figure 12: Stripping Dimensions (AC Cable).....	26
Figure 13: Open Housing Lock.....	26
Figure 14: Separate into Sections.....	27
Figure 15: Insert Gland Nut.....	27
Figure 16: Pass Cable Through.....	27
Figure 17: Insert Wire to Housing.....	27
Figure 18: AC Wire Placement.....	28
Figure 19: Tighten Three (3) Set Screws.....	28
Figure 20: Cable Click in Place.....	28
Figure 21: Place Split Rubber Gland.....	28
Figure 22: Gland Size on Edge.....	29
Figure 23: Place Tightening Cone on Split Gland.....	29
Figure 24: Tighten Gland Nut.....	29
Figure 25: Close the Lever.....	30
Figure 26: Secure Lock.....	30
Figure 27: Stripping Dimensions (DC Cable).....	30
Figure 28: Open Housing Lock.....	31
Figure 29: Separate into Sections.....	31
Figure 30: Insert Gland Nut.....	31
Figure 31: Pass DC Cable Thru.....	31
Figure 32: Tighten Two (2) Set Screws.....	32
Figure 33: Tighten the Strap Clamp.....	32
Figure 34: Align Marks + Click in Place.....	32
Figure 35: Place Split Rubber Gland.....	32
Figure 36: Gland Size on Edge.....	33

Figure 37: Place Tightening Cone on Split Gland .....	33
Figure 38: Tighten gland Nut.....	33
Figure 39: Close the Lever.....	33
Figure 40: Secure Housing Lock.....	34
Figure 41: Pre-assembled LC Duplex Cable .....	34
Figure 42: Open Housing Lock .....	34
Figure 43: Gland Nut on Cable .....	35
Figure 44: Insert Tightening Cone on Cable.....	35
Figure 45: Insert Rubber Gland on Cable.....	35
Figure 46: Pass Cable thru Housing.....	35
Figure 47: Insert Cable into Transceiver.....	36
Figure 48: Insert Holder over the Transceiver .....	36
Figure 49: Holder into Housing Base.....	36
Figure 50: Holder into Transceiver .....	36
Figure 51: Lift Lever.....	37
Figure 52: Insert Gland .....	37
Figure 53: Insert Cone .....	37
Figure 54: Tighten Gland Nut.....	37
Figure 55: Secure Housing Lock.....	38
Figure 56: Pre-assembled RJ45 Cable .....	38
Figure 57: Gland Nut on Cable .....	38
Figure 58: Insert Tightening Cone on Cable.....	38
Figure 59: Insert Rubber Gland on Cable.....	39
Figure 60: Insert Housing onto Cable.....	39
Figure 61: Insert Holder onto RJ45 .....	39
Figure 62: Holder into Housing Base.....	39
Figure 63: Align RJ45 into Holder .....	40
Figure 64: Lift Lever.....	40
Figure 65: Insert Gland .....	40
Figure 66: Tighten Gland Nut.....	40
Figure 67: Secure Housing Lock.....	41
Figure 68: AC Housing Lock Secured .....	41

## Tables

Table 1: AirSpeed 1050 ETSI Maximum Output TX Total Power .....	9
Table 2: Power Consumption.....	9
Table 3: Variants .....	9
Table 4. Hardware Requirements - Mounting .....	15
Table 5: AirSpeed 1050 Components .....	15

Table 6. AirSpeed 1050 Physical Dimensions .....	17
Table 7. AirSpeed 1050 Environment Compliance .....	18
Table 8: Outdoor Power Cable Requirements .....	25
Table 9: Recommended Gland Size.....	29

## Document Information

This document details procedures for installing the Airspan's AirSpeed 1050 Pico-class LTE eNodeB variant.

## Document Approvals

Department	Name	Role	Approval date
Product Management	STS	Product Line Manager	
R&D	EPI	Digital HW Group Manager	

## Revision History

Document owner: Shlomi Tsur, PLM

Revision	Date	Summary of Changes	Created by
0.1 - 0.3	January 2019	Initial document & comments	MSF
0.4	February 2019	Additions from comments	MSF
A	February 2019	<ul style="list-style-type: none"><li>• Additions from comments</li><li>• Publish</li></ul>	MSF
A1	May 2019	<ul style="list-style-type: none"><li>• Additions from comments</li></ul>	MSF
A2	June 2019	<ul style="list-style-type: none"><li>• Additions from comments</li></ul>	MSF



## Warnings and Cautions

### Human Exposure to Radio Frequencies

The AirSpeed 1050 when operational should be operated from a minimum safe distance of 2ft (64cm).

## Avertissement et Precautions d'Utilisation

### Exposition des personnes aux fréquences radioélectriques

Les antennes d'AirSpeed 1050 quand opérationnel doivent être installée et utilisée de façon à garantir la distance minimale de sécurité de 2ft. (60cm).

### Radio Interference

This AirSpeed 1050 generates, uses, and can radiate radio frequency energy and, if not installed and used in accordance with the instructions, may cause harmful interference to radio communications. However, there is no guarantee that interference will not occur in a particular installation. If this equipment does cause harmful interference to radio or television reception, which can be determined by turning the equipment on and off, the technician is encouraged to try to correct the interference by performing one or more of the following measures:

- Re-orientate or relocate the unit
- Increase separation between the units and/or End Device
- Connect the equipment to a circuit different from that to which the power source is connected

### Modifications

Any changes and modifications to this device that are not expressly approved by Airspan Networks may void the user's authority to operate the equipment.

### General

- Only qualified personnel should be allowed to install, replace, and service the equipment.
- The device cannot be sold retail, to the general public or by mail order. It must be sold to operators.
- Installation must be controlled.
- Installation must be performed by licensed professionals.
- Installation requires special training. The AirSpeed 1050 radio and antenna should be installed ONLY by experienced installation professionals who are familiar with local building and safety codes and, wherever applicable, are licensed by the appropriate government regulatory authorities. Failure to do so may void Airspan's product warranty and may expose the end user or the service provider to legal and financial liabilities. Airspan and its resellers or distributors are not liable for injury, damage or violation of regulations associated with the installation of outdoor units or antennas.
- The device is to be installed in a Restricted Access Location.

## Général

- Seul le personnel qualifié peut être autorisé pour installer ou remplacer l'équipement ainsi qu'effectuer les opérations de maintenance pour cet équipement.
- L'équipement ne peut pas être vendu en grande distribution ou par commande via email à destination du public. Il doit être vendu aux opérateurs de télécommunications.
- Son installation doit être contrôlée
- Son installation doit être effectuée par des professionnels autorisés.
- Son installation requiert une formation spécifique du personnel. L'AirSpeed 1050, radio et antenne doit être installée UNIQUEMENT par des installateurs professionnels expérimentés et ayant une connaissance des constructions locales et règles de sécurité, ainsi que, dès que nécessaire, disposant d'un accord des autorités gouvernementales de régulation. Toute infraction à ces obligations peut annuler la garantie délivrée par Airspan pour ces produits et peut exposer l'utilisateur final ou le fournisseur de services à des dommages légaux et financiers.
- Airspan et ses revendeurs ou ses distributeurs ne sont pas responsables des blessures, dommages ou violations de la réglementation en vigueur liées à l'installation du système extérieur ou des antennes.
- L'équipement doit être installé dans une zone à accès réduit et contrôlé.

## Important Safety Instructions

- Read and Save these instructions
- This Installation Guide contains instructions and warnings that should be followed during installation, and operation.
- Failure to follow these instructions could cause bodily injury and/or product failure.

## Safety

1. Read this guide and follow all operating and safety instructions.
2. Supply cord is not shipped with the unit and is to be provided by user. Installation is to be performed by a qualified electrician according to local codes. Installation to be done in accordance with the National Electrical Code (NEC), ANSI/NFPA 70, the Canadian Electrical Code (CEC), Part I, CAN/CSA C22.1, and when applicable, the National Electrical Safety Code, IEEE C2.
3. Static sensitive components inside - do not remove the lid or base: No user serviceable parts inside.
4. The ground connection should be made before connecting to supply connections.
5. Position the power cord to avoid possible damage; do not overload circuits.
6. Do not place this product on or near a direct heat source, and avoid placing objects on the terminal.
7. To avoid electrical shock do not install this device during adverse conditions such as rain or inclement weather.
8. Use only a damp cloth for cleaning. Do not use liquid or aerosol cleaners. Disconnect the power before cleaning.
9. The units should not be located too near power lines or other electrical power circuits, where it can come into contact with such power lines or circuits.
10. The unit must be properly grounded to protect against power surges and accumulated static electricity. It is the user's responsibility to install this device in accordance with the local electrical codes.
11. Installation of the unit must be contracted to a professional installer.

12. The circuit breaker should be easily accessible in case you have to disconnect the device.
13. When installed in the final configuration, the product must comply with the applicable Safety Standards and regulatory requirements of the country in which it is installed. If necessary, consult with the appropriate regulatory agencies and inspection authorities to ensure compliance.

## Securite

1. Lire attentivement ce guide et suivre les instructions d'utilisation et de sécurité.
2. Le cordon d'alimentation n'est pas livré avec l'appareil et doit être fourni par l'utilisateur. L'installation doit être effectuée par un électricien qualifié conformément aux règles et standards locaux. L'installation doit être effectuée en conformité avec le Code national de l'électricité ( NEC ), ANSI / NFPA 70, le Code canadien de l'électricité (CCE ), Partie I, CAN / CSA C22.1, et le cas échéant, le Code national de sécurité électrique, IEEE C2.
3. Des composants sensibles a électricité statique sont utilisés à l'intérieur. Ne pas retirer le coffre ou la base. Aucune pièce a l'intérieur est d'utilité pour l'utilisateur.
4. La connexion "terre" doit être effectuée en priorité et avant d'effectuer les connexions à la source d'alimentation (phase et neutre).
5. Positionner le cordon d'alimentation de façon à éviter des dommages potentiels. Ne pas surcharger les circuits.
6. Ne pas placer ce produit sur ou à proximité d'une source directe de chaleur et éviter de placer des objets sur le terminal.
7. Afin d'éviter des problèmes électriques, ne pas installer cet équipement au cours d'évènements climatiques difficiles comme averses ou météo non clémente.
8. Utiliser uniquement chiffon de coton pour nettoyage. Ne pas utiliser de produits liquides ou d'aérosols. Déconnecter le produit de la source d'alimentation avant nettoyage.
9. L'unité ne doit pas être située trop près de lignes électriques ou autres circuits de puissance, avec lesquels il pourrait entrer en contact.
10. L'émetteur radio doit être correctement relie a la terre afin de le protéger contre les surtensions ou accumulation d'électricité statique. L'utilisateur est tenu responsable de l'installation du produit conformément aux règles électrique en vigueur localement.
11. L'installation de unité doit être contractualisée avec un installateur professionnel.
12. L'interrupteur de circuit électrique doit être facilement accessible afin de pouvoir déconnecter l'équipement.
13. Lors de l'installation de la configuration finale, le produit doit être conforme aux Standards de Sécurité en vigueur ainsi qu'aux exigences réglementaires du pays dans lequel il est installé. Si nécessaire, consulter les agences règlementaires appropriées, ainsi que les autorités chargées de l'inspection afin de garantir la conformité.

## Warning of Hazardous Voltages

On AC installations, hazardous voltages exist. Use caution when verifying or working with AC power. Remove metal jewellery that could come into contact with AC power.

On DC sections, short-circuiting the low voltage, low impedance circuits can cause severe arcing that may result in burns or eye damage. Remove rings, watches etc. to avoid shorting DC circuits.

**Note:** Airspan products do not contain hazardous substances (as defined in UK Control of Substances Hazardous to Health Regulations 1989 and the Dangerous Substances Regulations 1990). At the end of any Airspan products life cycle, the customer should consult with Airspan to ensure that the product is disposed of in conformance with the relevant regulatory requirements.

## Attention aux Voltages Hasardeux

Sur les installations de réseau électrique de type courant alternatif (CA), des voltages hasardeux peuvent survenir. Garder une Attention particulière lors d'une vérification ou de travaux sur réseau électrique CA. Retirer tous bijoux en métal qui pourraient entrer en contact avec l'alimentation ou le réseau CA.

Sur les portions de réseau électrique de type courant continu (CC), un circuit basse impédance peut causer de sérieux arcs électriques qui pourraient brûler ou endommager les yeux. Retirer bagues, anneaux, montres etc... afin d'éviter les court-circuit sur le réseau CC.

## Adherence to European Directive 1999/5/EC

European Council Recommendation 1999/5/EC details basic restrictions and reference levels on human exposure to electromagnetic fields as advised by the ICNIRP. Adherence to these recommended restrictions and reference levels should provide a high level of protection as regards the established health effects that may result from exposure to electromagnetic fields.



Airspan equipment is compliant with CE and R&TTE regulations and can be operated in all EU (European Union) locations listed below:

Country Code			
BE	EL	LT	PT
BG	ES	LU	RO
CZ	FR	HU	SI
DK	HR	MT	SK
DE	IT	NL	FI
EE	CY	AT	SE
IE	LV	PL	UK

## Warning Symbols

The following symbols may be encountered during installation or troubleshooting. These warning symbols mean danger. Bodily injury may result if you are not aware of the safety hazards involved in working with electrical equipment and radio transmitters. Familiarize yourself with standard safety practices before continuing.



Caution, hot surface



Caution



Electro-Magnetic Radiation



High Voltage (AC)



DC

## Service Information

Refer all repairs to qualified service personnel. Do not modify any part of this device, as this will void the warranty.

Disconnect the power to this product and return it for service if the following conditions apply:

- a. The terminal does not function after following the operating instructions outlined in this manual.
- b. The product has been dropped or the housing is damaged.

Locate the serial number of the terminal and record this on your registration card for future reference. Also record the MAC address, located on the product sticker.

## UL Information

- The equipment must be properly grounded according with NEC and other local safety code requirements.
- Reminder to system installers: Attention to Section 820-40 of the NEC which provides guidelines for proper grounding and, in particular, specifies that the cable ground shall be connected to the grounding system of the building, as close to the point of cable entry as is practical.
- AirSpeed 1050 is designed to operate in environmental conditions complying with IP66 and relevant standards.

## Lightning Protection

**WARNING:** The following notes are general recommendations for the system. The wireless equipment should be installed by a qualified professional installer and must follow local and national codes for electrical grounding and safety. Failure to meet safety requirements and/or use of non-standard practices and procedures could result in personal injury and damage to equipment. A direct lightning strike may cause serious damage even if these guidelines are followed.

All outdoor wireless equipment is susceptible to lightning damage from a direct hit or induced current from a near strike. Lightning protection and grounding practices in local and national electrical codes serve to minimize equipment damage, service outages, and serious injury. The antennas are to be DC grounded, so surge protection may not be required. Reasons for lightning damage are summarized as:

- Poorly grounded tower/antenna sites that can conduct high lightning strike energy into equipment.
- Lack of properly installed lightning protection equipment that can cause equipment failures from lightning induced currents.

A lightning protection system provides a means by which the energy may enter earth without passing through and damaging parts of a structure. A lightning protection system does not prevent lightning from striking; it provides a means for controlling it and preventing damage by providing a low resistance path for the discharge of energy to travel safely to ground. Improperly grounded connections are also a source of noise that can cause sensitive equipment to malfunction.

A good tower grounding system disperses most of the surge energy from a tower strike away from the building and equipment.

To limit the equipment damage due to a lightning strike, the following practices are recommended for the wireless system:

- Provide direct grounding from the antenna mounting bracket, the radio and antenna and the lightning/surge protectors to the same ground point at the base of the tower or a ground bus on the building. Use the grounding screws on the antenna bracket and the radio and antenna for terminating the ground wires.
- The circuit ground must be connected to the same grounding system as the unit.

## Outdoor Cabling

- Connected cables should be outdoor grade with UV protection.
- Use shielded out CAT6 cabled terminated with metallic RJ45 connectors.
- Surge protection circuit must use a minimum 14AWG grounding cable.

## DECLARATION OF CONFORMITY

### European Community, Switzerland, Norway, Iceland, and Liechtenstein

#### Declaration of Conformity with Regard to the R&TTE Directive 1999/5/EC

##### English:

This equipment is in compliance with the essential requirements and other relevant provisions of Directive 1999/5/EC.

##### Deutsch:

Dieses Gerät entspricht den grundlegenden Anforderungen und den weiteren entsprechenden Vorgaben der Richtlinie 1999/5/EU.

##### Dansk:

Dette udstyr er i overensstemmelse med de væsentlige krav og andre relevante bestemmelser i Directiv 1999/5/EF.

##### Español:

Este equipo cumple con los requisitos esenciales así como con otras disposiciones de la Directiva 1999/5/EC.

##### Greek:

ΜΕ ΤΗΝ ΠΑΡΟΥΣΑ Airspan ΔΗΛΩΝΕΙ ΟΤΙ Ο ΕΞΟΠΛΙΣΜΟΣ ΣΥΜΜΟΡΦΩΝΕΤΑΙ ΠΡΟΣ ΤΙΣ ΟΥΣΙΩΔΕΙΣ ΑΠΑΙΤΗΣΕΙΣ ΚΑΙ ΤΙΣ ΛΟΙΠΕΣ ΣΧΕΤΙΚΕΣ ΔΙΑΤΑΞΕΙΣ ΤΗΣ ΟΔΗΓΙΑΣ 1999/5/ΕΚ.

##### Français:

Cet appareil est conforme aux exigences essentielles et aux autres dispositions pertinentes de la Directive 1999/5/EC.

##### Íslenska:

Þessi búnaður samrýmist lögboðnum kröfum og öðrum ákvæðum tilskipunar 1999/5/ESB.

##### Italiano:

Questo apparato é conforme ai requisiti essenziali ed agli altri principi sanciti dalla Direttiva 1999/5/EC.

##### Nederlands:

Deze apparatuur voldoet aan de belangrijkste eisen en andere voorzieningen van richtlijn 1999/5/EC.

##### Norsk:

Dette utstyret er i samsvar med de grunnleggende krav og andre relevante bestemmelser i EU-directiv 1999/5/EC.

##### Português:

Este equipamento satisfaz os requisitos essenciais e outras provisões da Directiva 1999/5/EC.

##### Suomalainen:

Tämä laite täyttää direktiivin 1999/5/EY oleelliset vaatimukset ja on siinä asetettujen muidenkin ehtojen mukainen.

##### Svenska:

Denna utrustning är i överensstämmelse med de väsentliga kraven och andra relevanta bestämmelser i Direktiv 1999/5/EC.

**Român:**

Acest echipament este în conformitate cu cerințele esențiale și alte prevederi relevante ale Directivei 1999/5/CE.

The Declaration of Conformity related to this product can be obtained from [PLM@Airspan.com](mailto:PLM@Airspan.com).

## GPS Compliance

The GPS is in compliance with the essential requirements and other relevant provisions of Directive 1999/5/EC."

The GPS complies with the following EMC Common Regulatory Testing standards:

- EN55022: Radiated and Conducted Emissions
- CISPR 22: Class B
- EN 50081-1: Generic Emissions Class B
- EN 50082-1: Generic Immunity Class B
- EN 61000-4-2: Electrostatic Discharge Immunity
- EN 61000-4-3: Radiated RF EM Field Immunity Test
- EN 61000-4-4: Electrical Fast Transient/Burst Test
- EN 61000-4-6: Conducted Immunity
- EN 61000-4-8: Magnetic Field Immunity

**Note:** A GPS is recommended for synchronizing between sectors.

**Note:** An optional GPS Lightning/Surge protector is available from Airspan when installing the GPS antenna in a remote location for lightning prone deployments.

## Maximum Output TX Total Power

Table 1: AirSpeed 1050 FCC Maximum Output TX Total Power

Frequency Band (MHz)	FCC		Antenna Gain (dBi)	Variant
	TX (dBm)	EIRP (dBm)		
2496 - 2690	35	47	12	1050

**Caution:** Do not set maximum output TX power to higher than local regulations.

## Power Consumption

AirSpeed 1050 has a Max nominal power consumption of 45W. AirSpeed 1050 power consumption is described in the following table:

Table 2: Power Consumption

Duplex	Tx Power at RF Port (dBm)	Nominal Power Consumption (W)
TDD	4x 33	45

## Product Variants

Table 3: Variants

Product Name	Product Code	Description
<b>AirSpeed 1050 B40 Fiber + copper BH, DC power</b>	AS105-U40-B08D	AirSpeed 1050, 2.3 - 2.4 GHz (B40), Fiber, Copper Backhaul, DC
<b>AirSpeed 1050 B40 Fiber + copper BH, AC power</b>	AS105-U40-B08A	AirSpeed 1050, 2.3 - 2.4 GHz (B40), Fiber, Copper Backhaul, AC



## Antenna System

The AirSpeed 1050 includes embedded antennas: 2x SBA. Each SBA includes two antenna elements which can be switch on/off.

---

**Figure 1: AirSpeed 1050**



## About This Document

### Purpose

This guide provides the workflow and step-by-step procedures for Installing the AirSpeed 1050. These procedures include:

- Verify prerequisites
- Install the AirSpeed 1050
- Connect and manage cables

### Intended Audience

This guide is intended for persons who are responsible for installing the AirSpeed 1050 equipment. These persons should have a working knowledge of the equipment.

### Related Reading

The following documents contain related information:

- AirSpeed 1050 Product Datasheet
- Airspan LTE Commissioning Manual *Pending*

---

## Customer Care Help Desk

Airspan's *Customer Care Help Desk* offers prompt and efficient customer support services.

**Note:** To avail Airspan's *Customer Care Help Desk* support, you must be a registered user and must have a valid support contract. To register, click [here](#) and fill the **Registration** form.

To create and update issue logs, send e-mails to [Customer Care Help Desk](#). Once you submit your issue, the system generates a new issue and sends an issue number for your reference. The system uses this issue number to categorize and store e-mails under the appropriate issue.

To help *Customer Care Help Desk* identify your issue, include the issue number and your *Customer Care Helpdesk* account details in all further communications.

---

### Main Operations

Airspan Communications Ltd.  
Capital Point  
33 Bath Road  
Slough, Berkshire  
SL1 3UF, United Kingdom  
Tel: +44-1895-467-100

### Worldwide Headquarters

Airspan Networks Inc.  
777, Yamato Road, Suite 105  
Boca Raton, FL 3341-4408, USA  
Tel: +1 561 893 8670

---

## Airspan Encourages Comments

Airspan welcomes any feedback and suggestions that help to improve the quality of the documentation. Send your feedback to [documentfeedback@airspan.com](mailto:documentfeedback@airspan.com).

# 1 Introduction

This section provides a descriptive overview of the Airspan's AirSpeed 1050 variant(s) and its place in the Airspan product suite. AirSpeed 1050 is a standalone product with fiber and copper backhaul. It includes dual sector access with SBA antenna. The product is aimed for outdoor deployment, on a pole top or side as well as wall mounting.

## 1.1 AirSpeed 1050

AirSpeed 1050 is part of Airspan's carrier-class LTE advanced outdoor family, a compact outdoor small cell with dual sector smart beam antennas

All Airspan products, including AirSpeed 1050 B40, are interoperable with a rich portfolio of 3<sup>rd</sup> party end user devices, including many handsets, indoor UEs, outdoor UEs and USB dongles from several ODMs, using various chipsets. For an updated of interoperability list, please contact your nearest Airspan Sales Representative.

**Note:** For management please refer to the Airspan LTE Commissioning Manual as well as the Netspan User Manual.

### 1.1.1 Deployment

AirSpeed 1050 perfectly fits the requirements of the hard zoning outdoor locations such as city centers, parks, universities, and hotel facilities all due to its super compact one box form factor.

AirSpeed 1050 creates a single install process for LTE Access and Backhaul, and enables "Just add Power" plug and play deployment method and along with the easy zoning of the product saving deployment related costs and time.

**Note:** The following is for illustration only; actual layout may differ as infrastructure is installation-specific.

**Note:** AirSpeed 1050 must be properly grounded according with NEC and other local safety code requirements.

**Figure 2: AirSpeed 1050**

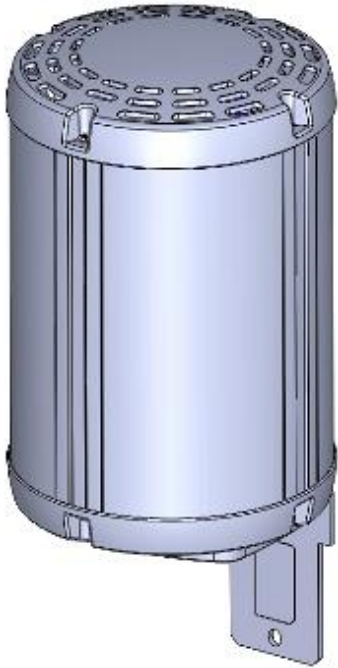

---

**Note:** The illustration above displays the AirSpeed 1050 unit.

---

## 2 Verifying Prerequisites

Prior to installing the AirSpeed 1050, verify the required safety, power, tools, parts and components. This chapter includes the hardware, software, and client requirements for installation. Verify the availability of:

- AirSpeed 1050 unit
- Mounting Kit
- Desired location with available power source

### 2.1 Verify the Tools

**Table 4. Hardware Requirements - Mounting**

Tool	Use
Large flat bladed screwdriver	securing the pole straps
13 mm wrench	for securing the M8 bolts
13 mm torque wrench	for final tightening of the M8 bolts (Tighten to a torque of no more than 14 Nm (10 ft-lb) max.)
Knife	For cable preparation
Small side cutters	For power cable preparation
Wire strippers	For power cable preparation

### 2.2 Verify the Parts and Kits

**Note:** Verify order and requirements to ensure the correct unit type is being installed.

**Note:** Currently available - AS105-U40-B08D (DC variant).

**Table 5: AirSpeed 1050 Components**

Installation Kit / Part	Product Code	AS P/N	Description
AirSpeed 1050 B40 Fiber + copper BH, DC power	AS105-U40-B08D	998-73-401SF	AirSpeed 1050, 2.3 - 2.4 GHz (B40), Fiber, Copper Backhaul, DC <ul style="list-style-type: none"> <li>• Nut, M6, Full, SS, A2, DIN934 (x2)</li> <li>• Spring Lock Washer M6 SQ End SS A2 DIN127B (x2)</li> <li>• HEX Head Screw M6x30mm, SS A2 DIN933 (x1)</li> </ul>
AirSpeed 1050 B40 Fiber + copper BH, AC power	AS105-U40-B08A	N/A	AirSpeed 1050, 2.3 - 2.4 GHz (B40), Fiber, Copper Backhaul, AC
Mounting Kit (Pole)	Mounting KIT Long Band	903-03-350	<ul style="list-style-type: none"> <li>• Pole Mounting Clamp Bracket (x1)</li> <li>• Sems Hex-Head Bolt M8x20 ISO4017 with 2 Washers-all A2 (x2)</li> <li>• Maxi Clamp, band 14mm (9/16in) wide + quick adjust lock, 63-406mm (1/2-16in) pole diameter. (x2)</li> </ul>

Installation Kit / Part	Product Code	AS P/N	Description
	<b>OR</b>		
	Mounting KIT Short Band	903-03-360	<ul style="list-style-type: none"> <li>• Pole Mounting Clamp Bracket (x1)</li> <li>• Sems Hex-Head Bolt M8x20 ISO4017 with 2 Washers-all A2 (x2)</li> <li>• Maxi Clamp, band 14mm (9/16in) wide + quick adjust lock, 51-178mm (2-7in) pole diameter. (x2)</li> </ul>
External Plug			
Octis Plug Kit - DC	10143758-101LF	300-50-133	Power DC - with 2 position power (26mm pitch) Screw Version
OCTIS KIT (W/O SFP connector)	10135746-101LF	300-50-134	SFP - W/O SFP 26MM
Octis plug kit - AC	10143762-102LF	300-50-135	Power AC - 3 position power(26mm pitch) Screw Version & metal tie
Octis plug kit W/O RJ45 connector)	10135742-101LF	300-20-062	ETH - without RJ45 connector ,Right (R) pitch 26mm

### 3 Physical Description

AirSpeed 1050 is in an all outdoor enclosure.

This section provides the physical attributes of the AirSpeed 1050.

Figure 3: AirSpeed 1050 Overall Dimensions

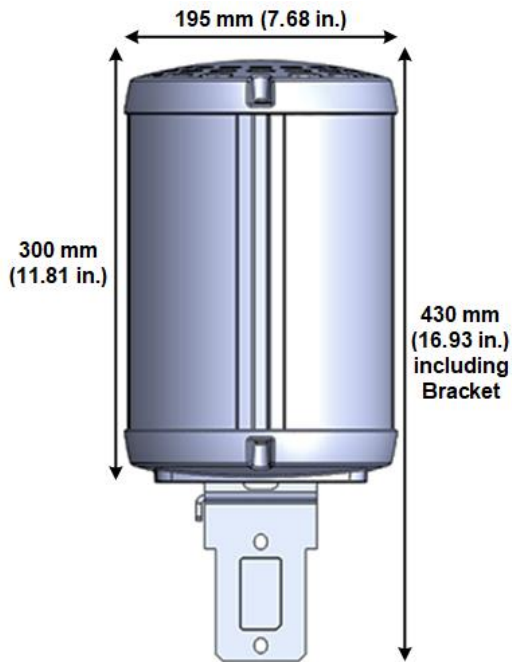

#### 3.1 AirSpeed 1050 Physical Dimensions

Table 6. AirSpeed 1050 Physical Dimensions

	Dimensions (H x D)	Comment
Dimensions	195 x 430 mm (7.68 x 16.93in.) – including bracket	The physical dimensions exclude connectors
	195 x 300 mm (7.68 x 11.1in.) – without bracket	
Volume	9.L	
<b>Weight</b>		
Main Unit	5.3Kg (11.68Lbs.)	



## 3.2 Bottom View

The following figure shows the AirSpeed 1050 from the bottom.

Figure 4: AirSpeed 1050 Bottom

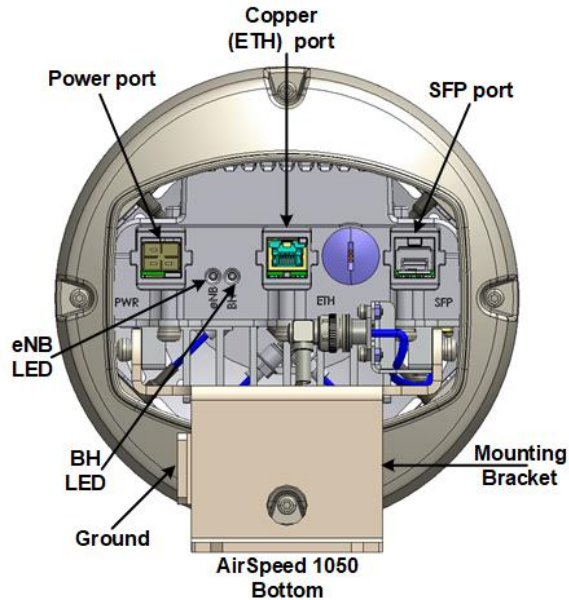

## 3.3 Power

AirSpeed 1050 supports direct connection to DC or AC power source variants.

Operational Voltage Range:

- DC - 40.5 to 57.0 VDC
- AC - 100~240 VAC, 50-60Hz, 2.5A

### 3.3.1 Environmental

**Note:** AirSpeed 1050 is not meant to be used in a Marine environment.

AirSpeed 1050 meets the following environmental requirements:

- GR-63 Storage and Transportation
- ETSI EN 300-019-1-4 Operational (non-weather protected equipment)
- ETSI EN 300-019-1-1 Storage (weather protected, not temperature controlled locations)
- ETSI EN 300-019-1-2 Transportation

Table 7. AirSpeed 1050 Environment Compliance

Type	Details
Operating temperature	-40°C to 55°C / -40°F to 131°F
Operating humidity	5% - 100% non-condensing
Storage temperature	-40°C to 70° C / -40°F to 158°F

Type	Details
Rain and dust ingress protection	IP66

---

## 4 Installation of AirSpeed 1050

### 4.1 Mounting

AirSpeed 1050 is installed on a pole (side or top) or wall and comes fully assembled. Prior to installation of the AirSpeed unit the mounting bracket must first be affixed in place on the Pole or Wall.

**Caution:** Proper local rigging and hoisting practices should be followed when installing the AirSpeed 1050.

**Note:** When installing the unit, a minimum gap of at least 35cm above the unit (so as to NOT block airflow) and a minimum gap of 20cm below the unit should be kept. In the event of any heat radiating source below the unit widen the gap.

**Recommended:** When installing the unit, care should be taken so that the unit should be distanced from any obstructions above that can interfere with “clear sky” conditions needed for good GPS reception. In the event this is unavoidable there is the option to use a remote GPS installation using an external antenna.

**Note:** There should be no other devices mounted on either side of the unit so as NOT to interfere with the antennas.

**Note:** Installation should take into consideration the antenna(s) and Sector(s) direction for maximum coverage.

**Note:** Pole installation should be so the antenna(s) are positioned parallel to the street for maximum coverage.

Figure 5: Positioning Overview

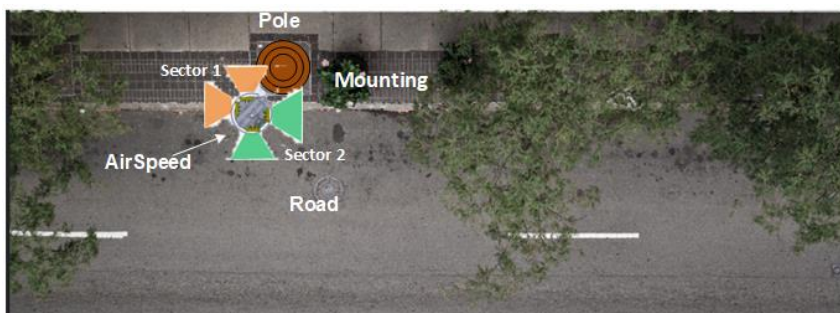

### 4.1.1 Pole Mount Assembly

The following images show the pole mount assembly on a pole.

1. Select the location on the pole to mount the AirSpeed 1050 mounting clamp bracket. You can attach the AirSpeed 1050 to any pole from 63-406mm (1/2-16in) or 51-178mm (2-7in) pole diameter, (dependent on the mounting kit).
2. Position the mounting clamp bracket as shown below.
3. Insert the clamp bands by passing them through the upper slots and the lower slots in the bracket, in two (2) places.
4. When in the required position, tighten the clamp bands with a large screw driver.

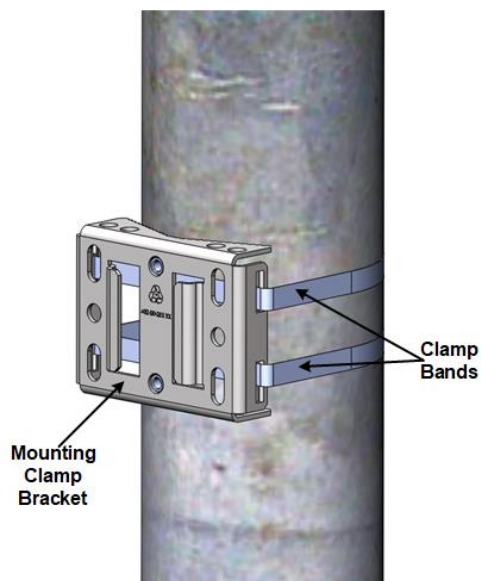

5. The mounting bracket is installed and ready for AirSpeed 1050 installation.

## 4.1.2 Wall Mount Assembly

The following images show the bracket wall mount assembly.

1. Select the location on the wall to mount the AirSpeed 1050 mounting bracket.
2. Position the mounting clamp bracket as shown below. Be sure to position the mounting bracket straight with **level mounting** to ensure the unit sits uniformly.
3. Mark the wall through the holes on the mounting bracket at the required height.
4. Attach the mounting bracket to the wall using wall plugs (x4) and appropriate screws rated for at least 8-10 Kg per fastener.

**Note:** Wall plugs (x3) and necessary hardware are **not** supplied by Airspan and are the responsibility of the installer. Recommended 3/8" dia. with appropriate wall plugs according to field conditions.

Figure 6: Mounting Bracket on Wall

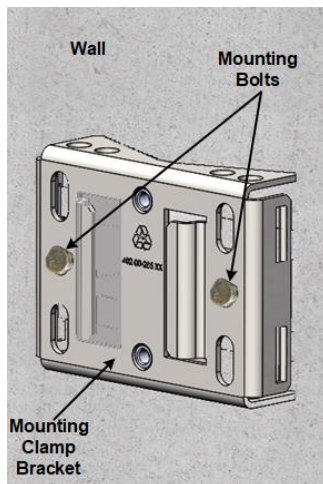

The mounting bracket is installed and ready for AirSpeed 1050 installation.

### 4.1.3 Securing the Unit to the Mounting Clamp Bracket

To mount the AirSpeed unit onto the Mounting Clamp Bracket, perform the following:

1. Lift the unit and slide the Mounting Bracket onto the Mounting Clamp Bracket.
2. Slide the unit downward until the two (2) holes in the Mounting Bracket line up with the two (2) M8 threaded holes in the Mounting Clamp Bracket.

Figure 7: Assembly on Pole

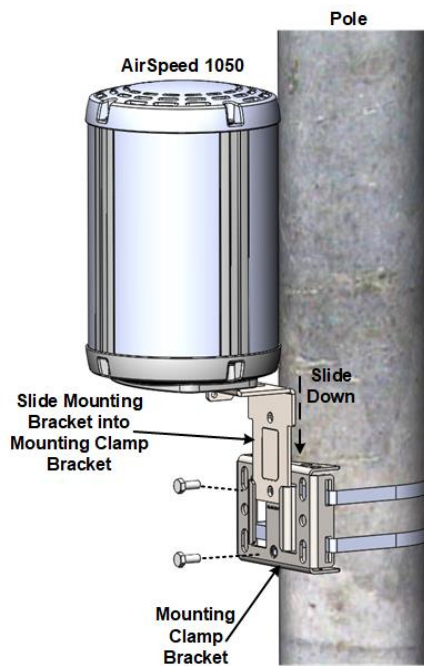

3. Insert the two (2) Hex-Head (M8x20) bolts in the threaded holes and tighten to a torque of no more than 14 Nm (10 ft-lb) max.

Figure 8: AirSpeed 1050 on Pole (Shown Wired)

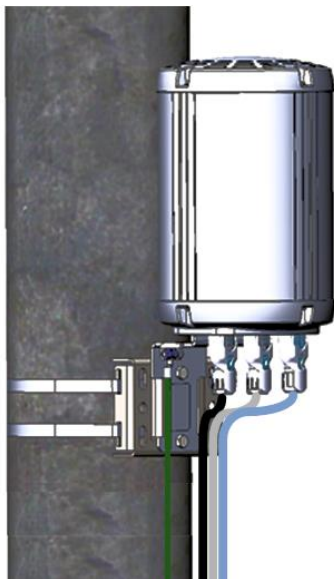

AirSpeed 1050 can also be mounted on top of pole, as shown below (for example).

**Note:** Extension pole and any required hardware for mounting on top of a pole are not included in should be obtained by the installer.

---

**Figure 9: AirSpeed 1050 on Top Pole - Example (Shown Wired)**



---

AirSpeed 1050 mounted on a wall.

---

**Figure 10: AirSpeed 1050 on Wall**

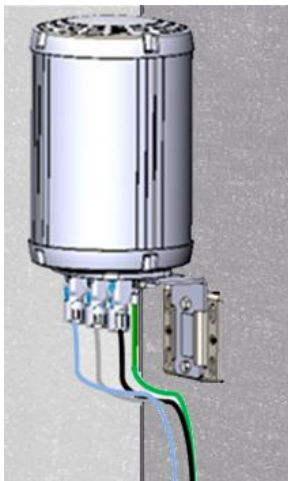

## 5 Connect and Manage Cables

### 5.1 Connecting the Ground Cable

Connect the ground lug with the ground cable (not supplied) to the M6 threaded bolt on the bracket assembled on the unit clearly marked with the universal ground symbol.

**Note:** Cutting the ground cable to the required length and crimping the grounding lug is performed by the Installer.

The cable should be grounded according to international or local standards.

Figure 11: Ground Connection

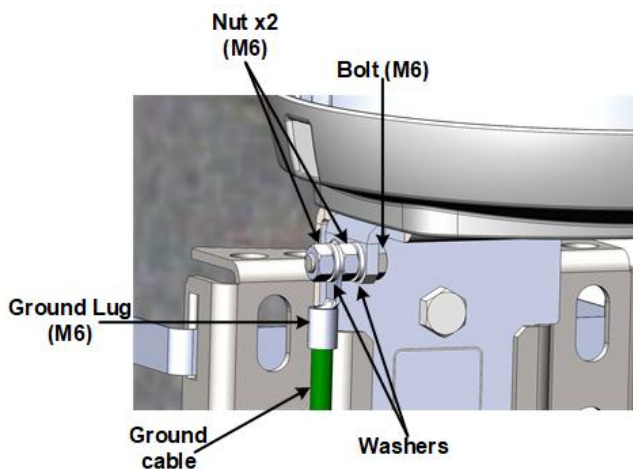

### 5.2 Cable Connection

The following explains the general instructions on how to connect a power cable (DC & AC) and the SFP & Copper Ethernet cables to the AirSpeed 1050 unit.

**Danger: Hazardous voltage!** Before working, ensure that the power is removed from the power connection cables. When the system is powered on, **do not touch the power terminals.**

Airspan recommends the following outdoor Power cable requirements – Cable, 3C, SJOOW, 18AWG, Stranded, Outdoor.

Table 8: Outdoor Power Cable Requirements

Outdoor Power Cable
18 AWG
Jacket 300V
Water Resistant
UV Resistant



**Tip:** It is good practice to label both ends of the cable to identify which AirSpeed 1050 unit it is connected to.

**Tip:** It is good practice to leave a spare loop of cable (approximately 0.5m). This will allow for easier wiring and will allow the cable to be re-terminated if necessary in the future.

**Note:** When securing the cable make sure there is no tension on the cable so that it is easy to disconnect and re-connect for future maintenance actions.

## 5.2.1 AC Cable Preparation

**Caution:** Safety - Disconnection of power supply

- When AirSpeed unit is connected directly to wiring a suitably rated and easily accessible circuit breaker shall be incorporated externally to the equipment.
- Power source disconnection is required before disconnecting the power connector.

**Warning:** This unit incorporates **double pole/neutral fusing**. Both the Line & Neutral have fuses in them.

**Warning:** The onsite source circuit breaker (6A) should be gang operated, **two (2) pole** (single phase type).

**Note:** Required AC power cable – 3 wire - 18 AWG within a pipe enclosure, connected directly to the building electrical power supply.

The following displays the proper steps for AC cable preparation:

1. Strip back and remove the outer sheath to expose the inner insulated wires to a length of 34mm max (1.34 in). Then strip back  $8\text{mm} \pm 2$  (0.31 in) of the inner core insulation.

Figure 12: Stripping Dimensions (AC Cable)

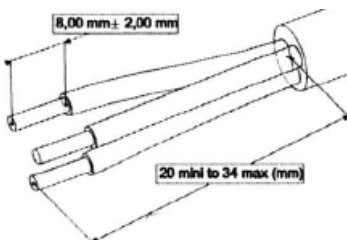

2. Open the housing lock by sliding up then lift the clamp handle.

Figure 13: Open Housing Lock

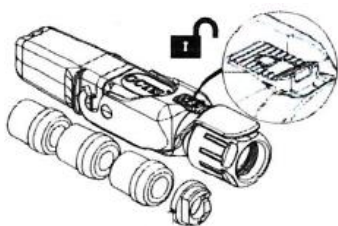

3. Separate the housing into its component sections.

Figure 14: Separate into Sections

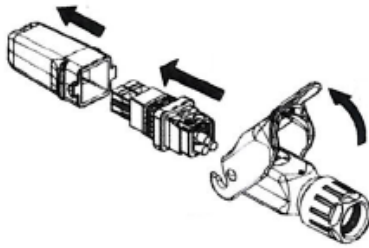

4. Insert the Gland nut through the other end of the cable.

Figure 15: Insert Gland Nut

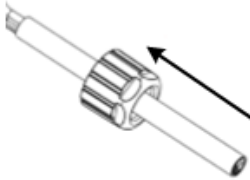

5. Feed the end of the source power cable through the housing of the AC connector.

Figure 16: Pass Cable Through

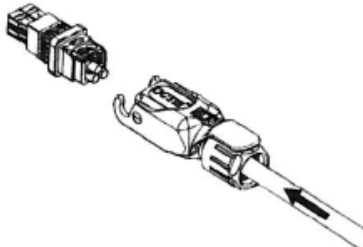

6. Insert the prepared ends of the cable into the inner part of the connector housing.

**Caution:** Verify the wire polarity before securing.

Figure 17: Insert Wire to Housing

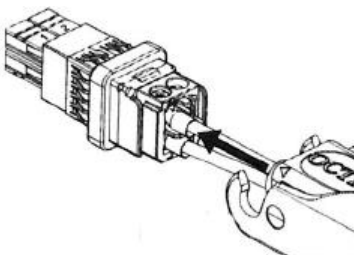

7. Verify the wires are in their correct stations.

Figure 18: AC Wire Placement

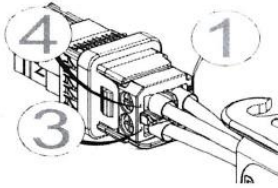

8. Tighten the three (3) set screws as shown below.

Figure 19: Tighten Three (3) Set Screws

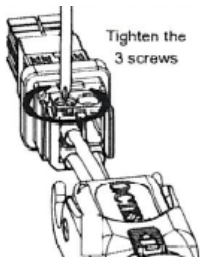

9. Insert into outer housing until “click” in place, align marks for proper alignment.

Figure 20: Cable Click in Place

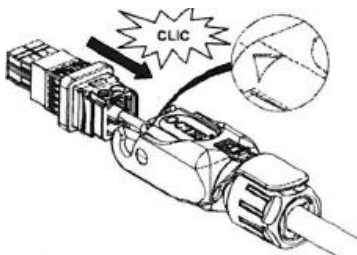

10. Place the split rubber gland onto the cable.

Figure 21: Place Split Rubber Gland

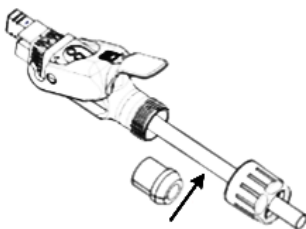

- Verify the gland size as shown below.

Table 9: Recommended Gland Size

Diameter	Recommended Gland Size
From 6.6min to 7.95 Max	"Φ8"
From 7.5min to 8.95 Max	"Φ9"
From 8.6min to 9.95 Max	"Φ10"
From 10.3min to 11.03 Max	"Φ11.5"

**Note:** The gland size is written on the edge of the gland.

Figure 22: Gland Size on Edge

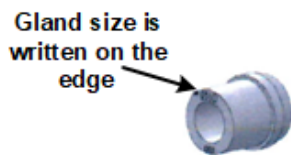

**Note:** The tolerances of the diameter should be taken into account to make sure it is always within the specified range.

- Place the tightening cone onto the split rubber gland.

Figure 23: Place Tightening Cone on Split Gland

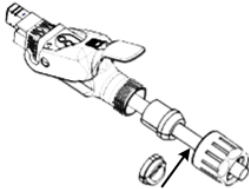

- Secure the Gland nut on to the body forcing the seal to compress around the power cable, then tighten the Gland nut with a 21mm wrench.

**Caution:** Do not over tighten the Gland nut. The Gland nut should be tightened to a torque of **no** more than 2.5-3.0 Nm (1.84 – 2.21 ft-lb) max.

Figure 24: Tighten Gland Nut

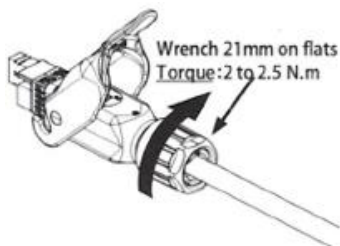

14. After tightening the gland nut, close the lever.

Figure 25: Close the Lever

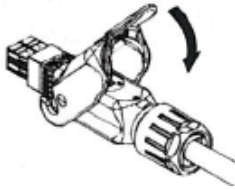

15. Secure the lock by sliding the secondary lock/button; assembly is now ready

Figure 26: Secure Lock

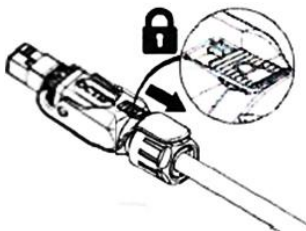

**Note:** When securing the cable verify there is no tension on the connector so that it is easy to disconnect and re-connect for future maintenance actions.

**Note:** After locking the secondary lock/button and lever, it is required to fasten down the lever mechanism with the supplied metal tie (to prevent easy opening) and verify that it is secure, as shown in [Figure 68: AC Housing Lock Secured](#).

## 5.2.2 DC Cable Preparation

The following displays the proper steps for DC cable preparation:

1. Strip back and remove the outer sheath to a length of  $9.0\text{mm} \pm 2$  (0.35 in) to expose the inner insulated wires to a length of  $13.5\text{mm} \pm 2$  (0.53 in). Then strip back  $7\text{mm} \pm 2$  (0.27 in) of the inner core insulation.

Figure 27: Stripping Dimensions (DC Cable)

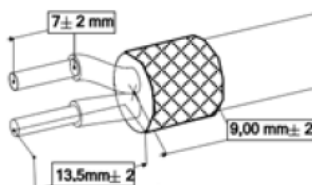

2. Open the housing lock by sliding up then lift the clamp handle.

Figure 28: Open Housing Lock

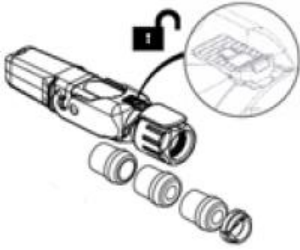

3. Separate the housing into its component sections.

Figure 29: Separate into Sections

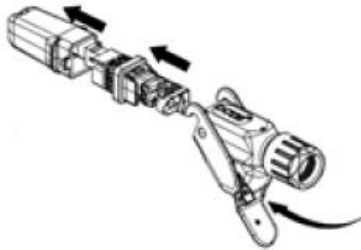

4. Insert the Gland nut through the other end of the cable.

Figure 30: Insert Gland Nut

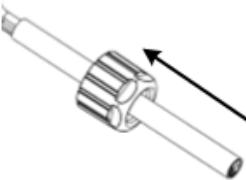

5. Loosen the strap clamp and feed the prepared end of the source power cable into the inner part of the DC connector housing.

Figure 31: Pass DC Cable Thru

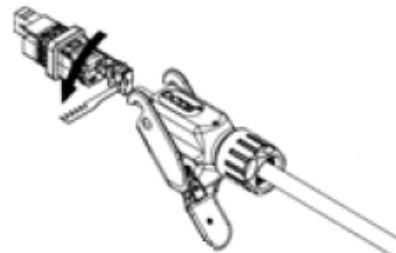

6. Secure the prepared ends of the cable into the inner part of the connector housing and tighten the 2 screws.

**Caution:** Verify the wire polarity before securing.

**Figure 32: Tighten Two (2) Set Screws**

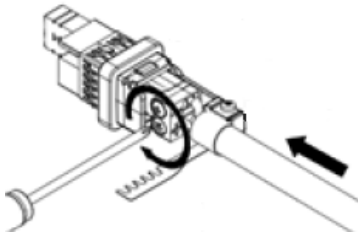

7. Tighten the strap clamp screw as shown below.

**Figure 33: Tighten the Strap Clamp**

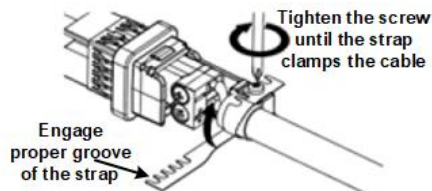

8. Insert into outer housing until "click" in place, align marks for proper alignment.

**Figure 34: Align Marks + Click in Place**

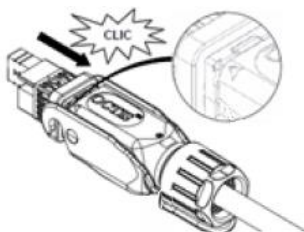

9. Place the split rubber gland onto the cable.

**Figure 35: Place Split Rubber Gland**

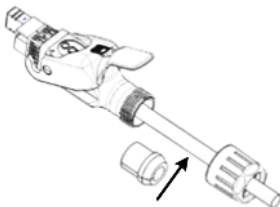

For recommended gland size see Table 9: Recommended Gland Size

**Note:** The gland size is written on the edge of the gland.

Figure 36: Gland Size on Edge

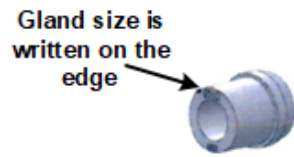

**Note:** The tolerances of the diameter should be taken into account to make sure it is always within the specified range.

10. Place the tightening cone onto the split rubber gland.

Figure 37: Place Tightening Cone on Split Gland

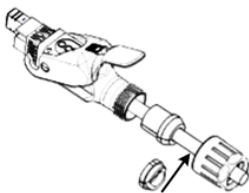

11. Tighten the gland nut with a 21mm wrench, to a torque of no more than 2-2.5 Nm (1.47 – 1.84 ft-lb) max.

Figure 38: Tighten gland Nut

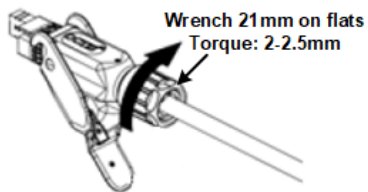

12. After tightening the gland nut, close the lever.

Figure 39: Close the Lever

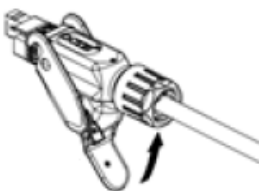



13. Secure the lock by sliding the secondary lock/button; assembly is now ready.

Figure 40: Secure Housing Lock

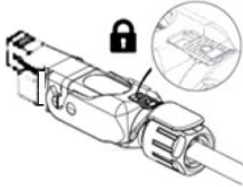

**Note:** When securing the cable verify there is no tension on the connector so that it is easy to disconnect and re-connect for future maintenance actions.

### 5.2.3 Fiber Ethernet (SFP) Cable Preparation

**Note:** Additional parts required for the SFP assembly:

- LC Duplex cable assembly
- SFP Transceiver

The following displays the proper steps for SFP cable preparation:

1. Have the pre-assembled LC Duplex cable assembly ready.

**Note:** Diameter of cable is in the 5 to 7mm (0.20-0.28) range.

Figure 41: Pre-assembled LC Duplex Cable

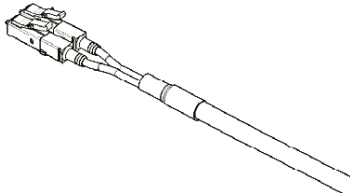

2. Open the housing lock by sliding up then lift the clamp handle,

Figure 42: Open Housing Lock

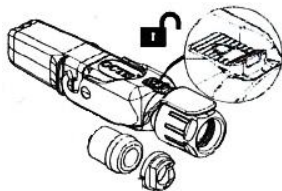

3. Separate the housing into its component sections.

4. Insert the gland nut through the front end of LC Duplex assembly.

Figure 43: Gland Nut on Cable

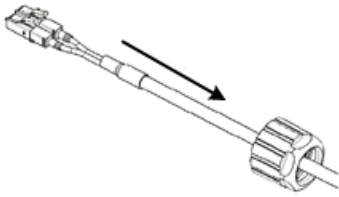

5. Insert the “split tightening cone” from the side of the cable.

Figure 44: Insert Tightening Cone on Cable

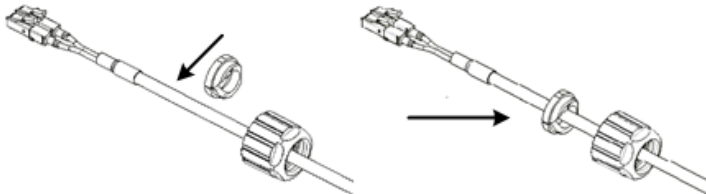

6. Insert the “split rubber gland” from side of the cable.

For recommended gland size see Table 9: Recommended Gland Size

**Note:** Inner diameter of rubber gland is in the range of 6 to 8mm (0.20-0.31) range.

Figure 45: Insert Rubber Gland on Cable

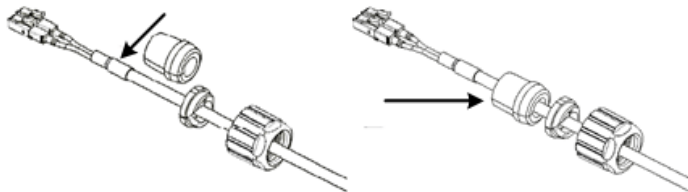

7. Pass the LC Duplex cable thru the housing.

Figure 46: Pass Cable thru Housing

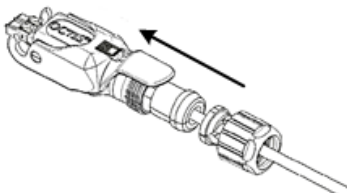

8. Insert the LC Duplex cable into the transceiver. A “click” is heard when engaged.

**Figure 47: Insert Cable into Transceiver**

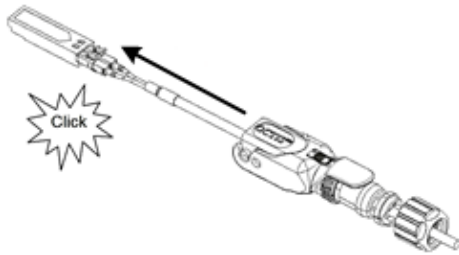

9. Insert the holder subset section from the front end of Transceiver.

**Figure 48: Insert Holder over the Transceiver**

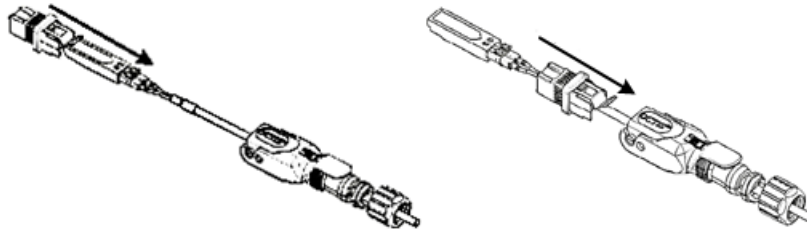

10. Fix the holder into the housing base. A “click” is heard when engaged.

**Figure 49: Holder into Housing Base**

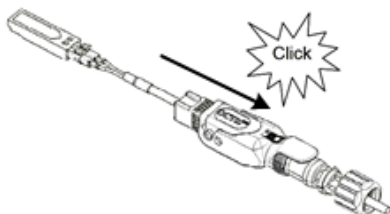

11. Secure the holder into the transceiver, “click” when engaged.

**Figure 50: Holder into Transceiver**



12. Lift the lever of housing base slightly so that the rubber gland, tightening cone and gland nut can be inserted and tightened correctly.

Figure 51: Lift Lever

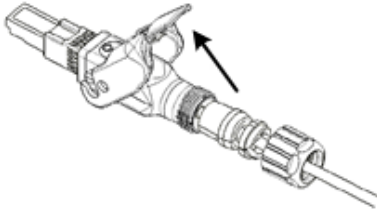

13. Push to insert the rubber gland.

Figure 52: Insert Gland

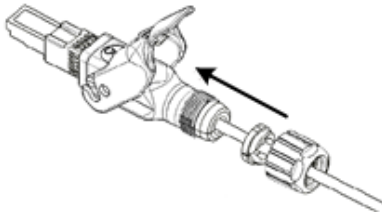

14. Push to insert the tightening cone.

Figure 53: Insert Cone

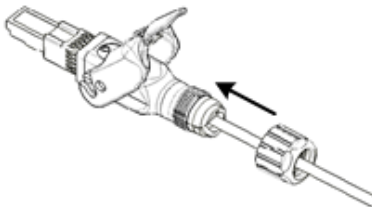

15. Tighten the gland nut with a 21mm wrench, to a torque of no more than 2-2.5 Nm (1.47 – 1.84 ft-lb) max.

Figure 54: Tighten Gland Nut

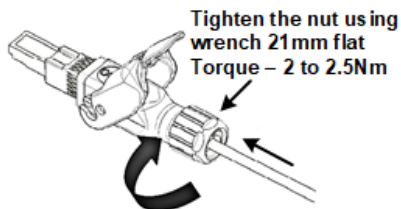

- Secure the lock by sliding the secondary lock/button, so that lever can't be lifted; assembly is now ready for insertion.

**Figure 55: Secure Housing Lock**

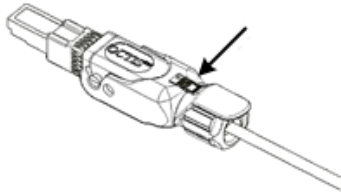

## 5.2.4 Copper Ethernet Cable Preparation

**Note:** A pre-assembled RJ45 cable is required for the Copper Ethernet assembly.

The following displays the proper steps for the Copper (ETH) cable preparation:

- Have the pre-assembled RJ45 cable assembly ready.

**Note:** Diameter of cable is in the 6 to 7mm (0.24-0.28) range.

**Figure 56: Pre-assembled RJ45 Cable**

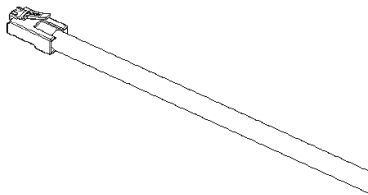

- Insert the gland nut through the front end of RJ45 assembly.

**Figure 57: Gland Nut on Cable**

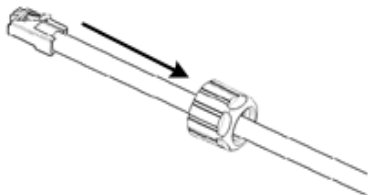

- Insert the "split tightening cone" from the side of the cable.

For recommended gland size see Table 9: Recommended Gland Size

**Figure 58: Insert Tightening Cone on Cable**

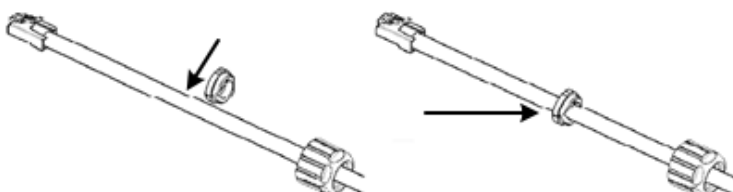

4. Insert the “split rubber gland” from side of the cable.

**Note:** Inner diameter of rubber gland is in the range of 7 to 8mm (0.28-0.31) range.

**Figure 59: Insert Rubber Gland on Cable**

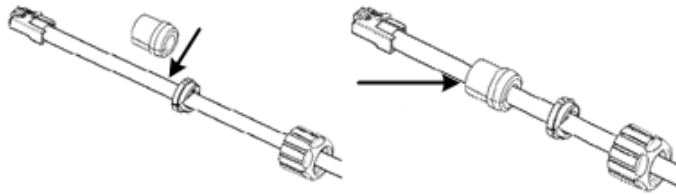

5. Insert the housing onto the RJ45 cable.

**Figure 60: Insert Housing onto Cable**

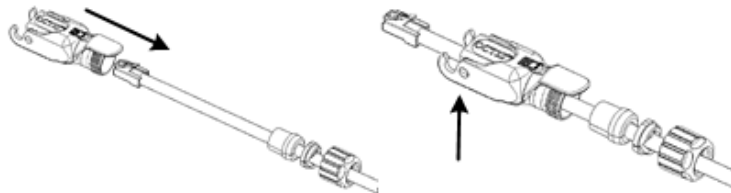

6. Insert the holder section onto the front of the RJ45.

**Figure 61: Insert Holder onto RJ45**

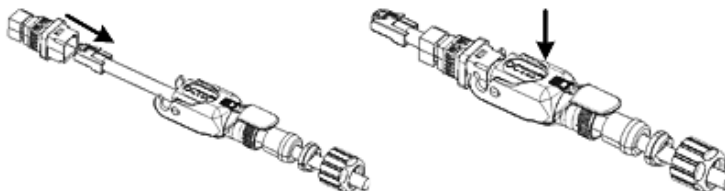

7. Fix the holder into the housing base. A “click” is heard when engaged.

**Figure 62: Holder into Housing Base**

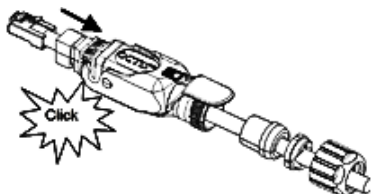

8. Ensure correct alignment of the RJ45 in the hosing by raising the lever to allow free movement and then push the RJ45 plug into the plug cap to ensure proper location, then lock the cap.

Figure 63: Align RJ45 into Holder

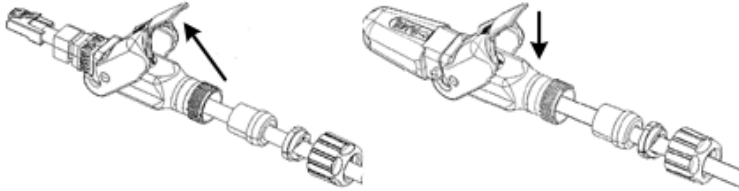

9. Lift the lever of housing base slightly so that the rubber gland, tightening cone and gland nut can be inserted and tightened correctly.

Figure 64: Lift Lever

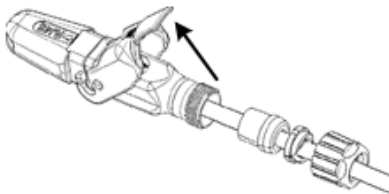

10. Push the rubber gland to insert in place then push the tightening cone to insert in place.

Figure 65: Insert Gland

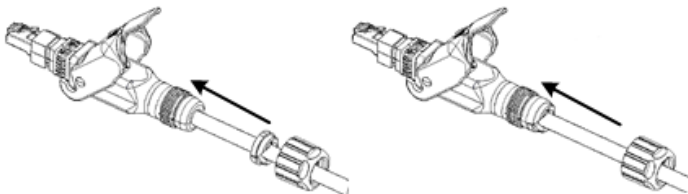

11. Tighten the gland nut with a 21mm wrench, to a torque of no more than 2-2.5 Nm (1.47 – 1.84 ft-lb) max.

Figure 66: Tighten Gland Nut

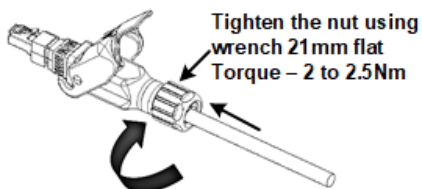

12. Close the lever and secure the lock by sliding the secondary lock/button, so that lever can't be lifted; assembly is now ready for insertion.

Figure 67: Secure Housing Lock

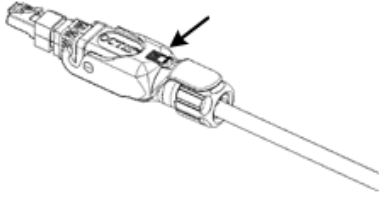
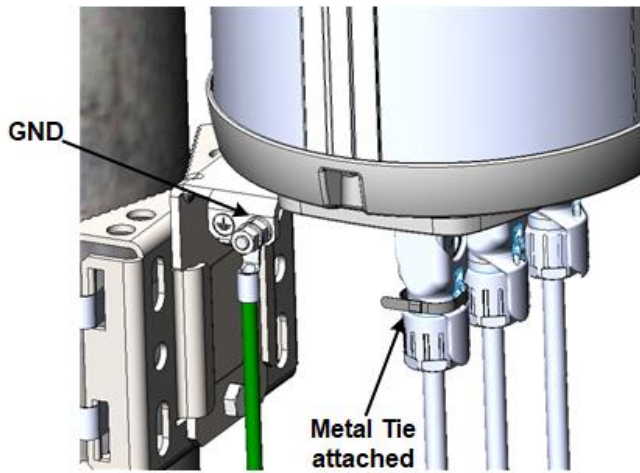

Figure 68: AC Housing Lock Secured





## A Job Sheet

This job sheet enables the users to keep track of their installation. It covers all the prerequisites required for accomplishing the AirSpeed 1050 installation.

Site Requirements
<ul style="list-style-type: none"> <li>○ Pole or Wall for installation identified</li> <li>○ Position on pole or wall identified</li> <li>○ Access restrictions (highway regulations, other services on pole, power pole)</li> <li>○ Method of reaching desired positions (ladders, Elevated work platform)</li> <li>○ Main fuse block available (where needed)</li> <li>○ Configuration programming details known</li> <li>○ All equipment items available at the installation site               <ul style="list-style-type: none"> <li>○ AirSpeed 1050 unit + mounting kit</li> </ul> </li> </ul>
Tools (For further information, see <a href="#">Verify the Tools.</a> )
<ul style="list-style-type: none"> <li>○ Large flat screw driver for pole clamps</li> <li>○ Small flat blade screw driver (insulated shaft recommended)</li> <li>○ Appropriate wrench's for unit assembly</li> <li>○ Knife</li> <li>○ pliers</li> <li>○ Small side cutters</li> <li>○ Tweezers (or fine blade long nose pliers)</li> <li>○ Wire strippers</li> </ul>
Required Ancillary Equipment
<ul style="list-style-type: none"> <li>○ Laptop PC for initial configuration</li> <li>○ cable for temporary connection of the lap top</li> </ul>

## B Abbreviations

<b>Term</b>	<b>Definition</b>
AC	Alternating Current
BH	Backhaul
DC	Direct Current
eNb	eNodeB
ETH	Ethernet (cable)
FDD	Frequency Division Duplex
FTP	File Transfer Protocol
LTE	Long Term Evolution, marketed as "4G LTE", is a standard for wireless communication of high-speed data for mobile phones and data terminals
NEC	National Electric Code
UE	User Equipment
WEEE	Waste Electrical and Electronic Equipment