



UGD-D00234 Rev C1

SSRM Module User Guide



Acknowledgements

Airspan Networks Inc. acknowledges the following trademarks used within this document:

 © Intel Corporation <http://www.intel.com/>

 © Microsoft Corporation <http://www.microsoft.com>

 © SEQUANS COMMUNICATIONS <http://www.sequans.com>

Copyright

© Copyright by **Airspan Networks Inc.**, 2012. All rights reserved worldwide.

The information contained within this document is proprietary and is subject to all relevant copyright, patent and other laws protecting intellectual property, as well as any specific agreements protecting Airspan Networks Inc. rights in the aforesaid information. Neither this document nor the information contained herein may be published, reproduced or disclosed to third parties, in whole or in part, without the express, prior, written permission of Airspan Networks Inc. In addition, any use of this document or the information contained herein for the purposes other than those for which it is disclosed is strictly forbidden.

Airspan Networks Inc. reserves the right, without prior notice or liability, to make changes in equipment design or specifications.

Information supplied by Airspan Networks Inc. is believed to be accurate and reliable. However, no responsibility is assumed by Airspan Networks Inc. for the use thereof nor for the rights of third parties which may be effected in any way by the use of thereof.

Any representation(s) in this document concerning performance of Airspan Networks Inc. product(s) are for informational purposes only and are not warranties of future performance, either expressed or implied. Airspan Networks Inc. standard limited warranty, stated in its sales contract or order confirmation form, is the only warranty offered by Airspan Networks Inc. in relation thereto.

This document may contain flaws, omissions or typesetting errors; no warranty is granted nor liability assumed in relation thereto unless specifically undertaken in Airspan Networks Inc. sales contract or order confirmation. Information contained herein is periodically updated and changes will be incorporated into subsequent editions. If you have encountered an error, please notify Airspan Networks Inc. All specifications are subject to change without prior notice.

Product performance figures quoted within this document are indicative and for information purposes only.

Table of Contents

| | |
|---|----|
| Acknowledgements | 2 |
| Copyright..... | 2 |
| Table of Contents..... | 3 |
| Summary of Figures..... | 5 |
| Summary of Tables | 6 |
| Warnings and Cautions..... | 7 |
| Human Exposure to Radio Frequencies | 7 |
| Radio Interference..... | 7 |
| Modifications | 7 |
| General..... | 7 |
| Disclaimer Statement | 7 |
| DECLARATION OF CONFORMITY | 8 |
| FCC Notice..... | 10 |
| Federal Communication Commission Notice | 10 |
| Limitations | 10 |
| Labeling Requirement | 10 |
| Maximum Output TX Power | 11 |
| Antenna Types | 11 |
| SSRM Antenna Usage | 11 |
| 1 About this Guide | 13 |
| 1.1 Purpose | 13 |
| 1.2 Conventions..... | 13 |
| 2 Overview | 14 |
| 2.1.1 Main Features..... | 14 |
| 2.2 WiMAX Management..... | 14 |
| 2.3 SSRM Block Diagram | 14 |
| 3 Installation Prerequisites | 15 |
| 3.1 Package Contents | 15 |
| 4 Physical Description | 16 |
| 4.1 SSRM | 16 |
| 4.1.1 Physical Dimensions..... | 16 |
| 4.2 Connector | 17 |
| 5 Connecting the SSRM Mini PCIe Module | 18 |
| 5.1 Typical SSRM Installation..... | 18 |
| 6 Instillation of Drivers and Software | 19 |
| 6.1 Configuration | 23 |
| 6.2 Connection Manager | 24 |



SSRM Module User Guide



| | | |
|-----|---|----|
| 7 | Appendix..... | 25 |
| 7.1 | SSRM – Power, Environmental, Standards Compliance | 25 |
| 7.2 | Glossary of Terms | 25 |
| 7.3 | Revision History..... | 27 |
| 7.4 | Contact Information | 27 |

Summary of Figures

| | |
|---|----|
| Figure 1 - Block Diagram | 14 |
| Figure 2 – SSRM PCIe module..... | 16 |
| Figure 3 - Mini PCI Connector | 17 |
| Figure 4 - Typical SSRM installation..... | 18 |
| Figure 5 - Setup language | 19 |
| Figure 6 - Setup wizard..... | 19 |
| Figure 7 - Select destination location..... | 20 |
| Figure 8 - Select start menu folder..... | 20 |
| Figure 9 - Additional tasks..... | 21 |
| Figure 10 - Ready to install | 21 |
| Figure 11 – Installing..... | 22 |
| Figure 12 - Installation complete..... | 22 |
| Figure 13 – Services | 24 |
| Figure 14 - WiMAX CM | 24 |



Summary of Tables

| | |
|--|----|
| Table 1 - SSRM FCC Maximum Output TX Power..... | 11 |
| Table 2 - SSRM ETSI Maximum Output TX Power | 11 |
| Table 3 – 1.x, 2.x & 3.x GHz Antenna Types - Technical | 11 |
| Table 4 - Antenna arrays..... | 12 |
| Table 6 - Package Contents | 15 |
| Table 7 - SSRM physical dimensions | 16 |
| Table 8 - Connector 52 pin, pinouts..... | 17 |
| Table 9 - Environment, EMC & Safety | 25 |

Warnings and Cautions

Human Exposure to Radio Frequencies

The WiMAX SSRM Antennas should be installed a minimum distance of 18.9 CM for the 1.4 GHz variant, 36 Cm for the 2.3 GHz variant, 47 Cm for the 2.5 GHz variant and 25.4 Cm for the 3.65 GHz variant from your body.

Radio Interference

This equipment generates, uses, and can radiate radio frequency energy and, if not installed and used in accordance with the instructions, may cause harmful interference to internal vehicle radio communications.

Please ensure a maximum separation between the SSRM's antenna and other antennas.

Modifications

Any changes and modifications to this device that are not expressly approved by Airspan Networks are not permitted and if done will result in voidance of warranty.

General

- Installation, replacement and service should be performed by qualified personnel who are familiar with local safety codes.
- Do not mount external antennas in inclement weather (such as rain or lightning) that may increase risk of electrocution.
- SSRM does not provide protection from hazard energy in case of single fault condition.
- Power supply shall be limited up to 3A in normal and single fault condition.

Disclaimer Statement

The information in this document is subject to change without notice and does not represent a commitment on the part of the vendor. No warranty or representation, either expressed or implied, is made with respect to the quality, accuracy or fitness for any particular purpose of this document. The manufacturer reserves the right to make changes to the content of this document and/or the products associated with it at any time without obligation to notify any person or organization of such changes. In no event will the manufacturer be liable for direct, indirect, special, incidental or consequential damages arising out of the use or inability to use this product or documentation, even if advised of the possibility of such damages. This document contains materials protected by copyright. All rights are reserved. No part of this manual may be reproduced or transmitted in any form, by any means or for any purpose without expressed written consent of its authors. Product names appearing in this document are mentioned for identification purchases only. All trademarks, product names or brand names appearing in this document are registered property of their respective owners.

DECLARATION OF CONFORMITY

European Community, Switzerland, Norway, Iceland, and Liechtenstein Declaration of Conformity with Regard to the R&TTE Directive 1999/5/EC

English:

This equipment is in compliance with the essential requirements and other relevant provisions of Directive 1999/5/EC.

Deutsch:

Dieses Gerät entspricht den grundlegenden Anforderungen und den weiteren entsprechedenen Vorgaben der Richtlinie 1999/5/EU.

Dansk:

Dette udstyr er i overensstemmelse med de væsentlige krav og andre relevante bestemmelser i Directiv 1999/5/EF.

Español:

Este equipo cumple con los requisitos esenciales así como con otras disposiciones de la Directiva 1999/5/EC.

Greek:

ΜΕ ΤΗΝ ΠΑΡΟΥΣΑ Airspan ΔΗΛΩΝΕΙ ΟΤΙ Ο ΕΞΟΠΛΙΣΜΟΣ ΣΥΜΜΟΡΦΩΝΕΤΑΙ ΠΡΟΣ ΤΙΣ ΟΥΣΙΩΔΕΙΣ ΑΠΑΙΤΗΣΕΙΣ ΚΑΙ ΤΙΣ ΛΟΙΠΕΣ ΣΧΕΤΙΚΕΣ ΔΙΑΤΑΞΕΙΣ ΤΗΣ ΟΔΗΓΙΑΣ 1999/5/ΕΚ.

Français:

Cet appareil est conforme aux exigences essentielles et aux autres dispositions pertinentes de la Directive 1999/5/EC.

Íslenska:

Þessi búnaður samrýmist lögboðnum kröfum og öðrum ákvæðum tilskipunar 1999/5/ESB.

Italiano:

Questo apparato é conforme ai requisiti essenziali ed agli altri principi sanciti dalla Direttiva 1999/5/EC.

Nederlands:

Deze apparatuur voldoet aan de belangrijkste eisen en andere voorzieningen van richtlijn 1999/5/EC.

Norsk:

Dette utstyret er i samsvar med de grunnleggende krav og andre relevante bestemmelser i EU-directiv 1999/5/EC.

Português:

Este equipamento satisfaz os requisitos essenciais e outras provisões da Directiva 1999/5/EC.

Suomalainen:

Tämä laite täyttää direktiivin 1999/5/EY oleelliset vaatimukset ja on siinä asetettujen muidenkin ehtojen mukainen.

Svenska:

Denna utrustning är i överensstämmelse med de väsentliga kraven och andra relevanta bestämmelser i Direktiv 1999/5/EC.

Român:

Acest echipament este în conformitate cu cerințele esențiale și alte prevederi relevante ale Directivei 1999/5/CE.



The Declaration of Conformity related to this product can be obtained from
product_management@Airspan.com

FCC Notice

Federal Communication Commission Notice

The United States Federal Communication Commission (FCC) and the Canadian Department of Communications have established certain rules governing the use of electronic equipment. Part 15, Class B.

This device complies with Part 15 of FCC rules. Operation is subject to the following two conditions:

1. This device may not cause harmful interference, and
2. This device must accept any interference received, including interference that may cause undesired operation. This equipment has been tested and found to comply with the limits for a Class B digital device, pursuant to Part 15 of the FCC Rules. These limits are designed to provide reasonable protection against harmful interference in a residential installation. This equipment generates uses and can radiate radio frequency energy, and if not installed and used in accordance with the instructions, may cause harmful interference to radio communications. However, there is no guarantee that interference will not occur in a particular installation. If this equipment does cause harmful interference to radio or television reception, which can be determined by turning off and on, the user is encouraged to try to correct the interference by one or more of the following measures:
 - Reorient or relocate the receiving antenna.
 - Increase the separation between the equipment and receiver.
 - Connect the equipment into an outlet on a circuit different from that to which the receiver is connected.
 - Consult the dealer or an experienced radio/TV technician for help.

Limitations

The SSRM PCIe module is a terminal station intended for use **only** in the (outdoor) Cisco Field Area Router – Cisco 1000 Series.

Antenna Limitations – see [Antenna Types](#)

Labeling Requirement

Cisco 1000 series router exterior label (per appropriate variant) must include wording similar to the following:

- “Contains FCC ID: PIDASMAX1400”
- “Contains FCC ID: PIDASMAX2350”
- “Contains FCC ID: PIDASMAX2500”
- “Contains FCC ID:PIDASMAX3700”

Maximum Output TX Power

Table 1 - SSRM FCC Maximum Output TX Power

| Frequency Band | FCC | | Antenna Gain |
|----------------|----------|----------|--------------|
| | TX | EIRP | |
| 1.4GHz | 26.18dBm | 36.18dBm | 10dBi |
| 2.3 GHz | 26dBm | 42dBm | 16dBi |
| 2.5GHz | 26.94dBm | 44.44dBm | 17.5dBi |
| 3.65GHz | 19.6dBm | 39.1dBm | 19.5dBi |
| 3.65GHz | 26.8dBm | 32.4dBm | 5.6dBi |



Caution: A Cavity filter is required for the SSRM Mini PCIe module FCC ID: PIDASMAX2350 deployment. WEVERCOMM WCS Cavity Filter Part No : WVC-2.3GDB-3.5M01B (ordered separately).

The Cavity filter must be connected between the RF output and the antenna.

Table 2 - SSRM ETSI Maximum Output TX Power

| Frequency Band | ETSI | | Rest of the World | | Antenna Gain |
|----------------|----------|----------|-------------------|----------|--------------|
| | TX | EIRP | TX | EIRP | |
| 1.4GHz | 26.18dBm | 36.18dBm | 26.18dBm | 36.18dBm | 10dBi |
| 2.3 GHz | 26dBm | 42dBm | 26dBm | 42dBm | 16dBi |
| 2.5GHz | 26.94dBm | 44.44dBm | 26.94dBm | 44.44dBm | 17.5dBi |
| 3.65GHz | 26dBm | 45dBm | 26dBm | 45dBm | 19dBi |



Caution: Do not set maximum output TX power to higher than local regulations.

Antenna Types

Table 3 – 1.x, 2.x & 3.x GHz Antenna Types - Technical

| Type | Frequency range | Gain | Part number |
|----------------------------------|-----------------|---------|--------------|
| Dual Slant CPE | 1.3-1.525 GHz | 10dBi | MT-282025/CD |
| Directional Dual-Polarized Panel | 2.3-2.36 GHz | 16dBi | 07-1160-01 |
| Directional Dual-Polarized Panel | 2.5-2.7 GHz | 17.5dBi | 07-1160-01 |
| Directional Dual-Polarized Panel | 3.3-3.8 GHz | 19.5dBi | 07-1161-01 |
| Direct Mount LPT Style | 3.3-3.8 GHz | 5.6dBi | W1982 |

SSRM Antenna Usage

SSRM has two (2) RF ports that can be connected to two single-port antennas



Note: Appropriate mounting kit (included) for the antenna(s) is required.

- Dual polarized antenna with two (2) ports - connected via 2 RF jumper cables.

The following table describes the antenna arrays:

Table 4 - Antenna arrays

| Frequency Band | # of Receivers | Sector | Antenna Type | # of Antennas |
|----------------|----------------|--------|--|---------------|
| 1.4 GHz | 2 | 45° | 1.3-1.525 GHz Dual Slant Antenna - mounting included | 1 |
| 2.3 GHz | 2 | 45° | 2.3-2.36 GHz Dual Polar Antenna - mounting included | 1 |
| 2.5 – 2.7 GHz | 2 | 45° | 2.5-2.7 GHz Dual Polar Antenna - mounting included | 1 |
| 3.3-3.8 GHz | 2 | 45° | 3.3-3.8 GHz Dual Polar Antenna - mounting included | 1 |
| 3.3-3.8 GHz | 2 | Omni | 3.3-3.8 Monopole | 1 |

1 About this Guide





This section discusses the purpose, intended audience, conventions, referenced documentation and organization for this guide.

1.1 Purpose

This User Guide is intended as an instruction manual for professional system integrators to provide step-by-step factory integration instructions for setting up, installing and initial configuration of the SSRM Mini PCIe module. These procedures include:

- System Overview
- Installation Prerequisites
- Physical description
- Connecting
- Initial Device Configurations

1.2 Conventions

| Icon | Description |
|---|---|
|  | Checkpoint: Marks a point in the workflow where there may be an exit or branch to some other procedure. At each Checkpoint the reason for an exit or branch is given along with specific directions to locate the entry point in the other procedure. |
|  | Reference: Gives a resource in the workflow that may be needed to complete a procedure along with specific directions to use the resource. |
|  | Caution: Describes a possible risk and how to lessen or avoid the risk. |
|  | Advice: Provides a recommendation based on best practice. |
|  | Note: Provides useful information. |

2 Overview

The Airspan SSRM Mini PCIe module is a product specific WiMAX module designed to be embedded in the Cisco Field Area Router – Cisco 1000 Series allowing WiMAX connectivity. The Wireless protocols that come with this product ensure data security and isolation from interference generated by other radio frequencies. The SSRM module supports MIMO antenna technology and high power output.

2.1.1 Main Features

The Airspan WiMAX SSRM Mini PCIe module provides the following main features:

- Based on the WiMAX IEEE 802.16e wireless technology.

2.2 WiMAX Management

- Software is upgraded locally and remotely.
- Designed for local and remote management via the Host processor.

2.3 SSRM Block Diagram

The figure below displays a block diagram of the SSRM:

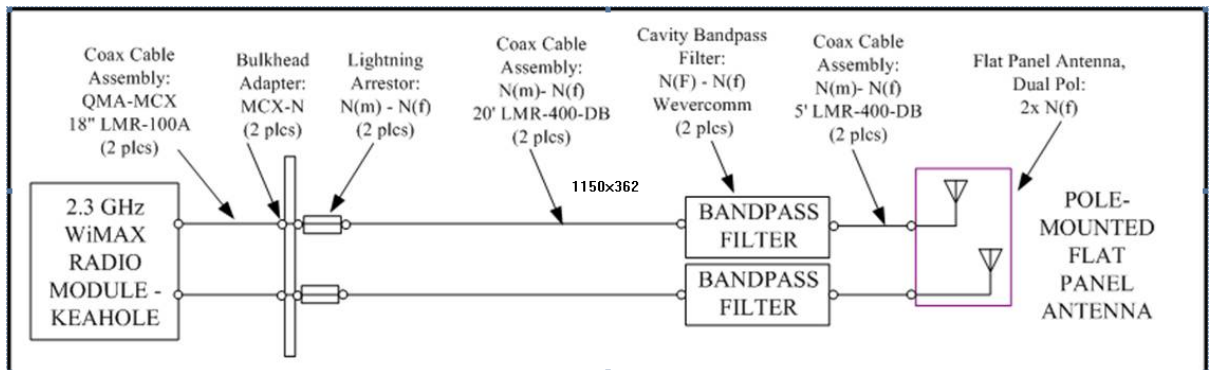

Figure 1 - Block Diagram



Note: The diagram is for illustration purposes only.

3 Installation Prerequisites

Before installing your SSRM, read the following:

3.1 Package Contents

Examine the Airspan WIMAX SSRM shipping container. If you notice any damage, or missing items as listed in the Packing List, immediately notify the carrier that delivered the unit and contact an Airspan representative.

The SSRM kit should contain the following items:

- SSRM Mini PCIe Module

Table 5 - Package Contents

| Name | Quantity | Comments | Image |
|------|----------|-------------|---|
| SSRM | 10 | PCIe module |  |

4 Physical Description

This section provides a description of the components of the SSRM installation:

- [Dimensions](#)
- [Connector](#)

4.1 SSRM

The SSRM Mini PCIe module



Figure 2 – SSRM PCIe module

4.1.1 Physical Dimensions

The table below lists the physical dimensions of the SSRM Mini PCIe module.

Table 6 - SSRM physical dimensions

| Parameter | Value |
|-------------------------------|--|
| Dimensions (W x L x H) | PCIe Mini-Card Form Factor: W: 51 mm (2.01") (including PCIe connector); L: 70 mm (2.36") H: 5.8mm (0.228") (not including RF connectors) |
| Weight | 0.1 Kg Approx. (100 grams Approx.) |

4.2 Connector

The connector is described below:

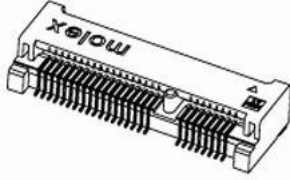

Figure 3 - Mini PCI Connector

Table 7 - Connector 52 pin, pinouts

| Pin | Signal | Pin | Signal |
|-----|--------|-----|---------|
| 1 | | 26 | GND |
| 2 | 5.5V | 27 | GND |
| 3 | | 28 | |
| 4 | GND | 29 | GND |
| 5 | | 30 | |
| 6 | | 31 | |
| 7 | | 32 | |
| 8 | | 33 | |
| 9 | GND | 34 | GND |
| 10 | | 35 | GND |
| 11 | | 36 | |
| 12 | | 37 | GND |
| 13 | | 38 | |
| 14 | | 39 | 5.5V |
| 15 | GND | 40 | GND |
| 16 | | 41 | 5.5V |
| 17 | | 42 | |
| 18 | GND | 43 | GND |
| 19 | | 44 | |
| 20 | | 45 | |
| 21 | GND | 46 | |
| 22 | | 47 | |
| 23 | | 48 | |
| 24 | 5.5V | 49 | |
| 25 | | 50 | GND |
| | | 51 | SQN_RST |
| | | 52 | 5.5V |

5 Connecting the SSRM Mini PCIe Module



Note: Carefully remove the SSRM Mini PCIe module from the packaging box



Caution: It is the responsibility of the person installing the SSRM module to ensure that only those antennas certified for use with the product are used. The use of any antenna other than those certified with the product is expressly forbidden.



Caution: The SSRM module and the antennas must be installed only by experienced installation professionals who are familiar with the local safety codes and are licensed by the appropriate government authorities.

To connect the SSRM Module:

1. Make sure the unit is turned off. Remove the cover from the unit.
2. Carefully slide the SSRM Mini PCIe module into the mini PCI slot. Align the pins and push evenly and slowly and ensure it is properly seated.
3. After the device has been connected, Windows will detect the module and you will be prompted to install the software and drivers.

5.1 Typical SSRM Installation

The following displays a typical installation with the SSRM Mini PCIe module installed.

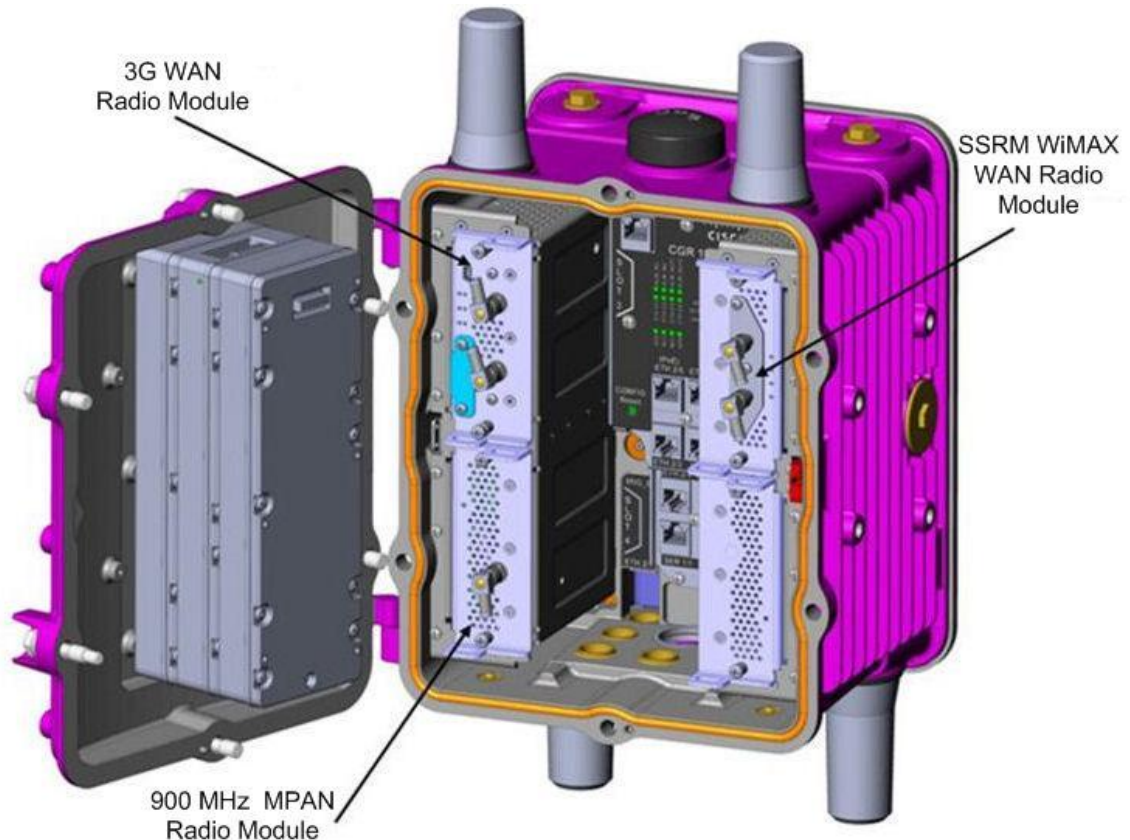

Figure 4 - Typical SSRM installation

6 Instillation of Drivers and Software

1. Exit all Windows programs. After recognizing the USB connection installation will initiate automatically.
2. When prompted select the language to use during the installation.

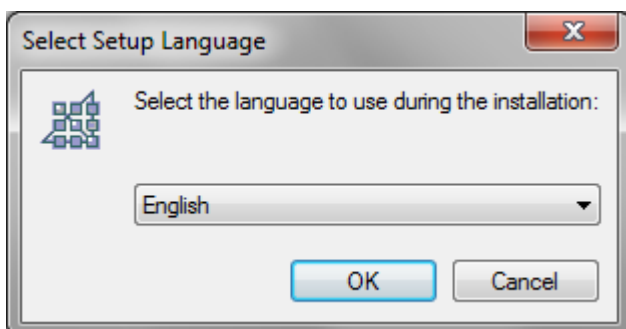

Figure 5 - Setup language

3. Click **OK** to continue.
4. The Setup Wizard will walk you through the process.

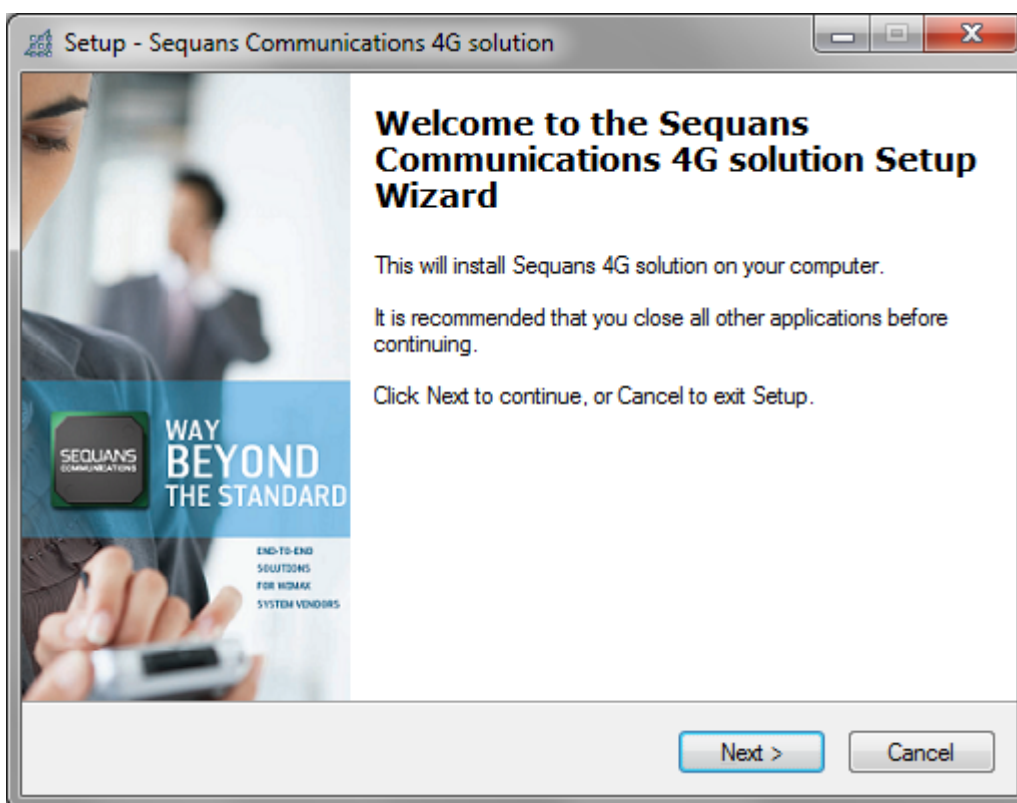

Figure 6 - Setup wizard

5. Click **Next** to continue.

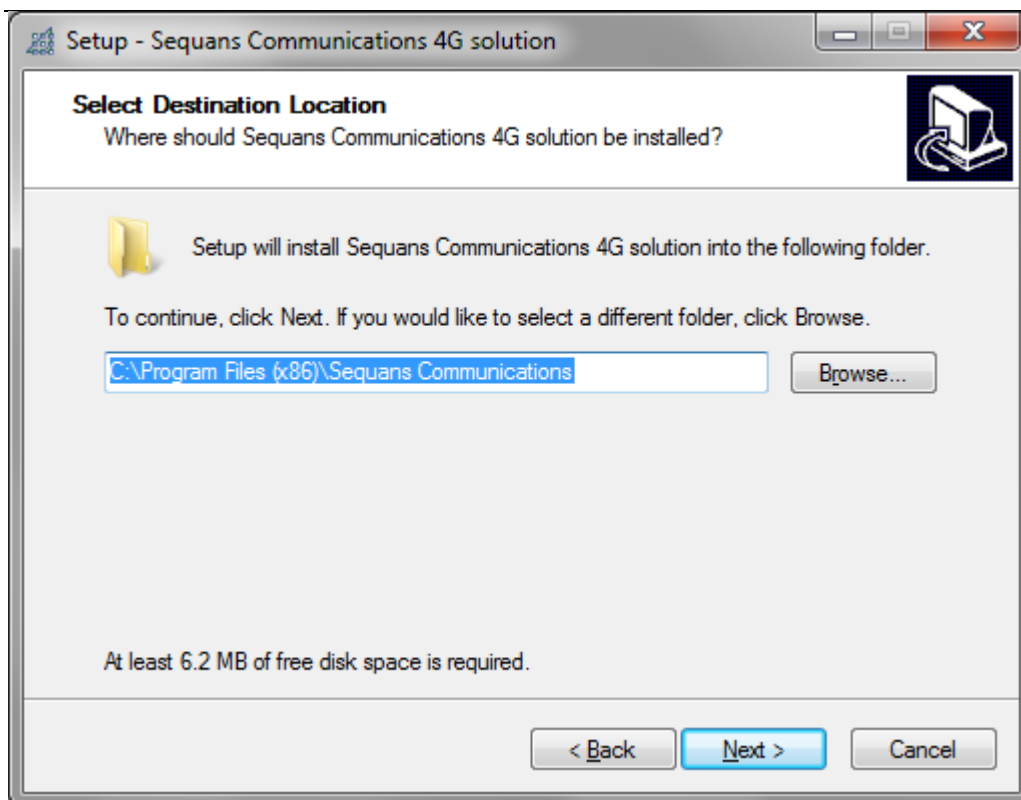

Figure 7 - Select destination location

6. Click **Next** to continue.

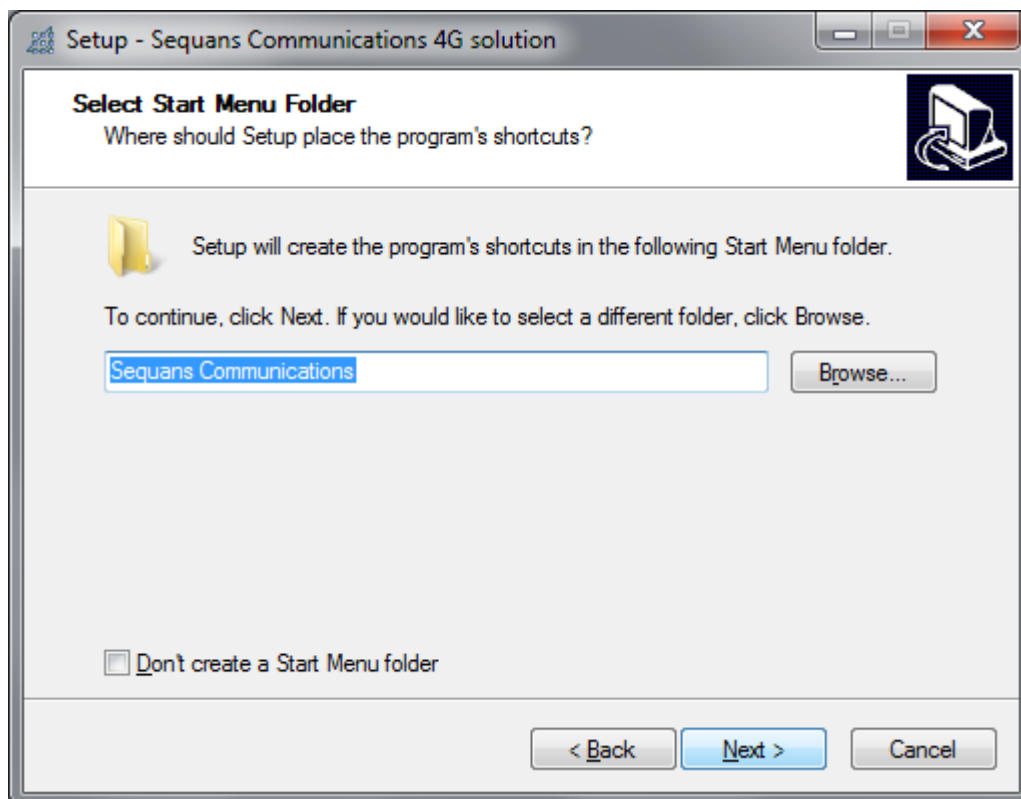

Figure 8 - Select start menu folder

7. Click **Next** to continue.

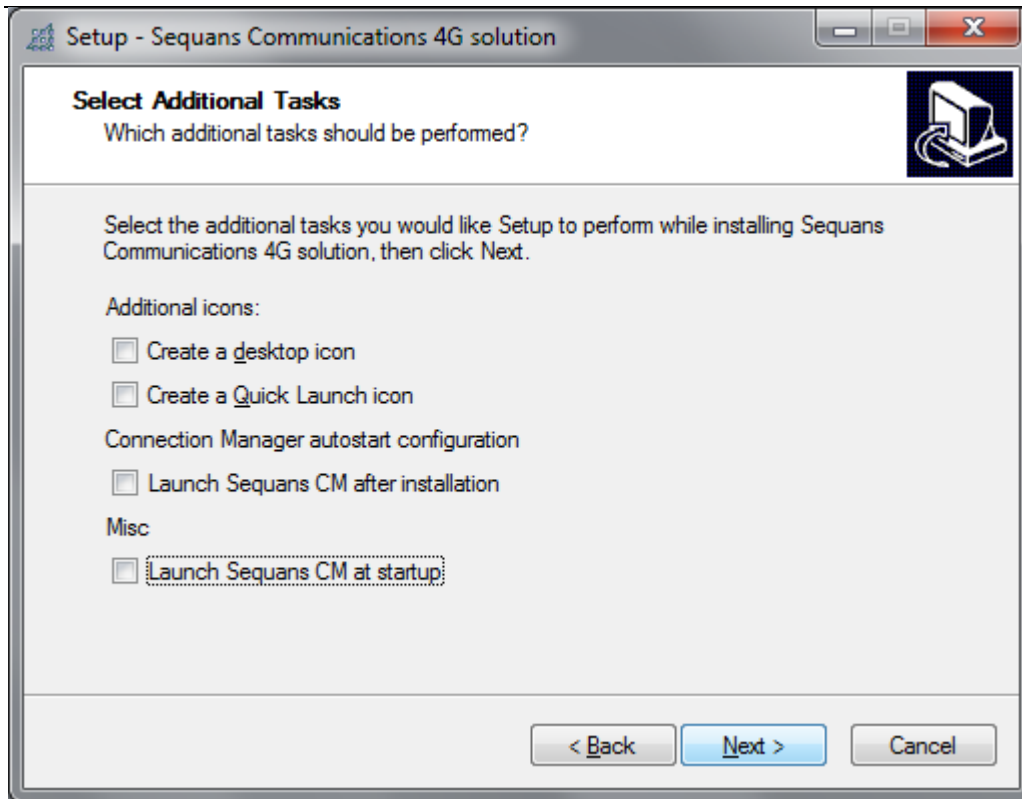

Figure 9 - Additional tasks

8. Select additional tasks, if required.
9. Click **Next** to continue.

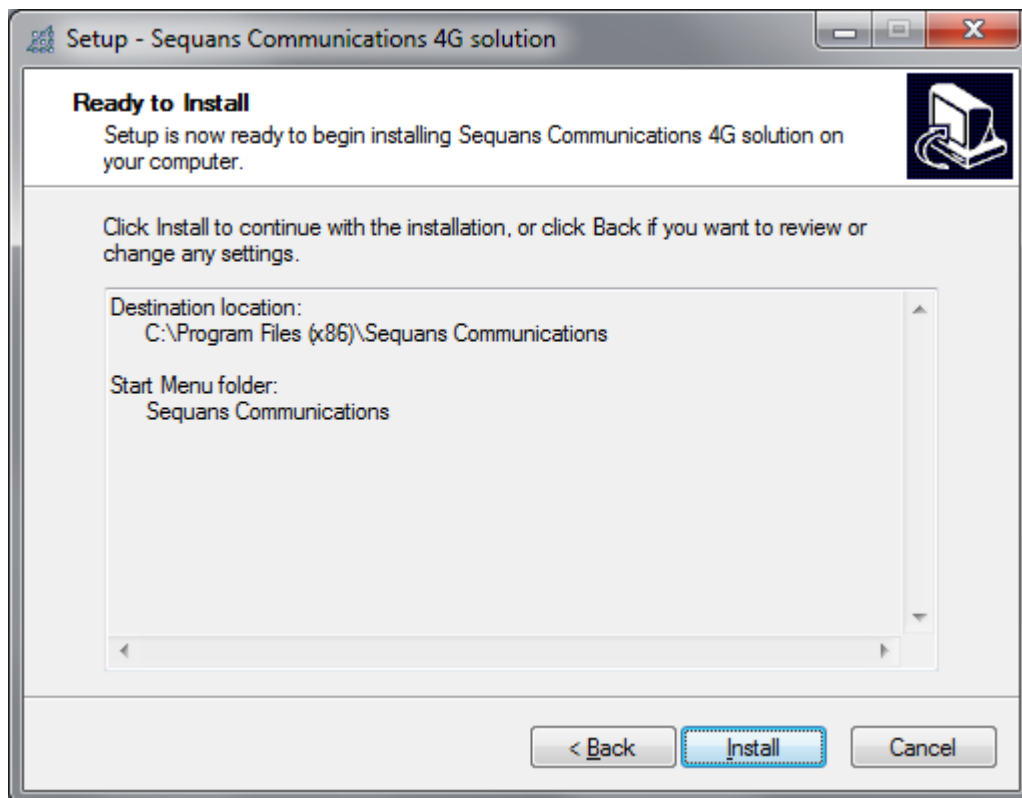

Figure 10 - Ready to install

10. Click Install to continue installation

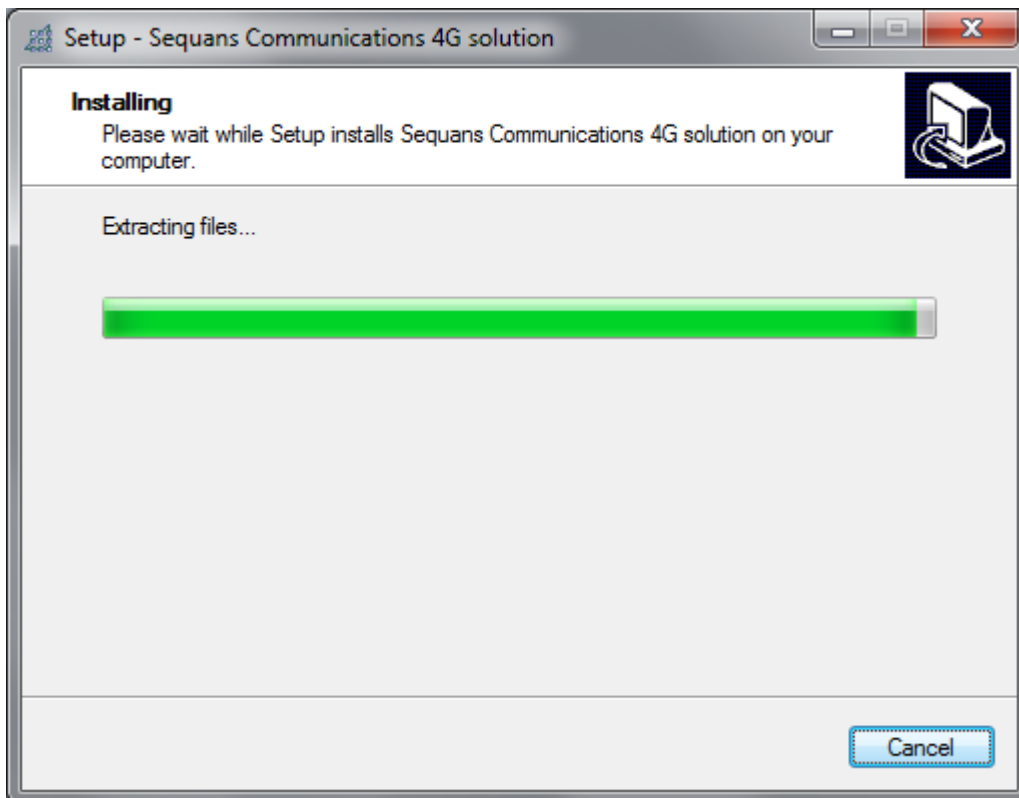

Figure 11 – Installing

11. Wait while installation continues.

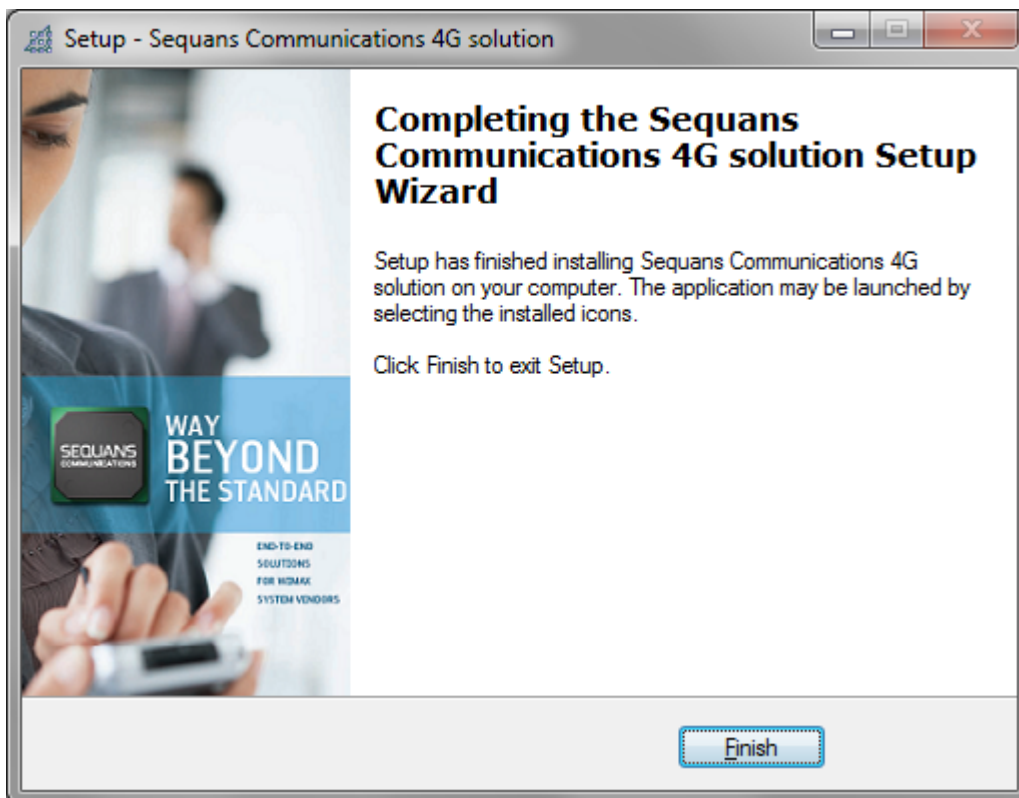

Figure 12 - Installation complete

12. After Installation is complete click **Finish**.

6.1 Configuration

1. Navigate to the sequansd.xml file location C:\Program Files\Sequans Communication which is used to configure frequency, bandwidth, etc. as shown below:

```
<?xml version="1.0"?>
-<sequansd>
<!-- DCC configuration -->

<!-- default config is listening on port 7771 on localhost. Change to IP address
0.0.0.0 for listening on all interfaces -->
-<server> <ip>127.0.0.1</ip> <port>7771</port>
<maxClients>10</maxClients> </server>
<!-- Define the firmware repository, for firmware from host mode -->
-<ffh> <repository>Firmwares</repository> </ffh>
<!-- Provisioning configuration -->
-<provisioning> -<ndss> <channel fft="1024" bandwidth="10000"
frequency="2300000" id="1"/> </ndss>
<!-- Default provisioning mode is XML. -->

<!-- For OMADM provisioning, please activate tag below. -->

<!-- Beware, certificates will be looked inside DM tree only -->

<!-- <mode>omadm</mode> -->
<mode>none</mode> </provisioning>
<!-- Define the log file name -->
-<debug> <logfilter>fine:*</logfilter> <logfile>SequansdLog.txt</logfile>
</debug> </sequansd>
```

2. Edit file as required.



Note: Contact Customer support for specific editing instructions.

3. After editing file, you need to restart sequansd service, as follows:

Navigate to - Start > settings > control panel > Administrative tools > Services

4. Choose service sequansd, right click > restart, as shown below:

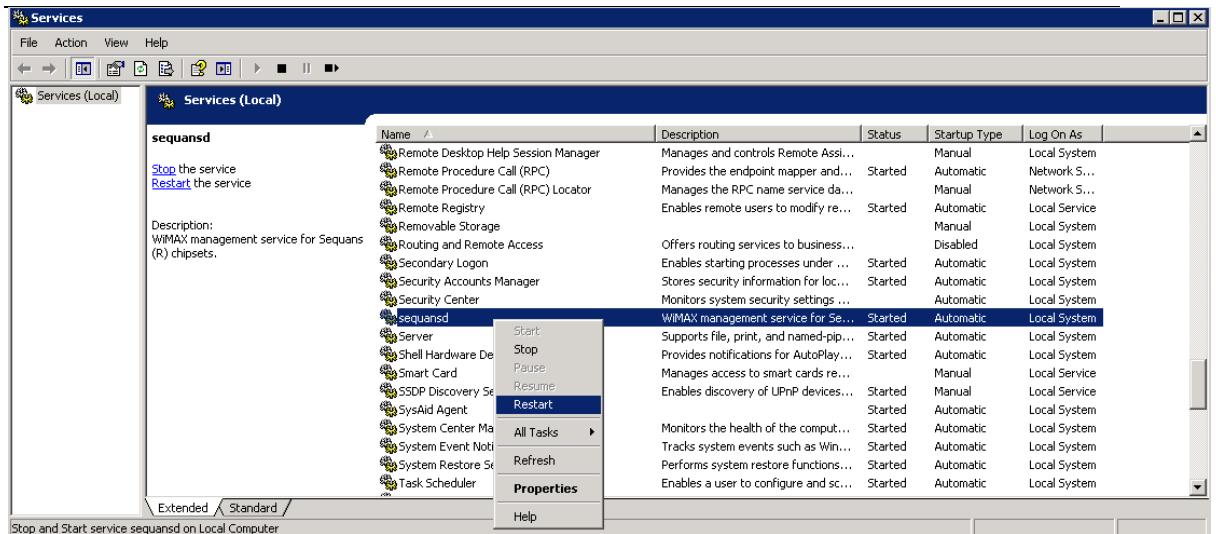

Figure 13 – Services

6.2 Connection Manager

Sequans Connection Manager - program which runs on the host to monitor the WiMAX link.

Navigate to - Start > Programs > Sequans Communications > Sequans CM

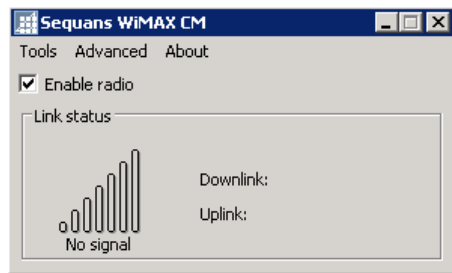

Figure 14 - WiMAX CM

The CM displays the downlink signal strength, uplink and downlink throughput counter:

- Enable radio – check to enable radio
- Link Status – displays current link status, such as:
 - Downlink
 - Uplink
- Tools
- Advanced

7 Appendix

7.1 SSRM – Power, Environmental, Standards Compliance

Table 8 - Environment, EMC & Safety

| Environmental | |
|-----------------------|---|
| Input | 5.5 VDC +/- 0.3 VDC through PCIe |
| DC Power Consumption | 5.79 W |
| Operating Temperature | -40°C to +85°C |
| Operating Humidity | 5% - 95%, non-condensing |
| EMC | FCC Part 15, Subpart B, Class B. According to FCC only class A is required for outdoor unit device. |
| Radio | FCC Part 90, FCC Part 27 |
| MTBF | 123 years (1,078,662 hours) |

7.2 Glossary of Terms

| | |
|----------------|-----------------------------------|
| CL-MIMO | Closed Loop MIMO |
| ESD | Electro Static Discharge |
| FCC | Federal Communications Commission |
| FUSC | Full Usage of Sub-channels |
| JTAG | Joint Test Action Group |
| LED | Light Emitting Diode |
| LNA | Low Noise Amplifier |
| MIMO | Multiple Inputs Multiple Outputs |
| MIMO-SM | MIMO Spatial Multiplexing |
| MRC | Maximum Ratio Combining |
| PA | Power Amplifier |
| PCI | Peripheral Component Interconnect |
| PHY | Physical Layer |
| PUSC | Partial Usage of Sub-channels |
| RF | Radio Frequency |
| Rx | Receive |
| SPI | Serial Peripheral Interface |
| SSRM | SS Radio Module |
| STC | Space Time Coding |
| TP | Test Point |
| Tx | Transmit |



SSRM Module User Guide



| | |
|--------------|---|
| UART | Universal Asynchronous Receiver/Transmitter |
| USB | Universal Serial Bus |
| WiMAX | WiMAX is a wireless industry coalition whose members are organized to advance IEEE 802.16 standards for broadband wireless access (BWA) networks. |

7.3 Revision History

| Revision | Originator | Date | Description |
|------------|------------|---------|--------------------|
| Draft 1 | M. Falik | 02-2012 | Initial document |
| Rev A - A2 | M. Falik | 05-2012 | Additional content |
| Rev B | M. Falik | 06-2012 | Additional content |
| Rev C | M. Falik | 07-2012 | Updates |
| Rev C | M. Falik | 08-2012 | Additions |

7.4 Contact Information

Customer Service Help-Desk for customer service emergency

Airspan Networks have introduced the [Airspan Tracker](#) application to enable prompt and efficient Customer Support services.

If you do not have an Airspan Tracker account, please obtain login credentials by filling-in the form in the main page "[Register New Account](#)".

Worldwide Headquarters:

Airspan Networks Inc.
777, Yamato Road, Suite 310,
Boca Raton, FL 33431, USA
Tel: +1 561 893 8670

www.airspan.com

Feedback:

To provide feedback on this document, please send comments to the following email address:
documentfeedback@airspan.com