



UGD-D01001 Rev A

**AirSynergy 2000
Installation Guide**





Copyright

© Copyright by **Airspan Networks Inc.**, 2013. All rights reserved worldwide.

The information contained within this document is proprietary and is subject to all relevant copyright, patent and other laws protecting intellectual property, as well as any specific agreements protecting Airspan Networks Inc. rights in the aforesaid information. Neither this document nor the information contained herein may be published, reproduced or disclosed to third parties, in whole or in part, without the express, prior, written permission of Airspan Networks Inc. In addition, any use of this document or the information contained herein for the purposes other than those for which it is disclosed is strictly forbidden.

Airspan Networks Inc. reserves the right, without prior notice or liability, to make changes in equipment design or specifications.

Information supplied by Airspan Networks Inc. is believed to be accurate and reliable. However, no responsibility is assumed by Airspan Networks Inc. for the use thereof nor for the rights of third parties which may be effected in any way by the use of thereof.

Any representation(s) in this document concerning performance of Airspan Networks Inc. product(s) are for informational purposes only and are not warranties of future performance, either expressed or implied. Airspan Networks Inc. standard limited warranty, stated in its sales contract or order confirmation form, is the only warranty offered by Airspan Networks Inc. in relation thereto.

This document may contain flaws, omissions or typesetting errors; no warranty is granted nor liability assumed in relation thereto unless specifically undertaken in Airspan Networks Inc. sales contract or order confirmation. Information contained herein is periodically updated and changes will be incorporated into subsequent editions. If you have encountered an error, please notify Airspan Networks Inc. All specifications are subject to change without prior notice.

Product performance figures quoted within this document are indicative and for information purposes only.



Table of Contents

Copyright	2
Table of Contents	3
Summary of Figures	5
Summary of Tables	7
Warnings and Cautions	8
Human Exposure to Radio Frequencies	8
Radio Interference	8
Avoiding Radio Interference	8
Modifications	8
General	8
Safety	8
Warning of Hazardous Voltages	9
Adherence to European Directive 1999/519/EC	9
Warning Symbols	9
Service Information	9
UL Information	10
Lightning Protection	10
DECLARATION OF CONFORMITY	11
FCC Notice	12
Federal Communication Commission Notice	12
GPS Compliance	12
Maximum Output TX Power	13
Power Consumption	13
Antenna Types	13
Switched Beam Antenna	13
Front Mount Sector Antenna	14
AirSynergy Antenna Usage Options	14
1 About this Guide	17
1.1 Purpose	17
1.2 Intended Audience	17
1.3 Conventions	17
1.4 Referenced Documentation	17
1.5 Organization of this Guide	17
2 Introduction	19
2.1 AirSynergy	19
2.1.1 Deployment Description	19
3 Getting Started	21
3.1 Workflow of Installation	21



AirSynergy 2000 Installation Guide

3.2	AirSynergy Installation Checklist	22
4	Verify Prerequisites.....	23
4.1	Verify Site Requirements	23
4.2	Verify Installation Requirements	23
4.2.1	Verify the Tools.....	23
4.2.2	Verify the Parts and Kits	23
4.2.2.1	Power Supply.....	25
4.2.3	Verify Components	25
4.2.3.1	Physical Dimensions.....	28
5	Install AirSynergy.....	29
5.1	Pole Mount Assembly	29
5.2	Wall Mount Assembly	30
5.3	Front Sector Antenna Assembly.....	31
5.4	Connecting GPS Antenna to AirSynergy.....	32
5.5	Securing AirSynergy to the Mounting Plate.....	34
5.6	LED Display	35
6	Connect and Manage Cables	36
6.1	Connecting the Ground Cable	36
6.2	Connecting RF Jumper Cables to External Antenna.....	37
6.3	Connecting the DC Power Cable to AirSynergy.....	37
7	Power System Connection	39
7.1	Required Tools	39
7.2	Cable Connections	39
7.2.1	DC Power Cable Installation.....	39
7.2.2	Network Cable Installation	40
7.3	Wiring DC Power Cable to the PSU	41
7.4	Connecting the AC/DC PSU to Power Supply	43
8	Appendix A	45
	Review Job Sheet.....	45
9	Appendix B - Glossary of Terms - Acronym, Abbreviations & Definitions.....	46
10	Appendix C - Installation Checklist.....	49
11	Appendix D – PSU for USA	50
12	Appendix E – Antenna (Currently Supported) Types	51
13	Appendix F.....	52
13.1	Revision History.....	52
13.2	Contact Information	52



Summary of Figures

Figure 1 - AirSynergy with sunshield	15
Figure 2 - AirSynergy with front sector antenna	15
Figure 3 - AirSynergy with switched beam antenna	16
Figure 4 - AirSynergy 2000 – assembled with: Front Mount antenna, sunshield, SBA and sunshield.....	20
Figure 5 - Workflow of Installation	21
Figure 6 - AirSynergy Unit, bottom termination	27
Figure 7 - AirSynergy Unit, RF ports, Internal Duplexers	27
Figure 8 - AirSynergy Unit, RF ports	28
Figure 9 - AirSynergy Unit, RF ports, External Duplexers.....	28
Figure 10 - AirSynergy mounting plate and hardware	29
Figure 11 - Assemble clamp bands (2 required)	29
Figure 12 – press down locking mechanism	30
Figure 13 – tighten clamp bands	30
Figure 14 – mounting plate installed on large diameter pole	30
Figure 15 - positioning wall mounting plate	31
Figure 16 - wall mounting plate fastened on wall	31
Figure 17 - attaching front mounted antenna to mounting plate	32
Figure 18 – Attaching front mount antenna assembly to AirSynergy	32
Figure 19 - attaching GPS antenna to mounting bracket	33
Figure 20 - Attaching the GPS antenna assembly to AirSynergy	34
Figure 21 - Lift unit to top of mounting plate	34
Figure 22 - unit engages into slots on the top of mounting plate	34
Figure 23 - lift the unit until the bottom studs fit into the bottom slots	35
Figure 24 - AirSynergy unit engaged into the bottom slots	35
Figure 25 – attaching ground cable to AirSynergy	36
Figure 26 - attach ground cable to pole.....	36
Figure 27 - Connecting RF cable.....	37
Figure 28 - weather-proof the connection - external antenna	37
Figure 29 - attaching power cable to AirSynergy	38
Figure 30 - required tools	39
Figure 31 - DC Power connection	40
Figure 32 - Power connection - AirSynergy bottom panel.....	40
Figure 33 - power and network cable overview.....	41
Figure 34 - Waterproof connector exploded view.....	41
Figure 35 - power cable preparation.....	41
Figure 36 - waterproof connector separated	41
Figure 37 - gland and connector on cable	42



AirSynergy 2000 Installation Guide

Figure 38 - secure cable to connector	42
Figure 39 – power cable wires assembled	42
Figure 40 - numbered connector contacts	42
Figure 41 - assemble and tighten	42
Figure 42 - PSU cable connector assembly	43
Figure 43 - PSU wires assembled	43
Figure 44 - assemble and tighten	43
Figure 45 - connector assembled and tightened	43
Figure 46 - High power (240W) PSU – used for dual AirSynergy installations	43
Figure 47 - Standard power (150W) PSU – used for standard AirSynergy installation	43
Figure 48 - attaching PSU	44
Figure 49 - PSU for USA deployment	44
Figure 50 - PSU for USA	50
Figure 51 - Inside PSU with cable terminations	50



Summary of Tables

Table 1 - AirSynergy FCC Maximum Output TX Power	13
Table 2 - AirSynergy ETSI Maximum Output TX Power	13
Table 3 - Switched Beam Antenna Parameters - Directional Mode	13
Table 4 - Switched Antenna Parameters - Omni Mode	14
Table 5 - Front Mounted Sector Antenna Parameters	14
Table 6 - AirSynergy installation tools	23
Table 7 - AirSynergy installation parts and kits	23
Table 8 - External Antenna and feeder kits (Optional)	25
Table 9 - AirSynergy additional items.....	25
Table 10 - AirSynergy components	25
Table 11 - AirSynergy physical dimensions	28
Table 12 - LED Display.....	35
Table 13 - Glossary of Terms	46
Table 14 - Checklist for Procedure	49
Table 18 - Antenna Types - Technical	51



Warnings and Cautions

Human Exposure to Radio Frequencies

The AirSynergy antennas should be installed and operated from a minimum safe distance of 1.5m.

Radio Interference

This AirSynergy generates, uses, and can radiate radio frequency energy and, if not installed and used in accordance with the instructions, may cause harmful interference to radio communications. However, there is no guarantee that interference will not occur in a particular installation. If this equipment does cause harmful interference to radio or television reception, which can be determined by turning the equipment on and off, the technician is encouraged to try to correct the interference by performing one or more of the following measures:

- Re-orientate or relocate the antenna
- Increase separation between the eNodeBs and/or End Device
- Connect the equipment to an outlet on a circuit different from that to which the power source is connected

Avoiding Radio Interference

Ensure a minimum of 1-meter separation between co-located antennas of AirSynergy units.

Modifications

Any changes and modifications to this device that are not expressly approved by Airspan Networks may void the user's authority to operate the equipment.

General

- Only qualified personnel should be allowed to install, replace, and service the equipment.
- The device cannot be sold retail, to the general public or by mail order. It must be sold to operators.
- Installation must be controlled.
- Installation must be performed by licensed professionals.
- Installation requires special training. The AirSynergy radio and antenna should be installed **ONLY** by experienced installation professionals who are familiar with local building and safety codes and, wherever applicable, are licensed by the appropriate government regulatory authorities. Failure to do so may void Airspan's product warranty and may expose the end user or the service provider to legal and financial liabilities. Airspan and its resellers or distributors are not liable for injury, damage or violation of regulations associated with the installation of outdoor units or antennas.

Safety

1. Read this guide and follow all operating and safety instructions.
2. Keep all product information for future reference.
3. This product is supplied with a grounding power plug. Do not defeat this important safety feature.
4. **Warning:** High voltages exist inside the product - do not remove the lid or base: No user serviceable parts inside.
5. Position the power cord to avoid possible damage; do not overload wall outlets.
6. Do not place this product on or near a direct heat source, and avoid placing objects on the terminal.
7. Do not operate this device near water or in a wet location.



AirSynergy 2000 Installation Guide

8. Use only a damp cloth for cleaning. Do not use liquid or aerosol cleaners. Disconnect the power before cleaning.
9. The units should not be located near power lines or other electrical power circuits.
10. The radio transceiver must be properly grounded to protect against power surges and accumulated static electricity. It is the user's responsibility to install this device in accordance with the local electrical codes.
11. Installation of the AirSynergy must be contracted to a professional installer.
12. Disconnect Device. The socket outlet should be easily accessible in case you have to disconnect the device.
13. When installed in the final configuration, the product must comply with the applicable Safety Standards and regulatory requirements of the country in which it is installed. If necessary, consult with the appropriate regulatory agencies and inspection authorities to ensure compliance.

Warning of Hazardous Voltages

On AC installations, hazardous voltages exist. Use caution when verifying or working with AC power. Remove metal jewelry that could come into contact with AC power.

On DC sections, short circuiting the low voltage, low impedance circuits can cause severe arcing that may result in burns or eye damage. Remove rings, watches etc. to avoid shorting DC circuits.



Note: Airspan products do not contain hazardous substances (as defined in UK Control of Substances Hazardous to Health Regulations 1989 and the Dangerous Substances Regulations 1990). At the end of any Airspan products life cycle, the customer should consult with Airspan to ensure that the product is disposed of in conformance with the relevant regulatory requirements.

Adherence to European Directive 1999/519/EC

European Council Recommendation 1999/519/EC details basic restrictions and reference levels on human exposure to electromagnetic fields as advised by the ICNIRP. Adherence to these recommended restrictions and reference levels should provide a high level of protection as regards the established health effects that may result from exposure to electromagnetic fields.

Warning Symbols

The following symbols may be encountered during installation or troubleshooting. These warning symbols mean danger. Bodily injury may result if you are not aware of the safety hazards involved in working with electrical equipment and radio transmitters. Familiarize yourself with standard safety practices before continuing.



Electro-Magnetic Radiation



High Voltage

Service Information

Refer all repairs to qualified service personnel. Do not remove the covers or modify any part of this device, as this will void the warranty.

Disconnect the power to this product and return it for service if the following conditions apply:

- a. The terminal does not function after following the operating instructions outlined in this manual.



AirSynergy 2000 Installation Guide

- b. Liquid has been spilled, a foreign object is inside, or the terminal has been exposed to rain.
- c. The product has been dropped or the housing is damaged.

Locate the serial number of the terminal, antenna, and transceiver and record these on your registration card for future reference. Use the space below to affix serial number stickers. Also record the MAC address, located on the back of the terminal.

UL Information

- The equipment must be properly grounded according with NEC and other local safety code requirements.
- Reminder to all the BWA system installers: Attention to Section 820-40 of the NEC which provides guidelines for proper grounding and, in particular, specifies that the cable ground shall be connected to the grounding system of the building, as close to the point of cable entry as is practical.

Lightning Protection

WARNING: The following notes are general recommendations for the system. The wireless equipment should be installed by a qualified professional installer and must follow local and national codes for electrical grounding and safety. Failure to meet safety requirements and/or use of non-standard practices and procedures could result in personal injury and damage to equipment. A direct lightning strike may cause serious damage even if these guidelines are followed.

All outdoor wireless equipment is susceptible to lightning damage from a direct hit or induced current from a near strike. Lightning protection and grounding practices in local and national electrical codes serve to minimize equipment damage, service outages, and serious injury. Reasons for lightning damage are summarized as:

- Poorly grounded tower/antenna sites that can conduct high lightning strike energy into equipment.
- Lack of properly installed lightning protection equipment that can cause equipment failures from lightning induced currents.

A lightning protection system provides a means by which the energy may enter earth without passing through and damaging parts of a structure. A lightning protection system does not prevent lightning from striking; it provides a means for controlling it and preventing damage by providing a low resistance path for the discharge of energy to travel safely to ground. Improperly grounded connections are also a source of noise that can cause sensitive equipment to malfunction.

A good tower grounding system disperses most of the surge energy from a tower strike away from the building and equipment.

To limit the equipment damage due to a lightning strike, the following practices are recommended for the wireless system:

- Provide direct grounding from the antenna mounting bracket, the radio and antenna and the lightning/surge protectors to the same ground point at the base of the tower or a ground bus on the building. Use the grounding screws on the antenna bracket and the radio and antenna for terminating the ground wires.
- The AC wall outlet ground must be connected to the same grounding system as the eNodeB.



DECLARATION OF CONFORMITY

European Community, Switzerland, Norway, Iceland, and Liechtenstein

Declaration of Conformity with Regard to the R&TTE Directive 1999/5/EC

English:

This equipment is in compliance with the essential requirements and other relevant provisions of Directive 1999/5/EC.

Deutsch:

Dieses Gerät entspricht den grundlegenden Anforderungen und den weiteren entsprechenden Vorgaben der Richtlinie 1999/5/EU.

Dansk:

Dette udstyr er i overensstemmelse med de væsentlige krav og andre relevante bestemmelser i Directiv 1999/5/EF.

Español:

Este equipo cumple con los requisitos esenciales así como con otras disposiciones de la Directiva 1999/5/EC.

Greek:

ΜΕ ΤΗΝ ΠΑΡΟΥΣΑ Airspan ΔΗΛΩΝΕΙ ΟΤΙ Ο ΕΞΟΠΛΙΣΜΟΣ ΣΥΜΜΟΡΦΩΝΕΤΑΙ ΠΡΟΣ ΤΙΣ ΟΥΣΙΩΔΕΙΣ ΑΠΑΙΤΗΣΕΙΣ ΚΑΙ ΤΙΣ ΛΟΙΠΕΣ ΣΧΕΤΙΚΕΣ ΔΙΑΤΑΞΕΙΣ ΤΗΣ ΟΔΗΓΙΑΣ 1999/5/ΕΚ.

Français:

Cet appareil est conforme aux exigences essentielles et aux autres dispositions pertinentes de la Directive 1999/5/EC.

Íslenska:

Þessi búnaður samrýmist lögboðnum kröfum og öðrum ákvæðum tilskipunar 1999/5/ESB.

Italiano:

Questo apparato é conforme ai requisiti essenziali ed agli altri principi sanciti dalla Direttiva 1999/5/EC.

Nederlands:

Deze apparatuur voldoet aan de belangrijkste eisen en andere voorzieningen van richtlijn 1999/5/EC.

Norsk:

Dette utstyret er i samsvar med de grunnleggende krav og andre relevante bestemmelser i EU-directiv 1999/5/EC.

Português:

Este equipamento satisfaz os requisitos essenciais e outras provisões da Directiva 1999/5/EC.

Suomalainen:

Tämä laite täyttää direktiivin 1999/5/EY oleelliset vaatimukset ja on siinä asetettujen muidenkin ehtojen mukainen.

Svenska:

Denna utrustning är i överensstämmelse med de väsentliga kraven och andra relevanta bestämmelser i Direktiv 1999/5/EC.

Român:

Acest echipament este în conformitate cu cerințele esențiale și alte prevederi relevante ale Directivei 1999/5/CE.

The Declaration of Conformity related to this product can be obtained from PLM@Airspan.com.



FCC Notice

Federal Communication Commission Notice

This equipment has been tested and found to comply with the limits for a Class A digital device, pursuant to part 15 of the FCC Rules. These limits are designed to provide reasonable protection against harmful interference when the equipment is operated in a commercial environment. This equipment generates, uses, and can radiate radio frequency energy and, if not installed and used in accordance with the instruction manual, may cause harmful interference to radio communications. Operation of this equipment in a residential area is likely to cause harmful interference in which case the user will be required to correct the interference at his/her own expense.

Fixed and base stations transmitting a signal with an emission bandwidth greater than 1 MHz must not exceed an ERP of 1000 watts/MHz and an antenna height of 305 m HAAT, except that antenna heights greater than 305 m HAAT are permitted if power levels are reduced below 1000 watts/MHz EIRP.

GPS Compliance

The GPS is in compliance with the essential requirements and other relevant provisions of Directive 1999/5/EC."

The GPS complies with the following EMC Common Regulatory Testing standards:

- EN55022: Radiated and Conducted Emissions
- CISPR 22: Class B
- EN 50081-1: Generic Emissions Class B
- EN 50082-1: Generic Immunity Class B
- EN 61000-4-2: Electrostatic Discharge Immunity
- EN 61000-4-3: Radiated RF EM Field Immunity Test
- EN 61000-4-4: Electrical Fast Transient/Burst Test
- EN 61000-4-6: Conducted Immunity
- EN 61000-4-8: Magnetic Field Immunity



Note: A GPS is recommended for synchronizing between LTE sectors.



Note: An optional GPS Lightning/Surge protector is available from Airspan for lightning prone deployments.



Maximum Output TX Power

Table 1 - AirSynergy FCC Maximum Output TX Power

Frequency Band	FCC		Antenna Gain
	TX	EIRP	
2. 11-2.17 GHz	33.48dBm	50.48dBm	17 dBi
2.62 – 2.69 GHz	33.36 dBm	51.36 dBm	18 dBi

Table 2 - AirSynergy ETSI Maximum Output TX Power

Frequency Band	ETSI		Antenna Gain
	TX	EIRP	
2110-2170 MHz	33 dBm	50 dBm	17.0 dBi
2560-2630 MHz	33 dBm	51 dBm	18.0 dBi
2620-2690 MHz	33 dBm	51 dBm	18.0 dBi
3400-3500 MHz	33 dBm	51 dBm	18.0 dBi



Caution: Do not set maximum output TX power to higher than local regulations.

Power Consumption

AirSynergy has a Max nominal power consumption of 78W. AirSynergy power consumption is described in the following table:

Duplex	Tx Power at RF Port (dBm)	Nominal Power Consumption (W)	Power Supply Requirement (W)
FDD	30	80	120
TDD	30	78	120

Antenna Types

The following antennas are designed specifically for AirSynergy deployments. Externally mounted antennas are available for use as well, but are specified separately.



Note: For a list of compatible external antennas, please contact your nearest Airspan sales representative.

Switched Beam Antenna

Switched Beam antenna (with built-in GPS antenna) variant include a top mounted steerable antenna with the following specification. The antenna is a multi-element cross polarized (dual slant) design which can be used in directional or omni modes of operation.

Table 3 - Switched Beam Antenna Parameters - Directional Mode

Parameter	2.3 GHz	2.6 GHz	3.x GHz
Frequency	2.3 - 2.5 GHz	2.5 - 2.7 GHz	3.4 - 3.7 GHz
Polarization	Dual Slant $\pm 45^\circ$	Dual Slant $\pm 45^\circ$	Dual Slant $\pm 45^\circ$
Polarization discrimination	14-15 dB	14-15 dB	14-15 dB



AirSynergy 2000 Installation Guide

Boresight gain	8 dBi	8 dBi	9 dBi
Azimuth HPBW	90°±10°	90°±10°	90°±10°
Elevation HPBW	20°	20°	20°
Co & X-Pol RPE	EN302-326-3 Class DN1	EN302-326-3 Class DN1	EN302-326-3 Class DN1
Grounding	DC Grounded	DC Grounded	DC Grounded

Table 4 - Switched Antenna Parameters - Omni Mode

Parameter	2.3 GHz	2.6 GHz	3.x GHz
Frequency	2.3 - 2.5 GHz	2.5 - 2.7 GHz	3.3 - 3.8 GHz
Polarization	Dual Slant ±45°	Dual Slant ±45°	Dual Slant ±45°
Polarization discrimination	10-16 dB	10-16 dB	10-16 dB
Average gain	2 dBi	2 dBi	3.5 dBi
Minimum gain ripple	4.5 dBi	4.5 dBi	4.5 dBi
Elevation HPBW	20°	20°	20°
Co & X-Pol RPE	EN 302-326-3	EN 302-326-3	EN 302-326-3
Grounding	DC Grounded	DC Grounded	DC Grounded

Front Mount Sector Antenna

The front mounted sector antenna is a cross polarized fixed antenna which mounts on the front of the unit in place of the sun-shield.



Note: When using a front mounted antenna, external antennas cannot be used.

Table 5 - Front Mounted Sector Antenna Parameters

Parameter	2.x GHz	3.x GHz
Frequency	2.3 – 2.7 GHz	3.3 – 3.8 GHz
Polarization	Dual Slant ±45°	Dual Slant ±45°
Polarization discrimination	>18 dB	>15 dB
Boresight gain	12 dBi	11.5 dBi
Azimuth HPBW	63°	65°
Elevation HPBW	21°	22°
Grounding	DC Grounded	DC Grounded

AirSynergy Antenna Usage Options

AirSynergy comes in a range of frequency variants that can be mounted with different antenna options and formats.



Figure 1 - AirSynergy with sunshield

A typical sector installation will have a cross-polar sector antenna fitted directly to the front of the AirSynergy main unit. (This is attached instead of the sun-shield).



Figure 2 - AirSynergy with front sector antenna

A switched beam antenna version with built in GPS antenna allows for versatile LTE access, selecting between omni and $n \times 90^\circ$ antenna patterns.



Figure 3 - AirSynergy with switched beam antenna



Note: Appropriate mounting kit (included) for the various external antennas is required.



1 About this Guide

This section discusses the purpose, intended audience, conventions, referenced documentation and organization for this guide.

1.1 Purpose

This guide provides the workflow and step-by-step procedures for Installing the AirSynergy. These procedures include:





- Verify prerequisites
- Install the AirSynergy radio equipment
- Install the PSU equipment (optional)
- Connect and manage cables

1.2 Intended Audience

This guide is intended for persons who are responsible for installing the AirSynergy equipment. These persons should have a working knowledge of the equipment.

1.3 Conventions

This document uses the following informational conventions.

Icon	Description
	Checkpoint: Marks a point in the workflow where there may be an exit or branch to some other procedure. At each Checkpoint the reason for an exit or branch is given along with specific directions to locate the entry point in the other procedure.
	Reference: Gives a resource in the workflow that may be needed to complete a procedure along with specific directions to use the resource.
	Caution: Describes a possible risk and how to lessen or avoid the risk.
	Advice: Provides a recommendation based on best practice.
	Note: Provides useful information.

1.4 Referenced Documentation

- AirSynergy 2000 Hardware Product Specification
- AirSynergy Overview Guide (pending)
- AirSynergy LTE Commissioning Manual

1.5 Organization of this Guide

This guide is organized into the following Sections:

- About this Guide
- Introduction
- Getting Started
- Verify prerequisites



AirSynergy 2000 Installation Guide

- Install AirSynergy
- Install the PSU equipment (Optional)
- Connect and manage cables
- Power System Connection
- Appendixes



2 Introduction

This section provides a descriptive overview of the Airspan's AirSynergy Pico eNodeB and its place in the product suite.

2.1 AirSynergy

AirSynergy is part of Airspan's carrier-class 4G Pico eNodeB family. AirSynergy supports 3GPP's Long Term Evolution (LTE) eNodeB, providing high-speed data and mobility, in order to meet the demands of the Broadband Wireless Access market.

AirSynergy is a compact, easy to install pico-cell, allowing an operator to deploy LTE broadband services using existing Street Furniture (e.g. street lamps, power poles, etc...)

AirSynergy employs Software Defined Radio (SDR) technology, together with two transmit and receive paths, antennas and a GPS receiver - all in a highly integrated, physically small and light, All-Outdoor package, targeted to blend seamlessly into the urban environment. This very compact outdoor product minimizes physical footprint, power consumption and operator OPEX.

AirSynergy supports a wide array of frequencies and channel sizes, able to operate in both licensed and unlicensed bands with more frequencies and channel sizes added regularly.

AirSynergy implements dual 30dBm (2 x 1W) transmitters, with several optional integral antennas and external antennas connectivity.

AirSynergy fully supports the standard LTE (Uu/S1/X2) interfaces, and can also operate in "Standalone" mode, without the need for an LTE Core network - providing an ideal cost effective solution for fixed applications.

All Airspan eNodeB products, including AirSynergy, are interoperable with a rich portfolio of 3rd party end user devices, including many handsets, indoor UEs, outdoor UEs and USB dongles from several ODMs, using various chipsets. For an updated of interoperability list, please contact your nearest Airspan Sales Representative.



Note: For management please refer to the AirSynergy LTE Commissioning Manual as well as the Netspan User Manual.

2.1.1 Deployment Description

A highly flexible and scalable 4G Base Station, the AirSynergy is capable of supporting LTE profiles across multiple frequency bands.



Note: The following is for illustration only; actual layout may differ as infrastructure is installation-specific.



Note: AirSynergy must be properly grounded according with NEC and other local safety code requirements.



Note: Installation of the GPS Lightning/Surge protector (ordered separately) is necessary to protect the GPS antenna. The Lightning/Surge protector must be properly grounded with NEC and other local safety code requirements.



Note: An External Duplexer is required for some lower frequency (<1GHz) FDD variants (supplied with AirSynergy, where required).



Figure 4 - AirSynergy 2000 – assembled with: Front Mount antenna, sunshield, SBA and sunshield



Note: Auto-negotiation must always be enabled on the core network side.



Note: Illustration above display the GPS connected directly to the top of the unit, there is also a remote GPS antenna option.

3 Getting Started

3.1 Workflow of Installation

The Workflow to install the AirSynergy is shown in the following diagram:

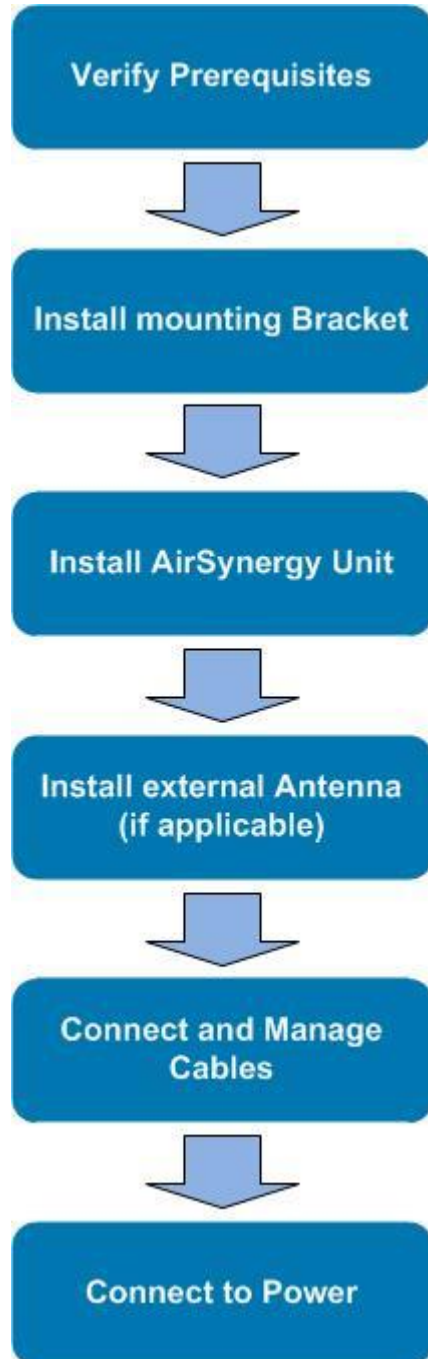

Figure 5 - Workflow of Installation



Caution: Antennas must be connected and attached before AirSynergy is powered on.



3.2 AirSynergy Installation Checklist

Plan the installation of the AirSynergy by using the Installation Checklist, which you can find as a removable job aid in [Appendix A](#) for this guide.



4 Verify Prerequisites

Prior to installing the AirSynergy, verify the required safety, power, tools, parts and components.



Reference: Set up requirements for the installation is detailed in the *Job Sheet*, see [Appendix A](#) for this guide.

4.1 Verify Site Requirements

To set up the AirSynergy, an IP connection to a Netspan server is required.

4.2 Verify Installation Requirements

4.2.1 Verify the Tools



Note: AirSynergy variants with Sunshield, front mounted and Switched Beam antennas come pre-assembled from the production line.

Table 6 - AirSynergy installation tools

Tool	Use
Large flat bladed screwdriver	securing the pole straps
13mm wrench x 2	heavy-duty pole clamp option only
10mm or 13/32 inch wrench	AirSynergy securing flange nuts
Large pliers	Tightening cable glands - To fit 15mm
Knife	For stripping insulation
Large pliers	Tightening cable glands on the US PSU - To fit 15mm across flats
Wire cutters	
Wire strippers	Cutting of insulation
Ring terminal crimp tool	
Tilt-meter	If accurate down-tilt of antenna needs to be set

4.2.2 Verify the Parts and Kits

Table 7 - AirSynergy installation parts and kits

Installation Kit / Part	Part No.	Consisting of	Note:
Main AirSynergy parts	SYN-U-PMK-2	1 x AirSynergy Universal Mounting Plate and pole strap kit	Includes 2 pole straps for poles up to 200mm diameter (minimum pole diameter 50mm)



AirSynergy 2000 Installation Guide

Installation Kit / Part	Part No.	Consisting of	Note:
	SYN35-xx-xx-xxx-xxx	AirSynergy unit(s)	Frequency band and assembly type-specific Verify order and requirements to ensure the correct unit type is being installed.
Optional Accessories			
	SYN-SUN-KT-1	1 x Sun Shield (Spare Unit)	Sun shield with included hardware (6 Flathead screws)
	SYN-SEC-MKT-1	1 x Sector Antenna mounting plate with fixing kit	4 M4 nuts 4 M4 flat washers 4 M4 spring washers 4 Cable ties 4 M5 SEM
	SEC60D-x.x-SYN-RC-x	1 x Sector Antenna (front mount)	
	GPS-SYN-KIT	GPS Antenna kit	Bracket M6 screw M6 plain washer M6 spring washer TNC to TNC cable (25cm)
Connecting cables		Grounding cable	M6 Lug at each end
Power Supply and power cable	SYN-PSU-OD-AC-3	Optional AC/DC 150W PSU module	1 per AirSynergy unit
	PWR-xx-INST-2	DC Power cable	1 per AirSynergy unit with external grade power cable with compatible power weather-proof connector (variable lengths)
	SYN-PWR-JOIN-1	Cable Join kit	1 per AirSynergy unit
	SYN-PSU-ODUL-AC-3	Optional AC/DC 150W PSU in weatherproof enclosure (NEMA approved)	Alternative to the standard 48V PSU (required for all North American installations)



AirSynergy 2000 Installation Guide

Table 8 - External Antenna and feeder kits (Optional)

Installation Kit / Part	Note
External Antenna Several variants - Verify the correct unit type is being installed.	Typically a 2 port dual-slant cross-polar antenna Pole mounting kits (supplied with antenna)
Antenna RF Cable	Variable length Heliax RF cables (for mounting antenna on the same pole immediately behind the AirSynergy unit or where the Antenna needs to be mounted away from the AirSynergy unit)

Table 9 - AirSynergy additional items

Additional Common Accessories (not provided by Airspan)
CAT-5e RJ45 network cable
Cable ties
Self-amalgamating tape
Black PVC tape
Ring terminal for ground cable. M6
Ground cable (4-6 mm) (yellow and green cable)

4.2.2.1 Power Supply

AirSynergy supports direct connection to DC power source (-48V DC):

- Operational Voltage Range: -40.5 to -57 VDC
- Transient Voltage: +150V (ETR283).

4.2.3 Verify Components

The following figures display various AirSynergy components and accessory kits.







Note: AirSynergy variants with Sunshield, front mounted antenna and Switched Beam antenna come factory pre-assembled.

Table 10 - AirSynergy components

Parts	Images
AirSynergy Unit (with Sunshield) in typical packing box	



AirSynergy 2000 Installation Guide

Parts	Images
AirSynergy Unit (with front mounted antenna) in typical packing box	 A photograph showing the interior of a cardboard packing box. The box is lined with pink foam padding, and the AirSynergy unit is visible in the center, protected by the padding.
AirSynergy unit with Switched Beam antenna and sunshield (factory assembled)	 A photograph of the AirSynergy unit, which is a long, cylindrical, light-colored device. It features a white cylindrical antenna protruding from the front and a sunshield at the rear.
Universal mounting plate and pole straps	 A photograph of a grey metal universal mounting plate with four L-shaped brackets. Two metal pole straps are attached to the bottom of the plate.
PSU AC/DC (switching power supply unit)	 A photograph of a white switching power supply unit (PSU) with a black AC power cord on the left and a black DC output cable on the right. The label on the top of the unit includes the model number "CLG-150-30A".
Enclosed PSU (U.S. requirement)	 A photograph of a grey metal enclosure housing the PSU. The enclosure has two metal mounting brackets on the front face, one on the left and one on the right.

AirSynergy 2000 Installation Guide

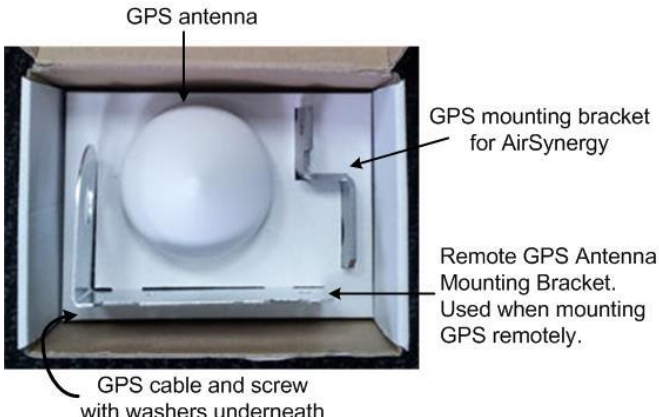
Parts	Images
GPS antenna mounting kit (boxed)	

AirSynergy is shown below from the Ethernet termination and RF port end views respectively.

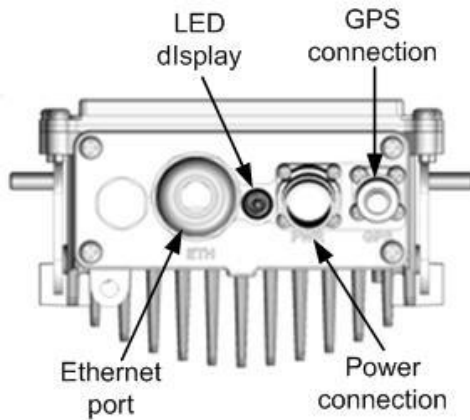

Figure 6 - AirSynergy Unit, bottom termination

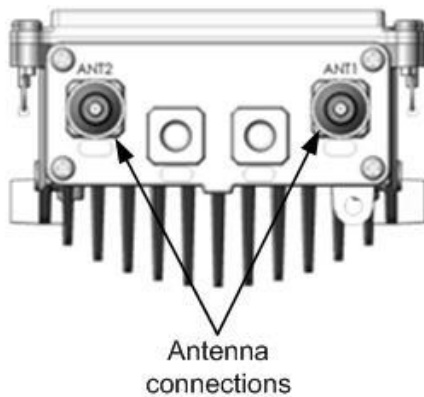

Figure 7 - AirSynergy Unit, RF ports, Internal Duplexers

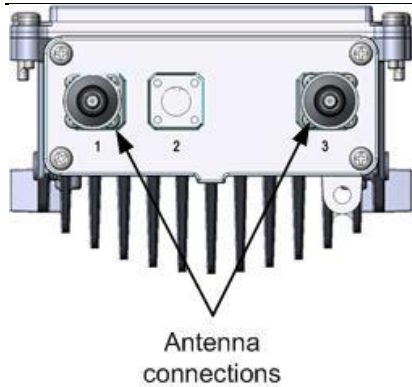

Figure 8 - AirSynergy Unit, RF ports

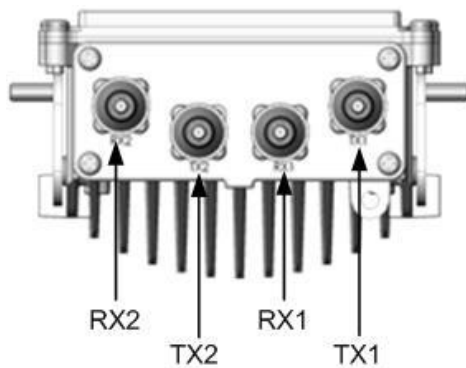

Figure 9 - AirSynergy Unit, RF ports, External Duplexers

4.2.3.1 Physical Dimensions

AirSynergy is in an all outdoor enclosure.

Table 11 - AirSynergy physical dimensions

Parameter	Value	Comment
Height	530 mm (20.9 in)	
Width	144 mm (4.49 in)	The physical dimensions exclude antenna and connectors
Depth	106 mm (4.17 in)	
Weight		
	Main unit (Connectorized)	4.65 kg (10.25 lb)
	Universal mounting bracket (Including pole straps)	925 g (2.04 lb)
	Sun-shield	575 g (1.27 lb)
	Front mount antenna & plate	1.35 kg (2.98 lb)

RF Ports for antenna connections are N-Type Female connectors located on the top of the AirSynergy enclosure.

5 Install AirSynergy

Install the AirSynergy eNodeB by pole mount, wall mount, or single point. The AirSynergy unit can be connected to various types of antennas via standard RF coaxial cables. Antennas should be positioned with 10 wavelengths horizontal separation to give optimal Downlink and Uplink MIMO performance.

AirSynergy is normally mounted on a pole (in close proximity to its external antenna when not using the AirSynergy front mounted Antenna). Take care to install the mounting plate the correct way up. This is with the slot openings in the bracket at the top edges as shown.



Caution: Proper local rigging and hoisting practices should be followed when installing the AirSynergy.

5.1 Pole Mount Assembly

The following images show the pole mount assembly.

1. Position mounting plate with slots facing up.



Figure 10 - AirSynergy mounting plate and hardware

2. Feed clamp bands through the quick release locking mechanisms and wrap around pole.



Figure 11 - Assemble clamp bands (2 required)

3. Wrap the band to properly fit on the pole. Press down locking mechanism with band excess fed through the mechanism.



Figure 12 – press down locking mechanism

4. Align and position each of the 2 pole clamps. Tighten the clamp bands with large flat screwdriver in place.



Figure 13 – tighten clamp bands

5. Mounting plate is installed and ready for AirSynergy mounting.



Figure 14 – mounting plate installed on large diameter pole

5.2 Wall Mount Assembly

The following images show the wall mount assembly.

1. Position mounting plate against the wall with slots facing up. Be sure to position the wall mounting plate straight with **level mounting** to ensure the unit sits evenly.



Figure 15 - positioning wall mounting plate

2. Mark the wall through the holes on the wall mount at the required height.
3. Attach the mounting plate to the wall using wall plugs (x4) rated for at least 8-10 Kg per fastener.

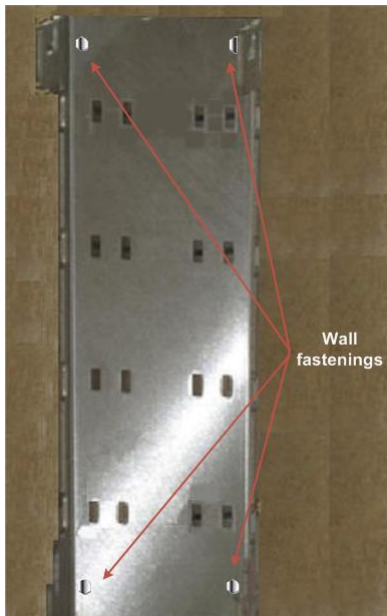

Figure 16 - wall mounting plate fastened on wall



Note: Wall plugs (x4) and necessary hardware are **not** supplied by Airspan and are the responsibility of the installer. Recommended minimum 8mm dia. with appropriate wall plugs according to field conditions.

5.3 Front Sector Antenna Assembly



Note: The following section is included for **spare-parts** or **replacement** assembly instructions as front mounted antenna variants come factory pre-assembled.

The AirSynergy unit can be used either with a sector antenna mounted directly on the front or with a remotely attached antenna. The following describes the installation procedure for the front mounted antenna.

For installation of a remotely mounted antenna follow the antenna manufacturer's instructions and connect the antenna to the AirSynergy using the appropriate cables. (Weather-proofed N-type Heliax RF cables (ordered separately)).



Note: When a front mounted antenna is not attached to the unit (remote antenna) a Sun-shield should be attached. Variants utilizing remotely attached antennas come factory pre-assembled with a sunshield.

To mount the front antenna, perform the following:

1. Fit the antenna to the (antenna) mounting plate. The four (4) studs on the back of the antenna pass through the front face of the mounting plate and are secured with the 4 sets of M4 nuts and washers (flat and split) included in the kit. Carefully position the lead RF cables as shown in the figure below and secure them in place to the eyelets on the back of the mounting plate with the provided cable ties. The cables are formed with a cross-over at the bottom.



Note: It is recommended to place some packing material under the unit while assembling to protect it from scratches.



Figure 17 - attaching front mounted antenna to mounting plate

2. Attach the assembled front mounted antenna with the bracket to the AirSynergy unit using the M5 SEMs (2 on each side) and connect the RF cables to the N type RF ports on the top of the AirSynergy.



Note: The plate is mounted with the side slots towards the top so that the required tilt-down can be set.



Figure 18 – Attaching front mount antenna assembly to AirSynergy

5.4 Connecting GPS Antenna to AirSynergy

The GPS antenna should be installed far from:

- High-voltage power cables.
- Strong radiation area of any TV transmission stations.
- Radiation area of the main lobe of the RF Antenna.
- Radiation area of the microwave antenna.
- Other areas with inter-frequency interference or strong electromagnetic interference.

Cable Fastening Good Practices:

- No more than 5m between cable fastening spaces.
- No more than 1m between cable termination and first fastener.
- Fastenings should be to a robust construction (i.e. mast pole, unit mount...).



AirSynergy 2000 Installation Guide

- Fasteners should be weather and UV resistant.
- Cables should have some slack for thermal expansion/contraction between fastenings.

An 80cm cable (supplied with GPS antenna kit) connects the GPS directly to the AirSynergy connector, on the bottom panel. When mounting the GPS antenna remotely from the unit, the GPS antenna should be used in conjunction with the Remote GPS Antenna Mounting Bracket (supplied with the GPS antenna kit) and the appropriate length GPS cable RG58 TNC-TNC by way of TNC connectors.



Note: All cables should be properly secured to prevent undue strain on any of the cable terminations.



Note: AirSynergy units without a factory assembled Switched Beam Antenna all require a GPS antenna (unless an alternative synchronization method is used, such as IEEE1588-2008) which comes in a kit with a mounting bracket and a 80cm cable. A primary consideration for a GPS antenna is a clear view of the sky, preferably 360 degrees.

1. Assemble the GPS antenna to the mounting bracket supplied in the GPS antenna mounting kit. The large nut should be tightened with a pipe wrench.



Caution: Take care not to over tighten the nut so as not to damage the plastic threads.



Figure 19 - attaching GPS antenna to mounting bracket

2. Attach the TNC to TNC cable from the GPS antenna to the TNC connector on the bottom of the AirSynergy unit.



Note: For extreme weather conditions weather-proofing of the TNC connections is recommended. This is done with a layer of self-amalgamating tape followed by an over layer of PVC tape. The weather-proofing is best done at this stage to give easier access to the connections.

3. Attach the GPS antenna assembly to the body of the AirSynergy unit using the single M6 screw and lock washer provided in the kit. There is a threaded hole on the top corner of the AirSynergy unit for this purpose.



Figure 20 - Attaching the GPS antenna assembly to AirSynergy



Caution: Attach the GPS bracket in the displayed position **only**, so as not to restrict the airflow in any way.

5.5 Securing AirSynergy to the Mounting Plate



Note: the following procedure can also be performed with the Front-Mount antenna variants exactly as shown below.

To mount AirSynergy to the universal mounting plate, perform the following:

1. Loosely fit the flange nuts on the studs protruding from the sides of the unit.



Figure 21 - Lift unit to top of mounting plate

2. Hook the studs into the top slots of the mounting plate.



Figure 22 - unit engages into slots on the top of mounting plate

3. With the studs engaged in the top slots raise the unit slightly until the bottom studs also drop into their respective slots.



Figure 23 - lift the unit until the bottom studs fit into the bottom slots



Figure 24 - AirSynergy unit engaged into the bottom slots

4. Tighten the flange nuts (4 places) to the required degree of down-tilt.
5. Check and tighten all flange nuts.

5.6 LED Display

A single tri-color LED (Green/Red/Orange) appears at the bottom of the unit, providing unit status indication.

When powering up refer to the following table for indication of current status:

Table 12 - LED Display

Name	Color	Status	Description
Powering Up	Orange	On Continuously	Till the SW starts loading
Software loading	Green	Blinking (3Hz)	While SW is loading
Normal Operation	Green	On Continuously	Normal operation (no alarm)
Major Alarm	Red	Blinking (3Hz)	Service not affected
Critical Alarm or Sector OOS	Red	On Continuously	

6 Connect and Manage Cables

6.1 Connecting the Ground Cable

There is an option to connect a ground cable to the M6 screw threaded connection at the bottom of the main body casting. This should be connected to a protection ground bar or clamped directly to the steel structure of the power or pole. This is required in areas of high lightning activity or when the AirSynergy unit is mounted on high exposed roofs or tower structures. A direct earth ground connection is required for the surge protection devices inside the AirSynergy to be effective.

1. Remove grounding screw and slip the ring terminal end of the ground cable onto the screw prior to re-setting into the threaded hole.



Figure 25 – attaching ground cable to AirSynergy

2. Connect the ground cable to the to the protection ground bar using a suitable crimp lugs. Alternatively use a clamp to bond the ground cable to the mounting pole or to the tower structure.

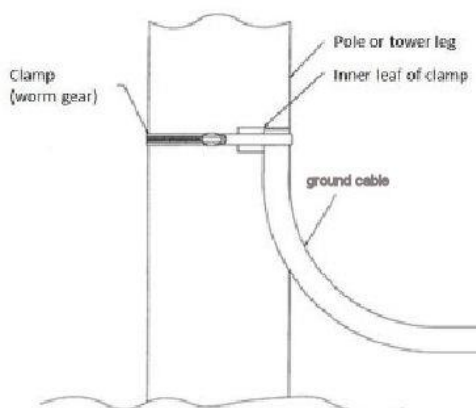

Figure 26 - attach ground cable to pole



Note: When installing a protection ground take care to use suitable metal combinations to avoid or minimize galvanic corrosion.

6.2 Connecting RF Jumper Cables to External Antenna

1. Attach, connect and secure the RF cable between the external antenna and the appropriate RF connection on the top of the unit.



Figure 27 - Connecting RF cable



Caution: Do not over-tighten the RF connector. RF failures can result when the RF connector is over-tightened.



Figure 28 - weather-proof the connection - external antenna

2. Weather-proofing of the RF N type connections is recommended. This is done with a layer of self-amalgamating tape followed by an over layer of PVC tape.
3. Verify the RF connector is completely weather-sealed.

6.3 Connecting the DC Power Cable to AirSynergy

1. Plan the position of the DC power cable run from the AirSynergy unit to the power supply unit. The DC power cable is offered in various lengths, to fit different deployments.
2. Uncoil the cable and secure the connector just below the AirSynergy unit.



Note: When securing the cable make sure there is no tension on the connector so that it is easy to disconnect and re-connect for future maintenance actions.

3. Position the pins correctly, the connector is secured to the unit with a locking ring that is screwed into place. Use firm hand pressure only, the connector has a built in sealing ring.



Caution: The internal plastic parts of the mating connector are keyed. Take care to align these by visual inspection or by gently rotating the connector body until the key way sections align and the pins go in before tightening the locking ring.



Figure 29 - attaching power cable to AirSynergy

7 Power System Connection



Hazardous voltage! Before working, ensure that the power is removed from the power connection cables. When the system is powered on, **do not touch the power terminals.**

7.1 Required Tools

The tools required for the connection of the PSU are:

- knife
- small flat blade screw driver (electrical insulated shaft recommended)
- medium Philips head screwdriver
- pliers
- small side cutters
- tweezers (or fine blade long nose pliers)



Figure 30 - required tools

7.2 Cable Connections

7.2.1 DC Power Cable Installation

When the DC power cable is to be passed through glands and/or down the center of a lamp post or other structure, the DC power cable can be cut leaving sufficient length for ease of termination. With the power supply placed at the selected installation location, trim the cable to the length for proper installation while allowing sufficient length to strip and prepare the cable ends.



Note: Standard cable supplied is 30m in length, other length options are available.

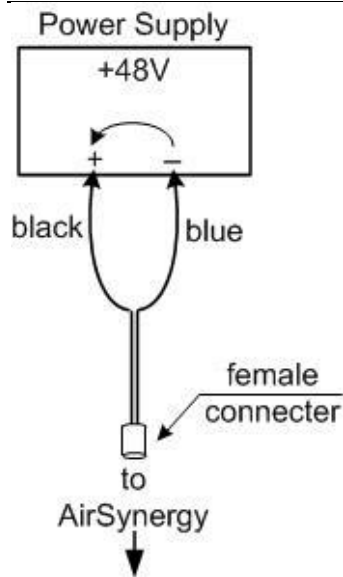

Figure 31 - DC Power connection

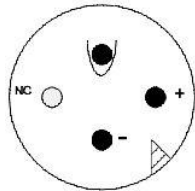

Figure 32 - Power connection - AirSynergy bottom panel



Advice: It is good practice to label both ends of the cable to identify which AirSynergy unit it is connected to. This is especially important where numerous AirSynergy units are installed on the same pole/tower.



Advice: It is good practice to leave a spare loop of cable (approximately 0.5m). This will allow for easier wiring to the power supply and will allow the cable to be re-terminated if necessary in the future.

7.2.2 Network Cable Installation

For installations that require a network connection a separate cable must be run to the network Ethernet switch. The standard length of pre-made cable is 30m. For other lengths up to a maximum of 100m cables can be made up on site.



Advice: It is good practice to label both ends of the Network cable to identify which AirSynergy unit it is connected to. This is especially important where numerous AirSynergy units are installed on the same pole/tower.



Advice: It is good practice to leave a spare loop of network cable (approximately 0.5m). This will allow for easier wiring to the Network switch and will allow the cable to be re-terminated if necessary in the future.

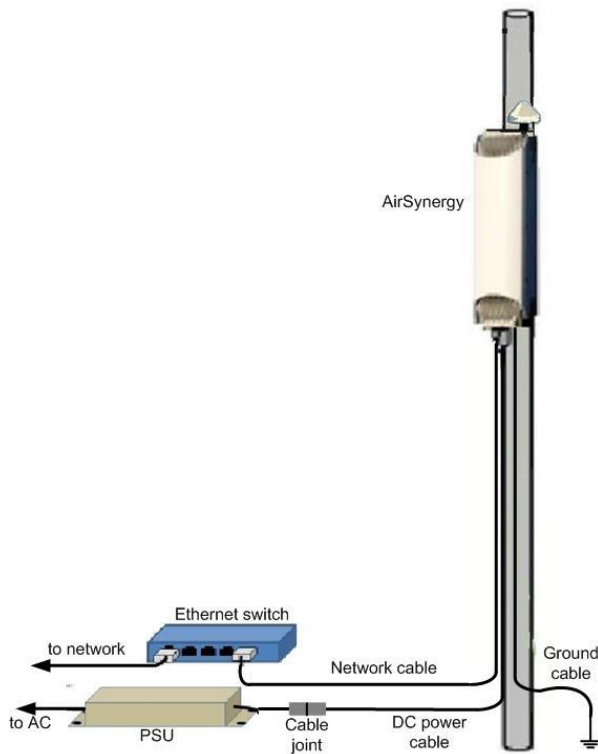

Figure 33 - power and network cable overview

7.3 Wiring DC Power Cable to the PSU

The DC power cable supplied is a standard 30m (98.42 ft) length with the power connector end for the AirSynergy unit pre-fitted. (Longer lengths are available).



Figure 34 - Waterproof connector exploded view

1. Choose the location PSU and the route of the power cable. Pass the cable through any building walls or cable entry glands and bring the unterminated end to the location of the PSU.
2. With the DC power cable from the AirSynergy cut to the required length prepare the cable to fit the waterproof power connector.
3. Strip back and remove the outer sheath to expose the inner blue and black insulated wires to a length of 3cm (1.18 in). Then strip back 6mm (0.24 in) of the inner core insulation.



Figure 35 - power cable preparation



Figure 36 - waterproof connector separated

4. Thread the prepared cable end through the gland, washer, sealing ring and body of the connector.



Figure 37 - gland and connector on cable

5. Secure the prepared ends of the power cable into the head part of the connector (male part with visible pins).



Figure 38 - secure cable to connector

6. Insert and secure the **black** wire into position **1** and the **blue** wire into position **2**.



Figure 39 – power cable wires assembled



Note: Individual connection numbers are marked on each part of the connector.



Figure 40 - numbered connector contacts

7. Assemble the parts of the connector and tighten the gland to provide a waterproof seal.



Figure 41 - assemble and tighten

8. Prepare the ends of the PSU low voltage cable and thread the connector parts over the cable.
9. Secure the prepared ends of the drop cable into the head part of the connector (female part).



Figure 42 - PSU cable connector assembly

10. Insert and secure the **red** wire into position **1** and the **black** wire into position **2**



Figure 43 - PSU wires assembled

11. Assemble the parts of the connector and tighten the gland to provide a waterproof seal.



Figure 44 - assemble and tighten

12. Fasten the 2 parts of the connector together and tighten to make a watertight seal.



Figure 45 - connector assembled and tightened

7.4 Connecting the AC/DC PSU to Power Supply

The power (mains) connection should be connected to a fused or protected mains supply (100 to 240 Volts AC). The Brown wire is the Live, the Blue wire is the Neutral and the Green/Yellow wire is the ground wire.



Figure 46 - High power (240W) PSU – used for dual AirSynergy installations



Figure 47 - Standard power (150W) PSU – used for standard AirSynergy installation

The PSU module can be screwed into position using the self-tapping screws provided (4 places).

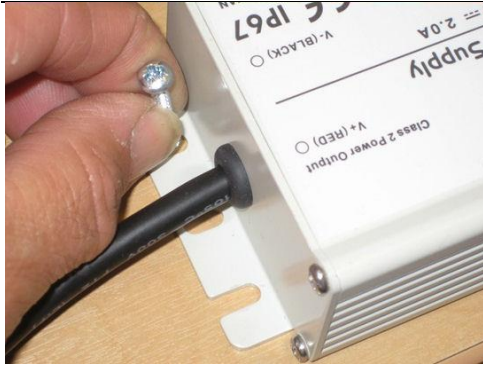

Figure 48 - attaching PSU



Note: For USA deployments an alternative PSU and enclosure arrangement is required – Refer to [Appendix D](#).



Figure 49 - PSU for USA deployment



Caution: Safety - Disconnection of AC supply.

- When AirSynergy is connected directly to building or lamp post wiring a suitably rated and easily accessible disconnect device shall be incorporated external to the equipment.
- When AirSynergy is connected to the AC power supply using a plug and socket, the socket-outlet shall be installed near the equipment and shall be easily accessible.



8 Appendix A

Review Job Sheet

The *Job Sheet* should include the following information:

- Pole for installation identified
- Position on pole identified
- Pole access restrictions (highway regulations, other services on pole, power pole)
- Method of reaching pole positions (ladders, Elevated work platform)
- AC main fuse block available for PSU (where needed)
- Configuration programming details known
- Point of connection for Ethernet (if applicable)
- All equipment items available at the installation site
 - Main AirSynergy unit
 - Mounting bracket and pole clamps
 - PSU
 - Ethernet cable assembly
 - GPS Antenna
 - GPS antenna installation kit
 - Front sector Antenna (if applicable)
 - Front sector Antenna mounting bracket and fixing kit (if applicable)
 - External panel antenna (if applicable)
 - RF feeder cable tails (if applicable)
- Required tools
 - Large flat screw driver for pole clamps
 - Small flat blade screw driver (insulated shaft recommended)
 - Medium Philips head screw driver
 - 20mm wrench or small pipe wrench for RF connections
 - 10mm wrench for unit mounting flange nuts
 - Knife
 - pliers
 - Small side cutters
 - Tweezers (or fine blade long nose pliers)
 - Wire strippers
- Required ancillary equipment
 - Laptop PC for initial configuration
 - Ethernet cable for temporary connection of the lap top
- Other install materials
 - Self-amalgamating tape
 - Black PVC tape
 - Cable ties
- Labels
- Whether the system is required to be locked to a GPS timing reference..



9 Appendix B - Glossary of Terms - Acronym, Abbreviations & Definitions

Table 13 - Glossary of Terms

Short	Long
3GPP	3rd Generation Partnership Project, responsible for LTE
ABS	Almost Blank Subframes
ACS	Adjacent Channel Selectivity is a measurement of a receiver's ability to process a desired signal while rejecting a strong signal in an adjacent frequency channel. ACS is defined as the ratio of the receiver filter attenuation on the assigned channel frequency to the receiver filter attenuation on the adjacent channel frequency
AWGN	Additive White Gaussian Noise is a channel model in which the only impairment to communication is a linear addition of white noise with a constant spectral density and a Gaussian distribution of amplitude.
BER	Bit Error Rate
CN	Core Network
CP	Cyclic Prefix
CTC	Convolution Turbo Code is a high-performance forward error correction (FEC) code
dB	Decibel. A logarithmic unit used to describe a ratio (such as power ratio in radio telecommunications)
dBm	An abbreviation for the power ratio in decibels (dB) of the measured power referenced to one milliwatt (mW). It is used as a convenient measure of absolute power because of its capability to express both very large and very small values in a short form
eNodeB	Evolved Node B, is the element in E-UTRAN of LTE
ESP	Encapsulating Security Payloads (ESP) provide confidentiality, data-origin authentication, connectionless integrity, an anti-replay service (a form of partial sequence integrity), and limited traffic-flow confidentiality
E-UTRAN	Evolved UMTS Terrestrial Radio Access Network, is the air interface of 3GPP's Long Term Evolution
EVM/RCE	The Error Vector Magnitude or EVM (sometimes also called Receive Constellation Error or RCE) is a measure used to quantify the performance of a digital radio transmitter or receiver. It is measured in dB or percentage (%) – the lower the better
FDD	Frequency-Division Duplexing. A transceiver mode where the transmitter and receiver operate at different carrier frequencies
GNSS	Global Navigation Satellite System is a term used to describe a satellite navigation system with global coverage. There are currently two fully operational GNSSs – the US GPS and the Russian GLONASS.
GTP-U	GPRS Tunneling Protocol for User data is a relatively simple IP based tunneling protocol which permits many tunnels between each set of end points
HPBW	Half Power BandWidth is the angular separation in an antenna, in which the magnitude of the radiation pattern decreases by 50% (or -3 dB) from the peak of the main beam
ICS	In-channel selectivity is a measure of the receiver's ability to receive a wanted



AirSynergy 2000 Installation Guide

Short	Long
	signal at its assigned Resource Block locations in the presence of an interfering signal
IPSec	Internet Protocol Security is a protocol suite for securing Internet Protocol (IP) communications by authenticating and encrypting each IP packet of a communication session
LED	Light Emitting Diode
LTE	Long Term Evolution
MAC	Medium Access Controller – responsible for several functions such Error Correction, Packet (De)Multiplexing, etc...
MBSFN	Multicast-Broadcast Single Frequency Network is an LTE feature designed to deliver services such as Mobile TV using the LTE infrastructure, and is expected to be a competitor to DVB-H-based TV broadcast
MCS	Modulation and Coding Scheme
MME	Mobility Management Entity is the key control-node for the LTE access-network. It is responsible, among other things for idle mode UE tracking and paging procedure including retransmissions
MTBF	Mean Time Between Failures
OFDMA	Orthogonal Frequency-Division Multiple Access (OFDMA) is a multi-user version of OFDM digital modulation scheme, used for eNodeB transmissions to UEs
PDCP	Packet Data Convergence Protocol. A Sub-Layer in LTE responsible for IP Header (De)Compression, etc...
PDU	Protocol Data Unit
PTP	Precision Time Protocol is used to synchronize clocks throughout a network. In this document, PTP is referring to IEEE1588-2008 protocol
RB	Resource Block
RLC	Radio Link Control. A Sub-Layer in LTE responsible for Ack/Nack, error correction, packet reordering, etc...
ROHS	Restriction Of Hazardous Substances
RRC	Radio Resource Control. A Sub-Layer in LTE responsible for Broadcast of system information, paging, security functions, radio bearer control, etc...
RRM	Radio Resource Management is used to cover all functions that are related to the assignment and sharing of radio resources among UEs
S-GW	Serving Gateway. A Core entity in the LTE EPC architecture responsible for routing and forwarding user data packets, while also acting as the mobility anchor for the user plane during inter-eNodeB handovers and as the anchor for mobility between LTE and other 3GPP technologies
SBA	Switched Beam Antenna
SC-FDMA	Single-Carrier FDMA is a frequency-division multiple access scheme, dealing with the assignment of multiple users to a shared communication resource. Used in LTE for UE transmissions to the eNodeB
SCTP	Stream Control Transmission Protocol is a reliable transport layer protocol, ensuring in-sequence transport of messages with congestion control like TCP
SDR	Software Defined Radio



AirSynergy 2000 Installation Guide

Short	Long
SyncE	Synchronous Ethernet. A method for maintaining synchronous communication over Ethernet using the physical layer (L1), as defined by ITU-T G.8262
TDD	Time-Division Duplexing. A transceiver mode where the transmitter and receiver operate on the same carrier frequency
UE	User Equipment. The end user in LTE
WEEE	Waste Electrical and Electronic Equipment



10 Appendix C - Installation Checklist

The Checklist below gives the high-level steps in the Workflow for this procedure. Detach or print this page to use as a job-aid for completing the actions this procedure requires.

Table 14 - Checklist for Procedure

Procedure	Actions	Outcome
1. Verify Prerequisites	Verify site requirements Verify safety requirements Verify installation requirements	All requirements are in place for a successful installation
2. Install AirSynergy universal mounting plate	Install the universal mounting plate Verify connection torque settings	
3. Install AirSynergy on the mounting plate		
4. Connect and manage cables	Connect power cable Connect GPS	
5. Connect power system	Connect Power Connect the ground cable Connect to Ethernet backhaul	

11 Appendix D – PSU for USA

To comply with US regulations that apply to outdoor deployments of mains power supplies, a special US version of the AirSynergy power supply has been produced with the PSU module and the electrical connecting blocks enclosed in a small NEMA approved enclosure. The electrical power cable and 48V power cables are brought through the weatherproof glands provided. This type of power supply (SYN-PSU-ODUL-AC-3) must be used for all deployments in the USA.



Figure 50 - PSU for USA

1. Remove the top cover of the PSU enclosure.

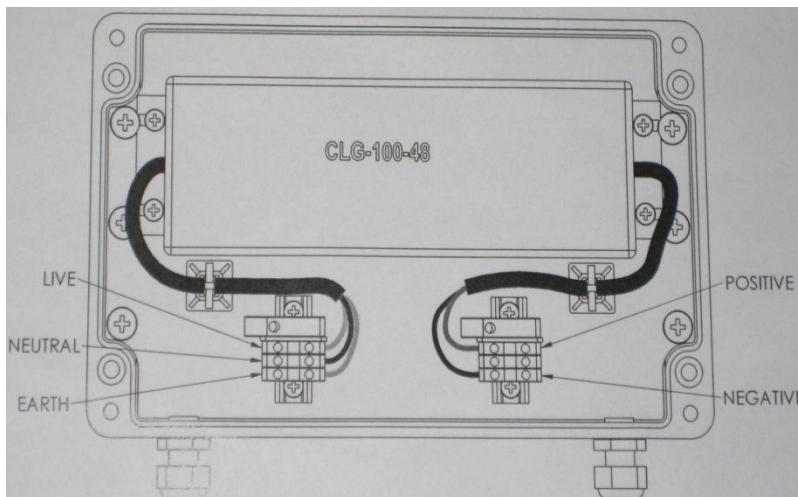

Figure 51 - Inside PSU with cable terminations

2. Feed the DC power cable through the gland nearest to the low voltage connection and connect to the terminal strip, observing the correct polarity. (Blue wire in drop cable to negative terminal and Black wire in the drop cable to positive)
3. Isolate the power supply and pass the power cable through the input gland and terminate on the connection blocks provided. The termination blocks are clearly labeled as Live, Neutral and Earth.
4. Choose a suitable position for the PSU enclosure. The PSU enclosure should be screwed to a firm surface with screws in 4 positions which are only accessible with the top cover removed.
5. Once the enclosure top cover has been re-fitted (4 screw positions) and the wiring completed the power can be connected.



12 Appendix E – Antenna (Currently Supported) Types

The currently supported antenna a listed in the table below:

Table 15 - Antenna Types - Technical

Type	Frequency range	Gain	Part number
45° Dual Slant – mounting kit (50 > 115 mm) included – Front Mount	2.3-2.7 GHz	11.0 dBi Nom	SA12-2.5-DS/1915
+/-45° Polarized 65° Sector - Quad Port Fixed Tilt – mounting kit (50 > 115 mm) included - External	2.3-2.7 GHz	18.0 dBi	AW3007
+/-45° Polarized 65° Sector - Quad Port Fixed Tilt – mounting kit (50 > 115 mm) included - External	2.3-2.7 GHz	17.0 dBi	AW3008
+/-45° Polarized 65° Sector – Dual Port Fixed Tilt - mounting kit (50 > 115 mm) included - External	1.71-2.17 GHz	17.0 dBi	AW3083



13 Appendix F

13.1 Revision History

Revision	Originator	Date	Description
Rev A	M. Falik	09-2013	Initial document

13.2 Contact Information

Customer Service Help-Desk for customer service emergency

Airspan Networks have introduced the Airspan Tracker application to enable prompt and efficient Customer Support services.

If you do not have an Airspan Tracker account, please obtain login credentials by filling-in the form in the main page www.airspan.com/Support Register New Account

Worldwide Headquarters:

Airspan Networks Inc.
777, Yamato Road, Suite 310,
Boca Raton, FL 33431, USA
Tel: +1 561 893 8670

www.airspan.com

Feedback:

To provide feedback on this document, please send comments to the following email address: documentfeedback@airspan.com