



**BOOM ARM MOWER**

Published 03/09

Part No. 02983328C

## OPERATOR'S MANUAL



This Operator's Manual is an integral part of the safe operation of this machine and must be maintained with the unit at all times. READ, UNDERSTAND, and FOLLOW the Safety and Operation Instructions contained in this manual before operating the equipment. *C01-Cover*



**ALAMO INDUSTRIAL®**

1502 E. Walnut  
Seguin, Texas 78155  
830-372-3551  
Email: parts@alamo-industrial.com



# To the Owner/Operator/Dealer

All implements with moving parts are potentially hazardous. There is no substitute for a cautious, safe-minded operator who recognizes the potential hazards and follows reasonable safety practices. The manufacturer has designed this implement to be used with all its safety equipment properly attached to minimize the chance of accidents.

**BEFORE YOU START!!** Read the safety messages on the implement and shown in your manual. Observe the rules of safety and common sense!

**DANGER**

FAILING TO FOLLOW SAFETY MESSAGES AND OPERATING INSTRUCTION CAN CAUSE SERIOUS BODILY INJURY OR EVEN DEATH TO OPERATOR AND OTHERS IN THE AREA.

<p>1. </p>	<p>2. NO RIDERS. NO CHILDREN OPERATORS </p>	<p>3. USE SAFETY SHOES, HARD HAT, SAFETY GLASSES, SEAT BELTS, ROPS &amp; OPS. </p>	<p>4. BLOCK UP SECURELY BEFORE WORKING UNDER. </p>
<p>1. Study and understand Operator's Manuals, Safety Decals, and Instructional Decals for tractor and implement to prevent misuse, abuse, and accidents. Practice before operating in a confined area or near passersby.</p> <ul style="list-style-type: none"> <li>• Learn how to stop engine suddenly in an emergency. Be alert for passersby and especially children.</li> </ul> <p>2. Allow no children on or near folding mower or tractor. Allow no riders on tractor or implement. Falling off may cause serious injury or death from being run over by tractor or mower or contact with rotating blades.</p> <p>3. Operate only with tractor having Roll-Over Protective Structure (ROPS) and with seat belt securely fastened to prevent injury and possible death from falling off or tractor overturn.</p> <ul style="list-style-type: none"> <li>• Personal Protective Equipment such as Hard Hat, Safety Glasses, Safety Shoes, &amp; Ear Plugs are recommended.</li> </ul> <p>4. Block up or support raised machine and all lifted components securely before putting hands or feet under or working underneath any lifted component to prevent crushing injury or death from sudden dropping or inadvertent operation of controls. Make certain area is clear before lowering or folding.</p> <p>5. Before transporting, put Lift Lever in detent or full-lift position. Install Transport Safety Devices securely on folding mowers. Put Booms securely in Transport Rest.</p> <ul style="list-style-type: none"> <li>• Folding and Boom Mowers have raised center of gravity. Slow down when turning and on hillsides.</li> </ul> <p>6. Make certain that SMV sign, warning lights, and reflectors are clearly visible. Follow local traffic codes.</p> <p>7. Never operate with Cutting Head or Folding Section raised if passersby, bystanders, or traffic are in the area to reduce possibility of injury or death from objects thrown by Blades under Guards or mower structure.</p> <p>8. Before dismounting, secure implement in transport position or lower to ground.</p> <ul style="list-style-type: none"> <li>• Put tractor in park or set brake, disengage PTO, stop engine, remove key, and wait until noise of rotation has ceased to prevent crushing by entanglement in rotating parts which could cause injury or death.</li> <li>• Never mount or dismount a moving vehicle. Crushing from runover may cause serious injury or death.</li> </ul>			
<p>5. TRANSPORT SAFELY, LOCK UP. </p>	<p>6. USE SMV, LIGHTS, &amp; REFLECTORS. </p>	<p>7. DO NOT OPERATE WITH CUTTER OR WING RAISED </p>	<p>8. DO NOT MOUNT OR DISMOUNT WHILE MOVING. </p>

02967827

## WARRANTY INFORMATION:

Read and understand the complete Warranty Statement found in this Manual. Fill out the Warranty Registration Form in full and return it to within 30 Days. Make certain the Serial Number of the Machine is recorded on the Warranty Card and on the Warranty Form that you retain.

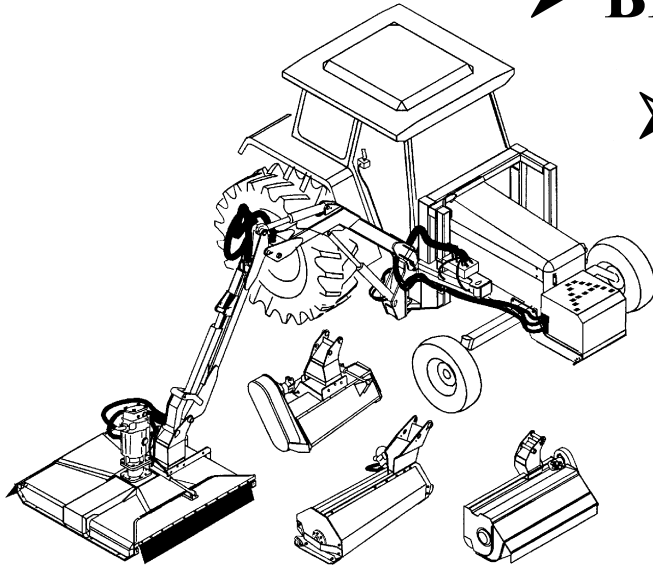

➤ **BE SAFE!**

➤ **BE ALERT!**

➤ **BE ALIVE!**

➤ **BE TRAINED  
before operating  
the Mower!**

**ALAMO  
INDUSTRIAL**

*Safety Training  
Makes the Difference*

In order to reduce accidents and enhance the safe operation of mowers, *Alamo Industrial*, in cooperation with other industry manufacturers has developed the AEM/FEMA Industrial and Agricultural Mower Safety Practices video and guide book.

The video will familiarize and instruct mower-tractor operators in safe practices when using industrial and agricultural mowing equipment. It is important that Every Mower Operator be educated in the operation of their mowing equipment and be able to recognize the potential hazards that can occur while operating a mower. This video, along with the mower operator's manual and the warning messages on the mower, will significantly assist in this important education.

Your Authorized *Alamo Industrial* Dealer may have shown this video and presented you a DVD Video when you purchased your mower. If you or any mower operator have not seen this video, **Watch the Video, Read this Operator's Manual, and Complete the Video Guidebook** before operating your new mower. If you do not understand any of the instructions included in the video or operator's manual or if you have any questions concerning safety of operation, contact your supervisor, dealer or *Alamo Industrial*.

If you would like a VHS video tape of the video, please email [AEMVideo@alamo-group.com](mailto:AEMVideo@alamo-group.com) or Fax AEM VHS Video at (830) 372-9529 or mail in a completed copy of the form on the back of this page to AEM VHS Video 1502 E Walnut Street, Seguin, TX 78155. and request the VHS video version. Please include your name, mailing address, mower model and serial number.

Every operator should be trained for each piece of equipment (Tractor and Mower), understand the intended use, and the potential hazards before operating the equipment.

**Alamo Industrial Division is willing to provide  
one (1) AEM Mower Safety Practices Video**

- Please Send Me:  VHS Format – AEM/FEMA Mower Operator Safety Video  
 DVD Format – AEM/FEMA Mower Operator Safety Video  
 Mower Operator’s Manual  
 AEM Mower Operator’s Safety Manual

Requester Name \_\_\_\_\_ Phone: \_\_\_\_\_

Requester Address: \_\_\_\_\_

City \_\_\_\_\_

State \_\_\_\_\_

Zip Code \_\_\_\_\_

Mower Model: \_\_\_\_\_ Serial Number: \_\_\_\_\_

Date Purchased: \_\_\_\_\_ Dealer Salesperson: \_\_\_\_\_

Dealership Name: \_\_\_\_\_ Dealership Location: \_\_\_\_\_

Mail to:

AEM Video Services

1502 E Walnut street

Seguin, TX 78155

Or Fax to:

(830) 372-9529

Or Email to:

AEMVideo@alamo-group.com



# Table Of Contents

- SAFETY SECTION ..... 1-1**
  - General Safety Instructions and Practices ..... 1-2
  - Operator Safety Instructions and Practices ..... 1-3
  - Connecting & Disconnecting Implement Safety Instructions & Practices ..... 1-5
  - Equipment Operation Safety Instructions and Practices ..... 1-6
  - Maintenance and Service Safety Instructions and Practices ..... 1-12
  - Transporting Safety Instructions and Practices ..... 1-14
  - Concluding Safety Instructions and Practices ..... 1-16
  - Decal Location ..... 1-17
  - Decal Description ..... 1-26
  - Federal Laws and Regulations ..... 1-39
  
- INTRODUCTION SECTION ..... 2-1**
  - Attention Owner/Operator ..... 2-4
  
- OPERATION SECTION ..... 3-1**
  - OPERATOR REQUIREMENTS ..... 3-3**
    - ROPS and Seat Belt ..... 3-4
    - Operator Thrown Object Protection ..... 3-4
    - Tractor Lighting and SMV Emblem ..... 3-5
    - Tractor Ballast ..... 3-5
  - GETTING ON AND OFF THE TRACTOR ..... 3-6**
    - Boarding the Tractor ..... 3-6
    - Dismounting the Tractor ..... 3-7
  - STARTING THE TRACTOR ..... 3-7**
  - CONNECTING ATTACHING HEADS TO THE BOOM ..... 3-8**
  - PRE-OPERATION INSPECTION AND SERVICE ..... 3-9**
    - Tractor Pre-Operation Inspection/Service ..... 3-10
    - Boom Unit Pre-Operation Inspection and Service ..... 3-10
    - Cutting Component Inspection ..... 3-19
    - Blade Bolt Inspection ..... 3-20
  - OPERATING THE MANUAL CONTROL VALVES ..... 3-21**
    - Swing ..... 3-24
    - Lift ..... 3-25
    - Dipper ..... 3-26
    - Telescoping Boom ..... 3-27
    - Tilt ..... 3-28
    - Boom Joystick Control - Optional Equipment ..... 3-29
  - OPERATING THE BOOM JOYSTICK CONTROL ..... 3-29**
    - Mower Head Power ..... 3-30
    - Swing ..... 3-31
    - Lift ..... 3-32
    - Dipper ..... 3-33
    - Tilt ..... 3-34
    - Door ..... 3-35
    - Head Swivel ..... 3-36
  - DRIVING THE TRACTOR AND IMPLEMENT ..... 3-37**
    - Starting the Tractor ..... 3-38
    - Brake and Differential Lock Setting ..... 3-39

Driving the Tractor and Boom .....	3-40
OPERATING THE BOOM UNIT AND ATTACHED HEAD .....	3-41
Foreign Debris Hazards/Overhead Obstructions .....	3-42
Operating Speed and Ground Speed .....	3-43
Operating the Attached Mower Heads .....	3-43
Shutting Down the Attached Head- For Standard Equipment .....	3-48
Shutting Down the Attached Head - For (Optional Equipment) .....	3-49
TRACTOR, BOOM, AND ATTACHED HEAD STORAGE .....	3-50
TRANSPORTING THE TRACTOR AND IMPLEMENT .....	3-50
Placing Boom Arm on Boom Arm Rest - For Standard Equipment .....	3-51
Placing Boom Arm on Boom Arm Rest - For Optional Equipment .....	3-52
Transporting on Public Roadways .....	3-53
Hauling the Tractor and Implement .....	3-55

**MAINTENANCE SECTION ..... 4-1**

Lubrication Information .....	4-2
Hydraulic Oil, Filters, and Components .....	4-4
Blades .....	4-5
Hardware .....	4-5
Cylinder Rod Maintenance .....	4-5
Proper Torque for Fasteners .....	4-6
Service of Spindle Housing (FIGURE Mnt-0006) .....	4-7
ROLLER BEARING REPLACEMENT .....	4-10
TIMBER CAT HEAD .....	4-11
Buzzbar Head .....	4-12
Flail Axe Head .....	4-14
Grass Flail Head .....	4-15
General Information on Flail Mower Vibration .....	4-17
Start up Procedure .....	4-18

# **SAFETY SECTION**

Safety Section 1-1

# SAFETY

## General Safety Instructions and Practices

A careful operator is the best operator. Safety is of primary importance to the manufacturer and should be to the owner/operator. Most accidents can be avoided by being aware of your equipment, your surroundings, and observing certain precautions. The first section of this manual includes a list of Safety Messages that, if followed, will help protect the operator and bystanders from injury or death. Read and understand these Safety Messages before assembling, operating or servicing this Implement. This equipment should only be operated by those persons who have read the manual, who are responsible and trained, and who know how to do so responsibly.



The Safety Alert Symbol combined with a Signal Word, as seen below, is used throughout this manual and on decals which are attached to the equipment. The Safety Alert Symbol means: "ATTENTION! BECOME ALERT! YOUR SAFETY IS INVOLVED!" The Symbol and Signal Word are intended to warn the owner/operator of impending hazards and the degree of possible injury faced when operating this equipment.

Practice all usual and customary safe working precautions and above all---remember safety is up to YOU. Only YOU can prevent serious injury or death from unsafe practices.



Indicates an imminently hazardous situation that, if not avoided, WILL result in DEATH OR VERY SERIOUS INJURY.



Indicates an imminently hazardous situation that, if not avoided, COULD result in DEATH OR SERIOUS INJURY.



Indicates an imminently hazardous situation that, if not avoided, MAY result in MINOR INJURY.



Identifies special instructions or procedures that, if not strictly observed, could result in damage to, or destruction of the machine, attachments or the environment.

**NOTE:** *Identifies points of particular interest for more efficient and convenient operation or repair.*(SG-1)

READ, UNDERSTAND, and FOLLOW the following Safety Messages. Serious injury or death may occur unless care is taken to follow the warnings and instructions stated in the Safety Messages. Always use good common sense to avoid hazards. (SG-2)



Si no lee ingles, pida ayuda a alguien que si lo lea para que le traduzca las medidas de seguridad. (SG-3)

**¡ LEA EL INSTRUCTIVO!**



# SAFETY



Engine Exhaust, some of its constituents, and certain vehicle components contain or emit chemicals known to the state of California to cause cancer and birth defects or other reproductive harm. (SG-30)



Battery posts, terminals and related accessories contain lead and lead compounds, chemicals known to the state of California to cause cancer, birth defects or other reproductive harm. (SG-31)

## Operator Safety Instructions and Practices



Never operate the Tractor or Implement until you have read and completely understand this Manual, the Tractor Operator's Manual, and each of the Safety Messages found in the Manual or on the Tractor and Implement. Learn how to stop the tractor engine suddenly in an emergency. Never allow inexperienced or untrained personnel to operate the Tractor and Implement without supervision. Make sure the operator has fully read and understood the manuals prior to operation.

(SG-4)

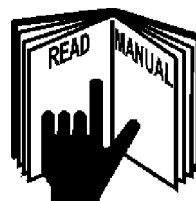

The operator and all support personnel should wear hard hats, safety shoes, safety glasses, and proper hearing protection at all times for protection from injury including injury from items that may be thrown by the equipment. (SG-16)

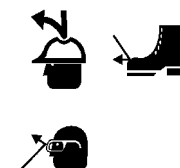

PROLONGED EXPOSURE TO LOUD NOISE MAY CAUSE PERMANENT HEARING LOSS! Tractors with or without an Implement attached can often be noisy enough to cause permanent hearing loss. We recommend that you always wear hearing protection if the noise in the Operator's position exceeds 80db. Noise over 85db over an extended period of time will cause severe hearing loss. Noise over 90db adjacent to the Operator over an extended period of time will cause permanent or total hearing loss. **NOTE:** *Hearing loss from loud noise [from tractors, chain saws, radios, and other such sources close to the ear] is cumulative over a lifetime without hope of natural recovery.* (SG-17)



Always read carefully and comply fully with the manufacturer's instructions when handling oil, solvents, cleansers, and any other chemical agent. (SG-22)



SAFETY



# SAFETY



KEEP AWAY FROM ROTATING ELEMENTS to prevent entanglement and possible serious injury or death. (SG-24)



Never allow children to play on or around Tractor or Implement. Children can slip or fall off the Equipment and be injured or killed. Children can cause the Implement to shift or fall crushing themselves or others. (SG-25)



NEVER use drugs or alcohol immediately before or while operating the Tractor and Implement. Drugs and alcohol will affect an operator's alertness and coordination and therefore affect the operator's ability to operate the equipment safely. Before operating the Tractor or Implement, an operator on prescription or over-the-counter medication must consult a medical professional regarding any side effects of the medication that would hinder their ability to operate the Equipment safely. NEVER knowingly allow anyone to operate this equipment when their alertness or coordination is impaired. Serious injury or death to the operator or others could result if the operator is under the influence of drugs or alcohol. (SG-27)

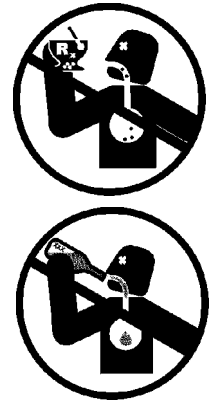

Prolonged operation may cause operator boredom and fatigue affecting safe operation. Take scheduled work breaks to help prevent these potentially impaired operating conditions. Never operate the Implement and Tractor in a fatigued or bored mental state which impairs proper and safe operation. (SG-32)



Use extreme caution when getting onto the Implement to perform repairs, maintenance and when removing accumulated material. Only stand on solid flat surfaces to ensure good footing. Use a ladder or raised stand to access high spots which cannot be reached from ground level. Slipping and falling can cause serious injury or death. (SG-33)



Avoid contact with hot surfaces including hydraulic oil tanks, pumps, motors, valves and hose connections. Relieve hydraulic pressure before performing maintenance or repairs. Use gloves and eye protection when servicing hot components. Contact with a hot surface or fluid can cause serious injury from burns or scalding. (SG-34)



DO NOT operate this Implement on a Tractor that is not properly maintained. Should a mechanical or Tractor control failure occur while operating, immediately shut down the Tractor and perform repairs before resuming operation. Serious injury and possible death could occur from not maintaining this Implement and Tractor in good operating condition. (SG-36)



Avoid contact with hot surfaces of the engine or muffler. Use gloves and eye protection when servicing hot components. Contact with a hot surface or fluid can cause serious injury from burns or scalding. (SG-38)

# SAFETY



The rotating parts of this machine continue to rotate even after the Tractor has been turned off. The operator should remain in his seat for 60 seconds after the brake has been set, the PTO disengaged, the tractor turned off, and all evidence of rotation has ceased. (SBM-5)

**“Wait a minute...Save a life!”**



Do not put hands or feet under mower decks. Blade Contact can result in serious injury or even death. Stay away until all motion has stopped and the decks are securely blocked up. (SFL-2)



Do not put hands or feet under mower decks. Blade Contact can result in serious injury or even death. Stay away until all motion has stopped and the decks are securely blocked up. (SGM-09)

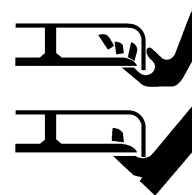

Do not put hands or feet near the cutter bar. Blade contact can result in serious injury. Stay away until all motion has stopped and the mower is securely blocked up. (SSM-1)



Do not operate the implement while wearing loose fitting clothing. Entanglement of the clothing with the rotating elements can result in serious injury or even death. Stay clear of all rotating elements at all times. (SSP-03)

## **Connecting & Disconnecting Implement Safety Instructions & Practices**



Each Rear Wheel must have a minimum of 1500 pound contact with the surface to prevent lateral instability and possible tip-over which could result in serious bodily injury or even death. Widen the wheel tread and add weights if needed. Refer to the mounting instructions or call Customer Service if you need assistance with Counterweight Procedure. (SBM-11)



Do Not attempt to raise or lower the boom or mower head unless the Implement is securely attached to the Tractor. The Implement could tip over and cause equipment damage and possible serious injury or death. Do Not use the boom controls to assist in installing the implement on the tractor. Raise or Lower the boom and mower head only while seated in the Tractor operator's seat with the seat belt securely fastened. Inadvertent contact with the boom controls could allow a component to fall. A sudden or inadvertent fall by any of these components could cause serious injury or even death. (SBM-23)

**SAFETY**

# SAFETY

## Equipment Operation Safety Instructions and Practices



**WARNING** Never leave the Tractor and Implement unattended while the Implement is in the lifted position. Accidental operation of lifting lever or a hydraulic failure may cause sudden drop of unit with injury or death by crushing. To properly park the implement when disconnecting it from the tractor, lower the stand and put the retaining pin securely in place, or put a secure support under the A-Frame. Lower the implement carefully to the ground. Do not put hands or feet under lifted components. (S3PT-1)



**DANGER** This Implement is wider than the Tractor. Be careful when operating or transporting this equipment to prevent the Implement from running into or striking sign posts, guard rails, concrete abutments or other solid objects. Such an impact could cause the Implement and Tractor to pivot violently resulting in loss of steering control, serious injury, or even death. Never allow the Implement to contact obstacles. (S3PT-12)



**DANGER** Use extreme caution when raising the Mower head. Stop the Blades from turning when the Mower Head is raised and passersby are within 100 yards. Raising the Mower head exposes the Cutting Blades which creates a potentially serious hazard and can cause serious injury by objects thrown from the Blades or by contact with the Blades. (SBM-2)



**WARNING** Never Leave the mower unattended while the head is in the raised position. The mower could fall causing serious injury to anyone who might inadvertently be under the mower. (SBM-4)



**DANGER** Always keep a careful lookout and use extreme care when working around overhead obstructions. Never allow the Mower head or boom within 10 feet of any power line. When working close to overhead power lines consult your electric company for a safe code of operation. (SBM-7)

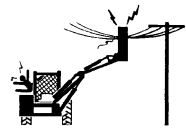

**DANGER** The center of Gravity of Tractors equipped with a Rear-Mounted Boom Mower is shifted to the rear and removes weight from the front wheels. Add front ballast until at least 20% of the tractors weight is on the front wheels to prevent rearing up, loss of steering control, and possibly injury. (SBM-10)



**DANGER** The Mower shaft speed must not - **UNDER ANY CIRCUMSTANCES** - exceed 1800 RPM. (SBM-15)



**WARNING** Use extreme care and Safety Awareness when using the boom mower head to mulch loose brush or wood that has fallen on the ground from overhead trimming. **DO NOT** mulch this debris if bystanders, vehicles, livestock or buildings are within 300 feet of the mower. This cut debris can be thrown at great velocities and could result in serious injury or even death. (SBM-17)

# SAFETY

## **CAUTION**

Do not back up this implement when the boom or mower head is extended. Backing could damage the machine or its components. (SBM-19)

## **WARNING**

Follow these guidelines to reduce the risk of equipment and grass fires while operating, servicing, and repairing the Mower and Tractor:

-Equip the Tractor with a fire extinguisher in an accessible location.

-Do Not operate the Mower on a Tractor with an underframe exhaust.

-Do Not smoke or have an open flame near the Mower and Tractor.

-Do Not drive into burning debris or freshly burnt areas.

-Do Not attempt to mow or place the mower head close to burning debris.

-Never allow clippings or debris to collect near drivelines, gearboxes or hydraulic components such as valves, tanks, pumps and motors. Periodically shut down the Tractor and Mower and clean clippings and collected debris from the mower deck. (SBM-20)

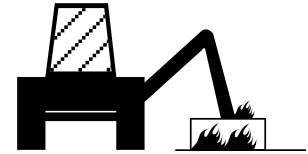

**SAFETY**

## **WARNING**

Do not operate Mower if excessive vibration exists. Shut down PTO and the Tractor engine. Inspect the Mower to determine the source of the vibration. If Mower blades are missing or damaged replace them immediately. Do not operate the mower until the blades have been replaced and the Mower operates smoothly. Operating the Mower with excessive vibration can result in component failure and broken objects to be thrown outward at very high velocities. To reduce the possibility of property damage, serious injury, or even death, never allow the Mower to be operated with blades missing. (SFL-4)

# SAFETY



Flail Mowers are capable under adverse conditions of throwing objects for great distances (100 yards or more) and causing serious injury or death. Follow safety messages carefully.



STOP MOWING IF PASSERSBY ARE WITHIN 100 YARDS UNLESS:

-Front and Rear Deflectors, Chain Guards, or Bands are installed and in good, workable condition;

-Mower sections or Wings are running close to and parallel to the ground without exposed Blades;

-Passerby are outside the existing thrown-object zone; -All areas have been thoroughly inspected and all foreign material such as rocks, cans, glass, and general debris has been removed.

NOTE: Where there are grass and weeds high enough to hide debris that could be struck by the blades, the area should be: inspected and large debris removed, mowed at an intermediate height, inspected, closely with any remaining debris being removed, and mowed again at desired final height. (This will also reduce power required to mow, reduce wear and tear on the Mower drivetrain, spread cut material better, eliminate streaking, and make the final cut more uniform.) (SFL-6)



Operate this Equipment only with a Tractor equipped with an approved roll-over-protective system (ROPS). Always wear seat belts. Serious injury or even death could result from falling off the tractor--particularly during a turnover when the operator could be pinned under the ROPS. (SG-7)



BEFORE leaving the tractor seat, always engage the brake and/or set the tractor transmission in parking gear, disengage the PTO, stop the engine, remove the key, and wait for all moving parts to stop. Place the tractor shift lever into a low range or parking gear to prevent the tractor from rolling. Never dismount a Tractor that is moving or while the engine is running. Operate the Tractor controls from the tractor seat only. (SG-9)

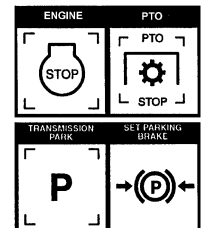

Never allow children or other persons to ride on the Tractor or Implement. Falling off can result in serious injury or death. (SG-10)



Never allow children to operate, ride on, or come close to the Tractor or Implement. Usually, 16-17 year-old children who are mature and responsible can operate the implement with adult supervision, if they have read and understand the Operator's Manuals, been trained in proper operation of the tractor and Implement, and are physically large enough to reach and operate the controls easily. (SG-11)





# SAFETY



Do not mount or dismount the Tractor while the tractor is moving. Mount the Tractor only when the Tractor and all moving parts are completely stopped. (SG-12)



Start tractor only when properly seated in the Tractor seat. Starting a tractor in gear can result in injury or death. Read the Tractor operators manual for proper starting instructions. (SG-13)



Do not operate this Equipment with hydraulic oil or fuel leaking. Oil and fuel are explosive and their presence could present a hazard. Do not check for leaks with your hand! High-pressure oil streams from breaks in the line could penetrate the skin and cause tissue damage including gangrene. To check for a hose leak, SHUT the unit ENGINE OFF and remove all hydraulic pressure. Wear oil impenetrable gloves, safety glasses and use Cardboard to check for evidence of oil leaks. If you suspect a leak, REMOVE the HOSE and have it tested at a Dealer. If oil does penetrate the skin, have the injury treated immediately by a physician knowledgeable and skilled in this procedure. (SG-15)



Never run the Tractor engine in a closed building or without adequate ventilation. The exhaust fumes can be hazardous to your health. (SG-23)



Do not exceed the rated PTO speed for the Implement. Excessive PTO speeds can cause Implement driveline or blade failures resulting in serious injury or death. (SG-26)



Operate the Tractor and/or Implement controls only while properly seated in the Tractor seat with the seat belt securely fastened around you. Inadvertent movement of the Tractor or Implement may cause serious injury or death. (SG-29)



In case of mechanical difficulty during operation, place the transmission in the park position, set the parking brake, shut down all power, including the PTO and the engine and remove the key. Wait until all rotating motion has stopped before dismounting. (SG-39)

SAFETY

# SAFETY

**WARNING**

Do Not operate this equipment in areas where insects such as bees may attack you and/or cause you to lose control of the equipment. If you must enter in such areas, use a tractor with an enclosed Cab and close the windows to prevent insects from entering. If a tractor cab is not available, wear suitable clothing including head, face, and hand protection to shield you from the insects. Attacking insects can cause you to lose control of the tractor, which can result in serious injury or death to you or bystanders. Never dismount a moving tractor. (SG-40)

**WARNING**

Mow only in conditions where you have clear visibility in daylight or with adequate artificial lighting. Never mow in darkness or foggy conditions where you cannot clearly see at least 100 yards(90 m) in front and to the sides of the tractor and mower. Make sure that you can clearly see and identify passersby, steep slopes, ditches, drop-offs, overhead obstructions, power lines, debris and foreign objects. If you are unable to clearly see these type of items discontinue mowing. (SGM-1)

**DANGER**

There are obvious and hidden potential hazards in the operation of this Mower. REMEMBER! This machine is often operated in heavy brush and in heavy weeds. The Blades of this Mower can throw objects if shields are not properly installed and maintained. Serious injury or even death may occur unless care is taken to insure the safety of the operator, bystanders, or passersby in the area. Do not operate this machine with anyone in the immediate area. Stop mowing if anyone is within 100 yards of mower. (SGM-02)



**DANGER**

The rotating parts of this machine have been designed and tested for rugged use. However, the blades could fail upon impact with heavy, solid objects such as metal guard rails and concrete structures. Such impact could cause the broken objects to be thrown outward at very high velocities. To reduce the possibility of property damage, serious injury, or even death, never allow the cutting blades to contact such obstacles. (SGM-4)

**WARNING**

Extreme care should be taken when operating near loose objects such as gravel, rocks, wire, and other debris. Inspect the area before mowing. Foreign objects should be removed from the site to prevent machine damage and/or bodily injury or even death. Any objects that cannot be removed must be clearly marked and carefully avoided by the operator. Stop mowing immediately if blades strike a foreign object. Repair all damage and make certain rotor or blade carrier is balanced before resuming mowing. (SGM-05)



**WARNING**

Many varied objects, such as wire, cable, rope, or chains, can become entangled in the operating parts of the mower head. These items could then swing outside the housing at greater velocities than the blades. Such a situation is extremely hazardous and could result in serious injury or even death. Inspect the cutting area for such objects before mowing. Remove any like object from the site. Never allow the cutting blades to contact such items. (SGM-06)

# SAFETY

## **WARNING**

Mow at the speed that you can safely operate and control the tractor and mower. The correct mowing speed depends on terrain condition and grass type, density, and height of cut. Normal ground speed range is from 2 to 5 mph(3-8 kph). Use slow mowing speeds when operating on or near steep slopes, ditches, drop-offs, overhead obstructions, power lines, or when debris and foreign objects are to be avoided. (SGM-07)

## **WARNING**

Avoid mowing in reverse direction when possible. Check to make sure there are no persons behind the mower and use extreme care when mowing in reverse. Mow only at a slow ground speed where you can safely operate and control the tractor and mower. Never mow an area that you have not inspected and removed debris or foreign material. (SGM-08)

## **WARNING**

Do not mow with two machines in the same area except with Cab tractors with the windows closed. (SGM-11)

## **WARNING**

Follow these guidelines to reduce the risk of equipment and grass fires while operating, servicing, and repairing the Mower and Tractor:



- Equip the Tractor with a fire extinguisher in an accessible location.
- Do Not operate the Mower on a Tractor with an underframe exhaust.
- Do Not smoke or have an open flame near the Mower and Tractor.
- Do Not drive into burning debris or freshly burnt areas.
- Ensure slip clutches are properly adjusted to prevent excessive slippage and plate heating.
- Never allow clippings or debris to collect near drivelines, slip clutches, and gearboxes. Periodically shut down the Tractor and Mower and clean clippings and collected debris from the mower deck. (SGM-12)

## **DANGER**

The Mower is designed for certain mowing applications and is rated to cut up to a specific size vegetation (see Mower Standard Equipment and Specifications). DO NOT use this mower to cut vegetation above the Mower's rated capacity or to cut any type of non-vegetative material. Only operate this Mower on a properly sized and equipped Tractor. Operating this Mower in an application for which it is not designed and/or operating the Mower with the wrong size Tractor can cause Mower component damage and equipment failure resulting in possible serious injury or death. (SGM-14)

## **WARNING**

Never leave the Implement and Power Unit unattended while the Implement is in the raised position. Accidental operation of a lifting lever or a hydraulic failure may cause the implement to suddenly fall causing serious injury or possible death to anyone who might inadvertently be under the Implement. Lower the implement carefully to the ground. Do not put hands or feet under lifted components. (SPU-3)

# SAFETY



Do not let the Blades turn when the Mower Deck is raised for any reason, including clearance or for turning. Raising the Mower deck exposes the Cutting Blades which creates a potentially serious hazard and could cause serious injury or even death from objects thrown from the Blades. (SRM-07)



## Maintenance and Service Safety Instructions and Practices



Make sure the PTO shield, integral driveline shields, and input shields are installed when using PTO-driven equipment. Always replace any shield if it is damaged or missing. (S3PT-8)



Always disconnect the main PTO Driveline from the Tractor before performing service on the Implement. Never work on the Implement with the tractor PTO driveline connected and running. Rotating Parts, Blades or Drivelines could turn without warning and cause immediate entanglement, injury or death. (S3PT-11)



Never interfere with factory-set hydraulic calibrations. Any change in calibration could cause a failure of the equipment and may result in injury. (SBH-13)



Relieve hydraulic pressure prior to doing any maintenance or repair work on the Implement. Place the Mower Head on the ground or securely supported on blocks or stands, disengage the PTO, and turn off the engine. Push and pull the control Levers or Joystick several times to relieve pressure prior to starting any maintenance or repair work. (SBM-6)



Always disconnect the wire leads from the mower pump solenoid before performing service on the Tractor or Mower. Use caution when working on the Tractor or Mower. Tractor engine must be stopped before working on Mower or Tractor. The Mower Blades could inadvertently be turned on without warning and cause immediate dismemberment, injury or death. (SBM-12a)

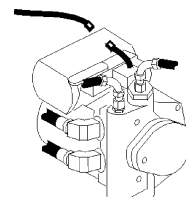

All Safety Shields, Guards and Safety devices including (but not limited to) - the Deflectors, Chain Guards, Steel Guards, Gearbox Shields, PTO integral shields, and Retractable Door Shields should be used and maintained in good working condition. All safety devices should be inspected carefully at least daily for missing or broken components. Missing, broken, or worn items must be replaced at once to reduce the possibility of injury or death from thrown objects, entanglement, or blade contact. (SBM-18)

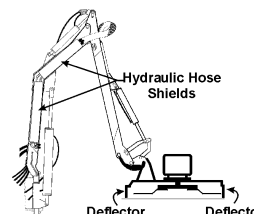

# SAFETY



**DO NOT** allow any person under a raised boom or mower head unless it is securely locked up or supported. **DO NOT** approach the Implement unless the Tractor is turned off and all motion has ceased. Never work under the frame work, or any lifted component unless the implement is securely supported or blocked up. Inadvertent contact with the controls could allow a component to fall. A sudden or inadvertent fall by any of these components could cause serious injury or even death. (SBM-22)



Always maintain the safety signs in good readable condition. If the safety signs are missing, damaged, or unreadable, obtain and install replacement safety signs immediately. (SG-5)



Do not modify or alter this Implement. Do not permit anyone to modify or alter this Implement, any of its components or any Implement function. (SG-8)



Never work under the Implement, the framework, or any lifted component unless the Implement is securely supported or blocked up to prevent sudden or inadvertent falling which could cause serious injury or even death. (SG-14)



Never attempt to lubricate, adjust, or remove material from the Implement while it is in motion or while tractor engine is running. (SG-20)



Periodically inspect all moving parts for wear and replace when necessary with authorized service parts. Look for loose fasteners, worn or broken parts, and leaky or loose fittings. Make sure all pins have cotter pins and washers. Serious injury may occur from not maintaining this machine in good working order. (SG-21)

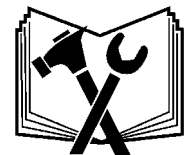

Do Not fill fuel tank while engine is running. Refuel only after engine has cooled down. If fuel is spilled, move machine away from the area of the spill and avoid creating any source of ignition until the gasoline has evaporated. (SG-28)



# SAFETY



Perform service, repairs and lubrication according to the maintenance section. Ensure the unit is properly lubricated as specified in the lubrication schedule and all bolts and nuts are properly torqued. Failure to properly service, repair and maintain this Implement in good operating condition could cause component failure and possible serious injury or even death. (SG-35)



Use caution and wear protective gloves when handling sharp objects such as blades, knives, and other cutting edges. Be alert to worn component surfaces which have sharp edges. Sharp surfaces can inflict severe laceration injuries if proper hand protection is not worn. (SG-37)



Replace bent or broken blades with new blades. NEVER ATTEMPT TO STRAIGHTEN, WELD, OR WELD HARDFACING ON BLADES SINCE THIS WILL LIKELY CRACK OR OTHERWISE DAMAGE THE BLADE WITH SUBSEQUENT FAILURE AND POSSIBLE SERIOUS INJURY FROM THROWN BLADES. (SGM-10)



DO NOT weld or repair rotating mower components. Welds and other repairs may cause severe vibration and/or component failure resulting in part being thrown from the mower causing serious bodily injury. See your Authorized Dealer for proper repairs. (SGM-13)

## PARTS INFORMATION

Alamo Industrial mowers use balanced and matched system components for blade carriers, blades, cuttershafts, knives, knife hangers, rollers, drivetrain components, and bearings. These parts are made and tested to Alamo Industrial specifications. Non-genuine "will fit" parts do not consistently meet these specifications. The use of "will fit" parts may reduce mower performance, void mower warranties, and present a safety hazard. Use genuine Alamo Industrial mower parts for economy and safety. (SPRM-1)

## SEE YOUR ALAMO DEALER

## Transporting Safety Instructions and Practices



Be particularly careful when transporting the Implement with the Tractor. Turn curves or go up hills only at a low speed and using a gradual steering angle. Rear mounted implements move the center of gravity to the rear and remove weight from the front wheels. Make certain, by adding front ballast, that at least 20% of the tractor's weight is on the front wheels to prevent rearing up, loss of steering control or Tractor tip-over. Slow down on rough or uneven surfaces to prevent loss of steering control which could result in property damage or possible injury. Do not transport unless 3-Point lift lever is fully raised and in the latched transport position. Dropping implement in transport can cause serious damage to the tractor and/or Implement and possibly cause the operator or others to be injured or killed. (S3PT-02)



Allow sufficient clearance for the Implement to swing outward while turning. Implements carried behind the Tractor will swing outside the tire path when making turns. Contacting a solid object while turning will cause equipment damage and possible injury. (S3PT-20)

# SAFETY

## **⚠ DANGER**

Be particularly careful in transport. The Mower has raised the center of gravity for the tractor and has increased the possibility of overturn. Turn curves or go up slopes only at low speed and using a gradual turning angle. Slow down on rough or uneven surfaces. (SBM-3)



## **⚠ DANGER**

When transporting Boom Mower on a truck or trailer, the height or width may exceed legal limits when the boom is in the transport position. Contact with side or overhead structures or power lines can cause property damage or serious injury or death. If necessary lower boom to reduce height and/or remove mowing head to reduce width to the legal limits. (SBM-8)



## **⚠ DANGER**

Never operate the Tractor and Mower Unit without an OPS (Operators Protective Structure) or Cab to prevent injury from objects thrown from ground or from overhead trimming. Stop mowing if workers or passersby are within 100 yards. (SBM-9)

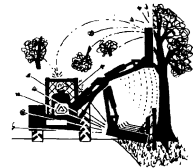

## **⚠ WARNING**

The Joystick Master Control Switch must be OFF to prevent accidental movement of the boom and cutting head whenever the mower is not being operated. (SBM-16)

## **⚠ WARNING**

Secure the boom and mower head in the transport position before traveling on public roads. Never transport on public roads with the boom and mower head extended. Always disengage and lock out the hydraulic controls for the boom mower before transporting. Inadvertent boom movement on public roads may contact with other vehicles resulting in serious bodily injuries or even death. (SBM-21)

## **⚠ WARNING**

Make certain that the "Slow Moving Vehicle" (SMV) sign is installed in such a way as to be clearly visible and legible. When transporting the Equipment use the Tractor flashing warning lights and follow all local traffic regulations. (SG-6)

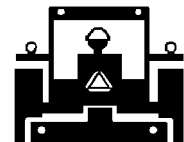

SAFETY

# SAFETY



Transport only at speeds where you can maintain control of the equipment. Serious accidents and injuries can result from operating this equipment at high speeds. Understand the Tractor and Implement and how it handles before transporting on streets and highways. Make sure the Tractor steering and brakes are in good condition and operate properly.



Before transporting the Tractor and Implement, determine the proper transport speeds for you and the equipment. Make sure you abide by the following rules:

Test the tractor at a slow speed and increase the speed slowly. Apply the Brakes smoothly to determine the stopping characteristics of the Tractor and Implement. As you increase the speed of the Tractor the stopping distance increases. Determine the maximum transport speed not to exceed 20 mph (30 kph) for transporting this equipment.

Test the equipment at a slow speed in turns. Increase the speed through the turn only after you determine that the equipment can be operated at a higher speed. Use extreme care and reduce your speed when turning sharply to prevent the tractor and implement from turning over. Determine the maximum turning speed for you and this equipment before operating on roads or uneven ground.



Only transport the Tractor and Implement at the speeds which allow you to properly control the equipment.

Be aware of the operating conditions. Do not operate the Tractor with weak or faulty brakes or worn tires. When operating down a hill or on wet or rain slick roads, the braking distance increases: use extreme care and reduce your speed. When operating in traffic always use the Tractor's flashing warning lights and reduce your speed. Be aware of traffic around you and watch out for the other guy. (SG-19)



Your driving vision may be reduced or impaired by the tractor, cab, or implement. Before driving on public roadways identify any limited vision areas, and make adjustments to your operating position, mirrors, and the implement transport position so that you can clearly see the area where you will be traveling, and any traffic that may approach you. Failure to maintain adequate vision of the public roadway and traffic can result in serious injury or even death. (STI-10)

## **Concluding Safety Instructions and Practices**

In addition to the design and configuration of this Implement, including Safety Signs and Safety Equipment, hazard control and accident prevention are dependent upon the awareness, concern, prudence, and proper training of personnel involved in the operation, transport, maintenance, and storage of the machine. Refer also to Safety Messages and operation instruction in each of the appropriate sections of the Tractor and Equipment Manuals. Pay close attention to the Safety Signs affixed to the Tractor and Equipment. (SG-18)

# SAFETY

**SAFETY**

## Decal Location

**NOTE:** Alamo Industrial supplies safety decals on this product to promote safe operation. Damage to the decals may occur while in shipping, use, or reconditioning. Alamo Industrial cares about the safety of its customers, operators, and bystanders, and will replace the safety decals on this product in the field, free of charge (Some shipping and handling charges may apply). Contact your Alamo Industrial dealer to order replacement decals.

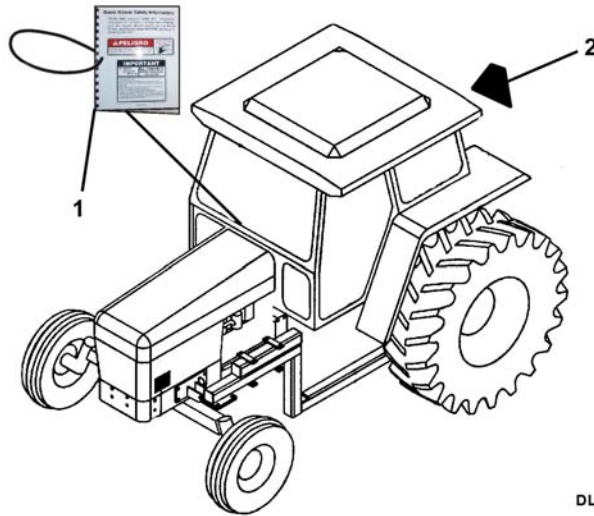

DL-0010

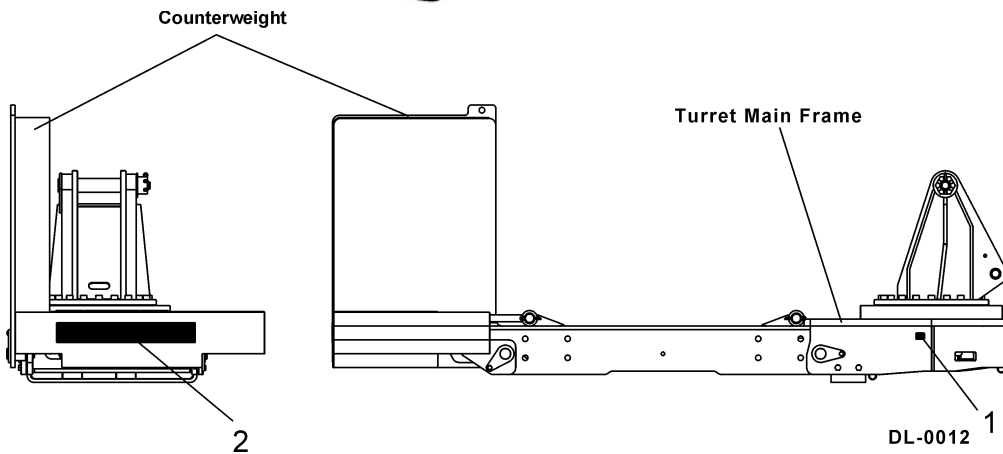

DL-0012

ITEM	PART NO.	QTY.	TYPE	DESCRIPTION
	-	-	-	<b>Tractor Decals</b>
1.	D377	1	INSTRUCT	Boom Mower Safety Booklet
2.	03200347	1	REFLECT	SMV
	-	-	-	<b>Frame &amp; Counterweight Decals</b>
1.	000678	1	INSTRUCT	Grease Fitting Inside
2.	02971943	1	LOGO	Alamo Industrial 2-7/8x20

# SAFETY

**SAFETY**

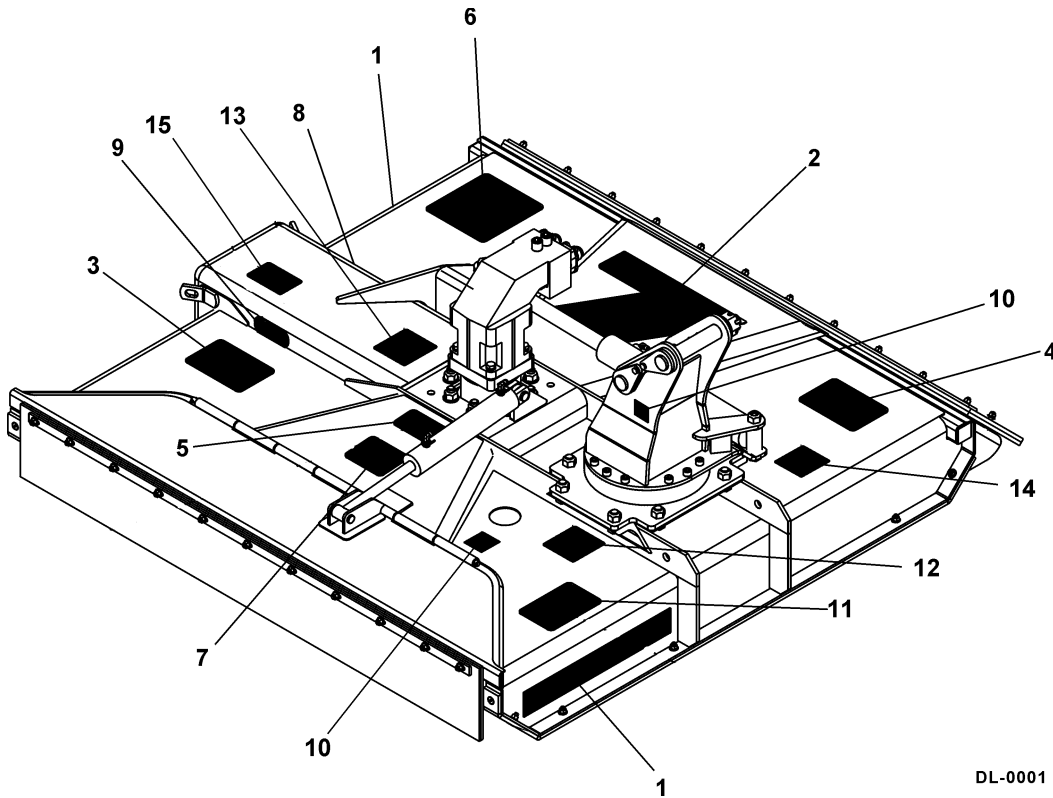

DL-0001

ITEM	PART NO.	QTY.	LEVEL	DESCRIPTION
	02983222	1	-	60" Rotary
	02983208	1	-	60" Rotary
	02985242	1	-	50" Rotary
	02985243	1	-	50" Rotary
1.	00757139	2	LOGO	Alamo Group
2.	00757140	1	LOGO	Alamo Industrial
3.	02958241	1	DANGER	Tractor Operator Safety
4.	02967668	1	DANGER	Thrown Objects
5.	02925100	1	IMPORTANT	Replacement Parts
6.	02967827	1	DANGER	Multi Hazard
7.	02967867	1	DANGER	Safety Shield
8.	2738332	1	REFLECT	Red Reflector
9.	2738333	1	REFLECT	Yellow Reflector
10.	02962764	2	WARNING	Pinch Points
11.	TB1011	1	WARNING	Do not Remove Shields
12.	24028	1	WARNING	Replace Worn Rubber Deflectors
13.	D138	1	INSTRUCT	CW Blade Rotation
14.	22839	1	CAUTION	Hand Gun Grease Only
15.	D375	1	WARNING	Replace Blades in Pairs

# SAFETY

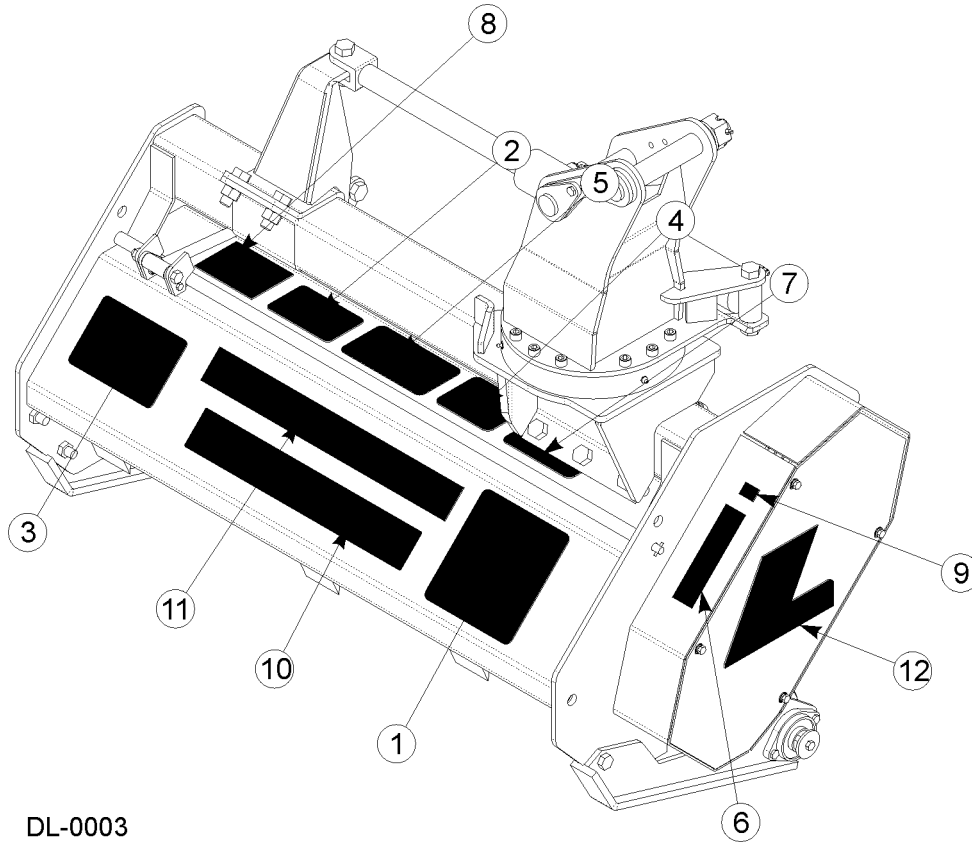

DL-0003

ITEM	PART NO.	QTY.	LEVEL	DESCRIPTION
		1	-	48" Flail Axe
1.	002369	1	DANGER	Multi-Hazard
2.	02965141	1	DANGER	Thrown Objects
3.	02967668	1	DANGER	Thrown Objects Safety Shields
4.	02967867	1	DANGER	Safety Shield
5.	00725739	1	WARNING	Shield and Guards
6.	00758194	1	WARNING	Belt Shield
7.	02925100	1	IMPORTANT	Replacement Parts
8.	000108	1	INSTRUCT	Flail Operation
9.	000678	1	INSTRUCT	Grease Fitting Inside
10.	00757139	1	LOGO	Alamo Industrial
11.	02970887	1	LOGO NAME	Flail Axe 48"
12.	02979551	1	LOGO	Alamo Industrial Square

**SAFETY**

# SAFETY

**SAFETY**

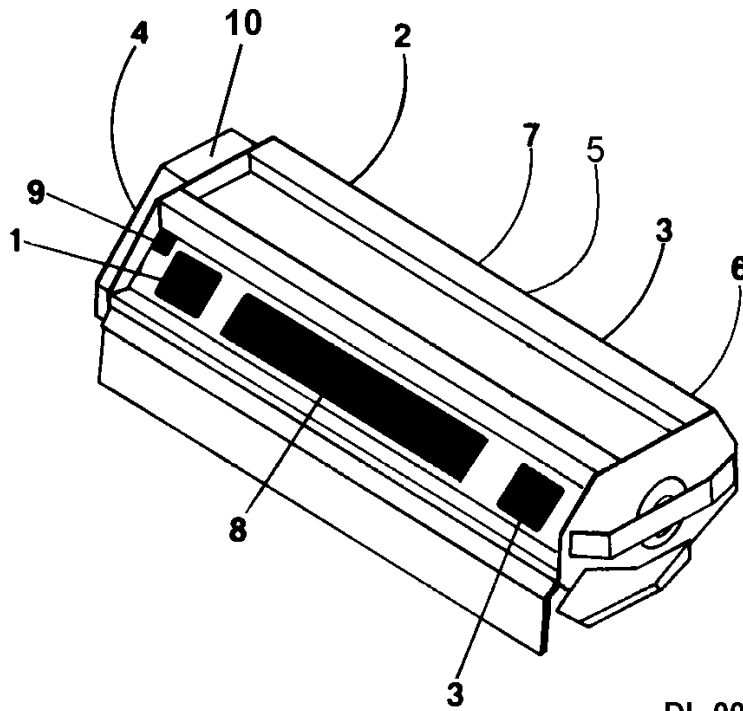

**DL-0017**

ITEM	PART NO.	QTY.	TYPE	DESCRIPTION
-	-	-	-	<b>Flail Head</b>
1.	002369	1	DANGER	Flail Multi Hazard
2.	00756007	1	WARNING	Use/Repair Shields/Guards
3.	02967668	1	DANGER	Cutting Blades/Thrown Objects
4.	00758194	1	WARNING	Pinch Point (V-Belt/Pulley
5.	02965141	1	DANGER	Boom Flails
6.	000108	1	INSTRUC	Flail Operating Inst
7.	03200432	1	IMPORTANT	Genuine Parts, Flail
8.	00757139	1	LOGO	ALAMO (4-1/2 x 16-1/2)
9.	NFS	1	SER PLT	Flail Mower Serial Plate
10.	000678	2	INSTRUC	Grease Fitting Inside

# SAFETY

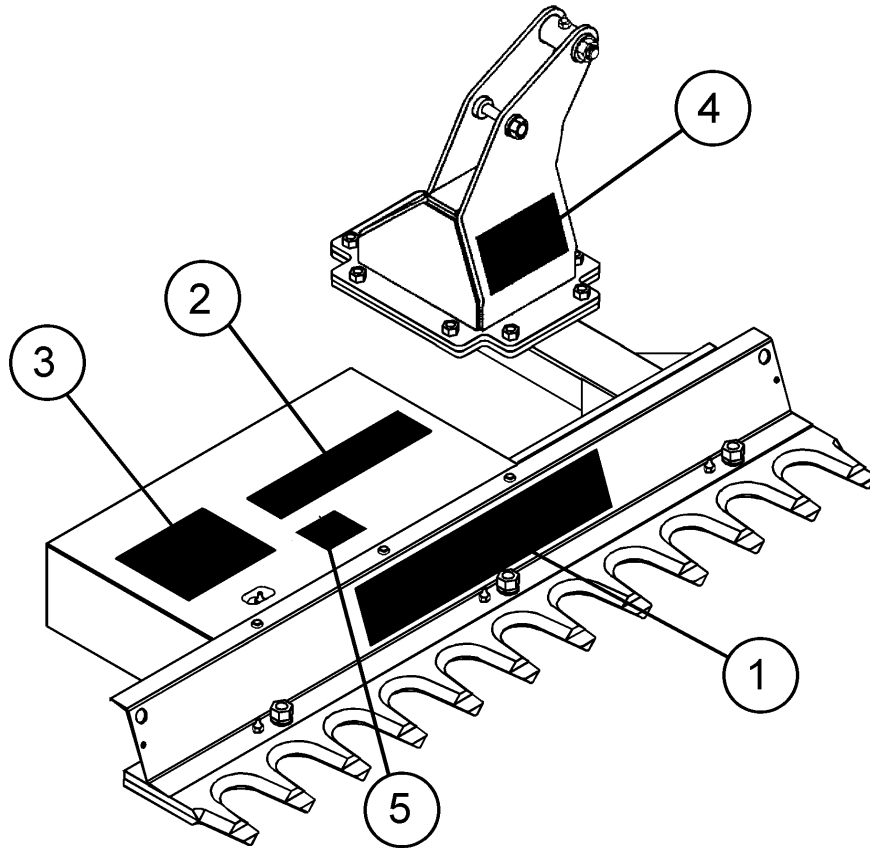

DL-0006

SAFETY

ITEM	PART NO.	QTY.	DESCRIPTION
	<b>02972145</b>	<b>1</b>	<b>TIMBER CAT 5'</b>
	<b>02972146</b>	<b>1</b>	<b>TIMBER CAT 7'</b>
1.	00757139	1	Decal - Alamo TK Logo
2.	02971931	1	Decal - Timber Cat
3.	00757140	1	Decal - Alamo Logo
4.	02973496	2	Keep Away - Amputation
5.	000678	1	Decal - Grease Fitting Inside



# SAFETY

**SAFETY**

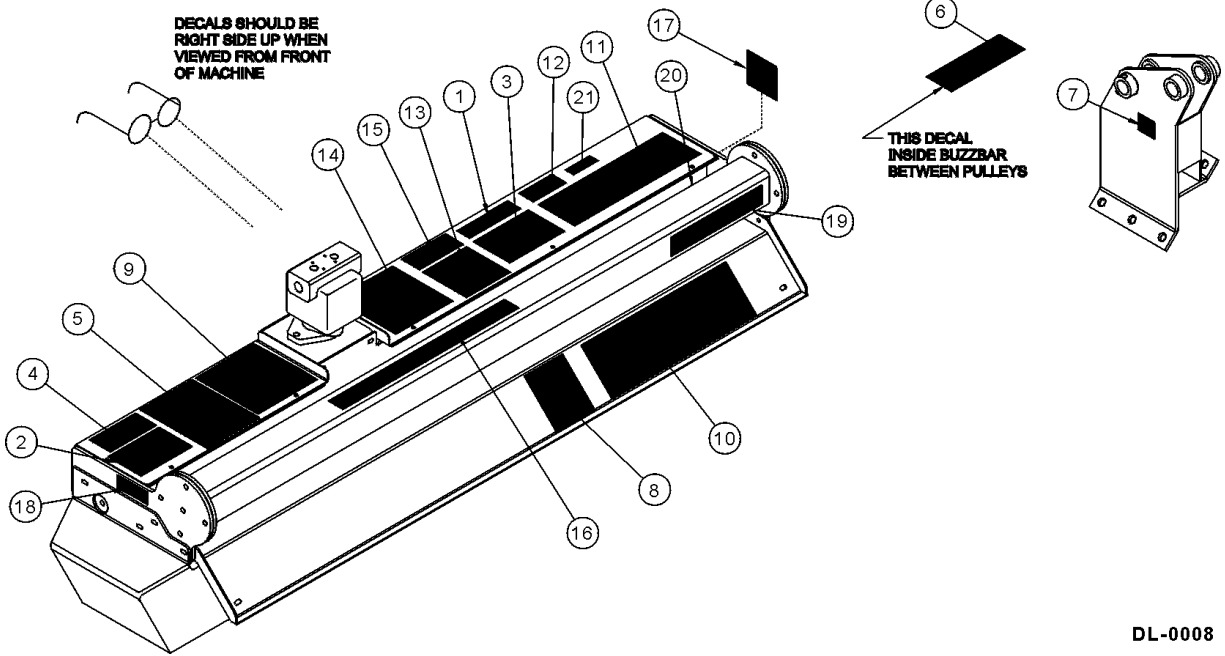

DL-0008

ITEM	PART NO.	QTY.	TYPE	DESCRIPTION
1.	00758194	1	WARNING	V-Belt Pinch
2.	00769736	1	WARNING	Use/Repair Shields
3.	00769737	1	DANGER	Cutting Blades
4.	02925100	1	CAUTION	Genuine Parts
5.	02958241	1	DANGER	Operator Safety
6.	02962764	1	DANGER	Pinch Point
7.	00756004	1	DANGER	Guard Missing
8.	02965262	1	DANGER	Leak/Hose Burst
9.	02967827	1	DANGER	Multi hazard Rotary
10.	00757139	1	LOGO	Alamo By Terrain King
11.	02974998	1	LOGO	Buzzbar
12.	D138	1	DECAL	Blade Rotation
13.	02975158	1	WARNING	Hearing Protection
14.	02975170	1	DANGER	Foot/Leg Contact
15.	02975515	1	WARNING	Disconnect Solenoid
16.	02975516	1	CAUTION	No Hitch Post Here
17.	02975514	1	-----	Pitch Adjust
18.	nfs	1	-----	Serial Plate
19.	1458392	1	REFLECT	Red Reflector
20.	1458393	1	REFLECT	Yellow Reflector
21.	02961134	1	-----	Patent Pending

# SAFETY

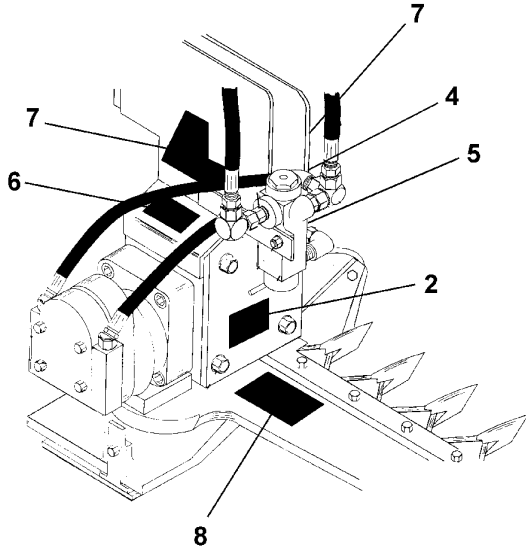

**SICKLE BAR**

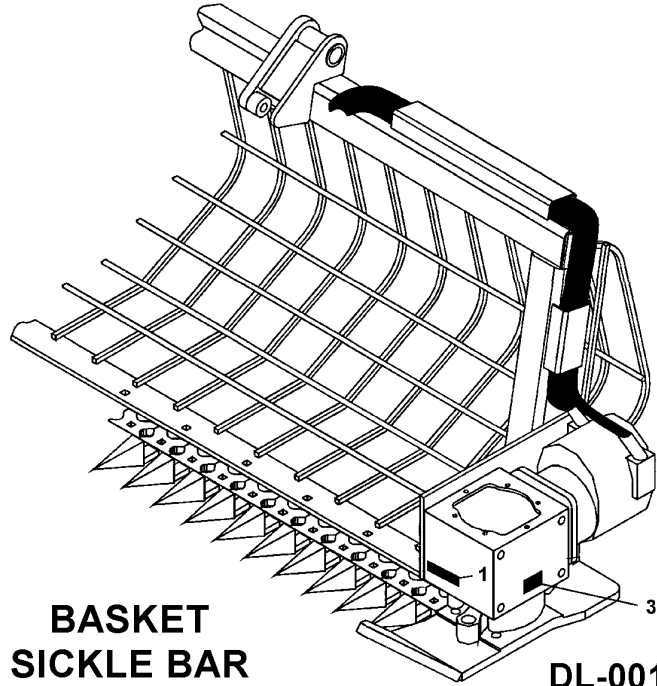

**BASKET  
SICKLE BAR**

**DL-0019**

**SAFETY**

ITEM	PART NO.	QTY.	DESCRIPTION
1.	6659	1	INSTRUCT      General Instructions
2.	02970354	1	INSTRUCT      Knife Service
3.	02965093	1	ATTENTION    Do Not over Speed Engine
4.	00725746	1	PELIGRO       Spanish Translation
5.	02973496	1	DANGER       Amputation Hazard Keep Away
6.	00756059	1	WARNING      Hydraulic Pressure Leak
7.	001650	2	LOGO           Alamo Industrial
8.	02925100	1	INSTRUCT      Use Genuine Alamo Industrial Parts

# SAFETY

**SAFETY**

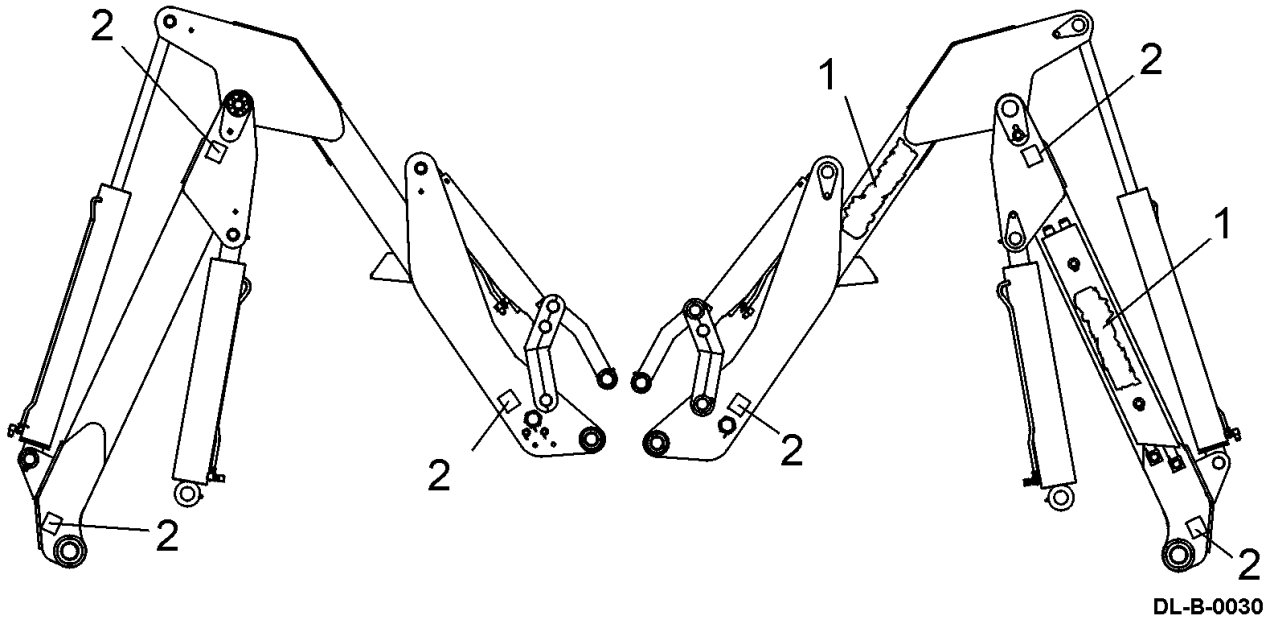

ITEM	PART NO.	QTY.	DESCRIPTION
	02982733	1	18' Boom Assy
	02982736	1	22' Boom Assy
	02982739	1	25' Boom Assy
1.	02983263	2	Name Logo, 18' Axtreme
.	02983264	2	Name Logo, 22' Axtreme
.	02983265	2	Name Logo, 25' Axtreme
2.	02962764	6	Pinch Points

# SAFETY

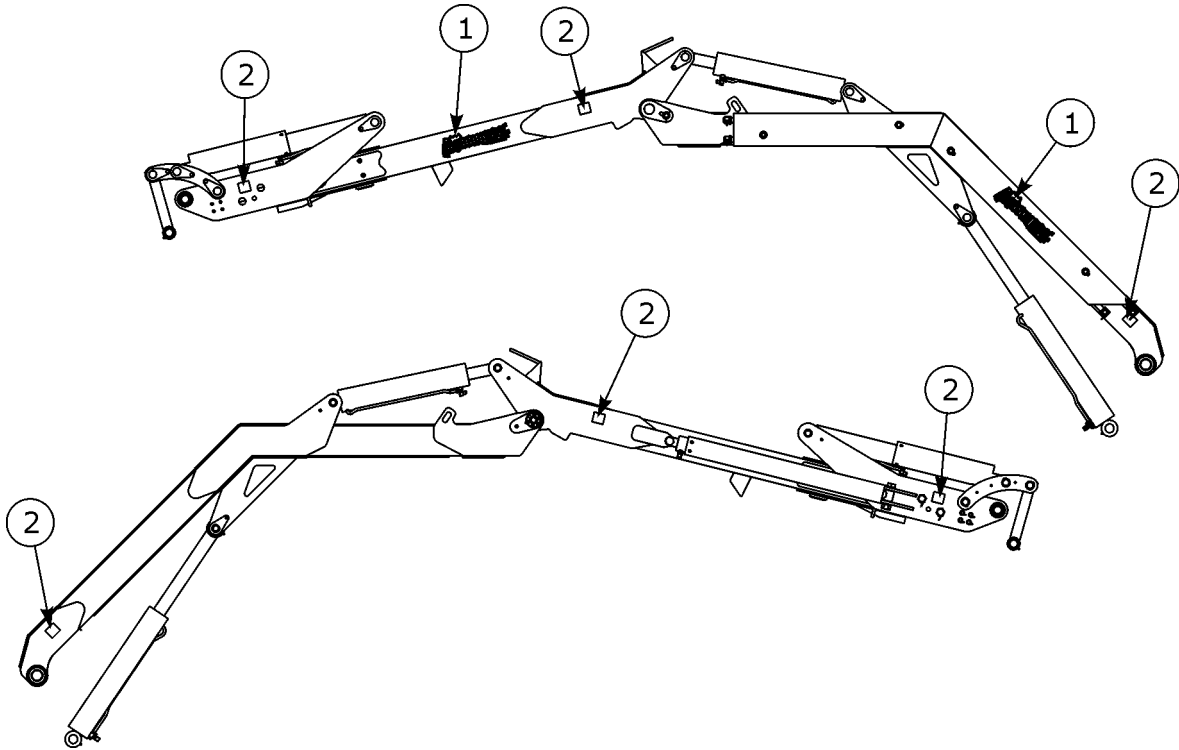

**SAFETY**

ITEM	PART NO.	QTY.	DESCRIPTION
	02984841	1	28'T Boom Assy
1.	02985356	2	Name Logo, 28' Xtreme
2.	02962764	6	Pinch Points

# SAFETY

SAFETY

## Decal Description

Slow Moving Vehicle Decal. Keep SMV reflector clean and visible. DO NOT transport or operate without the SMV.

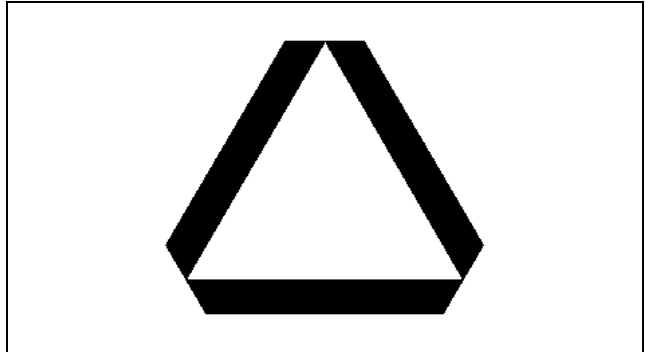

P/N 03200347

Information that Grease Fitting is present and must apply grease.

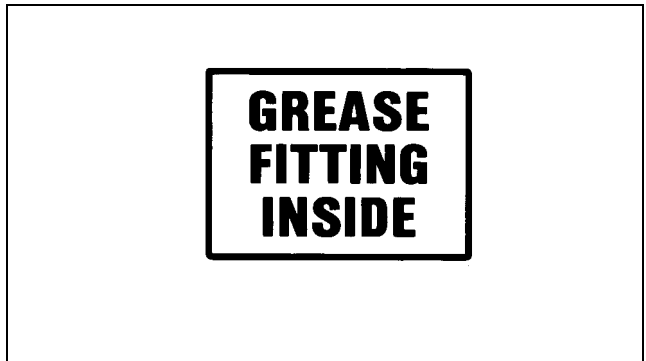

P/N 000678

NAME LOGO



P/N 02971943

Name LOGO - Alamo Industrial



P/N 00757139

# SAFETY

Name LOGO - Alamo Industrial

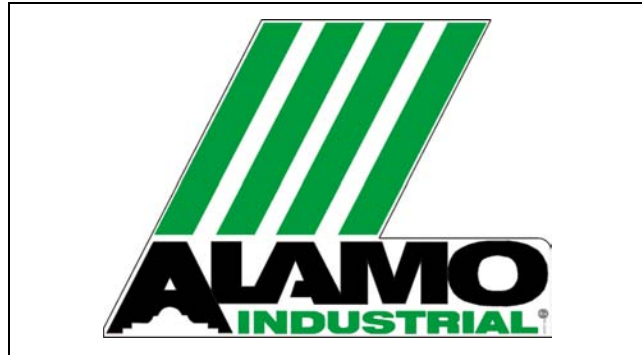

P/N 00757140

**DANGER!** - Multi-Hazard Boom. Take precautions while transporting and operating Boom Unit.

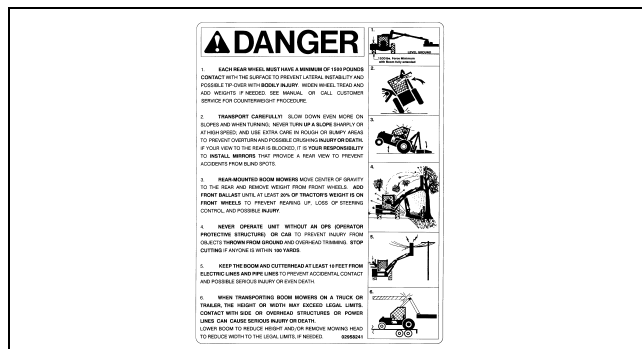

P/N 02958241

**DANGER!** - Keep Away - Thrown Objects. Inspect area before mowing. Do not let rotating blades contact solid objects. Operate only if all Guards - Deflectors are in place. Do not operate with Mower or Wing raised off the ground. Stop mowing if Passerby enter the area. Stay away from rotating blades. Keep hands and feet away from rotating blades. Do not approach mower until all movement has stopped.

P/N 02967668



**IMPORTANT** - Use only Genuine Alamo Industrial replacement parts.



P/N 02925100

**SAFETY**

# SAFETY

DANGER! - Multi Hazard - Failure to follow Safety Messages and Operating Instructions can cause serious bodily injury or even death to Operator and Others in area.



P/N 02967827

DANGER! - Multi Hazard - Failure to follow Safety Messages and Operating Instructions can cause serious bodily injury or even death to Operator and Others in area.



P/N 02967867

Red Reflectors

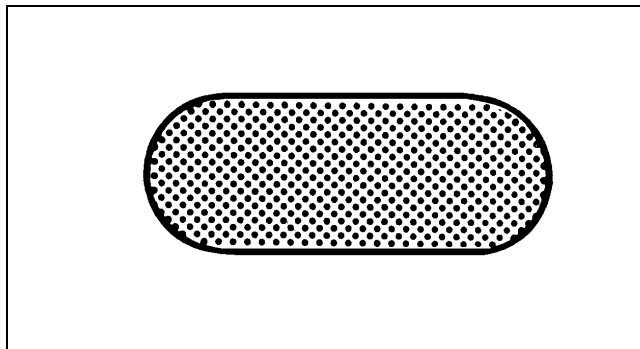

P/N 2738332

Yellow Reflectors

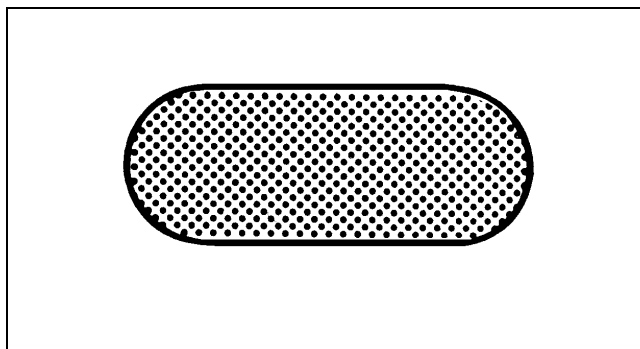

P/N 2738333

SAFETY

# SAFETY

WARNING! Pinch Points

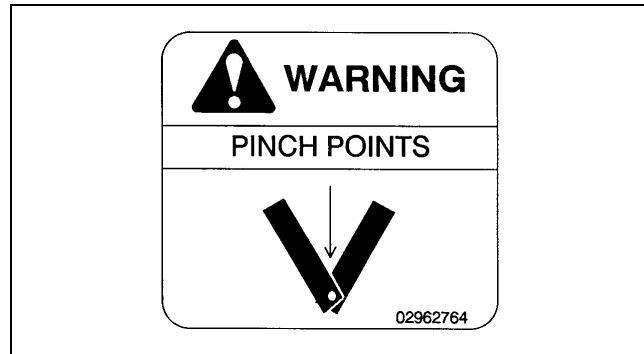

P/N 02962764

WARNING! Do not operate mower with safety shield removed.



P/N TB1011

WARNING! Inspect Rubber Deflector and replace if damaged or noticeably worn. Do not operate mower if deflector is missing or damaged.



P/N 24028

Blade Rotation Clockwise.

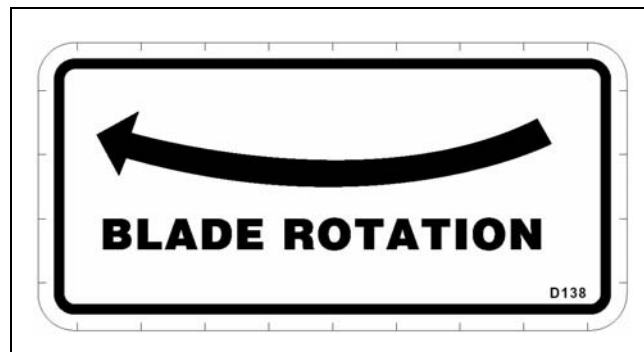

P/N D138

SAFETY



# SAFETY

CAUTION! Do not lubricate with automatic grease gun. Grease with hand gun grease only.

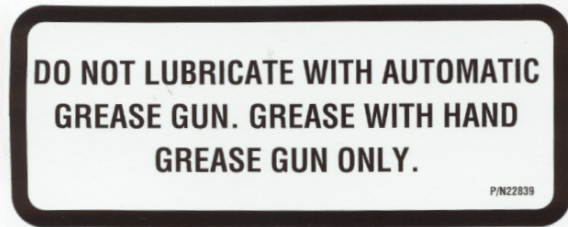

P/N 22839

WARNING! Replace blade bolts and nuts everytime you replace mower blades.



P/N D375

LOGO NAME 18' XTREME ALAMO INDUSTRIAL



P/N 02983263

LOGO NAME 22' XTREME ALAMO INDUSTRIAL



P/N 02983264

SAFETY



# SAFETY

Instructions to properly lubricate and check mower for potential problems prior to operation.

P/N 000108

**OPERATING INSTRUCTIONS**

This Mower will give long satisfactory service with a minimum of upkeep cost if the following procedure is followed:

1. KEEP PROPERLY LUBRICATED
  - a. BEARINGS - Use a lithium-based #2 Bearing Grease such as Shell Alvania #2, Sinclair Litholene, Mobil BRB, Texaco Marfak #2, Standard Stanolith #57, etc.
  - b. GEARBOX - Use SAE EP90 oil.
2. KEEP FASTENERS TIGHTENED
  - a. Normally, if Fasteners loosen after being properly tightened, the Mower is vibrating more than is acceptable and permanent damage can occur rapidly.
  - b. See Bolt Chart for proper tightening torque.
3. KEEP THE MOWER RUNNING SMOOTHLY AND QUIETLY.
  - a. After hitting any obstruction and at the first sign of any unusual vibration or noise, STOP THE MOWER, and do not operate again until the problem is found and corrected. VIBRATION CAN DESTROY THE ENTIRE MOWER IN A SHORT TIME.
  - b. Inspect for broken or missing Knives, Knives restricted from swinging freely, worn Bearings, a bent Shaft, or other conditions causing out-of-balance rotation.
  - c. See Operators Manual for details on causes and correction of vibration of Flail Mowers.

**NOTICE:** Warranty does not cover damage resulting from the failure to observe these reasonable procedures. 000108

WARNING! Do not operate with Belt Shield removed. Finger(s) may be pinched off if get caught between V-Belt and Pulley.



P/N 00758194

Name LOGO - Alamo Industrial



P/N 02979551

NAME DECAL

**FLAIL AXE 48**

P/N 02970887

# SAFETY

**WARNING!** Keep all safety shielding installed, repaired and replaced when damaged so that machine stays in safe condition.

P/N 00756007

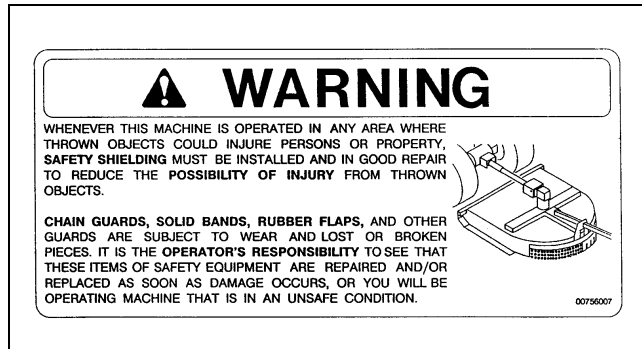

**IMPORTANT** - Use ALAMO Genuine Flail Parts.

P/N 03200432



NAME LOGO



P/N 02971931

**DANGER!** KEEP AWAY! Sickle Blades are guarded only by remote location. Keep all persons away from cutting Blades to prevent amputation of contacted body parts.

P/N 02973496

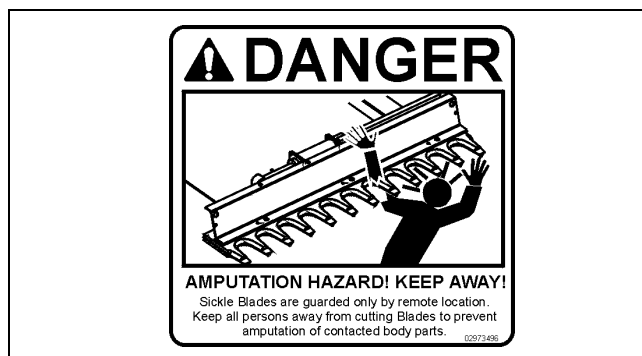

**SAFETY**

# SAFETY

**WARNING!** Maintain shields and deflectors in good condition. Failure to do so may lead to injury or even death.

P/N 00769736



**DANGER!** Keep Away Thrown Objects.

Inspect the area before mowing for potential mower hazards. Remove or avoid all foreign objects such as wire, cable, metal objects, and all other foreign material.

Foreign material can be thrown from the mower and cause serious bodily injury to the operator and passerby.

Do Not let rotating blades contact solid objects like rocks, posts, curbs or guard rails.

Operate only if all Guards, Deflectors are in place and in good condition.

Do Not operate with Mower or Wing raised off the ground.

Stop mowing if Passersby enter the area of thrown objects. (See Operator's Manual)

Stay away from rotating blades. Keep hands and feet away from rotating blades.

Do Not approach mower until all motion has stopped.

P/N 00769737



**DANGER!** Guard Missing, Do Not Operate. If you see this decal, Do Not Operate the mower until the shield has been replaced.

P/N 00756004



# SAFETY

WARNING! Failure to INSPECT and REPAIR or REPLACE Hoses may allow worn Hoses to rupture SUDDENLY and VIOLENTLY with resulting serious BODILY INJURY from SCALDING or FIRE with resulting BURN INJURY or DEATH.

P/N 02965262



LOGO NAME BUZZBAR.



P/N 02974998

WARNING- Hearing Protection is required when working within 100 yards of this machine.



P/N 02975158

DANGER- Keep away rotating blades.

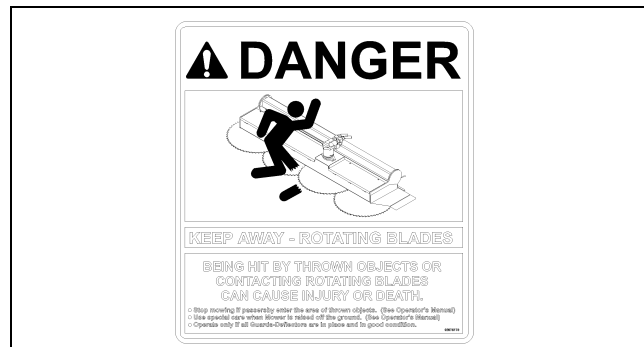

P/N 02975170

**SAFETY**

# SAFETY

WARNING- Disconnect the hydraulic solenoid before performing service work on tractor or mower.

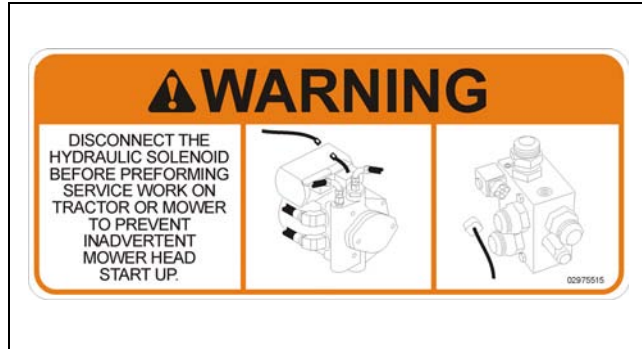

P/N 02975515

INSTRUCT- Do not locate hitch post in this area



P/N 02975516

INSTRUCT- Pitch Adjust

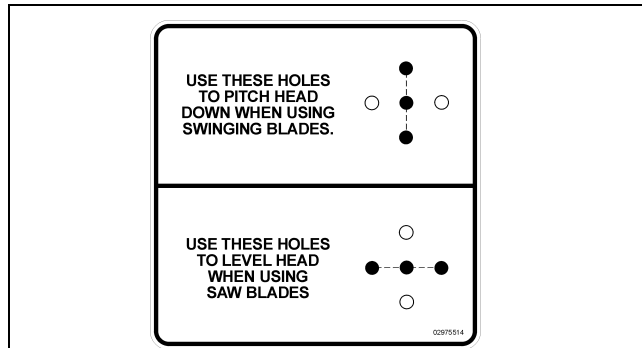

P/N 02975514

Red Reflector. Keep reflectors clean and visible.

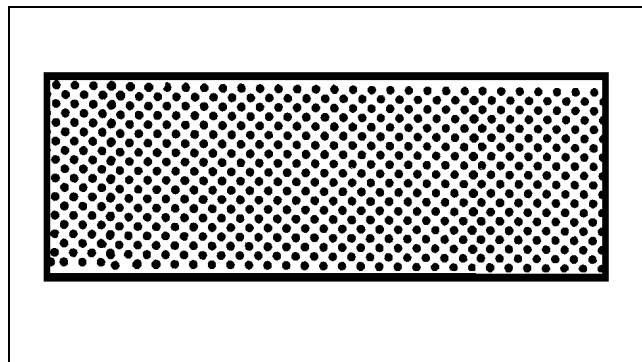

P/N 1458392

SAFETY

# SAFETY

Amber Reflector. Keep reflectors clean and visible.

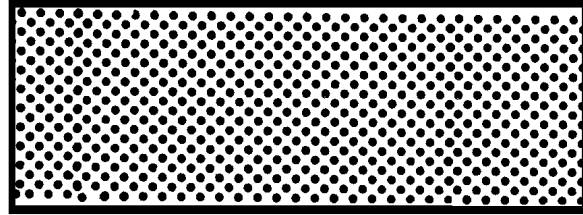

P/N 1458393

**IMPORTANT** - Inspect knife to ledger plate clearance daily. Poor cutting performance will result if proper clearance is not maintained. Refer to operators manual for adjustment.

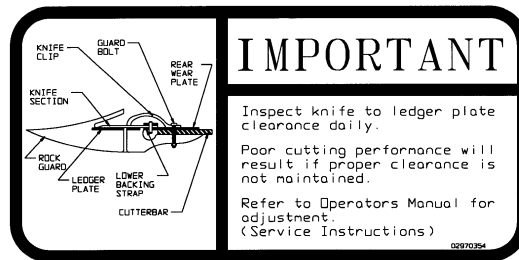

02970354

**INFORMATION** - To prevent premature hydraulic component failure, do not over speed the engine. When using the mower attachment, operate tractor at the engine speed which will deliver 540 PTO RPM on Tachometer. Over speeding the engine and pump when operating the mower will overheat and rapidly ruin the oil which will decrease the life of the hydraulic components.

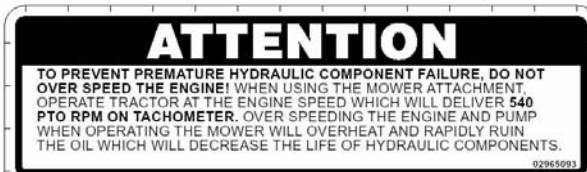

P/N 02965093

**Peligro Translation**, If you do not know how to read English, please find someone who knows how to read English.



P/N 00725746

SAFETY



# SAFETY

WARNING! Never use your hand to check for oil leaks. Always use paper or cardboard.



P/N 00756059

ALAMO NAME LOGO.

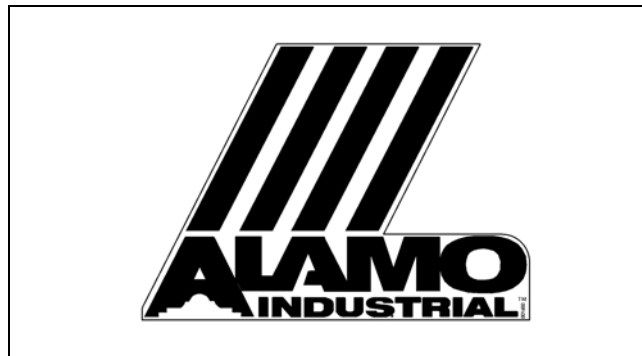

P/N 001650

LOGO NAME 28'T XTREME ALAMO INDUSTRIAL



P/N 02985356

SAFETY

# SAFETY

## **Federal Laws and Regulations**

This section is intended to explain in broad terms the concept and effect of federal laws and regulations concerning employer and employee equipment operators. This section is not intended as a legal interpretation of the law and should not be considered as such.

### **Employer-Employee Operator Regulations**

U.S. Public Law 91-596 (The Williams-Steiger Occupational and Health Act of 1970) OSHA

#### **This Act Seeks:**

“...to assure so far as possible every working man and woman in the nation safe and healthful working conditions and to preserve our human resources...”

#### **DUTIES**

Sec. 5 (a) Each employer-

(1) shall furnish to each of his employees employment and a place of employment which are free from recognized hazards that are causing or are likely to cause death or serious physical harm to his employees;

(2) shall comply with occupational safety and health standards promulgated under this Act.

(b) Each employee shall comply with occupational safety and health standards and all rules, regulations and orders issued pursuant to this Act which are applicable to his own actions and conduct.

#### **OSHA Regulations**

OSHA regulations state in part: “At the time of initial assignment and at least annually thereafter, the employer shall instruct every employee in the safe operation and servicing of all equipment with which the employee is, or will be involved.”

### **Employer Responsibilities:**

To ensure employee safety during Tractor and Implement operation, it is the employer’s responsibility to:

1. Train the employee in the proper and safe operation of the Tractor and Implement.
2. Require that the employee read and fully understand the Tractor and Implement Operator’s manual.
3. Permit only qualified and properly trained employees to operate the Tractor and Implement.
4. Maintain the Tractor and Implement in a safe operational condition and maintain all shields and guards on the equipment.
5. Ensure the Tractor is equipped with a functional ROPS and seat belt and require that the employee operator securely fasten the safety belt and operate with the ROPS in the raised position at all times.
6. Forbid the employee operator to carry additional riders on the Tractor or Implement.
7. Provide the required tools to maintain the Tractor and Implement in a good safe working condition and provide the necessary support devices to secure the equipment safely while performing repairs and service.
8. Require that the employee operator stop operation if bystanders or passersby come within 25 feet.

### **Child Labor Under 16 Years of Age**

Some regulations specify that no one under the age of 16 may operate power machinery. It is your responsibility to know what these regulations are in your own area or situation. (Refer to U.S. Dept. of Labor, Employment Standard Administration, Wage & Home Division, Child Labor Bulletin #102.)



# Safety Manual

*For Operators  
and Mechanics*

# Industrial/ Agricultural Mower

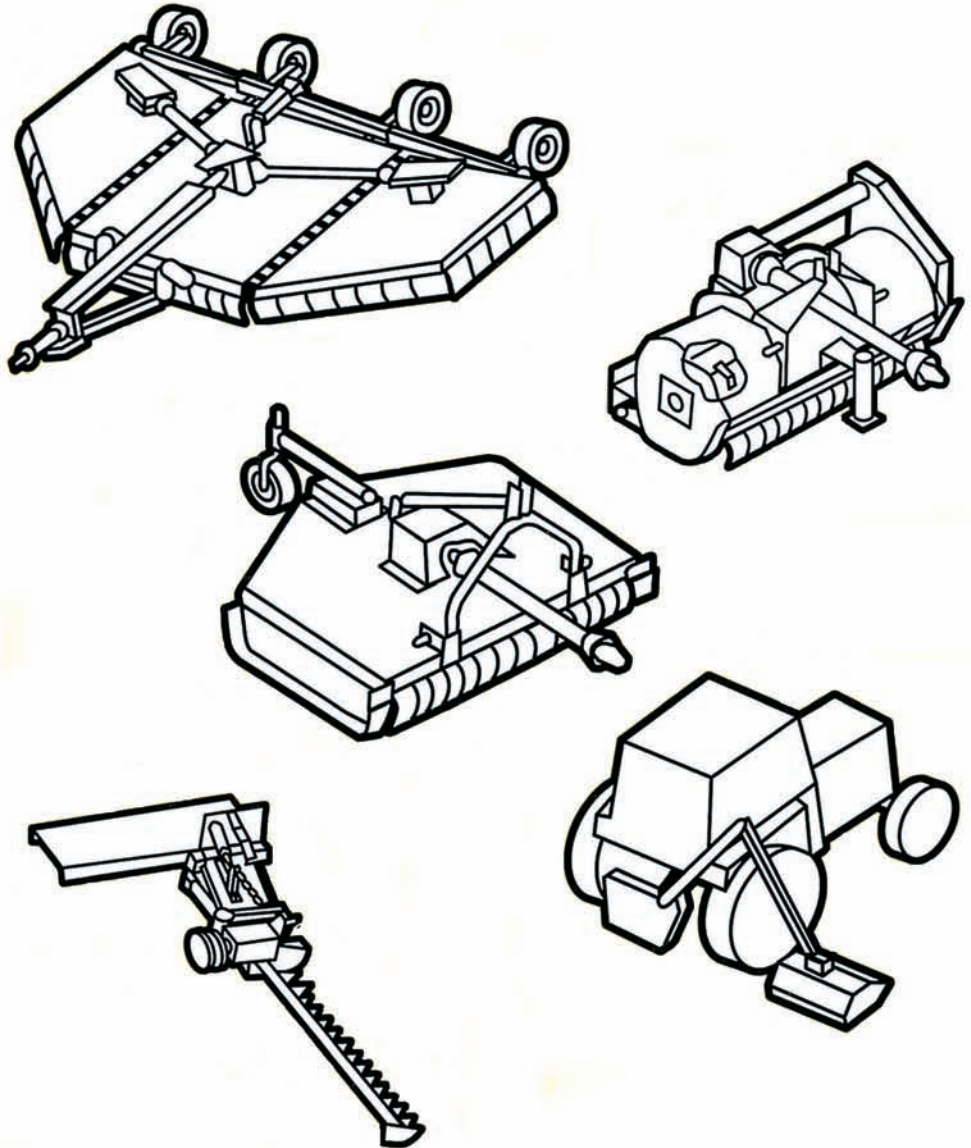

111 E. Wisconsin Avenue • Milwaukee, Wisconsin 53202 U.S.A.  
[www.aem.org](http://www.aem.org)

# **Contents**

---

<b>Acknowledgement</b> .....	2
<b>Forward</b> .....	3
<b>A Word to the User</b> .....	3
<b>Safety Alert Symbol</b> .....	4
<b>Industrial/Agricultural Mower Types</b> .....	4
<b>Be a Responsible Operator</b> .....	5
<b>Safety Management of Hazards and Risks</b> .....	6
<b>Follow a Safety Program</b> .....	11
<b>Safety-Before Operation</b> .....	11
<b>Safety-Starting and Testing</b> .....	13
<b>Safety-During Operation</b> .....	14
<b>Safety-During Shutdown</b> .....	18
<b>Safety-During Maintenance</b> .....	19
<b>One Final Word</b> .....	21

## **Acknowledgement**

---

We wish to acknowledge the contributions of the members of the Association of Equipment Manufacturers to the preparation of this Safety Manual.

**Copyright**  
© 2000 AEM (formerly Equipment Manufacturers Institute). Revised 08.2003. All rights reserved.

## Forward

---

This Safety Manual is intended to point out some of the basic safety situations which may be encountered during the normal operation and maintenance of your machine and to suggest possible ways of dealing with these conditions. This manual is NOT a substitute for the manufacturer's manual(s).

Additional precautions may be necessary, or some instructions may not be applicable, depending on the equipment, attachment devices, and conditions at the worksite or in the service area. The manufacturer has no direct control over machine application, operation, inspection, lubrication, or maintenance. Therefore, it is **YOUR** responsibility to use good safety practices in these areas.

The information provided in this manual supplements the specific information about your machine that is contained in the manufacturer's manual(s). Other information which may affect the safe operation of your machine may be contained on safety signs or in insurance requirements, employer's safety and training programs, safety codes, local, state/provincial and national laws, rules and regulations.

**IMPORTANT:** *If you do not have the manufacturer's manual(s) for your particular machine, get a replacement manual from your employer, equipment dealer, or the manufacturer of your machine. Keep this safety manual and the manufacturer's manual(s) with your machine.*

## A Word to the User

---

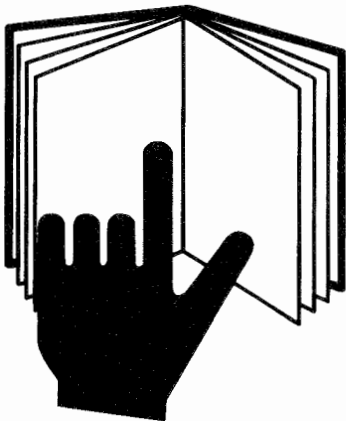

It is your responsibility to read and understand this safety manual and the manufacturer's manual(s) before operating this machine. This safety manual takes you step-by-step through your working day. The safety manual, manufacturer's manual(s), safety signs (decals) and safety precautions must be explained to those users or operators who cannot read the material.

In addition to equipment design and configuration, **HAZARD CONTROL** and **ACCIDENT PREVENTION** are dependent upon the owner's and operator's awareness, concern, prudence, and proper training in the operation, transport, maintenance and storage of equipment.

Remember that **YOU** are the key to safety. Good safety practices not only protect you but also protect the people around you. Study this manual and the manufacturer's manual(s) for your specific machine. Make them a working part of your safety program. Keep in mind that this safety manual is written only for industrial and agricultural mowers.

**Practice all usual and customary safe working precautions and above all – remember safety is up to YOU. Only YOU can prevent serious injury or death from unsafe practices.**

# Safety Alerts

## Symbol

This Safety Alert Symbol means:

**“ATTENTION! BECOME ALERT!  
YOUR SAFETY IS INVOLVED!”**

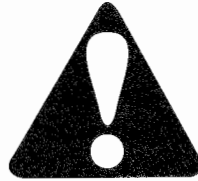

The Safety Alert Symbol identifies important safety messages on equipment, safety signs, in manuals or elsewhere. When you see this symbol, be alert to the possibility of death or personal injury. Follow the instructions in the safety message.

## Signal Words

Signal words are distinctive words that will typically be found on safety decals on this equipment or other equipment on the worksite. These words are intended to alert the viewer to the existence and relative degree of a hazard.



This signal word indicates an imminently hazardous situation which, not avoided, will result in death or serious injury.



This signal word indicates a potentially hazardous situation which, if not avoided, could result in death or serious injury.



This signal word indicates a potentially hazardous situation exists which, if not avoided, may result in minor or moderate injury.

- ACCIDENTS DISABLE AND KILL.
- ACCIDENTS COST.
- ACCIDENTS CAN BE AVOIDED.

# Industrial/Agricultural Mowers

A mower for pasture clipping, crop residue shredding, heavy brush cutting for land clearing, waterways, right-of-ways, road side or highway mowing.

## INDUSTRIAL/AGRICULTURAL MOWER TYPES:

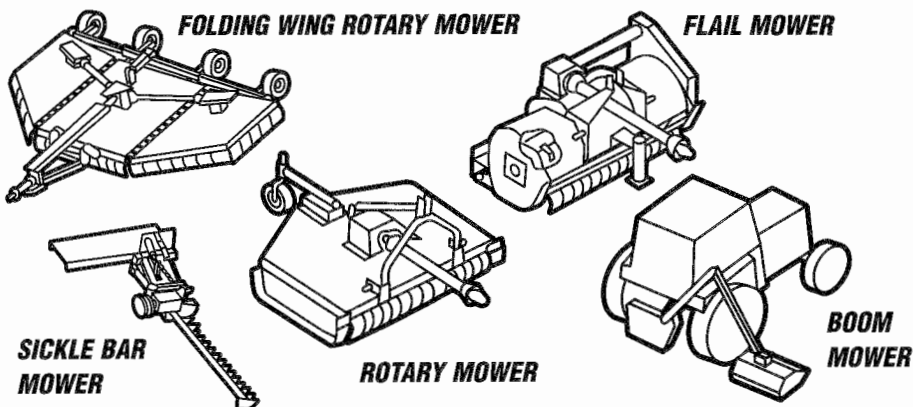



# Be a Responsible Operator



**DON'T**  
Drink & Drive



**DON'T**  
Take  
Drugs & Drive

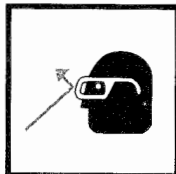
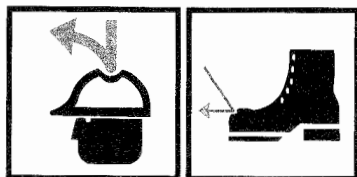

**PROTECT**  
Yourself



**CALL**  
For Assistance

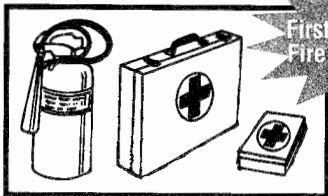

**LOCATE**  
First Aid Kits and  
Fire Extinguisher

For safe operation of your equipment, you must be a responsible operator. A responsible operator must clearly understand the written instructions supplied by the manufacturer, be trained—including actual operation of the equipment and know the safety rules and regulations for the worksite.

Drugs and alcohol will affect an operator's alertness and coordination and therefore affect the operator's ability to operate the equipment safely. An operator should **NEVER** use drugs which affect alertness, judgement and coordination or alcohol while operating motorized equipment, including tractors and mowers. An operator on prescription or over-the-counter medication must consult a medical professional regarding any side effects of the medication that would hinder his or her ability to operate this equipment safely. **NEVER** knowingly allow anyone to operate this equipment when their alertness, judgement or coordination is impaired.

## Protect Yourself

Wear all the protective clothing and personal safety devices issued to you or called for by job conditions.

### You may need:

- Hard hat
- Safety shoes
- Safety glasses with side shields, goggles or face shield
- Heavy gloves
- Hearing protection
- Reflective clothing
- Wet weather gear
- Respirator or filter mask

Wear adequate clothing for the job conditions.

Always know where to get assistance in the case of an emergency. Know where to find and how to use a first aid kit and fire extinguisher/fire suppression system.

**Stay alert. Avoid accidents.  
Don't learn safety the hard way.**

# Safety Management of Hazards and Risks

In addition to equipment design and configuration, **HAZARD CONTROL** and **ACCIDENT PREVENTION** are dependent upon the owner's and operator's awareness, concern, prudence, and proper training in the operation, transport, maintenance and storage of equipment.

**SAFETY MANAGEMENT OF HAZARDS AND RISKS IS ESSENTIAL TO RESPONSIBLE OWNERS AND OPERATORS OF TRACTORS AND MOWERS.**

**REVIEW THE FOLLOWING SAFETY MANAGEMENT OF LISTED HAZARDS AND RISKS:**

## ***Thrown Object Hazard***

**POSSIBLE THROWN OBJECT INJURY RISKS EXIST FOR MOWER OPERATORS AND BYSTANDERS DURING MOWER OPERATIONS FROM THE FOLLOWING:**

**DISCHARGED OBJECTS (ROCKS, DEBRIS, BROKEN MOWER BLADES, BLADE BOLTS, CABLES, CHAINS, WIRE, ETC....) FROM THE MOWER.**

## ***Equipment Protective Devices And Recommended Safety Practices***

The mower deck and protective devices cannot prevent all objects or debris from escaping the blade enclosure area in every mowing condition. It is possible for objects to escape and travel several hundred (300) feet.

### **RECOMMENDED SAFETY PRACTICES**

Read manufacturer's operator manual(s) for recommended operating safety practices. Explain the practices to users or operators who cannot read.

**TO HELP PREVENT SERIOUS INJURY OR DEATH FROM OBJECTS STRIKING OPERATOR OR OTHER PERSONS DO THE FOLLOWING:**

#### **BYSTANDERS SAFETY**

- Keep bystanders several hundred (300) feet from mowing area.

#### **EQUIPMENT PROTECTIVE DEVICES SAFETY**

**To contain, deflect or reduce thrown objects from blade enclosure area:**

- Keep chain, flexible or solid deflector shields in place on the front and rear of the mower deck and in good repair.
- Do not operate with damaged or missing thrown object shielding.

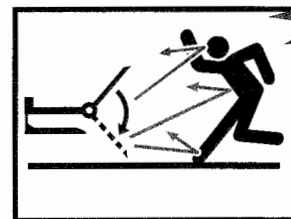
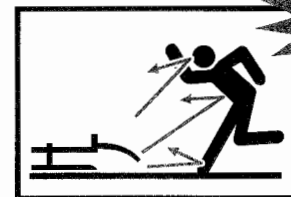
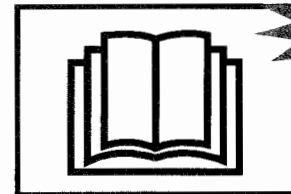
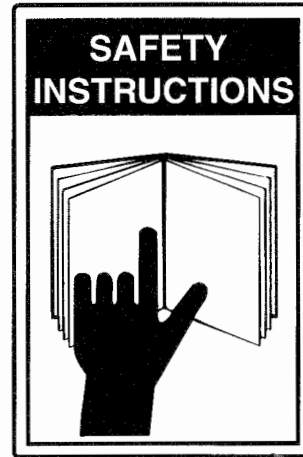

**THROWN Object Hazard**

**READ Manuals**

**KEEP Bystanders Away**

**THROWN Object Hazard**



**USE ROPS  
Enclosed Cabs  
or Protective  
Enclosures**

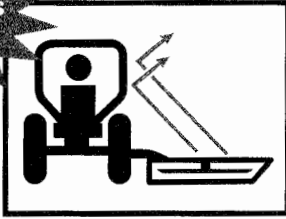

**USE Proper  
PTO Speed**

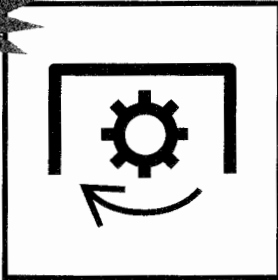

**MAINTAIN  
Equipment**

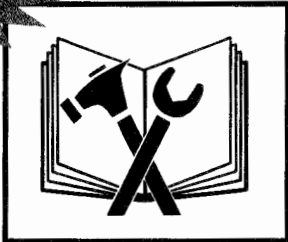

## **OPERATOR SAFETY**

Raised wings, side mount and boom type mower operations may reduce the mower's thrown object shielding effectiveness for the mower operator's protection.

**Do the following to increase operator protection from thrown objects during these mowing operations:**

- Use enclosed ROPS cabs, special protective enclosures, screens or other operator shielding devices when performing these operations.

### **EXCEEDING RECOMMENDED PTO SPEEDS**

Do not exceed manufacturer's recommended PTO speeds.

**Excessive PTO speeds may cause:**

- Blade failures
- Higher velocity objects escaping or broken blades being thrown from mower blade enclosures.
- Potential 540 rpm driveline failures operating at 750 to 1000 rpm speeds.

### **OTHER SAFETY PRACTICES:**

- Never operate mower with broken, bent, missing, or severely worn blades.
- Before mowing, remove debris and foreign objects to avoid them being picked up and thrown out by the mower.
- \* Do not operate the mower in transport or in raised wing positions.

## **RECOMMENDED MAINTENANCE PRACTICES**

Read manufacturer's operator manual(s) inspection and maintenance instructions for chain guards, flexible or solid deflector shielding:

- Replace worn or damaged guards and other shielding before mowing.
- Use only manufacturer's replacement guards and shielding. Other guarding or shielding sources may not fit or have inadequate materials to meet the strength requirements of the equipment.
- Replace worn or damaged decals and warning instructions.
- Explain the inspection and maintenance instructions to those users or operators who cannot read.

# Rotating Blades and Driveline Hazards and Risks

A POSSIBLE INJURY RISK EXISTS TO MOWER OPERATORS AND BYSTANDERS DURING MOWING OPERATIONS FROM THE FOLLOWING:

- BODY CONTACT WITH ROTATING BLADES.
- BODY ENTANGLEMENT WITH ROTATING DRIVELINES AND PARTS.

## Equipment Protective Devices and Recommended Safety Practices

### RECOMMENDED SAFETY PRACTICES

Read manufacturer's operator manual(s) for recommended operating safety practices. Explain the practices to those users or operators who cannot read. To help prevent serious injury or death from moving blade contact, driveline or parts entanglement of operators or other persons do the following:

#### BYSTANDERS SAFETY

- Do not operate near bystanders.
- Keep other persons several hundred (300) feet from the mowing area.

#### OPERATOR SAFETY PRACTICES

- Do not allow riders on tractor or mower. Securely fasten seat belt when mowing.
- Use proper equipment shutdown practice before servicing, adjusting, cleaning or unclogging the mower.
- Keep clear of rotating blades, parts, and drivelines.
- Never start tractor engine while standing beside equipment.
- Only start tractor engine while sitting in operator's seat with seat belt fastened.

#### RECOMMENDED GUARDS, DRIVELINE GUARDS AND SHIELDING SAFETY PRACTICES

- Keep guards, driveline and other shielding in place and in good repair.
- Do not operate mower with missing or damaged guards, driveline guards or other shielding.

#### RECOMMENDED MAINTENANCE PRACTICES

Read manufacturer's operator manual(s) inspection and maintenance instructions for guards, driveline guards and other shielding:

- Replace worn or damaged guards, driveline guards and other shielding before mowing.
- Use only manufacturer's replacement guards and shielding. Other guarding or shielding sources may not fit or have inadequate materials to meet the strength requirements of the equipment.
- Replace worn or damaged decals and warning instructions.
- Explain the inspection and maintenance instructions to those users or operators who cannot read.

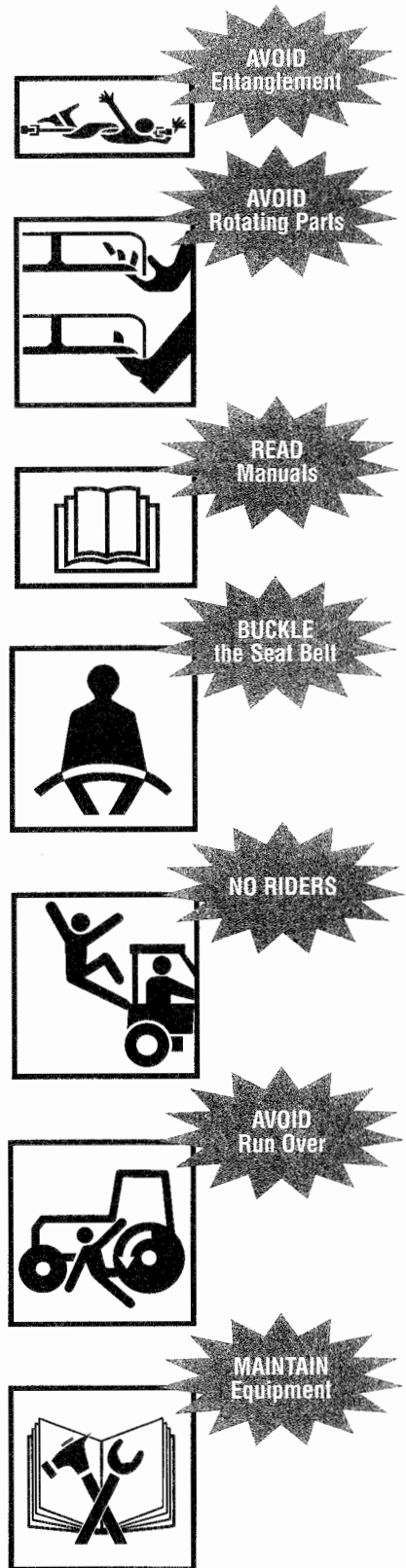

## ***Tractor and Mower Rollover or Overturn Hazards and Risks***

A POSSIBLE ROLLOVER OR OVERTURN INJURY RISK EXISTS TO MOWER OPERATORS DURING MOWING OPERATIONS FROM THE FOLLOWING:

- ROUGH TERRAIN, STEEP SLOPES, HOLES, BUMPS, RUTS, ROCKS, STUMPS OR OTHER OBSTRUCTIONS THAT COULD OVERTURN TRACTOR AND MOWER.
- EXCESSIVE GROUND SPEEDS FOR THESE TERRAIN CONDITIONS.

### ***Equipment Protective Devices and Recommended Safety Practices***

When possible remove stumps, stones, etc.. or mark them and other obstructions clearly to avoid upsets, breakdowns, and dangerous driving conditions. Use extreme care to maintain control over the equipment when operating in these terrain conditions.

#### **RECOMMENDED-TRACTOR ROPS**

A tractor equipped with ROPS or enclosed ROPS cab and seat belt for operator safety is essential for additional operator protection when operating mower in these terrain conditions.

#### **RECOMMENDED-TRACTOR STABILITY ADJUSTMENTS**

Read the tractor operator's manual for adjustments to increase tractor stability:

- Adding front and rear wheel weights or ballast.
- Adjusting wheel spacing to maximum width .
- Adding off-side counter ballast to side-mounted and boom mowers.
- Explain adjustments to those users or operators who cannot read.

### **RECOMMENDED SAFETY PRACTICES**

Read manufacturer's operator manual(s) for recommended operating safety practices. Explain the practices to those users or operators who cannot read. **To help prevent serious injury or death to the operator from tractor and mower overturns, do the following:**

- Securely fasten seat belt when mowing with ROPS equipped tractors.
- Avoid excessive ground speed for terrain conditions.
- Avoid sudden starts, stops and turns when operating up, down or across slopes.
- Avoid slippery ground conditions.
- Make wide and gradual turns.
- Plan to mow down hill on steep slopes to avoid overturning.

## ***Falling Mower or Parts Crushing Hazards and Risks***

A POSSIBLE CRUSHING INJURY RISK EXISTS FOR MOWER OPERATORS AND OTHERS DURING MOWING OPERATIONS FROM THE FOLLOWING:

- FALLING MOWER OR EQUIPMENT FROM HYDRAULIC SYSTEM FAILURE.
- FAILURE TO SECURELY SUPPORT, BLOCK-UP OR LOCK-UP LIFTED MOWER OR EQUIPMENT PARTS.

**AVOID  
Rollover**

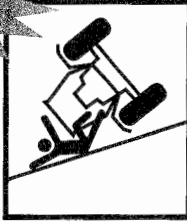

**USE  
Tractor ROPS**



**READ  
Manuals**

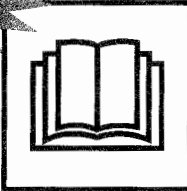

**ADD  
Ballast**



**WIDEN  
Wheel Spacing  
and ADD Off-Side  
Ballast**



**BUCKLE  
the Seat Belt**



**AVOID  
CRUSHING  
Lock-Up Wing**



## Equipment Protective Devices and Recommended Safety Practices

Read manufacturer's operator manual(s) for recommended operating safety practices. Explain the practices to those users or operators who cannot read. **To help prevent serious injury or death to operators and other from alling mower or equipment parts, do the following:**

### **RECOMMENDED SAFETY PRACTICES**

Before working near or underneath lifted mower or equipment parts:

- Use proper equipment shutdown practices before servicing, adjusting, cleaning or unclogging the mower.
- Securely support or block-up raised mower or equipment parts.
- Securely support, block-up or lock-up wings with locking devices on wing type mowers or lower mower or equipment parts to the ground.
- Use transport locks when transporting mower on public roads.

## High Pressure Hydraulic Fluid Leak Hazards and Risks

**A POSSIBLE HIGH PRESSURE FLUID SKIN INJECTION INJURY AND GANGRENE RISK EXISTS FOR MOWER OPERATORS AND OTHERS FROM HIGH PRESSURE HYDRAULIC OR DIESEL OIL LEAK INJECTION INTO THE SKIN.**

**TO AVOID GANGRENE, INJECTED FLUID MUST BE SURGICALLY REMOVED WITHIN A FEW HOURS BY A DOCTOR FAMILIAR WITH THIS TYPE OF INJURY.**

### **RECOMMENDED SAFETY PRACTICES**

Read manufacturer's operator manual(s) for recommended operating safety practices. Explain the practices to those users or operators who cannot read. High pressure fluid pinhole leaks can be almost invisible.

**To help prevent serious injury or death, do the following:**

- Search for leaks with cardboard or wood.
- Do not use hands to check for leaks.
- Relieve system pressure before disconnecting lines.
- Before applying system pressure:
  - Check for damaged lines, pipes, and hoses.
  - Check to insure tight connections.
- Before operating pressurized systems:
  - Purge air from system.
  - Refer to the manufacturer's operator manual(s) for instructions.
  - Explain the procedures to those users or operators who cannot read.

## Tractor Refueling Hazards and Risks

**To avoid serious injury or death from fire during refueling:**

- Shut off engine and ignition.
- Never fill fuel tank near open flames.
- Never smoke while refueling.
- Avoid static electricity sparks by grounding fuel nozzle against tank filler neck.
- Avoid overfilling tank or spilling fuel.
- Clean up any spilled fuel immediately.
- Always replace fuel cap.

**To avoid serious injury or death from engine exhaust fumes:**

- Adequately ventilate enclosed spaces before starting the engine.

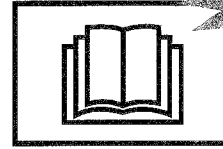

**READ  
Manuals**

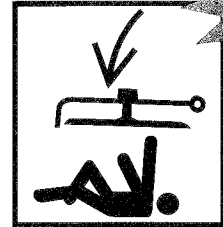

**AVOID  
CRUSHING  
Block-Up or  
Securely Support  
Mower**

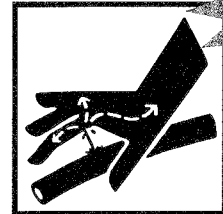

**HIGH  
PRESSURE FLUID  
Can Inject  
into the Body**



**READ  
Manuals**

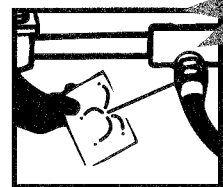

**AVOID  
INJECTION  
Use Cardboard  
Not Hands**



**AVOID  
Fires and  
Explosions**

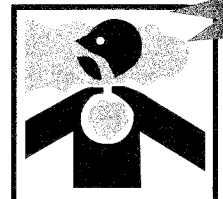

**AVOID  
Exhaust Fumes**

## Follow A Safety Program

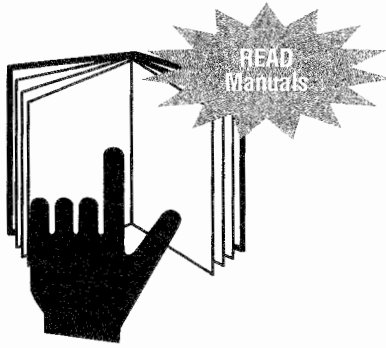

**SAFETY IS IMPORTANT TO RESPONSIBLE OWNERS AND OPERATORS OF TRACTORS AND MOWERS. DO THE FOLLOWING FOR YOUR SAFE MOWING OPERATION:**

### BE A QUALIFIED OPERATOR BY:

- Reading, understanding and obeying the manufacturer's written instructions in operator manual(s) and safety signs on mower and tractor.
- Receiving operational training with mower and tractor.
- Asking your equipment dealer or supervisor to explain things you do not understand.
- Explaining the written instructions in the operator manual(s) and safety signs (decals) on the mower and tractor to those users or operators who cannot read.

## Safety Before Operation

### Know Job Site Safety Rules And Regulations

Ask your supervisor about equipment operation safety rules you will be expected to obey.

#### Some basic rules for your's and others' safety:

- A ROPS and seat belt equipped tractor is required for operator protection during mowing operations.
- Know mower and tractor operating capacity and characteristics.
- Never alter or remove safety equipment.
- Never allow children or unqualified persons to operate mower or tractor.
- Never allow riders on mower or tractor.
- Keep others away from mowing operation.
- Use proper equipment shutdown practice before dismounting tractor.
- Allow all moving parts to stop before making equipment inspections, repairs, or adjustments.
- Securely support or block-up mower before working beneath mower or lifted components.
- Wear personal protective clothing and safety devices issued to you or recommended by the equipment manufacturer.



### Know Tractor And Mower Controls

Know the following about your tractor and mower:

- Function, purpose and use of controls.
- Safe operating speeds.
- Safe slope and uneven terrain capabilities.
- Braking and steering characteristics.
- Tractor and mower operating clearances.
- How to stop equipment quickly in an emergency.

## **Use All Available Equipment Safety Devices**

To help keep you and others around you safe:

- Make certain manufacturer's recommended guards, shields and safety signs are installed on equipment and in good condition.
- Keep all protective devices in place and securely fastened.
- **NEVER** operate your equipment with missing, disconnected or damaged safety devices.
- Use ballast and weight required for equipment operational stability.

## **Check The Mower And Tractor Equipment**

**Before beginning your work day:**

- Check for loose, broken, missing or damaged tractor and mower parts.
- Repair or replace these parts when needed.
- Check for proper tractor and mower attachments.
- Check for proper tractor and mower PTO rpm rating match.
- Check mower blades condition. Sharpen or replace per manufacturer's recommendation. Blade modifications, such as welding or hard surfacing cutting edges by welding or straightening bent blades, can reduce blade strength and adversely affect blade properties and safety.
- Check that all guards and shields are in place and that all equipment is in good operating condition. This includes PTO driveline, gearbox and implement guards and shields that are used for operator protection.
- Check for properly latched driveline yoke end locking devices.
- Check for damaged or leaky tractor and mower hydraulic systems.
- Check and read safety signs and warning instructions.
- Explain the safety signs and warning instructions to those users or operators who cannot read.

## **Check The Work Area**

**Inspect, identify and avoid hazardous conditions in the work area:**

- Rough terrain, drop-offs, ditches, potholes steep slopes, stumps, standing water, mud soft soil, slippery conditions, debris and foreign objects.
- Inspect mowing area and remove or mark all foreign objects and debris to be avoided by mower.

**Analyze mowing area to determine:**

- Best and safest mowing procedure.
- Material type and height to be mowed.
- Operating terrain conditions.
- Using forward travel mowing pattern when possible.

## **Look Out For The Safety of Others**

**Before starting equipment:**

- Walk around the equipment.
- Check for anyone under, on or near the equipment.
- Clear everyone from these areas.
- Sound a warning.



**USE ROPS  
and Seatbelt**

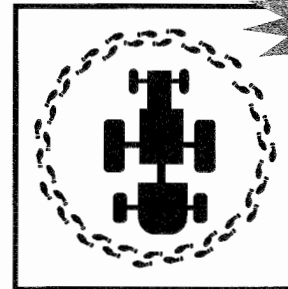

**WALK AROUND  
Inspection**

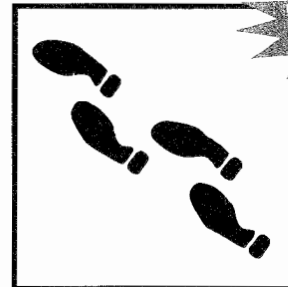

**WALK AROUND  
the Worksite**

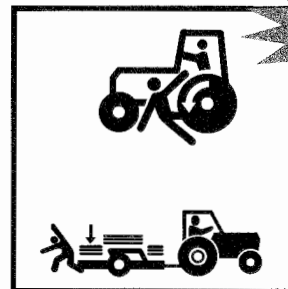

**LOOK OUT  
For Others**

# Safety – Starting & Testing

USE Three Point Contact



USE ROPS and Seatbelt



USE Proper PTO speed

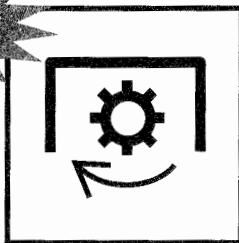

## Mounting Tractor Safety

### Before mounting:

- Clean shoes and wipe hands.

### During mounting and dismounting:

- Use handholds and step plates.
- Never grab steering wheels or controls for handholds.
- Never mount or dismount from a moving tractor.

## Tractor And Mower Controls Safety Test

### Before starting:

- Fasten and adjust seat belt on your ROPS-equipped tractor.
- Check parking brake for engagement.
- Check PTO disengagement.
- Check all controls for Neutral or Park position.
- Warn others in area before starting tractor.
- Follow tractor manufacturer's recommended starting procedures.

### After starting:

- Check all instruments, gauges and indicator lights for normal operation.
- Check all tractor controls, steering and brakes for proper function.
- Repair improperly functioning tractor before using.
- Raise and lower mower for driveline bottoming out or engagement problems.
- Check your equipment for excessive vibration and unusual noises.
- Use proper equipment shutdown practices before inspecting equipment.

## Power Takeoff System And Mower Safety

Tractors with dual-speed (540 or 1000 rpm) shiftable PTO systems.

To avoid serious injury or death from failed parts due to mower over speed:

- Be sure to position PTO selector to mower's rated PTO rpm speed.

Tractors with transmission-driven PTO systems.

A rotary mower will have a significant flywheel effect which may continue to propel a tractor with a transmission-driven PTO system.

The tractor should be equipped and operated as follows:

- Install an over-running clutch.
- Give yourself sufficient maneuvering room and time by anticipating turns, stops and speed reductions.



# Safety – During Operation

## Hitching Mower To Tractor Safety

### Three-point hitch-mounted mower safety:

- Refer to mower and tractor manufacturers' manuals.
- Place tractor's hydraulic power lift (rockshaft) selector lever in down position to avoid unexpected movement.
- Explain the hitching procedures to those users or operators who cannot read.

### Pull-type hitch-mounted mower safety:

- Refer to mower and tractor manufacturers' manuals.
- Attach only to drawbar hitch.
- Do not attach to tractor's rear axle or three-point hitch arms.
- Adjust tractor drawbar length for 540 or 1000 rpm PTO operation.

## Make The Right Start In Mower Safety

Mow only in daylight or good artificial light conditions.

### To avoid serious injury or death from mower thrown objects or blade contact:

- Keep chain shields, flexible or solid deflector shields or discharge chutes in place and in good repair.
- Keep everyone several hundred (300) feet from mowing operation.
- Never direct mower discharge toward anyone.
- Keep hands, feet and other body parts away from rotating parts, blades and discharge openings.
- Do not operate mower in transport position.

### Mower PTO drive engagement:

- Raise mower to maximum cutting height.
- Engage PTO at low engine rpm.
- Increase engine rpm to mower rated rpm PTO speed.
- Lower mower to desired cutting height.
- Stop and shut down immediately if the mower strikes an obstruction.
- Inspect and repair any mower damage before resuming mowing.
- Do not operate mower with severe vibrations or with unusual noise.

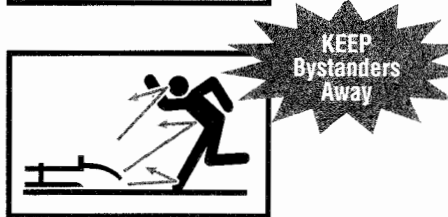
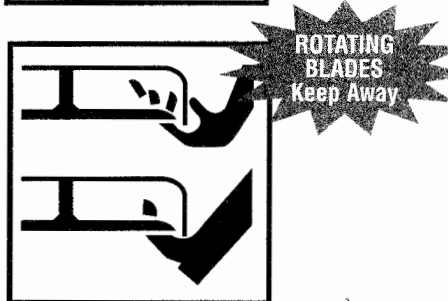
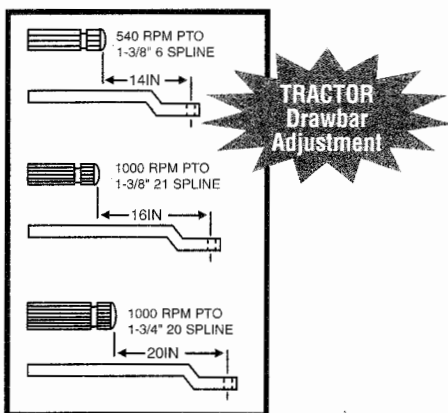
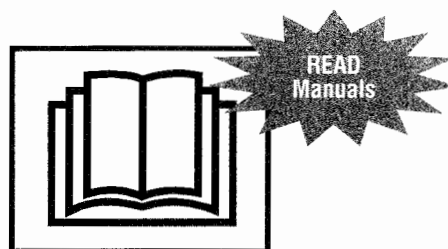



LOOK OUT  
For Others

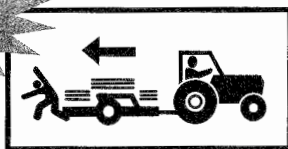

## Mowing In Reverse Safety

Avoid mowing in reverse direction when possible.

Do the following when mowing in reverse direction:

- Check for any persons behind mower before reversing direction.
- Use extreme care when reverse direction mowing.
- Maintain rotary mower front and rear safety shields and flail front shields and rear rollers.

MAINTAIN  
FLAIL  
Rear Roller

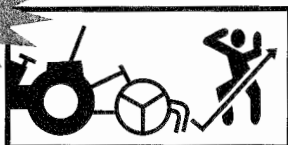

## Mowing Ground Speed

Proper ground speed depends on terrain conditions and grass type, density and height to be cut:

- Normal ground speed range is 2 to 5 mph.
- Slower ground speed for mowing tall, dense grass.
- Faster ground speed for mowing medium height, thin grass and under smooth terrain conditions.
- Use slower ground speed for mowing in rough, sloping or unfamiliar terrain.

USE PROPER  
Ground Speeds

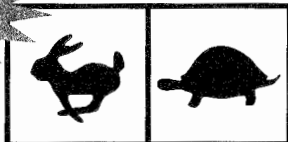

STOP BLADE  
Before  
Unclogging



## Extremely tall grass mowing

- You may need to mow extremely tall grass twice.

First mowing pass:

- Cut grass higher (10-15 inches) to avoid hidden objects.

Second mowing pass:

- Remove debris and objects.
- Cut grass at desired height and 90 degree to the first mowing pass when possible.
- Use proper equipment shutdown practice for your safety before dismounting tractor.

PROVIDE  
Adequate  
Clearance for  
Mower Swing

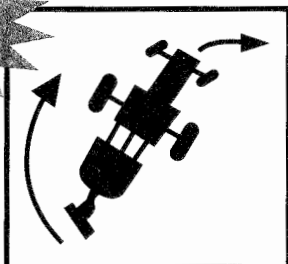

## Watch equipment clearances

Three-point hitch and side mounted mowers have a larger turning arc than pull-type mowers. Allow sufficient clearance for safe turning.

NEVER STAND  
On Mower  
Keep Away

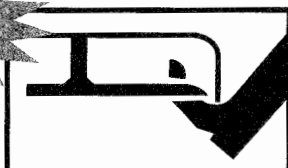

## Under Mount Mower Safety

When mowing with an under mount mower:

- Keep removable discharge chute in place and over discharge opening.
- Never stand on an operating mower housing.
- Distribute grass clipping with discharge chute facing mowed area.
- Use proper equipment shutdown practice before clearing clogged mower or discharge chute.

KEEP CHUTE  
In Place

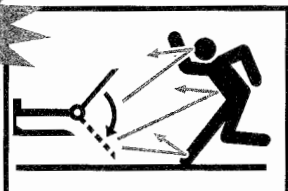

## ***Wing Or Boom Type Mower Overhead Obstruction Hazards and Risks***

Check for overhead obstructions with raised wings or boom-type mowers to avoid serious injury or death by contact with:

- Electrical power lines.
- Low tree limbs.
- Other overhead obstructions.

## ***Wing And Side Mount Mowers Safety***

When mowing with wing and side-mount mowers:

Raised wing positions reduces shielding protection and increases the thrown object and blade contact hazard risks.

To avoid serious injury or death by thrown objects or blade contact from raising and lowering wings during mowing operations:

- Do not mow with bystanders in mowing area.
- Be sure no one is near mower while raising or lowering wings.
- Keep the exposed rotating wing blade time to a practical minimum during a raised wing mowing operations.
- Stop mowing if persons enter into mowing area.
- Only raise wing to clear objects in the mowing path or to match ground slope.
- Disengage wing drive for extended periods of mowing with raised wings.
- Lower raised wing to ground after clearing object or ground slope conditions.
- Allow all mower blades to stop rotating before raising wing sections during other operations.

## ***Ditch Bank Mowing Safety***

Use extreme care when mowing ditch banks. Watch for washouts, eroded areas and mowing obstructions along the ditch banks. Hitting obstructions with side-mount or boom mowers may swerve the tractor's front end toward the ditch.

Raised wing and boom-type mower ditch bank operations may reduce the mower's thrown object shielding effectiveness for the mower operator's protection.

To increase operator protection from thrown objects during ditch bank operations:

- Use enclosed ROPS cabs, special protective enclosures and other operator shielding when performing these operations.
- Inspect mowing area and remove or mark all foreign objects and debris to be avoided by mower.



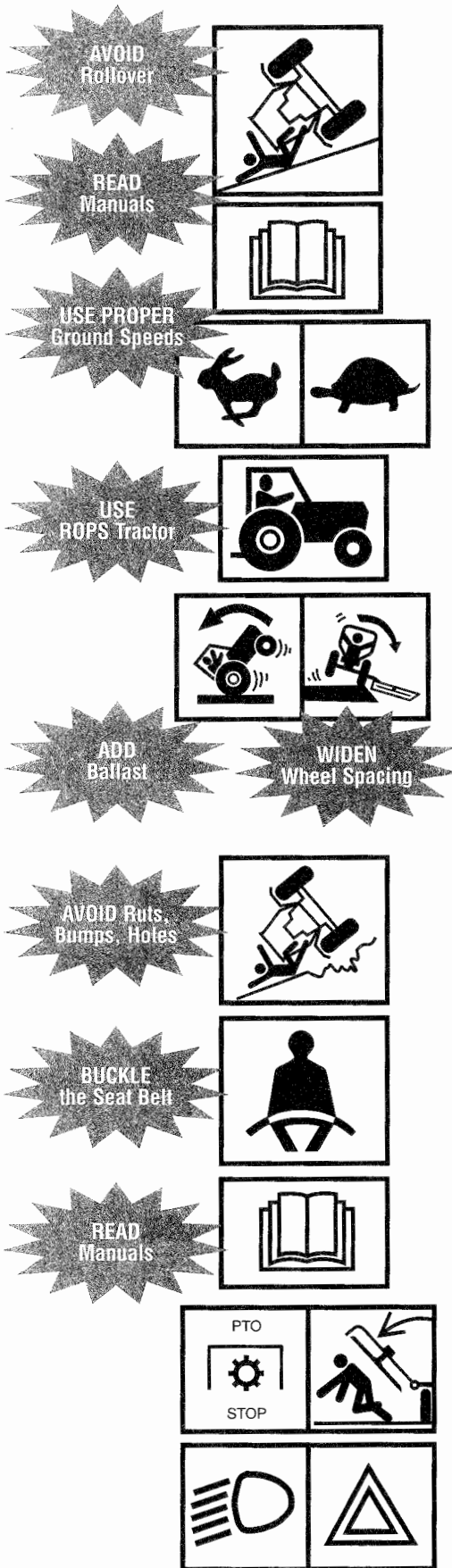

## Mowing Uneven Terrain Safely

The tractor and mower stability is reduced on slopes and uneven terrain.

You can prevent tractor and mower overturns and maintain equipment stability control by:

- Reviewing tractor and mower operator's manuals for operating safety practices on slopes and uneven terrain conditions. Explain the practices to those users and operators who cannot read.
- Avoiding extremely steep slope operations.
- Using extreme care to maintain control over your equipment when operating in these conditions.
- Increasing tractor stability by adding wheel weights and increasing wheel spacing (Refer to tractor operator's manual for recommendations)
- Using ROPS and seat-belt-equipped tractor for operator safety during mowing operations.
- Maintaining minimum ground speed.
- Making wide and gradual turns.
- Avoiding sudden starts, stops, and turns when operating up, down, or across slopes.
- Not raising rear-mount or side-mount mowers or mower wings from the ground during these operations .
- Keeping alert for holes, bumps, ruts, rocks, stumps or other obstructions that could overturn tractor and mower.
- Avoiding slippery ground conditions that could overturn tractor and mower.
- Avoiding tractor and mower "hang up" by diagonal passing through sharp dips and drops.

Use extreme care in maintaining equipment stability during all uneven terrain and slope mowing operations. You are the final judge as to any slope that can be safely negotiated.

## Equipment Road Transporting Safety

If equipment is to be driven on public roads:

- Refer to tractor and mower manufacturers' operator's manuals for instructions.
- Explain the instructions to those users or operators who cannot read.
- Check local regulations for required equipment markings, lights, flashers, etc., while traveling on public roads. Lights are required on mowers that obscure tractor taillights and/or warning lights.

Before transporting on public roads:

- Disengage PTO to mower.
- Raise mower into transport position.
- Lock wings up into transport position with locking devices on wing-type and side-mounted mowers.
- Attach safety chain between pull-type mower and tractor.
- Make sure lights, flashers, reflectors and SMV are in place and visible.
- Check SMV (Slow-Moving Vehicle) emblem for visibility to any rear approaching vehicle.

**While transporting on public roads:**

- Obey all local traffic regulations.
- Approach intersections with caution.
- Observe speed and traffic control signs.
- Avoid panic stops and sharp turns.

**Parking Safety**

**Park equipment at:**

- Designated or out-of-traffic areas.
- Preferably level ground locations.

**Sloping ground parking locations:**

- Position equipment across slope.
- Set parking brakes.
- Lower mower to ground.
- Block tractor wheels.

**Before temporarily parking and leaving disabled equipment near traffic areas:**

- Remove equipment from public roads.
- Set out warning flags
- Use tractor flashers.

**Safety – During Shutdown**

**Use Proper Equipment Shutdown Practices For Your Safety**

Refer to tractor and mower manufacturer’s operator manual(s) for recommend shutdown procedures. Explain the procedures to those users or operators who cannot read.

**Make proper equipment shutdown procedures an important habit to practice. Follow these safety practices before dismanting tractor:**

- Disengage PTO clutch and transmission drive.
- Idle engine for gradual cooling.
- Place the controls in PARK or NEUTRAL.
- Set the parking brake.
- Lower mower to ground.
- Lower wings of wing-type mowers to ground.
- Shut off engine.
- Wait for all moving parts to stop before equipment inspections, adjustments or repairs.
- Relieve hydraulic pressure by moving hydraulic controls several times in all directions.
- Lock ignition and remove key when equipment is to be inspected, repaired, adjusted or unattended.
- Lock anti-vandalism covers and closures when equipment is unattended.
- Dismount carefully maintaining three-point contact.

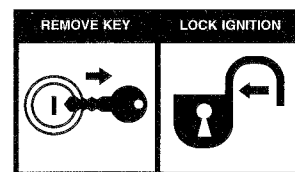
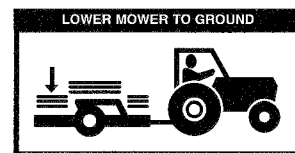
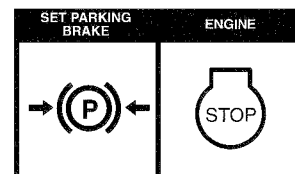
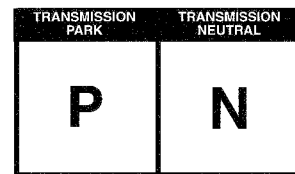
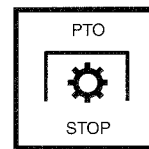
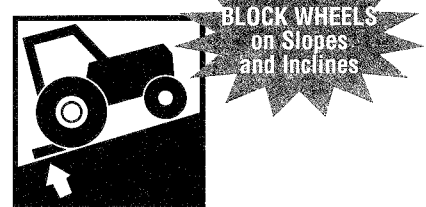
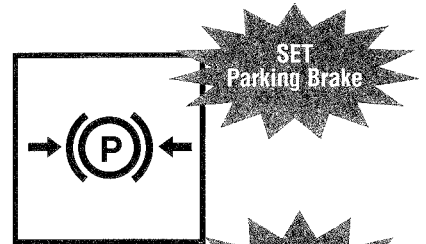

**WAIT For Moving Parts to Stop Before Dismount**

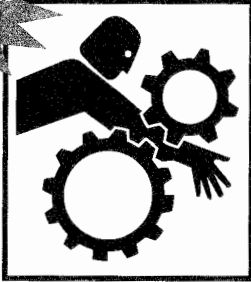

**USE Three Point Contact**



**MAINTAIN Equipment**

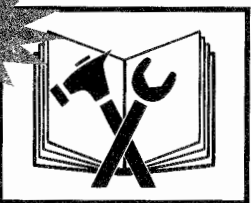

**FOLLOW**

**Maintenance Schedule**



## ***Dismounting Tractor Safely***

### **Before dismounting tractor:**

- Use proper equipment shutdown practice for your safety.
- Lower implement to the ground, stop engine and PTO, set brakes, allow all moving parts to stop, and remove key before dismounting from tractor.
- Never dismount from moving equipment.
- Never jump from machines.
- Dismount carefully.
- Check for slippery steps
- Keep feet and hands away from controls.
- Use handholds and steps during dismount.
- Face machine and use 3 point contact (2 hands, 1 foot or 2 feet, 1 hand).

## ***Safety – During Maintenance***

### ***Maintenance Safety***

**Do the following for your safety before performing any maintenance, repairs or service procedures:**

- Follow proper equipment shutdown practice.
- Wear all the protective clothing and personal safety devices necessary to safely perform the job.
- Refer to your manufacturer's manuals for proper maintenance, repair and service procedures. Explain the procedures to those users and operators who cannot read.

Stored energy sources (electrical, mechanical, hydraulic, pneumatic, chemical, thermal, etc..) must be either locked, blocked, relieved, disconnected, stopped, secured, neutralized, controlled or reduced to a practical minimum before any maintenance, repair or service procedures can be done safely.

**Some basic safety practices to prevent potential injuries from energy releasing sources:**

- Disengage PTO before shutting off engine.
- Place controls in PARK or NEUTRAL before shutting off engine.
- Set parking brake or block wheels.
- Allow all moving parts to stop.
- Lower mower to ground.
- Lower wings to ground on wing-type mowers.
- Shut off tractor engine.
- Lock ignition and remove key.
- Look and listen for evidence of moving parts before opening shields.
- Securely support or block-up mower before working underneath mower or other lifted components.
- Securely support, block-up, or lock-up mower wings with locking devices before working near or underneath a wing-type mower.
- Relieve hydraulic system pressure by moving controls several times in all directions.
- Relieve pressure before disconnecting or disassembling any pressurized system.
- Block or relieve spring pressure before disassembling any spring-loaded mechanism.
- Securely support or block up any elevated machine component before working on it.
- Avoid flames, sparks, or smoking near any fuels.

***Mower Manufacturer Parts and Your Safety***

Most mower manufacturers use special fasteners and specially designed parts to meet mowing operations requirements.

Critical safety-related parts (Self-locking blade bolts, blades, pins, shields or other special items) have specific strength, design and fit requirements for the make and model mower you are using.

**Modifications or repair parts not approved by the mower manufacturer can cause serious safety hazard exposure risk to you and others.**

**TO AVOID SERIOUS INJURY OR DEATH FROM UNAPPROVED PARTS OR MODIFICATIONS:**

- Do not substitute common hardware for self-locking blade bolts or other special part items.
- Do not substitute blades, pins, shields or other critical safety-related parts.
- Do not use grade 5 or 8 bolts to replace grade 2 shear bolts.

***FOLLOW THE SAFETY PRACTICE OF ALWAYS CHECKING THE MOWER FOR PROPER FUNCTION AFTER ALL ADJUSTMENTS REPAIRS OR SERVICE.***

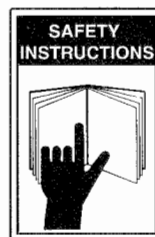
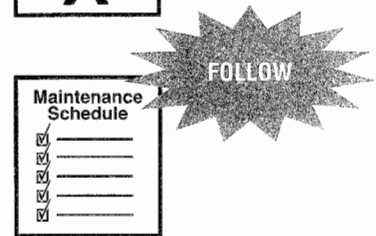
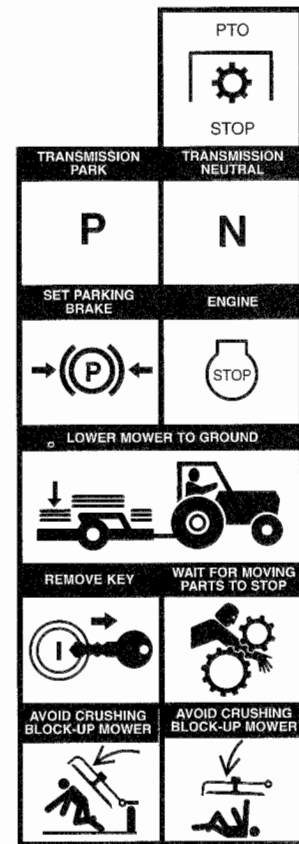

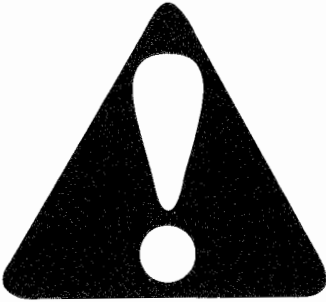

## ***One Final Word***



You have just finished reading the Mower Safety Manual. It is impossible for this manual to cover every potentially hazardous situation you may encounter. But, your knowledge of these safety precautions and your adherence to the basic rules of safety will help build good judgment in all situations. Our objective is to help you develop good safety habits and make you a better mower operator. The mower safety manual, safety precautions and basic rules of safety must be explained to those users or operators who cannot read.

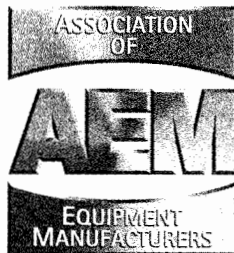

111 E. Wisconsin Avenue • Milwaukee, Wisconsin 53202 U.S.A.  
[www.aem.org](http://www.aem.org)

For information on additional copies of this and  
other safety manuals, call 800-369-2310





# Segadora industrial y agrícola

manual de seguridad

*para operadores  
y mecánicos*

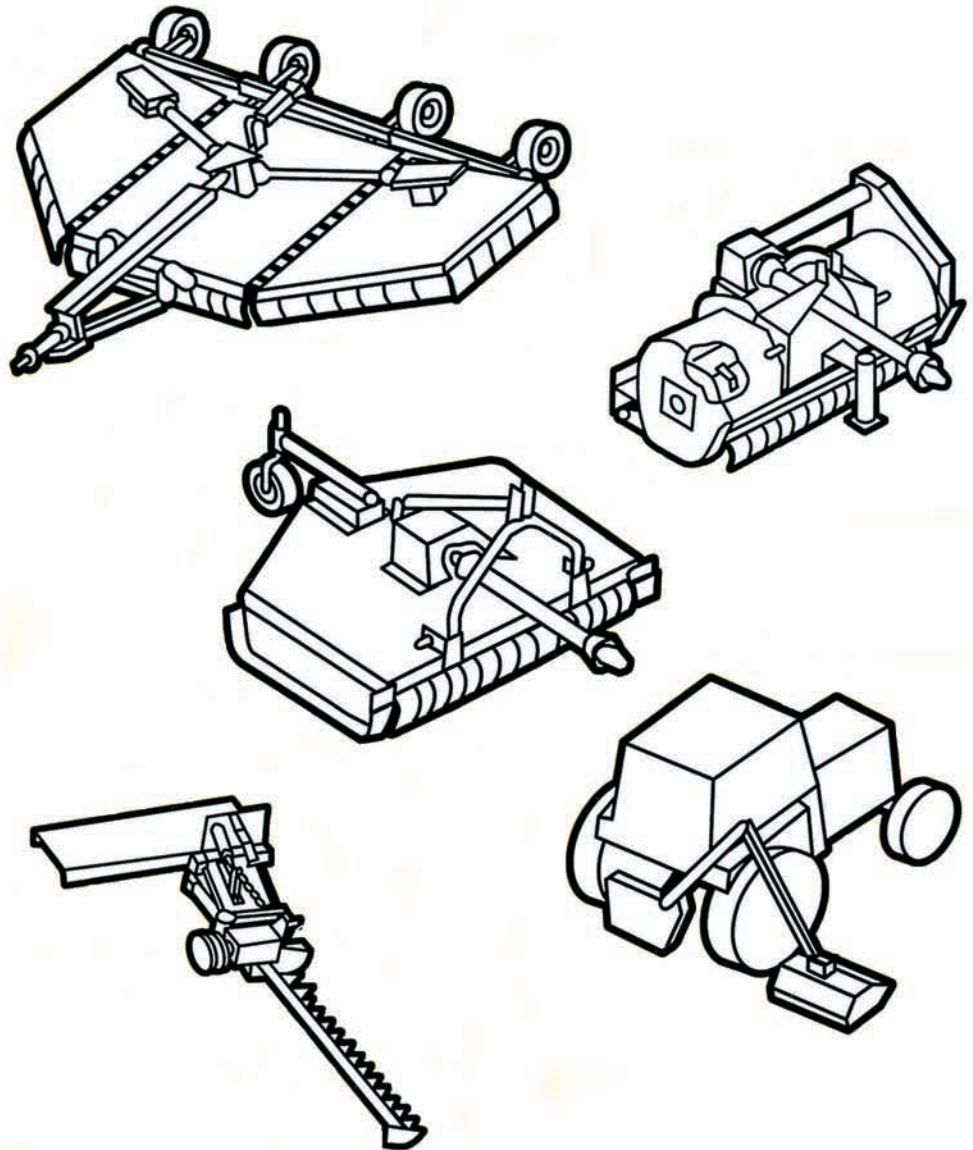

111 E. Wisconsin Avenue • Milwaukee, Wisconsin 53202 U.S.A.  
[www.aem.org](http://www.aem.org)

# Contenido

---

<b>Reconocimiento .....</b>	<b>2</b>
<b>Introducción .....</b>	<b>3</b>
<b>Palabras para el usuario .....</b>	<b>3</b>
<b>Alerta de seguridad .....</b>	<b>4</b>
<b>Segadoras industriales y agrícolas.....</b>	<b>4</b>
<b>Sea un operador responsable .....</b>	<b>5</b>
<b>Manejo seguro de riesgos y peligros.....</b>	<b>6</b>
<b>Cumpla con un programa de seguridad.....</b>	<b>11</b>
<b>Seguridad previa a la operación .....</b>	<b>11</b>
<b>Seguridad durante el arranque y prueba .....</b>	<b>13</b>
<b>Seguridad durante la operación .....</b>	<b>14</b>
<b>Seguridad durante la parada .....</b>	<b>18</b>
<b>Seguridad durante el mantenimiento .....</b>	<b>19</b>
<b>Palabra final .....</b>	<b>21</b>

## Reconocimiento

---

Deseamos extender nuestro reconocimiento a los miembros de del Association of Equipment Manufacturers por sus contribuciones para la preparación de este manual de seguridad.

### Derechos de autor

© 2000 Equipment Manufacturers Institute. Todos los derechos reservados. Revisado 08.2003

# Introducción

---

El propósito de este manual de seguridad es señalar algunas de las situaciones básicas de seguridad que pueden ocurrir durante la operación y mantenimiento de su máquina y sugerir los métodos posibles para tratar estas situaciones. Este manual NO es un sustituto de el (los) manual(es) del fabricante.

Pueden ser necesarias algunas precauciones adicionales, o algunas instrucciones no pueden aplicar, dependiendo del equipo, dispositivos de fijación, y las condiciones del lugar de trabajo o del área en que se realiza el servicio. El fabricante no tiene control directo sobre las aplicaciones, operación, inspección, lubricación o mantenimiento de la máquina. Por lo tanto, es **SU** responsabilidad practicar buenas medidas de seguridad en estas áreas.

La información proporcionada en este manual sirve como complemento de los detalles de información específicos de su máquina que están incluidos en el (los) manual(es) del fabricante. La información adicional que pueda afectar la operación segura de su máquina puede estar incluida en las etiquetas de seguridad o en los requisitos del seguro, programas de seguridad del empleador, códigos de seguridad, leyes locales del estado/provincia y leyes nacionales, reglas y reglamentos.

**IMPORTANTE:** si usted no tiene el (los) manual(es) del fabricante de su máquina específica, obtenga un manual de reemplazo con su empleador, distribuidor de equipo o el fabricante de su máquina. Mantenga este manual de seguridad y el (los) manual(es) del fabricante con su máquina.

## Palabras para el usuario

---

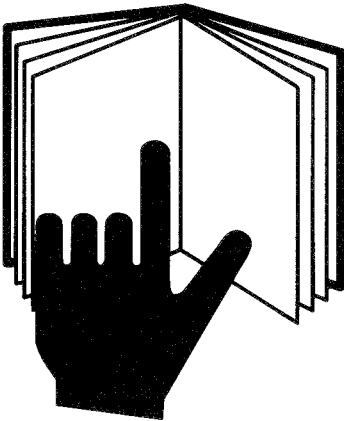

Usted tiene la responsabilidad de leer y comprender este manual de seguridad y el (los) manual(es) del fabricante, antes de operar esta máquina. Este manual de seguridad lo guía paso a paso a lo largo de su día de trabajo. El manual de seguridad, el (los) manual(es) del fabricante, avisos de seguridad (calcomanías) y precauciones de seguridad, deben explicarse a los usuarios u operadores que no puedan leer el material.

Adicionalmente al diseño y configuración del equipo el **CONTROL DEL PELIGRO** y la **PREVENCIÓN DE ACCIDENTES** dependen de la conciencia, preocupación, prudencia y capacitación adecuada de los propietarios y operadores durante la operación, transporte, mantenimiento y almacenamiento del equipo.

Recuerde que **USTED** es la clave para mantener la seguridad. Las buenas prácticas de seguridad no lo protegen solamente a usted sino que también a las personas que lo rodean. Estudie este manual y el (los) manual(es) del fabricante para su máquina específica. Hágalos una parte integral de su programa de seguridad. Recuerde que este manual de seguridad está escrito únicamente para segadoras industriales y agrícolas.

**Practique todas las precauciones de seguridad usuales y acostumbradas en el trabajo y más que todo – recuerde que la seguridad depende de USTED. Solamente USTED puede evitar las lesiones graves o la muerte debidas a prácticas inseguras.**

# Advertencia de seguridad

## Símbolo

Este símbolo de alerta de seguridad significa:

**“¡ATENCIÓN! ¡MANTÉNGASE ALERTA! ¡SU SEGURIDAD ESTÁ INVOLUCRADA!”**



El símbolo de alerta de seguridad identifica los mensajes de seguridad importantes en el equipo, en los avisos de seguridad, en los manuales y en otros lugares. Cuando usted vea este símbolo, esté alerta a la posibilidad de muerte o lesiones. Siga las instrucciones en el aviso de seguridad.

## Palabras de señales

Las palabras de señales son palabras específicas que regularmente se encontrarán en las calcomanías de seguridad en este equipo o en otros equipos en el lugar de trabajo. Estas palabras tienen el objetivo de alertar a la persona que las vea de la presencia y el grado relativo de un riesgo.



Esta palabra de señal indica una situación de riesgo inminente que si no es evitado podrá resultar en la muerte o lesiones graves.



Esta palabra de señal indica una situación potencialmente riesgosa que si no se evita podría resultar en la muerte o lesiones graves.



Esta palabra de señal indica una situación potencialmente riesgosa que si no se evita podría resultar en lesiones menores o moderadas.

- LOS ACCIDENTES PUEDEN LISIAR Y CAUSAR LA MUERTE.
- LOS ACCIDENTES SON COSTOSOS.
- LOS ACCIDENTES PUEDEN EVITARSE.

# Segadoras industriales y agrícolas

Es una segadora para cortar pasto, triturar residuos de cultivos, cortar maleza para la limpieza de terrenos, vías navegables, derechos de paso, cortes en los bordes de los caminos o carreteras.

## TIPOS DE SEGADORAS INDUSTRIALES Y AGRÍCOLAS:

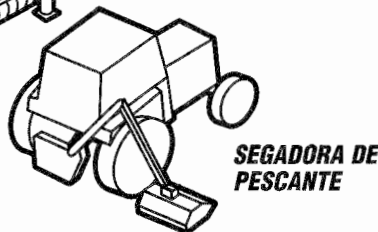
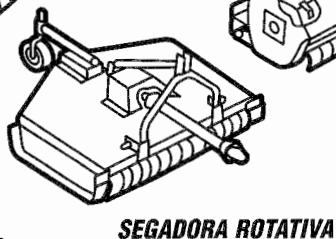
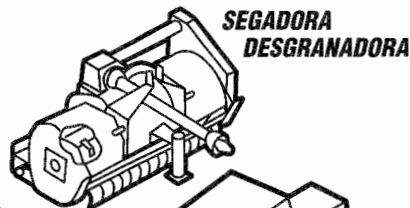

# Sea un operador responsable



Para la operación segura de su equipo usted debe ser un operador responsable. Un operador responsable debe comprender claramente las instrucciones escritas proporcionadas por el fabricante ser capacitado – incluyendo la operación real del equipo y el conocimiento de las reglas y reglamentos de seguridad del lugar de trabajo.

Las medicinas y el alcohol pueden y afectarán el estado de alerta y coordinación del operador, por lo tanto, afectarán la habilidad del operador para operar el equipo en forma segura. Un operador **NUNCA** debe usar medicinas que puedan afectar su estado de alerta, juicio y coordinación; ni beber alcohol mientras opera equipo motorizado incluyendo tractores y segadoras. Un operador que use medicamentos por prescripción médica o de venta libre debe consultar con un médico profesional para conocer sobre cualquier efecto secundario que podría limitar su habilidad para operar este equipo en forma segura. **NUNCA** permita que alguien opere este equipo cuando estén afectados su estado de juicio alerta o de coordinación.

## Protéjase usted mismo

Use toda la ropa protectora y los dispositivos de seguridad personal que se le proporcionen o que sean los indicados para las condiciones de trabajo.

### Usted puede necesitar:

- Casco protector
- Zapatos de seguridad
- Anteojos de seguridad con protección lateral, gafas protectoras o protector facial
- Guantes extrafuertes
- Protección auditiva
- Ropa reflectora
- Equipo para clima húmedo
- Respirador o máscara filtrante

Use ropa apropiada para las condiciones del trabajo.

Siempre conozca cómo obtener ayuda en caso de una emergencia. Conozca donde encontrar y cómo usar los equipos de primeros auxilios y el extintor de incendios/sistema de supresión de incendios.



**Manténgase alerta. Evite los accidentes.  
No conozca la seguridad en la forma más difícil.**

# Manejo seguro de riesgos y peligros

Adicionalmente al diseño y configuración del equipo, el **CONTROL DEL PELIGRO** y la **PREVENCIÓN DE ACCIDENTES** dependen de la conciencia, preocupación, prudencia y capacitación adecuada de los propietarios y operadores durante la operación, transporte, mantenimiento y almacenamiento del equipo.

**EL MANEJO SEGURO DE RIESGOS Y PELIGROS ES UN ELEMENTO ESENCIAL PARA LOS PROPIETARIOS Y OPERADORES RESPONSABLES DE TRACTORES Y SEGADORAS.**

**REVISE EL MANEJO SEGURO DE LOS PELIGROS Y RIESGOS ENUMERADOS A CONTINUACIÓN.**

## ***Peligro de objetos despididos***

EXISTE LA POSIBILIDAD DEL RIESGO DE LESIONES A LOS OPERADORES Y TRANSEÚNTES CAUSADAS POR OBJETOS DESPIDIDOS DURANTE LA OPERACIÓN DE LA SEGADORA POR LOS SIGUIENTES:

OBJETOS (PIEDRAS, ESCOMBROS, HOJAS ROTAS DE LA SEGADORA, PERNOS DE LA HOJA, CABLES, CADENAS, ALAMBRE, ETC.) DESPIDIDOS POR LA SEGADORA.

## ***Dispositivos protectores del equipo y prácticas de seguridad recomendadas***

La cubierta de la segadora y los dispositivos protectores no pueden evitar que escapen todos los objetos o desechos del área cerrada de la hoja en todas las condiciones de segado. Es posible que los objetos escapen y se desplacen cientos de pies (300 [100 m]).

### **PRÁCTICAS DE SEGURIDAD RECOMENDADAS**

Lea los manuales del operador del fabricante para conocer las prácticas de seguridad recomendadas durante la operación. Explique las prácticas a los usuarios u operadores que no puedan leer.

**PARA AYUDAR A EVITAR LESIONES GRAVES O LA MUERTE CAUSADAS POR OBJETOS QUE GOLPEEN AL OPERADOR U OTRAS PERSONAS HAGA LO SIGUIENTE:**

#### **SEGURIDAD DE TRANSEÚNTES**

- Mantenga a los transeúntes a varios cientos de pies (300 [100 m]) del área segada.

#### **SEGURIDAD PROPORCIONADA POR LOS DISPOSITIVOS PROTECTORES DEL EQUIPO**

Para contener, desviar o reducir los objetos despididos del área cerrada de la hoja:

- Mantenga la cadena, blindajes deflectores flexibles o sólidos colocados en la parte delantera y trasera de la cubierta de la segadora, en su lugar y en buen estado de funcionamiento.
- No opere el equipo con los blindajes para objetos despididos dañados o sin que estén colocados en su lugar.

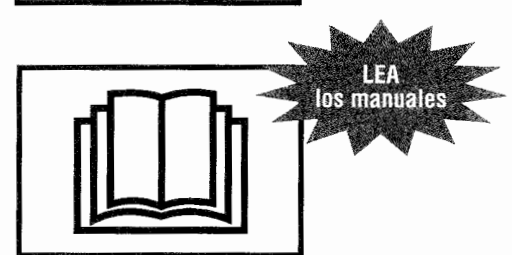



## SEGURIDAD DEL OPERADOR

La operación de las segadoras con las alas levantadas, de montaje lateral y pescante, pueden reducir la efectividad del blindaje para proteger al operador contra los objetos despedidos de la segadora.

**Haga lo indicado a continuación para aumentar la protección del operador contra los objetos despedidos durante las operaciones de segado:**

- Use cabinas cerradas con una estructura de protección contra vuelcos (ROPS), cubiertas protectoras especiales, mallas u otros dispositivos para proteger al operador cuando efectúa estas operaciones.

### **SOBREPASAR LAS VELOCIDADES RECOMENDADAS PARA LA TOMA DE FUERZA (PTO)**

No sobrepase las velocidades recomendadas por el fabricante para la toma de fuerza (PTO).

**Las velocidades excesivas de la toma de fuerza (PTO) pueden causar:**

- Fallo de la hoja
- Escape de objetos a velocidad alta u hojas rotas despedidas del área cerrada de la hoja de la segadora.
- Fallos potenciales de la línea de transmisión de 540 rpm cuando se opera a velocidades de 750 a 1000 rpm.

### **OTRAS PRÁCTICAS DE SEGURIDAD:**

- Nunca debe operar la segadora con hojas rotas, dobladas, faltantes o que estén extremadamente desgastadas.
- Antes de segar retire los desechos y objetos extraños para evitar que sean recogidos y despedidos por la segadora.
- No debe operar la segadora durante el transporte o en posición de ala levantada.

### **PRÁCTICAS DE MANTENIMIENTO RECOMENDADAS**

Lea los manuales del operador del fabricante para conocer sobre la inspección y mantenimiento de las defensas de la cadena y blindaje deflector flexible o sólido:

- Reemplace las defensas desgastadas o dañadas y los demás blindajes antes de segar.
- Use solamente las defensas y blindajes de reemplazo del fabricante. Otras defensas o blindajes pueden no encajar, o los materiales pueden no ser adecuados para cumplir con los requisitos de resistencia del equipo.
- Reemplace las calcomanías desgastadas o dañadas y las instrucciones de advertencia.
- Explique las instrucciones de inspección y mantenimiento a los usuarios u operadores que no puedan leer.

USE cabinas cerradas con una estructura protectora contra vuelcos (ROPS) o cubiertas protectoras

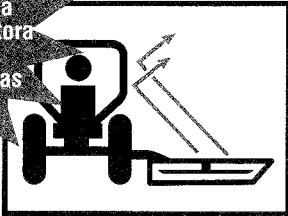

USE la velocidad apropiada de la toma de fuerza (PTO)

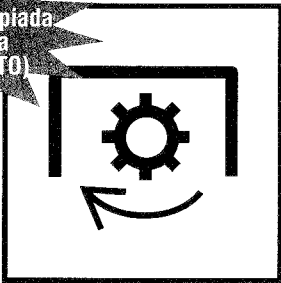

DÉ MANTENIMIENTO a su equipo

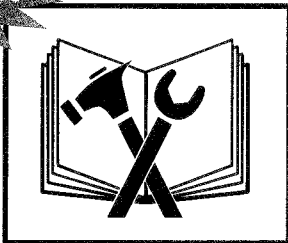

# ***Peligros y riesgos de las hojas rotativas y línea de transmisión***

EXISTE EL RIESGO DE POSIBLES LESIONES A LOS OPERADORES DE LA SEGADORA Y TRANSEÚNTES DURANTE LAS OPERACIONES DE SEGADO CAUSADAS POR LO SIGUIENTE:

- CONTACTO DEL CUERPO CON LAS HOJAS ROTATIVAS.
- ENREDO DEL CUERPO CON LAS LÍNEAS DE TRANSMISIÓN Y PIEZAS ROTATIVAS.

## ***Dispositivos protectores del equipo y prácticas de seguridad recomendadas***

### **PRÁCTICAS DE SEGURIDAD RECOMENDADAS**

Lea los manuales del operador del fabricante para conocer las prácticas de seguridad recomendadas. Explique las prácticas a los usuarios u operadores que no puedan leer. Para evitar el riesgo de lesiones graves o la muerte causadas por el contacto con la hoja en movimiento, línea de transmisión o enredo de los operadores u otras personas haga lo siguiente:

#### **SEGURIDAD DE TRANSEÚNTES**

- No debe operar cerca de transeúntes.
- Mantenga a otras personas a varios cientos de pies (300 [100 m]) del área de segado.

#### **PRÁCTICAS DE SEGURIDAD DEL OPERADOR**

- No permita pasajeros en el tractor o segadora. Asegúrese el cinturón de seguridad durante el segado.
- Use la práctica de parada del equipo apropiada antes de dar servicio, ajustar, limpiar o eliminar las obstrucciones de la segadora.
- Manténgase alejado de las hojas rotativas, piezas y líneas de transmisión.
- Nunca arranque el motor del tractor mientras esté de pie al lado del equipo.
- Solamente arranque el motor del tractor cuando esté sentado en el asiento del operador con el cinturón de seguridad abrochado.

#### **PRÁCTICAS DE SEGURIDAD RECOMENDADAS PARA DEFENSAS Y BLINDAJES DE LA LÍNEA DE TRANSMISIÓN**

- Mantenga las líneas de transmisión y otros blindajes colocados y en buen estado.
- No debe operar la segadora cuando las defensas, defensas de la línea de transmisión u otros blindajes hagan falta o estén dañados.

#### **PRÁCTICAS DE SEGURIDAD RECOMENDADAS**

Lea los manuales del operador del fabricante para conocer las instrucciones sobre defensas, defensas de la línea de transmisión y otros blindajes:

- Reemplace las defensas, defensas de la línea de transmisión y otros blindajes desgastados o dañados antes de segar.
- Use solamente defensas y blindajes de reemplazo hechas por el fabricante. Otras defensas o blindajes pueden no encajar o ser de materiales inadecuados que no cumplan con los requisitos de resistencia del equipo.
- Reemplace las calcomanías e instrucciones de advertencia desgastadas o dañadas.
- Explique las instrucciones de inspección y mantenimiento a los usuarios u operadores que no puedan leer.



**EVITE enredarse**

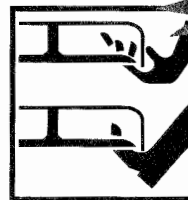

**EVITE las piezas rotativas**



**LEA los manuales**



**ASEGÚRESE el cinturón de seguridad**



**NO LLEVE PASAJEROS**



**EVITE el ser atropellado**



**DÉ MANTENIMIENTO a su equipo**



**EVITE vuelcos**

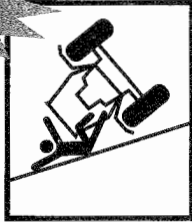

**USE la estructura contra vuelcos (ROPS) del tractor**



**LEA los manuales**

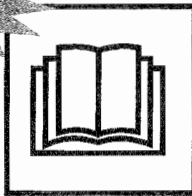

**AGREGUE balasto**



**AUMENTE el espacio entre las ruedas y AGREGUE balasto en el lado contrario**



**ASEGURESE el cinturón de seguridad**



**EVITE EL APLASTAMIENTO asegure el ala**



## ***Peligros y riesgos de rodamiento o vuelco del tractor y segadora***

EXISTE UN RIESGO DE LESIONES POSIBLES AL OPERADOR POR RODAMIENTO O VUELCO DE LA SEGADORA DURANTE LAS OPERACIONES DE SEGADO POR LO SIGUIENTE:

- TERRENO ACCIDENTADO, PENDIENTES INCLINADAS, AGUJEROS, BACHES, SURCOS, PIEDRAS, TRONCOS U OTRAS OBSTRUCCIONES QUE PODRÍAN VOLCAR EL TRACTOR Y SEGADORA.
- VELOCIDADES ABSOLUTAS EXCESIVAS PARA ESTAS CONDICIONES DE TERRENO.

### ***Dispositivos protectores del equipo y prácticas de seguridad recomendadas***

Cuando sea posible, retire los troncos, piedras, etc., o márkuelos claramente con las demás obstrucciones para evitar vuelcos, averías y condiciones de conducción peligrosas. Tenga extremo cuidado para mantener el control sobre el equipo cuando opere en terrenos con estas condiciones.

#### **ESTRUCTURAS CONTRA VUELCO (ROPS) RECOMENDADAS PARA TRACTORES**

Un tractor equipado con una estructura contra vuelcos (ROPS) o cabina ROPS cerrada y cinturón de seguridad para la seguridad del operador, es esencial para la protección adicional del operador, cuando opera en terrenos con estas condiciones

#### **AJUSTES RECOMENDADOS PARA LA ESTABILIDAD DEL TRACTOR**

Lea el manual del operador del tractor para conocer los ajustes para aumentar la estabilidad del tractor:

- Agregue pesas o balasto a las ruedas delanteras y traseras.
- Ajuste el espacio entre las ruedas al ancho máximo.
- Agregue contra balasto en el lado contrario a las segadoras de montaje lateral y de pescante.
- Explique los ajustes a los usuarios u operadores que no puedan leer.

### ***PRÁCTICAS DE SEGURIDAD RECOMENDADAS***

Lea los manuales del operador del fabricante para conocer las prácticas de seguridad de operación recomendadas. Explique las prácticas a los usuarios u operadores que no puedan leer. **Para evitar lesiones graves o la muerte del operador por el vuelco del tractor y segadora, haga lo siguiente:**

- Abroche firmemente el cinturón de seguridad cuando seque con tractores equipados con una estructura contra vuelcos (ROPS).
- Evite la velocidad absoluta excesiva de acuerdo con las condiciones del terreno.
- Evite los arranques, paradas y virajes repentinos cuando opere subiendo, bajando o atravesando pendientes.
- Evite las condiciones de terreno resbaloso.
- Haga virajes anchos y graduales.
- Planifique segar cuesta abajo en pendientes inclinadas para evitar los vuelcos.

## ***Peligros y riesgos de aplastamiento por una segadora o piezas desprendidas***

EXISTE EL RIESGO DE UNA LESIÓN POR APLASTAMIENTO PARA LOS OPERADORES Y OTRAS PERSONAS DURANTE LAS OPERACIONES DE SEGADO DEBIDO A LO SIGUIENTE:

- SEGADORA O EQUIPO DESPRENDIDO DEBIDO A FALLO DEL SISTEMA HIDRÁULICO.
- FALLO EN DAR SOPORTE, BLOQUEAR O ASEGURAR COMPLETAMENTE LA SEGADORA O PIEZAS DEL EQUIPO.

## Dispositivos protectores del equipo y prácticas de seguridad recomendadas

Lea los manuales del operador del fabricante para conocer las prácticas de seguridad de operación recomendadas. Explique las prácticas a los usuarios u operadores que no puedan leer. **Para ayudar a evitar lesiones serias o la muerte de los operadores y otras personas causadas por la caída de la segadora o piezas de equipo, haga lo siguiente:**

### **PRÁCTICAS DE SEGURIDAD RECOMENDADAS**

Antes de trabajar cerca o debajo de la segadora o piezas de equipo en posición levantada:

- Use la práctica de parada del equipo apropiada antes de dar servicio, ajustar, limpiar o eliminar las obstrucciones de la segadora.
- Soporte o coloque bloques firmemente debajo de la segadora o piezas de equipo.
- En las segadoras de tipo ala coloque bloques o asegure firmemente las alas con los seguros o baje al suelo la segadora o piezas del equipo.
- Use los seguros de transporte cuando transporte la segadora en caminos públicos.

## ***Peligros y riesgos por la fuga de fluido hidráulico a presión alta***

EXISTE UN RIESGO PARA LOS OPERADORES DE SEGADORAS Y OTRAS PERSONAS DE UNA POSIBLE INYECCIÓN DE FLUIDO A PRESIÓN ALTA O GANGRENA CAUSADA POR LA INYECCIÓN EN LA PIEL DE ACEITE HIDRÁULICO O DIESEL.

PARA EVITAR LA GANGRENA, EL FLUIDO INYECTADO DEBE SER ELIMINADO QUIRÚRGICAMENTE EN POCAS HORAS, POR UN MÉDICO FAMILIARIZADO CON ESTE TIPO DE LESIÓN.

### **PRÁCTICAS DE SEGURIDAD RECOMENDADAS**

Lea los manuales del operador del fabricante para conocer las prácticas de seguridad recomendadas. Explique las prácticas a los usuarios u operadores que no puedan leer. Las fugas de fluido a presión alta por agujeros minúsculos pueden ser casi invisibles.

**Para ayudar a evitar lesiones serias o la muerte haga lo siguiente:**

- Busque las fugas con pedazos de cartón o madera.
- No use las manos para verificar la presencia de fugas.
- Descargue la presión del sistema antes de desconectar los conductos.
- Antes de aplicar presión al sistema:
  - Revise que los conductos, tuberías y mangueras no estén dañados.
  - Revise que las conexiones estén apretadas.
- Antes de operar los sistemas presurizados:
  - Descargue el aire del sistema.
  - Haga referencia al (los) manual(es) del operador del fabricante para obtener instrucciones.
  - Explique los procedimientos a los usuarios u operadores que no puedan leer.

## ***Peligros y riesgos durante el llenado de combustible del tractor***

Para evitar las lesiones serias o la muerte por incendio durante el llenado:

- Apague el motor y la ignición.
- Nunca llene el tanque de combustible cerca de llamas descubiertas.
- Nunca fume mientras llena combustible.
- Evite las chispas causadas por la electricidad estática poniendo a tierra la boquilla del combustible contra el cuello de llenado del tanque.
- Evite sobrellenar el tanque o derramar el combustible.
- Limpie inmediatamente el combustible derramado.
- Siempre vuelva a colocar la tapa del combustible.

Para evitar lesiones serias o la muerte causadas por las emanaciones del escape del motor:

- Ventile adecuadamente los espacios cerrados antes de arrancar el motor.



LEA los manuales



EVITE EL APLASTAMIENTO coloque bloques o soportes seguros en la segadora



FLUIDO A PRESIÓN ALTA puede inyectarse en el cuerpo



LEA los manuales

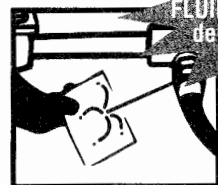

EVITE LA INYECCIÓN DE FLUIDO use un pedazo de cartón, no use las manos



EVITE los incendios y las explosiones

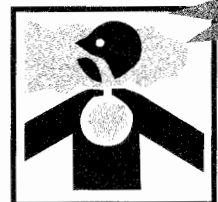

EVITE las emanaciones del escape

## Cumpla con un programa de seguridad



LA SEGURIDAD ES IMPORTANTE PARA LOS PROPIETARIOS Y OPERADORES RESPONSABLES DE TRACTORES Y SEGADORAS. HAGA LO SIGUIENTE PARA SU SEGURIDAD DURANTE LA OPERACIÓN DE SEGADO:

### SEA UN OPERADOR CAPACITADO HACIENDO LO SIGUIENTE:

- Leyendo, comprendiendo y obedeciendo las instrucciones escritas del fabricante en el (los) manual(es) del operador y avisos de seguridad en la segadora y tractor.
- Recibiendo capacitación operativa para la segadora y tractor.
- Solicitando a su distribuidor de equipo o supervisor que le explique lo que usted no comprende.
- Explicando las instrucciones escritas en el (los) manual(es) del operador y avisos de seguridad (calcomanías) en la segadora y tractor a los usuarios u operadores que no puedan leer.

## Seguridad previa a la operación

### Conozca las reglas y reglamentaciones de seguridad del lugar de trabajo

Pregunte a su supervisor sobre las reglas de seguridad de operación del equipo que usted deberá obedecer.

#### Algunas reglas para su seguridad y la de los demás:

- Un tractor equipado con una estructura contra vuelcos (ROPS) es necesario para la protección del operador durante las operaciones de segado.
- Conozca la capacidad y características de operación de la segadora y tractor.
- Nunca altere o desmonte el equipo de seguridad.
- Nunca permita que niños o personas no capacitadas operen una segadora o tractor.
- Nunca permita pasajeros en la segadora o tractor.
- Mantenga a otras personas alejadas de la operación de segado.
- Use la práctica apropiada para parar el equipo antes de bajarse del tractor.
- Permita que se detengan todas las piezas móviles antes de efectuar inspecciones, reparaciones o ajustes al equipo.
- Soporte o coloque bloques firmemente debajo de la segadora antes de trabajar debajo de la segadora o componentes elevados.
- Use la ropa protectora y dispositivos de seguridad personal que le han sido asignados o recomendados por el fabricante del equipo.



### Conozca los controles del tractor y segadora

#### Conozca lo siguiente sobre su tractor y segadora:

- Función, propósito y uso de los controles.
- Velocidades seguras de operación.
- Capacidad para operar en forma segura en pendientes y terreno accidentado.
- Características de frenado y dirección.
- Espacios libres necesarios para la operación del tractor y segadora.
- Cómo detener rápidamente el equipo cuando haya una emergencia.



## Use todos los dispositivos de seguridad del equipo disponibles

Para ayudar a mantener su seguridad y la de las personas que lo rodean:

- Asegúrese de que las defensas, blindajes y avisos de seguridad recomendados por el fabricante están instalados en el equipo y en buen estado.
- Mantenga todos los dispositivos protectores en su lugar y abrochados firmemente.
- **NUNCA** debe operar su equipo con los dispositivos de seguridad sin colocar, desconectados o dañados.
- Use el balasto y peso requerido para la estabilidad operativa del equipo.

## Inspeccione el equipo de la segadora y tractor

Antes de comenzar su día de trabajo:

- Revise que no haya piezas del tractor y segadora que estén sueltas, rotas, dañadas o que no estén colocadas en su lugar.
- Repare o reemplace estas piezas cuando sea necesario.
- Verifique que los implementos del tractor y segadora sean los apropiados.
- Verifique que sean iguales las rpm de régimen de la toma de fuerza (PTO) a las del tractor y de la segadora.
- Revise el estado de las hojas de la segadora. Afile o reemplace de acuerdo con las recomendaciones del fabricante. Las modificaciones a las hojas como soldadura o endurecimiento de los bordes cortantes con soldadura o enderezado de las hojas dobladas, pueden reducir la resistencia de las hojas y afectar adversamente las propiedades y seguridad de las hojas.
- Verifique que todas las defensas y blindajes estén colocados en su lugar y que todo el equipo esté en buen estado de funcionamiento. Esto incluye la línea de transmisión de la toma de fuerza (PTO), caja de engranajes, defensas y blindajes del implemento que sirven para la protección del operador.
- Verifique que la horqueta de la línea de transmisión y los dispositivos de seguro estén correctamente asegurados.
- Verifique que los sistemas hidráulicos del tractor y segadora no estén dañados ni tengan fugas.
- Revise y lea los avisos de seguridad y las instrucciones de advertencia.
- Explique los avisos de seguridad e instrucciones de advertencia a los usuarios u operadores que no puedan leer.

## Inspeccione el área de trabajo

Inspeccione, identifique y evite las condiciones peligrosas en el área de trabajo:

- Terreno accidentado, bajadas escarpadas, zanjas, agujeros, pendientes inclinadas, troncos, agua estancada, suelo de lodo suave, condiciones resbalosas, desechos y objetos extraños.
- Inspeccione el área de segado y elimine o marque todos los objetos extraños y desechos que debe evitar con la segadora.

Analice el área de segado para establecer:

- El mejor y más seguro procedimiento de segado.
- Tipo de material y altura de segado.
- Estado del terreno de operación.
- El uso de un patrón de segado de desplazamiento hacia delante siempre que sea posible.

## Verifique la seguridad de las demás personas

Antes de arrancar el equipo:

- Camine alrededor del equipo.
- Verifique que no haya nadie debajo, sobre o cerca del equipo.
- Aleje a todas las personas de estas áreas.
- Haga sonar una alarma.



USE UNA ESTRUCTURA CONTRA VUELCOS (ROPS) y el cinturón de seguridad

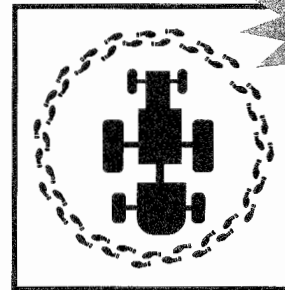

CAMINE ALREDEDOR para inspeccionar

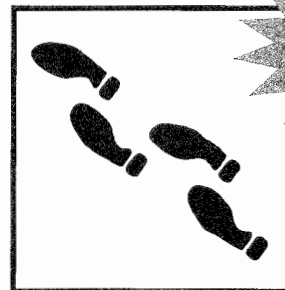

CAMINE ALREDEDOR del lugar de trabajo

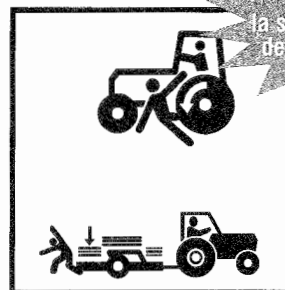

VERIFIQUE la seguridad de las demás personas

# Seguridad durante el arranque y prueba

USE  
el contacto de  
tres puntos



USE UNA  
ESTRUCTURA  
CONTRA VUELCOS  
(ROPS) y el  
cinturón de  
seguridad



USE la  
velocidad  
correcta de la  
toma de fuerza  
(PTO)

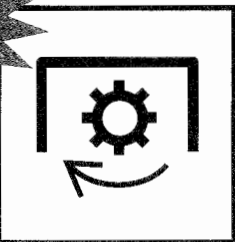

## Seguridad durante la subida al tractor

**Antes de subir:**

- Límpiense los zapatos y las manos.

**Durante la subida y la bajada del tractor:**

- Use las asas y placas de los escalones.
- Nunca utilice los volantes de dirección o controles como asas.
- Nunca suba ni baje de un tractor en movimiento.

## Prueba de seguridad de los controles del tractor y segadora

**Antes del arranque:**

- Ajuste y abroche el cinturón de seguridad en su tractor equipado con una estructura contra vuelcos (ROPS).
- Verifique que el freno de estacionamiento esté enganchado.
- Verifique que desenganche la toma de fuerza (PTO).
- Verifique que todos los controles estén en la posición de punto muerto (N) o de estacionamiento (P).
- Advierta a las demás personas presentes en el área antes de arrancar el tractor.
- Cumpla con los procedimientos de arranque recomendados por el fabricante del tractor.

**Después del arranque:**

- Revise que todos los instrumentos, indicadores y luces indicadoras funcionen normalmente.
- Revise que todos los controles, dirección y frenos del tractor funcionen apropiadamente.
- Repare un tractor que no esté funcionando apropiadamente antes de usarlo.
- Suba y baje la segadora cuando la línea de transmisión llegue al fondo o cuando existen problemas de enganche.
- Verifique que su equipo no vibre excesivamente y que no tenga ruidos anormales.
- Use prácticas apropiadas para detener el equipo antes de inspeccionarlo.

## Seguridad en el sistema de toma de fuerza y segadora

**Tractores con sistemas de doble velocidad (540 ó 1000 rpm) toma de fuerza (PTO) de cambios.**

**Para evitar las lesiones serias o la muerte por el fallo de piezas causado por la sobrevelocidad de la segadora:**

- Asegúrese de colocar el selector de la toma de fuerza (PTO) a la velocidad de régimen de las rpm de la toma de fuerza (PTO).

**Tractores con sistemas con toma de fuerza (PTO) impulsados por la transmisión.**

Una segadora rotativa tendrá un efecto significativo de volante, que puede continuar impulsando el tractor cuando tiene un sistema de toma de fuerza (PTO) impulsado por la transmisión.

**El tractor debe estar equipado y ser operado como se indica a continuación:**

- Instale un embrague de sobremarcha.
- Permítase suficiente espacio y tiempo para maniobrar anticipando los virajes, paradas y reducciones de velocidad.

# Seguridad durante la operación

## Seguridad durante el enganche de la segadora al tractor

### Seguridad en el montaje de la segadora con un enganche de tres puntos:

- Haga referencia a los manuales de los fabricantes de la segadoras y el tractor.
- Coloque la palanca selectora del elevador de potencia hidráulica del tractor (eje de balancín) en posición baja para evitar el movimiento inesperado.
- Explique los procedimientos de enganche a los usuarios u operadores que no puedan leer.

### Seguridad en el montaje de la segadora con enganche de tipo tiro:

- Haga referencia a los manuales del fabricante de la segadora y tractor.
- Utilice solamente un enganche de barra de tiro.
- No la enganche al eje trasero del tractor ni a los brazos del enganche de tres puntos.
- Ajuste la longitud de la barra de tiro del tractor para la operación de la toma de fuerza (PTO) de 540 ó 1000 rpm.

## Comience el uso de la segadora en forma correcta para mayor seguridad

Segue solamente durante el día o cuando exista iluminación artificial adecuada.

### Para evitar las lesiones serias o la muerte causadas por objetos despedidos por la segadora o contacto con las hojas:

- Mantenga los blindajes de la cadena, blindajes deflectores flexibles o sólidos, conductos de descarga, colocados en su lugar y en buen estado.
- Mantenga a todas las personas a varios cientos de pies (300 [100 m]) de la operación de segado.
- Nunca dirija hacia ninguna persona la descarga de la segadora.
- Mantenga las manos, pies y otras partes del cuerpo alejadas de las piezas rotativas, hojas y agujeros de descarga.
- No debe operar la segadora en posición de transporte.

### Enganche de la transmisión, toma de fuerza (PTO) de la segadora:

- Suba la segadora a la altura máxima de corte.
- Enganche la toma de fuerza (PTO) con rpm bajas del motor.
- Aumente las rpm del motor a la velocidad de régimen de las rpm de la toma de fuerza (PTO).
- Baje la segadora a la altura de corte deseado.
- Deténgase y pare inmediatamente si la segadora golpea una obstrucción.
- Inspeccione y repare cualquier daño que tenga la segadora antes de reiniciar el segado.
- No debe operar la segadora cuando tenga vibración excesiva o ruidos anormales.

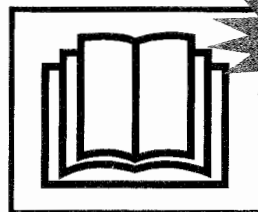

LEA  
los manuales

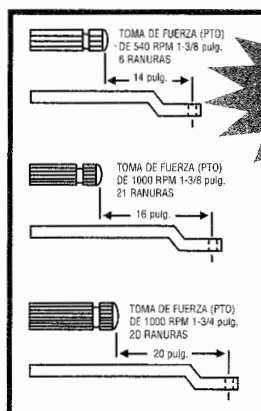

Ajuste  
de la barra  
de tiro del  
TRACTOR

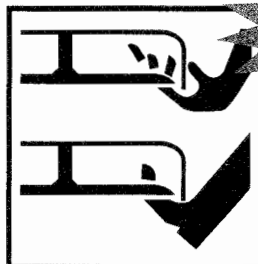

Mantenga la  
distancia de  
LAS HOJAS  
ROTATIVAS

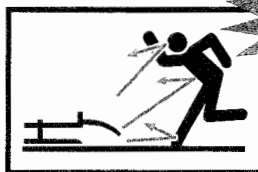

MANTENGA  
alejados a los  
transeúntes



**CUIDE**  
que no haya  
más personas

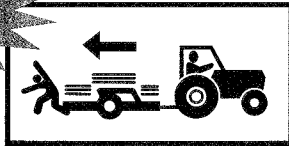

**MANTENGA**  
el rodillo  
trasero de la  
desgranadora

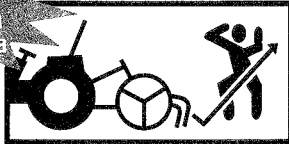

**USE** las  
velocidades  
absolutas  
apropiadas

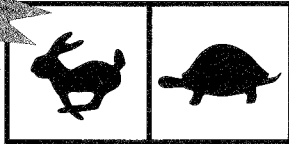

**DETENGA**  
LA HOJA  
antes de eliminar  
obstrucciones



**ESTABLEZCA**  
QUE el espacio  
libre sea adecuado  
para la oscilación  
de la segadora

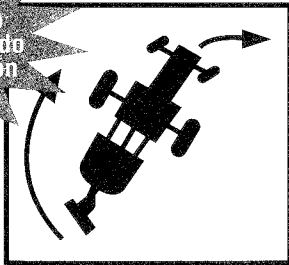

**NUNCA**  
PERMANEZCA  
DE PIE sobre  
la defensa de  
la segadora

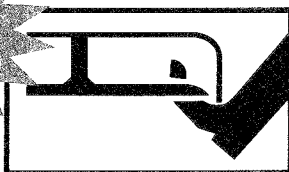

**MANTENGA**  
EL CONDUCTO  
colocado en  
su lugar

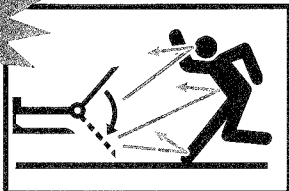

## **Seguridad durante el segado en marcha atrás**

Evite segar en marcha atrás siempre que sea posible.

Haga lo siguiente cuando segue en marcha atrás:

- Verifique que no haya personas atrás de la segadora antes de dar marcha atrás.
- Use extremo cuidado al invertir la dirección del segado.
- Mantenga los blindajes de seguridad delanteros y traseros y los blindajes delanteros de la desgranadora y los rodillos traseros de la segadora rotativa.

## **Velocidad absoluta de segado**

La velocidad absoluta depende de las condiciones del terreno, tipo de pasto, densidad y la altura de corte:

- El alcance normal de la velocidad absoluta es de 2 a 5 mph.
- La velocidad absoluta debe ser menor cuando segue pasto alto y denso.
- La velocidad absoluta puede ser mayor cuando segue pasto de altura mediana, delgado y cuando las condiciones del terreno sean uniformes.
- Use una velocidad absoluta menor cuando segue en pendientes accidentadas o terreno desconocido.

**Segado de pasto extremadamente alto**

- Puede ser necesario segar dos veces el pasto extremadamente alto.

**Primera pasada de segado:**

- Haga un corte alto al pasto (10-15 pulgadas [25-38 mm]) para evitar objetos escondidos.

**Segunda pasada de segado:**

- Retire los desechos y otros objetos.
- Corte el pasto a la altura deseada y a 90 grados de la primera pasada siempre que sea posible.
- Use las prácticas apropiadas de parada del equipo para su seguridad al bajar del tractor.

**Vigile los espacios libres del equipo**

Las segadoras con enganche de tres puntos y de montaje lateral tienen un arco de viraje mayor que las segadoras de tiro. Permita suficiente espacio libre para virar con seguridad.

## **Seguridad en el uso de las segadoras montadas en la parte inferior**

Cuando segue con una segadora montada en la parte inferior:

- Mantenga el conducto de descarga desmontable colocado en su lugar sobre el agujero de descarga.
- Nunca permanezca de pie sobre la cubierta de una segadora que esté en operación.
- Distribuya el pasto cortado con el conducto de descarga hacia el área ya segada.
- Use las prácticas apropiadas para la parada del equipo antes de eliminar las obstrucciones de la segadora o conducto de descarga.

## **Riesgos y peligros de obstrucciones elevadas cuando se usan segadoras de ala o pescante**

Verifique que no haya obstrucciones elevadas cuando use segadoras con alas levantadas o de tipo pescante, para evitar lesiones graves o la muerte causadas por el contacto con:

- Líneas de transmisión de energía eléctrica.
- Ramas bajas de árboles.
- Otras obstrucciones elevadas.

## **Seguridad en el uso de las segadoras de ala y de montaje lateral**

**Cuando utilice segadoras de ala y de montaje lateral:**

Las posiciones con el ala levantada reducen la protección del blindaje y aumentan los riesgos de objetos despedidos y de contacto con la hoja.

**Para evitar las lesiones serias o la muerte causadas por objetos despedidos o contacto con la hoja por la subida y bajada de las alas durante las operaciones de segado:**

- No segue cuando haya transeúntes en el área de segado.
- Asegúrese de que no haya personas cerca cuando suba o baje las alas.
- Mantenga el período de tiempo durante el que está expuesta la hoja rotativa del ala, a un mínimo práctico durante las operaciones de segado con el ala levantada.
- Detenga el segado si entran personas en el área de segado.
- Solamente suba el ala para pasar sobre objetos que se encuentren en el camino de segado o para seguir la inclinación del terreno.
- Desenganche la transmisión del ala durante los períodos prolongados de segado con las alas levantadas.
- Después de pasar sobre un objeto o sobre inclinaciones del terreno, baje el ala levantada, al suelo.
- Permita que todas las hojas de la segadora detengan su rotación antes de levantar las secciones del ala durante otras operaciones.

## **Seguridad durante el segado de los bordes de las zanjas**

Use cuidado extremo cuando sigue los bordes de las zanjas. Vigile para ver si hay derrumbes, áreas erosionadas y obstrucciones para el segado a lo largo del borde de la zanja. El extremo delantero del tractor puede desviarse hacia la zanja al golpear las obstrucciones con las segadoras de montaje lateral o de pescante.

Las operaciones con segadoras con alas levantadas y pescantes pueden reducir la efectividad del blindaje para objetos despedidos de la segadora que sirven para proteger al operador.

**Para aumentar la protección del operador de objetos despedidos durante las operaciones en los bordes de las zanjas:**

- Use cabinas cerradas con una estructura contra vuelcos (ROPS), cubiertas protectoras especiales y otros blindajes para el operador, cuando efectúe estas operaciones.
- Inspeccione el área de segado y retire o marque todos los objetos extraños y desechos que deben evitarse con la segadora.





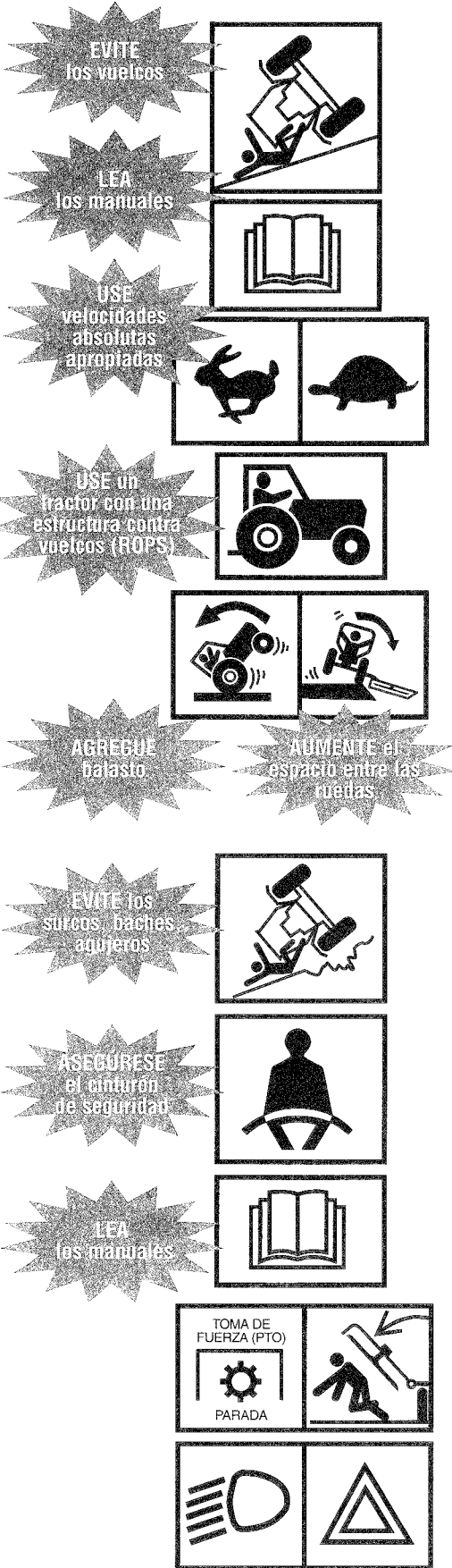

## Seguridad durante el segado de terreno accidentado

La estabilidad del tractor y segadora se reduce en las pendientes y terreno accidentado.

**Usted puede evitar el vuelco del tractor y segadora y mantener el control de la estabilidad del equipo haciendo lo siguiente:**

- Revisando los manuales del operador del tractor y segadora para conocer las prácticas de seguridad de operación en pendientes y terreno accidentado. Explique las prácticas a los usuarios u operadores que no puedan leer.
- Evitando operar en pendientes extremadamente inclinadas.
- Usando cuidado extremo para mantener el control sobre su equipo cuando opere en estas condiciones.
- Aumentando la estabilidad del tractor, agregando pesas a las ruedas y aumentando el espacio entre las mismas, (haga referencia al manual del operador del tractor para conocer las recomendaciones).
- Usando un tractor equipado con una estructura contra vuelcos (ROPS) y cinturón de seguridad para la seguridad del operador durante las operaciones de segado.
- Manteniendo una velocidad absoluta mínima.
- Haciendo virajes anchos y graduales.
- Evitando arranques, paradas y virajes repentinos cuando opere subiendo, bajando o atravesando las pendientes.
- No subiendo del suelo las segadoras montadas atrás o lateralmente ni las alas de segado durante estas operaciones.
- Manteniéndose alerta por si hubiera agujeros, baches, surcos, piedras, troncos u otras obstrucciones que podrían volcar el tractor y segadora.
- Evitando las condiciones de suelo resbaloso que podrían volcar el tractor y segadora.
- Evitando que el tractor y segadora queden atascados al pasar diagonalmente sobre declives y bajadas escarpadas pronunciadas.

**Use extremo cuidado para mantener la estabilidad del equipo durante todas las operaciones sobre terreno accidentado y pendientes. Usted tiene la palabra final referente a cualquier pendiente que pueda ser trabajada en forma segura.**

## Seguridad durante el transporte del equipo en caminos

**Si es necesario conducir el equipo sobre los caminos públicos:**

- Haga referencia al manual del operador del fabricante del tractor y segadora para conocer las instrucciones.
- Explique las instrucciones a los usuarios u operadores que no puedan leer.
- Verifique las reglamentaciones locales referentes a las marcas, luces, luces intermitentes, etc., requeridas del equipo para el desplazamiento sobre caminos públicos. Se requiere de luces para las segadoras que obstruyen las luces traseras del tractor y/o las luces de advertencia.

**Antes del transporte en caminos públicos:**

- Desenganche la toma de fuerza (PTO) conectada a la segadora.
- Suba la segadora a la posición de transporte.
- Asegure las alas en la posición de transporte con los seguros en las segadoras de tipo ala y de montaje lateral.
- Enganche la cadena de seguridad entre la segadora de tipo tiro y el tractor.
- Asegúrese de que las luces, luces intermitentes, reflectores y avisos de vehículo de movimiento lento (SMV) están colocados y visibles.
- Revise que el emblema de vehículo de movimiento lento (SMV) sea visible para cualquier vehículo que se acerque desde atrás.

### Cuando transporte en caminos públicos:

- Obedezca todas las reglamentaciones locales de tráfico.
- Acérquese a las intersecciones con precaución.
- Cumpla con los avisos de velocidad y de control de tráfico.
- Evite las paradas bruscas y doblar repentinamente.

### Seguridad durante el estacionamiento

#### Estacione el equipo en:

- Áreas designadas o alejadas del tráfico.
- Preferentemente utilice lugares en terreno nivelado.

#### Lugares de estacionamiento en terreno inclinado:

- Coloque el equipo en posición transversal en las pendientes.
- Aplique los frenos de estacionamiento.
- Baje la segadora al suelo.
- Coloque bloques en las ruedas del tractor.

#### Antes de estacionar temporalmente y abandonar el equipo incapacitado cerca de áreas con tráfico:

- Retire el equipo de los caminos públicos.
- Coloque las banderas de advertencia.
- Use las luces intermitentes del tractor.

## Seguridad durante la parada

### Para su seguridad use las prácticas apropiadas para la parada del equipo

Haga referencia al (los) manual(es) del operador del fabricante del tractor y segadora para conocer los procedimientos de parada recomendados. Explique los procedimientos a los usuarios u operadores que no puedan leer.

#### Haga que los procedimientos apropiados de parada del equipo sean una costumbre importante que se debe practicar. Siga estas prácticas de seguridad antes de bajarse del tractor:

- Desenganche el embrague y transmisión de la toma de fuerza (PTO).
- Para que el motor enfríe gradualmente permita que funcione al ralentí.
- Coloque los controles en estacionamiento (P) o en punto muerto (N).
- Coloque el freno de estacionamiento.
- Baje la segadora al suelo.
- Baje al suelo las alas de las segadoras de tipo ala.
- Apague el motor.
- Espere a que todas las piezas movibles se detengan antes de efectuar inspecciones, ajustes o reparaciones al equipo.
- Descargue la presión hidráulica moviendo los controles hidráulicos varias veces en todas las direcciones.
- Asegure la ignición y extraiga la llave cuando el equipo debe ser inspeccionado, reparado, ajustado o va a permanecer desatendido.
- Asegure las cubiertas contra el vandalismo cuando el equipo permanece desatendido.
- Baje cuidadosamente manteniendo un contacto de tres puntos.

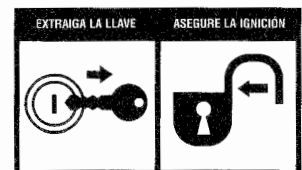
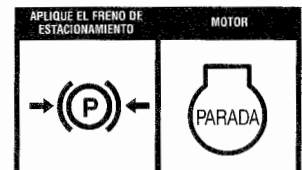
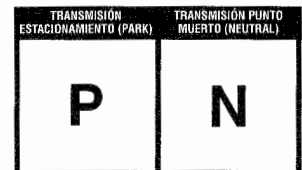
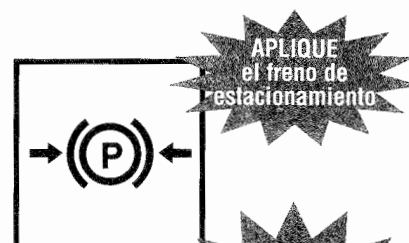

**ESPERE** que las piezas móviles se detengan antes de bajar

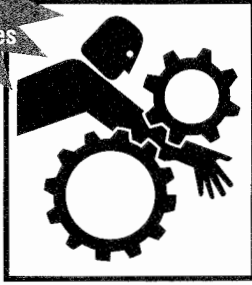

**USE** el contacto de tres puntos



**DE MANTENIMIENTO** a su equipo

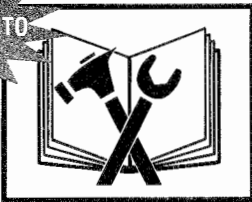

**CUMPLA**

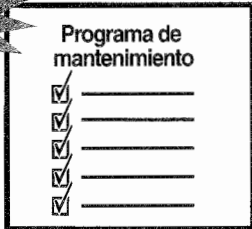

## **Seguridad durante la bajada del tractor**

**Antes de bajar del tractor haga lo siguiente:**

- Para su seguridad, use las prácticas apropiadas para la parada del equipo.
- Baje el implemento al suelo, apague el motor y la toma de fuerza (PTO), aplique los frenos, permita que se detengan todas las piezas móviles y extraiga la llave antes de bajar del tractor.
- Nunca baje del equipo cuando esté en movimiento.
- Nunca salte de las máquinas.
- Baje cuidadosamente.
- Verifique que los escalones no estén resbalosos.
- Mantenga los pies y manos alejados de los controles.
- Use las asas para las manos y los escalones para bajar.
- Vea hacia la máquina y use el contacto de 3 puntos (2 manos, 1 pie ó 2 pies, 1 mano).

## **Seguridad durante el mantenimiento**

### **Seguridad durante el mantenimiento**

**Para su seguridad haga lo siguiente antes de efectuar procedimientos de mantenimiento, reparación o servicio:**

- Cumpla con la práctica apropiada para la parada del equipo.
- Use toda la ropa protectora y equipo de seguridad personal necesarios para efectuar el trabajo en forma segura.
- Haga referencia a sus manuales del fabricante para conocer los procedimientos correctos de mantenimiento, reparación y servicio. Explique los procedimientos a los usuarios y operadores que no puedan leer.

Las fuentes de energía almacenada (eléctrica, mecánica, hidráulica, neumática, química, térmica etc.) deben estar aseguradas, bloqueadas, descargadas, desconectadas, apagadas, aseguradas, neutralizadas, controladas o reducidas a un mínimo práctico, antes de efectuar con seguridad cualquier procedimiento de mantenimiento, reparación o servicio.

**Algunas prácticas de seguridad básicas para evitar posibles lesiones causadas por las fuentes que emiten energía:**

- Desenganche la toma de fuerza (PTO) antes de apagar el motor.
- Coloque los controles en estacionamiento (P) o punto muerto (N) antes de apagar el motor.
- Aplique el freno de estacionamiento o coloque bloques en las ruedas.
- Permita que todas las piezas movibles se detengan.
- Baje la segadora al suelo.
- En las segadoras de tipo ala, baje las alas al suelo.
- Apague el motor del tractor.
- Asegure la ignición y extraiga la llave.
- Observe y escuche para establecer si hay piezas en movimiento antes de abrir los blindajes.
- Soporte o coloque bloques firmemente debajo de la segadora antes de trabajar debajo de la segadora u otros componentes elevados.
- Soporte, coloque bloques o asegure firmemente las alas de la segadora con los seguros antes de trabajar cerca o debajo de una segadora de tipo ala.
- Descargue la presión del sistema hidráulico moviendo los controles varias veces en todas direcciones.
- Descargue la presión antes de desconectar o desensamblar cualquier sistema presurizado.
- Coloque bloques o descargue la presión del resorte antes de desensamblar cualquier dispositivo a resorte.
- Soporte o bloquee firmemente cualquier componente de la máquina que esté elevado, antes de trabajar en ella.
- Evite las llamas, chispas o fumar cerca de cualquier combustible.



**Su seguridad y las piezas del fabricante para la segadora**

La mayoría de los fabricantes de segadoras usan sujetadores y piezas especialmente diseñadas para cumplir con los requerimientos de la operación de segado.

Seguridad crítica – piezas relacionadas (pernos de la hoja autoasegurados, hojas, pasadores, blindajes u otros artículos especiales) tienen requerimientos de fuerza, diseño y encaje específicos para el estilo y modelo de la segadora que usted utiliza.

Las modificaciones o piezas para reparación que no son aprobadas por el fabricante de la segadora pueden causar un riesgo significativo por exposición a su seguridad y la de los demás.

**PARA EVITAR LAS LESIONES SERIAS O LA MUERTE CAUSADAS POR PIEZAS O MODIFICACIONES NO APROBADAS:**

- No sustituya accesorios comunes por los pernos autoasegurados de las hojas u otras piezas especiales.
- No sustituya las hojas, pasadores, blindajes u otras piezas relacionadas con la seguridad crítica.
- No use pernos de grado 5 u 8 para reemplazar los pernos de resistencia limitada grado 2.

**CUMPLA LA PRÁCTICA SEGURA DE SIEMPRE VERIFICAR EL FUNCIONAMIENTO CORRECTO DE TODOS LOS AJUSTES, REPARACIONES O SERVICIO DE LA SEGADORA.**



## **Palabra final**

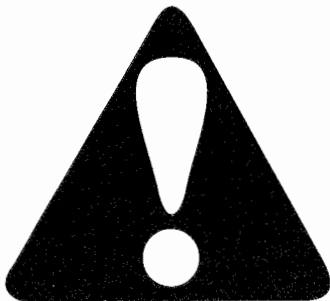

Usted ha terminado de leer el manual de seguridad de la segadora. Es imposible que este manual incluya toda situación peligrosa potencial que usted pueda encontrar. Sin embargo, su conocimiento de estas precauciones de seguridad y su cumplimiento de las reglas básicas de seguridad le ayudarán a crear buen juicio para todas las situaciones. Nuestro objetivo es ayudarle a desarrollar buenos hábitos de seguridad y hacerlo un mejor operador de segadora. El manual de seguridad de la segadora, precauciones de seguridad y reglas básicas de seguridad deben explicarse a los usuarios u operadores que no puedan leer.

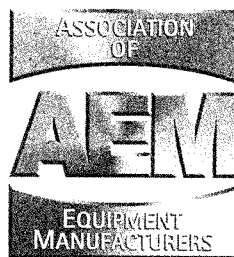

111 E. Wisconsin Avenue • Milwaukee, Wisconsin 53202 U.S.A.  
[www.aem.org](http://www.aem.org)

Para obtener información de reproducciones adicionales y  
otros manuales de seguridad, llame al 800-369-2310



# **INTRODUCTION SECTION**

Introduction Section 2-1



# INTRODUCTION

This Boom Mower is designed with care and built with quality materials by skilled workers. Proper assembly, maintenance, and operating practices, as described in this manual, will help the owner/operator get years of satisfactory service from the machine.

The purpose of this manual is to familiarize, instruct, and train. The Assembly Section instructs the owner/operator in the correct assembly of the Mower using standard and optional equipment. The Parts Listing section is designed to familiarize the owner/operator with replaceable parts on the Mower. This section provides exploded assembly drawings of each mower component illustrating each piece and the corresponding part number.

Careful use and timely service saves extensive repairs and costly downtime losses. The Operation and Maintenance Sections of the manual train the owner/operator how to work the Mower correctly and attend to appropriate maintenance. The Trouble Shooting Guide helps diagnose difficulties with mower and offers solution to the problems.

Safety is of primary importance to the owner/operator and to the manufacturer. The first section of this manual includes a list of Safety Messages, that, if followed, will help protect the operator and bystanders from injury or death. Many of the Safety Messages will be repeated throughout the manual. The owner/operator/dealer should know these Safety Messages before assembly and be aware of the hazards of operating this mower during assembly, use, and maintenance. The Safety Alert Symbol combined with a Signal Word, as seen below, is intended to warn the owner/operator of impending hazards and the degree of possible injury faced when operating this machine.



Indicates an imminently hazardous situation that, if not avoided, WILL result in DEATH OR VERY SERIOUS INJURY.



Indicates an imminently hazardous situation that, if not avoided, COULD result in DEATH OR SERIOUS INJURY.



Indicates an imminently hazardous situation that, if not avoided, MAY result in MINOR INJURY.



Identifies special instructions or procedures that, if not strictly observed, could result in damage to, or destruction of the machine, attachments or the environment.

**NOTE:** *Identifies points of particular interest for more efficient and convenient operation or repair.*

# INTRODUCTION

Your AXTREME Boom Mower is designed for heavy-duty cutting in limited access areas such as highway, park, and rural roadsides, overhead growth, ditches, levees, and other such grass and limb control uses in generally hard-to-reach areas. Your Axetreme Boom can be equipped with a variety of cutting heads designed for specific cutting needs.

The Rotary Head: Rotary unit, 60" wide cut, up to 5" vegetation, front safety gate.

The Flail Axe Head: Flail unit, 48" wide cut, up to 5" vegetation.

The Grass Flail Head: Flail unit, 60" wide cut, up to 2" vegetation.

The Buzzbar Head: Buzzbar unit, 48", 63" & 90" wide cut, up to 6" diameter tree limbs.

The Timbercat Head: Timbercat unit, 5' and 7' wide cut, up to 4" diameter tree limbs.

## DIRECTION

Throughout this Manual front and rear, left and right are determined by the normal direction of travel, the same as driving an automobile. Front and rear, and left and right are determined by the normal direction of travel (the same as on your automobile).



# INTRODUCTION

## Attention Owner/Operator

BEFORE OPERATING THIS MACHINE:

1. Carefully read the Operator's Manual, completely understand the Safety Messages and instructions, and know how to operate correctly both the tractor and implement.
2. Fill out the Warranty Card in full. Be sure to answer all questions, including the Serial Number of the implement. Mail within 30 days of delivery date of this implement.

**NOTE:** Warranties are honored only if completed "Owner Registration and Warranty" forms are received by Alamo Group within thirty days of delivery of the implement.

3. Record the Model and Serial Numbers on the Warranty page at the front of the Operator's Manual. Keep this as part of the permanent maintenance file for the implement.

# IMPORTANT

**For your safety and to guarantee optimum product reliability, always use Genuine ALAMO INDUSTRIAL replacement parts. The use of inferior "will-fit" parts will void Warranty of your ALAMO INDUSTRIAL implement and may cause premature or catastrophic failure which can result in serious injury or death. If you have any questions concerning the repair parts you are using, contact ALAMO INDUSTRIAL, 1502 E. Walnut Seguin, TX 78155 (830) 372-3551.**

**///ALAMO**  
INDUSTRIAL

02926100

# OPERATION SECTION

Operation Section 3-1

# OPERATION

## ALAMO INDUSTRIAL AXTREME BOOM MOWER OPERATING INSTRUCTIONS

Alamo Industrial Booms are manufactured with quality material by skilled workers. The AXTREME Boom is designed to attach to a tractor and operate various heads for a wide range of vegetative maintenance applications. The boom and heads are equipped with safety warning decals, protective deflectors, shields, and other safety features to provide operator and passerby protection, however, no shielding is 100% accurate. ALL safety equipment and safety warning decals must be maintained on the unit in good operational condition at all times.

It is the operator's responsibility to be knowledgeable of all potential operating hazards and to take every reasonable precaution to ensure oneself, others, animals, and property are not injured or damaged by the boom unit, tractor or a thrown object. Do not operate the boom and attached head if bystanders, passersby, pets or livestock are within 300 feet of the unit.

This section of the Operator's Manual is designed to familiarize, instruct, and educate operators to the safe and proper use of the boom and attached head. Pictures contained in this section are intended to be used as a visual aid to assist in explaining the operation of a AXTREME Boom and are not specific to a AXTREME Boom. Some pictures may show shields removed to enhance visual clarity. NEVER operate the boom unit without all safety equipment in place and in good operational condition. The operator must be familiar with the boom unit and tractor operation and all safety practices before beginning operation. Proper operation, as detailed in this manual, will help ensure years of safe and satisfactory use of the AXTREME Boom

**READ AND UNDERSTAND THE ENTIRE OPERATING INSTRUCTIONS AND SAFETY SECTION OF THIS MANUAL AND THE TRACTOR MANUAL BEFORE ATTEMPTING TO USE THE TRACTOR AND IMPLEMENT.** If you do not understand any of the instructions, contact your nearest authorized dealer for a full explanation. Pay close attention to all safety signs and safety messages contained in this manual and those affixed to the implement and tractor. *OPS-U- 0001*

READ, UNDERSTAND, and FOLLOW the following Safety Messages. Serious injury or death may occur unless care is taken to follow the warnings and instructions stated in the Safety Messages. Always use good common sense to avoid hazards. (SG-2)



Si no lee ingles, pida ayuda a alguien que si lo lea para que le traduzca las medidas de seguridad. (SG-3)



# OPERATION

## 1. OPERATOR REQUIREMENTS

Safe operation of the unit is the responsibility of a qualified operator. A qualified operator has read and understands the implement and tractor Operator's Manuals and is experienced in implement and tractor operation and all associated safety practices. In addition to the safety messages contained in this manual, safety signs are affixed to the implement and tractor. If any part of the operation and safe use of this equipment is not completely understood, consult an authorized dealer for a complete explanation.

If the operator cannot read the manuals for themselves or does not completely understand the operation of the equipment, it is the responsibility of the supervisor to read and explain the manuals, safety practices, and operating instructions to the operator.

Safe operation of equipment requires that the operator wear approved Personal Protective Equipment (PPE) for the job conditions when attaching, operating, servicing, and repairing the equipment. PPE is designed to provide operator protection and includes the following safety wear:

### PERSONAL PROTECTIVE EQUIPMENT (PPE)

- Protective Eye Glasses, Goggles, or Face Shield
- Hard Hat
- Steel Toe Safety Footwear
- Gloves
- Hearing Protection
- Close Fitting Clothing
- Respirator or Filter Mask (depends on operating conditions) OPS-U- 0002

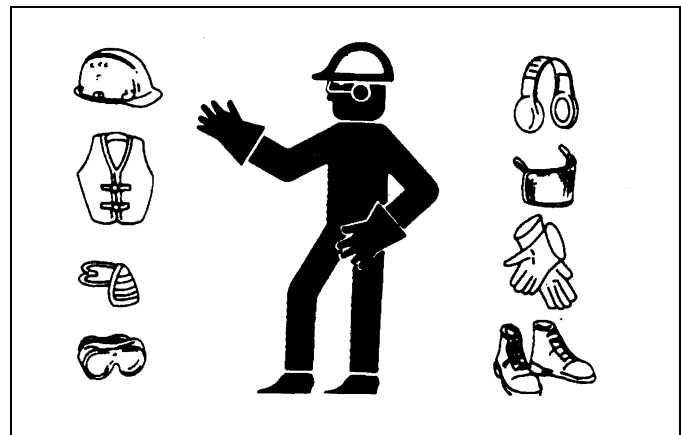

### **⚠ DANGER**

NEVER use drugs or alcohol immediately before or while operating the Tractor and Implement. Drugs and alcohol will affect an operator's alertness and coordination and therefore affect the operator's ability to operate the equipment safely. Before operating the Tractor or Implement, an operator on prescription or over-the-counter medication must consult a medical professional regarding any side effects of the medication that would hinder their ability to operate the Equipment safely. NEVER knowingly allow anyone to operate this equipment when their alertness or coordination is impaired. Serious injury or death to the operator or others could result if the operator is under the influence of drugs or alcohol. (SG-27)

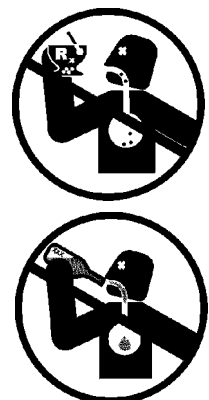

### TRACTOR REQUIREMENTS

# OPERATION

In addition to tractor horsepower and size required to operate the boom unit, the tractor must also be properly equipped to provide operator protection, to alert approaching vehicle drivers of the tractor's presence, and to ensure tractor stability when mowing with the boom fully extended.

## Tractor Requirements and Capabilities

- ASAE approved Roll-Over Protective Structure (ROPS) or ROPS cab and seat belt.
- Operator Protection ..... Tractor must be equipped with protective structure such as operator cage or lexan window to protect operator from thrown object and falling objects
- Tractor Safety Devices ..... Slow Moving Vehicle (SMV) emblem, lighting,
- Tractor Ballast ..... As required to maintain at least 1500 lbs. on left rear tire

### 1.1 ROPS and Seat Belt

The tractor must be equipped with a Roll-Over-Protective-Structure (ROPS) (tractor cab or roll-bar) and seat belt to protect the operator from falling off the tractor, especially during a roll over where the driver could be crushed and killed. Only operate the tractor with the ROPS in the raised position and seat belt fastened. Tractor model not equipped with a ROPS and seat belt should have these life saving features installed by an authorized dealer. *OPS-U- 0003*



Operate this Equipment only with a Tractor equipped with an approved roll-over-protective system (ROPS). Always wear seat belts. Serious injury or even death could result from falling off the tractor--particularly during a turnover when the operator could be pinned under the ROPS. (SG-7)



### 1.2 Operator Thrown Object Protection

The tractor must be equipped with protective equipment to shield the operator from falling and thrown objects. For cab tractors, the tractor must be equipped with an operator safety screen on its right side or the right side windows must be fitted with a shatter proof safety window. For non-cab tractors, the tractor must be equipped with a ROPS and operator protective safety cage that provides protection to the right and above the operator seat. DO NOT remove the ROPS from non-cab tractors to equip a safety cage.



*OPS-B- 0001*



Never operate the Tractor and Mower Unit without an OPS (Operators Protective Structure) or Cab to prevent injury from objects thrown from ground or from overhead trimming. Stop mowing if workers or passersby are within 100 yards. (SBM-9)



# OPERATION

## 1.3 Tractor Lighting and SMV Emblem

If the tractor will be operated near or traveled on a public roadway it must be equipped with proper warning lighting and a Slow Moving Vehicle (SMV) emblem which are clearly visible from the rear of the unit. Most tractor's have different settings for operating and transporting lighting. Refer to the tractor operator's manual for using the tractor's light switch and operating the turn signals.

OPS-B- 0017



## 1.4 Tractor Ballast

To ensure tractor stability when operating on flat surfaces the left rear tractor tire **MUST** exert a minimum down force (weight) of 1500 lbs. on the ground when the tractor is on level ground, its boom is fully extended and the mower head is horizontal and two feet above the ground. For units which have the ability to operate on either side of the tractor, these requirements must also be met for the right side tire when the boom is extended to the left side as described above. A tractor that does not meet this criteria is **DANGEROUS** and should not be operated as upset of the unit can occur resulting in possible serious injury and property damage. **NOTE:** All factory mounted units are tested and meet the ballast requirement before shipment; further testing is not required unless the unit is operated in a manner other than what is considered standard operating conditions.

For additional information on properly ballasting the tractor, refer to Alamo Industrial Tractor and Mower Stability Pamphlet P/N #02959010

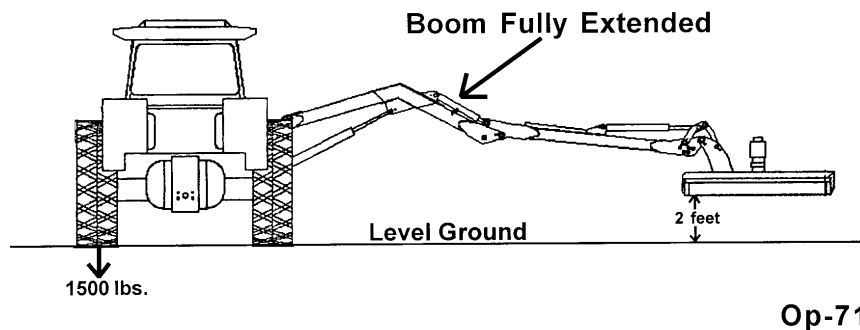

If the unit is operated on slopes greater than 5°,

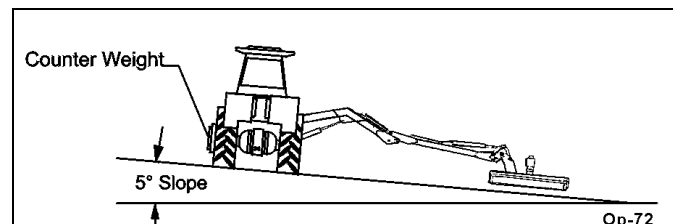



# OPERATION

## 2.GETTING ON AND OFF THE TRACTOR

Before getting onto the tractor, the operator must read and completely understand the implement and tractor operator manuals. If any part of either manual is not completely understood, consult an authorized dealer for a complete explanation. *OPS-U- 0007*



Do not mount or dismount the Tractor while the tractor is moving. Mount the Tractor only when the Tractor and all moving parts are completely stopped. (SG-12)



### 2.1 Boarding the Tractor

Use both hands and equipped handrails and steps for support when boarding the tractor. Never use control levers for support when mounting the tractor. Seat yourself in the operator's seat and secure the seat belt around you.

Never allow passengers to ride on the tractor or attached equipment. Riders can easily fall off and be seriously injured or killed from falling off and being ran over. It is the operator's responsibility to forbid all extra riders at all times. *OPS-U- 0008*



Never allow children to operate, ride on, or come close to the Tractor or Implement. Usually, 16-17 year-old children who are mature and responsible can operate the implement with adult supervision, if they have read and understand the Operator's Manuals, been trained in proper operation of the tractor and Implement, and are physically large enough to reach and operate the controls easily. (SG-11)



Never allow children or other persons to ride on the Tractor or Implement. Falling off can result in serious injury or death. (SG-10)



Do not mount or dismount the Tractor while the tractor is moving. Mount the Tractor only when the Tractor and all moving parts are completely stopped. (SG-12)



# OPERATION

## 2.2 Dismounting the Tractor

Before dismounting the tractor, idle the tractor engine down, disengage the head and retract the boom arm to the transport position. Park the tractor on a level surface, set the transmission in park or neutral and apply the parking brake. Shut down the tractor engine, remove the key, and wait for all motion to come to a complete stop before exiting the operator's seat. NEVER leave the seat until the tractor, its engine, and mower head movement have come to a complete stop.

Use hand rails and extra steps when exiting the tractor. Be careful of your step and use extra caution when mud, ice, snow, and other matter has accumulated on the steps and handrails. Never rush or jump off the tractor. OPS-B- 0002



BEFORE leaving the tractor seat, always engage the brake and/or set the tractor transmission in parking gear, disengage the PTO, stop the engine, remove the key, and wait for all moving parts to stop. Place the tractor shift lever into a low range or parking gear to prevent the tractor from rolling. Never dismount a Tractor that is moving or while the engine is running. Operate the Tractor controls from the tractor seat only. (SG-9)

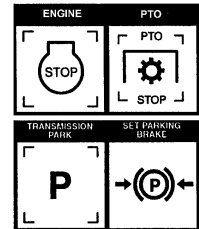

## 3.STARTING THE TRACTOR

The operator must have a complete understanding of the placement, function, and operational use of all tractor controls before starting the tractor. Review the tractor operator's manual and consult an authorized dealer for tractor operation instructions if needed.

Essential Tractor Controls:

- Locate the ignition key/switch
- Locate the engine shut off control
- Locate the hydraulic control levers
- Locate the light control lever
- Locate the brake pedals and clutch
- Locate the PTO control
- Locate the 3 point hitch control lever
- Locate the boom operating controls (joystick or valve bank)

Before starting the tractor ensure the following:

- Conduct all pre-start operation inspection and service according to the tractor operator's manual.
- Make sure all guards, shields, and other safety devices are securely in place.
- The parking brake is on.
- The tractor transmission levers are in park or neutral.
- The boom operating controls are in the neutral and off position.
- The PTO control lever is disengaged.
- The hydraulic remote control levers are in the neutral position.

Refer to the tractor owner's manual for tractor starting procedures. Only start the tractor while seated and belted in the tractor operator's seat. Never bypass the ignition switch by short circuiting the starter solenoid. After the tractor engine is running, avoid accidental contact with the tractor transmission to prevent sudden and unexpected tractor movement. OPS-B- 0003

# OPERATION

OPERATION



Never run the Tractor engine in a closed building or without adequate ventilation. The exhaust fumes can be hazardous to your health. (SG-23)



Start tractor only when properly seated in the Tractor seat. Starting a tractor in gear can result in injury or death. Read the Tractor operators manual for proper starting instructions. (SG-13)



Start only from seat in park or neutral. Starting in gear kills.

## 4. CONNECTING ATTACHING HEADS TO THE BOOM

1. Start by using a hoist to lower the boom(1) down to the head(2). Align the Boom with the Head Hitch Post(3), insert the upper hitch pin(4) through the Dipper end of the boom and the Head Upper Hitch Post. Attach with washer(5), nut(6) , and cotter pin(13).
2. Then align the lower linkage(7) of the Boom and insert the lower hitch pin(8) through hitch post. Attach with nut(9) and bolt(10).
3. Finally make sure all bolts, nuts, and pins are tightened to recommended torque. OPS-B- 0004\_C

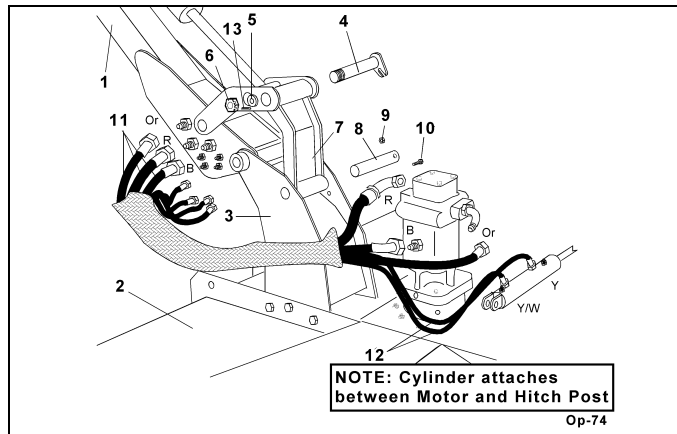

Avoid contact with hot surfaces including hydraulic oil tanks, pumps, motors, valves and hose connections. Relieve hydraulic pressure before performing maintenance or repairs. Use gloves and eye protection when servicing hot components. Contact with a hot surface or fluid can cause serious injury from burns or scalding. (SG-34)



Do not operate this Equipment with hydraulic oil or fuel leaking. Oil and fuel are explosive and their presence could present a hazard. Do not check for leaks with your hand! High-pressure oil streams from breaks in the line could penetrate the skin and cause tissue damage including gangrene. To check for a hose leak, SHUT the unit ENGINE OFF and remove all hydraulic pressure. Wear oil impenetrable gloves, safety glasses and use Cardboard to check for evidence of oil leaks. If you suspect a leak, REMOVE the HOSE and have it tested at a Dealer. If oil does penetrate the skin, have the injury treated immediately by a physician knowledgeable and skilled in this procedure. (SG-15)



# OPERATION

## 5. PRE-OPERATION INSPECTION AND SERVICE

Before each use, a pre-operation inspection and service of the implement and tractor must be performed. This includes routine maintenance and scheduled lubrication, inspecting that all safety devices are equipped and functional, and performing needed repairs. DO NOT operate the unit if the pre-operation inspection reveals any condition affecting safe operation. Perform repairs and replacement of damaged and missing parts as soon as noticed. By performing a thorough pre-operation inspection and service, valuable down time and repair cost can be avoided. OPS-U-0029



Periodically inspect all moving parts for wear and replace when necessary with authorized service parts. Look for loose fasteners, worn or broken parts, and leaky or loose fittings. Make sure all pins have cotter pins and washers. Serious injury may occur from not maintaining this machine in good working order. (SG-21)



All Safety Shields, Guards and Safety devices including (but not limited to) - the Deflectors, Chain Guards, Steel Guards, Gearbox Shields, PTO integral shields, and Retractable Door Shields should be used and maintained in good working condition. All safety devices should be inspected carefully at least daily for missing or broken components. Missing, broken, or worn items must be replaced at once to reduce the possibility of injury or death from thrown objects, entanglement, or blade contact. (SGM-3)

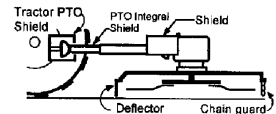

# OPERATION

## 5.1 Tractor Pre-Operation Inspection/Service

Refer to the tractor operator's manual to ensure a complete pre-operation inspection and scheduled service is performed according to the manufacturers recommendations. The following are some of the items that require daily service and inspection:

- Tire condition/air pressure
- Wheel lug bolts
- Steering linkage
- PTO shield
- SMV sign is clean and visible
- Tractor's lights are clean and functional
- Tractor Seat belt is in good condition
- Tractor ROPS is in good condition
- ROPS is in the raised position
- No tractor oil leaks
- Radiator free of debris
- Engine oil level and condition
- Engine coolant level and condition
- Power brake fluid level
- Power steering fluid level
- Fuel condition and level
- Sufficient lubrication at all lube points



## 5.2 Boom Unit Pre-Operation Inspection and Service

Inspect and service the boom arm and head prior to operation. Damaged and/or broken parts should be repaired and/or replaced immediately. To ensure the unit is ready for operation, conduct the following:

*OPS-B- 0020*

### **▲WARNING**

Periodically inspect all moving parts for wear and replace when necessary with authorized service parts. Look for loose fasteners, worn or broken parts, and leaky or loose fittings. Make sure all pins have cotter pins and washers. Serious injury may occur from not maintaining this machine in good working order. (SG-21)

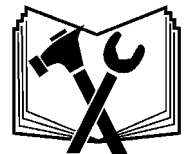

# OPERATION

The operator's manual and safety signs affixed on the unit contain important instructions on the safe and proper use of the equipment. Maintain these important safety features on the implement in good condition to ensure the information is available to the operator at all times.

- Ensure the manual canister is secured to the equipment with the operator's manual inside.
- Ensure all safety signs are in place and legible. Replace missing, damaged, and illegible decals. *OPS-U- 0011*



## FRAME ASSEMBLY

- Inspect condition of mounting frame weldment.
- Inspect condition of Turret Frame Assembly.
- Ensure all bolts and screws are in position and are properly torqued.
- Ensure all pins are in place and fastened with screws.
- Ensure frame is properly mounted to tractor and hardware is properly installed and tightened. *OPS-B- 0021\_C*

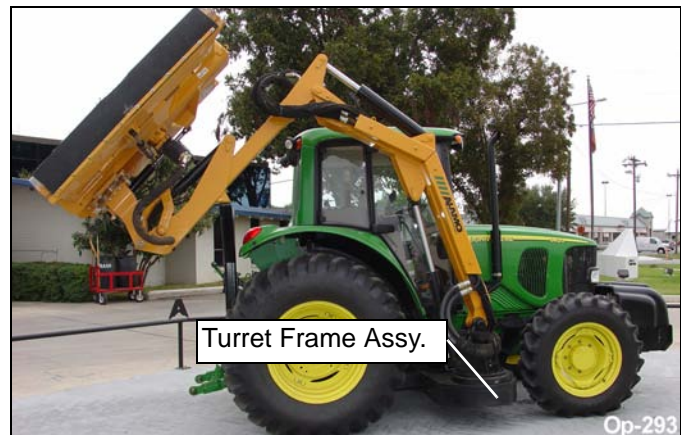

**WARNING**

Relieve hydraulic pressure prior to doing any maintenance or repair work on the Implement. Place the Mower Head on the ground or securely supported on blocks or stands, disengage the PTO, and turn off the engine. Push and pull the control Levers or Joystick several times to relieve pressure prior to starting any maintenance or repair work. (SBM-6)



**WARNING**

Never Leave the mower unattended while the head is in the raised position. The mower could fall causing serious injury to anyone who might inadvertently be under the mower. (SBM-4)



# OPERATION

## BOOM ARM ASSEMBLY

- Inspect condition of each arm section weldment
- Ensure all pins are in place.
- Ensure all bolts and screws are properly installed.
- Check condition of teflon bushings at boom pivot points.
- Ensure each hydraulic cylinder is installed and retained correctly. Ensure the proper size pins are used to retain the cylinders in place and are secured properly. OPS-B- 0022\_D



Never attempt to lubricate, adjust, or remove material from the Implement while it is in motion or while tractor engine is running. (SG-20)

## HYDRAULIC LINE INSPECTION

- Check for hydraulic leaks along hoses, cylinders and fittings. **IMPORTANT:** DO NOT use your hands to check for oil leaks. Use a piece of heavy paper or cardboard to check for hydraulic oil leaks.
  - Inspect the condition of the valve weldment.
  - Ensure fitting is properly connected
  - Inspect condition of nylon bushings.
- OPS-B- 0023\_D



Do not operate this Equipment with hydraulic oil or fuel leaking. Oil and fuel are explosive and their presence could present a hazard. Do not check for leaks with your hand! High-pressure oil streams from breaks in the line could penetrate the skin and cause tissue damage including gangrene. To check for a hose leak, SHUT the unit ENGINE OFF and remove all hydraulic pressure. Wear oil impenetrable gloves, safety glasses and use Cardboard to check for evidence of oil leaks. If you suspect a leak, REMOVE the HOSE and have it tested at a Dealer. If oil does penetrate the skin, have the injury treated immediately by a physician knowledgeable and skilled in this procedure. (SG-15)



# OPERATION

## HYDRAULIC PUMP/OIL RESERVOIR

- Check oil reservoir level and oil condition. (Add specific type oil if low)
- Change hydraulic oil filter and hydraulic oil according to maintenance schedule.
- Ensure there are no oil leaks and fitting are properly connected
- Inspect overall condition of hydraulic pump.
- Inspect pump drive shaft.

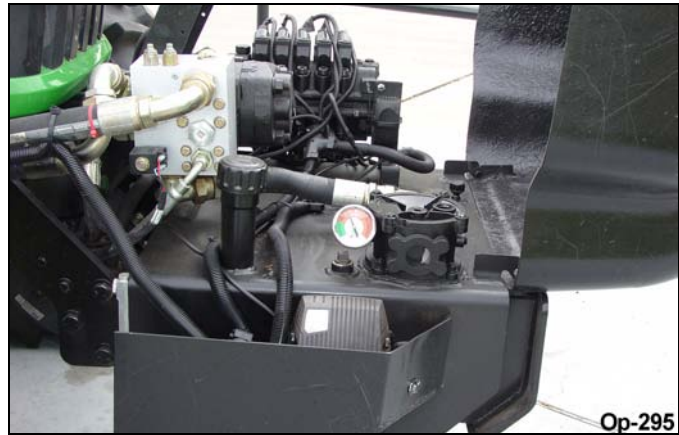

Check the fluid level in the Hydraulic Tank on the Tractor, and add oil if required. As the air has been forced out of the Cylinders and Hoses, it goes into the Hydraulic Tank and reduces the volume of oil. Maintain the oil level within the sight gauge located on the side of the reservoir. Never fill the tank above the sight gauge to allow for the expansion of the oil. The tank maintains pressure after the mower has been run. Stand off to one side when removing the breather cap element to prevent possible injury. To relieve pressure remove the breather cap element and depress the spring loaded pressure valve to release any excess air. OPS-B 0024\_E

### **WARNING**

Attention: Oil Filler Cap is also the Pressure Relief Cap.

Remove cap slowly to relieve pressure before removing cap completely. Stay clear to prevent being scalded with hot oil that may spray out of the tank that is still pressurized and may cause serious injury to eyes, face, and exposed skin. (Ops-0001-MISC)

### **WARNING**

Avoid contact with hot surfaces including hydraulic oil tanks, pumps, motors, valves and hose connections. Relieve hydraulic pressure before performing maintenance or repairs. Use gloves and eye protection when servicing hot components. Contact with a hot surface or fluid can cause serious injury from burns or scalding. (SG-34)



# OPERATION

## ROTARY HEAD INSPECTION

- Inspect blades and blade bolts for looseness and excessive wear. Rotate to 90° to make for checking easier. Replace damaged, worn, and missing blades as complete sets to maintain rotary balance.
- Ensure carrier hub nuts are tightened with the cotter pin inserted and spread.
- Ensure rubber deflectors are in position and not damaged. Replace worn, broken, and missing sections immediately.
- Ensure hydraulic lines are properly connected to the hydraulic motor. Check for hydraulic leaks along hoses and fittings. **DO NOT** use your hands to check for oil leaks. Use a piece of heavy paper or cardboard to check for hydraulic oil leaks.
- Inspect the condition of deck skid shoes and hardware. *OPS-B- 0025*



Do not put hands or feet under mower decks. Blade Contact can result in serious injury or even death. Stay away until all motion has stopped and the decks are securely blocked up. (SGM-09)



Do not put hands or feet near the cutter bar. Blade contact can result in serious injury. Stay away until all motion has stopped and the mower is securely blocked up. (SSM-1)

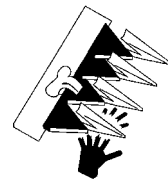

All Safety Shields, Guards and other safety devices including (but not limited to) - Deflectors, Steel Guards and Gearbox Shields must be used and maintained in good working condition. All safety devices should be inspected carefully at least daily for missing or broken components. Missing, broken, or worn items must be replaced at once to reduce the possibility of injury or death from thrown objects, entanglement, or blade contact. (SSM-07)

# OPERATION

## FLAIL HEAD INSPECTION

- Inspect blades and blade bolts for looseness and excessive wear. Rotate to 90° to make for checking easier. Replace damaged, worn, and missing blades as complete sets to maintain cuttershaft balance.
- Ensure rubber deflectors are in position and not damaged. Replace worn, broken, and missing sections immediately.
- Ensure the rollers are in good condition and rotate freely.
- Inspect that all bolts and screws are in position and are properly torqued.
- Ensure hydraulic lines are properly connected to the hydraulic motor. Check for hydraulic leaks along hoses and fittings. **DO NOT** use your hands to check for oil leaks. Use a piece of heavy paper or cardboard to check for hydraulic oil leaks.
- Inspect the condition of the drive belts.
- Ensure the drive belt shields are in place and in good repair.
- Remove any grass or other debris which may be wrapped around the cuttershafts ends.
- Inspect the condition of deck skid shoes and hardware. *OPS-B- 0026\_A*



Do not put hands or feet under mower decks. Blade Contact can result in serious injury or even death. Stay away until all motion has stopped and the decks are securely blocked up. (SFL-2)



All Safety Shields, Guards and other safety devices including (but not limited to) - Deflectors, Steel Guards and Gearbox Shields must be used and maintained in good working condition. All safety devices should be inspected carefully at least daily for missing or broken components. Missing, broken, or worn items must be replaced at once to reduce the possibility of injury or death from thrown objects, entanglement, or blade contact. (SSM-07)

# OPERATION

## TIMBER CAT HEAD INSPECTION

- Inspect blade and bolts for looseness and excessive wear. Make sure the unit is securely blocked up when crawling underneath or set on ground before doing maintenance. Replace damaged and worn blade to keep unit operating properly.
- Ensure hydraulic cylinder is installed and retained correctly. Ensure the proper size pins are used to retain the cylinder in place and are secured with pins.
- Ensure hydraulic lines are properly connected to the hydraulic valve and cylinder. Check for hydraulic leaks along hoses and fittings. DO NOT use your hands to check for oil leaks. Use a piece of heavy paper or cardboard to check for hydraulic oil leaks. OPS-B- 0027



## BUZZBAR HEAD INSPECTION

- Inspect the saw blades and spindle bolts for looseness and excessive wear. Make sure the unit is securely blocked up before doing maintenance. Replace damaged and worn saw blades as complete sets to maintain unit balance.
- Ensure hydraulic lines are properly connected to the hydraulic motor. Check for hydraulic leaks along hoses and fittings. DO NOT use your hands to check for oil leaks. Use a piece of heavy paper or cardboard to check for hydraulic oil leaks.
- Inspect the condition of the Micro V-belts.
- Ensure the drive belt shields are in place and in good repair. OPS-B- 0028



Do not put hands or feet near the cutter bar. Blade contact can result in serious injury. Stay away until all motion has stopped and the mower is securely blocked up. (SSM-1)



# OPERATION

## Boom Mower PRE-OPERATION Inspection



Mower ID# \_\_\_\_\_ Make \_\_\_\_\_

Date: \_\_\_\_\_ Shift \_\_\_\_\_



**Before conducting the inspection, make sure the tractor engine is off, all rotation has stopped and the tractor is in park with the parking brake engaged. Make sure the mower is resting on the ground or securely blocked up and all hydraulic pressure has been relieved.**

**OPERATION**

Item	Condition at Start of Shift	Specific Comments if not O.K.
The Operator's Manual is in the canister on the mower		
All safety decals are in place and legible		
The Mounting frame bolts are in place and tight		
The Boom connection bolts & pins are tight		
There are no cracks in boom		
The Hydraulic Cylinders pins are tight		
The Hydraulic Pump hose connections are tight		
The Hydraulic Valve hose connections are tight		
The Hydraulic Valve controls function properly		
There are no leaking or damaged hoses		
The Hydraulic Oil level is full		
There is no evidence of Hydraulic leaks		
The Blades are not chipped, cracked or bent		
The Blade bolts are tight		
The Deflectors are in place and in good condition		
The Mower shields are in place and in good condition		
The Skid shoes are in good condition & tight		
There are no cracks or holes in mower deck		
The Hyd. motor mounting bolts are tight		
The mower head spindle housing is tight and lubricated		

Operator's Signature: \_\_\_\_\_

**DO NOT OPERATE an UNSAFE TRACTOR or MOWER**

# OPERATION

## Tractor PRE-OPERATION Inspection



Mower ID# \_\_\_\_\_ Make \_\_\_\_\_

Date: \_\_\_\_\_ Shift \_\_\_\_\_



**Before conducting the inspection, make sure the tractor engine is off, all rotation has stopped and the tractor is in park with the parking brake engaged. Make sure the mower is resting on the ground or securely blocked up and all hydraulic pressure has been relieved.**

**OPERATION**

Item	Condition at Start of Shift	Specific Comments if not O.K.
The flashing lights function properly		
The SMV Sign is clean and visible		
The tires are in good condition with proper pressure		
The wheel lug bolts are tight		
The tractor brakes are in good condition		
The steering linkage is in good condition		
There are no visible oil leaks		
The hydraulic controls function properly		
The ROPS or ROBS Cab is in good condition		
The seatbelt is in place and in good condition		
The 3-point hitch is in good condition		
The drawbar pins are securely in place		
The PTO master shield is in place		
The engine oil level is full		
The brake fluid level is full		
The power steering fluid level is full		
The fuel level is adequate		
The engine coolant fluid level is full		
The radiator is free of debris		
The air filter is in good condition		

Operator's Signature: \_\_\_\_\_

**DO NOT OPERATE an UNSAFE TRACTOR or MOWER**

This Inspection Form may be freely duplicated for extra copies.

# OPERATION

## 5.3 Cutting Component Inspection

Inspect blade pan and blade assembly for the following:

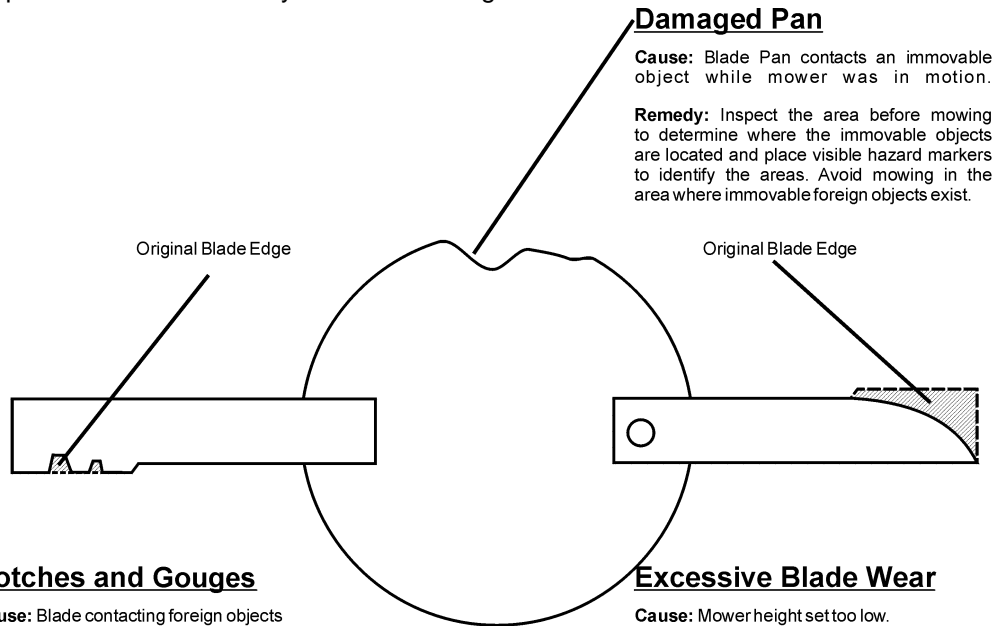

### Damaged Pan

**Cause:** Blade Pan contacts an immovable object while mower was in motion.

**Remedy:** Inspect the area before mowing to determine where the immovable objects are located and place visible hazard markers to identify the areas. Avoid mowing in the area where immovable foreign objects exist.

### Notches and Gouges

**Cause:** Blade contacting foreign objects

**Remedy:** Inspect the area to be mowed and remove foreign objects that could cause damage to the blades

### Excessive Blade Wear

**Cause:** Mower height set too low. Blade used past intended life.

**Remedy:** Replace blades more often. Adjust mower height for mowing Conditions to eliminate blade-to-ground contact

Op-22

OPS-U-0031



Inspect the Blades daily for abnormal wear. REPLACE BOTH BLADES on that carrier IMMEDIATELY if either blade has:

- Become bent or deformed from its original shape or
- Any cracks are visible, or
- Deep gouges in the blade's surface are present, or
- Gouges or chipped areas in the cutting edge are larger than 1/2"(12.7mm), or
- The material on the leading edge has been worn away by more than 1/2(12.7mm)"

Failure to replace abnormally worn blades may lead to catastrophic failure of the blades and ejection of the broken part with tremendous force which may cause serious bodily injury or death. OPS-U-0032

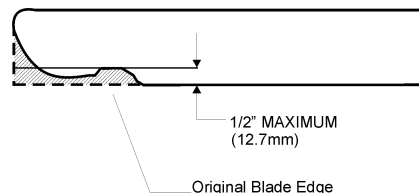

**NOTE:**  
Replace Blades in pairs after no more than 1/2" (12.7mm) wear  
Op-23

# OPERATION

OPERATION

## 5.4 Blade Bolt Inspection

Inspect Blade Bolt Head daily for wear as followed:

### Excessive Blade Bolt Wear

**Cause:** Blade Bolt contacts a foreign or solid object while Blade is in motion.

**Remedy:** Inspect the area before mowing to determine where the foreign objects are located and place visible hazard markers to identify the areas where immovable foreign objects exist, and avoid hitting the objects.

### Notches and Gouges

**Cause:** Blade Bolt contacting foreign objects.

**Remedy:** Inspect area to be mowed and remove foreign objects that could cause damage to the blade bolt.

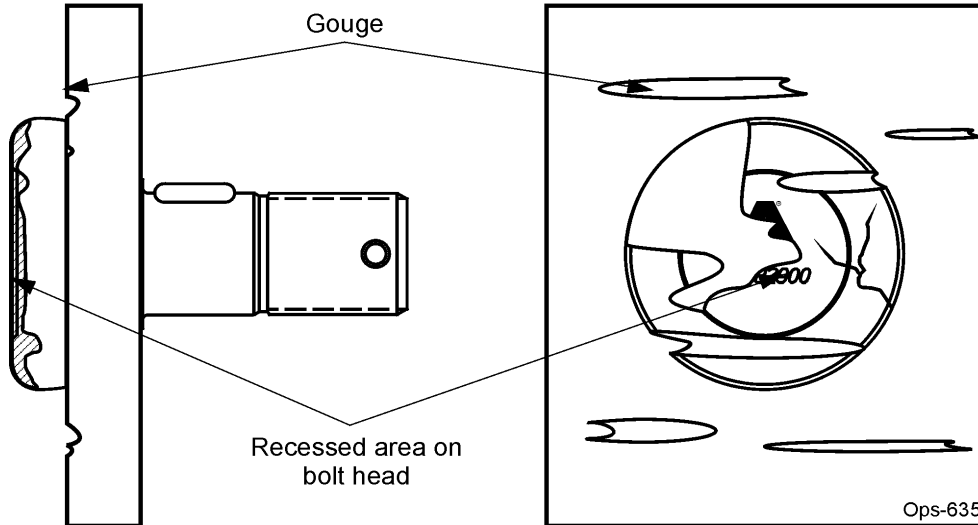

Inspect the Blade Bolt Heads daily for abnormal wear. REPLACE BOTH BLADE BOLTS on the Blades IMMEDIATELY if either blade bolts has:

- Visible cracks or
- If the recessed area on blade bolt is worn off or
- If Blade Bolt has gouges or chipped areas.

Failure to replace abnormally worn blade bolts may lead to catastrophic failure of the blades and ejection of the broken part which may cause serious bodily injury or death.

**Always replace Blade Bolts with new bolts whenever replacing the Blades. OPS-U-0037**



# OPERATION

## 6. OPERATING THE MANUAL CONTROL VALVES

The AX TREME has two control valves. One is the on-off switch to the cutter motor and the other is the position control valve.

ON-OFF Switch (Mower Valve) - To operate the mower, pull the switch while the tractor is running. The push-pull operator will remain in the ON position PULLED or the OFF position PUSHED until the operator desires to start or stop the mower. Always start the cutterhead with the tractor at idle.



The operator should not leave his seat with this valve engaged or with the tractor engine running. Allow approximately 60 seconds for the blades to come to rest after turning the switch off before dismounting.

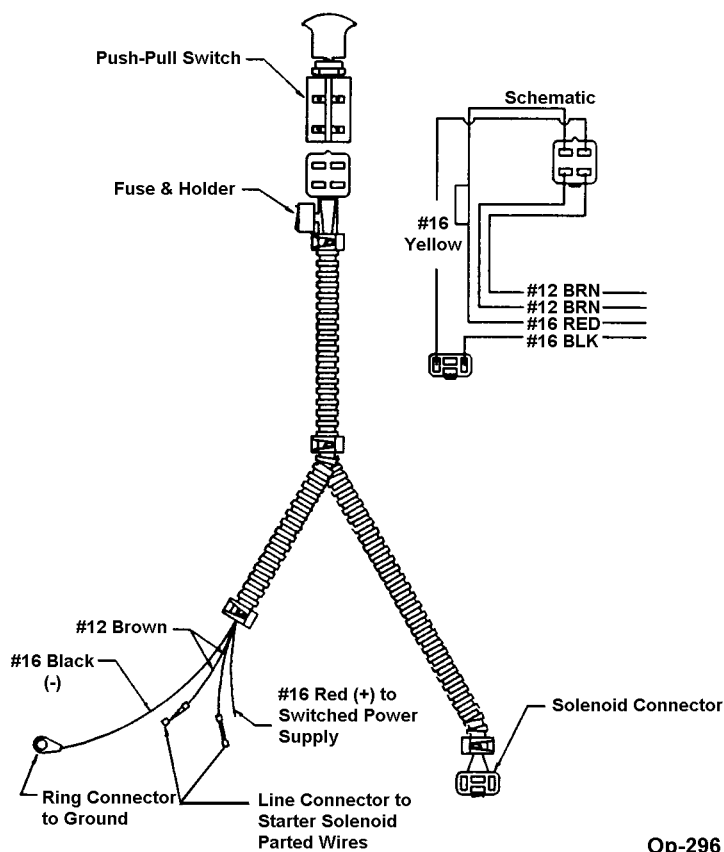

The mower valve comes with a push-pull operator switch that, when properly installed, will prevent the tractor from starting if the switch is in the ON position (pulled out). To properly install the push-pull operator, follow the



Operate the Tractor and/or Implement controls only while properly seated in the Tractor seat with the seat belt securely fastened around you. Inadvertent movement of the Tractor or Implement may cause serious injury or death. (SG-29)



# OPERATION

For safe and efficient boom mower operation, it is critical that the operator be experienced and feel confident in using the control valve sticks to position the boom. New operator's should allowed ample time to practice using the control valve sticks in an open area before entering the work site. Before attempting to operate this equipment, read these instructions completely. If you have any questions concerning safety of operation, contact your dealer or **ALAMO INDUSTRIAL**.

This valve is located on the Main Frame of the unit. These are fastened together in a bank of five valves. Their use will be explained in the following pages of this manual. Read each explanation carefully then practice in a safe, level area, CLEAR of all people, animals, and any obstructions. As always, use extreme caution when using this machine. This valve is controlled by operating the Remote Control Valve Box mounted to the right of the operator at a convenient height.

**NOTE:** The stamped metal plate located above the control valve indicates each valve function.

Practice performing multiple functions simultaneously. With some practice, the control valve sticks will become very easy to operate and will feel almost as it were an extension of your arm.

With the exception of the relief valves, which are preset at the factory, these are all the controls for operating the machine other than the controls on the tractor itself.

# OPERATION

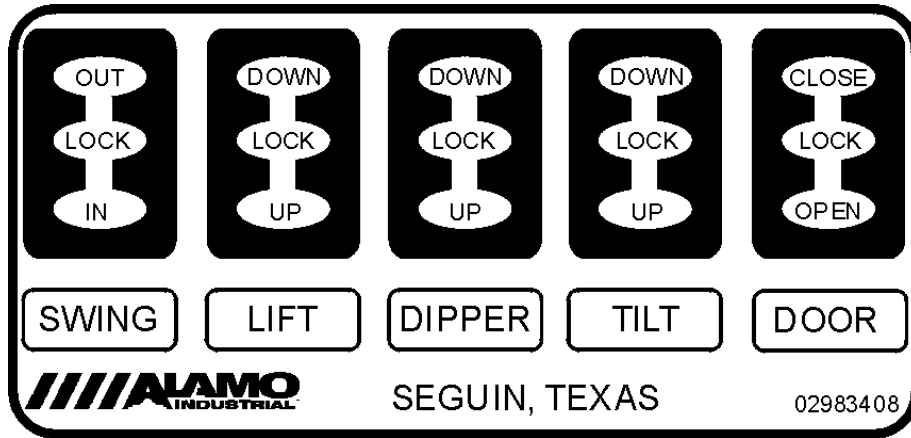

VALVE OPERATION PLATE P/N 02983408

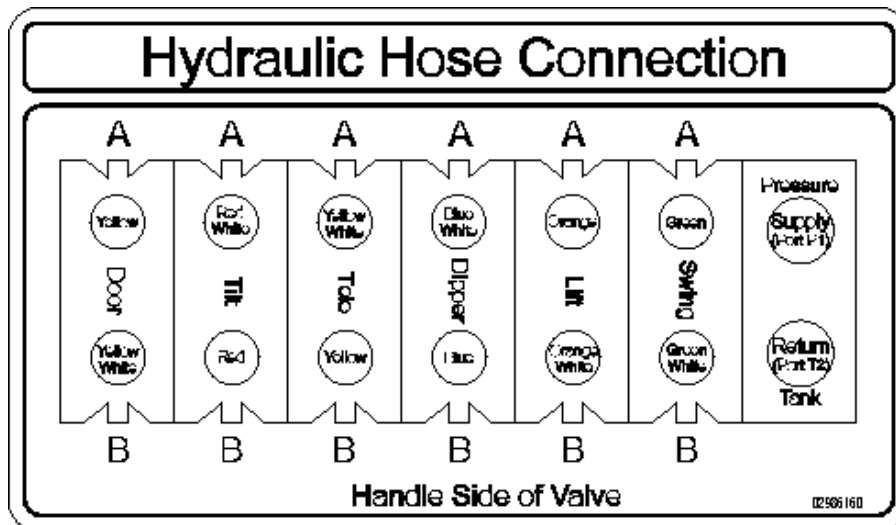

VALVE OPERATION PLATE P/N 02986160 APPLIES ONLY FOR 28T AXTRME

**OPERATION**

# OPERATION

## OPERATION

### 6.1 Swing

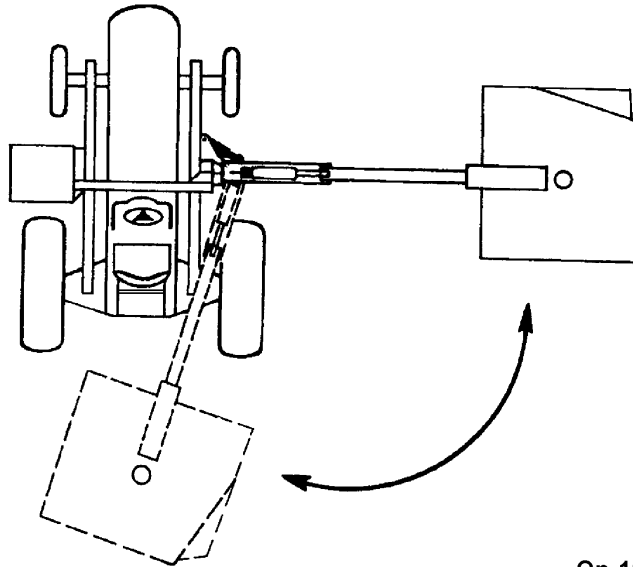

Op-168

The handle nearest the center of the tractor, in the bank of four valves, actuates the SWING cylinder. This valve has three positions and operates in three ways.

Push the valve handle forward and you admit hydraulic fluid to the Rod End of the SWING cylinder, causing the boom to swing out to the right side of the tractor. (See Diagram).

If the handle is released, the valve will automatically return to center, and the boom will be LOCKED in position.

Pull the valve handle back towards you and admit hydraulic fluid to the dead end of the cylinder causing the boom to swing back toward the rear of the tractor. If the handle is continually held in this position, the boom will continue to the left side of the tractor.

Again, if the valve handle is released, the valve will automatically return to center and the boom will be LOCKED in place.

**BOOM SAFETY VALVE** - If a rigid object (guard railpost, tree, etc.) is struck by the extended boom while the unit is moving forward the boom safety valve will allow the boom to swing rearward, and minimize the possibility of damage.

**NOTICE:** This device will NOT work if the unit is mowing BACKWARDS and the boom is in the full forward position.



Make certain that the Boom swing path is clear of bystanders, powerlines, and obstructions to prevent injury, electrocution, and possible machine damage. Swing Boom SLOWLY AND CAREFULLY. Avoid sudden starting and stopping. (Ops-0002-MISC)

# OPERATION

## 6.2 Lift

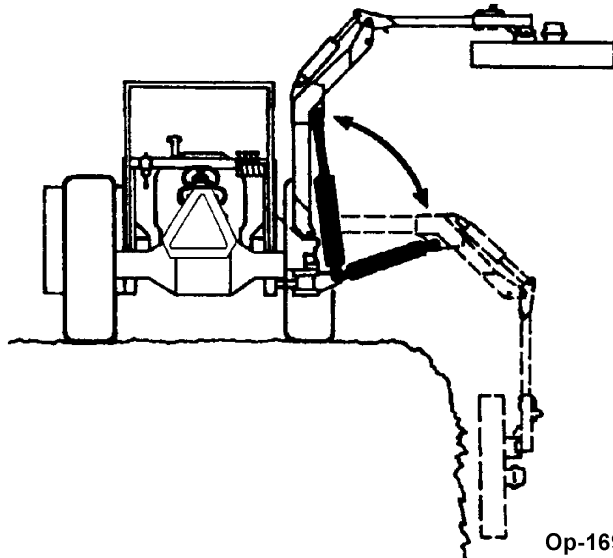

The second handle from the left in the bank of four valves actuates the LIFT cylinder. This valve has four positions.

Pulling the valve handle back, toward the operator, causes the boom LIFT cylinder to lift the boom arm up.



Make certain that you do not lift the head in such a fashion that you lift the left rear wheel off the ground. Install weight as needed to keep at least 1000 lbs. on the left rear wheel.

If the handle is released, the valve will automatically return to center and boom will be LOCKED in position.

Pushing the handle forward from the locked position will lower the boom.

Again, if the handle is released, the valve will automatically return to center and the boom will be LOCKED in position.



Make certain that you do not lift the head in such a fashion that you lift the left rear wheel off the ground. Install weight as needed to keep at least 1500 lb. on the ground under left rear wheel.



Never Leave the mower unattended while the head is in the raised position. The mower could fall causing serious injury to anyone who might inadvertently be under the mower. (SBM-4)



# OPERATION

OPERATION

## 6.3 Dipper

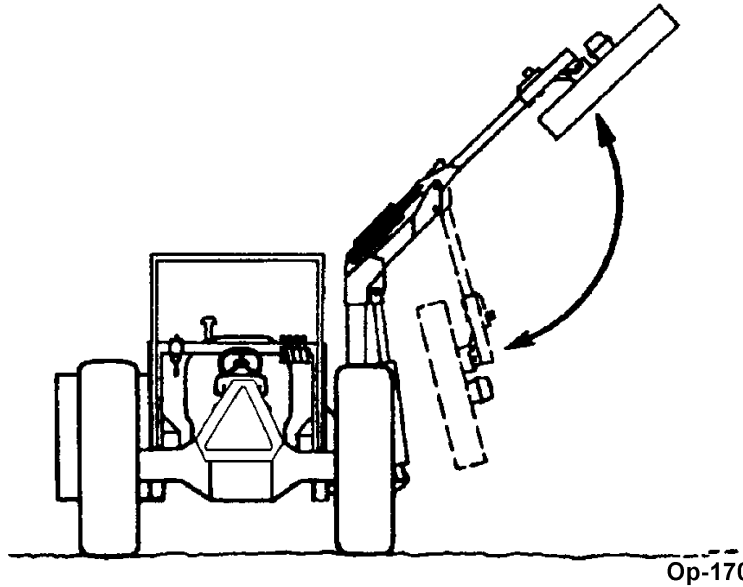

The third handle in the bank of four valves actuates the DIPPER cylinder.

Like the swing valves, this has three positions.

Pulling the valve handle causes the boom DIPPER cylinder to lift the small boom UP.



Make certain that you do not lift the head in such a fashion that you lift the left rear wheel off the ground. Install weight as needed to keep at least 1000 lbs. on the left rear wheel.

If the handle is released, the valve will automatically return to center, and the boom will be LOCKED in position.

Pushing the valve handle will lower the boom.

Again, if the handle is released, the valve will automatically return to center, and the boom will be LOCKED in position.



Make certain that the Boom swing path is clear of bystanders, power lines, and obstruction to prevent injury, electrocution, and possible machine damage. Swing Boom SLOWLY AND CAREFULLY. Avoid sudden starting and stopping.

OPS-B- 0034\_B

# OPERATION

## 6.4 Telescoping Boom

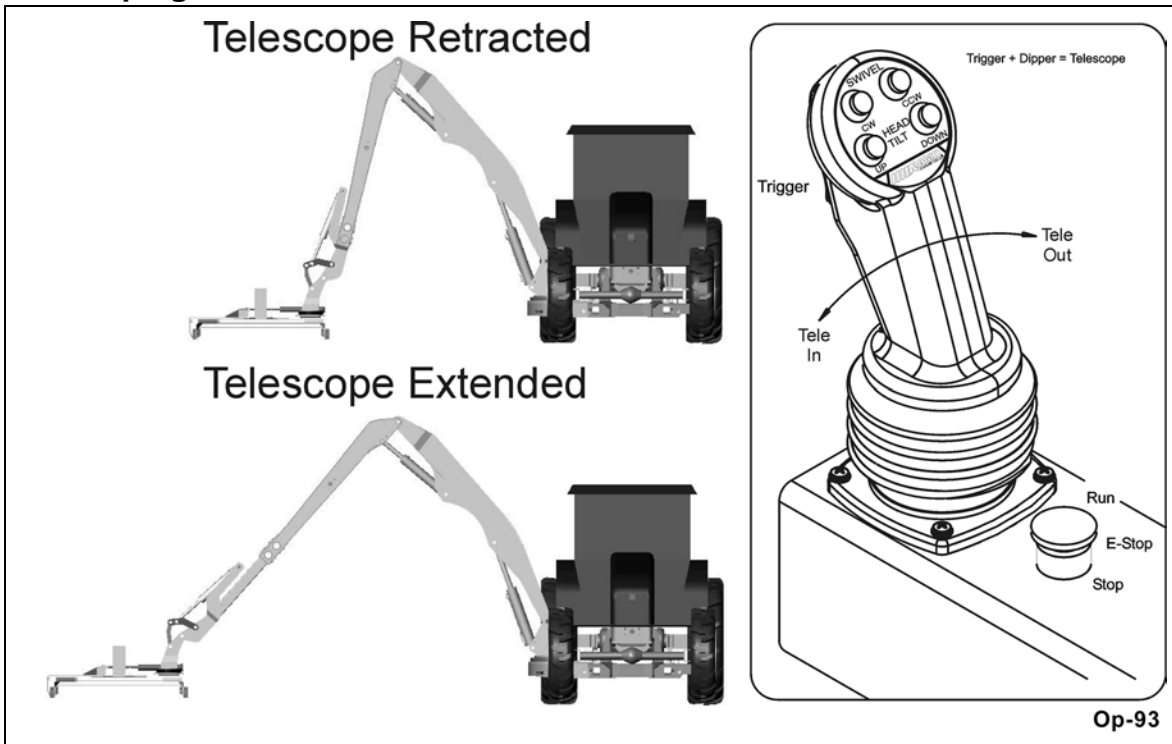

Using the trigger button in conjunction with the left and right dipper movement actuates the Telescoping Boom.

Pressing the trigger button and pushing the Joystick lever to the right causes the boom to telescope out.

Pressing the trigger button and pushing the Joystick lever to the left causes the boom to telescope in.

If the Joystick is released, the valve will automatically return to center, and the boom will be LOCKED in position.



Make certain that the Boom swing path is clear of bystanders, powerlines, and obstructions to prevent injury, electrocution, and possible machine damage. Swing Boom SLOWLY AND CAREFULLY. Avoid sudden starting and stopping. (Ops-0002-MISC)



Make certain that you do not lift the head in such a fashion that you lift the left rear wheel off the ground. Install weight as needed to keep at least 1500 lb. on the ground under left rear wheel.

# OPERATION

## 6.5 Tilt

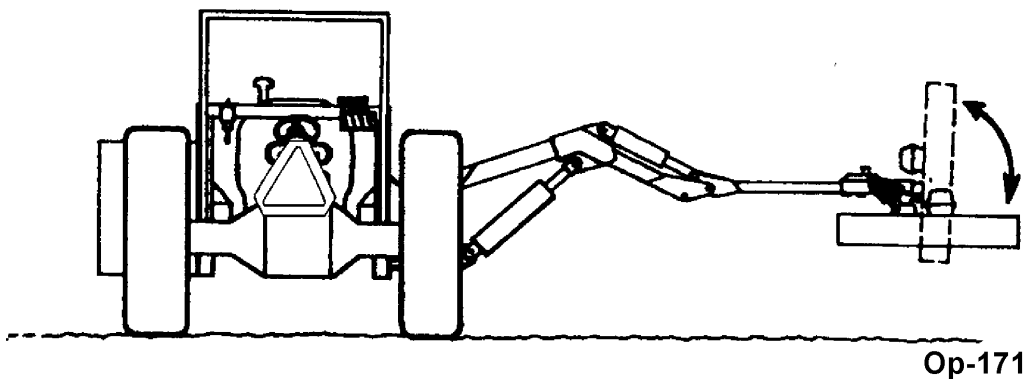

The fourth handle in the bank of four valves actuates the TILT cylinder. This valve, like the lift valve, has four positions.

Pull the valve handle backward and you will cause the outer rim (farthest from the tractor) to move UP until the mower is cutting with the blade vertical, if you wish. This feature has been used successfully for trimming hedges many feet away from the tractor.

If the handle is released, the valve will automatically return to center and the boom will be LOCKED in position.

Pushing the handle forward will move the head in the opposite direction.

Again, if the handle is released, the valve will automatically return to center and the boom will be LOCKED in position. OPS-B- 0035\_C

# OPERATION

## 7.Boom Joystick Control - Optional Equipment

### 8.OPERATING THE BOOM JOYSTICK CONTROL

Positioning the boom is performed with electronic valves controlled by the operator using a single joystick. The joystick controls five standard operations: Swing, Lift, Dipper, Head, Tilt, and Door. Of these five operations, the Swing, Lift, and Dipper functions are *proportional*; that is, when the joystick is moved a small amount, the cylinder moves slowly and as the joystick continues to be moved, the cylinder continually becomes faster. This allows very precise positioning of the boom. Using a single joystick, many of the functions can be operated simultaneously such as the Lift and Dipper for even greater speed at positioning of the boom.

For safe and efficient boom mower operation, it is critical that the operator be experienced and feel confident in using the joystick control to position the boom. New operator's should allowed ample time to practice using the joystick in an open area before entering the worksite. Before attempting to operate this equipment, read these instructions completely. If you have any questions concerning safety of operation, contact your dealer or ALAMO INDUSTRIAL.

Each joystick control and responding boom action is covered in detail on the following pages. Read each explanation carefully then practice in a safe, level area, CLEAR of all people, animals, and any obstructions. As always, use extreme caution when using this machine.

Practice performing multiple functions simultaneously. With some practice, the joystick will become very easy to operate and will feel almost as it were an extension of your arm.

With the exception of the relief valves, which are preset at the factory, these are all the controls for operating the machine other than the controls on the tractor itself.

### Master Switch

Operating any joystick function requires that the joystick Master Switch be ON. When ON the master switch indicator light will be illuminated. Turning off the master switch will deactivate all joystick controls. The master switch also serves as a safety device and will prevent the tractor from being started if the master switch is in the ON position.

OPS-B- 0030\_A

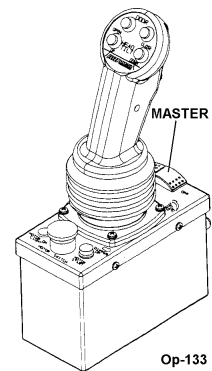

Operate the Tractor and/or Implement controls only while properly seated in the Tractor seat with the seat belt securely fastened around you. Inadvertent movement of the Tractor or Implement may cause serious injury or death. (SG-29)



# OPERATION

OPERATION

## **8.1 Mower Head Power**

ON - OFF Switches (base of the JOYSTICK)

Before attempting to start the Tractor, make certain that the Motor Switch is pushed IN to the STOP position and the Master Switch is in the OFF position to ensure that the mower head is not engaged. As a safety device, the tractor can only be started with the Master Switch in the OFF position.

### **Starting**

To Start the Motor on the Attached Head, Start the Tractor and Move the Master Switch to the ON position. Position the head in an area which is clear of any brush, grass, or any other obstruction. Pull the Motor Switch OUT until it snaps into the up position, and then press the Motor Start momentary switch to start the motor. Once the motor starts, release the momentary switch. Bring the Tractor's engine speed up to the normal operating speed of 540 PTO. The motor on light will illuminate while the mower motor is on.

The attached head motor will continue to operate while the Master Switch and the Motor Switch are in the On positions. Pushing the Motor Switch in to the STOP position or switching the Master Switch to the OFF position will stop the attached head motor.

### **Stopping**

To stop the motor on the mower head, lower the Tractor engine speed and push the Motor Switch IN to the STOP position. The mower will come to a complete stop in approximately 15 seconds. OPS-B- 0031\_A

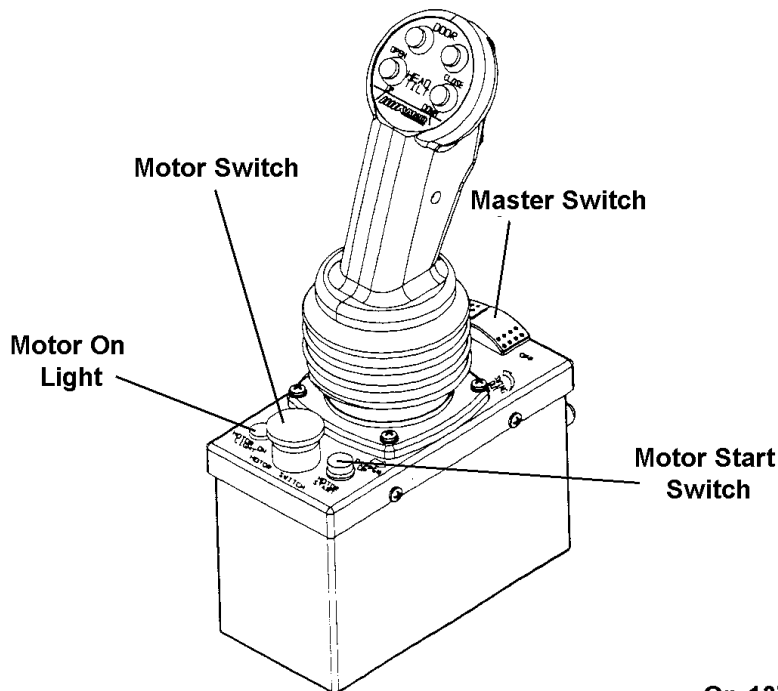

Op-137

# OPERATION

## 8.2 Swing

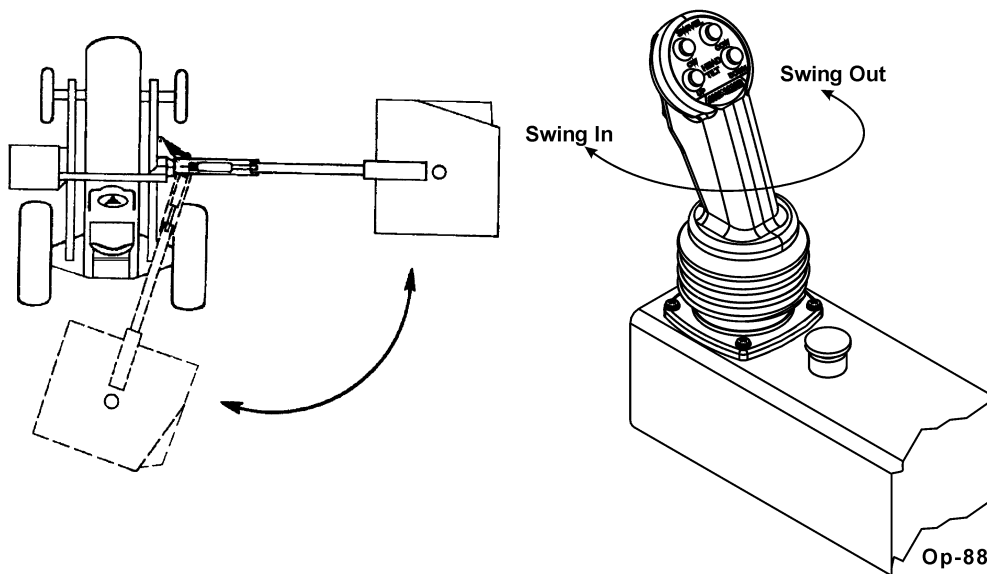

The twisting motion of the Joystick, actuates the SWING cylinder.

Twisting the Joystick Counterclockwise admits hydraulic fluid to the Butt End of the SWING cylinder, causing the boom to swing out to the right side of the tractor. (See Diagrams above)

When the Joystick is Released, the valve will automatically return to center, and the boom will be LOCKED in the current position.

Twisting the Joystick Clockwise admits hydraulic fluid to the rod end of the cylinder causing the boom to swing back toward the rear of the tractor. If the Joystick is continually held in this position pull in , the boom will continue to the left side of the tractor.

Again, if the Joystick is released, the valve will automatically return to center and the boom will be LOCKED in the current position.

**BOOM SAFETY VALVE** - If a rigid object (guard rail post, tree, etc.) is struck by the extended boom while the tractor is moving forward, the boom safety valve will allow the boom to swing rearward, and minimize the possibility of damage.

**NOTICE:** This device will NOT work if the unit is mowing BACKWARDS and the boom is in the full forward position. **SWING THE BOOM 10 DEGREES TO 15 DEGREES TO THE REAR WHEN MOVING THE TRACTOR IN REVERSE.** Mower heads are not designed to cut in reverse. OPS-B- 0032



Make certain that the Boom swing path is clear of bystanders, powerlines, and obstructions to prevent injury, electrocution, and possible machine damage. Swing Boom SLOWLY AND CAREFULLY. Avoid sudden starting and stopping. (Ops-0002-MISC)

# OPERATION

OPERATION

## 8.3 Lift

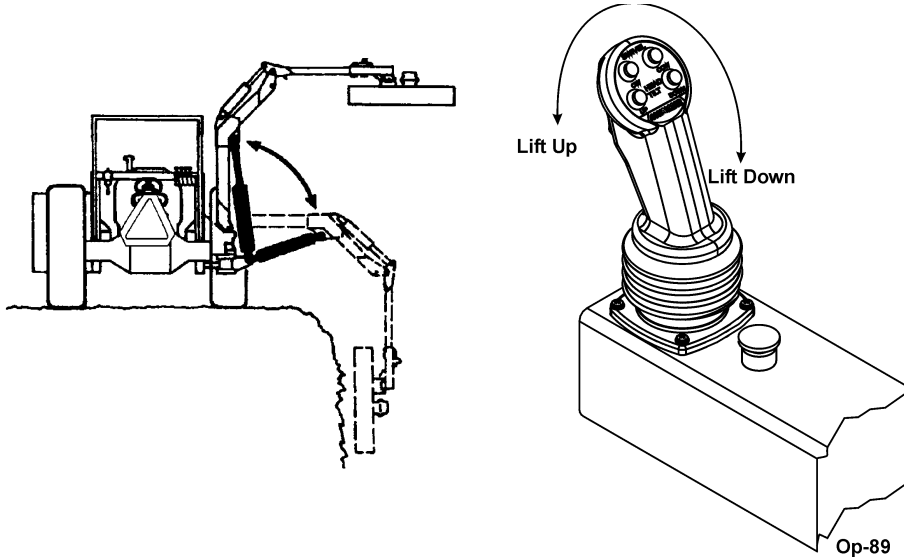

The forward and back movement of the Joystick actuates the LIFT cylinder.

Pulling the Joystick back, toward the operator, causes the boom LIFT cylinder to lift the boom arm up. Pushing the Joystick forward, causes the LIFT Cylinder to lower the Boom. If the Joystick is released, the Boom will LOCK in the position and the Joystick will return to the center position. OPS-B- 0033



Make certain that you do not lift the head in such a fashion that you lift the left rear wheel off the ground. Install weight as needed to keep at least 1500 lb. on the ground under left rear wheel.



Never Leave the mower unattended while the head is in the raised position. The mower could fall causing serious injury to anyone who might inadvertently be under the mower. (SBM-4)



# OPERATION

## 8.4 Dipper

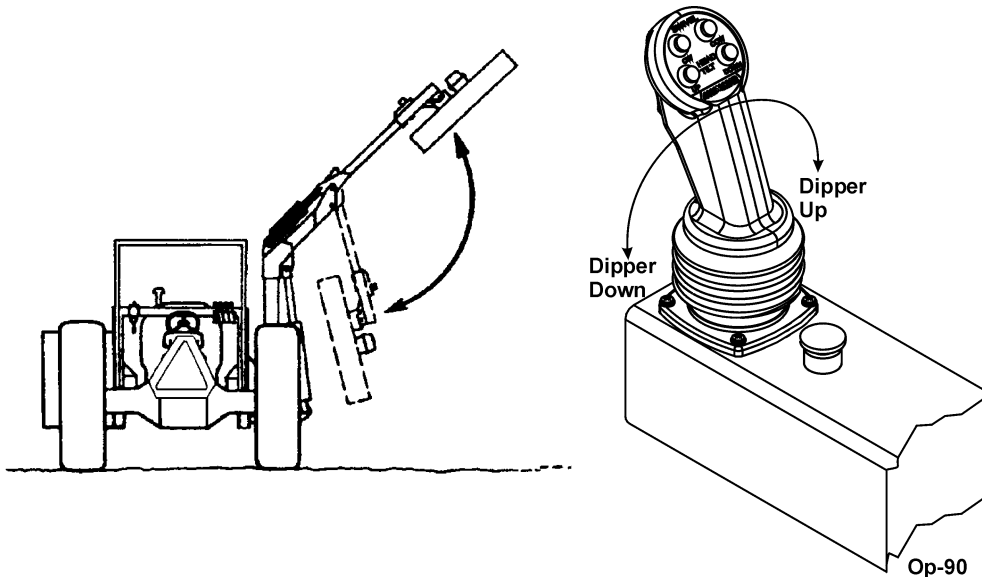

The Left and Right movement of the Joystick actuates the DIPPER cylinder.

Pushing the Joystick lever to the RIGHT causes the boom DIPPER cylinder to LIFT the small boom UP.

If the Joystick is released, the valve will automatically return to center, and the boom will be LOCKED in position.

Pushing the Joystick to the LEFT will lower the boom.

Again, if the Joystick is released, the valve will automatically return to center and the boom will be LOCKED in the current place. OPS-B- 0034



Make certain that you do not lift the head in such a fashion that you lift the left rear wheel off the ground. Install weight as needed to keep at least 1500 lb. on the ground under left rear wheel.



Make certain that the Boom swing path is clear of bystanders, powerlines, and obstructions to prevent injury, electrocution, and possible machine damage. Swing Boom SLOWLY AND CAREFULLY. Avoid sudden starting and stopping. (Ops-0002-MISC)

# OPERATION

## 8.5 Tilt

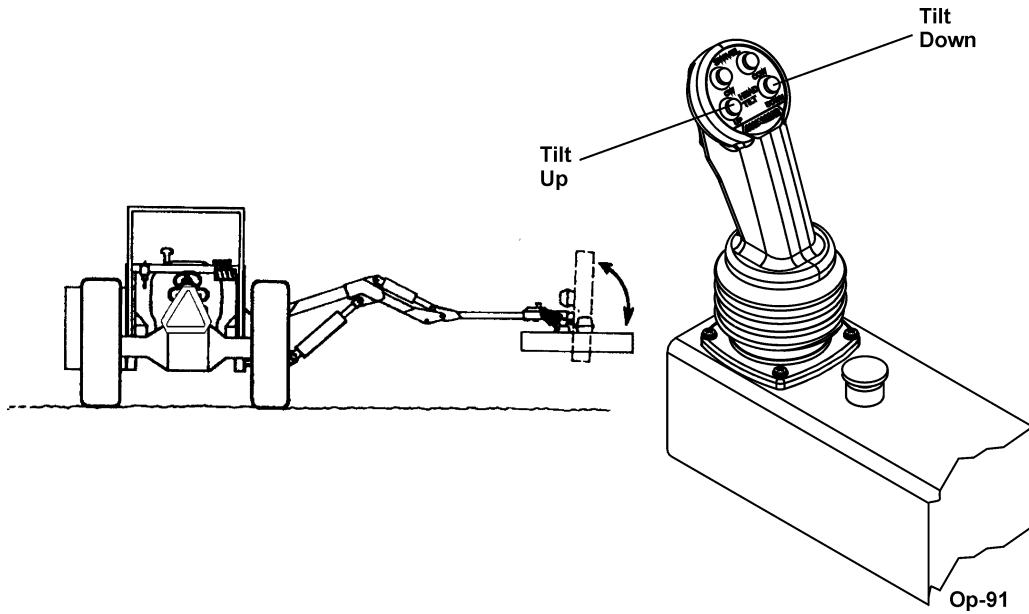

The two lower thumb buttons (Red Buttons) on the panel at the top of the joystick activates the TILT cylinder.

Pressing the left button will cause the outer rim (farthest from the tractor) to move UP.

Pressing the right button will lower the Outer Rim down.

When the Joystick's Thumb lever is released, the thumb lever will return to the center position and lock the head in the current position. OPS-B- 0035



Make certain that you do not lift the head in such a fashion that you lift the left rear wheel off the ground. Install weight as needed to keep at least 1500 lb. on the ground under left rear wheel.



Make certain that the Boom swing path is clear of bystanders, powerlines, and obstructions to prevent injury, electrocution, and possible machine damage. Swing Boom SLOWLY AND CAREFULLY. Avoid sudden starting and stopping. (Ops-0002-MISC)

# OPERATION

## 8.6 Door

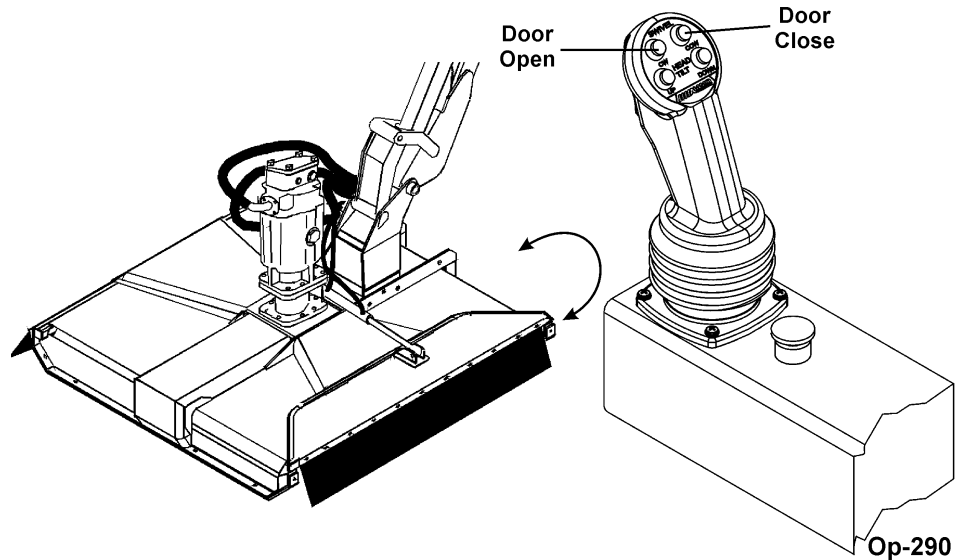

Using the trigger button in conjunction with the swivel buttons (Red Buttons) on the joystick actuates the Auxiliary Cylinder on the attached head.

Pressing the trigger button and pushing the left swivel button opens the door.

Pressing the trigger button and pushing the right swivel button closes the door.

When the buttons are released, the door will lock in current position.

OPS-B- 0038\_B

 **DANGER**

**SAFETY SHIELD & DEFLECTOR OPERATION**



**SAFETY SHIELD**

**DEFLECTOR**

- Failure to close Safety Shield and Deflector may allow objects to be thrown outward with great force which can cause property damage, bodily injury, or death.
- 1. Keep Safety Shield and Deflector fully closed when cutting grass and weeds to reduce possibility of objects being thrown outward by the Blades if persons are in the area.
- 2. Before Cutting brush, trimming limbs, or other such operations, raise the Deflector and Safety Shield fully to allow the blades to contact the material if area is clear of passerby. Operator must stop cutting and close shield if passerby enters the thrown objects area or blade contact area.
- 3. Repair or replace Safety Shield and Deflectors as needed.
- 4. Always transport with Safety Shield and Deflector closed.

02967867

# OPERATION

OPERATION

## OPTIONAL

### 8.7 Head Swivel

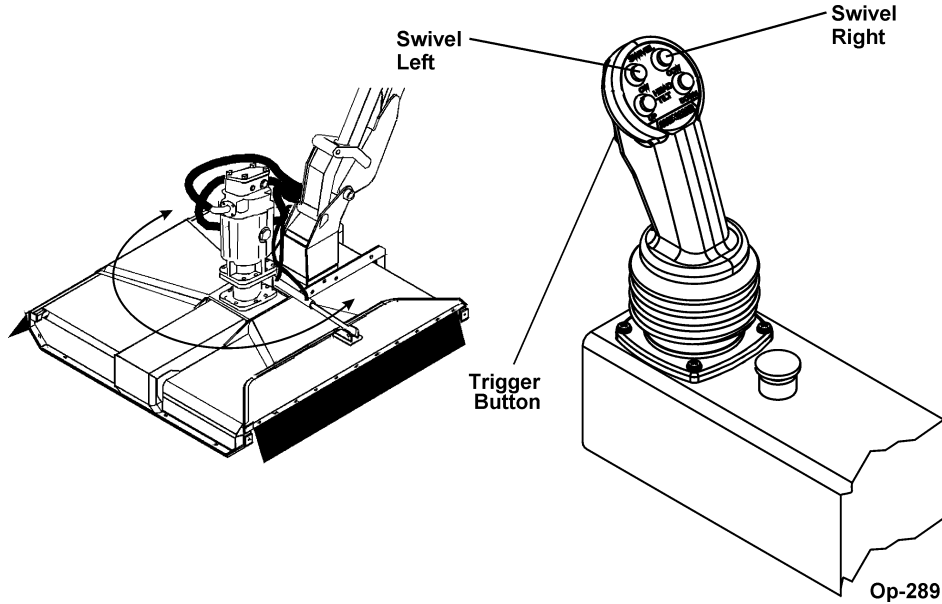

The two upper buttons (Red Buttons) on the panel at the top of the joystick actuates the head swivel on the attached head.

Pressing the left button swivels the head to the left.

Pressing the right button swivels the head to the right.

OPS-B- 0036\_A



Make certain that the Boom swing path is clear of bystanders, powerlines, and obstructions to prevent injury, electrocution, and possible machine damage. Swing Boom SLOWLY AND CAREFULLY. Avoid sudden starting and stopping. (Ops-0002-MISC)

# OPERATION

## 9. DRIVING THE TRACTOR AND IMPLEMENT

Safe tractor transport requires the operator to possess a thorough knowledge of the model being operated and precautions to take while driving with an attached implement. Ensure the tractor has the capacity to handle the weight of the boom and the tractor operating controls are set for safe transport. To ensure safety while driving the tractor with a boom, review the following.

Read all safety instructions. Decals on the Boom warn you of particular and multiple hazards. Some decals are attached close to part of the Boom where there is a possible hazard. Read and make sure you understand the safety messages before you operate the implement. Keep all decals clean and readable. Replace lost or damaged decals, refer to safety section for more information.

Power for operating the mower is supplied from the tractor PTO. Refer to your tractor manual instructions for engaging and disengaging the PTO. Start the tractor and bring the engine speed up to normal operating 540 PTO speed. Always engage the PTO at low engine RPM and run the mower for a short period until all air is removed from the hoses. Keep all person's well clear of mower since blades can throw objects with great velocity for a considerable distance! KEEP CLEAR! OPS-B- 0005



Never operate the Tractor or Implement until you have read and completely understand this Manual, the Tractor Operator's Manual, and each of the Safety Messages found in the Manual or on the Tractor and Implement. Learn how to stop the tractor engine suddenly in an emergency. Never allow inexperienced or untrained personnel to operate the Tractor and Implement without supervision. Make sure the operator has fully read and understood the manuals prior to operation.

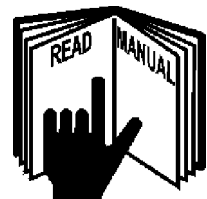

(SG-4)



Always maintain the safety signs in good readable condition. If the safety signs are missing, damaged, or unreadable, obtain and install replacement safety signs immediately. (SG-5)



BEFORE leaving the tractor seat, always engage the brake and/or set the tractor transmission in parking gear, disengage the PTO, stop the engine, remove the key, and wait for all moving parts to stop. Place the tractor shift lever into a low range or parking gear to prevent the tractor from rolling. Never dismount a Tractor that is moving or while the engine is running. Operate the Tractor controls from the tractor seat only. (SG-9)

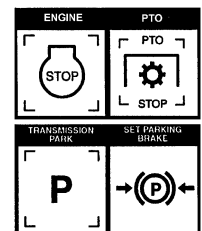



# OPERATION

## **WARNING**

Transport only at speeds where you can maintain control of the equipment. Serious accidents and injuries can result from operating this equipment at high speeds. Understand the Tractor and Implement and how it handles before transporting on streets and highways. Make sure the Tractor steering and brakes are in good condition and operate properly.



Before transporting the Tractor and Implement, determine the proper transport speeds for you and the equipment. Make sure you abide by the following rules:

Test the tractor at a slow speed and increase the speed slowly. Apply the Brakes smoothly to determine the stopping characteristics of the Tractor and Implement. As you increase the speed of the Tractor the stopping distance increases. Determine the maximum transport speed not to exceed 20 mph (30 kph) for transporting this equipment.

Test the equipment at a slow speed in turns. Increase the speed through the turn only after you determine that the equipment can be operated at a higher speed. Use extreme care and reduce your speed when turning sharply to prevent the tractor and implement from turning over. Determine the maximum turning speed for you and this equipment before operating on roads or uneven ground.



Only transport the Tractor and Implement at the speeds which allow you to properly control the equipment.

Be aware of the operating conditions. Do not operate the Tractor with weak or faulty brakes or worn tires. When operating down a hill or on wet or rain slick roads, the braking distance increases: use extreme care and reduce your speed. When operating in traffic always use the Tractor's flashing warning lights and reduce your speed. Be aware of traffic around you and watch out for the other guy. (SG-19)

## **9.1 Starting the Tractor**

The procedure to start the tractor is model specific. Refer to the tractor operator's manual for starting procedures for your particular tractor. Consult an authorized dealer if the starting procedure is unclear. Ensure the 3-point control lever is in the lowered position and the PTO is disengaged before starting the tractor. OPS-U-0033



# OPERATION

## **9.2 Brake and Differential Lock Setting**

Make sure the tractor brakes are in good operating condition. Tractor brakes can be set to operate independently allowing single rear wheel braking action or locked together to provide simultaneous rear wheel braking. FOR MOST DRIVING AND OPERATING CONDITIONS, THE BRAKE PEDALS SHOULD BE LOCKED TOGETHER TO PROVIDE THE MOST EFFECTIVE BRAKING ACTION.

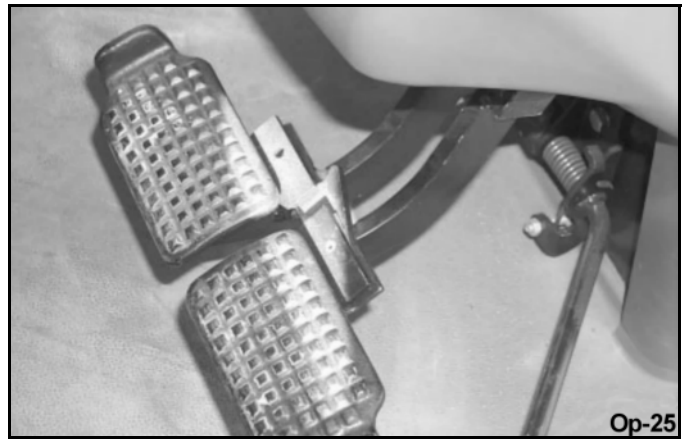

Always disengage the tractor differential lock when turning. When engaged the differential lock will prevent or limit the tractor from turning. During normal cutting conditions, locking the differential provides no benefit and should not be used. OPS-U- 0013



Be aware of the operating conditions. Do not operate the Tractor with weak or faulty brakes.



Be aware of the operating conditions. Do not operate the Tractor with weak or faulty brakes. When operating down a hill or on wet or rain slick roads, the braking distance increases; use extreme care and reduce your speed in these conditions. When operating in traffic, always use the Tractor's flashing warning lights and reduce your speed. Be aware of traffic around you and watch out for the other guy. (Ops-0004-MISC)



BEFORE leaving the tractor seat, always engage the brake and/or set the tractor transmission in parking gear, disengage the PTO, stop the engine, remove the key, and wait for all moving parts to stop. Place the tractor shift lever into a low range or parking gear to prevent the tractor from rolling. Never dismount a Tractor that is moving or while the engine is running. Operate the Tractor controls from the tractor seat only. (SG-9)

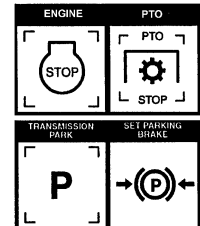

# OPERATION

## 9.3 Driving the Tractor and Boom

Start off driving at a slow speed and gradually increase your speed while maintaining complete control of the tractor. Never operate the tractor at speeds that cannot be safely handled or which will prevent the operator from stopping quickly during an emergency. If the power steering or engine ceases operating, stop the tractor immediately as the tractor will be difficult to control.

Perform turns with the tractor and mower at slow speeds to determine how the tractor with and attached implement handles a turn. Determine the safe speed to maintain proper control of the tractor when making turns. When turning with the implement the overall working length and width of the unit is increased. Allow additional clearance for the unit when turning or when passing large obstructions.

To avoid overturns, drive the tractor with care and at safe speeds, especially when operating over rough ground, crossing ditches or slopes, and turning corners. Use extreme caution when operating on steep slopes. Keep the tractor in a low gear when going downhill. DO NOT coast or free-wheel downhill.

OPS-B- 0006



**WARNING** Never Leave the mower unattended while the head is in the raised position. The mower could fall causing serious injury to anyone who might inadvertently be under the mower. (SBM-4)



**DANGER** Always keep a careful lookout and use extreme care when working around overhead obstructions. Never allow the Mower head or boom within 10 feet of any power line. When working close to overhead power lines consult your electric company for a safe code of operation. (SBM-7)

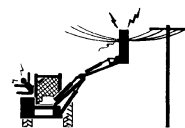

# OPERATION

## **10.OPERATING THE BOOM UNIT AND ATTACHED HEAD**

**THE OPERATOR MUST COMPLETELY UNDERSTAND HOW TO OPERATE THE TRACTOR AND MOWER AND ALL CONTROLS BEFORE ATTEMPTING TO MOW.** The operator must read and understand the Safety and Operation Sections of this manual and the tractor operator's manuals. These manuals must be read and explained to any operator who cannot read. Never allow someone to operate the unit without complete operating instructions.

To ensure safety to the operator, bystanders, and equipment and before starting any mowing operation. The operator must become familiar with the area to be mowed, and any obstacles and hazards contained within. Special attention should be paid to foreign debris, overhead obstructions, rough terrain, steep slopes, passersby and animals in the area.

Only operate the mower head from the tractor operator's seat with the seatbelt securely fastened. Only operate a boom and equipped head on cabbed tractor that is equipped with a Lexan® protected right side window or a non cabbed tractor equipped with a ROPS and operator safety screen.

Avoid operating in the reverse direction when possible. In situations where the boom and mower must be backed to access areas to be cut, make sure there are no persons or other foreign debris behind the tractor. When backing, operate the tractor at a much reduced ground speed to ensure complete control of the unit is maintained. *OPS-B- 0007*



Do not mow with two machines in the same area except with Cab tractors with the windows closed. (SGM-11)



Mow only in conditions where you have clear visibility in daylight or with adequate artificial lighting. Never mow in darkness or foggy conditions where you cannot clearly see at least 100 yards(90 m) in front and to the sides of the tractor and mower. Make sure that you can clearly see and identify passersby, steep slopes, ditches, drop-offs, overhead obstructions, power lines, debris and foreign objects. If you are unable to clearly see these type of items discontinue mowing. (SGM-1)



Avoid mowing in reverse direction when possible. Check to make sure there are no persons behind the mower and use extreme care when mowing in reverse. Mow only at a slow ground speed where you can safely operate and control the tractor and mower. Never mow an area that you have not inspected and removed debris or foreign material. (SGM-08)



Never operate the mower head tilted down where the operator can see the blades of the mower. The blade could throw an object toward the operator causing serious injury or death. Never operate the mower without an Operator Protective Structure. Always wear safety glasses and a hard hat. (Ops-0005-MISC)

# OPERATION

## 10.1 Foreign Debris Hazards/Overhead Obstructions

An area to be cut must first be inspected for objects that could be thrown or that could damage the machine. Walk through the area looking for fences, boulder, rocks, culverts, stumps or metal objects. Mark the inspected area with flags. If the area is dense and cannot be walked thoroughly it may be necessary to inspect a smaller area as well as possible, then trim away the part that has been inspected and can safely be removed. Walk each new area again and repeat the inspection before cutting more away. Repeat as often as necessary until the area is cleared. It can be damaging and/or dangerous to work the cutter in an area that had not been visually inspected.

Place DANGER signs at least 300 feet beyond the perimeter of the area to be worked, not just 300 feet from where the machine started operating! It is convenient in many cases to work in 300 foot sections. Move the first Danger sign to the beginning of the freshly cleared area, place it, then take the first cutting area flag up to the end of the freshly cleared area 300 feet away. Walk and inspect the next 300 feet and place the second cutting area flag. Pick up the second DANGER sign, and take it a further 300 feet along the road or trail. Note that in many cases the DANGER area will extend in front of and behind the machine as well as along each side. Post signs accordingly. OPS-B- 0008



Extreme care should be taken when operating near loose objects such as gravel, rocks, wire, and other debris. Inspect the area before mowing. Foreign objects should be removed from the site to prevent machine damage and/or bodily injury or even death. Any objects that cannot be removed must be clearly marked and carefully avoided by the operator. Stop mowing immediately if blades strike a foreign object. Repair all damage and make certain rotor or blade carrier is balanced before resuming mowing. (SGM-05)



Many varied objects, such as wire, cable, rope, or chains, can become entangled in the operating parts of the mower head. These items could then swing outside the housing at greater velocities than the blades. Such a situation is extremely hazardous and could result in serious injury or even death. Inspect the cutting area for such objects before mowing. Remove any like object from the site. Never allow the cutting blades to contact such items. (SGM-06)



Mow at the speed that you can safely operate and control the tractor and mower. The correct mowing speed depends on terrain condition and grass type, density, and height of cut. Normal ground speed range is from 2 to 5 mph(3-8 kph). Use slow mowing speeds when operating on or near steep slopes, ditches, drop-offs, overhead obstructions, power lines, or when debris and foreign objects are to be avoided. (SGM-07)

# OPERATION

## 10.2 Operating Speed and Ground Speed

Ground speed for mowing will depend upon the height, type, and density of vegetation to be cut. Do Not exceed 2 MPH while operating. Operate the mower at its full rated PTO speed to maintain blade speed for a clean cut. Refer to the tractor operator's manual or the tractor instrument panel for the engine speed and gear to provide the required operating and desired ground speed. Make sure that the mower is operating at its full rated speed before entering the vegetation to be cut. Always start and stop cutting blades with engine near idle.

Ground speed is achieved by transmission gear selection and not by the engine operating speed. The operator may be required to experiment with several gear range combinations to determine the best gear and range which provides the most ideal performance from the implement and most efficient tractor operation. As the severity of cutting conditions increase, the ground speed should be decreased by selecting a lower gear to maintain the proper operating PTO speed. *OPS-B- 0009*



Mow at the speed that you can safely operate and control the tractor and mower. The correct mowing speed depends on terrain condition and grass type, density, and height of cut. Normal ground speed range is from 2 to 5 mph(3-8 kph). Use slow mowing speeds when operating on or near steep slopes, ditches, drop-offs, overhead obstructions, power lines, or when debris and foreign objects are to be avoided. (SGM-07)

## 10.3 Operating the Attached Mower Heads

The boom can attach to and operate multiple heads one at a time for a wide range of vegetation control applications. The attached heads are designed for different applications. The head should be selected based on the mowing application and the location that the unit is being operated.

Refer to the Assembly Section of this manual to ensure the head is properly attached to the boom hitch and hydraulic lines are properly connected. *OPS-B- 0010*



There are obvious and hidden potential hazards in the operation of this Mower. REMEMBER! This machine is often operated in heavy brush and in heavy weeds. The Blades of this Mower can throw objects if shields are not properly installed and maintained. Serious injury or even death may occur unless care is taken to insure the safety of the operator, bystanders, or passersby in the area. Do not operate this machine with anyone in the immediate area. Stop mowing if anyone is within 100 yards of mower. (SGM-02)



# OPERATION

## Rotary Cutter

- The Rotary Cutting Head is rated to cut vegetation up to 5" in diameter.
- Objects tend to be thrown out from under the head in the direction of blade rotation and toward the raised edge of the shroud. Avoid cutting with the head tilted at an angle that objects would be thrown towards the unit operator position.
- When clearing brush and small trees, operate unit at 1 mph ground speed and position cutter head at an angle that will cut 2' to 3' into the growth. Make the first pass just above ground level. This will remove the low branches and allow operator a better view of the material to plan for the next pass. After repeated passes, each elevated approximately 4' above the last, the main trunks of the trees will be exposed and they can be cut as desired. This avoids clogging the head with cut and mulched material.
- Open the hydraulically operated door to allow blades to reach large diameter vegetation. Operate the mower with the door closed when cutting grass, weeds, and light brush to reduce thrown objects for safer mower operation.
- When operating near the ground or when mulching be particularly careful that there are no bystanders or animals with a 100 yards. Debris tends to fly out at great speed and can injure or even cause death.



OPS-B- 0039

### **⚠ DANGER**

The rotating parts of this machine have been designed and tested for rugged use. However, the blades could fail upon impact with heavy, solid objects such as metal guard rails and concrete structures. Such impact could cause the broken objects to be thrown outward at very high velocities. To reduce the possibility of property damage, serious injury, or even death, never allow the cutting blades to contact such obstacles. (SGM-4)

### **⚠ DANGER**

All Safety Shields, Guards and Safety devices including (but not limited to) - the Deflectors, Chain Guards, Steel Guards, Gearbox Shields, PTO integral shields, and Retractable Door Shields should be used and maintained in good working condition. All safety devices should be inspected carefully at least daily for missing or broken components. Missing, broken, or worn items must be replaced at once to reduce the possibility of injury or death from thrown objects, entanglement, or blade contact. (SGM-3)

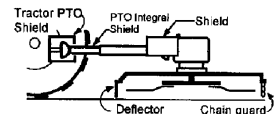



# OPERATION

## **WARNING**

Many varied objects, such as wire, cable, rope, or chains, can become entangled in the operating parts of the mower head. These items could then swing outside the housing at greater velocities than the blades. Such a situation is extremely hazardous and could result in serious injury or even death. Inspect the cutting area for such objects before mowing. Remove any like object from the site. Never allow the cutting blades to contact such items.

(SGM-06)

## **Grass Flail**

- The Grass Flail head is rated for cutting grass only.
- The Grass Flail operates attached to the boom arm, and is ideal for cutting hard to reach areas where a smooth cut is required.
- Cutting height ranges from 3/4" to 4" in vegetation. Cutting height is set by adjusting the height of the roller assembly.
- When operating near the ground or when mulching be particularly careful that there are no bystanders or animals with a 100 yards. Debris tends to fly out at great speed and can injure or even cause death.

OPS-B- 0040



## **Flail**

- The Flail Brush Cutter is rated to cut material up to 4" in diameter.
- Setting cutting height ranges from 3/4" to 6". Cutting height is set by adjusting the height of the roller assembly.
- Remove roller assembly when cutting limbs and other large diameter vegetation (greater than 2") to prevent damaging the roller assembly.
- When operating near the ground or when mulching be particularly careful that there are no bystanders or animals within a 100 yards. Debris tends to fly out at great speed and can injure or even cause death. OPS-B- 0042



## **WARNING**

Many varied objects, such as wire, cable, rope, or chains, can become entangled in the operating parts of the mower head. These items could then swing outside the housing at greater velocities than the blades. Such a situation is extremely hazardous and could result in serious injury or even death. Inspect the cutting area for such objects before mowing. Remove any like object from the site. Never allow the cutting blades to contact such items.

(SGM-06)



# OPERATION

## OPERATION

### BuzzBar® Tree Limb Cutter

- The BuzzBar Tree Limb Cutter is rated for material up to 4" in diameter.
- Suggested cutting Speed for the Buzzbar is 1st gear. Slow down for thick, dense, or hard material.
- Always cut with the boom positioned perpendicular to the limbs being cut (see diagram). Cutting with the boom swing backward or forward will cause the blades to warp from "raking" through the cut material.
- For maximum blade life, do not allow the blades to contact hard items such as the ground or metal objects.
- Check belt tension daily. If belts start to slip adjust tension soon. The more belt slippage, the more they will wear and looser they become.
- Grease bearings of saw blade spindles daily.
- Two pumps from hand grease gun.
- When operating the unit be sure there are no bystanders or animals within 100 yards of the unit.

OPS-B- 0043



**IMPORTANT!** Always cut with boom positioned perpendicular (straightout) from the tractor.

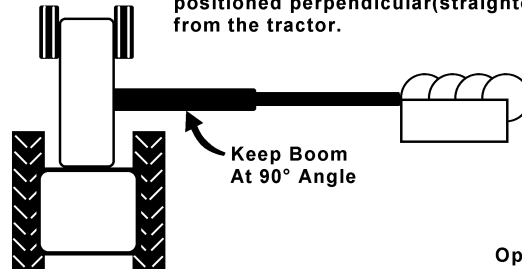

### Timber Cat

- The Timber Cat Sickle Bar Limb Cutter is rated for material up to 4" in diameter.
- The Timber Cat is operated attached to the boom arm and is ideal for trimming populated areas where a smooth cut is required.
- When operating the Timber Cat correctly the limbs fall straight down for easy disposal and clean-up.
- When operating the unit be sure there are no bystanders or animals within 100 yards of the unit.

OPS-B- 0044



# OPERATION

## Sickle Bar

- The Sickle Bar Cutter will cut a 5' swath through tough weeds and grass.
- The Sickle Bar Cutter is operated attached to the boom arm and is ideal for vegetation maintenance
- When operating the Sickle Bar correctly it will give you a fast, efficient, and cost-effective method of vegetation maintenance.
- The Sickle Bar will also cut vegetation through tough weeds under water, ideal for maintaining ponds, creeks, and other areas that may be under shallow water.
- When operating the unit be sure there are no bystanders or animals within 100 yards of the unit.



OPS-B- 0049



The rotating parts of this machine have been designed and tested for rugged use. However, the blades could fail upon impact with heavy, solid objects such as metal guard rails and concrete structures. Such impact could cause the broken objects to be thrown outward at very high velocities. To reduce the possibility of property damage, serious injury, or even death, never allow the cutting blades to contact such obstacles. (SGM-4)

# OPERATION

## 10.4 Shutting Down the Attached Head- For Standard Equipment

To shut down attached mower head, first bring the tractor to a complete stop. Decrease engine RPM to idle then disengage cutterhead. The mower head will come to a complete stop within a suitable amount of time. Do not engage or disengage the cutterheads at a high RPM unless there is an emergency situation.



Park the tractor on a level surface, place the transmission in park or neutral and apply the parking brake, shut down the engine, remove the key, and wait for all motion to come to a complete stop before exiting the tractor. OPS-B- 0011\_D



BEFORE leaving the tractor seat, always engage the brake and/or set the tractor transmission in parking gear, disengage the PTO, stop the engine, remove the key, and wait for all moving parts to stop. Place the tractor shift lever into a low range or parking gear to prevent the tractor from rolling. Never dismount a Tractor that is moving or while the engine is running. Operate the Tractor controls from the tractor seat only. (SG-9)

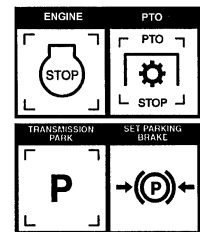

# OPERATION

## 10.5 Shutting Down the Attached Head - For (Optional Equipment)

To shut down attached mower head, first bring the tractor to a complete stop. Decrease engine RPM to idle then disengage cutterhead. The mower head will come to a complete stop within a suitable amount of time. Do not engage or disengage the cutterheads at a high RPM unless there is an emergency situation.



Park the tractor on a level surface, place the transmission in park or neutral and apply the parking brake, shut down the engine, remove the key, and wait for all motion to come to a complete stop before exiting the tractor. OPS-B- 0011\_C



BEFORE leaving the tractor seat, always engage the brake and/or set the tractor transmission in parking gear, disengage the PTO, stop the engine, remove the key, and wait for all moving parts to stop. Place the tractor shift lever into a low range or parking gear to prevent the tractor from rolling. Never dismount a Tractor that is moving or while the engine is running. Operate the Tractor controls from the tractor seat only. (SG-9)

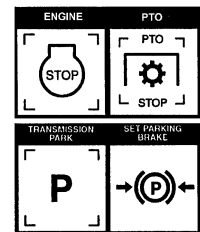

OPERATION



# OPERATION

## 11. TRACTOR, BOOM, AND ATTACHED HEAD STORAGE

Properly preparing and storing the unit at the end of the season is critical to maintaining its appearance and to help ensure years of dependable service. The following are suggested storage procedures:

- Thoroughly clean all debris from boom and head to prevent damage from rotting grass and standing water.
- Lubricate all grease points and fill oil levels according to the maintenance lubrication schedule.
- Tighten all bolts to the proper torque. Ensure all pins and other hardware are in place.
- Check the boom arm and head for worn and damaged parts. Perform repairs and make replacements so that the mower will be ready for use at the start of the next season.
- Store the unit in a clean and dry location.
- Use spray touch-up enamel where necessary on bare metal surfaces to prevent rust and to maintain the appearance of the mower.



OPS-B- 0012\_C



Never allow children to play on or around Tractor or Implement. Children can slip or fall off the Equipment and be injured or killed. Children can cause the Implement to shift or fall crushing themselves or others. (SG-25)



BEFORE leaving the tractor seat, always engage the brake and/or set the tractor transmission in parking gear, disengage the PTO, stop the engine, remove the key, and wait for all moving parts to stop. Place the tractor shift lever into a low range or parking gear to prevent the tractor from rolling. Never dismount a Tractor that is moving or while the engine is running. Operate the Tractor controls from the tractor seat only. (SG-9)

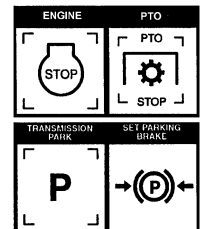

Perform service, repairs and lubrication according to the maintenance section. Ensure the unit is properly lubricated as specified in the lubrication schedule and all bolts and nuts are properly torqued. Failure to properly service, repair and maintain this Implement in good operating condition could cause component failure and possible serious injury or even death. (SG-35)

## 12. TRANSPORTING THE TRACTOR AND IMPLEMENT

Inherent hazards of operating the tractor and implement and the possibility of accidents are not left behind when you finish working in an area. Therefore, the operator must employ good judgement and safe operation practices when transporting the tractor and implement between locations. By using good judgement and following safe transport procedures, the possibility of accidents while moving between locations can be substantially minimized. OPS-U- 0017

# OPERATION

## **13.Placing Boom Arm on Boom Arm Rest - For Standard Equipment**

Before transporting tractor between locations, idle the tractor engine, disengage the attached head, and wait for all head motion to come to a complete stop. Place the boom in its storage cradle rest support and then turn the joystick master switch to the OFF position.



- Placing Boom Articulating Arm on Boom Arm Rest
- Extend the dipper section approximately half way out.
- Bring the Lift to its full height and carefully swing the boom back until it is just positioned over the Boom Rest. NOTE: There is a formed "V" plate on the boom arm that fits onto the boom arm rest.
- Lower the boom arm until this "V" rest on the Boom Rest.
- Place the Master Switch in to the OFF position. The boom is now in the transport position. To remove the boom from the Boom Rest, pull the Lift back and raise the boom about 6 inches. Then Swing the boom around to the desired position.



OPS-B- 0013\_D



Never allow children or other persons to ride on the Tractor or Implement. Falling off can result in serious injury or death. (SG-10)



# OPERATION

OPERATION

## 14.Placing Boom Arm on Boom Arm Rest - For Optional Equipment

Before transporting tractor between locations, idle the tractor engine, disengage the attached head, and wait for all head motion to come to a complete stop. Place the boom in its storage cradle rest support and then turn the joystick master switch to the OFF position.



Placing Boom Articulating Arm on Boom Arm Rest

- Extend the dipper section approximately half way out.
- Bring the Lift to its full height and carefully swing the boom back until it is just positioned over the Boom Pin Rest. NOTE: There is a formed pin on the dipper section that fits onto the Boom Arm Lug Rest.
- Lower the Lift until the Boom Arm Lug Rest on the Boom Pin Rest (this may take some re-adjustment of the dipper section).
- Use your joystick to swivel the head to the lefthand side so that the head is aligned with the tractors width (this prevents the head from protruding from the side of the tractor).
- Place the Master Switch in to the OFF position.

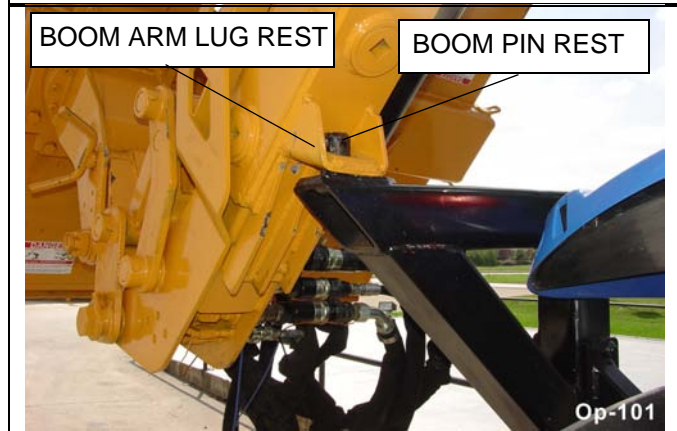

The boom is now in the transport position. To remove the boom from the Boom Rest, pull the Lift back and raise the boom about 6 inches. Then Swing the boom around to the desired position. OPS-B- 0013\_C

Before transporting the tractor on a public roadway or boarding a trailer for transport, the tractor brake pedals should be locked together. Locking the pedals ensures that both wheels brake simultaneously while stopping, especially when making an emergency stop.

Use extreme caution and avoid hard applications of the tractor brakes when towing heavy loads at road speeds. Never tow the implement at speeds greater than 20 MPH (25 kph). OPS-U- 0018

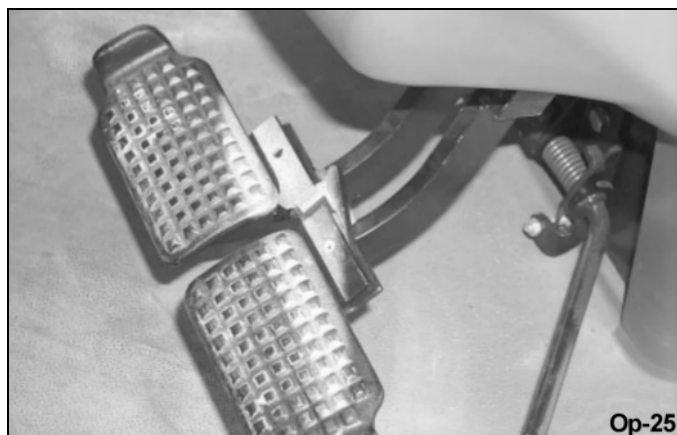

# OPERATION

## **14.1 Transporting on Public Roadways**

Extreme caution should be used when transporting the tractor and mower on public roadways. The tractor must be equipped with all required safety warning features including a SMV emblem and flashing warning lights to alert drivers of the tractor's presence. Remember that roadways are primarily designed for automotive drivers and most drivers will not be looking out for you, therefore, you must look out for them. Check your side view mirrors frequently and remember that vehicles will approach quickly because of the tractor's slower speed. Be extremely cautious when the piece of equipment that you are towing, is wider than the tractor tire width and/or extends beyond your lane of the road. *OPS-B- 0014*

The SMV (Slow-Moving Vehicle) emblem is universal symbol used to alert drivers of the presence of equipment traveling on roadways at a slow speed. SMV signs are a triangular bright orange with reflective red trim for both easy day and night visibility. Make sure the SMV sign is clean and visible from the rear of the unit before transporting the tractor and implement on a public roadway. Replace the SMV emblem if faded, damaged, or no longer reflective. *OPS-U- 0020*



Make sure that all tractor flashing warning lights, headlights, and brake/taillights are functioning properly before proceeding onto public roads. While newer model tractors have plenty of lighting to provide warning signals and operating lighting, most older models were only equipped with operating lights. Consult an authorized tractor dealer for lighting kits and modifications available to upgrade the lighting on older tractor models. *OPS-B- 0015*





# OPERATION

When operating on public roads, have consideration for other road users. Pull to the side of the road occasionally to allow all following traffic to pass. Do not exceed the legal speed limit set in your country for agricultural tractors. Always stay alert when transporting the tractor and mower on public roads. Especially in busy cities, the boom extends to right farther than the tractor's width, so be careful there are no bystanders, poles, large obstructions or any vehicles that may be in path of the mower head on boom. Use caution and reduce speed if other vehicles or pedestrians are in the area. OPS-B-0016



**⚠ DANGER**

When transporting Boom Mower on a truck or trailer, the height or width may exceed legal limits when the boom is in the transport position. Contact with side or overhead structures or power lines can cause property damage or serious injury or death. If necessary lower boom to reduce height and/or remove mowing head to reduce width to the legal limits. (SBM-8)

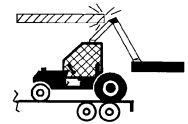

**⚠ DANGER**

Never allow children or other persons to ride on the Tractor or Implement. Falling off can result in serious injury or death. (SG-10)



**⚠ WARNING**

Make certain that the "Slow Moving Vehicle" (SMV) sign is installed in such a way as to be clearly visible and legible. When transporting the Equipment use the Tractor flashing warning lights and follow all local traffic regulations. (SG-6)

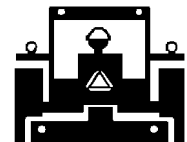

Reduce speed before turning or applying the brakes. Ensure that both brake pedals are locked together when operating on public roads. OPS-U-0023

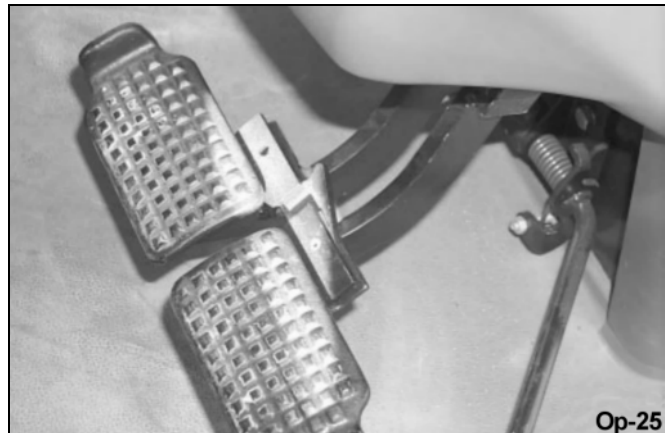

# OPERATION

## **14.2 Hauling the Tractor and Implement**

Before transporting a loaded tractor and implement, measure the height and width dimensions and gross weight of the complete loaded unit. Ensure that the load will be in compliance with the legal limits set for the areas that will be traveled through. *OPS-U- 0024*



Use adequately sized and rated trailers and equipment to transport the tractor and implement. Consult an authorized dealer to determine the proper equipment required. Using adequately sized chains, heavy duty straps, cables and/or binders, securely tie down both the front and rear of the tractor utilizing the proper tie down locations as specified by the tractor manufacturer. *OPS-U- 0025*



Arrange the chains so that when tightened, the chains are pulling downward and against themselves. Carefully tighten the securing chains or other fasteners using boomers or binders to apply maximum tension. Use extreme care when attaching and removing the securing devices as the extreme tension involved when released has the potential to inflict serious injury.

While hauling the tractor and implement, make occasional stops to check that the tractor and implement have not moved or shifted and that the securing chains have maintained tension. If during transport a hard braking, sharp turning, or swerving action was performed, stop at the next safe location to inspect the security of the load. *OPS-U- 0026*





# **MAINTENANCE SECTION**

Maintenance Section 4-1

# MAINTENANCE

## Lubrication Information

Before operating your Implement, take the time to inspect and repair any damage to the machine or tractor. Only a minimum of time and effort is required to regularly maintain this machine to provide long life and trouble free operation.

### **BOOM ARM:**

Your Boom uses greased bushings that need lubrication, with proper lubrication should last the lifetime of the machine.

### **MOWER HEAD:**

The Spindle Housing on the Mower head should be serviced daily (every eight hours of operation) to achieve the best operation and the longest life. Fill with NLGI EP#2 Grease.

### **DRIVELINE:**

The driveline powering the hydraulic system may have a universal joint at each end. Check you tractor and locate the grease points on the driveline that is connected from the front engine pulley to the front mounted-pump. Grease weekly



### **WARNING**

Do not operate this Equipment with hydraulic oil or fuel leaking. Oil and fuel are explosive and their presence could present a hazard. Do not check for leaks with your hand! High-pressure oil streams from breaks in the line could penetrate the skin and cause tissue damage including gangrene. To check for a hose leak, SHUT the unit ENGINE OFF and remove all hydraulic pressure. Wear oil impenetrable gloves, safety glasses and use Cardboard to check for evidence of oil leaks. If you suspect a leak, REMOVE the HOSE and have it tested at a Dealer. If oil does penetrate the skin, have the injury treated immediately by a physician knowledgeable and skilled in this procedure. (SG-15)



# MAINTENANCE

MAINTENANCE

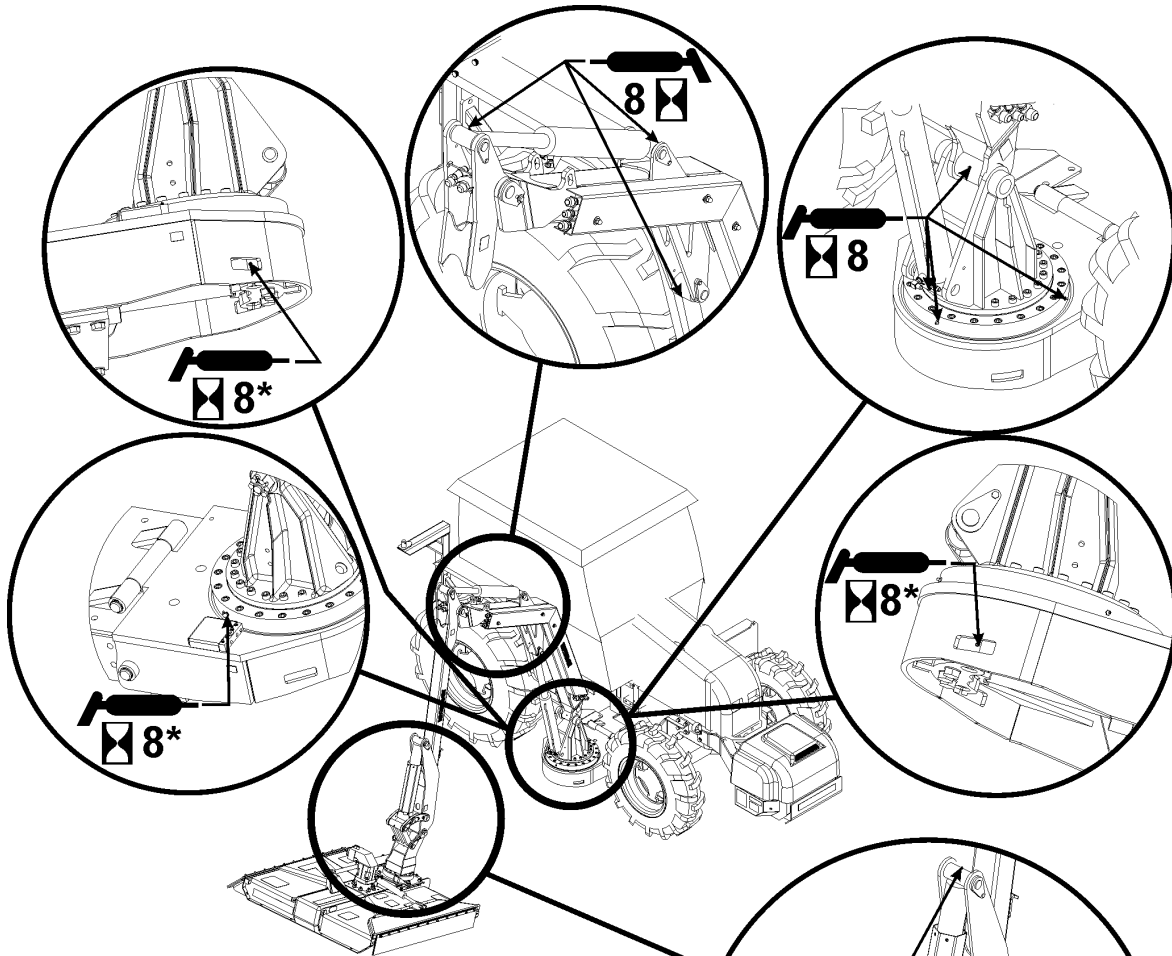

**Mower Head & Tilt Linkage Arm**  
 Bearing and Spindle Housing 8 Hours  
 Tilt Linkage 8 Hours

**Boom Arm**  
 Cylinder Pivots 8 Hours  
 Dipper Pivot Cylinder 8 Hours

**Turret Frame**  
 \*Bearing Slewing 8 Hours  
 Swing Rod End 8 Hours

Tractor Driveline Daily

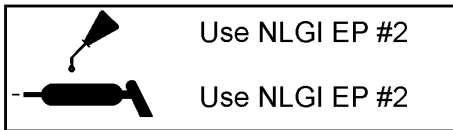

**\* Turret Bearing Greasing Procedure**

Rotate boom to the forward most position and grease. Move boom perpendicular from tractor and grease. Then swing boom reward and grease for complete coverage.

Mnt-B-0047

# MAINTENANCE

MAINTENANCE

## Hydraulic Oil, Filters, and Components

Filters and Oil - Change the Pressure Filter after the first 200 hours of operation. Change the filter again at 800 hours; then, change the oil and filters at 1600 hours. After that, continue to change the filter every 800 hours and the oil every 1600 hours. Use hydraulic oil Chevron 1000 THF or equivalent tractor.

**Note:** Your ambient temperature and operating conditions may require a different viscosity oil. Please consult the oil manufacturer for proper specifications.

If the Mower head cuts off or loses power it may be an indication that the Pressure Filter needs to be changed. Keep all hoses and adapters tight. Repair any leaks immediately. Do not overtighten hose end fittings. Tighten to specifications only. (See Chart Below)

Check the hydraulic oil level daily.

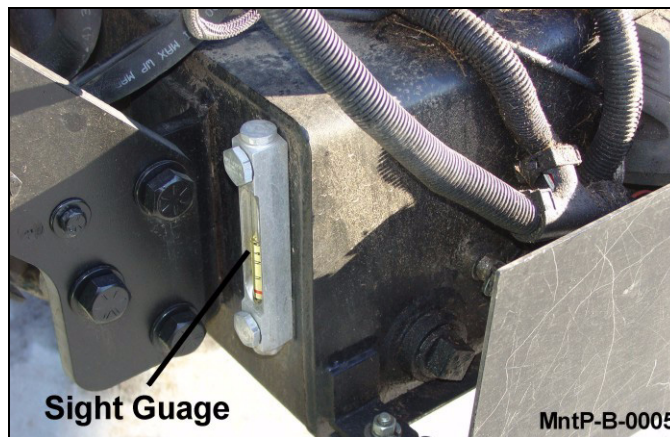

Sight Gauge

MntP-B-0005

### RECOMMENDED HOSE END TORQUE VALUES FOR 37 DEGREE ANGLE STEEL HOSE END FITTINGS

DASH SIZE	NOMINAL SIZE (IN.)	TORQUE (IN.LBS.)	VALUE* (FT.LBS.)
-4	1/4	140	12
-6	3/8	230	19
-8	1/2	450	38
-10	5/8	650	54
-12	3/4	900	75
-16	1	1200	100
-20	1-1/4	1600	133
-24	1-1/2	2000	167
-32	2	2800	233

\* Straight threads do not always seal better when higher torques are used. Too much torque causes distortion and may lead to leakage.

Mnt-B-0004

# MAINTENANCE

## Blades

Check the Blades for cracks and wear and Blade Bolts for tightness, daily. Blades should be replaced when they are worn excessively, bent, deformed, or out of balance.



Blades should always be replaced in pairs. Blades of different weights can cause serious imbalance and damage to the machine and personnel. When replacing blades, take care to replace the blade bolts, nuts, and washers.

## Hardware

Most nuts and bolts will stay tight and therefore need only periodic checking. However, the following nuts and bolts are extremely important and should receive special attention:

Spindle Housing Bolts: Tighten to 400 Ft./Lbs. Torque

Blade Bolts: Tighten to 400 Ft./Lbs. Torque

Blade Bar To Spindle Bolts: Tighten to 400 Ft./Lbs. Torque



Be certain to clamp or securely support the Spindle Housing and subassemblies to prevent injuries to hands and feet due to inadvertent dropping or falling over.



Always wear safety glasses and gloves to prevent eye and hand injury when chiseling or hammering on metal components. Hardened metal will chip unexpectedly.



An assembled spindle housing is quite heavy. Use a hoist or get help to handle them safely. Lift carefully and properly using your legs to lift - NOT YOUR BACK.

## Cylinder Rod Maintenance

It is important to visually inspect the hydraulic cylinder rods daily before use. It is highly recommended that while the machine is stored or getting very little use that a protectant is applied to the hydraulic cylinder rods to prevent degradation. If the machine receives more frequent use, be sure to fully cycle each cylinder function so that the cylinder rod is coated by the systems hydraulic fluid. Depending on your operating environment it may be necessary, under normal operating conditions, to apply a protective lubricant to the cylinder rods for protection against rust and pitting. Hydraulic fluid may provide a suitable amount of protection, but remember any protectant can attract dust and debris so attention must be given to the cylinder rods daily. Also remember that any other protectant must be compatible with hydraulic fluid. Alamo Industrial is not responsible for rust or pitting of the cylinder rod due to weather exposure or impacts from normal operation or mounting. If hydraulic cylinders and or the cylinder rods are damaged as a result of the rods rusting or pitting, the hydraulic cylinders and rods will not be covered under warranty by Alamo Industrial.



# MAINTENANCE



MAINTENANCE

## Proper Torque for Fasteners





The chart lists the correct tightening torque for fasteners. When bolts are to be tightened or replaced, refer to this chart to determine the grade of bolts and the proper torque except when specific torque values are assigned in manual text.

RECOMMENDED TORQUE IN FOOT POUNDS UNLESS OTHERWISE STATED IN THE MANUAL \*

**NOTE:** These values apply to fasteners as received from supplier, dry or when lubricated with normal engine oil. They do not apply if special graphited or molydisulphide greases or other extreme pressure lubricants are used. This applies to both UNF fine and UNC coarse threads.

Bolt Diameter	Proper Torque Values for Standard Bolts		
	 Head Marking No Marks Grade Two	 Head Marking Three Lines Grade Five	 Head Marking Six Lines Grade Eight
	Pound - Foot Value Dry	Pound - Foot Value Dry	Pound - Foot Value Dry
1/4"	5.5	6	12.5
5/16"	11	18	22
3/8"	20	31	39
7/16"	30	50	60
1/2"	49	75	88
9/16"	70	109	134
5/8"	97	151	172
3/4"	175	266	295
7/8"	210	430	440
1"	250	640	651

To get Newton-Meters multiply pound-foot of torque by 1.356

Bolt Diameter	Proper Torque Values for Metric Bolts			
	 Head Marking 4.8	 Head Marking 8.8 or 9.8	 Head Marking 10.9	 Head Marking 12.9
	Pound - Foot Value Dry	Pound - Foot Value Dry	Pound - Foot Value Dry	Pound - Foot Value Dry
6mm	3	7.7	12	13
8mm	7.3	19	27	31
10mm	14.4	37	53	62
12mm	25	65	92	108
14mm	40	103	147	172
16mm	62.5	166	230	269
18mm	86	229	317	371
20mm	122	325	450	525
22mm	166	442	612	715
24mm	210	562	777	908
27mm	308	822	1137	1329
30mm	418	1117	1544	1805

Mnt-B-0005

# MAINTENANCE

## Service of Spindle Housing (FIGURE Mnt-0006)

Remove blade bar or pan.

Remove hydraulic motor.

Remove spindle housing from unit.

Drain remaining oil from housing.

Using a chisel, bend the tang on the lockwasher (6) until it is free from the slot in the nut (5).

Unscrew locknut and remove locknut and lockwasher, and second locknut.

The Spindle should now slide from the Spindle housing, so the Spindle can be removed from the Housing.

Remove the Seal (7) from the Housing

### REMOVING BEARINGS:

If replacing bearings:

Remove the old bearings from the Spindle and Housing. Be careful not to damage either the Spindle or Housing in this process.

Turn the spindle housing over and from the bottom side of the spindle housing, using a punch, drive the remaining bearing cup out.

Clean spindle housing, spindle and bearings thoroughly.

When rebuilding the spindle housing assembly, always replace the locknuts, lockwasher, and seal.

### INSPECTION:

Bearing and cups:

Inspect bearings and bearing cups for nicks, pitting, discoloration and wear. If any exist, replace bearing and bearing cup.

# MAINTENANCE

MAINTENANCE

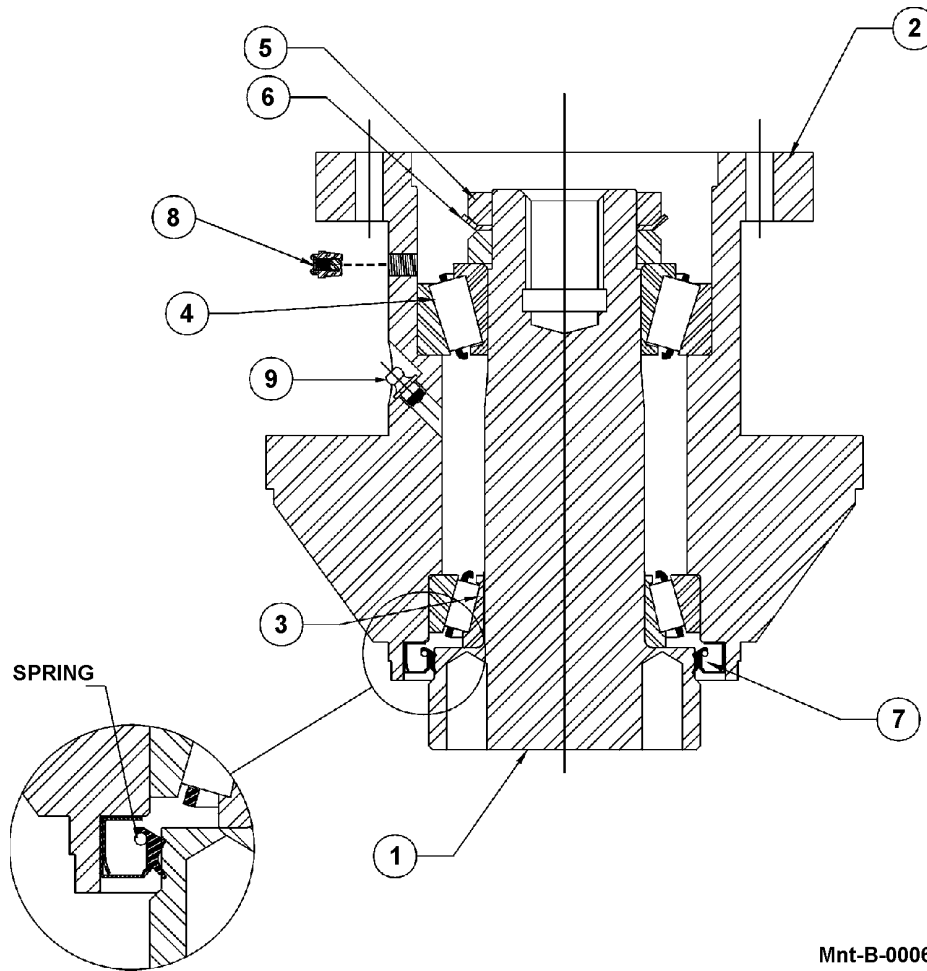

Mnt-B-0006

## **ASSEMBLY**

Make sure all parts are clean and free of any contamination

Install Bearing Cups (3 & 4) into Spindle Housing (2) using a suitable bearing driver to seat the cups. Caution must be taken not to damage the cup or spindle housing, cups must be fully seated. If Cups are damaged during installation or not fully seated, bearing and spindle assembly life are greatly reduced!

Never drive against bearing surface! Never used the mating bearing cone to seat the cup!

Once the Lower Cup is installed, the seal may be installed. The seal should be installed with the spring towards the inside Press seal (7) into spindle housing, make sure seal is fully seated. Be careful not to damage seal!

Press the Lower Cone (3) on the spindle shaft (1) use the proper tool when pressing the bearing onto the shaft, driving against the inner race and not the rollers or cage. Any damage to the bearing will cause premature failures of the bearing and spindle assembly.

Before installing the spindle (with the bearing pressed on it), lubricate the rubber portion of the seal. This will reduce the chance of the Seal being torn by the installation of the spindle and is a necessary step when setting the rolling Torque.

Turn the Spindle Housing Upside Down and insert the spindle (with the bearing pressed onto it) into the spindle

# MAINTENANCE

MAINTENANCE

housing until the bearing cone contacts the cup in the Housing. During this step take care not to damage the seal.

While supporting the Spindle and Housing turn the assembly over so that the assembly is setting on the spindle.

Install the upper bearing (4) on the spindle shaft (1).

After the Upper Bearing is installed, install the nut (5) with the chamfer facing up. Run the nut down against the bearing, but do not torque the nut at this time. Clamp the spindle Housing in a vise so that the spindle shaft can rotate. Tighten the nut until the spindle shaft has a rolling torque of 25 in-lbs (that is it takes 25 in-lbs to rotate the spindle shaft).

Install the tanged lockwasher (6) with the outside prongs facing upward.

Install the top nut (5) with the chamfer facing down. Block the spindle to keep it from rotating and torque the top nut to a minimum of 100 ft-lbs. Bend the tang of the lockwasher to fit into one of the grooves of the top nut.

Install vent plug (8) and Grease Fitting (9).

Fill spindle assembly with NLGI EP#2 Grease (Approx 22 oz.)

## IMPORTANT

### ALAMO GENUINE FLAIL PARTS

ALAMO INDUSTRIAL Flail Mowers use dynamically balanced and matched system components for Cutter Shafts, Knives, Knife Hangers, Rollers, Drivetrain components, Bearings, Belts, and Pulleys. ALAMO INDUSTRIAL parts are made and tested to meet close-tolerance specifications of balance, quality, and consistency that assure long, trouble-free service.

The use of inferior "will fit" parts will void warranty for your ALAMO INDUSTRIAL implement and may cause premature or catastrophic failure which can result in serious injury or death. If you have any questions concerning the repair parts you are using, contact ALAMO INDUSTRIAL 1502 E. Walnut Seguin, TX 78155 (830) 372-3551.



03200432

# MAINTENANCE

## ROLLER BEARING REPLACEMENT

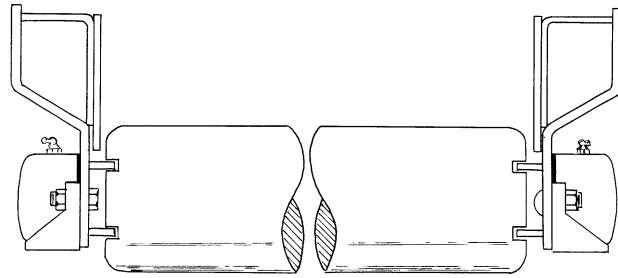
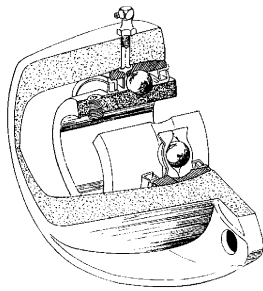

DETAIL OF ROLLER BEARING

Mnt-B-0029



Securely support mower while removing and installing roller assembly.

If installing a roller with pre assembled bearing and bracket assemblies, remove the old roller, proceed to step 11.

1. Remove roller and both bearing and bracket assemblies from mower. Lift the mower only high enough to remove the roller assembly.
2. Slide bearing and bracket assemblies off each end of roller. If replacing with new bearing and bracket assemblies, proceed to step 9.
3. Remove roller bearing and housing assembly attaching hardware. Remove assembly from bracket. Inspect seal between assembly and bracket for brittleness, cracks, wear and tear. Replace if necessary. If replacing with new roller bearing and housing assemblies, proceed to step 8.
4. Remove grease fitting from the top of bearing housing.
5. Remove bearing from housing by rotating Bearing 90° sideways and line up with notches in Bearing Housing then pull out.
6. Install new bearing into housing. Bearing must be installed with grease hole in bearing aligned with grease fitting hole in housing.
7. Reinstall grease fitting to housing. Grease Fitting must have locking pin installed which inserts into grease hole in bearing when installed. If Grease Fitting does not have a pin, order a new grease fitting. Grease fitting must be tight and seated in grease hole in bearing to prevent bearing from rotating in housing.
8. Attach roller bearing and housing assembly to bracket with seal between housing and bracket.
9. Slide bearing and bracket assemblies on each end of roller.
10. Check bearing for proper installation in housing by gently rocking bearing and bracket assembly in end of roller. Play should be slight to none at all.
11. Install roller and bearing and bracket assemblies on mower.
12. Lubricate roller bearing until lubricant can be seen coming out between roller and bearing housing.

# MAINTENANCE

## TIMBER CAT HEAD

### Lubrication/Daily Checks (Figure Mnt-0007)

Lubricate the grease fittings on top of the blade bar every 4 hours. See **Figure Mnt-0007**.

Every 8 hours, lubricate the cylinder grease fitting through the top slot in the cover. See **Figure Mnt-0007**. Every 8 hours, check all bolts and nuts for proper tightness. Tighten any bolt or nut found to be loose. Periodically check the hydraulic connections for oil leaks. Visually inspect the hoses for damage and replace as necessary. Periodically inspect blade stroke adjustment by running the head at normal operating speed (540 PTO) and checking that the upper and lower blades line-up perfectly the instant of reversal (when they change direction).

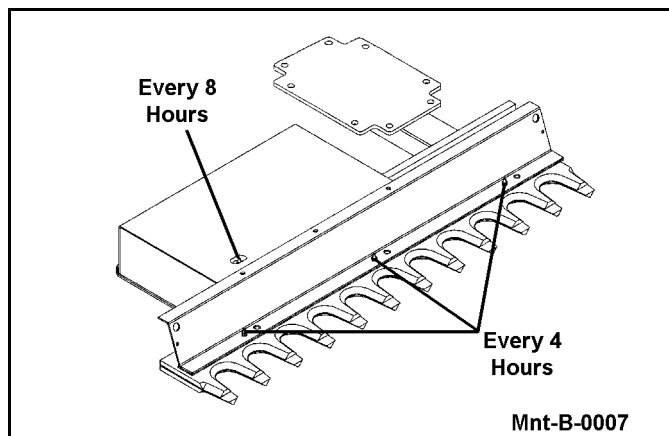

Improper adjustment is also indicated by an abnormally high shock load on the hydraulic system during blade reversal. This is due to the hydraulic cylinder reaching its stroke limit, causing the pressure relief reversing components to engage. Continuous operation in this mode will result in oil overheating and premature failure of components. If the unit is improperly adjusted, follow the stroke adjustment procedures below.

### Stroke Adjustment (Figure Mnt-0008)

Position the head in a safe area for operation. If necessary, barricade the head to prevent contact while it is being operated.

Remove the cover and loosen the two jam nuts (Item 1). See **Figure Mnt-0008**. Screw the two spring bolt assemblies (Item 2) in toward the valve push buttons. Start the unit and bring the speed up to normal operating speed (540 PTO). Check the blade overlap. Adjust the spring bolt assemblies (Item 2), one by one until the upper and lower blades perfectly align in the instant of reversal. Never adjust the bolt assemblies to a point where the hydraulic cylinder reaches its stroke limit! This is indicated by an abnormally high shock load on the hydraulic system due to the pressure relief reversing components being engaged. Continuous operation in this mode will cause premature component failure and hydraulic oil overheat. Once proper adjustment has been achieved, tighten the jam nuts (Item 1) and replace cover.

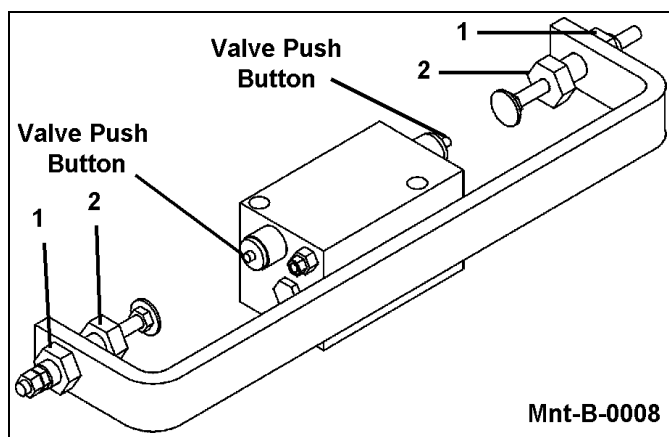

# MAINTENANCE

## Buzzbar Head

### BLADES

For best performance, have blades set and sharpened when they begin to dull. Blades can be touched up with a grinder or file between sharpenings.

To extend the life of the blade, remove resin accumulations. When the resin builds up, the blades will "burn" in the cut, causing the blades to overheat and warp. When cutting some types of trees, blades will need to be cleaned every few hours. To remove the resin, use oven cleaner or lacquer thinner with a Scotch-Brite pad or steel wool. Apply these products carefully since many of them will remove paint from your BuzzBar. Always follow manufacturer's instructions for safe use.

Blades should turn clockwise when views from the top.

See illustration below for hose routing.

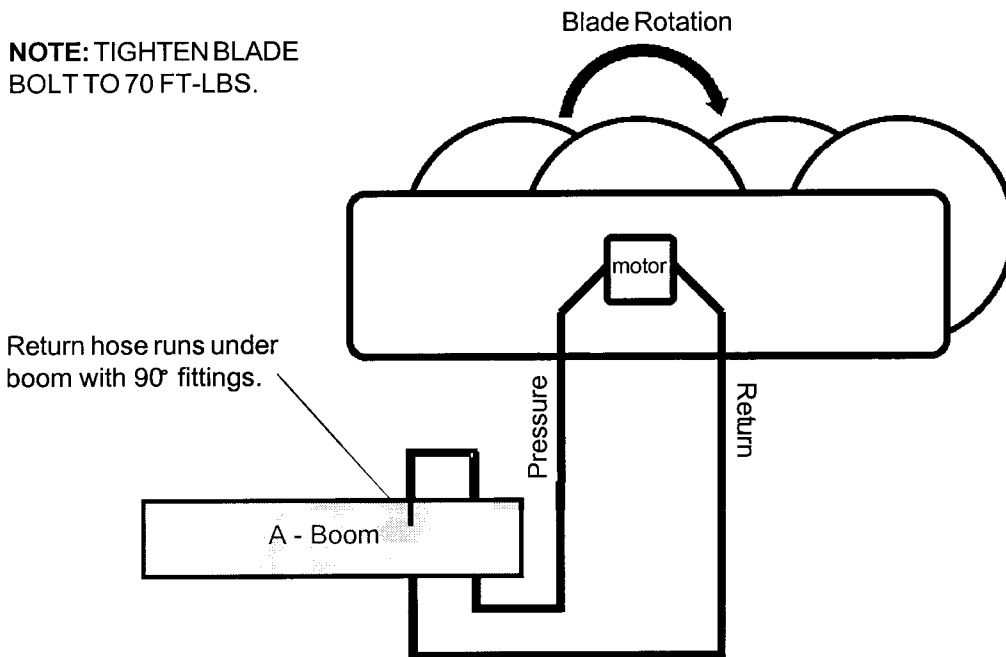

Mnt-B-0009

### LUBRICATION

Grease each spindle with one pump of high quality lithium grease weekly. More than one pump is unnecessary and will cause extra grease to spill from the relief.

Grease fittings are located in front of the machine, just above the blades.

# MAINTENANCE

## **Belt Tension Adjustment (Figure Mnt-B-0010)**

Loosen nuts on the 4 studs and the jam nut.

Use a hand wrench or socket to tension the belts.



Never use power or air equipment to tighten belt! This could cause damage to belt, sheave, shaft and bearings

Once the belts begin to tighten, small adjustments will produce large changes in tension.

Belts should be tensioned 15-20 lbs of force for 5/16 inches deflection.

Tighten nuts on studs and jam nut to hold tension.

## **BELT TENSION ADJUSTMENT**

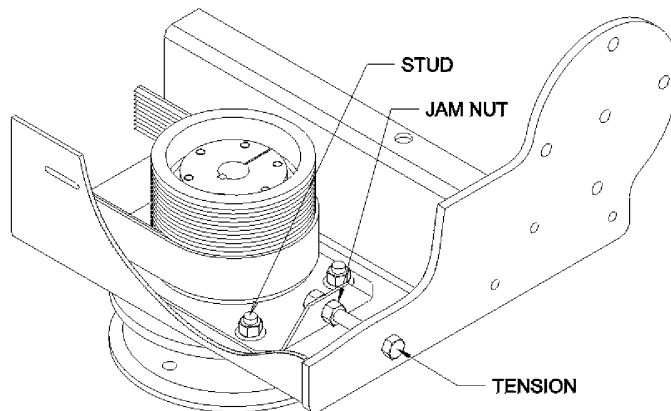

**MEASURE FORCE AND DEFLECTION  
WITH BELT TENSION METER**

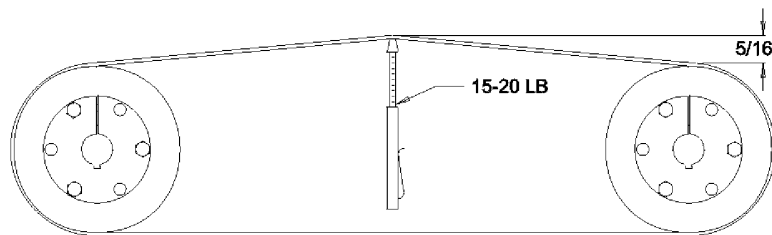

Mnt-B-0010

## **Lubrication:**

XTREME 03/09

Maintenance Section 4-13



# MAINTENANCE

Grease each spindle with one pump of high quality lithium grease weekly. More than one pump is unnecessary and will cause a mess when extra grease squirts out of the relief.

Grease fittings are on front of machine, just above the blades.

## **Belts:**

Check the belt tension daily. Your buzzbar is equipped with high performance Micro-V belts that run much tighter than regular V-belts. The belts should be tensioned to 15 to 20 lbs. of force for 5/16 of an inch of deflection.

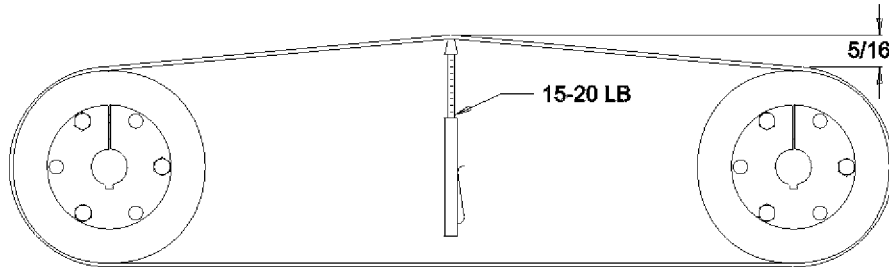

Mnt-B-0011

If belts begin to slip, check tension.

To tighten the belts, loosen the four nuts that hold the spindle to the body of the machine. Then use a hand wrench or socket to turn the bolt that tensions the belt. Never use power tools to tighten belt. Once the belts begin to tighten, small adjustments will produce large changes in belt tension.

Too much tension can cause premature bearing, sheave, and belt damage.

## **Flail Axe Head**

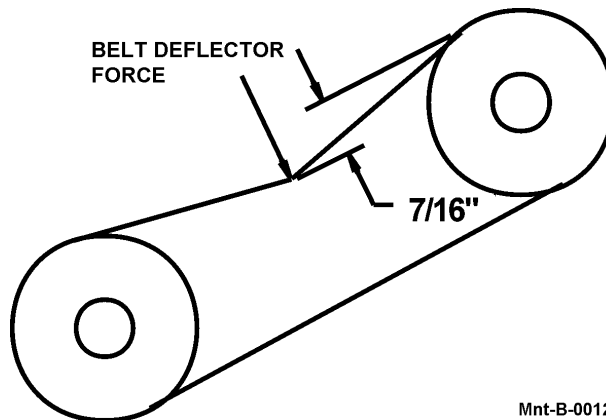

Mnt-B-0012

## **Belt Tension:**

When installing new belts, tighten belts to obtain a 16 lb. Belt Deflector Force at 7/16" deflection. After a few hours of operation to allow the belts to seat into the sheave grooves recheck and adjust as needed to obtain an 8 to 12 lb. Belt Deflection Force at 7/16" deflection. Inspect belts and recheck belt tension periodically to maintain an 8 to 12 lb. Belt Deflection Force at 7/16" deflection.

# MAINTENANCE

## Grass Flail Head

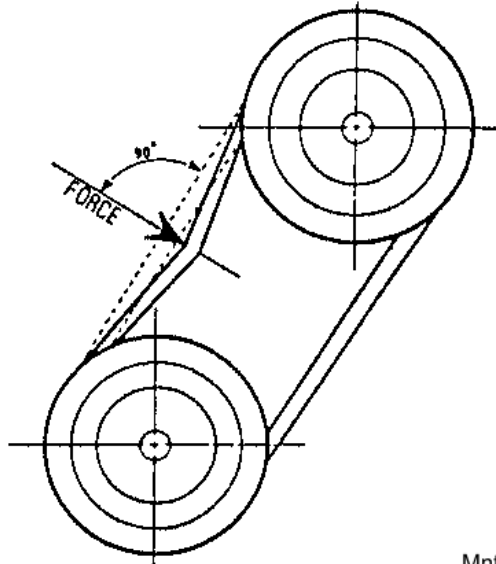

Mnt-B-0049

### Tensioning Drive Belts

The rotor shaft is driven from the gear motor via “V” belts which are adjustable for tension. After stopping the tractor engine, remove the drive guards to tighten the belts. Check the tension by applying a force of 6.17 - 7.72 lbs at right angles to the belt in the centre of the two pulleys. If the deflection is great than 1/4” then release the motor mounting plate screws and adjuster locknut and screw the adjuster to tighten the belts until the deflection is 1/4”. Then, tighten the locknut, recheck the belt tension, and replace the belt cover.

**IMPORTANT:** Do not overtighten belt as this may cause premature failure of the rotor shaft and motor bearings.

MAINTENANCE

# MAINTENANCE

## TAPER BUSHING & SHEAVE INSTALLATION

Do not use lubricants during installation as this may cause sheave breakage.

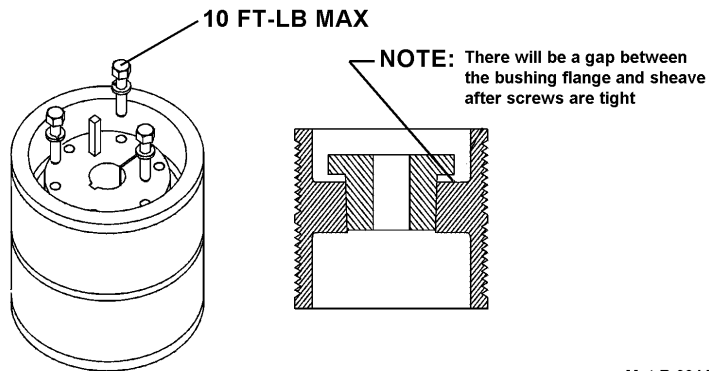

Mnt-B-0014

Make sure the bushing and bore of the sheave are free of dirt, paint, metal chips, etc.

Insert cap screws and lockwashers engaging only 2 or 3 threads.

With key in the keyway, slide the loosely assembled unit onto the shaft and position for good belt alignment. Temporary shimming under the pulley may make it easier to position.

Carefully tighten cap screws alternately and progressively until tapers are seated (about 5 FT-LB).

Check sheave alignment and runout (wobble).

Continue careful alternate and progressive tightening of cap screws to 10 FT-LB.

Maximum torque should be achieved on each individual bolt only two times.

# MAINTENANCE

MAINTENANCE

## General Information on Flail Mower Vibration

### FLAIL MOWERS INFORMATION BULLETIN NO. 5

#### EXCESSIVE VIBRATION

Vibration is a **MONSTER** and if allowed to continue unchecked, can cause the complete break-up of a machine in a very short time.

A properly operated Flail Mower will produce very little vibration. If vibration does occur, the mower should be stopped and the trouble corrected, as warranty does not cover failures resulting from continued operation after something happens to cause the mower to vibrate excessively.

Vibration is caused by a rotating part which is out of balance. This could be the cutter shaft or, on those models having a universal slip joint assembly drive shaft, from the drive shaft.

If the two extreme ends of the drive shaft, (the yoke splines which fit on the tractor power take off shaft and on the mower gear box driven shaft), are not parallel, vibration will be evident.

This is because of the mechanics of a universal drive wherein the rotational speed thru a universal joint is not uniform. If the ends of a universal drive shaft are parallel, the uneven rotation effect is cancelled out and the machine being driven will be driven at a uniform rate of speed. However, if the ends are not parallel, the uneven rotation effect may be multiplied, resulting in a speeding up and slowing down of the entire mower system (gear box, extension shaft, pulleys, belt, and cutter shaft) each revolution. This effect can be readily noticed if the mower, while running, is raised to an extreme height on the tractor lift.

For smoothest operation, the tilt of the mower should be adjusted (on a 3-point hitch, by adjusting the length of the top link between the tractor and the mower) so that the ends of the drive shaft are parallel when the mower is down in operating position. Raising the mower, while running, to extreme heights on the lift should be avoided.

To check where the vibration is originating, first be sure the ends of the universal drive shaft are parallel. Then, if vibration is still present, remove the drive belt and run the mower. If vibration is still present, it most likely is coming from and caused by a bent drive shaft. If so, the shaft should be replaced or straightened. If the vibration is gone - the drive portion of the mower is running smoothly - then the vibration is probably coming from the cutter shaft (it could be a pulley out of balance or a faulty belt with a varying cross section, but this is not likely).

#### The cutter shaft will run out of balance if:

1. Wire, rope, string, rags, etc., around the cutter shaft. are holding the knives in a folded back position. Remove such foreign objects and be sure all knives are free to swing to the extended position.
2. Knives are missing or broken. Replace missing or broken knives.
3. Knife hanger lugs are broken off shaft. This condition usually results from continued operation in contact with large hard objects where the knife hanger lugs themselves are hitting the hard objects. Lugs should be replaced using arc welding equipment so as not to direct too much heat in one area of the shaft.
4. Cutter shaft ball bearings are worn enough to have radial "play" in them. Replace ball bearing and other worn parts to eliminate "play".
5. Shaft is bent. The shafts are straight within a couple of thousandths of an inch when they are made. It is possible that they will become bent in use, such as if the shaft is hooked on a stump while the tractor is moving forward at a good speed.
6. Shafts are operated at improper speed. Rotating shafts have what is known as a natural period of vibration. The same is true of the cutter shafts on the Flail Mowers.

# MAINTENANCE

The actual speed at which the harmonic will occur will vary with each mower and each installation. To avoid this harmonic vibration when operating the mower, it may be necessary to adjust the engine speed of the tractor up or down.

Some units have a harmonic vibration which occurs below the nominal operating speed. On these units, it will be noticed that there is always a little vibration at a particular RPM as the mower is being sped up to operating speed. This occurs as the shaft passes through its normal harmonic vibration point. As long as the mower is opened at the proper speed, then harmonic vibration will not be an issue.

## MAINTENANCE

### Start up Procedure

1. Read all safety instructions. Decals on the Boom warn you of particular and multiple hazards. Many decals are attached close to part of the Boom where there is a possible hazard. Read and make sure you understand the safety messages before you operate the Boom. Keep all decals clean and readable. Replace lost or damaged decals.
2. Before operating, read all the safety and operating instructions in the Operators Manual for both the tractor and mower.
3. When the hydraulic tank has been filled and the mower unit properly assembled, the unit should be started up. **NOTE:** Make sure that no materials, tools, or jacks, have been left under the mower head. Make sure the front and rear of the mower are properly guarded to prevent any foreign objects from being thrown by the mower. All other workers should be kept a safe distance from the unit before the mower is started.
4. Start the tractor and idle at a slow engine speed until oil is being pumped.
5. Engage the Cutter Control Valve at low engine PTO speed and run the mower slowly for a short period until all air is removed from the hoses. Keep all persons WELL CLEAR of mower since Blades can THROW OBJECTS with great velocity for a considerable distance! KEEP CLEAR!
6. With the area clear of any ground and overhead obstructions, work each cylinder on the boom one at a time, several times, to expel any air in the Hoses and Cylinders.
7. Run the Mower Head for 5 minutes. While the tractor is idling, blocked, wearing protective clothing and eye protection, **CAREFULLY** check for leaking hydraulic fittings, hoses and ports at this point with a piece of cardboard, **DO NOT USE YOUR HAND!** If any are found stop the tractor immediately and correct any leaky connections.
8. Check the fluid level in the Hydraulic Tank on the Tractor, and add oil if required. As the air has been forced out of the Cylinders and Hoses, it goes into the Hydraulic Tank and reduces the oil level. Check your Tractors Operators Manual for the proper level and type of oil to be used.



# ALAMO-INDUSTRIAL LIMITED WARRANTY

## 1. LIMITED WARRANTIES

- 1.01. Alamo Industrial warrants for one year from the purchase date to the original non-commercial, governmental, or municipal purchaser ("Purchaser") and warrants for six months to the original commercial or industrial purchaser
- 1.02. Manufacturer will replace for the Purchaser any part or parts found, upon examination at one of its factories, to be defective under normal use and service due to defects in material or workmanship.
- 1.03. This limited warranty does not apply to any part of the goods which has been subjected to improper or abnormal use, negligence, alteration, modification, or accident, damaged due to lack of maintenance or use of wrong fuel, oil, or lubricants, or which has served its normal life. This limited warranty does not apply to any part of any internal combustion engine, or expendable items such as blades, shields, guards, or pneumatic tires except as specifically found
- 1.04. Except as provided herein, no employee, agent, Dealer, or other person is authorized to give any warranties of any nature on behalf of Manufacturer.

## 2. REMEDIES AND PROCEDURES.

- 2.01. This limited warranty is not effective unless the Purchaser returns the Registration and Warranty Form to Manufacturer within 30 days of purchase.
- 2.02. Purchaser claims must be made in writing to the Authorized Dealer ("Dealer") from whom Purchaser purchased the goods or an approved Authorized Dealer ("Dealer") within 30 days after Purchaser learns of the facts on which the claim is based.
- 2.03. Purchaser is responsible for returning the goods in question to the Dealer.
- 2.04. If after examining the goods and/or parts in question, Manufacturer finds them to be defective under normal use and service due to defects in material or workmanship, Manufacturer will:
  - (a) Repair or replace the defective goods or part(s) or
  - (b) Reimburse Purchaser for the cost of the part(s) and reasonable labor charges (as determined by Manufacturer) if Purchaser paid for the repair and/or replacement prior to the final determination of applicability of the warranty by Manufacturer.

The choice of remedy shall belong to Manufacturer.

- 2.05. Purchaser is responsible for any labor charges exceeding a reasonable amount as determined by Manufacturer and for returning the goods to the Dealer, whether or not the claim is approved. Purchaser is responsible for the transportation cost for the goods or part(s) from the Dealer to the designated factory.

## 3. LIMITATION OF LIABILITY.

- 3.01. MANUFACTURER DISCLAIMS ANY EXPRESS (EXCEPT AS SET FORTH HEREIN) AND IMPLIED WARRANTIES WITH RESPECT TO THE GOODS INCLUDING, BUT NOT LIMITED TO, MERCHANTABILITY AND FITNESS FOR A PARTICULAR PURPOSE.
- 3.02. MANUFACTURER MAKES NO WARRANTY AS TO THE DESIGN, CAPABILITY, CAPACITY, OR SUITABILITY FOR USE OF THE GOODS.
- 3.03. EXCEPT AS PROVIDED HEREIN, MANUFACTURER SHALL HAVE NO LIABILITY OR RESPONSIBILITY TO PURCHASER OR ANY OTHER PERSON OR ENTITY WITH RESPECT TO ANY LIABILITY, LOSS, OR DAMAGE CAUSED OR ALLEGED TO BE CAUSED DIRECTLY OR INDIRECTLY BY THE GOODS INCLUDING, BUT NOT LIMITED TO, ANY INDIRECT, SPECIAL, CONSEQUENTIAL, OR INCIDENTAL DAMAGES RESULTING FROM THE USE OR OPERATION OF THE GOODS OR ANY BREACH OF THIS WARRANTY. NOT WITHSTANDING THE ABOVE LIMITATIONS AND WARRANTIES, MANUFACTURER'S LIABILITY HEREUNDER FOR DAMAGES INCURRED BY PURCHASER OR OTHERS SHALL NOT EXCEED THE PRICE OF THE GOODS.
- 3.04. NO ACTION ARISING OUT OF ANY CLAIMED BREACH OF THIS WARRANTY OR TRANSACTIONS UNDER THIS WARRANTY MAY BE BROUGHT MORE THAN TWO (2) YEARS AFTER THE CAUSE OF ACTION HAS OCCURRED.

## 4. MISCELLANEOUS.

- 4.01. Proper Venue for any lawsuits arising from or related to this limited warranty shall be only in Guadalupe County, Texas.
- 4.02. Manufacturer may waive compliance with any of the terms of this limited warranty, but no waiver of any terms shall be deemed to be a waiver of any other term.
- 4.03. If any provision of this limited warranty shall violate any applicable law and is held to be unenforceable, then the invalidity of such provision shall not invalidate any other provisions herein.
- 4.04. Applicable law may provide rights and benefits to purchaser in addition to those provided herein.

## KEEP FOR YOUR RECORDS

ATTENTION: Purchaser should fill in the blanks below for his reference when buying repair parts and/or for proper machine identification when applying for warranty.

Alamo Industrial Implement Model \_\_\_\_\_

Serial Number \_\_\_\_\_

Date Purchased \_\_\_\_\_

Dealer \_\_\_\_\_

ATTENTION: \_\_\_\_\_

READ YOUR OPERATOR'S MANUAL

**ALAMO INDUSTRIAL**  
An Alamo Group Company  
Post Office Drawer 549  
Seguin, Texas 78156  
830-379-1480

8C-002





# TO THE OWNER/OPERATOR/DEALER

To keep your implement running efficiently and safely, read your manual thoroughly and follow these directions and the Safety Messages in this Manual. The Table of Contents clearly identifies each section where you can easily find the information you need.

The OCCUPATIONAL SAFETY AND HEALTH ACT (1928.51 Subpart C) makes these minimum safety requirements of tractor operators:

## REQUIRED OF THE OWNER:

1. Provide a Roll-Over-Protective Structure that meets the requirements of this Standard; and
2. Provide Seat belts that meet the requirements of this paragraph of this Standard and SAE J4C; and
3. Ensure that each employee uses such Seat belt while the tractor is moving; and
4. Ensure that each employee tightens the Seat belt sufficiently to confine the employee to the protected area provided by the ROPS.

## REQUIRED OF THE OPERATOR

1. Securely fasten seat belt if the tractor has a ROPS.
2. Where possible, avoid operating the tractor near ditches, embankments, and holes.
3. Reduce speed when turning, crossing slopes, and on rough, slick, or muddy surfaces.
4. Stay off slopes too steep for safe operation.
5. Watch where you are going - especially at row ends, on roads, and around trees.
6. Do not permit others to ride.
7. Operate the tractor smoothly - no jerky turns, starts, or stops.
8. Hitch only to the drawbar and hitch points recommended by the tractor manufacturer.
9. When the tractor is stopped, set brakes securely and use park lock, if available.

- Keep children away from danger all day, every day...
- Equip tractors with rollover protection (ROPS) and keep all machinery guards in place...
- Please work, drive, play and live each day with care and concern for your safety and that of your family and fellow citizens.





BC-0001