



SL60

SKID STEER ROTARY MOWER

Published 03/08

Part No. 00777575C

OPERATOR'S MANUAL



This Operator's Manual is an integral part of the safe operation of this machine and must be maintained with the unit at all times. READ, UNDERSTAND, and FOLLOW the Safety and Operation Instructions contained in this manual before operating the equipment. C01-Cover

FC-R-0020



ALAMO INDUSTRIAL®

1502 E. Walnut
Seguin, Texas 78155
830-372-3551
Email: parts@alamo-industrial.com



To the Owner/Operator/Dealer





All implements with moving parts are potentially hazardous. There is no substitute for a cautious, safe-minded operator who recognizes the potential hazards and follows reasonable safety practices. The manufacturer has designed this implement to be used with all its safety equipment properly attached to minimize the chance of accidents.

BEFORE YOU START!! Read the safety messages on the implement and shown in your manual. Observe the rules of safety and common sense!



DANGER

FAILING TO FOLLOW SAFETY MESSAGES AND OPERATING INSTRUCTIONS CAN CAUSE SERIOUS BODILY INJURY OR EVEN DEATH TO OPERATOR AND OTHERS IN THE AREA.

<p>1. </p>	<p>2. NORIDERS. NO CHILDREN OPERATORS. </p>	<p>3. USE SAFETY SHOES, HARD HAT, SAFETY GLASSES, SEAT BELTS, & ROPS. </p>	<p>4. BLOCK UP SECURELY BEFORE WORKING UNDER. </p>
---	--	--	---

1. Study and understand Operator's Manuals, Safety Signs, and Instructional Decals for tractor and implement to prevent misuse, abuse and accidents.

- Learn how to stop engine suddenly in an emergency. Be alert for passersby and especially children.

2. Allow no children on or near implement or tractor. Allow no riders on tractor or implement. Falling off may cause serious injury or death from being run over by tractor or cutter or contact with rotating blades.

3. Operate only with tractor having Roll-Over Protective Structure (ROPS) and with seatbelt fastened securely and snugly to prevent injury and possible death from falling off or tractor overturn. Personal Protective Equipment such as Hard Hat, Safety Glasses, Safety shoes, and Ear Plugs are recommended.

4. Block up or support raised machine and all lifted components securely before putting hands or feet under or working underneath any lifted components to prevent crushing injury or death from sudden dropping or inadvertent operation of controls. Make certain area is clear before lowering or folding.

5. Before transporting, put Lift Lever in detent or full-lift position. Secure the implement for transport by installing Cylinder Stops or Transport Pin on pull-type implement center axle and Wing Transport Locks on folding implements.



- Attach Safety Chain to cutter and towing unit securely. See Operator's Manual.

6. Make certain that SMV sign, Warning Lights, and Reflectors are clearly visible. Follow local traffic codes.

7. Never operate with Cutting Head raised if passersby, bystanders, or traffic are in the area to reduce possibility of injury or death from objects thrown by Blades under Guards or cutter structure.

8. Before dismounting, secure implement in transport position or lower to ground.

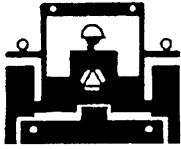
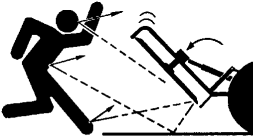
- Put tractor in park or set brake, disengage PTO, stop engine, and remove key, and wait until noise of rotation has ceased to prevent entanglement in rotating parts which can cause injury or death.
- Never mount or dismount a moving vehicle. Crushing from runover may cause injury or death.

<p>5. TRANSPORT SAFELY, CARRY LOW TO GROUND </p>	<p>6. USE SMV, LIGHTS, & REFLECTORS. </p>	<p>7. DO NOT OPERATE WITH CUTTER RAISED. </p>	<p>8. DO NOT MOUNT OR DISMOUNT WHILE MOVING. </p>
---	--	---	--

00777519

WARRANTY INFORMATION:

Read and understand the complete Warranty Statement found in this Manual. Fill out the Warranty Registration Form in full and return it to within 30 Days. Make certain the Serial Number of the Machine is recorded on the Warranty Card and on the Warranty Form that you retain.

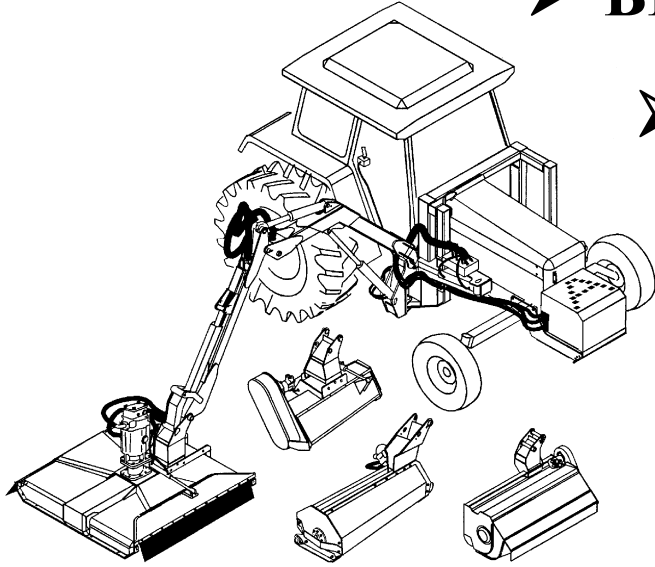

➤ **BE SAFE!**

➤ **BE ALERT!**

➤ **BE ALIVE!**

➤ **BE TRAINED
before operating
the Mower!**

**////ALAMO
INDUSTRIAL**

*Safety Training
Makes the Difference*

In order to reduce accidents and enhance the safe operation of mowers, *Alamo Industrial*, in cooperation with other industry manufacturers has developed the AEM/FEMA Industrial and Agricultural Mower Safety Practices video and guide book.

The video will familiarize and instruct mower-tractor operators in safe practices when using industrial and agricultural mowing equipment. It is important that Every Mower Operator be educated in the operation of their mowing equipment and be able to recognize the potential hazards that can occur while operating a mower. This video, along with the mower operator's manual and the warning messages on the mower, will significantly assist in this important education.

Your Authorized *Alamo Industrial* Dealer may have shown this video and presented you a DVD Video when you purchased your mower. If you or any mower operator have not seen this video, **Watch the Video, Read this Operator's Manual, and Complete the Video Guidebook** before operating your new mower. If you do not understand any of the instructions included in the video or operator's manual or if you have any questions concerning safety of operation, contact your supervisor, dealer or *Alamo Industrial*.

If you would like a VHS video tape of the video, please email AEMVideo@alamo-group.com or Fax AEM VHS Video at (830) 372-9529 or mail in a completed copy of the form on the back of this page to AEM VHS Video 1502 E Walnut Street, Seguin, TX 78155. and request the VHS video version. Please include your name, mailing address, mower model and serial number.

Every operator should be trained for each piece of equipment (Tractor and Mower), understand the intended use, and the potential hazards before operating the equipment.

**Alamo Industrial Division is willing to provide
one (1) AEM Mower Safety Practices Video**

- Please Send Me: VHS Format – AEM/FEMA Mower Operator Safety Video
 DVD Format – AEM/FEMA Mower Operator Safety Video
 Mower Operator’s Manual
 AEM Mower Operator’s Safety Manual

Requester Name _____ Phone: _____

Requester Address: _____

City _____

State _____

Zip Code _____

Mower Model: _____ Serial Number: _____

Date Purchased: _____ Dealer Salesperson: _____

Dealership Name: _____ Dealership Location: _____

Mail to:

AEM Video Services

1502 E Walnut street

Seguin, TX 78155

Or Fax to:

(830) 372-9529

Or Email to:

AEMVideo@alamo-group.com

TABLE OF CONTENTS

SAFETY SECTION	1-1
General Safety Instructions and Practices	1-2
Operator Safety Instructions and Practices	1-3
Equipment Operation Safety Instructions and Practices	1-5
Connecting or Disconnecting Implement Safety Instructions and Practices	1-11
Transporting Safety Instructions and Practices	1-12
Maintenance and Service Safety Instructions and Practices	1-14
Concluding Safety Instructions and Practices	1-16
Decal Location	1-17
Decal Description	1-19
Federal Laws and Regulations	1-23
INTRODUCTION SECTION	2-1
ASSEMBLY SECTION	3-1
DEALER SETUP INSTRUCTIONS	3-2
HITCH LINKAGE SETUP INSTRUCTIONS	3-2
HITCH ASSEMBLY	3-3
FRONT CHAIN GUARD ASSEMBLY	3-4
REAR CHAIN GUARD ASSEMBLY	3-4
SIDE DEFLECTOR ASSEMBLY	3-5
SKID SHOE ASSEMBLY	3-5
OPERATION SECTION	4-1
SL60 Standard Equipment and Specifications	4-3
OPERATOR REQUIREMENTS	4-4
SKID STEER REQUIREMENTS	4-5
ROPS and Seat Belt	4-5
Operator Protective Door	4-6
Tractor Safety Devices	4-6
Hitch	4-6
Auxiliary Hydraulics	4-7
GETTING ON AND OFF THE SKID STEER	4-7
Dismounting the Skid Steer	4-8
STARTING THE SKID STEER	4-9
CONNECTING THE MOWER TO THE SKID STEER	4-10
Connecting the Hitches	4-11
Connecting Mower and Skid Steer Hydraulics Lines	4-12
PRE-OPERATION INSPECTION AND SERVICE	4-13
Skid Steer Pre-Operation Inspection/Service	4-14
Mower Pre-Operation Inspection/Service	4-14
Cutting Component Inspection	4-17
Blade Bolt Inspection	4-18
DRIVING THE SKID STEER AND MOWER	4-21
Starting the Skid Steer	4-22
Driving the Skid Steer	4-22
OPERATING THE SKID STEER AND MOWER	4-22
Foreign Debris Hazards	4-23

Bystander/Passersby Precautions	4-24
Engaging the Mower	4-24
Operating Speed and Ground Speed	4-25
Operating the Mower	4-26
Shutting Down the Mower	4-26
DISCONNECTING THE MOWER FROM THE SKID STEER	4-27
MOWER STORAGE	4-28
TRANSPORTING THE SKID STEER AND MOWER	4-28
Transporting on Public Roadways	4-29
Hauling the Skid Steer and Mower	4-30
TROUBLESHOOTING GUIDE	4-31

MAINTENANCE SECTION 5-1

LUBRICATION INFORMATION	5-2
LUBRICATION SCHEDULE	5-2
SPINDLE LUBRICATION	5-3
HYDRAULIC LINES, COUPLERS, & ADAPTERS	5-3
BLADE SERVICING	5-4
BLADE SHARPENING	5-4
BLADE REMOVAL	5-5
BLADE CARRIER REMOVAL	5-5
BLADE CARRIER INSTALLATION	5-5
STORAGE	5-6
PROPER TORQUE FOR FASTENERS	5-6

SAFETY SECTION

Safety Section 1-1

SAFETY

General Safety Instructions and Practices

A careful operator is the best operator. Safety is of primary importance to the manufacturer and should be to the owner/operator. Most accidents can be avoided by being aware of your equipment, your surroundings, and observing certain precautions. The first section of this manual includes a list of Safety Messages that, if followed, will help protect the operator and bystanders from injury or death. Read and understand these Safety Messages before assembling, operating or servicing this Implement. This equipment should only be operated by those persons who have read the Manual, who are responsible and trained, and who know how to do so responsibly.



The Safety Alert Symbol combined with a Signal Word, as seen below, is used throughout this manual and on decals which are attached to the equipment. The Safety Alert Symbol means: "ATTENTION! BECOME ALERT! YOUR SAFETY IS INVOLVED!" The Symbol and Signal Word are intended to warn the owner/operator of impending hazards and the degree of possible injury faced when operating this equipment.

Practice all usual and customary safe working precautions and above all--remember safety is up to YOU. Only YOU can prevent serious injury or death from unsafe practices.



Indicates an imminently hazardous situation that, if not avoided, WILL result in DEATH OR VERY SERIOUS INJURY.



Indicates an imminently hazardous situation that, if not avoided, COULD result in DEATH OR SERIOUS INJURY.



Indicates an imminently hazardous situation that, if not avoided, MAY result in MINOR INJURY.



Identifies special instructions or procedures that, if not strictly observed, could result in damage to, or destruction of the machine, attachments or the environment.

NOTE: *Identifies points of particular interest for more efficient and convenient operation or repair.* (SG-1)

READ, UNDERSTAND, and FOLLOW the following Safety Messages. Serious injury or death may occur unless care is taken to follow the warnings and instructions stated in the Safety Messages. Always use good common sense to avoid hazards. (SG-2)



Si no lee ingles, pida ayuda a alguien que si lo lea para que le traduzca las medidas de seguridad. (SG-3)



SAFETY



Engine Exhaust, some of its constituents, and certain vehicle components contain or emit chemicals known to the state of California to cause cancer and birth defects or other reproductive harm. (SG-30)



Battery posts, terminals and related accessories contain lead and lead compounds, chemicals known to the state of California to cause cancer, birth defects or other reproductive harm. (SG-31)

Operator Safety Instructions and Practices



The rotating parts of this machine continue to rotate even after the PTO has been turned off. The operator should remain in his seat for 60 seconds after the brake has been set, the PTO disengaged, the tractor turned off, and all evidence of rotation has ceased. (S3PT-10)

“Wait a minute...Save a life!”



Never crawl under a raised Implement supported solely by the Tractor 3-Point hitch. Release of the control lever or mechanical failure will result in the Implement falling and possible injury or death. Always securely block up the Implement before crawling underneath to perform repairs and service. (S3PT-19)



Never operate the Tractor or Implement until you have read and completely understand this Manual, the Tractor Operator's Manual, and each of the Safety Messages found in the Manual or on the Tractor and Implement. Learn how to stop the tractor engine suddenly in an emergency. Never allow inexperienced or untrained personnel to operate the Tractor and Implement without supervision. Make sure the operator has fully read and understood the manuals prior to operation. (SG-4)



The operator and all support personnel should wear hard hats, safety shoes, safety glasses, and proper hearing protection at all times for protection from injury including injury from items that may be thrown by the equipment. (SG-16)

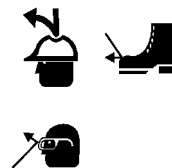

SAFETY

CAUTION

PROLONGED EXPOSURE TO LOUD NOISE MAY CAUSE PERMANENT HEARING LOSS! Tractors with or without an Implement attached can often be noisy enough to cause permanent hearing loss. We recommend that you always wear hearing protection if the noise in the Operator's position exceeds 80db. Noise over 85db over an extended period of time will cause severe hearing loss. Noise over 90db adjacent to the Operator over an extended period of time will cause permanent or total hearing loss. **NOTE:** *Hearing loss from loud noise [from tractors, chain saws, radios, and other such sources close to the ear] is cumulative over a lifetime without hope of natural recovery.* (SG-17)



WARNING

Always read carefully and comply fully with the manufacturer's instructions when handling oil, solvents, cleansers, and any other chemical agent. (SG-22)



DANGER

KEEP AWAY FROM ROTATING ELEMENTS to prevent entanglement and possible serious injury or death. (SG-24)



DANGER

Never allow children to play on or around Tractor or Implement. Children can slip or fall off the Equipment and be injured or killed. Children can cause the Implement to shift or fall crushing themselves or others. (SG-25)

DANGER

NEVER use drugs or alcohol immediately before or while operating the Tractor and Implement. Drugs and alcohol will affect an operator's alertness and coordination and therefore affect the operator's ability to operate the equipment safely. Before operating the Tractor or Implement, an operator on prescription or over-the-counter medication must consult a medical professional regarding any side effects of the medication that would hinder their ability to operate the Equipment safely. NEVER knowingly allow anyone to operate this equipment when their alertness or coordination is impaired. Serious injury or death to the operator or others could result if the operator is under the influence of drugs or alcohol. (SG-27)



WARNING

Prolonged operation may cause operator boredom and fatigue affecting safe operation. Take scheduled work breaks to help prevent these potentially impaired operating conditions. Never operate the Implement and Tractor in a fatigued or bored mental state which impairs proper and safe operation. (SG-32)

SAFETY



WARNING

Use extreme caution when getting onto the Implement to perform repairs, maintenance and when removing accumulated material. Only stand on solid flat surfaces to ensure good footing. Use a ladder or raised stand to access high spots which cannot be reached from ground level. Slipping and falling can cause serious injury or death. (SG-33)



WARNING

Avoid contact with hot surfaces including hydraulic oil tanks, pumps, motors, valves and hose connections. Relieve hydraulic pressure before performing maintenance or repairs. Use gloves and eye protection when servicing hot components. Contact with a hot surface or fluid can cause serious injury from burns or scalding. (SG-34)



DANGER

DO NOT operate this Implement on a Tractor that is not properly maintained. Should a mechanical or Tractor control failure occur while operating, immediately shut down the Tractor and perform repairs before resuming operation. Serious injury and possible death could occur from not maintaining this Implement and Tractor in good operating condition. (SG-36)



WARNING

Avoid contact with hot surfaces of the engine or muffler. Use gloves and eye protection when servicing hot components. Contact with a hot surface or fluid can cause serious injury from burns or scalding. (SG-38)



WARNING

Do not put hands or feet under mower decks. Blade Contact can result in serious injury or even death. Stay away until all motion has stopped and the decks are securely blocked up. (SGM-9)



DANGER

Always keep a careful lookout and use extreme care when working around utility and municipal obstructions. Never allow the Mower to contact any utility, municipal, or other type structure. Clearly mark all mowing obstructions and consult local utility providers for a safe code of operation. (SPU-5)



DANGER

Do not operate the implement while wearing loose fitting clothing. Entanglement of the clothing with the rotating elements can result in serious injury or even death. Stay clear of all rotating elements at all times. (SSP-3)

Equipment Operation Safety Instructions and Practices



WARNING

Never leave the Tractor and Implement unattended while the Implement is in the lifted position. Accidental operation of lifting lever or a hydraulic failure may cause sudden drop of unit with injury or death by crushing. To properly park the implement when disconnecting it from the tractor, lower the stand and put the retaining pin securely in place, or put a secure support under the A-Frame. Lower the implement carefully to the ground. Do not put hands or feet under lifted components. (S3PT-1)

SAFETY



Use extreme care when lowering or unfolding the implement's wings. Make sure no bystanders are close by or underneath the wings. Allow ample clearance around the implement when folding or unfolding the wings. Use extreme caution around buildings or overhead power lines. (S3PT-5)



This Implement is wider than the Tractor. Be careful when operating or transporting this equipment to prevent the Implement from running into or striking sign posts, guard rails, concrete abutments or other solid objects. Such an impact could cause the Implement and Tractor to pivot violently resulting in loss of steering control, serious injury, or even death. Never allow the Implement to contact obstacles. (S3PT-12)



Be sure you have adequate knowledge of the property you will be working on. Take time to make yourself aware of any area underground lines or cables. Contact with buried lines or cable could result in **serious injury** or **death**. If in doubt about buried utility lines call 811 before digging or 1-800-258-0808. (SBH-6)



Do not operate Mower if excessive vibration exists. Shut down PTO and the Tractor engine. Inspect the Mower to determine the source of the vibration. If Mower blades are missing or damaged replace them immediately. Do not operate the mower until the blades have been replaced and the Mower operates smoothly. Operating the Mower with excessive vibration can result in component failure and broken objects to be thrown outward at very high velocities. To reduce the possibility of property damage, serious injury, or even death, never allow the Mower to be operated with blades missing.

(SFL-4)



Operate this Equipment only with a Tractor equipped with an approved roll-over-protective system (ROPS). Always wear seat belts. Serious injury or even death could result from falling off the tractor--particularly during a turnover when the operator could be pinned under the ROPS. (SG-7)



BEFORE leaving the tractor seat, always engage the brake and/or set the tractor transmission in parking gear, disengage the PTO, stop the engine, remove the key, and wait for all moving parts to stop. Place the tractor shift lever into a low range or parking gear to prevent the tractor from rolling. Never dismount a Tractor that is moving or while the engine is running. Operate the Tractor controls from the tractor seat only. (SG-9)

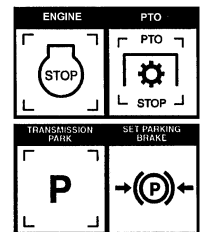

Never allow children or other persons to ride on the Tractor or Implement. Falling off can result in serious injury or death. (SG-10)



SAFETY

▲ DANGER

Never allow children to operate, ride on, or come close to the Tractor or Implement. Usually, 16-17 year-old children who are mature and responsible can operate the implement with adult supervision, if they have read and understand the Operator's Manuals, been trained in proper operation of the tractor and Implement, and are physically large enough to reach and operate the controls easily. (SG-11)



▲ WARNING

Do not mount the Tractor while the tractor is moving. Mount the Tractor only when the Tractor and all moving parts are completely stopped. (SG-12)



▲ DANGER

Start tractor only when properly seated in the Tractor seat. Starting a tractor in gear can result in injury or death. Read the Tractor operators manual for proper starting instructions. (SG-13)



▲ WARNING

Do not operate this Equipment with hydraulic oil or fuel leaking. Oil and fuel are explosive and their presence could present a hazard. Do not check for leaks with your hand! High-pressure oil streams from breaks in the line could penetrate the skin and cause tissue damage including gangrene. To check for a hose leak, SHUT the unit ENGINE OFF and remove all hydraulic pressure. Wear oil impenetrable gloves, safety glasses and use Cardboard to check for evidence of oil leaks. If you suspect a leak, REMOVE the HOSE and have it tested at a Dealer. If oil does penetrate the skin, have the injury treated immediately by a physician knowledgeable and skilled in this procedure. (SG-15)



▲ DANGER

Never run the Tractor engine in a closed building or without adequate ventilation. The exhaust fumes can be hazardous to your health. (SG-23)

▲ WARNING

Do not exceed the rated PTO speed for the Implement. Excessive PTO speeds can cause Implement driveline or blade failures resulting in serious injury or death. (SG-26)

▲ DANGER

Operate the Tractor and/or Implement controls only while properly seated in the Tractor seat with the seat belt securely fastened around you. Inadvertent movement of the Tractor or Implement may cause serious injury or death. (SG-29)

SAFETY

SAFETY

⚠ WARNING

In case of mechanical difficulty during operation, place the transmission in the park position, set the parking brake, shut down all power, including the PTO and the engine and remove the key. Wait until all rotating motion has stopped before dismounting. (SG-39)

⚠ WARNING

Do Not operate this equipment in areas where insects such as bees may attack you and/or cause you to lose control of the equipment. If you must enter in such areas, use a tractor with an enclosed Cab and close the windows to prevent insects from entering. If a tractor cab is not available, wear suitable clothing including head, face, and hand protection to shield you from the insects. Attacking insects can cause you to lose control of the tractor, which can result in serious injury or death to you or bystanders. Never dismount a moving tractor. (SG-40)

⚠ WARNING

Mow only in conditions where you have clear visibility in daylight or with adequate artificial lighting. Never mow in darkness or foggy conditions where you cannot clearly see at least 100 yards(90 m) in front and to the sides of the tractor and mower. Make sure that you can clearly see and identify passersby, steep slopes, ditches, drop-offs, overhead obstructions, power lines, debris and foreign objects. If you are unable to clearly see these type of items discontinue mowing. (SGM-1)

⚠ DANGER

There are obvious and hidden potential hazards in the operation of this Mower. REMEMBER! This machine is often operated in heavy brush and in heavy weeds. The Blades of this Mower can throw objects if shields are not properly installed and maintained. Serious injury or even death may occur unless care is taken to insure the safety of the operator, bystanders, or passersby in the area. Do not operate this machine with anyone in the immediate area. Stop mowing if anyone is within 100 yards of mower. (SGM-2)



⚠ DANGER

The rotating parts of this machine have been designed and tested for rugged use. However, the blades could fail upon impact with heavy, solid objects such as metal guard rails and concrete structures. Such impact could cause the broken objects to be thrown outward at very high velocities. To reduce the possibility of property damage, serious injury, or even death, never allow the cutting blades to contact such obstacles. (SGM-4)

⚠ WARNING

Extreme care should be taken when operating near loose objects such as gravel, rocks, wire, and other debris. Inspect the area before mowing. Foreign objects should be removed from the site to prevent machine damage and/or bodily injury or even death. Any objects that cannot be removed must be clearly marked and carefully avoided by the operator. Stop mowing immediately if blades strike a foreign object. Repair all damage and make certain rotor or blade carrier is balanced before resuming mowing. (SGM-5)



SAFETY

WARNING

Many varied objects, such as wire, cable, rope, or chains, can become entangled in the operating parts of the mower head. These items could then swing outside the housing at greater velocities than the blades. Such a situation is extremely hazardous and could result in serious injury or even death. Inspect the cutting area for such objects before mowing. Remove any like object from the site. Never allow the cutting blades to contact such items. (SGM-6)

WARNING

Mow at the speed that you can safely operate and control the tractor and mower. The correct mowing speed depends on terrain condition and grass type, density, and height of cut. Normal ground speed range is from 2 to 5 mph(3-8 kph). Use slow mowing speeds when operating on or near steep slopes, ditches, drop-offs, overhead obstructions, power lines, or when debris and foreign objects are to be avoided. (SGM-7)

WARNING

Avoid mowing in reverse direction when possible. Check to make sure there are no persons behind the mower and use extreme care when mowing in reverse. Mow only at a slow ground speed where you can safely operate and control the tractor and mower. Never mow an area that you have not inspected and removed debris or foreign material. (SGM-8)

WARNING

Do not mow with two machines in the same area except with Cab tractors with the windows closed. (SGM-11)

WARNING

Follow these guidelines to reduce the risk of equipment and grass fires while operating, servicing, and repairing the Mower and Tractor:



- Equip the Tractor with a fire extinguisher in an accessible location.
- Do Not operate the Mower on a Tractor with an underframe exhaust.
- Do Not smoke or have an open flame near the Mower and Tractor.
- Do Not drive into burning debris or freshly burnt areas.
- Ensure slip clutches are properly adjusted to prevent excessive slippage and plate heating.
- Never allow clippings or debris to collect near drivelines, slip clutches, and gearboxes. Periodically shut down the Tractor and Mower and clean clippings and collected debris from the mower deck. (SGM-12)

DANGER

The Mower is designed for certain mowing applications and is rated to cut up to a specific size vegetation (see Mower Standard Equipment and Specifications). DO NOT use this mower to cut vegetation above the Mower's rated capacity or to cut any type of non-vegetative material. Only operate this Mower on a properly sized and equipped Tractor. Operating this Mower in an application for which it is not designed and/or operating the Mower with the wrong size Tractor can cause Mower component damage and equipment failure resulting in possible serious injury or death. (SGM-14)

SAFETY



Do not operate or pull the mower into standing water. When uplift or fan type mower blades contact water they can be severely deflected downward causing possible failure of blade resulting in serious bodily injury to the operator or bystanders. (SGM-15)



Use extreme caution when raising the Mower above ground level. Stop the Blades from turning when the Mower is raised and passersby are within 100 yards. Raising the Mower exposes the Cutting Blades which creates a potentially serious hazard and can cause serious injury by objects thrown from the Blades or by contact with the Blades. (SPU-1)



Rotary Mowers are capable under adverse conditions of throwing objects for great distances (300 feet or more) and causing serious injury or death. Follow safety messages carefully.



STOP MOWING IF PASSERSBY ARE WITHIN 100 YARDS UNLESS:

- Front and Rear Deflectors, Chain Guards, or Bands are installed and in good, workable condition;
- Mower sections or Wings are running close to and parallel to the ground without exposed Blades;
- Passersby are outside the existing thrown-object zone;
- All areas have been thoroughly inspected and all foreign material such as rocks, cans, glass, and general debris has been removed.

NOTE: *Where there are grass and weeds high enough to hide debris that could be struck by the blades, the area should be: inspected and large debris removed, mowed at an intermediate height, inspected, closely with any remaining debris being removed, and mowed again at desired final height. (This will also reduce power required to mow, reduce wear and tear on the Mower drivetrain, spread cut material better, reduce streaking, and make the final cut more uniform).* (SRM-1)



Do not turn so sharp or lift mower so high to produce a severe "knocking" of the Driveline which will cause accelerated wear and breakage of drive train components and could result in possible injury from the separated Driveline sections. (SRM-4)



Do not let the Blades turn when the Mower Deck is raised for any reason, including clearance or for turning. Raising the Mower deck exposes the Cutting Blades which creates a potentially serious hazard and could cause serious injury or even death from objects thrown from the Blades. (SRM-7)



SAFETY

Connecting or Disconnecting Implement Safety Instructions and Practices



DO NOT use a PTO adapter to attach a non-matching Implement driveline to a Tractor PTO. Use of an adapter can double the operating speed of the Implement resulting in excessive vibration, thrown objects, and blade and implement failure. Adapter use will also change the working length of the driveline exposing unshielded driveline areas. Serious bodily injury and/or equipment failure can result from using a PTO adapter. Consult an authorized dealer for assistance if the Implement driveline does not match the Tractor PTO.

(S3PT-14)



Always shut the Tractor completely down, place the transmission in park, and set the parking brake before you or anyone else attempts to connect or disconnect the Implement and Tractor hitches. (S3PT-15)



Never operate the Tractor and Mower if the Implement input driveline is directly connected to the Tractor transmission. Tractor braking distances can be substantially increased by the momentum of the rotating Mower blades driving the Tractor transmission even though the Tractor clutch has been disengaged. Install an over running clutch between the Tractor PTO and the Mower driveline to prevent this potentially dangerous situation. (S3PT-16)



When attaching the Implement input driveline to the Tractor PTO, it is important that the connecting yoke spring activated locking collar slides freely and the locking balls are seated securely in the groove on the Tractor PTO shaft. A driveline not attached correctly to the Tractor PTO shaft could come loose and result in personal injury and damage to the Implement. (S3PT-17)



Before operating the Implement, check to make sure the Implement input driveline will not bottom out or become disengaged. Bottoming out occurs when the inner shaft penetrates the outer housing until the assembly becomes solid-it can shorten no more. Bottoming out can cause serious damage to the Tractor PTO by pushing the PTO into the Tractor and through the support bearings or downward onto the PTO shaft, breaking it off. A broken driveline can cause personal injury. (S3PT-18)

SAFETY

Transporting Safety Instructions and Practices



Be particularly careful when transporting the Implement with the Tractor. Turn curves or go up hills only at a low speed and using a gradual steering angle. Rear mounted implements move the center of gravity to the rear and remove weight from the front wheels. Make certain, by adding front ballast, that at least 20% of the tractor's weight is on the front wheels to prevent rearing up, loss of steering control or Tractor tip-over. Slow down on rough or uneven surfaces to prevent loss of steering control which could result in property damage or possible injury. Do not transport unless 3-Point lift lever is fully raised and in the latched transport position. Dropping implement in transport can cause serious damage to the tractor and/or Implement and possibly cause the operator or others to be injured or killed. (S3PT-2)



Allow sufficient clearance for the Implement to swing outward while turning. Implements carried behind the Tractor will swing outside the tire path when making turns. Contacting a solid object while turning will cause equipment damage and possible injury. (S3PT-20)



Make certain that the "Slow Moving Vehicle" (SMV) sign is installed in such a way as to be clearly visible and legible. When transporting the Equipment use the Tractor flashing warning lights and follow all local traffic regulations. (SG-6)

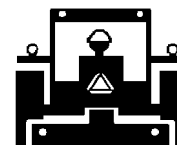

SAFETY

WARNING

Transport only at speeds where you can maintain control of the equipment. Serious accidents and injuries can result from operating this equipment at high speeds. Understand the Tractor and Implement and how it handles before transporting on streets and highways. Make sure the Tractor steering and brakes are in good condition and operate properly.



Before transporting the Tractor and Implement, determine the proper transport speeds for you and the equipment. Make sure you abide by the following rules:

Test the tractor at a slow speed and increase the speed slowly. Apply the Brakes smoothly to determine the stopping characteristics of the Tractor and Implement. As you increase the speed of the Tractor the stopping distance increases. Determine the maximum transport speed not to exceed 20 mph (30 kph) for transporting this equipment.

Test the equipment at a slow speed in turns. Increase the speed through the turn only after you determine that the equipment can be operated at a higher speed. Use extreme care and reduce your speed when turning sharply to prevent the tractor and implement from turning over. Determine the maximum turning speed for you and this equipment before operating on roads or uneven ground.



Only transport the Tractor and Implement at the speeds which allow you to properly control the equipment.

Be aware of the operating conditions. Do not operate the Tractor with weak or faulty brakes or worn tires. When operating down a hill or on wet or rain slick roads, the braking distance increases: use extreme care and reduce your speed. When operating in traffic always use the Tractor's flashing warning lights and reduce your speed. Be aware of traffic around you and watch out for the other guy. (SG-19)

DANGER

Be particularly careful when transporting the Implement using the tractor. Turn curves or go up or down hills only at a low speed and at a gradual steering angle. Make certain that at least 20% of the tractor's weight is on the front wheels to maintain safe steering. Slow down on rough or uneven surfaces. (STI-1)

WARNING

Only transport the Implement behind a properly sized and equipped Tractor which exceeds the weight of the Implement by at least 20%. DO NOT transport the Implement behind a truck or other type of vehicle. Never transport the Implement and another Implement connected in tandem. Never transport the Implement at speeds over 20 MPH. (STI-6)



WARNING

Your driving vision may be reduced or impaired by the tractor, cab, or implement. Before driving on public roadways identify any limited vision areas, and make adjustments to your operating position, mirrors, and the implement transport position so that you can clearly see the area where you will be traveling, and any traffic that may approach you. Failure to maintain adequate vision of the public roadway and traffic can result in serious injury or even death. (STI-10)

SAFETY

Maintenance and Service Safety Instructions and Practices

▲ DANGER

Make sure the PTO shield, integral driveline shields, and input shields are installed when using PTO-driven equipment. Always replace any shield if it is damaged or missing. (S3PT-8)



▲ WARNING

Relieve hydraulic pressure prior to doing any maintenance or repair work on the Implement. Place the Implement on the ground or securely blocked up, disengage the PTO, and turn off the tractor engine. Push and pull the Remote Cylinder lever in and out several times prior to starting any maintenance or repair work. (S3PT-9)



▲ DANGER

Always disconnect the main PTO Driveline from the Tractor before performing service on the Implement. Never work on the Implement with the tractor PTO driveline connected and running. Rotating Parts, Blades or Drivelines could turn without warning and cause immediate entanglement, injury or death. (S3PT-11)

▲ WARNING

Never interfere with factory-set hydraulic calibrations. Any change in calibration could cause a failure of the equipment and may result in injury. (SBH-13)

▲ WARNING

Always maintain the safety signs in good readable condition. If the safety signs are missing, damaged, or unreadable, obtain and install replacement safety signs immediately. (SG-5)

▲ WARNING

Do not modify or alter this Implement. Do not permit anyone to modify or alter this Implement, any of its components or any Implement function. (SG-8)

▲ DANGER

Never work under the Implement, the framework, or any lifted component unless the Implement is securely supported or blocked up to prevent sudden or inadvertent falling which could cause serious injury or even death. (SG-14)



▲ WARNING

Never attempt to lubricate, adjust, or remove material from the Implement while it is in motion or while tractor engine is running. (SG-20)

SAFETY

WARNING

Periodically inspect all moving parts for wear and replace when necessary with authorized service parts. Look for loose fasteners, worn or broken parts, and leaky or loose fittings. Make sure all pins have cotter pins and washers. Serious injury may occur from not maintaining this machine in good working order. (SG-21)

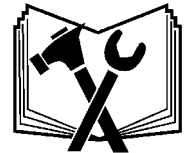

DANGER

Do Not fill gasoline tank while engine is running. Refuel only after engine has cooled down. If gasoline is spilled, move machine away from the area of the spill and avoid creating any source of ignition until the gasoline has evaporated. (SG-28)

WARNING

Perform service, repairs and lubrication according to the maintenance section. Ensure the unit is properly lubricated as specified in the lubrication schedule and all bolts and nuts are properly torqued. Failure to properly service, repair and maintain this Implement in good operating condition could cause component failure and possible serious injury or even death. (SG-35)

WARNING

Use caution and wear protective gloves when handling sharp objects such as blades, knives, and other cutting edges. Be alert to worn component surfaces which have sharp edges. Sharp surfaces can inflict severe laceration injuries if proper hand protection is not worn. (SG-37)

DANGER

All Safety Shields, Guards and Safety devices including (but not limited to) - the Deflectors, Chain Guards, Steel Guards, Gearbox Shields, PTO integral shields, and Retractable Door Shields should be used and maintained in good working condition. All safety devices should be inspected carefully at least daily for missing or broken components. Missing, broken, or worn items must be replaced at once to reduce the possibility of injury or death from thrown objects, entanglement, or blade contact. (SGM-3)

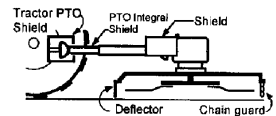

DANGER

Replace bent or broken blades with new blades. NEVER ATTEMPT TO STRAIGHTEN, WELD, OR WELD HARDFACING ON BLADES SINCE THIS WILL LIKELY CRACK OR OTHERWISE DAMAGE THE BLADE WITH SUBSEQUENT FAILURE AND POSSIBLE SERIOUS INJURY FROM THROWN BLADES. (SGM-10)

WARNING

DO NOT weld or repair rotating mower components. Welds and other repairs may cause severe vibration and/or component failure resulting in part being thrown from the mower causing serious bodily injury. See your Authorized Dealer for proper repairs. (SGM-13)

SAFETY

SAFETY

PARTS INFORMATION

Alamo Industrial mowers use balanced and matched system components for blade carriers, blades, cuttershafts, knives, knife hangers, rollers, drivetrain components, and bearings. These parts are made and tested to Alamo Industrial specifications. Non-genuine "will fit" parts do not consistently meet these specifications. The use of "will fit" parts may reduce mower performance, void mower warranties, and present a safety hazard. Use genuine Alamo Industrial mower parts for economy and safety. (SPRM-1)

SEE YOUR ALAMO DEALER



Be sure you have adequate knowledge of the property you will be working on. Take time to make yourself aware of any area underground lines or cables. Contact with buried lines or cable could result in **serious injury or death**. (STL-1)



In wet conditions where there is a likelihood of material collecting on the Implement, make certain that this material is removed before traveling on public roadways. (STL-7)

Concluding Safety Instructions and Practices

In addition to the design and configuration of this Implement, including Safety Signs and Safety Equipment, hazard control and accident prevention are dependent upon the awareness, concern, prudence, and proper training of personnel involved in the operation, transport, maintenance, and storage of the machine. Refer also to Safety Messages and operation instruction in each of the appropriate sections of the Tractor and Equipment Manuals. Pay close attention to the Safety Signs affixed to the Tractor and Equipment. (SG-18)

SAFETY

Decal Location

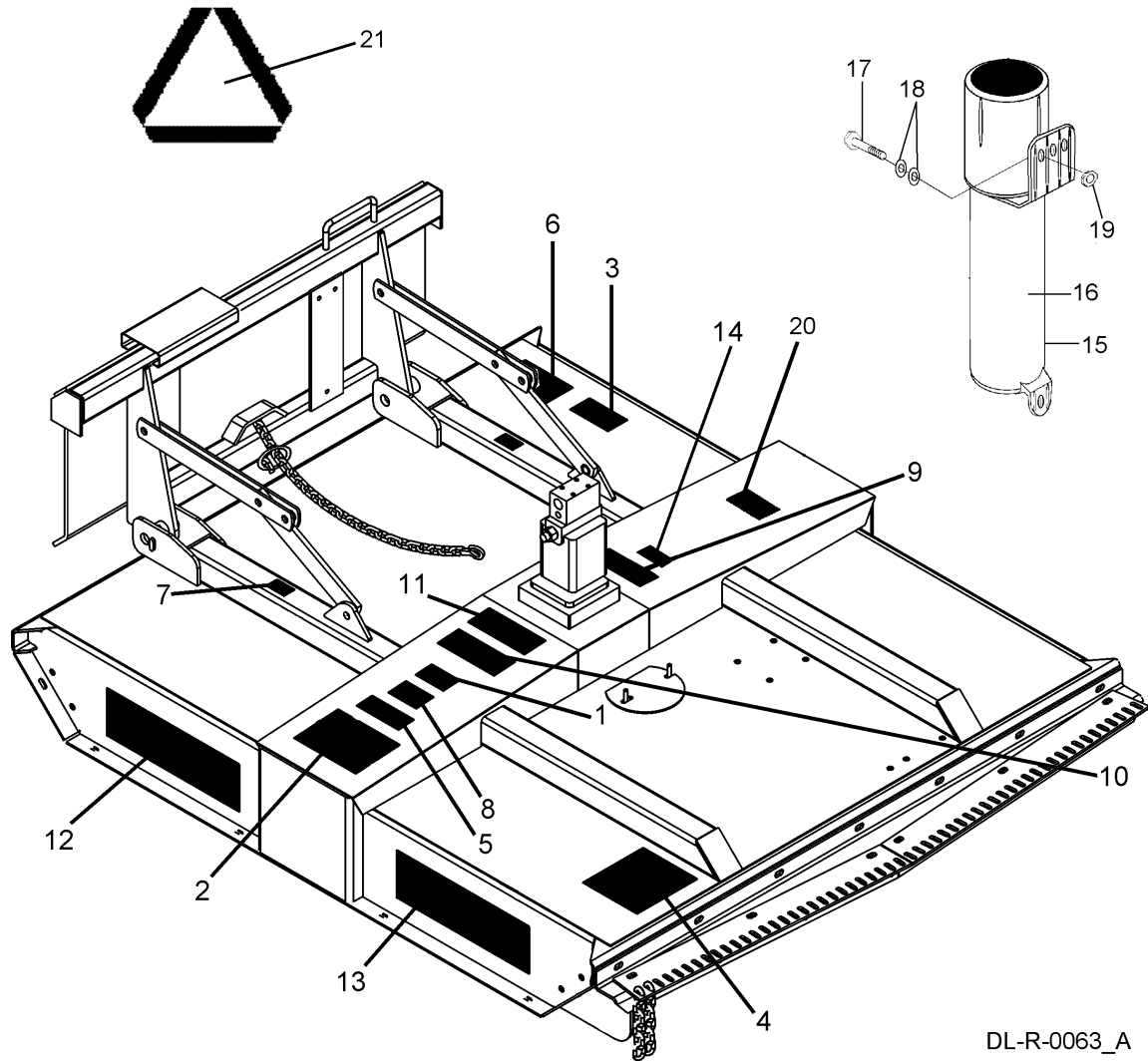

DL-R-0063_A

NOTE: Rhino supplies safety decals on this product to promote safe operation. Damage to the decals may occur while in shipping, use, or reconditioning. Rhino cares about the safety of its customers, operators, and bystanders, and will replace the safety decals on this product in the field, free of charge (Some shipping and handling charges may apply). Contact your Rhino dealer to order replacement decals.

SAFETY

SAFETY

SAFETY

ITEM	PART NO.	QTY	TYPE	DESCRIPTION
1-14	00776621			Decal Sheet
1.	00725746	1	PELIGRO	Translate Safety Material
2.	00749117	1	DANGER	Multi-Hazard
3.	00755742	1	DANGER	Cutting Blades/Thrown Objects
4.	00769737	1	DANGER	Blades/ Thrown Objects
5.	00776607	1	WARNING	Max Cut
6.	00776608	1	WARNING	No Step
7.	02962764	2	DANGER	Pinch Point
8.	00776609	1	DANGER	Protect Operator
9.	00756059	1	DANGER	Oil Leak
10.	02925100	1	IMPORTANT	Genuine Alamo Parts
11.	00763977	1	INSTRUC	Notice to Owner
12.	00757139	2	LOGO NAME	Alamo Industrial Name
13.		1	NAME	SL60
14.	NFS	1	-----	Flow Decal
15.	00776031	1	-----	Canister, Operators Manual
16.	00776405C	1	-----	Operators Manual
17.	10058000	3	-----	Bolt
18.	00024100	6	-----	Flatwasher
19.	02959924	3	-----	Locknut
20.	00778036	1	WARNING	Implement Weight
21.	03200347	*	REFLCTR	SMV Sign

* Supplied by Tractor Manufacturer. Replace if missing from tractor.

SAFETY

SAFETY

Decal Description

Peligro Translation, If you do not know how to read English, please find someone who knows how to read English.

P/N 00725746



DANGER! Multi-Hazard Decal (Refer To Front Cover)

P/N 00749117



DANGER! Keep Away

P/N 00755742



DANGER! Keep Away Thrown Objects. Inspect the area before mowing and remove foreign material that could become mower thrown objects.

P/N 00769737

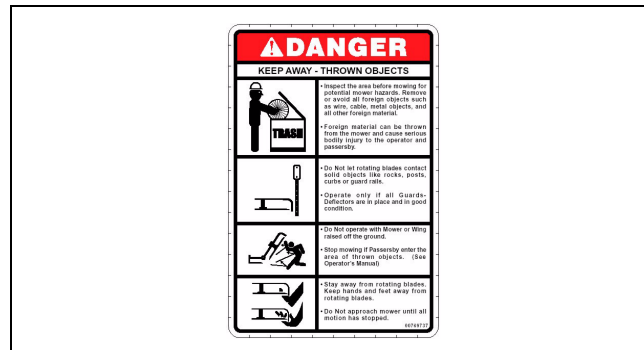

SAFETY

DANGER! - Maximum Cutting Height is 18". Do Not operate Mower above 18".

00776607

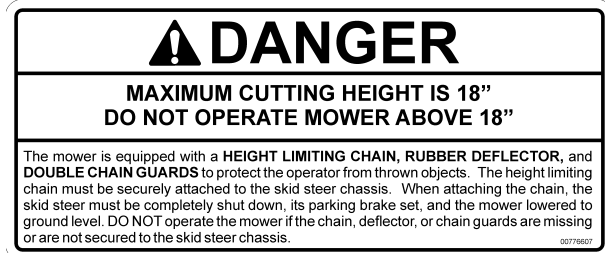

WARNING! - Not a Step. Do not board from this side.

00776608



WARNING! Pinch Points

P/N 02962764



DANGER! - Protect Operator with Front Door. The Skid Steer must be equipped with an Operator Front Protective Door. Serious injury or death can result from a thrown object hitting an unprotected operator.

00776609



SAFETY

SAFETY

WARNING! Never use your hand to check for oil leaks. Always use paper or cardboard.

P/N 00756059

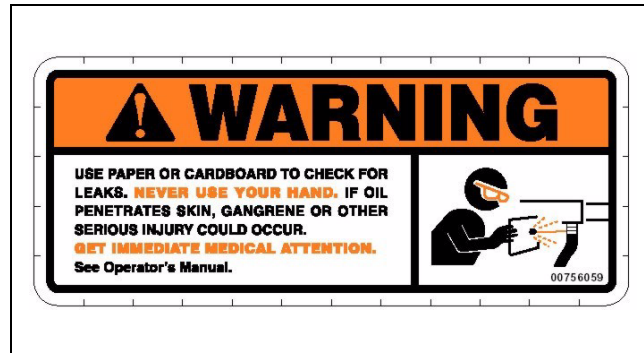

For safety and to guarantee optimum product reliability always use genuine RHINO replacement parts.

P/N 00760657

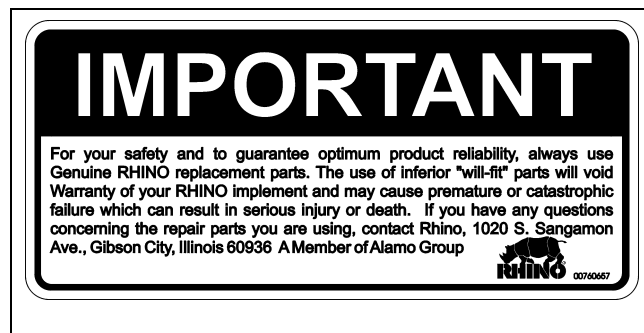

Operator's Manual (with repair parts) and warranty was attached to this implement during final inspection.

P/N 00763977

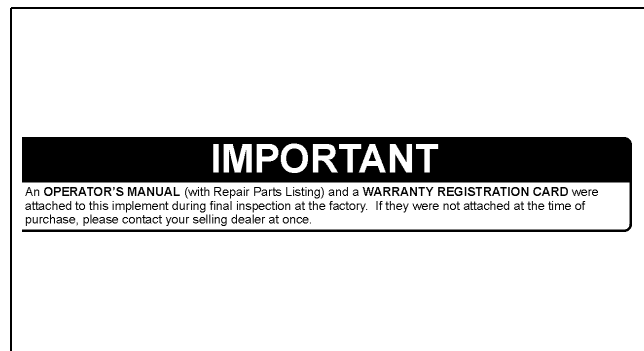

Name LOGO - Alamo Industrial

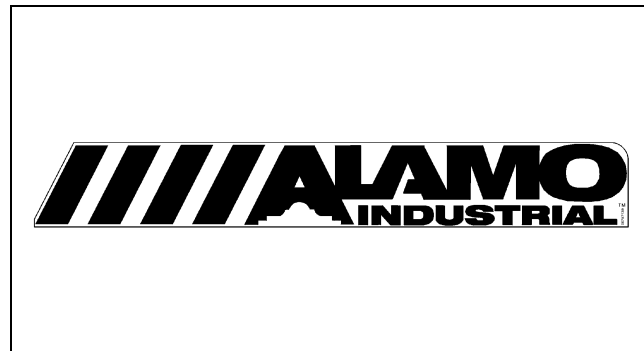

P/N 00757139

SAFETY

SAFETY

NAME LOGO - SL60



SL60

Read Operator's Manual! The operator's manual is located inside this canister. If the manual is missing order one from your dealer.

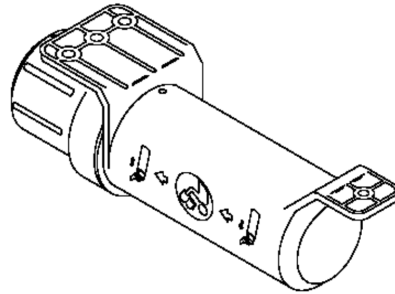

P/N 00776031

Slow Moving Vehicle Decal. Keep SMV reflector clean and visible. DO NOT transport or operate without the SMV.

Provided by Tractor Manufacturer. Replace if missing on tractor.

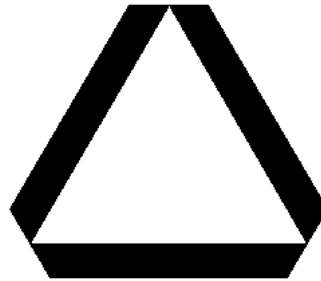

P/N 03200347

SAFETY

SAFETY

Federal Laws and Regulations

This section is intended to explain in broad terms the concept and effect of federal laws and regulations concerning employer and employee equipment operators. This section is not intended as a legal interpretation of the law and should not be considered as such.

Employer-Employee Operator Regulations

U.S. Public Law 91-596 (The Williams-Steiger Occupational and Health Act of 1970) OSHA

This Act Seeks:

“...to assure so far as possible every working man and woman in the nation safe and healthful working conditions and to preserve our human resources...”

DUTIES

Sec. 5 (a) Each employer-

(1) shall furnish to each of his employees employment and a place of employment which are free from recognized hazards that are causing or are likely to cause death or serious physical harm to his employees;

(2) shall comply with occupational safety and health standards promulgated under this Act.

(b) Each employee shall comply with occupational safety and health standards and all rules, regulations and orders issued pursuant to this Act which are applicable to his own actions and conduct.

OSHA Regulations

OSHA regulations state in part: “At the time of initial assignment and at least annually thereafter, the employer shall instruct every employee in the safe operation and servicing of all equipment with which the employee is, or will be involved.”

Employer Responsibilities:

To ensure employee safety during Tractor and Implement operation, it is the employer’s responsibility to:

1. Train the employee in the proper and safe operation of the Tractor and Implement.
2. Require that the employee read and fully understand the Tractor and Implement Operator’s manual.
3. Permit only qualified and properly trained employees to operate the Tractor and Implement.
4. Maintain the Tractor and Implement in a safe operational condition and maintain all shields and guards on the equipment.
5. Ensure the Tractor is equipped with a functional ROPS and seat belt and require that the employee operator securely fasten the safety belt and operate with the ROPS in the raised position at all times.
6. Forbid the employee operator to carry additional riders on the Tractor or Implement.
7. Provide the required tools to maintain the Tractor and Implement in a good safe working condition and provide the necessary support devices to secure the equipment safely while performing repairs and service.
8. Require that the employee operator stop operation if bystanders or passerbys come within 25 feet.

Child Labor Under 16 Years of Age

Some regulations specify that no one under the age of 16 may operate power machinery. It is your responsibility to know what these regulations are in your own area or situation. (Refer to U.S. Dept. of Labor, Employment Standard Administration, Wage & Home Division, Child Labor Bulletin #102.)



Safety Manual

*For Operators
and Mechanics*

Industrial/ Agricultural Mower

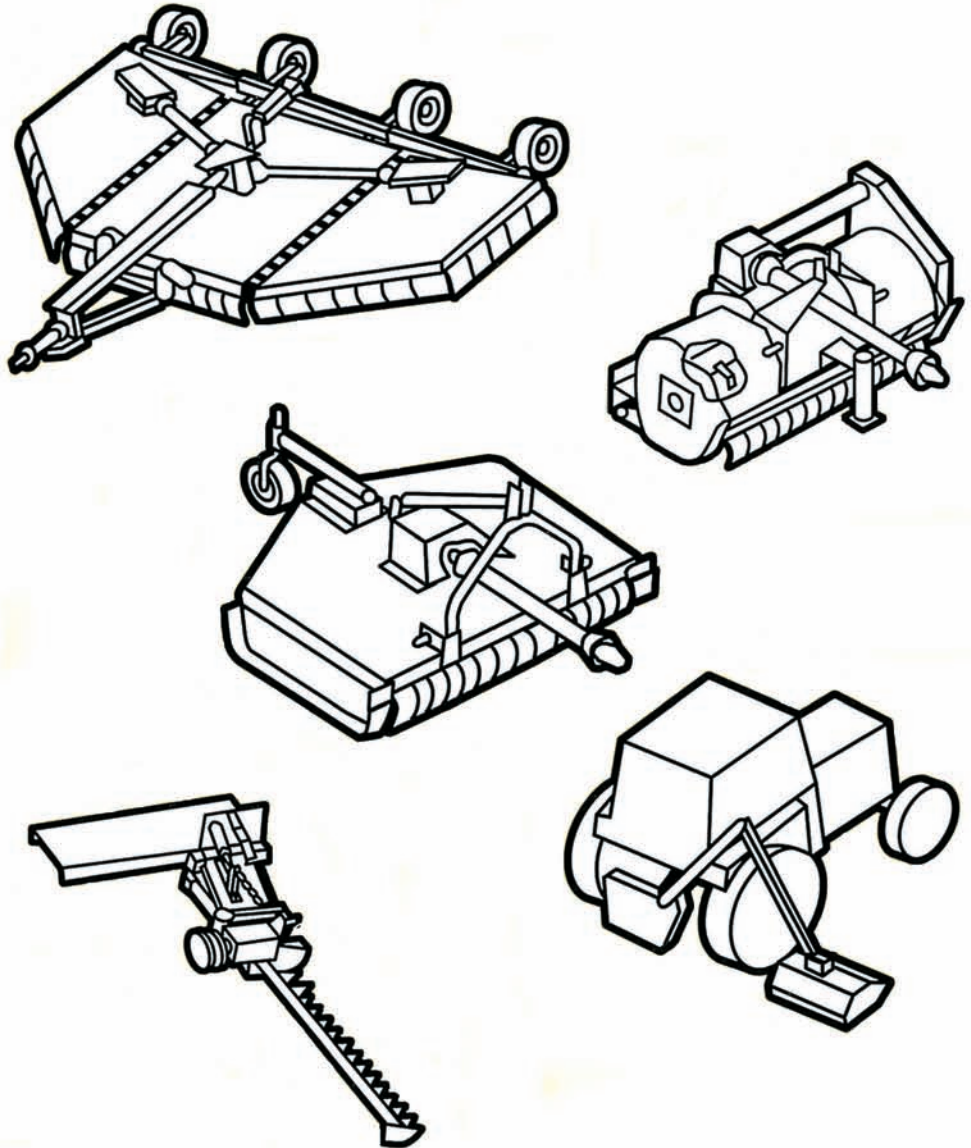

111 E. Wisconsin Avenue • Milwaukee, Wisconsin 53202 U.S.A.
www.aem.org

Contents

Acknowledgement	2
Forward	3
A Word to the User	3
Safety Alert Symbol	4
Industrial/Agricultural Mower Types	4
Be a Responsible Operator	5
Safety Management of Hazards and Risks	6
Follow a Safety Program	11
Safety-Before Operation	11
Safety-Starting and Testing	13
Safety-During Operation	14
Safety-During Shutdown	18
Safety-During Maintenance	19
One Final Word	21

Acknowledgement

We wish to acknowledge the contributions of the members of the Association of Equipment Manufacturers to the preparation of this Safety Manual.

Copyright
© 2000 AEM (formerly Equipment Manufacturers Institute). Revised 08.2003. All rights reserved.

Forward

This Safety Manual is intended to point out some of the basic safety situations which may be encountered during the normal operation and maintenance of your machine and to suggest possible ways of dealing with these conditions. This manual is NOT a substitute for the manufacturer's manual(s).

Additional precautions may be necessary, or some instructions may not be applicable, depending on the equipment, attachment devices, and conditions at the worksite or in the service area. The manufacturer has no direct control over machine application, operation, inspection, lubrication, or maintenance. Therefore, it is **YOUR** responsibility to use good safety practices in these areas.

The information provided in this manual supplements the specific information about your machine that is contained in the manufacturer's manual(s). Other information which may affect the safe operation of your machine may be contained on safety signs or in insurance requirements, employer's safety and training programs, safety codes, local, state/provincial and national laws, rules and regulations.

IMPORTANT: *If you do not have the manufacturer's manual(s) for your particular machine, get a replacement manual from your employer, equipment dealer, or the manufacturer of your machine. Keep this safety manual and the manufacturer's manual(s) with your machine.*

A Word to the User

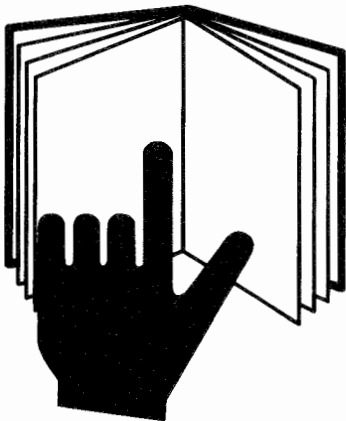

It is your responsibility to read and understand this safety manual and the manufacturer's manual(s) before operating this machine. This safety manual takes you step-by-step through your working day. The safety manual, manufacturer's manual(s), safety signs (decals) and safety precautions must be explained to those users or operators who cannot read the material.

In addition to equipment design and configuration, **HAZARD CONTROL** and **ACCIDENT PREVENTION** are dependent upon the owner's and operator's awareness, concern, prudence, and proper training in the operation, transport, maintenance and storage of equipment.

Remember that **YOU** are the key to safety. Good safety practices not only protect you but also protect the people around you. Study this manual and the manufacturer's manual(s) for your specific machine. Make them a working part of your safety program. Keep in mind that this safety manual is written only for industrial and agricultural mowers.

Practice all usual and customary safe working precautions and above all – remember safety is up to YOU. Only YOU can prevent serious injury or death from unsafe practices.

Safety Alerts

Symbol

This Safety Alert Symbol means:

**“ATTENTION! BECOME ALERT!
YOUR SAFETY IS INVOLVED!”**

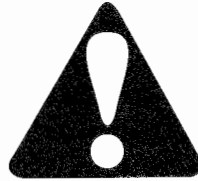

The Safety Alert Symbol identifies important safety messages on equipment, safety signs, in manuals or elsewhere. When you see this symbol, be alert to the possibility of death or personal injury. Follow the instructions in the safety message.

Signal Words

Signal words are distinctive words that will typically be found on safety decals on this equipment or other equipment on the worksite. These words are intended to alert the viewer to the existence and relative degree of a hazard.



This signal word indicates an imminently hazardous situation which, not avoided, will result in death or serious injury.



This signal word indicates a potentially hazardous situation which, if not avoided, could result in death or serious injury.



This signal word indicates a potentially hazardous situation exists which, if not avoided, may result in minor or moderate injury.

- ACCIDENTS DISABLE AND KILL.
- ACCIDENTS COST.
- ACCIDENTS CAN BE AVOIDED.

Industrial/Agricultural Mowers

A mower for pasture clipping, crop residue shredding, heavy brush cutting for land clearing, waterways, right-of-ways, road side or highway mowing.

INDUSTRIAL/AGRICULTURAL MOWER TYPES:

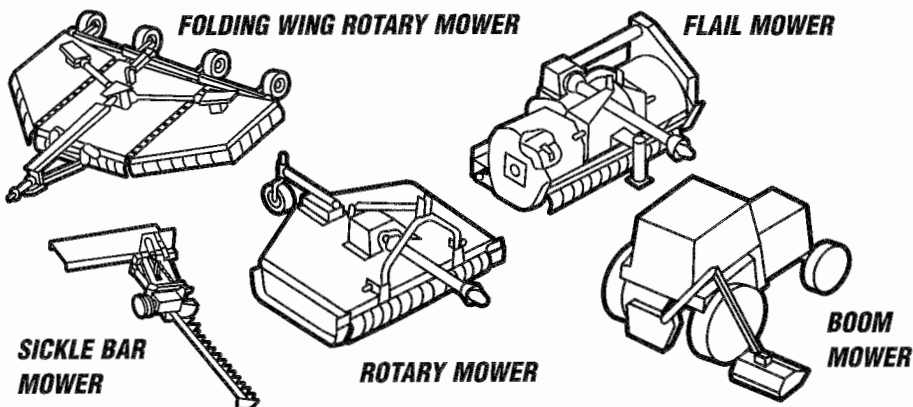

Be a Responsible Operator



DON'T
Drink & Drive



DON'T
Take
Drugs & Drive

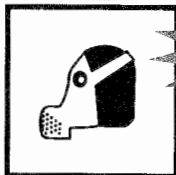
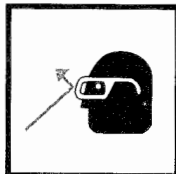
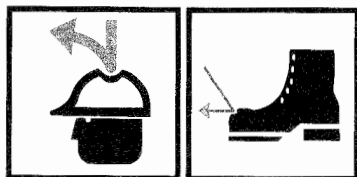

PROTECT
Yourself



CALL
For Assistance

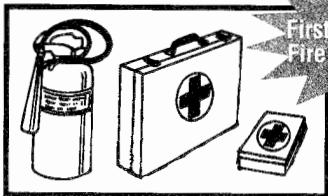

LOCATE
First Aid Kits and
Fire Extinguisher

For safe operation of your equipment, you must be a responsible operator. A responsible operator must clearly understand the written instructions supplied by the manufacturer, be trained—including actual operation of the equipment and know the safety rules and regulations for the worksite.

Drugs and alcohol will affect an operator's alertness and coordination and therefore affect the operator's ability to operate the equipment safely. An operator should **NEVER** use drugs which affect alertness, judgement and coordination or alcohol while operating motorized equipment, including tractors and mowers. An operator on prescription or over-the-counter medication must consult a medical professional regarding any side effects of the medication that would hinder his or her ability to operate this equipment safely. **NEVER** knowingly allow anyone to operate this equipment when their alertness, judgement or coordination is impaired.

Protect Yourself

Wear all the protective clothing and personal safety devices issued to you or called for by job conditions.

You may need:

- Hard hat
- Safety shoes
- Safety glasses with side shields, goggles or face shield
- Heavy gloves
- Hearing protection
- Reflective clothing
- Wet weather gear
- Respirator or filter mask

Wear adequate clothing for the job conditions.

Always know where to get assistance in the case of an emergency. Know where to find and how to use a first aid kit and fire extinguisher/fire suppression system.

**Stay alert. Avoid accidents.
Don't learn safety the hard way.**

Safety Management of Hazards and Risks

In addition to equipment design and configuration, **HAZARD CONTROL** and **ACCIDENT PREVENTION** are dependent upon the owner's and operator's awareness, concern, prudence, and proper training in the operation, transport, maintenance and storage of equipment.

SAFETY MANAGEMENT OF HAZARDS AND RISKS IS ESSENTIAL TO RESPONSIBLE OWNERS AND OPERATORS OF TRACTORS AND MOWERS.

REVIEW THE FOLLOWING SAFETY MANAGEMENT OF LISTED HAZARDS AND RISKS:

Thrown Object Hazard

POSSIBLE THROWN OBJECT INJURY RISKS EXIST FOR MOWER OPERATORS AND BYSTANDERS DURING MOWER OPERATIONS FROM THE FOLLOWING:

DISCHARGED OBJECTS (ROCKS, DEBRIS, BROKEN MOWER BLADES, BLADE BOLTS, CABLES, CHAINS, WIRE, ETC....) FROM THE MOWER.

Equipment Protective Devices And Recommended Safety Practices

The mower deck and protective devices cannot prevent all objects or debris from escaping the blade enclosure area in every mowing condition. It is possible for objects to escape and travel several hundred (300) feet.

RECOMMENDED SAFETY PRACTICES

Read manufacturer's operator manual(s) for recommended operating safety practices. Explain the practices to users or operators who cannot read.

TO HELP PREVENT SERIOUS INJURY OR DEATH FROM OBJECTS STRIKING OPERATOR OR OTHER PERSONS DO THE FOLLOWING:

BYSTANDERS SAFETY

- Keep bystanders several hundred (300) feet from mowing area.

EQUIPMENT PROTECTIVE DEVICES SAFETY

To contain, deflect or reduce thrown objects from blade enclosure area:

- Keep chain, flexible or solid deflector shields in place on the front and rear of the mower deck and in good repair.
- Do not operate with damaged or missing thrown object shielding.

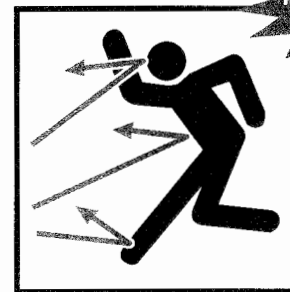
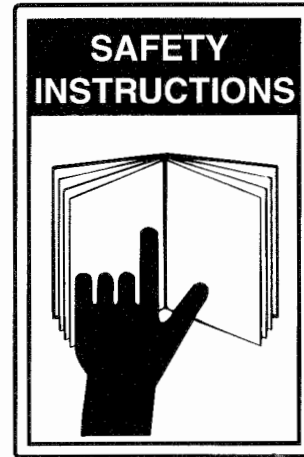

THROWN Object Hazard

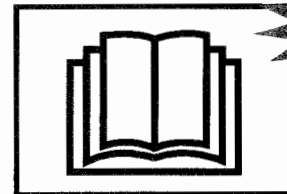

READ Manuals

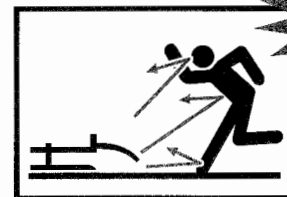

KEEP Bystanders Away

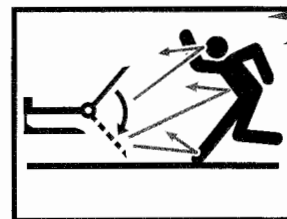

THROWN Object Hazard

**USE ROPS
Enclosed Cabs
or Protective
Enclosures**

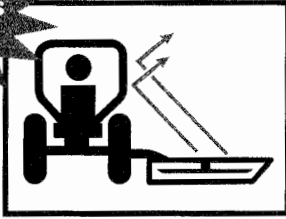

**USE Proper
PTO Speed**

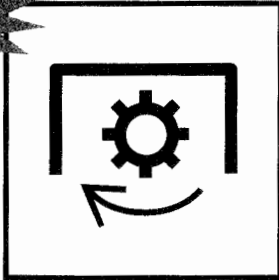

**MAINTAIN
Equipment**

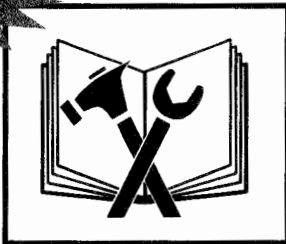

OPERATOR SAFETY

Raised wings, side mount and boom type mower operations may reduce the mower's thrown object shielding effectiveness for the mower operator's protection.

Do the following to increase operator protection from thrown objects during these mowing operations:

- Use enclosed ROPS cabs, special protective enclosures, screens or other operator shielding devices when performing these operations.

EXCEEDING RECOMMENDED PTO SPEEDS

Do not exceed manufacturer's recommended PTO speeds.

Excessive PTO speeds may cause:

- Blade failures
- Higher velocity objects escaping or broken blades being thrown from mower blade enclosures.
- Potential 540 rpm driveline failures operating at 750 to 1000 rpm speeds.

OTHER SAFETY PRACTICES:

- Never operate mower with broken, bent, missing, or severely worn blades.
- Before mowing, remove debris and foreign objects to avoid them being picked up and thrown out by the mower.
- * Do not operate the mower in transport or in raised wing positions.

RECOMMENDED MAINTENANCE PRACTICES

Read manufacturer's operator manual(s) inspection and maintenance instructions for chain guards, flexible or solid deflector shielding:

- Replace worn or damaged guards and other shielding before mowing.
- Use only manufacturer's replacement guards and shielding. Other guarding or shielding sources may not fit or have inadequate materials to meet the strength requirements of the equipment.
- Replace worn or damaged decals and warning instructions.
- Explain the inspection and maintenance instructions to those users or operators who cannot read.

Rotating Blades and Driveline Hazards and Risks

A POSSIBLE INJURY RISK EXISTS TO MOWER OPERATORS AND BYSTANDERS DURING MOWING OPERATIONS FROM THE FOLLOWING:

- BODY CONTACT WITH ROTATING BLADES.
- BODY ENTANGLEMENT WITH ROTATING DRIVELINES AND PARTS.

Equipment Protective Devices and Recommended Safety Practices

RECOMMENDED SAFETY PRACTICES

Read manufacturer's operator manual(s) for recommended operating safety practices. Explain the practices to those users or operators who cannot read. To help prevent serious injury or death from moving blade contact, driveline or parts entanglement of operators or other persons do the following:

BYSTANDERS SAFETY

- Do not operate near bystanders.
- Keep other persons several hundred (300) feet from the mowing area.

OPERATOR SAFETY PRACTICES

- Do not allow riders on tractor or mower. Securely fasten seat belt when mowing.
- Use proper equipment shutdown practice before servicing, adjusting, cleaning or unclogging the mower.
- Keep clear of rotating blades, parts, and drivelines.
- Never start tractor engine while standing beside equipment.
- Only start tractor engine while sitting in operator's seat with seat belt fastened.

RECOMMENDED GUARDS, DRIVELINE GUARDS AND SHIELDING SAFETY PRACTICES

- Keep guards, driveline and other shielding in place and in good repair.
- Do not operate mower with missing or damaged guards, driveline guards or other shielding.

RECOMMENDED MAINTENANCE PRACTICES

Read manufacturer's operator manual(s) inspection and maintenance instructions for guards, driveline guards and other shielding:

- Replace worn or damaged guards, driveline guards and other shielding before mowing.
- Use only manufacturer's replacement guards and shielding. Other guarding or shielding sources may not fit or have inadequate materials to meet the strength requirements of the equipment.
- Replace worn or damaged decals and warning instructions.
- Explain the inspection and maintenance instructions to those users or operators who cannot read.

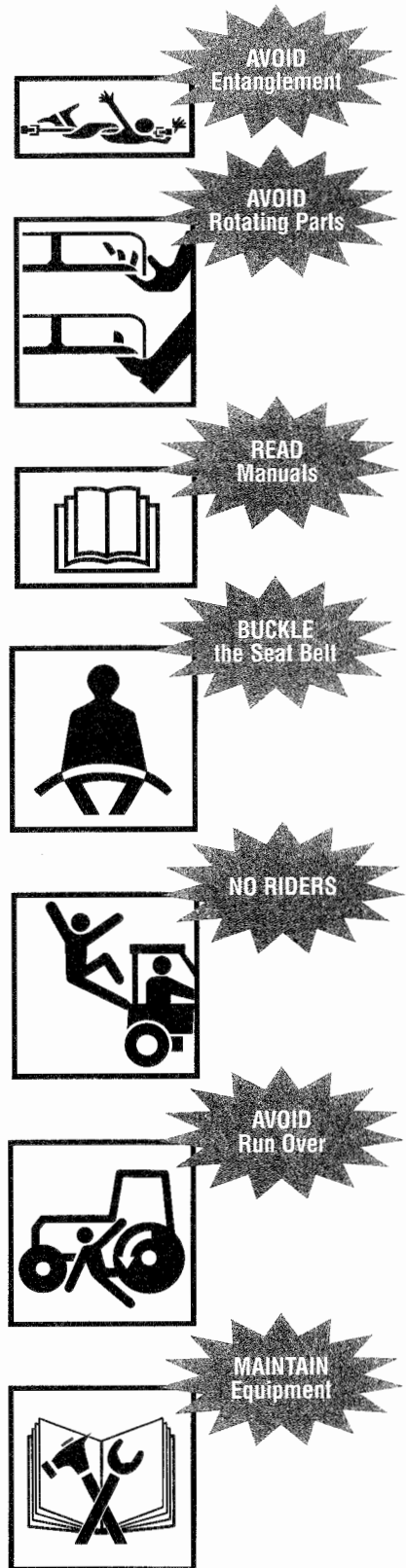

Tractor and Mower Rollover or Overturn Hazards and Risks

A POSSIBLE ROLLOVER OR OVERTURN INJURY RISK EXISTS TO MOWER OPERATORS DURING MOWING OPERATIONS FROM THE FOLLOWING:

- ROUGH TERRAIN, STEEP SLOPES, HOLES, BUMPS, RUTS, ROCKS, STUMPS OR OTHER OBSTRUCTIONS THAT COULD OVERTURN TRACTOR AND MOWER.
- EXCESSIVE GROUND SPEEDS FOR THESE TERRAIN CONDITIONS.

Equipment Protective Devices and Recommended Safety Practices

When possible remove stumps, stones, etc.. or mark them and other obstructions clearly to avoid upsets, breakdowns, and dangerous driving conditions. Use extreme care to maintain control over the equipment when operating in these terrain conditions.

RECOMMENDED-TRACTOR ROPS

A tractor equipped with ROPS or enclosed ROPS cab and seat belt for operator safety is essential for additional operator protection when operating mower in these terrain conditions.

RECOMMENDED-TRACTOR STABILITY ADJUSTMENTS

Read the tractor operator's manual for adjustments to increase tractor stability:

- Adding front and rear wheel weights or ballast.
- Adjusting wheel spacing to maximum width .
- Adding off-side counter ballast to side-mounted and boom mowers.
- Explain adjustments to those users or operators who cannot read.

RECOMMENDED SAFETY PRACTICES

Read manufacturer's operator manual(s) for recommended operating safety practices. Explain the practices to those users or operators who cannot read. **To help prevent serious injury or death to the operator from tractor and mower overturns, do the following:**

- Securely fasten seat belt when mowing with ROPS equipped tractors.
- Avoid excessive ground speed for terrain conditions.
- Avoid sudden starts, stops and turns when operating up, down or across slopes.
- Avoid slippery ground conditions.
- Make wide and gradual turns.
- Plan to mow down hill on steep slopes to avoid overturning.

Falling Mower or Parts Crushing Hazards and Risks

A POSSIBLE CRUSHING INJURY RISK EXISTS FOR MOWER OPERATORS AND OTHERS DURING MOWING OPERATIONS FROM THE FOLLOWING:

- FALLING MOWER OR EQUIPMENT FROM HYDRAULIC SYSTEM FAILURE.
- FAILURE TO SECURELY SUPPORT, BLOCK-UP OR LOCK-UP LIFTED MOWER OR EQUIPMENT PARTS.

**AVOID
Rollover**

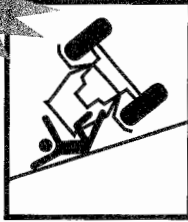

**USE
Tractor ROPS**



**READ
Manuals**

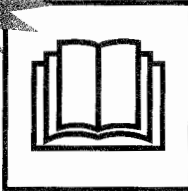

**ADD
Ballast**



**WIDEN
Wheel Spacing
and ADD Off-Side
Ballast**



**BUCKLE
the Seat Belt**



**AVOID
CRUSHING
Lock-Up Wing**



Equipment Protective Devices and Recommended Safety Practices

Read manufacturer's operator manual(s) for recommended operating safety practices. Explain the practices to those users or operators who cannot read. **To help prevent serious injury or death to operators and other from alling mower or equipment parts, do the following:**

RECOMMENDED SAFETY PRACTICES

Before working near or underneath lifted mower or equipment parts:

- Use proper equipment shutdown practices before servicing, adjusting, cleaning or unclogging the mower.
- Securely support or block-up raised mower or equipment parts.
- Securely support, block-up or lock-up wings with locking devices on wing type mowers or lower mower or equipment parts to the ground.
- Use transport locks when transporting mower on public roads.

High Pressure Hydraulic Fluid Leak Hazards and Risks

A POSSIBLE HIGH PRESSURE FLUID SKIN INJECTION INJURY AND GANGRENE RISK EXISTS FOR MOWER OPERATORS AND OTHERS FROM HIGH PRESSURE HYDRAULIC OR DIESEL OIL LEAK INJECTION INTO THE SKIN.

TO AVOID GANGRENE, INJECTED FLUID MUST BE SURGICALLY REMOVED WITHIN A FEW HOURS BY A DOCTOR FAMILIAR WITH THIS TYPE OF INJURY.

RECOMMENDED SAFETY PRACTICES

Read manufacturer's operator manual(s) for recommended operating safety practices. Explain the practices to those users or operators who cannot read. High pressure fluid pinhole leaks can be almost invisible.

To help prevent serious injury or death, do the following:

- Search for leaks with cardboard or wood.
- Do not use hands to check for leaks.
- Relieve system pressure before disconnecting lines.
- Before applying system pressure:
 - Check for damaged lines, pipes, and hoses.
 - Check to insure tight connections.
- Before operating pressurized systems:
 - Purge air from system.
 - Refer to the manufacturer's operator manual(s) for instructions.
 - Explain the procedures to those users or operators who cannot read.

Tractor Refueling Hazards and Risks

To avoid serious injury or death from fire during refueling:

- Shut off engine and ignition.
- Never fill fuel tank near open flames.
- Never smoke while refueling.
- Avoid static electricity sparks by grounding fuel nozzle against tank filler neck.
- Avoid overfilling tank or spilling fuel.
- Clean up any spilled fuel immediately.
- Always replace fuel cap.

To avoid serious injury or death from engine exhaust fumes:

- Adequately ventilate enclosed spaces before starting the engine.

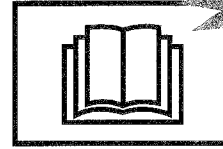

**READ
Manuals**

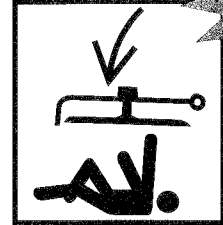

**AVOID
CRUSHING
Block-Up or
Securely Support
Mower**



**HIGH
PRESSURE FLUID
Can Inject
into the Body**

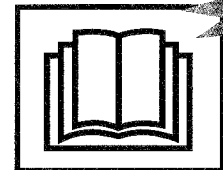

**READ
Manuals**

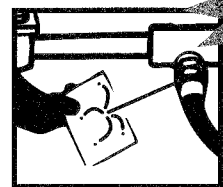

**AVOID
INJECTION
Use Cardboard
Not Hands**



**AVOID
Fires and
Explosions**

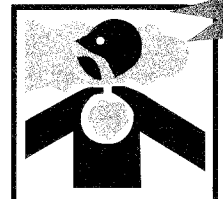

**AVOID
Exhaust Fumes**

Follow A Safety Program

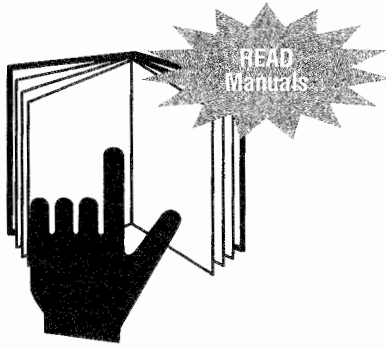

SAFETY IS IMPORTANT TO RESPONSIBLE OWNERS AND OPERATORS OF TRACTORS AND MOWERS. DO THE FOLLOWING FOR YOUR SAFE MOWING OPERATION:

BE A QUALIFIED OPERATOR BY:

- Reading, understanding and obeying the manufacturer's written instructions in operator manual(s) and safety signs on mower and tractor.
- Receiving operational training with mower and tractor.
- Asking your equipment dealer or supervisor to explain things you do not understand.
- Explaining the written instructions in the operator manual(s) and safety signs (decals) on the mower and tractor to those users or operators who cannot read.

Safety Before Operation

Know Job Site Safety Rules And Regulations

Ask your supervisor about equipment operation safety rules you will be expected to obey.

Some basic rules for your's and others' safety:

- A ROPS and seat belt equipped tractor is required for operator protection during mowing operations.
- Know mower and tractor operating capacity and characteristics.
- Never alter or remove safety equipment.
- Never allow children or unqualified persons to operate mower or tractor.
- Never allow riders on mower or tractor.
- Keep others away from mowing operation.
- Use proper equipment shutdown practice before dismounting tractor.
- Allow all moving parts to stop before making equipment inspections, repairs, or adjustments.
- Securely support or block-up mower before working beneath mower or lifted components.
- Wear personal protective clothing and safety devices issued to you or recommended by the equipment manufacturer.



Know Tractor And Mower Controls

Know the following about your tractor and mower:

- Function, purpose and use of controls.
- Safe operating speeds.
- Safe slope and uneven terrain capabilities.
- Braking and steering characteristics.
- Tractor and mower operating clearances.
- How to stop equipment quickly in an emergency.

Use All Available Equipment Safety Devices

To help keep you and others around you safe:

- Make certain manufacturer's recommended guards, shields and safety signs are installed on equipment and in good condition.
- Keep all protective devices in place and securely fastened.
- **NEVER** operate your equipment with missing, disconnected or damaged safety devices.
- Use ballast and weight required for equipment operational stability.

Check The Mower And Tractor Equipment

Before beginning your work day:

- Check for loose, broken, missing or damaged tractor and mower parts.
- Repair or replace these parts when needed.
- Check for proper tractor and mower attachments.
- Check for proper tractor and mower PTO rpm rating match.
- Check mower blades condition. Sharpen or replace per manufacturer's recommendation. Blade modifications, such as welding or hard surfacing cutting edges by welding or straightening bent blades, can reduce blade strength and adversely affect blade properties and safety.
- Check that all guards and shields are in place and that all equipment is in good operating condition. This includes PTO driveline, gearbox and implement guards and shields that are used for operator protection.
- Check for properly latched driveline yoke end locking devices.
- Check for damaged or leaky tractor and mower hydraulic systems.
- Check and read safety signs and warning instructions.
- Explain the safety signs and warning instructions to those users or operators who cannot read.

Check The Work Area

Inspect, identify and avoid hazardous conditions in the work area:

- Rough terrain, drop-offs, ditches, potholes steep slopes, stumps, standing water, mud soft soil, slippery conditions, debris and foreign objects.
- Inspect mowing area and remove or mark all foreign objects and debris to be avoided by mower.

Analyze mowing area to determine:

- Best and safest mowing procedure.
- Material type and height to be mowed.
- Operating terrain conditions.
- Using forward travel mowing pattern when possible.

Look Out For The Safety of Others

Before starting equipment:

- Walk around the equipment.
- Check for anyone under, on or near the equipment.
- Clear everyone from these areas.
- Sound a warning.



**USE ROPS
and Seatbelt**

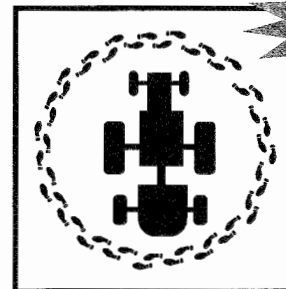

**WALK AROUND
Inspection**

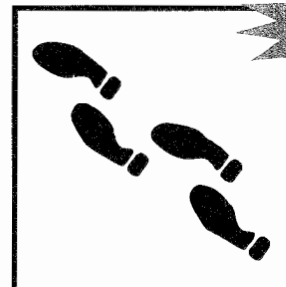

**WALK AROUND
the Worksite**

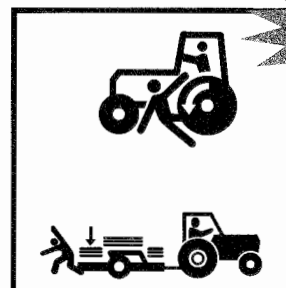

**LOOK OUT
For Others**

Safety – Starting & Testing

USE Three Point Contact



USE ROPS and Seatbelt



USE Proper PTO speed

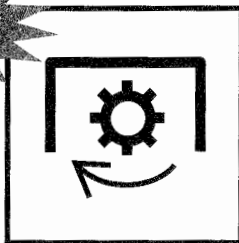

Mounting Tractor Safely

Before mounting:

- Clean shoes and wipe hands.

During mounting and dismounting:

- Use handholds and step plates.
- Never grab steering wheels or controls for handholds.
- Never mount or dismount from a moving tractor.

Tractor And Mower Controls Safety Test

Before starting:

- Fasten and adjust seat belt on your ROPS-equipped tractor.
- Check parking brake for engagement.
- Check PTO disengagement.
- Check all controls for Neutral or Park position.
- Warn others in area before starting tractor.
- Follow tractor manufacturer's recommended starting procedures.

After starting:

- Check all instruments, gauges and indicator lights for normal operation.
- Check all tractor controls, steering and brakes for proper function.
- Repair improperly functioning tractor before using.
- Raise and lower mower for driveline bottoming out or engagement problems.
- Check your equipment for excessive vibration and unusual noises.
- Use proper equipment shutdown practices before inspecting equipment.

Power Takeoff System And Mower Safety

Tractors with dual-speed (540 or 1000 rpm) shiftable PTO systems.

To avoid serious injury or death from failed parts due to mower over speed:

- Be sure to position PTO selector to mower's rated PTO rpm speed.

Tractors with transmission-driven PTO systems.

A rotary mower will have a significant flywheel effect which may continue to propel a tractor with a transmission-driven PTO system.

The tractor should be equipped and operated as follows:

- Install an over-running clutch.
- Give yourself sufficient maneuvering room and time by anticipating turns, stops and speed reductions.

Safety – During Operation

Hitching Mower To Tractor Safety

Three-point hitch-mounted mower safety:

- Refer to mower and tractor manufacturers' manuals.
- Place tractor's hydraulic power lift (rockshaft) selector lever in down position to avoid unexpected movement.
- Explain the hitching procedures to those users or operators who cannot read.

Pull-type hitch-mounted mower safety:

- Refer to mower and tractor manufacturers' manuals.
- Attach only to drawbar hitch.
- Do not attach to tractor's rear axle or three-point hitch arms.
- Adjust tractor drawbar length for 540 or 1000 rpm PTO operation.

Make The Right Start In Mower Safety

Mow only in daylight or good artificial light conditions.

To avoid serious injury or death from mower thrown objects or blade contact:

- Keep chain shields, flexible or solid deflector shields or discharge chutes in place and in good repair.
- Keep everyone several hundred (300) feet from mowing operation.
- Never direct mower discharge toward anyone.
- Keep hands, feet and other body parts away from rotating parts, blades and discharge openings.
- Do not operate mower in transport position.

Mower PTO drive engagement:

- Raise mower to maximum cutting height.
- Engage PTO at low engine rpm.
- Increase engine rpm to mower rated rpm PTO speed.
- Lower mower to desired cutting height.
- Stop and shut down immediately if the mower strikes an obstruction.
- Inspect and repair any mower damage before resuming mowing.
- Do not operate mower with severe vibrations or with unusual noise.

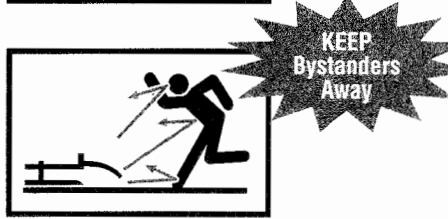
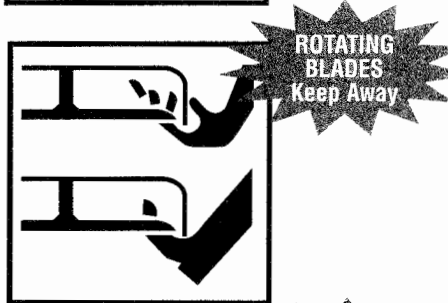
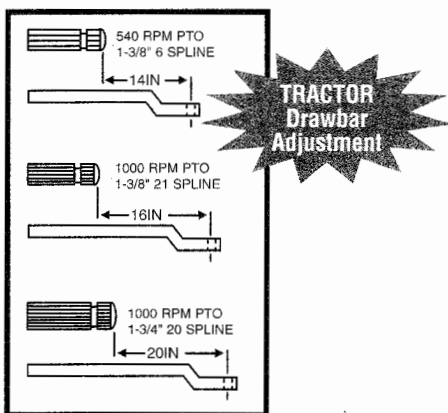
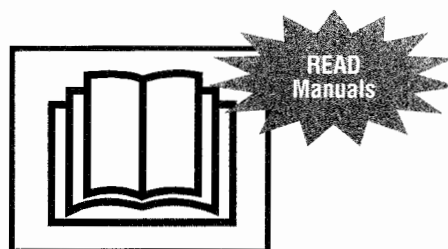

LOOK OUT
For Others

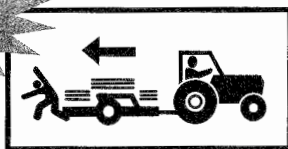

Mowing In Reverse Safety

Avoid mowing in reverse direction when possible.

Do the following when mowing in reverse direction:

- Check for any persons behind mower before reversing direction.
- Use extreme care when reverse direction mowing.
- Maintain rotary mower front and rear safety shields and flail front shields and rear rollers.

MAINTAIN
FLAIL
Rear Roller

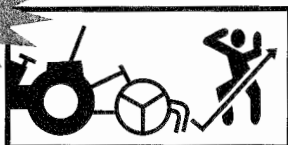

Mowing Ground Speed

Proper ground speed depends on terrain conditions and grass type, density and height to be cut:

- Normal ground speed range is 2 to 5 mph.
- Slower ground speed for mowing tall, dense grass.
- Faster ground speed for mowing medium height, thin grass and under smooth terrain conditions.
- Use slower ground speed for mowing in rough, sloping or unfamiliar terrain.

USE PROPER
Ground Speeds

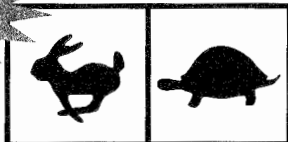

STOP BLADE
Before
Unclogging



Extremely tall grass mowing

- You may need to mow extremely tall grass twice.

First mowing pass:

- Cut grass higher (10-15 inches) to avoid hidden objects.

Second mowing pass:

- Remove debris and objects.
- Cut grass at desired height and 90 degree to the first mowing pass when possible.
- Use proper equipment shutdown practice for your safety before dismounting tractor.

PROVIDE
Adequate
Clearance for
Mower Swing

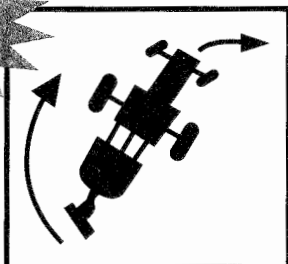

Watch equipment clearances

Three-point hitch and side mounted mowers have a larger turning arc than pull-type mowers. Allow sufficient clearance for safe turning.

NEVER STAND
On Mower
Keep Away

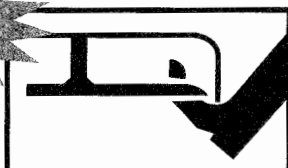

Under Mount Mower Safety

When mowing with an under mount mower:

- Keep removable discharge chute in place and over discharge opening.
- Never stand on an operating mower housing.
- Distribute grass clipping with discharge chute facing mowed area.
- Use proper equipment shutdown practice before clearing clogged mower or discharge chute.

KEEP CHUTE
In Place

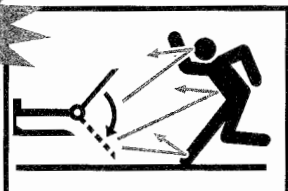

Wing Or Boom Type Mower Overhead Obstruction Hazards and Risks

Check for overhead obstructions with raised wings or boom-type mowers to avoid serious injury or death by contact with:

- Electrical power lines.
- Low tree limbs.
- Other overhead obstructions.

Wing And Side Mount Mowers Safety

When mowing with wing and side-mount mowers:

Raised wing positions reduces shielding protection and increases the thrown object and blade contact hazard risks.

To avoid serious injury or death by thrown objects or blade contact from raising and lowering wings during mowing operations:

- Do not mow with bystanders in mowing area.
- Be sure no one is near mower while raising or lowering wings.
- Keep the exposed rotating wing blade time to a practical minimum during a raised wing mowing operations.
- Stop mowing if persons enter into mowing area.
- Only raise wing to clear objects in the mowing path or to match ground slope.
- Disengage wing drive for extended periods of mowing with raised wings.
- Lower raised wing to ground after clearing object or ground slope conditions.
- Allow all mower blades to stop rotating before raising wing sections during other operations.

Ditch Bank Mowing Safety

Use extreme care when mowing ditch banks. Watch for washouts, eroded areas and mowing obstructions along the ditch banks. Hitting obstructions with side-mount or boom mowers may swerve the tractor's front end toward the ditch.

Raised wing and boom-type mower ditch bank operations may reduce the mower's thrown object shielding effectiveness for the mower operator's protection.

To increase operator protection from thrown objects during ditch bank operations:

- Use enclosed ROPS cabs, special protective enclosures and other operator shielding when performing these operations.
- Inspect mowing area and remove or mark all foreign objects and debris to be avoided by mower.



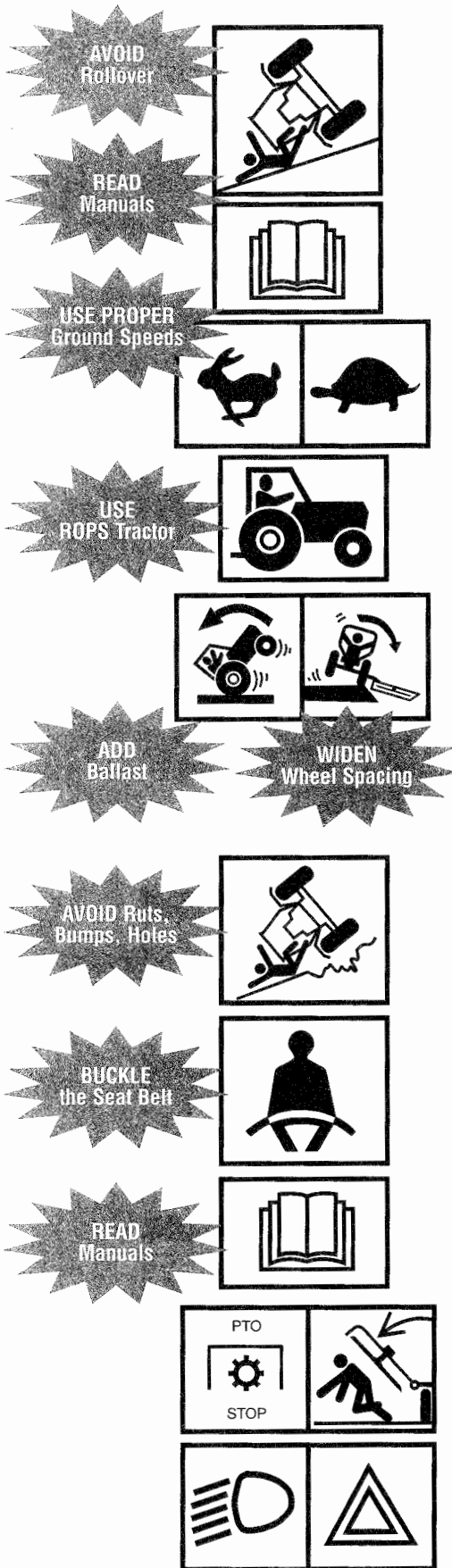

Mowing Uneven Terrain Safely

The tractor and mower stability is reduced on slopes and uneven terrain.

You can prevent tractor and mower overturns and maintain equipment stability control by:

- Reviewing tractor and mower operator's manuals for operating safety practices on slopes and uneven terrain conditions. Explain the practices to those users and operators who cannot read.
- Avoiding extremely steep slope operations.
- Using extreme care to maintain control over your equipment when operating in these conditions.
- Increasing tractor stability by adding wheel weights and increasing wheel spacing (Refer to tractor operator's manual for recommendations)
- Using ROPS and seat-belt-equipped tractor for operator safety during mowing operations.
- Maintaining minimum ground speed.
- Making wide and gradual turns.
- Avoiding sudden starts, stops, and turns when operating up, down, or across slopes.
- Not raising rear-mount or side-mount mowers or mower wings from the ground during these operations .
- Keeping alert for holes, bumps, ruts, rocks, stumps or other obstructions that could overturn tractor and mower.
- Avoiding slippery ground conditions that could overturn tractor and mower.
- Avoiding tractor and mower "hang up" by diagonal passing through sharp dips and drops.

Use extreme care in maintaining equipment stability during all uneven terrain and slope mowing operations. You are the final judge as to any slope that can be safely negotiated.

Equipment Road Transporting Safety

If equipment is to be driven on public roads:

- Refer to tractor and mower manufacturers' operator's manuals for instructions.
- Explain the instructions to those users or operators who cannot read.
- Check local regulations for required equipment markings, lights, flashers, etc., while traveling on public roads. Lights are required on mowers that obscure tractor taillights and/or warning lights.

Before transporting on public roads:

- Disengage PTO to mower.
- Raise mower into transport position.
- Lock wings up into transport position with locking devices on wing-type and side-mounted mowers.
- Attach safety chain between pull-type mower and tractor.
- Make sure lights, flashers, reflectors and SMV are in place and visible.
- Check SMV (Slow-Moving Vehicle) emblem for visibility to any rear approaching vehicle.

While transporting on public roads:

- Obey all local traffic regulations.
- Approach intersections with caution.
- Observe speed and traffic control signs.
- Avoid panic stops and sharp turns.

Parking Safety

Park equipment at:

- Designated or out-of-traffic areas.
- Preferably level ground locations.

Sloping ground parking locations:

- Position equipment across slope.
- Set parking brakes.
- Lower mower to ground.
- Block tractor wheels.

Before temporarily parking and leaving disabled equipment near traffic areas:

- Remove equipment from public roads.
- Set out warning flags
- Use tractor flashers.

Safety – During Shutdown

Use Proper Equipment Shutdown Practices For Your Safety

Refer to tractor and mower manufacturer’s operator manual(s) for recommend shutdown procedures. Explain the procedures to those users or operators who cannot read.

Make proper equipment shutdown procedures an important habit to practice. Follow these safety practices before dismanting tractor:

- Disengage PTO clutch and transmission drive.
- Idle engine for gradual cooling.
- Place the controls in PARK or NEUTRAL.
- Set the parking brake.
- Lower mower to ground.
- Lower wings of wing-type mowers to ground.
- Shut off engine.
- Wait for all moving parts to stop before equipment inspections, adjustments or repairs.
- Relieve hydraulic pressure by moving hydraulic controls several times in all directions.
- Lock ignition and remove key when equipment is to be inspected, repaired, adjusted or unattended.
- Lock anti-vandalism covers and closures when equipment is unattended.
- Dismount carefully maintaining three-point contact.

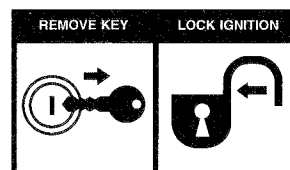
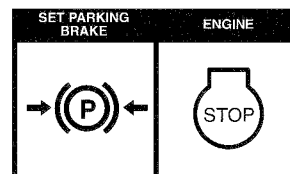
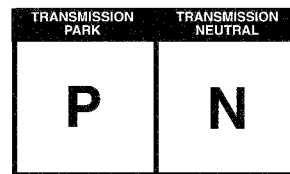
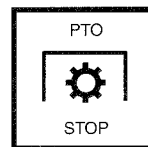
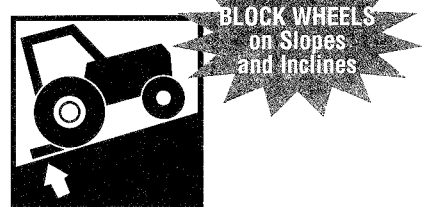
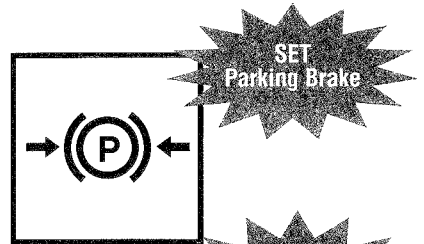
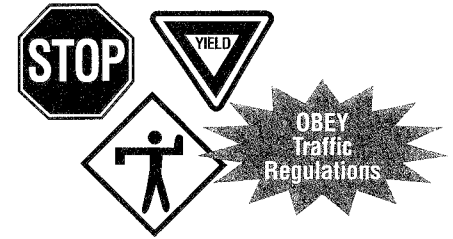

WAIT For Moving Parts to Stop Before Dismount



USE Three Point Contact



MAINTAIN Equipment

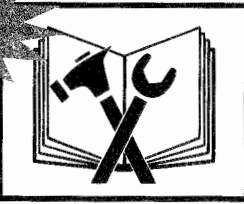

FOLLOW

Maintenance Schedule



Dismounting Tractor Safely

Before dismounting tractor:

- Use proper equipment shutdown practice for your safety.
- Lower implement to the ground, stop engine and PTO, set brakes, allow all moving parts to stop, and remove key before dismounting from tractor.
- Never dismount from moving equipment.
- Never jump from machines.
- Dismount carefully.
- Check for slippery steps
- Keep feet and hands away from controls.
- Use handholds and steps during dismount.
- Face machine and use 3 point contact (2 hands, 1 foot or 2 feet, 1 hand).

Safety – During Maintenance

Maintenance Safety

Do the following for your safety before performing any maintenance, repairs or service procedures:

- Follow proper equipment shutdown practice.
- Wear all the protective clothing and personal safety devices necessary to safely perform the job.
- Refer to your manufacturer's manuals for proper maintenance, repair and service procedures. Explain the procedures to those users and operators who cannot read.

Stored energy sources (electrical, mechanical, hydraulic, pneumatic, chemical, thermal, etc..) must be either locked, blocked, relieved, disconnected, stopped, secured, neutralized, controlled or reduced to a practical minimum before any maintenance, repair or service procedures can be done safely.

Some basic safety practices to prevent potential injuries from energy releasing sources:

- Disengage PTO before shutting off engine.
- Place controls in PARK or NEUTRAL before shutting off engine.
- Set parking brake or block wheels.
- Allow all moving parts to stop.
- Lower mower to ground.
- Lower wings to ground on wing-type mowers.
- Shut off tractor engine.
- Lock ignition and remove key.
- Look and listen for evidence of moving parts before opening shields.
- Securely support or block-up mower before working underneath mower or other lifted components.
- Securely support, block-up, or lock-up mower wings with locking devices before working near or underneath a wing-type mower.
- Relieve hydraulic system pressure by moving controls several times in all directions.
- Relieve pressure before disconnecting or disassembling any pressurized system.
- Block or relieve spring pressure before disassembling any spring-loaded mechanism.
- Securely support or block up any elevated machine component before working on it.
- Avoid flames, sparks, or smoking near any fuels.

Mower Manufacturer Parts and Your Safety

Most mower manufacturers use special fasteners and specially designed parts to meet mowing operations requirements.

Critical safety-related parts (Self-locking blade bolts, blades, pins, shields or other special items) have specific strength, design and fit requirements for the make and model mower you are using.

Modifications or repair parts not approved by the mower manufacturer can cause serious safety hazard exposure risk to you and others.

TO AVOID SERIOUS INJURY OR DEATH FROM UNAPPROVED PARTS OR MODIFICATIONS:

- Do not substitute common hardware for self-locking blade bolts or other special part items.
- Do not substitute blades, pins, shields or other critical safety-related parts.
- Do not use grade 5 or 8 bolts to replace grade 2 shear bolts.

FOLLOW THE SAFETY PRACTICE OF ALWAYS CHECKING THE MOWER FOR PROPER FUNCTION AFTER ALL ADJUSTMENTS REPAIRS OR SERVICE.

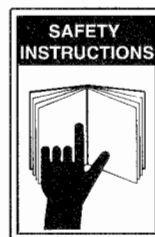
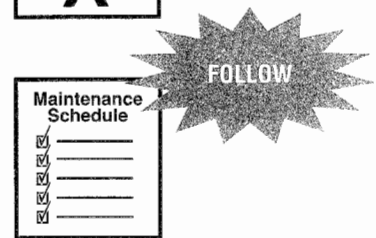
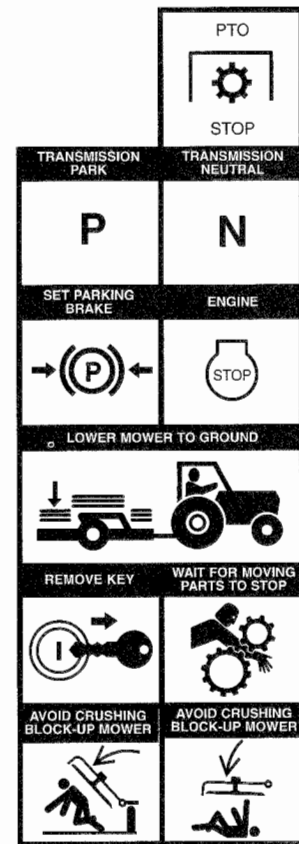

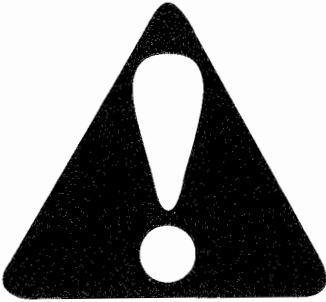

One Final Word



You have just finished reading the Mower Safety Manual. It is impossible for this manual to cover every potentially hazardous situation you may encounter. But, your knowledge of these safety precautions and your adherence to the basic rules of safety will help build good judgment in all situations. Our objective is to help you develop good safety habits and make you a better mower operator. The mower safety manual, safety precautions and basic rules of safety must be explained to those users or operators who cannot read.

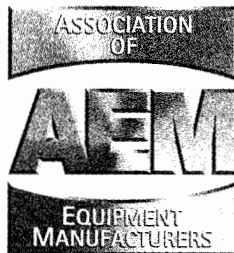

111 E. Wisconsin Avenue • Milwaukee, Wisconsin 53202 U.S.A.
www.aem.org

For information on additional copies of this and
other safety manuals, call 800-369-2310



Segadora industrial y agrícola

manual de
seguridad

*para operadores
y mecánicos*

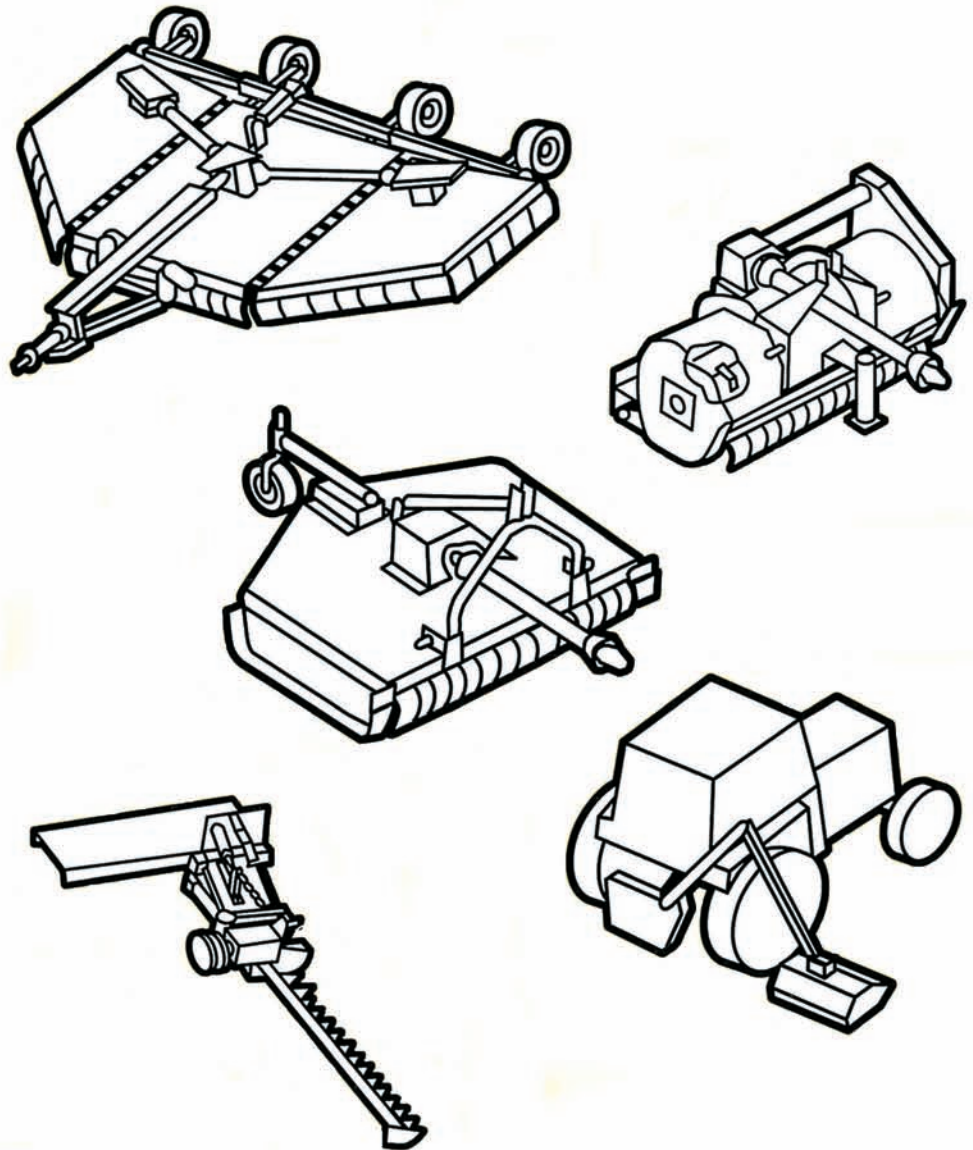

111 E. Wisconsin Avenue • Milwaukee, Wisconsin 53202 U.S.A.
www.aem.org

Contenido

Reconocimiento	2
Introducción	3
Palabras para el usuario	3
Alerta de seguridad	4
Segadoras industriales y agrícolas	4
Sea un operador responsable	5
Manejo seguro de riesgos y peligros	6
Cumpla con un programa de seguridad	11
Seguridad previa a la operación	11
Seguridad durante el arranque y prueba	13
Seguridad durante la operación	14
Seguridad durante la parada	18
Seguridad durante el mantenimiento	19
Palabra final	21

Reconocimiento

Deseamos extender nuestro reconocimiento a los miembros de del Association of Equipment Manufacturers por sus contribuciones para la preparación de este manual de seguridad.

Derechos de autor

© 2000 Equipment Manufacturers Institute. Todos los derechos reservados. Revisado 08.2003

Introducción

El propósito de este manual de seguridad es señalar algunas de las situaciones básicas de seguridad que pueden ocurrir durante la operación y mantenimiento de su máquina y sugerir los métodos posibles para tratar estas situaciones. Este manual NO es un sustituto de el (los) manual(es) del fabricante.

Pueden ser necesarias algunas precauciones adicionales, o algunas instrucciones no pueden aplicar, dependiendo del equipo, dispositivos de fijación, y las condiciones del lugar de trabajo o del área en que se realiza el servicio. El fabricante no tiene control directo sobre las aplicaciones, operación, inspección, lubricación o mantenimiento de la máquina. Por lo tanto, es **SU** responsabilidad practicar buenas medidas de seguridad en estas áreas.

La información proporcionada en este manual sirve como complemento de los detalles de información específicos de su máquina que están incluidos en el (los) manual(es) del fabricante. La información adicional que pueda afectar la operación segura de su máquina puede estar incluida en las etiquetas de seguridad o en los requisitos del seguro, programas de seguridad del empleador, códigos de seguridad, leyes locales del estado/provincia y leyes nacionales, reglas y reglamentos.

IMPORTANTE: si usted no tiene el (los) manual(es) del fabricante de su máquina específica, obtenga un manual de reemplazo con su empleador, distribuidor de equipo o el fabricante de su máquina. Mantenga este manual de seguridad y el (los) manual(es) del fabricante con su máquina.

Palabras para el usuario

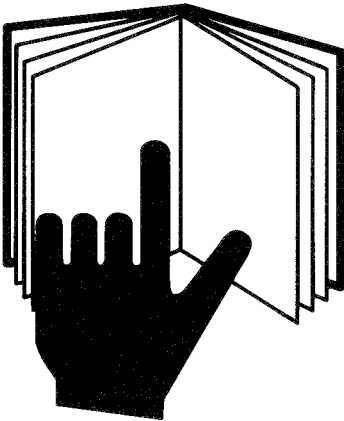

Usted tiene la responsabilidad de leer y comprender este manual de seguridad y el (los) manual(es) del fabricante, antes de operar esta máquina. Este manual de seguridad lo guía paso a paso a lo largo de su día de trabajo. El manual de seguridad, el (los) manual(es) del fabricante, avisos de seguridad (calcomanías) y precauciones de seguridad, deben explicarse a los usuarios u operadores que no puedan leer el material.

Adicionalmente al diseño y configuración del equipo el **CONTROL DEL PELIGRO** y la **PREVENCIÓN DE ACCIDENTES** dependen de la conciencia, preocupación, prudencia y capacitación adecuada de los propietarios y operadores durante la operación, transporte, mantenimiento y almacenamiento del equipo.

Recuerde que **USTED** es la clave para mantener la seguridad. Las buenas prácticas de seguridad no lo protegen solamente a usted sino que también a las personas que lo rodean. Estudie este manual y el (los) manual(es) del fabricante para su máquina específica. Hágalos una parte integral de su programa de seguridad. Recuerde que este manual de seguridad está escrito únicamente para segadoras industriales y agrícolas.

Practique todas las precauciones de seguridad usuales y acostumbradas en el trabajo y más que todo – recuerde que la seguridad depende de USTED. Solamente USTED puede evitar las lesiones graves o la muerte debidas a prácticas inseguras.

Advertencia de seguridad

Símbolo

Este símbolo de alerta de seguridad significa:

“¡ATENCIÓN! ¡MANTÉNGASE ALERTA! ¡SU SEGURIDAD ESTÁ INVOLUCRADA!”



El símbolo de alerta de seguridad identifica los mensajes de seguridad importantes en el equipo, en los avisos de seguridad, en los manuales y en otros lugares. Cuando usted vea este símbolo, esté alerta a la posibilidad de muerte o lesiones. Siga las instrucciones en el aviso de seguridad.

Palabras de señales

Las palabras de señales son palabras específicas que regularmente se encontrarán en las calcomanías de seguridad en este equipo o en otros equipos en el lugar de trabajo. Estas palabras tienen el objetivo de alertar a la persona que las vea de la presencia y el grado relativo de un riesgo.



Esta palabra de señal indica una situación de riesgo inminente que si no es evitado podrá resultar en la muerte o lesiones graves.



Esta palabra de señal indica una situación potencialmente riesgosa que si no se evita podría resultar en la muerte o lesiones graves.



Esta palabra de señal indica una situación potencialmente riesgosa que si no se evita podría resultar en lesiones menores o moderadas.

- LOS ACCIDENTES PUEDEN LISIAR Y CAUSAR LA MUERTE.
- LOS ACCIDENTES SON COSTOSOS.
- LOS ACCIDENTES PUEDEN EVITARSE.

Segadoras industriales y agrícolas

Es una segadora para cortar pasto, triturar residuos de cultivos, cortar maleza para la limpieza de terrenos, vías navegables, derechos de paso, cortes en los bordes de los caminos o carreteras.

TIPOS DE SEGADORAS INDUSTRIALES Y AGRÍCOLAS:

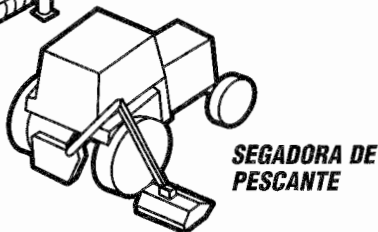
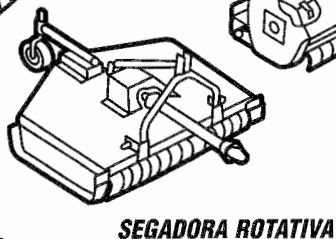
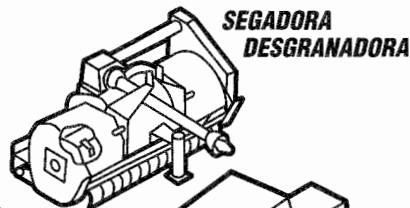

Sea un operador responsable



Para la operación segura de su equipo usted debe ser un operador responsable. Un operador responsable debe comprender claramente las instrucciones escritas proporcionadas por el fabricante ser capacitado – incluyendo la operación real del equipo y el conocimiento de las reglas y reglamentos de seguridad del lugar de trabajo.

Las medicinas y el alcohol pueden y afectarán el estado de alerta y coordinación del operador, por lo tanto, afectarán la habilidad del operador para operar el equipo en forma segura. Un operador **NUNCA** debe usar medicinas que puedan afectar su estado de alerta, juicio y coordinación; ni beber alcohol mientras opera equipo motorizado incluyendo tractores y segadoras. Un operador que use medicamentos por prescripción médica o de venta libre debe consultar con un médico profesional para conocer sobre cualquier efecto secundario que podría limitar su habilidad para operar este equipo en forma segura. **NUNCA** permita que alguien opere este equipo cuando estén afectados su estado de juicio alerta o de coordinación.

Protéjase usted mismo

Use toda la ropa protectora y los dispositivos de seguridad personal que se le proporcionen o que sean los indicados para las condiciones de trabajo.

Usted puede necesitar:

- Casco protector
- Zapatos de seguridad
- Anteojos de seguridad con protección lateral, gafas protectoras o protector facial
- Guantes extrafuertes
- Protección auditiva
- Ropa reflectora
- Equipo para clima húmedo
- Respirador o máscara filtrante

Use ropa apropiada para las condiciones del trabajo.

Siempre conozca cómo obtener ayuda en caso de una emergencia. Conozca donde encontrar y cómo usar los equipos de primeros auxilios y el extintor de incendios/sistema de supresión de incendios.



**Manténgase alerta. Evite los accidentes.
No conozca la seguridad en la forma más difícil.**

Manejo seguro de riesgos y peligros

Adicionalmente al diseño y configuración del equipo, el **CONTROL DEL PELIGRO** y la **PREVENCIÓN DE ACCIDENTES** dependen de la conciencia, preocupación, prudencia y capacitación adecuada de los propietarios y operadores durante la operación, transporte, mantenimiento y almacenamiento del equipo.

EL MANEJO SEGURO DE RIESGOS Y PELIGROS ES UN ELEMENTO ESENCIAL PARA LOS PROPIETARIOS Y OPERADORES RESPONSABLES DE TRACTORES Y SEGADORAS.

REVISE EL MANEJO SEGURO DE LOS PELIGROS Y RIESGOS ENUMERADOS A CONTINUACIÓN.

Peligro de objetos despididos

EXISTE LA POSIBILIDAD DEL RIESGO DE LESIONES A LOS OPERADORES Y TRANSEÚNTES CAUSADAS POR OBJETOS DESPIDIDOS DURANTE LA OPERACIÓN DE LA SEGADORA POR LOS SIGUIENTES:

OBJETOS (PIEDRAS, ESCOMBROS, HOJAS ROTAS DE LA SEGADORA, PERNOS DE LA HOJA, CABLES, CADENAS, ALAMBRE, ETC.) DESPIDIDOS POR LA SEGADORA.

Dispositivos protectores del equipo y prácticas de seguridad recomendadas

La cubierta de la segadora y los dispositivos protectores no pueden evitar que escapen todos los objetos o desechos del área cerrada de la hoja en todas las condiciones de segado. Es posible que los objetos escapen y se desplacen cientos de pies (300 [100 m]).

PRÁCTICAS DE SEGURIDAD RECOMENDADAS

Lea los manuales del operador del fabricante para conocer las prácticas de seguridad recomendadas durante la operación. Explique las prácticas a los usuarios u operadores que no puedan leer.

PARA AYUDAR A EVITAR LESIONES GRAVES O LA MUERTE CAUSADAS POR OBJETOS QUE GOLPEEN AL OPERADOR U OTRAS PERSONAS HAGA LO SIGUIENTE:

SEGURIDAD DE TRANSEÚNTES

- Mantenga a los transeúntes a varios cientos de pies (300 [100 m]) del área segada.

SEGURIDAD PROPORCIONADA POR LOS DISPOSITIVOS PROTECTORES DEL EQUIPO

Para contener, desviar o reducir los objetos despididos del área cerrada de la hoja:

- Mantenga la cadena, blindajes deflectores flexibles o sólidos colocados en la parte delantera y trasera de la cubierta de la segadora, en su lugar y en buen estado de funcionamiento.
- No opere el equipo con los blindajes para objetos despididos dañados o sin que estén colocados en su lugar.

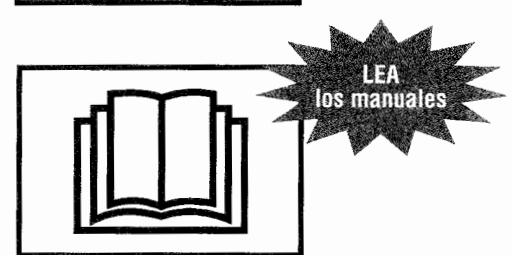

SEGURIDAD DEL OPERADOR

La operación de las segadoras con las alas levantadas, de montaje lateral y pescante, pueden reducir la efectividad del blindaje para proteger al operador contra los objetos despedidos de la segadora.

Haga lo indicado a continuación para aumentar la protección del operador contra los objetos despedidos durante las operaciones de segado:

- Use cabinas cerradas con una estructura de protección contra vuelcos (ROPS), cubiertas protectoras especiales, mallas u otros dispositivos para proteger al operador cuando efectúa estas operaciones.

SOBREPASAR LAS VELOCIDADES RECOMENDADAS PARA LA TOMA DE FUERZA (PTO)

No sobrepase las velocidades recomendadas por el fabricante para la toma de fuerza (PTO).

Las velocidades excesivas de la toma de fuerza (PTO) pueden causar:

- Fallo de la hoja
- Escape de objetos a velocidad alta u hojas rotas despedidas del área cerrada de la hoja de la segadora.
- Fallos potenciales de la línea de transmisión de 540 rpm cuando se opera a velocidades de 750 a 1000 rpm.

OTRAS PRÁCTICAS DE SEGURIDAD:

- Nunca debe operar la segadora con hojas rotas, dobladas, faltantes o que estén extremadamente desgastadas.
- Antes de segar retire los desechos y objetos extraños para evitar que sean recogidos y despedidos por la segadora.
- No debe operar la segadora durante el transporte o en posición de ala levantada.

PRÁCTICAS DE MANTENIMIENTO RECOMENDADAS

Lea los manuales del operador del fabricante para conocer sobre la inspección y mantenimiento de las defensas de la cadena y blindaje deflector flexible o sólido:

- Reemplace las defensas desgastadas o dañadas y los demás blindajes antes de segar.
- Use solamente las defensas y blindajes de reemplazo del fabricante. Otras defensas o blindajes pueden no encajar, o los materiales pueden no ser adecuados para cumplir con los requisitos de resistencia del equipo.
- Reemplace las calcomanías desgastadas o dañadas y las instrucciones de advertencia.
- Explique las instrucciones de inspección y mantenimiento a los usuarios u operadores que no puedan leer.

USE cabinas cerradas con una estructura protectora contra vuelcos (ROPS) o cubiertas protectoras

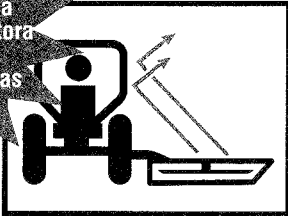

USE la velocidad apropiada de la toma de fuerza (PTO)

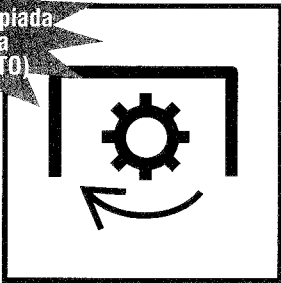

DÉ MANTENIMIENTO a su equipo

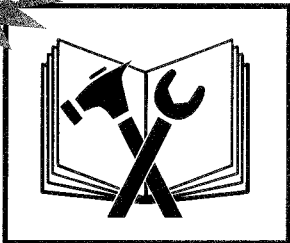

Peligros y riesgos de las hojas rotativas y línea de transmisión

EXISTE EL RIESGO DE POSIBLES LESIONES A LOS OPERADORES DE LA SEGADORA Y TRANSEÚNTES DURANTE LAS OPERACIONES DE SEGADO CAUSADAS POR LO SIGUIENTE:

- CONTACTO DEL CUERPO CON LAS HOJAS ROTATIVAS.
- ENREDO DEL CUERPO CON LAS LÍNEAS DE TRANSMISIÓN Y PIEZAS ROTATIVAS.

Dispositivos protectores del equipo y prácticas de seguridad recomendadas

PRÁCTICAS DE SEGURIDAD RECOMENDADAS

Lea los manuales del operador del fabricante para conocer las prácticas de seguridad recomendadas. Explique las prácticas a los usuarios u operadores que no puedan leer. Para evitar el riesgo de lesiones graves o la muerte causadas por el contacto con la hoja en movimiento, línea de transmisión o enredo de los operadores u otras personas haga lo siguiente:

SEGURIDAD DE TRANSEÚNTES

- No debe operar cerca de transeúntes.
- Mantenga a otras personas a varios cientos de pies (300 [100 m]) del área de segado.

PRÁCTICAS DE SEGURIDAD DEL OPERADOR

- No permita pasajeros en el tractor o segadora. Asegúrese el cinturón de seguridad durante el segado.
- Use la práctica de parada del equipo apropiada antes de dar servicio, ajustar, limpiar o eliminar las obstrucciones de la segadora.
- Manténgase alejado de las hojas rotativas, piezas y líneas de transmisión.
- Nunca arranque el motor del tractor mientras esté de pie al lado del equipo.
- Solamente arranque el motor del tractor cuando esté sentado en el asiento del operador con el cinturón de seguridad abrochado.

PRÁCTICAS DE SEGURIDAD RECOMENDADAS PARA DEFENSAS Y BLINDAJES DE LA LÍNEA DE TRANSMISIÓN

- Mantenga las líneas de transmisión y otros blindajes colocados y en buen estado.
- No debe operar la segadora cuando las defensas, defensas de la línea de transmisión u otros blindajes hagan falta o estén dañados.

PRÁCTICAS DE SEGURIDAD RECOMENDADAS

Lea los manuales del operador del fabricante para conocer las instrucciones sobre defensas, defensas de la línea de transmisión y otros blindajes:

- Reemplace las defensas, defensas de la línea de transmisión y otros blindajes desgastados o dañados antes de segar.
- Use solamente defensas y blindajes de reemplazo hechas por el fabricante. Otras defensas o blindajes pueden no encajar o ser de materiales inadecuados que no cumplan con los requisitos de resistencia del equipo.
- Reemplace las calcomanías e instrucciones de advertencia desgastadas o dañadas.
- Explique las instrucciones de inspección y mantenimiento a los usuarios u operadores que no puedan leer.



EVITE enredarse

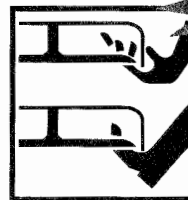

EVITE las piezas rotativas



LEA los manuales



ASEGÚRESE el cinturón de seguridad



NO LLEVE PASAJEROS



EVITE el ser atropellado



DÉ MANTENIMIENTO a su equipo

EVITE vuelcos

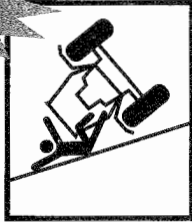

USE la estructura contra vuelcos (ROPS) del tractor



LEA los manuales

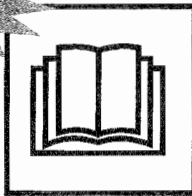

AGREGUE balasto



AUMENTE el espacio entre las ruedas y AGREGUE balasto en el lado contrario



ASEGURESE el cinturón de seguridad



EVITE EL APLASTAMIENTO asegure el ala



Peligros y riesgos de rodamiento o vuelco del tractor y segadora

EXISTE UN RIESGO DE LESIONES POSIBLES AL OPERADOR POR RODAMIENTO O VUELCO DE LA SEGADORA DURANTE LAS OPERACIONES DE SEGADO POR LO SIGUIENTE:

- TERRENO ACCIDENTADO, PENDIENTES INCLINADAS, AGUJEROS, BACHES, SURCOS, PIEDRAS, TRONCOS U OTRAS OBSTRUCCIONES QUE PODRÍAN VOLCAR EL TRACTOR Y SEGADORA.
- VELOCIDADES ABSOLUTAS EXCESIVAS PARA ESTAS CONDICIONES DE TERRENO.

Dispositivos protectores del equipo y prácticas de seguridad recomendadas

Cuando sea posible, retire los troncos, piedras, etc., o márquelos claramente con las demás obstrucciones para evitar vuelcos, averías y condiciones de conducción peligrosas. Tenga extremo cuidado para mantener el control sobre el equipo cuando opere en terrenos con estas condiciones.

ESTRUCTURAS CONTRA VUELCO (ROPS) RECOMENDADAS PARA TRACTORES

Un tractor equipado con una estructura contra vuelcos (ROPS) o cabina ROPS cerrada y cinturón de seguridad para la seguridad del operador, es esencial para la protección adicional del operador, cuando opera en terrenos con estas condiciones

AJUSTES RECOMENDADOS PARA LA ESTABILIDAD DEL TRACTOR

Lea el manual del operador del tractor para conocer los ajustes para aumentar la estabilidad del tractor:

- Agregue pesas o balasto a las ruedas delanteras y traseras.
- Ajuste el espacio entre las ruedas al ancho máximo.
- Agregue contra balasto en el lado contrario a las segadoras de montaje lateral y de pescante.
- Explique los ajustes a los usuarios u operadores que no puedan leer.

PRÁCTICAS DE SEGURIDAD RECOMENDADAS

Lea los manuales del operador del fabricante para conocer las prácticas de seguridad de operación recomendadas. Explique las prácticas a los usuarios u operadores que no puedan leer. **Para evitar lesiones graves o la muerte del operador por el vuelco del tractor y segadora, haga lo siguiente:**

- Abroche firmemente el cinturón de seguridad cuando seque con tractores equipados con una estructura contra vuelcos (ROPS).
- Evite la velocidad absoluta excesiva de acuerdo con las condiciones del terreno.
- Evite los arranques, paradas y virajes repentinos cuando opere subiendo, bajando o atravesando pendientes.
- Evite las condiciones de terreno resbaloso.
- Haga virajes anchos y graduales.
- Planifique segar cuesta abajo en pendientes inclinadas para evitar los vuelcos.

Peligros y riesgos de aplastamiento por una segadora o piezas desprendidas

EXISTE EL RIESGO DE UNA LESIÓN POR APLASTAMIENTO PARA LOS OPERADORES Y OTRAS PERSONAS DURANTE LAS OPERACIONES DE SEGADO DEBIDO A LO SIGUIENTE:

- SEGADORA O EQUIPO DESPRENDIDO DEBIDO A FALLO DEL SISTEMA HIDRÁULICO.
- FALLO EN DAR SOPORTE, BLOQUEAR O ASEGURAR COMPLETAMENTE LA SEGADORA O PIEZAS DEL EQUIPO.

Dispositivos protectores del equipo y prácticas de seguridad recomendadas

Lea los manuales del operador del fabricante para conocer las prácticas de seguridad de operación recomendadas. Explique las prácticas a los usuarios u operadores que no puedan leer. **Para ayudar a evitar lesiones serias o la muerte de los operadores y otras personas causadas por la caída de la segadora o piezas de equipo, haga lo siguiente:**

PRÁCTICAS DE SEGURIDAD RECOMENDADAS

Antes de trabajar cerca o debajo de la segadora o piezas de equipo en posición levantada:

- Use la práctica de parada del equipo apropiada antes de dar servicio, ajustar, limpiar o eliminar las obstrucciones de la segadora.
- Soporte o coloque bloques firmemente debajo de la segadora o piezas de equipo.
- En las segadoras de tipo ala coloque bloques o asegure firmemente las alas con los seguros o baje al suelo la segadora o piezas del equipo.
- Use los seguros de transporte cuando transporte la segadora en caminos públicos.

Peligros y riesgos por la fuga de fluido hidráulico a presión alta

EXISTE UN RIESGO PARA LOS OPERADORES DE SEGADORAS Y OTRAS PERSONAS DE UNA POSIBLE INYECCIÓN DE FLUIDO A PRESIÓN ALTA O GANGRENA CAUSADA POR LA INYECCIÓN EN LA PIEL DE ACEITE HIDRÁULICO O DIESEL.

PARA EVITAR LA GANGRENA, EL FLUIDO INYECTADO DEBE SER ELIMINADO QUIRÚRGICAMENTE EN POCAS HORAS, POR UN MÉDICO FAMILIARIZADO CON ESTE TIPO DE LESIÓN.

PRÁCTICAS DE SEGURIDAD RECOMENDADAS

Lea los manuales del operador del fabricante para conocer las prácticas de seguridad recomendadas. Explique las prácticas a los usuarios u operadores que no puedan leer. Las fugas de fluido a presión alta por agujeros minúsculos pueden ser casi invisibles.

Para ayudar a evitar lesiones serias o la muerte haga lo siguiente:

- Busque las fugas con pedazos de cartón o madera.
- No use las manos para verificar la presencia de fugas.
- Descargue la presión del sistema antes de desconectar los conductos.
- Antes de aplicar presión al sistema:
 - Revise que los conductos, tuberías y mangueras no estén dañados.
 - Revise que las conexiones estén apretadas.
- Antes de operar los sistemas presurizados:
 - Descargue el aire del sistema.
 - Haga referencia al (los) manual(es) del operador del fabricante para obtener instrucciones.
 - Explique los procedimientos a los usuarios u operadores que no puedan leer.

Peligros y riesgos durante el llenado de combustible del tractor

Para evitar las lesiones serias o la muerte por incendio durante el llenado:

- Apague el motor y la ignición.
- Nunca llene el tanque de combustible cerca de llamas descubiertas.
- Nunca fume mientras llena combustible.
- Evite las chispas causadas por la electricidad estática poniendo a tierra la boquilla del combustible contra el cuello de llenado del tanque.
- Evite sobrellenar el tanque o derramar el combustible.
- Limpie inmediatamente el combustible derramado.
- Siempre vuelva a colocar la tapa del combustible.

Para evitar lesiones serias o la muerte causadas por las emanaciones del escape del motor:

- Ventile adecuadamente los espacios cerrados antes de arrancar el motor.



LEA los manuales

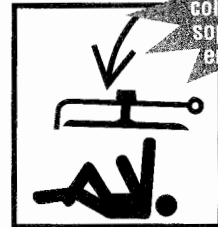

EVITE EL APLASTAMIENTO coloque bloques o soportes seguros en la segadora



FLUIDO A PRESIÓN ALTA puede inyectarse en el cuerpo

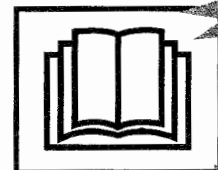

LEA los manuales

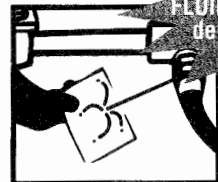

EVITE LA INYECCIÓN DE FLUIDO use un pedazo de cartón, no use las manos



EVITE los incendios y las explosiones

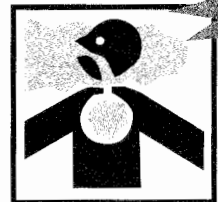

EVITE las emanaciones del escape

Cumpla con un programa de seguridad



LA SEGURIDAD ES IMPORTANTE PARA LOS PROPIETARIOS Y OPERADORES RESPONSABLES DE TRACTORES Y SEGADORAS. HAGA LO SIGUIENTE PARA SU SEGURIDAD DURANTE LA OPERACIÓN DE SEGADO:

SEA UN OPERADOR CAPACITADO HACIENDO LO SIGUIENTE:

- Leyendo, comprendiendo y obedeciendo las instrucciones escritas del fabricante en el (los) manual(es) del operador y avisos de seguridad en la segadora y tractor.
- Recibiendo capacitación operativa para la segadora y tractor.
- Solicitando a su distribuidor de equipo o supervisor que le explique lo que usted no comprende.
- Explicando las instrucciones escritas en el (los) manual(es) del operador y avisos de seguridad (calcomanías) en la segadora y tractor a los usuarios u operadores que no puedan leer.

Seguridad previa a la operación

Conozca las reglas y reglamentaciones de seguridad del lugar de trabajo

Pregunte a su supervisor sobre las reglas de seguridad de operación del equipo que usted deberá obedecer.

Algunas reglas para su seguridad y la de los demás:

- Un tractor equipado con una estructura contra vuelcos (ROPS) es necesario para la protección del operador durante las operaciones de segado.
- Conozca la capacidad y características de operación de la segadora y tractor.
- Nunca altere o desmonte el equipo de seguridad.
- Nunca permita que niños o personas no capacitadas operen una segadora o tractor.
- Nunca permita pasajeros en la segadora o tractor.
- Mantenga a otras personas alejadas de la operación de segado.
- Use la práctica apropiada para parar el equipo antes de bajarse del tractor.
- Permita que se detengan todas las piezas móviles antes de efectuar inspecciones, reparaciones o ajustes al equipo.
- Soporte o coloque bloques firmemente debajo de la segadora antes de trabajar debajo de la segadora o componentes elevados.
- Use la ropa protectora y dispositivos de seguridad personal que le han sido asignados o recomendados por el fabricante del equipo.



Conozca los controles del tractor y segadora

Conozca lo siguiente sobre su tractor y segadora:

- Función, propósito y uso de los controles.
- Velocidades seguras de operación.
- Capacidad para operar en forma segura en pendientes y terreno accidentado.
- Características de frenado y dirección.
- Espacios libres necesarios para la operación del tractor y segadora.
- Cómo detener rápidamente el equipo cuando haya una emergencia.



Use todos los dispositivos de seguridad del equipo disponibles

Para ayudar a mantener su seguridad y la de las personas que lo rodean:

- Asegúrese de que las defensas, blindajes y avisos de seguridad recomendados por el fabricante están instalados en el equipo y en buen estado.
- Mantenga todos los dispositivos protectores en su lugar y abrochados firmemente.
- **NUNCA** debe operar su equipo con los dispositivos de seguridad sin colocar, desconectados o dañados.
- Use el balasto y peso requerido para la estabilidad operativa del equipo.

Inspeccione el equipo de la segadora y tractor

Antes de comenzar su día de trabajo:

- Revise que no haya piezas del tractor y segadora que estén sueltas, rotas, dañadas o que no estén colocadas en su lugar.
- Repare o reemplace estas piezas cuando sea necesario.
- Verifique que los implementos del tractor y segadora sean los apropiados.
- Verifique que sean iguales las rpm de régimen de la toma de fuerza (PTO) a las del tractor y de la segadora.
- Revise el estado de las hojas de la segadora. Afile o reemplace de acuerdo con las recomendaciones del fabricante. Las modificaciones a las hojas como soldadura o endurecimiento de los bordes cortantes con soldadura o enderezado de las hojas dobladas, pueden reducir la resistencia de las hojas y afectar adversamente las propiedades y seguridad de las hojas.
- Verifique que todas las defensas y blindajes estén colocados en su lugar y que todo el equipo esté en buen estado de funcionamiento. Esto incluye la línea de transmisión de la toma de fuerza (PTO), caja de engranajes, defensas y blindajes del implemento que sirven para la protección del operador.
- Verifique que la horqueta de la línea de transmisión y los dispositivos de seguro estén correctamente asegurados.
- Verifique que los sistemas hidráulicos del tractor y segadora no estén dañados ni tengan fugas.
- Revise y lea los avisos de seguridad y las instrucciones de advertencia.
- Explique los avisos de seguridad e instrucciones de advertencia a los usuarios u operadores que no puedan leer.

Inspeccione el área de trabajo

Inspeccione, identifique y evite las condiciones peligrosas en el área de trabajo:

- Terreno accidentado, bajadas escarpadas, zanjas, agujeros, pendientes inclinadas, troncos, agua estancada, suelo de lodo suave, condiciones resbalosas, desechos y objetos extraños.
- Inspeccione el área de segado y elimine o marque todos los objetos extraños y desechos que debe evitar con la segadora.

Analice el área de segado para establecer:

- El mejor y más seguro procedimiento de segado.
- Tipo de material y altura de segado.
- Estado del terreno de operación.
- El uso de un patrón de segado de desplazamiento hacia delante siempre que sea posible.

Verifique la seguridad de las demás personas

Antes de arrancar el equipo:

- Camine alrededor del equipo.
- Verifique que no haya nadie debajo, sobre o cerca del equipo.
- Aleje a todas las personas de estas áreas.
- Haga sonar una alarma.



USE UNA ESTRUCTURA CONTRA VUELCOS (ROPS) y el cinturón de seguridad

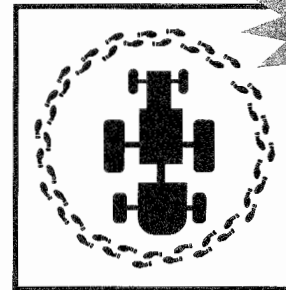

CAMINE ALREDEDOR para inspeccionar

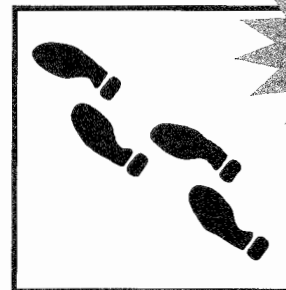

CAMINE ALREDEDOR del lugar de trabajo

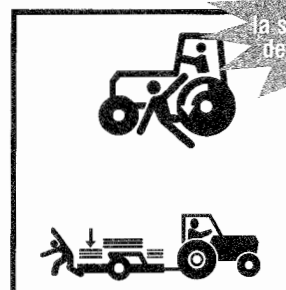

VERIFIQUE la seguridad de las demás personas

Seguridad durante el arranque y prueba

USE
el contacto de
tres puntos



USE UNA
ESTRUCTURA
CONTRA VUELCOS
(ROPS) y el
cinturón de
seguridad



USE la
velocidad
correcta de la
toma de fuerza
(PTO)

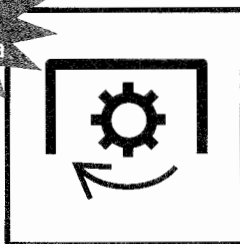

Seguridad durante la subida al tractor

Antes de subir:

- Límpiense los zapatos y las manos.

Durante la subida y la bajada del tractor:

- Use las asas y placas de los escalones.
- Nunca utilice los volantes de dirección o controles como asas.
- Nunca suba ni baje de un tractor en movimiento.

Prueba de seguridad de los controles del tractor y segadora

Antes del arranque:

- Ajuste y abroche el cinturón de seguridad en su tractor equipado con una estructura contra vuelcos (ROPS).
- Verifique que el freno de estacionamiento esté enganchado.
- Verifique que desenganche la toma de fuerza (PTO).
- Verifique que todos los controles estén en la posición de punto muerto (N) o de estacionamiento (P).
- Advierta a las demás personas presentes en el área antes de arrancar el tractor.
- Cumpla con los procedimientos de arranque recomendados por el fabricante del tractor.

Después del arranque:

- Revise que todos los instrumentos, indicadores y luces indicadoras funcionen normalmente.
- Revise que todos los controles, dirección y frenos del tractor funcionen apropiadamente.
- Repare un tractor que no esté funcionando apropiadamente antes de usarlo.
- Suba y baje la segadora cuando la línea de transmisión llegue al fondo o cuando existen problemas de enganche.
- Verifique que su equipo no vibre excesivamente y que no tenga ruidos anormales.
- Use prácticas apropiadas para detener el equipo antes de inspeccionarlo.

Seguridad en el sistema de toma de fuerza y segadora

Tractores con sistemas de doble velocidad (540 ó 1000 rpm) toma de fuerza (PTO) de cambios.

Para evitar las lesiones serias o la muerte por el fallo de piezas causado por la sobrevelocidad de la segadora:

- Asegúrese de colocar el selector de la toma de fuerza (PTO) a la velocidad de régimen de las rpm de la toma de fuerza (PTO).

Tractores con sistemas con toma de fuerza (PTO) impulsados por la transmisión.

Una segadora rotativa tendrá un efecto significativo de volante, que puede continuar impulsando el tractor cuando tiene un sistema de toma de fuerza (PTO) impulsado por la transmisión.

El tractor debe estar equipado y ser operado como se indica a continuación:

- Instale un embrague de sobremarcha.
- Permítase suficiente espacio y tiempo para maniobrar anticipando los virajes, paradas y reducciones de velocidad.

Seguridad durante la operación

Seguridad durante el enganche de la segadora al tractor

Seguridad en el montaje de la segadora con un enganche de tres puntos:

- Haga referencia a los manuales de los fabricantes de la segadoras y el tractor.
- Coloque la palanca selectora del elevador de potencia hidráulica del tractor (eje de balancín) en posición baja para evitar el movimiento inesperado.
- Explique los procedimientos de enganche a los usuarios u operadores que no puedan leer.

Seguridad en el montaje de la segadora con enganche de tipo tiro:

- Haga referencia a los manuales del fabricante de la segadora y tractor.
- Utilice solamente un enganche de barra de tiro.
- No la enganche al eje trasero del tractor ni a los brazos del enganche de tres puntos.
- Ajuste la longitud de la barra de tiro del tractor para la operación de la toma de fuerza (PTO) de 540 ó 1000 rpm.

Comience el uso de la segadora en forma correcta para mayor seguridad

Segue solamente durante el día o cuando exista iluminación artificial adecuada.

Para evitar las lesiones serias o la muerte causadas por objetos despedidos por la segadora o contacto con las hojas:

- Mantenga los blindajes de la cadena, blindajes deflectores flexibles o sólidos, conductos de descarga, colocados en su lugar y en buen estado.
- Mantenga a todas las personas a varios cientos de pies (300 [100 m]) de la operación de segado.
- Nunca dirija hacia ninguna persona la descarga de la segadora.
- Mantenga las manos, pies y otras partes del cuerpo alejadas de las piezas rotativas, hojas y agujeros de descarga.
- No debe operar la segadora en posición de transporte.

Enganche de la transmisión, toma de fuerza (PTO) de la segadora:

- Suba la segadora a la altura máxima de corte.
- Enganche la toma de fuerza (PTO) con rpm bajas del motor.
- Aumente las rpm del motor a la velocidad de régimen de las rpm de la toma de fuerza (PTO).
- Baje la segadora a la altura de corte deseado.
- Deténgase y pare inmediatamente si la segadora golpea una obstrucción.
- Inspeccione y repare cualquier daño que tenga la segadora antes de reiniciar el segado.
- No debe operar la segadora cuando tenga vibración excesiva o ruidos anormales.

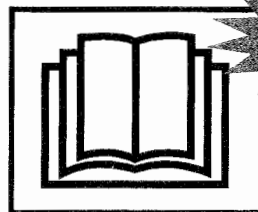

LEA
los manuales

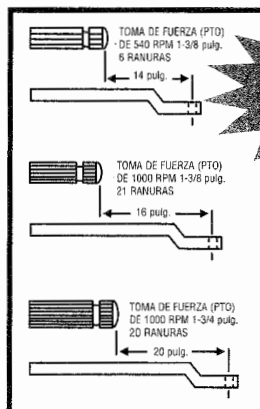

Ajuste
de la barra
de tiro del
TRACTOR

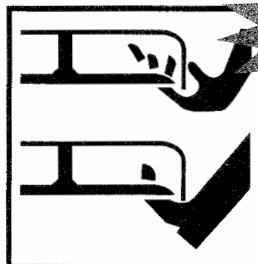

Mantenga la
distancia de
LAS HOJAS
ROTATIVAS

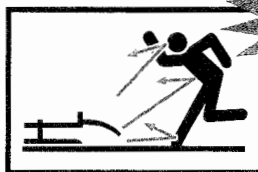

MANTENGA
alejados a los
transeúntes

CUIDE
que no haya
más personas

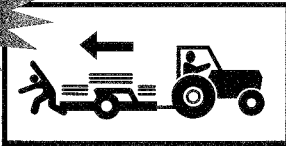

MANTENGA
el rodillo
trasero de la
desgranadora

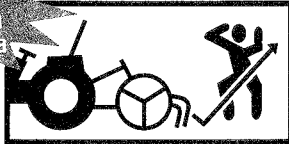

USE las
velocidades
absolutas
apropiadas

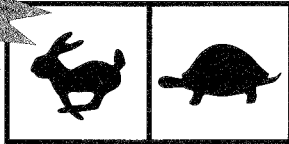

DETENGA
LA HOJA
antes de eliminar
obstrucciones



ESTABLEZCA
QUE el espacio
libre sea adecuado
para la oscilación
de la segadora

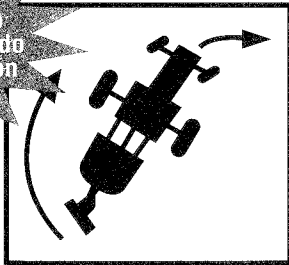

NUNCA
PERMANEZCA
DE PIE sobre
la defensa de
la segadora

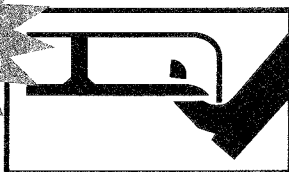

MANTENGA
EL CONDUCTO
colocado en
su lugar

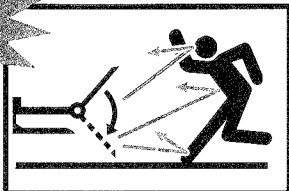

Seguridad durante el segado en marcha atrás

Evite segar en marcha atrás siempre que sea posible.

Haga lo siguiente cuando segue en marcha atrás:

- Verifique que no haya personas atrás de la segadora antes de dar marcha atrás.
- Use extremo cuidado al invertir la dirección del segado.
- Mantenga los blindajes de seguridad delanteros y traseros y los blindajes delanteros de la desgranadora y los rodillos traseros de la segadora rotativa.

Velocidad absoluta de segado

La velocidad absoluta depende de las condiciones del terreno, tipo de pasto, densidad y la altura de corte:

- El alcance normal de la velocidad absoluta es de 2 a 5 mph.
- La velocidad absoluta debe ser menor cuando segue pasto alto y denso.
- La velocidad absoluta puede ser mayor cuando segue pasto de altura mediana, delgado y cuando las condiciones del terreno sean uniformes.
- Use una velocidad absoluta menor cuando segue en pendientes accidentadas o terreno desconocido.

Segado de pasto extremadamente alto

- Puede ser necesario segar dos veces el pasto extremadamente alto.

Primera pasada de segado:

- Haga un corte alto al pasto (10-15 pulgadas [25-38 mm]) para evitar objetos escondidos.

Segunda pasada de segado:

- Retire los desechos y otros objetos.
- Corte el pasto a la altura deseada y a 90 grados de la primera pasada siempre que sea posible.
- Use las prácticas apropiadas de parada del equipo para su seguridad al bajar del tractor.

Vigile los espacios libres del equipo

Las segadoras con enganche de tres puntos y de montaje lateral tienen un arco de viraje mayor que las segadoras de tiro. Permita suficiente espacio libre para virar con seguridad.

Seguridad en el uso de las segadoras montadas en la parte inferior

Cuando segue con una segadora montada en la parte inferior:

- Mantenga el conducto de descarga desmontable colocado en su lugar sobre el agujero de descarga.
- Nunca permanezca de pie sobre la cubierta de una segadora que esté en operación.
- Distribuya el pasto cortado con el conducto de descarga hacia el área ya segada.
- Use las prácticas apropiadas para la parada del equipo antes de eliminar las obstrucciones de la segadora o conducto de descarga.

Riesgos y peligros de obstrucciones elevadas cuando se usan segadoras de ala o pescante

Verifique que no haya obstrucciones elevadas cuando use segadoras con alas levantadas o de tipo pescante, para evitar lesiones graves o la muerte causadas por el contacto con:

- Líneas de transmisión de energía eléctrica.
- Ramas bajas de árboles.
- Otras obstrucciones elevadas.

Seguridad en el uso de las segadoras de ala y de montaje lateral

Cuando utilice segadoras de ala y de montaje lateral:

Las posiciones con el ala levantada reducen la protección del blindaje y aumentan los riesgos de objetos despedidos y de contacto con la hoja.

Para evitar las lesiones serias o la muerte causadas por objetos despedidos o contacto con la hoja por la subida y bajada de las alas durante las operaciones de segado:

- No segue cuando haya transeúntes en el área de segado.
- Asegúrese de que no haya personas cerca cuando suba o baje las alas.
- Mantenga el período de tiempo durante el que está expuesta la hoja rotativa del ala, a un mínimo práctico durante las operaciones de segado con el ala levantada.
- Detenga el segado si entran personas en el área de segado.
- Solamente suba el ala para pasar sobre objetos que se encuentren en el camino de segado o para seguir la inclinación del terreno.
- Desenganche la transmisión del ala durante los períodos prolongados de segado con las alas levantadas.
- Después de pasar sobre un objeto o sobre inclinaciones del terreno, baje el ala levantada, al suelo.
- Permita que todas las hojas de la segadora detengan su rotación antes de levantar las secciones del ala durante otras operaciones.

Seguridad durante el segado de los bordes de las zanjas

Use cuidado extremo cuando sigue los bordes de las zanjas. Vigile para ver si hay derrumbes, áreas erosionadas y obstrucciones para el segado a lo largo del borde de la zanja. El extremo delantero del tractor puede desviarse hacia la zanja al golpear las obstrucciones con las segadoras de montaje lateral o de pescante.

Las operaciones con segadoras con alas levantadas y pescantes pueden reducir la efectividad del blindaje para objetos despedidos de la segadora que sirven para proteger al operador.

Para aumentar la protección del operador de objetos despedidos durante las operaciones en los bordes de las zanjas:

- Use cabinas cerradas con una estructura contra vuelcos (ROPS), cubiertas protectoras especiales y otros blindajes para el operador, cuando efectúe estas operaciones.
- Inspeccione el área de segado y retire o marque todos los objetos extraños y desechos que deben evitarse con la segadora.



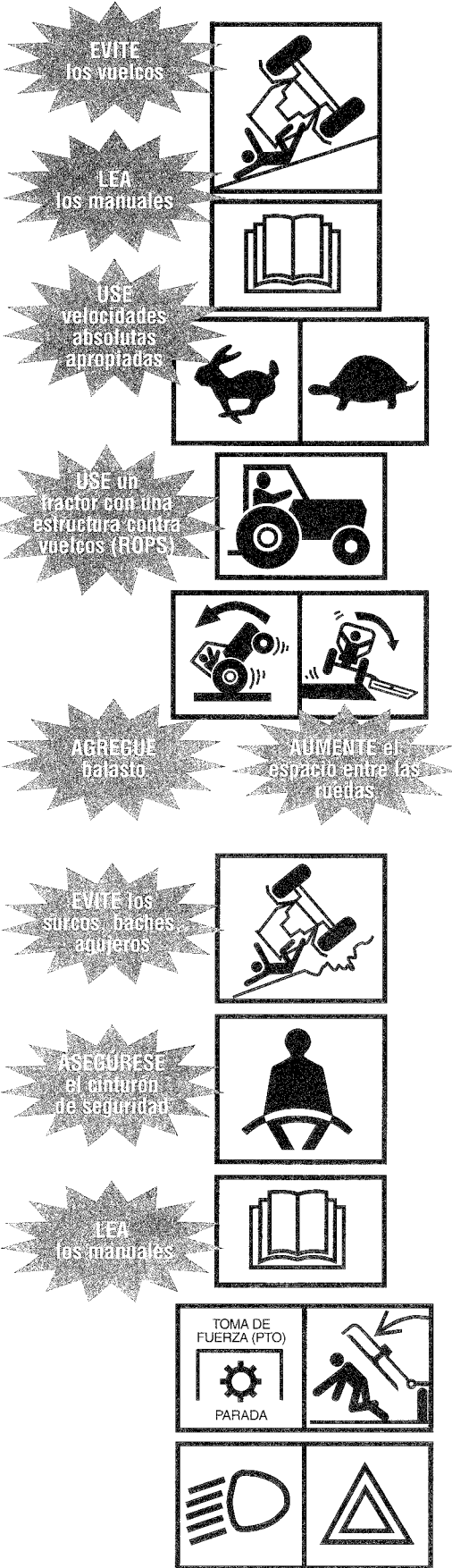

Seguridad durante el segado de terreno accidentado

La estabilidad del tractor y segadora se reduce en las pendientes y terreno accidentado.

Usted puede evitar el vuelco del tractor y segadora y mantener el control de la estabilidad del equipo haciendo lo siguiente:

- Revisando los manuales del operador del tractor y segadora para conocer las prácticas de seguridad de operación en pendientes y terreno accidentado. Explique las prácticas a los usuarios u operadores que no puedan leer.
- Evitando operar en pendientes extremadamente inclinadas.
- Usando cuidado extremo para mantener el control sobre su equipo cuando opere en estas condiciones.
- Aumentando la estabilidad del tractor, agregando pesas a las ruedas y aumentando el espacio entre las mismas, (haga referencia al manual del operador del tractor para conocer las recomendaciones).
- Usando un tractor equipado con una estructura contra vuelcos (ROPS) y cinturón de seguridad para la seguridad del operador durante las operaciones de segado.
- Manteniendo una velocidad absoluta mínima.
- Haciendo virajes anchos y graduales.
- Evitando arranques, paradas y virajes repentinos cuando opere subiendo, bajando o atravesando las pendientes.
- No subiendo del suelo las segadoras montadas atrás o lateralmente ni las alas de segado durante estas operaciones.
- Manteniéndose alerta por si hubiera agujeros, baches, surcos, piedras, troncos u otras obstrucciones que podrían volcar el tractor y segadora.
- Evitando las condiciones de suelo resbaloso que podrían volcar el tractor y segadora.
- Evitando que el tractor y segadora queden atascados al pasar diagonalmente sobre declives y bajadas escarpadas pronunciadas.

Use extremo cuidado para mantener la estabilidad del equipo durante todas las operaciones sobre terreno accidentado y pendientes. Usted tiene la palabra final referente a cualquier pendiente que pueda ser trabajada en forma segura.

Seguridad durante el transporte del equipo en caminos

Si es necesario conducir el equipo sobre los caminos públicos:

- Haga referencia al manual del operador del fabricante del tractor y segadora para conocer las instrucciones.
- Explique las instrucciones a los usuarios u operadores que no puedan leer.
- Verifique las reglamentaciones locales referentes a las marcas, luces, luces intermitentes, etc., requeridas del equipo para el desplazamiento sobre caminos públicos. Se requiere de luces para las segadoras que obstruyen las luces traseras del tractor y/o las luces de advertencia.

Antes del transporte en caminos públicos:

- Desenganche la toma de fuerza (PTO) conectada a la segadora.
- Suba la segadora a la posición de transporte.
- Asegure las alas en la posición de transporte con los seguros en las segadoras de tipo ala y de montaje lateral.
- Enganche la cadena de seguridad entre la segadora de tipo tiro y el tractor.
- Asegúrese de que las luces, luces intermitentes, reflectores y avisos de vehículo de movimiento lento (SMV) están colocados y visibles.
- Revise que el emblema de vehículo de movimiento lento (SMV) sea visible para cualquier vehículo que se acerque desde atrás.

Cuando transporte en caminos públicos:

- Obedezca todas las reglamentaciones locales de tráfico.
- Acérquese a las intersecciones con precaución.
- Cumpla con los avisos de velocidad y de control de tráfico.
- Evite las paradas bruscas y doblar repentinamente.

Seguridad durante el estacionamiento

Estacione el equipo en:

- Áreas designadas o alejadas del tráfico.
- Preferentemente utilice lugares en terreno nivelado.

Lugares de estacionamiento en terreno inclinado:

- Coloque el equipo en posición transversal en las pendientes.
- Aplique los frenos de estacionamiento.
- Baje la segadora al suelo.
- Coloque bloques en las ruedas del tractor.

Antes de estacionar temporalmente y abandonar el equipo incapacitado cerca de áreas con tráfico:

- Retire el equipo de los caminos públicos.
- Coloque las banderas de advertencia.
- Use las luces intermitentes del tractor.

Seguridad durante la parada

Para su seguridad use las prácticas apropiadas para la parada del equipo

Haga referencia al (los) manual(es) del operador del fabricante del tractor y segadora para conocer los procedimientos de parada recomendados. Explique los procedimientos a los usuarios u operadores que no puedan leer.

Haga que los procedimientos apropiados de parada del equipo sean una costumbre importante que se debe practicar. Siga estas prácticas de seguridad antes de bajarse del tractor:

- Desenganche el embrague y transmisión de la toma de fuerza (PTO).
- Para que el motor enfríe gradualmente permita que funcione al ralentí.
- Coloque los controles en estacionamiento (P) o en punto muerto (N).
- Coloque el freno de estacionamiento.
- Baje la segadora al suelo.
- Baje al suelo las alas de las segadoras de tipo ala.
- Apague el motor.
- Espere a que todas las piezas movibles se detengan antes de efectuar inspecciones, ajustes o reparaciones al equipo.
- Descargue la presión hidráulica moviendo los controles hidráulicos varias veces en todas las direcciones.
- Asegure la ignición y extraiga la llave cuando el equipo debe ser inspeccionado, reparado, ajustado o va a permanecer desatendido.
- Asegure las cubiertas contra el vandalismo cuando el equipo permanece desatendido.
- Baje cuidadosamente manteniendo un contacto de tres puntos.

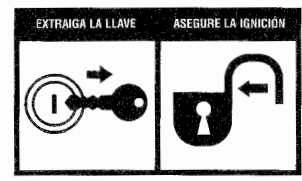
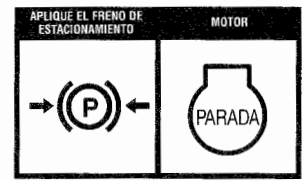
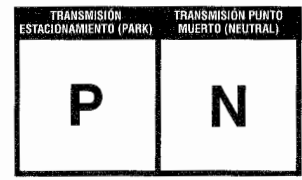
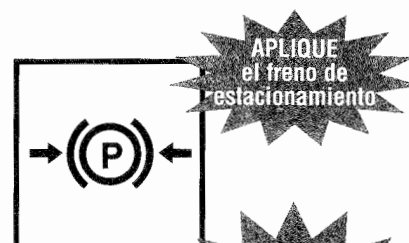

ESPERE que las piezas móviles se detengan antes de bajar

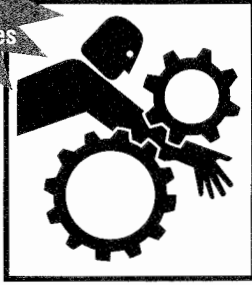

USE el contacto de tres puntos



DE MANTENIMIENTO a su equipo

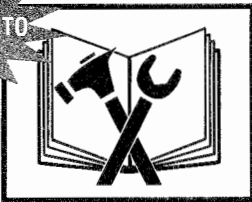

CUMPLA

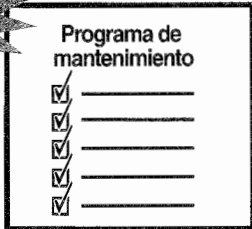

Seguridad durante la bajada del tractor

Antes de bajar del tractor haga lo siguiente:

- Para su seguridad, use las prácticas apropiadas para la parada del equipo.
- Baje el implemento al suelo, apague el motor y la toma de fuerza (PTO), aplique los frenos, permita que se detengan todas las piezas móviles y extraiga la llave antes de bajar del tractor.
- Nunca baje del equipo cuando esté en movimiento.
- Nunca salte de las máquinas.
- Baje cuidadosamente.
- Verifique que los escalones no estén resbalosos.
- Mantenga los pies y manos alejados de los controles.
- Use las asas para las manos y los escalones para bajar.
- Vea hacia la máquina y use el contacto de 3 puntos (2 manos, 1 pie ó 2 pies, 1 mano).

Seguridad durante el mantenimiento

Seguridad durante el mantenimiento

Para su seguridad haga lo siguiente antes de efectuar procedimientos de mantenimiento, reparación o servicio:

- Cumpla con la práctica apropiada para la parada del equipo.
- Use toda la ropa protectora y equipo de seguridad personal necesarios para efectuar el trabajo en forma segura.
- Haga referencia a sus manuales del fabricante para conocer los procedimientos correctos de mantenimiento, reparación y servicio. Explique los procedimientos a los usuarios y operadores que no puedan leer.

Las fuentes de energía almacenada (eléctrica, mecánica, hidráulica, neumática, química, térmica etc.) deben estar aseguradas, bloqueadas, descargadas, desconectadas, apagadas, aseguradas, neutralizadas, controladas o reducidas a un mínimo práctico, antes de efectuar con seguridad cualquier procedimiento de mantenimiento, reparación o servicio.

Algunas prácticas de seguridad básicas para evitar posibles lesiones causadas por las fuentes que emiten energía:

- Desenganche la toma de fuerza (PTO) antes de apagar el motor.
- Coloque los controles en estacionamiento (P) o punto muerto (N) antes de apagar el motor.
- Aplique el freno de estacionamiento o coloque bloques en las ruedas.
- Permita que todas las piezas movibles se detengan.
- Baje la segadora al suelo.
- En las segadoras de tipo ala, baje las alas al suelo.
- Apague el motor del tractor.
- Asegure la ignición y extraiga la llave.
- Observe y escuche para establecer si hay piezas en movimiento antes de abrir los blindajes.
- Soporte o coloque bloques firmemente debajo de la segadora antes de trabajar debajo de la segadora u otros componentes elevados.
- Soporte, coloque bloques o asegure firmemente las alas de la segadora con los seguros antes de trabajar cerca o debajo de una segadora de tipo ala.
- Descargue la presión del sistema hidráulico moviendo los controles varias veces en todas direcciones.
- Descargue la presión antes de desconectar o desensamblar cualquier sistema presurizado.
- Coloque bloques o descargue la presión del resorte antes de desensamblar cualquier dispositivo a resorte.
- Soporte o bloquee firmemente cualquier componente de la máquina que esté elevado, antes de trabajar en ella.
- Evite las llamas, chispas o fumar cerca de cualquier combustible.



Su seguridad y las piezas del fabricante para la segadora

La mayoría de los fabricantes de segadoras usan sujetadores y piezas especialmente diseñadas para cumplir con los requerimientos de la operación de segado.

Seguridad crítica – piezas relacionadas (pernos de la hoja autoasegurados, hojas, pasadores, blindajes u otros artículos especiales) tienen requerimientos de fuerza, diseño y encaje específicos para el estilo y modelo de la segadora que usted utiliza.

Las modificaciones o piezas para reparación que no son aprobadas por el fabricante de la segadora pueden causar un riesgo significativo por exposición a su seguridad y la de los demás.

PARA EVITAR LAS LESIONES SERIAS O LA MUERTE CAUSADAS POR PIEZAS O MODIFICACIONES NO APROBADAS:

- No sustituya accesorios comunes por los pernos autoasegurados de las hojas u otras piezas especiales.
- No sustituya las hojas, pasadores, blindajes u otras piezas relacionadas con la seguridad crítica.
- No use pernos de grado 5 u 8 para reemplazar los pernos de resistencia limitada grado 2.

CUMPLA LA PRÁCTICA SEGURA DE SIEMPRE VERIFICAR EL FUNCIONAMIENTO CORRECTO DE TODOS LOS AJUSTES, REPARACIONES O SERVICIO DE LA SEGADORA.



Palabra final

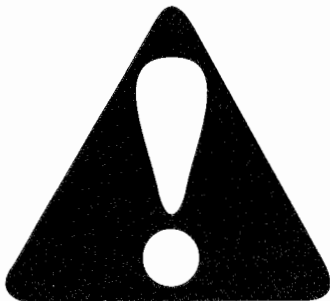

Usted ha terminado de leer el manual de seguridad de la segadora. Es imposible que este manual incluya toda situación peligrosa potencial que usted pueda encontrar. Sin embargo, su conocimiento de estas precauciones de seguridad y su cumplimiento de las reglas básicas de seguridad le ayudarán a crear buen juicio para todas las situaciones. Nuestro objetivo es ayudarle a desarrollar buenos hábitos de seguridad y hacerlo un mejor operador de segadora. El manual de seguridad de la segadora, precauciones de seguridad y reglas básicas de seguridad deben explicarse a los usuarios u operadores que no puedan leer.

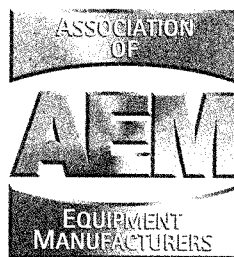

111 E. Wisconsin Avenue • Milwaukee, Wisconsin 53202 U.S.A.
www.aem.org

Para obtener información de reproducciones adicionales y
otros manuales de seguridad, llame al 800-369-2310

INTRODUCTION SECTION

Introduction Section 2-1

INTRODUCTION

INTRODUCTION

This Rotary Mower is designed with care and built with quality materials by skilled workers. Proper assembly, maintenance, and operating practices, as described in this manual, will help the owner/operator get years of satisfactory service from the machine.

The purpose of this manual is to familiarize, instruct, and train. The Assembly Section instructs the owner/operator in the correct assembly of the Mower using standard and optional equipment. The Parts Listing section is designed to familiarize the owner/operator with replaceable parts on the Mower. This section provides exploded assembly drawings of each mower component illustrating each piece and the corresponding part number.

Careful use and timely service save extensive repairs and costly downtime losses. The Operation and Maintenance Sections of the manual train the owner/operator how to work the Mower correctly and attend to appropriate maintenance. The Trouble Shooting Guide helps diagnose difficulties with mower and offers solution to the problems.

Safety is of primary importance to the owner/operator and to the manufacturer. The first section of this manual includes a list of Safety Messages, that, if followed, will help protect the operator and bystanders from injury or death. Many of the Safety Messages will be repeated throughout the manual. The owner/operator/dealer should know these Safety Messages before assembly and be aware of the hazards of operating this mower during assembly, use, and maintenance. The Safety Alert Symbol combined with a Signal Word, as seen below, is intended to warn the owner/operator of impending hazards and the degree of possible injury faced when operating this machine.



Indicates an imminently hazardous situation that, if not avoided, WILL result in DEATH OR VERY SERIOUS INJURY.



Indicates an imminently hazardous situation that, if not avoided, COULD result in DEATH OR SERIOUS INJURY.



Indicates an imminently hazardous situation that, if not avoided, MAY result in MINOR INJURY.

Important

Identifies special instructions or procedures that, if not strictly observed, could result in damage to, or destruction of the machine, attachments or the environment.

INTRODUCTION

FC-R-0020



INTRODUCTION

The SL60 rotary mower is designed to be operated on skid steer power units. These rugged Mowers are designed for medium-duty work and are related to cut vegetation up to 2" in diameter.

▲ DANGER

The Power Unit must be equipped with an Operator Front Protective Door. Serious injury or death can result from a thrown object hitting an unprotected operator. Contact the Power Unit manufacturer or an authorized dealer for this protective feature. Always wear protective clothing including safety glasses and hearing protection when operating this mower. (SPU-11)

▲ DANGER

The mower is equipped with a HEIGHT LIMITING CHAIN, RUBBER DEFLECTOR, and DOUBLE CHAIN GUARDS to protect the operator from thrown objects. The height limiting chain must be securely attached to the front of the skid steer chassis. When attaching the chain, the skid steer must be completely shut down, its parking brake set, and the mower lowered to ground level. DO NOT operate the mower if the chain, deflector, or chain guards are missing or are not secured to the skid steer chassis..

Mower Orientation: Front and rear, and left and right are determined by the normal direction of travel (the same as your automobile).

INTRODUCTION

ATTENTION OWNER/OPERATOR

BEFORE OPERATING THIS MACHINE:

1. Carefully read the Operator's Manual, completely understand the Safety Messages and instructions, and know how to operate correctly both the Mower and Power Unit.
2. Fill out the Warranty Card in full. Be sure to answer all questions, including the Serial Number of the Mower. Mail promptly using the return envelope included with the Operator's Manual.

NOTE: Warranties are honored only if completed "Owner Registration and Warranty" forms are received by Alamo Group within thirty days of delivery of the mower.

3. Record the Mower Model and Serial Numbers on the Warranty page at the end of the Operator's Manual. Keep this as part of the permanent maintenance file for the Mower.

IMPORTANT

For your safety and to guarantee optimum product reliability, always use Genuine ALAMO INDUSTRIAL replacement parts. The use of inferior "will-fit" parts will void Warranty of your ALAMO INDUSTRIAL implement and may cause premature or catastrophic failure which can result in serious injury or death. If you have any questions concerning the repair parts you are using, contact ALAMO INDUSTRIAL, 1502 E. Walnut Seguin, TX 78155 (830) 372-3551.

///ALAMO[™]
INDUSTRIAL 02925100

ASSEMBLY SECTION

Assembly Section 3-1

ASSEMBLY

DEALER SETUP INSTRUCTIONS

Set up mower as received from factory with these instructions.

This mower is shipped partially assembled. Assembly will be easier if components are aligned and loosely assembled before tightening hardware. Refer to bolt torque chart in Maintenance Section. All bolts are Grade 5 unless otherwise specified.

All references to location as right, left, front, rear, top and bottom is viewed facing the direction of forward travel when the implement is properly attached to the operating power unit.



Never work under the Implement, the framework, or any lifted component unless the Implement is securely supported or blocked up to prevent sudden or inadvertent falling which could cause serious injury or even death. (SG-14)



Do not modify or alter this Implement. Do not permit anyone to modify or alter this Implement, any of its components or any Implement function. (SG-8)

HITCH LINKAGE SETUP INSTRUCTIONS

IMPORTANT! For shipping purposes, the mower hitch floating links are positioned to flex downward toward the mower deck. Before operation, the linkage must be re-configured to flex outward. Failure to reposition floating linkage bolt and bushing as described below before operation could result in mower hitch failure.

1. Place the cutter on a solid level surface resting on its skids.
2. Remove lower bolt, nut and bushing which are installed through both hitch link lower holes for shipping purposes only as shown in top figure.



ASSEMBLY

3. Place bushing between both arms above mower link and install 5/8" bolt through bushing and fasten with 5/8" locknut.



HITCH ASSEMBLY

1. Secure Hitch Weldment (1) to mower deck using 1" x 5" Bolts (7) and 1" Locknuts (6).
2. Insert Bushing (5) in upper holes of hitch weldment, place a set of Upper Floating Links (3) on each side of bushing, and secure together using 5/8" x 1-3/4" Bolt (8) and 5/8" Locknuts (9). Place bushing (5) between opposite upper floating link set ends and secure pairs together with bolt (8) and locknut (9).
3. Place bushing (5) into end of Lower Floating Links (4) and secure between upper links with bolt (8) and locknut (9). Place another bushing into opposite lower link hole and place against outside of lugs near center of mower deck. Insert bolt (8) through link, bushing, and lug, and retain together with 5/8" Flat Washer (10), and locknut (9).
4. Secure Safety Chain (2) around lower hitch frame.
5. Tighten all bolts and nuts to the recommend torque. (Refer to Image Asm-R-0270)

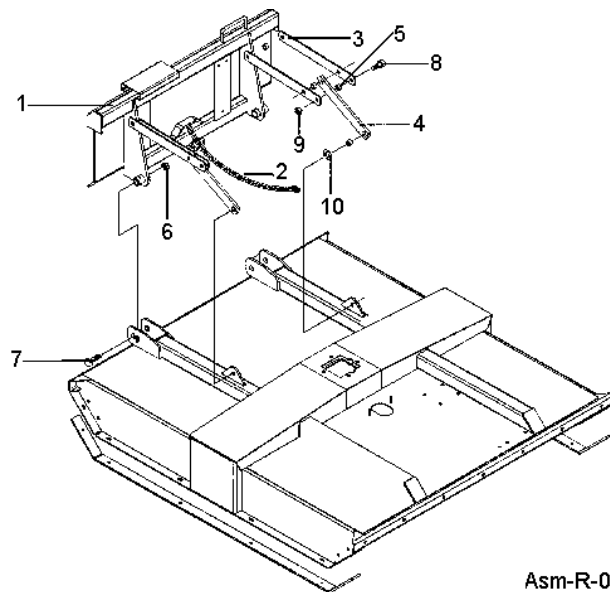

Asm-R-0270

ASSEMBLY

FRONT CHAIN GUARD ASSEMBLY

1. Attach Chain Guard Bracket (6) to Deflector Bracket (5) using 1/2" x 1-1/4" Bolts (8), 1/2" Flatwashers (2), and 1/2" Locknuts (1). Do not attach ends together at this time.
2. Attach Deflector Bracket (5) to deck using 1/2" x 1-1/2" Bolts (3), flatwasher (2), and locknuts (1).
3. Attach the Right and Left Side Shields (4 and 7) to deck sides using bolts (8), flatwashers (2), and locknuts (1). Insert bolt (3) through top of side shields (4 and 7), deflector bracket (5), and chain guard bracket (6) and secure together using flatwashers (2) and locknuts (1).
4. Tighten all bolts and nuts to the recommended torque. (Refer to Image Asm-R-0271)

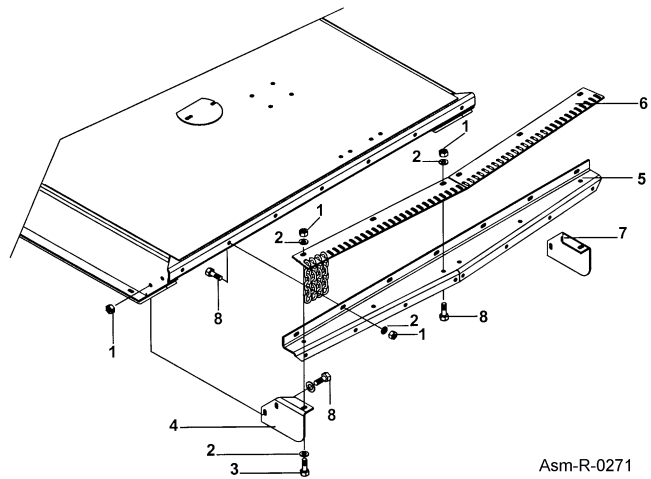

Asm-R-0271

REAR CHAIN GUARD ASSEMBLY

1. Place Deflector Strap (6) against mower deck left side and Chain Guard Bracket (8) against mower deck right side. Place Rear Deflector Panel (5) against bracket and deflector and align hole through panel, deflector/bracket, and mower deck and secure together using 1/2" x 1-1/2" Bolts (4), Flatwashers (2), and Locknuts (1).
2. Tighten all bolts and nuts to the recommended torque. (Refer to Image Asm-R-0272)

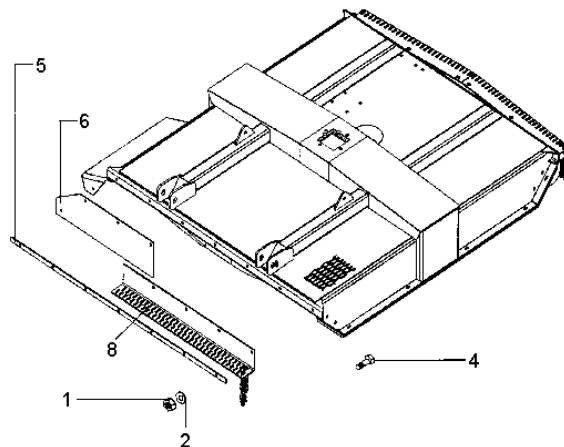

Asm-R-0272

ASSEMBLY

SIDE DEFLECTOR ASSEMBLY

1. Place Side Deflector Panel (3) on top lip of left rear discharge chute. Place Side Deflector Strap (4) on top of panel and align holes of strap, panel, and mower deck. Secure together using $1/2" \times 1-1/4"$ Bolts (1) and Locknuts (2).
2. Secure side deflector panel (3) end to chute using bolts (1), Flatwasher (5), and Locknut (2).
3. Tighten all bolts and nuts to the recommended torque. (Refer to Image Asm-R-0273)

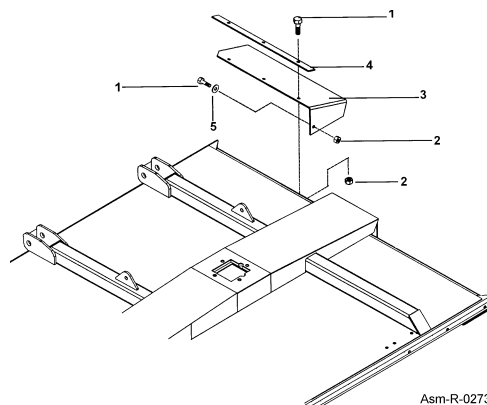

SKID SHOE ASSEMBLY

1. Attach Flat Bar Left and Right Hand Skid Shoes (1 and 5) to the underside of the mower side skirts using $3/8" \times 1-1/2"$ Bolts (2), Flatwashers (3), and Locknuts (4). Insert bolts from the underside up to ensure that threads do not become worn and nuts can be removed if skid shoes are to be replaced at a later time.
2. Secure Front Right and Left Hand Skid Shoes (6 and 7, optional equipment) to the front of the mower using bolts (2), locknuts (4), and lockwashers (3). Front skid shoes have multiple hole patterns that enable deck height to be placed at desired mowing height.
3. Tighten all bolts and nuts to the recommended torque. (Refer to Image Asm-R-0274)

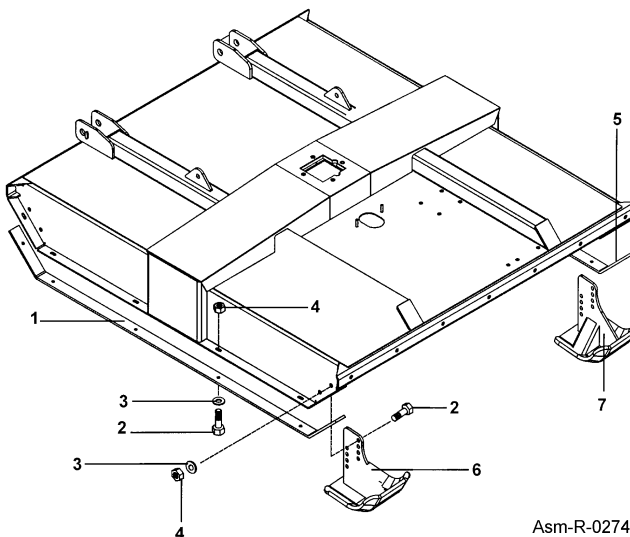

ASSEMBLY

OPERATION SECTION

Operation Section 4-1

OPERATION

OPERATION

RHINO SL60 SKID STEER ROTARY MOWER OPERATION INSTRUCTIONS

Alamo Industrial SL60 rotary mowers are manufactured with quality material by skilled workers. These mowers are designed to cut grass, weeds, small brush, and other vegetative material up to 2" in diameter. The mower is equipped with protective deflectors and chain guards to prevent objects being thrown from the mower by the blades, however, no shielding is 100% effective. All shields, guards, deflectors, and chains equipped on the unit must be maintained on the mower in good operational condition.

It is the operator's responsibility to be knowledgeable of all potential operating hazards and to take every reasonable precaution to ensure oneself, others, animals, and property are not injured or damaged by the mower, tractor, or a thrown object. Do not operate the mower if passersby, pets, livestock, or property are within 300 feet of the unit.

This section of the Operator's Manual is designed to familiarize, instruct, and educate safe and proper mower use to the operator. Pictures contained in this section are intended to be used as a visual aid to assist in explaining the operation of a rotary mower and are not necessarily of a SL60 cutter. Some pictures may show shields removed for purposes of clarity. NEVER OPERATE this implement without all shields in place and in operational condition. The operator must be familiar with mower and skid steer operation and all associated safety practices before operating the mower and skid steer. Proper operation of the mower, as detailed in this manual, will help ensure years of safe and satisfactory use of the mower.

IMPORTANT: To avoid mower damage, retorque all bolts after the first 10 hours of operation. Retighten blade carrier retaining nut on gearbox lower shaft to 400 ft. lbs.

READ AND UNDERSTAND THE ENTIRE OPERATING INSTRUCTIONS AND SAFETY SECTION OF THIS MANUAL AND THE TRACTOR MANUAL BEFORE ATTEMPTING TO USE THE TRACTOR AND IMPLEMENT. If you do not understand any of the instructions, contact your nearest authorized dealer for a full explanation. Pay close attention to all safety signs and safety messages contained in this manual and those affixed to the implement and tractor. *OPS-U-0001*

READ, UNDERSTAND, and FOLLOW the following Safety Messages. Serious injury or death may occur unless care is taken to follow the warnings and instructions stated in the Safety Messages. Always use good common sense to avoid hazards. (SG-2)

**SAFETY
INSTRUCTIONS**



PELIGRO

Si no lee ingles, pida ayuda a alguien que si lo lea para que le traduzca las medidas de seguridad. (SG-3)

**¡ LEA EL
INSTRUCTIVO!**



OPERATION

1. SL60 Standard Equipment and Specifications

Cutting Width	60"
Cutting Capacity (Diameter)	2" maximum
Cutting Height Range	1-9/16" to 18"
Overall Width	65-1/2"
Overall Length	73"
Front and Rear Guards	Standard
Hitch	Universal Mount, Quick
Weight (Approximate)	875 lbs.
Drive Protection	Hydraulic Relief Valve
Blade Carrier	Pan
Deck Thickness	10 Gauge
Side Skirts	1/4" x 9-1/2"
Replaceable Skid Shoes	Standard
Drive Motors:	
Low Volume.....	For Systems Delivering 11-14 GPM at 1500-3000 PSI; 105 ft./lbs. Torque at 2500 PSI
Medium Volume.....	For Systems Delivering 15-19 GPM at 1500-3000 PSI; 127 ft./lbs. Torque at 2500 PSI
High Volume.....	For Systems Delivering 20-25 GPM at 1500-3000 PSI; 153 ft./lbs. Torque at 2500 PSI
Blade Tip Speed:	
Low Volume.....	11 GPM / 12,517 FPM 14 GPM / 15,931 FPM
Medium Volume.....	15 GPM / 14,240 FPM 19 GPM / 18,038 FPM
High Volume.....	20 GPM / 14,222 FPM 25 GPM / 17,777 FPM
Optional Equipment.....	Front-Mounted Skid Shoes

OPERATION

2. OPERATOR REQUIREMENTS

Safe operation of the unit is the responsibility of a qualified operator. A qualified operator has read and understands the implement and tractor Operator's Manuals and is experienced in implement and tractor operation and all associated safety practices. In addition to the safety messages contained in this manual, safety signs are affixed to the implement and tractor. If any part of the operation and safe use of this equipment is not completely understood, consult an authorized dealer for a complete explanation.

If the operator cannot read the manuals for themselves or does not completely understand the operation of the equipment, it is the responsibility of the supervisor to read and explain the manuals, safety practices, and operating instructions to the operator.

Safe operation of equipment requires that the operator wear approved Personal Protective Equipment (PPE) for the job conditions when attaching, operating, servicing, and repairing the equipment. PPE is designed to provide operator protection and includes the following safety wear:

PERSONAL PROTECTIVE EQUIPMENT (PPE)

- Protective Eye Glasses, Goggles, or Face Shield
- Hard Hat
- Steel Toe Safety Footwear
- Gloves
- Hearing Protection
- Close Fitting Clothing
- Respirator or Filter Mask (depends on operating conditions) OPS-U- 0002

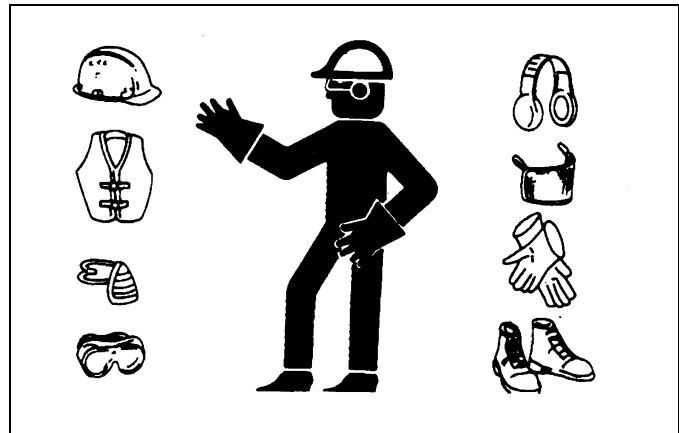

NEVER use drugs or alcohol immediately before or while operating the Tractor and Implement. Drugs and alcohol will affect an operator's alertness and coordination and therefore affect the operator's ability to operate the equipment safely. Before operating the Tractor or Implement, an operator on prescription or over-the-counter medication must consult a medical professional regarding any side effects of the medication that would hinder their ability to operate the Equipment safely. NEVER knowingly allow anyone to operate this equipment when their alertness or coordination is impaired. Serious injury or death to the operator or others could result if the operator is under the influence of drugs or alcohol. (SG-

27)

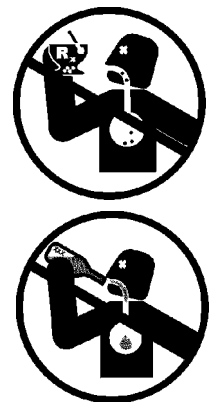

OPERATION

3. SKID STEER REQUIREMENTS

Skid Steer Requirements and Capabilities

- ASAE approved Roll-Over Operator Protective Structure and Seatbelt.
- Operator Protective Door Contact authorized skid steer dealer for equipping unit with operator protective door.
- Skid Steer Warning Equipment Slow Moving Vehicle (SMV) emblem, proper lighting
- Hitch Universal Mount, Quick Hitch
- Front Auxiliary Hydraulics..... Mower drive motors must be matched with the hydraulic output capacity of the skid steer

Mower Drive Motors:

- Low Volume For Systems Delivering 11-14 GPM at 1500-3000 PSI;
105 ft./lbs. Torque at 2500 PSI
- Medium Volume For Systems Delivering 15-19 GPM at 1500-3000 PSI;
127 ft./lbs. Torque at 2500 PSI
- High Volume For Systems Delivering 20-25 GPM at 1500-3000 PSI;
153 ft./lbs. Torque at 2500 PSI

3.1 ROPS and Seat Belt

The tractor must be equipped with a Roll-Over-Protective-Structure (ROPS) (tractor cab or roll-bar) and seat belt to protect the operator from falling off the tractor, especially during a roll over where the driver could be crushed and killed. Only operate the tractor with the ROPS in the raised position and seat belt fastened. Tractor model not equipped with a ROPS and seat belt should have these life saving features installed by an authorized dealer. *OPS-U- 0003*



Operate this Equipment only with a Power Unit equipped with an approved operator Roll-Over Protective Structure (ROPS). Always wear seat belts. Serious injury or even death could result from falling off the Power Unit--particularly during a turnover when the operator could be pinned under the Operator Protective Structure. (SPU-14)



OPERATION

3.2 Operator Protective Door

The skid steer must be equipped with an Operator Front Protective Door. Serious injury or death can result from a thrown object hitting an unprotected operator. Contact the skid steer manufacturer or an authorized dealer for this protective feature. *OPS-SS-0017*



3.3 Tractor Safety Devices

If transporting or operating the tractor and implement near a public roadway, the tractor must be equipped with proper warning lighting and a Slow Moving Vehicle (SMV) emblem which are clearly visible from the rear of the unit. Lights and a SMV emblem must be equipped directly on implements if the visibility of the tractor warning signals are obscured.

Maintain all manufacturer equipped safety shields and guards. Always replace shields and guards that were removed for access to connect, service, or repair the tractor or implement. Never operate the tractor PTO with the PTO master shield missing or in the raised position. *OPS-U- 0004*

3.4 Hitch

The skid steer must be equipped with a compatible Standard Universal Quick Mount Hitch to connect and operate the mower. *OPS-SS-0001*



OPERATION

3.5 Auxiliary Hydraulics

The skid steer must be equipped with Front Auxiliary Hydraulics. The hydraulic output capacity of the skid steer must match the equipped mower drive motor. Reference the skid steer operator's manual to determine the hydraulic output specifications of the skid steer.

A decal is affixed to the mower designating the mower as equipped with either a High, Medium, or Low Flow Motor. If the decal is missing or is not legible, the motor flow volume can be determined from its part number (found on tag attached to the motor) using the table to the right or by contacting Servis-Rhino customer service.

The mower is not shipped equipped with hydraulic hose coupler ends. Coupler ends must be purchased from an authorized skid steer dealer to ensure mower and skid steer auxiliary hydraulic couplers are compatible



Part Number	Flow Volume
00776387	LOW
00776388	MEDIUM
00776389	HIGH

4. GETTING ON AND OFF THE SKID STEER

Before getting onto the skid steer, the operator must read and completely understand the implement and skid steer operator manuals. If any part of either manual is not completely understood, consult an authorized dealer for a complete explanation. OPS-SS- 0002

OPERATION

WARNING

Do not mount the Power Unit while the Power Unit is moving. Mount the Power Unit only when the Power Unit and all moving parts are completely stopped. (SPU-18)



4.1 Dismounting the Skid Steer

Before dismounting, park the skid steer and mower on a reasonably level surface, apply the parking brake, idle the engine down, disengage the auxiliary hydraulics, and lower the mower to the ground. Shut down the skid steer engine according to the operator's manual, remove the key, and wait for all motion to completely stop. Never leave the seat until the skid steer, its engine and all moving mower parts are completely stopped. OPS-SS- 0003

DANGER

Never allow children or other persons to ride on the Power Unit or Implement. Falling off can result in serious injury or death. (SPU-16)



DANGER

Never allow children to operate or ride on the Power Unit or Implement. (SPU-17)



OPERATION

4.2 Dismounting the Skid Steer

Before dismounting, park the skid steer and mower on a reasonably level surface, apply the parking brake, idle the engine down, disengage the auxiliary hydraulics, and lower the mower to the ground. Shut down the skid steer engine according to the operator's manual, remove the key, and wait for all motion to completely stop. Never leave the seat until the skid steer, its engine and all moving mower parts are completely stopped.



BEFORE leaving the Power Unit seat, always engage the brake and set the Power Unit transmission in parking gear, disengage the auxiliary hydraulics, stop the engine, remove the key, and wait for all moving parts to stop. Place the Power Unit shift lever into a low range or parking gear to prevent the tractor from rolling. Never dismount a Power Unit that is moving or while the engine is running. Operate the Power Unit controls from the operator seat only.

(SPU-15)

Use hand rails and steps when exiting the skid steer. Be careful of your step and use extra caution when mud, ice, snow or other matter has accumulated on the steps or hand rails. Use all handrails and steps for support and never rush or jump off the skid steer.

5. STARTING THE SKID STEER

The operator must have a complete understanding of the placement, function, and operational use of all skid steer controls before starting the skid steer. Review the skid steer operator's manual and consult an authorized dealer for operating instructions if needed.

Essential Skid Steer Controls:

- Locate the light control lever
- Locate the engine shut off control
- Locate the brake pedals and the clutch
- Locate the auxiliary hydraulic control lever.
- Locate the boom height foot controls.
- Locate the hitch tilt foot controls.

Before starting the skid steer ensure the following:

- Conduct all pre-start operation inspection and service according to the skid steer operator's manual.
- Make sure all guards, shields, and other safety devices are securely in place.
- The parking brake is on.
- The skid steer transmission is in neutral.
- The auxiliary hydraulics are disengaged.
- The boom height/tilt controls are in the neutral position.

Refer to the skid steer owner's manual for procedures to start the skid steer. Only start the skid steer while seated and belted in the operator's seat. Never bypass the ignition switch by short circuiting the starter solenoid.

After the engine is running, avoid accidental contact with the skid steer transmission to prevent sudden and unexpected skid steer movement.

OPS-SS-0022



Never run the Power Unit engine in a closed building or without adequate ventilation. The exhaust fumes can be hazardous to your health. (SPU-23)

OPERATION



Start the Power Unit only when properly seated in the Power Unit seat. Starting a Power Unit in gear can result in injury or death. Read the Power Unit Operator's Manual for proper starting instructions. (SPU-19)



6. CONNECTING THE MOWER TO THE SKID STEER

Use extreme caution when connecting the mower to the skid steer. The mower should be securely resting at ground level or on blocks. Keep hands and feet out from under the mower and clear of pinch points between the mower and skid steer. OPS-SS-0023



Always shut the Power Unit completely down, place the transmission in park, and set the parking brake before you or anyone else attempts to connect or disconnect the Implement and Power Unit hitches. (SPU-32)



Never work under the Implement, the framework, or any lifted component unless the Implement is securely supported or blocked up to prevent sudden or inadvertent falling which could cause serious injury or even death. (SG-14)



OPERATION

6.1 Connecting the Hitches

Important

The mower can only be attached to skid steers equipped with a universal quick mount hitch. The mower attaches to the skid steer by engaging the skid steer mounting plate under the mower hitch saddle weldment and locking hitch pins to secure the skid steer and mower hitches together. OPS-SS-0024

1. With the engine completely shut down and the parking brake set, rotate the skid steer latch handles upward to the unlatched position. The latch handles must be completely raised to fully retract the hitch lock pins.
2. Start the skid steer and tilt the hitch mounting plate forward while guiding the mounting plate crest under the attachment saddle of the mower. Raise and roll back the mounting plate until the mower hitch plate is securely seated flat against the skid steer mounting plate.
3. With the mower fully supported by the skid steer boom, lower the mower to ground level. Slightly tilt the front of the mower head upward about 2" from ground level. Turn off the engine, set the parking brake, and exit the skid steer. Push both latch handles downward to engage the hitch pins into the mower hitch retaining tabs. Never extend any part of your body from the operator's area to operate latches or to connect hydraulic lines or the height limiting chain. The mower hitch is now securely attached to the mounting plate of the skid steer.
4. With the skid steer still completely shut down, secure the height limiting safety chain to the front of the skid steer chassis.



OPERATION

OPERATION

6.2 Connecting Mower and Skid Steer Hydraulics Lines

1. Before connecting the mower hydraulic lines to the skid steer auxiliary hydraulic ports, be sure that the hydraulic output capacity of the skid steer matches the rated capacity of the mower and that the hydraulic lines and quick couplers are of the same size and type.
2. With the skid steer completely shut down and secured in position and the mower resting at ground level, relieve auxiliary hydraulic pressure by moving the control levers back and forth several times.
3. When connecting the skid steer hydraulic lines to the mower, keep hoses, quick couplers, and swivels free of contamination. Clean dirt and other debris from the connections with a clean rag to prevent contamination of the hydraulic oil.
4. The mower will only operate with oil fed through the mower in one direction. If the mower does not operate when the auxiliary hydraulics are engaged, oil is probably being fed through the motor in the reverse direction. To correct this problem, reverse the hydraulic line connection between the mower and skid steer and engage the hydraulics again or try engaging the auxiliary hydraulic lever in the opposite direction.
5. Once hydraulic lines are properly connected for operation, secure cordura sleeving over couplers to retain possible leaks.

NOTE: *If hydraulic lines are removed from the pump or if couplers are removed from hose ends, ensure lines and couplers are replaced in the same configuration as removed to ensure correct oil flow direction is maintained.*



OPERATION

7. PRE-OPERATION INSPECTION AND SERVICE

Before each use, a pre-operation inspection and service of the implement and tractor must be performed. This includes routine maintenance and scheduled lubrication, inspecting that all safety devices are equipped and functional, and performing needed repairs. DO NOT operate the unit if the pre-operation inspection reveals any condition affecting safe operation. Perform repairs and replacement of damaged and missing parts as soon as noticed. By performing a thorough pre-operation inspection and service, valuable down time and repair cost can be avoided. *OPS-U-0029*

▲ DANGER

Always disconnect the auxiliary hydraulic couplers from the Power Unit before performing service on the Implement. Never work on the Implement with the Power Unit auxiliary hydraulics connected. Rotating parts such as blades could turn without warning and cause immediate entanglement, injury or death. (SPU-31)

▲ WARNING

Periodically inspect all moving parts for wear and replace when necessary with authorized service parts. Look for loose fasteners, worn or broken parts, and leaky or loose fittings. Make sure all pins have cotter pins and washers. Serious injury may occur from not maintaining this machine in good working order. (SG-21)



OPERATION

7.1 Skid Steer Pre-Operation Inspection/Service

Refer to the skid steer operator's manual to ensure a complete pre-operation inspection and scheduled service is performed according to manufacturer recommendations. The following is a partial list of items requiring inspection:

- Tire condition/air pressure
- Wheel lug bolts
- SMV sign is clean and visible
- Skid Steer lights are clean and functional
- Skid Steer Seat belt is in good condition
- Skid Steer operator enclosure is in good condition
- Operator front protective door condition
- No oil leaks
- Radiator free of debris
- Engine oil level and condition
- Engine coolant level and condition
- Hydraulic oil level and condition
- Fuel condition and level
- Sufficient lubrication at all lube points
- Air filter condition

OPS-SS-0025



7.2 Mower Pre-Operation Inspection/Service

Before each mower use, a complete inspection and service is required to ensure the mower is in a good and safe working condition. Damaged and/or broken parts should be repaired and/or replaced immediately. To ensure the mower is ready for operation, conduct the following.



All Safety Shields, Guards and Safety devices including (but not limited to) - the Deflectors, Chain Guards and Height Limiting Safety Chain should be used and maintained in good working condition. All safety devices should be inspected carefully at least daily for missing or broken components. Missing, broken, or worn items must be replaced at once to reduce the possibility of injury or death from thrown objects, entanglement, or blade contact. (SPU-28)



Replace bent or broken blades with new blades. NEVER ATTEMPT TO STRAIGHTEN, WELD, OR WELD HARDFACING ON BLADES SINCE THIS WILL LIKELY CRACK OR OTHERWISE DAMAGE THE BLADE WITH SUBSEQUENT FAILURE AND POSSIBLE SERIOUS INJURY FROM THROWN BLADES. (SGM-10)

OPERATION

The operator's manual and safety signs affixed on the unit contain important instructions on the safe and proper use of the equipment. Maintain these important safety features on the implement in good condition to ensure the information is available to the operator at all times.

- Ensure the manual canister is secured to the equipment with the operator's manual inside.
- Ensure all safety signs are in place and legible. Replace missing, damaged, and illegible decals. *OPS-U-0011*



- Ensure the mower is securely attached to the skid steer mounting plate and the latch pins are engaged.
- Ensure the height limitin safety chain is correctly secured and connected between the mower and skid steer chassis.
- Check that the hydraulic couplers connecting the skid steer and mower hydraulics are securely attached. Secure cordura sleeving around coupler connections to contain possible leaks. *OPS-SS-0005*



- Ensure chain guards and rubber deflectors are in position and not damaged. Replace worn, broken, and missing sections immediately.
- Inspect that all bolts and screws are in position and are properly torqued. *OPS-SS-0006*



OPERATION

OPERATION

- Perform scheduled lubrication as specified in the maintenance section.
- Inspect the spindle oil level and replenish if needed. A low oil level is a warning sign that the spindle housing may be cracked or its seal is damaged and needs to be replaced.
- Ensure the spindle vent is in place and free from clogs. *OPS-SS-0007*



- Inspect blades and blade bolts for looseness and excessive wear. Make sure the mower is securely blocked up before crawling beneath. Replace damaged, worn, and missing blades as complete sets to maintain rotary balance.
- Ensure carrier hub nuts are tightened with the cotter pin inserted and spread.
- Inspect the condition of the deck skid shoes and the skid shoe attaching hardware. *OPS-R-0012*



OPERATION

7.3 Cutting Component Inspection

Inspect blade pan and blade assembly for the following:
OPS-U-0031

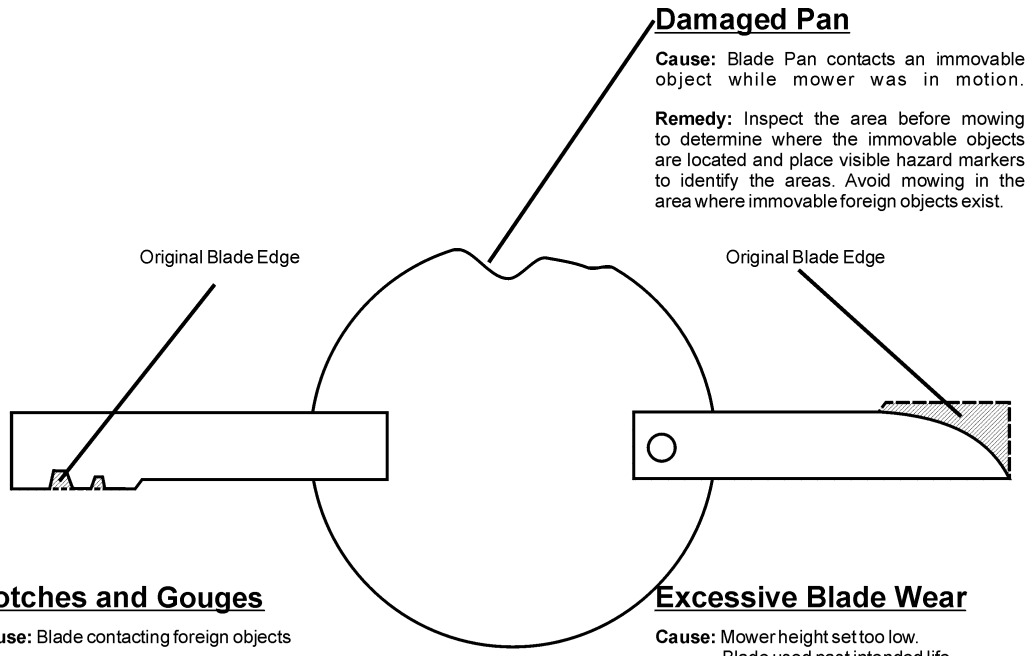

Damaged Pan

Cause: Blade Pan contacts an immovable object while mower was in motion.

Remedy: Inspect the area before mowing to determine where the immovable objects are located and place visible hazard markers to identify the areas. Avoid mowing in the area where immovable foreign objects exist.

Notches and Gouges

Cause: Blade contacting foreign objects

Remedy: Inspect the area to be mowed and remove foreign objects that could cause damage to the blades

Excessive Blade Wear

Cause: Mower height set too low.
Blade used past intended life.

Remedy: Replace blades more often.
Adjust mower height for mowing
Conditions to eliminate blade-to-ground contact

Op - 22



Inspect the Blades daily for abnormal wear. REPLACE BOTH BLADES on that carrier IMMEDIATELY if either blade has:

• Become bent or deformed from it's original shape or

- Any cracks are visible, or
- Deep gouges in the blade's surface are present, or
- Gouges or chipped areas in the cutting edge are larger than 1/2" (12.7mm), or
- The material on the leading edge has been worn away by more than 1/2" (12.7mm)"

Failure to replace abnormally worn blades may lead to catastrophic failure of the blades and ejection of the broken part with tremendous force which may cause serious bodily injury or death. OPS-U-0032

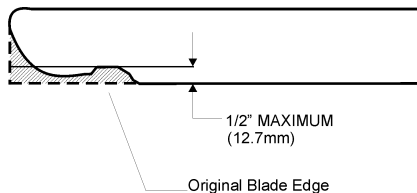

NOTE:
Replace Blades in pairs after no more than 1/2" (12.7mm) wear
Op - 23

OPERATION

OPERATION

7.4 Blade Bolt Inspection

Inspect Blade Bolt Head daily for wear as followed:

Excessive Blade Bolt Wear

Cause: Blade Bolt contacts a foreign or solid object while Blade is in motion.

Remedy: Inspect the area before mowing to determine where the foreign objects are located and place visible hazard markers to identify the areas where immovable foreign objects exist, and avoid hitting the objects

Notches and Gouges

Cause: Blade Bolt contacting foreign objects

Remedy: Inspect area to be mowed and remove foreign objects that could cause damage to the blade bolts.

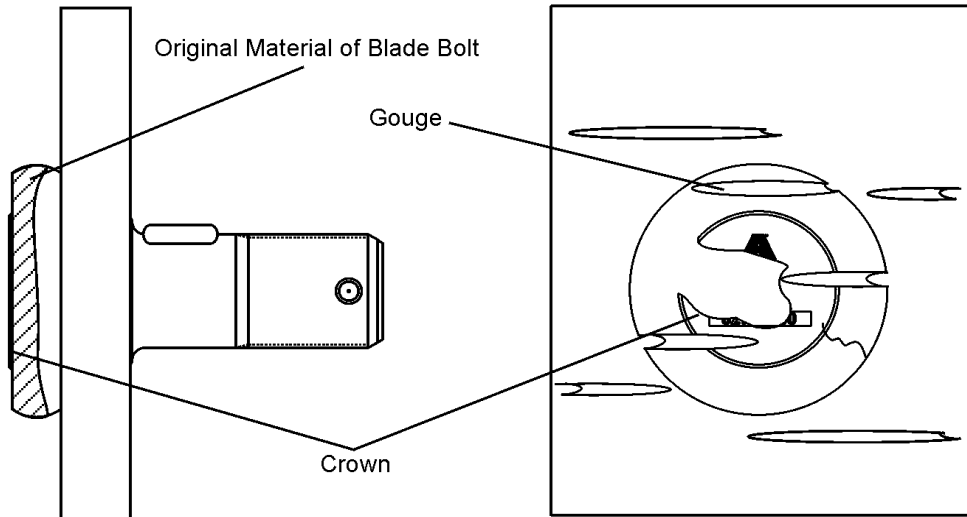

Inspect the Blade Bolt Heads daily for abnormal wear. REPLACE BOTH BLADE BOLTS on the Blades IMMEDIATELY if either blade bolts has:

- Visible cracks or
- If the blade bolt crown is worn off or
- If Blade Bolt has gouges or chipped areas.

Failure to replace abnormally worn blade bolts may lead to catastrophic failure of the blades and ejection of the broken part which may cause serious bodily injury or death.

Always replace Blade Bolts with new bolts whenever replacing the Blades. OPS-U-0037

OPERATION

Rotary Mower PRE-OPERATION Inspection



Mower ID# _____ Make _____

Date: _____ Shift _____



Before conducting the inspection, make sure the tractor engine is off, all rotation has stopped and the tractor is in park with the parking brake engaged. Make sure the mower is resting on the ground or securely blocked up and all hydraulic pressure has been relieved.

Item	Condition at Start of Shift	Specific Comments if not O.K.
The Operator's Manual is in the canister on the mower		
All safety decals are in place and legible		
The tongue/hitch connection bolts & pins are tight		
There are no cracks in tongue or hitch		
The tow chain is secured to the tractor & mower		
The hydraulic cylinders pins are tight		
There are no leaking or damaged hoses		
The mower deck is clear of cut grass and debris		
Chain guards/deflectors are in place & in good condition		
Driveline/gearbox shields are in good condition		
Driveline clutches are in good condition; not frozen		
Driveline telescoping members & U-joints are lubricated		
Driveline yokes are securely attached to PTO & mower		
Gearbox mounting bolts are tight		
Gearbox oil is at the proper level		
Blade carrier retaining nut is tight		
Blades are not chipped, cracked or bent		
Blade bolts are tight		
Wheel lug nuts are tight		
Transport locks are in good condition		

Operator's Signature: _____

DO NOT OPERATE an UNSAFE TRACTOR or MOWER

OPERATION

OPERATION

Tractor PRE-OPERATION Inspection



Mower ID# _____ Make _____

Date: _____ Shift _____



Before conducting the inspection, make sure the tractor engine is off, all rotation has stopped and the tractor is in park with the parking brake engaged. Make sure the mower is resting on the ground or securely blocked up and all hydraulic pressure has been relieved.

OPERATION

Item	Condition at Start of Shift	Specific Comments if not O.K.
The flashing lights function properly		
The SMV Sign is clean and visible		
The tires are in good condition with proper pressure		
The wheel lug bolts are tight		
The tractor brakes are in good condition		
The steering linkage is in good condition		
There are no visible oil leaks		
The hydraulic controls function properly		
The ROPS or ROBS Cab is in good condition		
The seatbelt is in place and in good condition		
The 3-point hitch is in good condition		
The drawbar pins are securely in place		
The PTO master shield is in place		
The engine oil level is full		
The brake fluid level is full		
The power steering fluid level is full		
The fuel level is adequate		
The engine coolant fluid level is full		
The radiator is free of debris		
The air filter is in good condition		

Operator's Signature: _____

DO NOT OPERATE an UNSAFE TRACTOR or MOWER

This Inspection Form may be freely duplicated for extra copies.

OPERATION

8. DRIVING THE SKID STEER AND MOWER

Safe skid steer transport requires the operator possess a thorough knowledge of the model being operated and precautions to take while driving with a front attachment. Ensure the skid steer has the capacity to handle the weight of the mower and the skid steer operating controls are set for safe transport. OPS-SS-0008



OPERATION



WARNING Transport only at safe speeds. Serious accidents and injuries can result from operating this equipment at unsafe speeds. Understand the Power Unit and Implement and how it handles before transporting on streets and highways. Make sure the Power Unit steering and brakes are in good condition and operate properly.

Before transporting the Power Unit and Implement, determine the safe transport speeds for you and the equipment. Make sure you abide by the following rules:

- Test the Power Unit at a slow speed and increase the speed slowly. Apply the Brakes smoothly to determine the stopping characteristics of the Power Unit and Implement. As you increase the speed of the Power Unit the stopping distance increases. Determine the maximum safe transport speed for you and this Equipment.
- Test the equipment at a slow speed in turns. Increase the speed through the turn only after you determine that it is safe to operate at a higher speed. Use extreme care and reduce your speed when turning sharply to prevent the tractor and implement from turning over. Determine the maximum safe turning speed for you and this equipment before operating on roads or uneven ground.
- Only transport the Power Unit and Implement at the speeds that you have determined are safe and which allow you to properly control the equipment.

Be aware of the operating conditions. Do not operate the Power Unit with weak or faulty brakes. When operating down a hill or on wet or rain slick roads, the braking distance increases: use extreme care and reduce your speed. When operating in traffic always use the Power Unit's flashing warning lights and reduce your speed. Be aware of traffic around you and watch out for the other guy. (SPU-21)

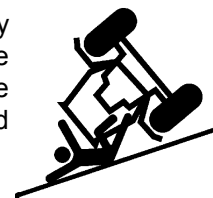

OPERATION

8.1 Starting the Skid Steer

Refer to the skid steer operator's manual for proper starting procedures. Consult an authorized dealer if the starting procedure is unclear. Make sure that the skid steer parking brake is set, its transmission is in neutral, the mower is lowered to the ground, and the auxiliary hydraulic remote lever is disengaged before starting the skid steer. Only start the skid steer when properly seated in the operator's seat with the seat belt securely fastened. OPS-SS-0026

8.2 Driving the Skid Steer

Start off driving at a slow speed and gradually increase your speed while maintaining complete control of the skid steer and mower. Do not operate the skid steer at speeds that cannot be safely handled or which will prevent stopping quickly during an emergency.

Do not raise or tilt the mower to a height that obstructs the operator's visibility to the front of the mower. The height limiting safety chain should stay connected to the mower and skid steer during transport to prevent the mower from being raised too high. OPS-SS-0027

9. OPERATING THE SKID STEER AND MOWER

THE OPERATOR MUST COMPLETELY UNDERSTAND HOW TO OPERATE THE SKID STEER AND MOWER AND ALL CONTROLS BEFORE ATTEMPTING TO MOW. The operator must read and understand the Safety and Operation Sections of the mower and skid steer operator's manuals. These manuals must be read and explained to any operator who cannot read. Never allow someone to operate the mower and skid steer without complete operating instructions.

Before starting any mowing operation, the operator must become familiar with the area to be mowed and any obstacles and hazards contained within to ensure safety to the operator, bystanders, and equipment. Special attention should be paid to foreign debris, rough terrain, steep slopes, and passersby and animals in the area. OPS-SS-0028

⚠ WARNING Extreme care should be taken when operating near loose objects such as gravel, rocks, wire, and other debris. Inspect the area before mowing. Foreign objects should be removed from the site to prevent machine damage and/or bodily injury or even death. Any objects that cannot be removed must be clearly marked and carefully avoided by the operator. Stop mowing immediately if blades strike a foreign object. Repair all damage and make certain rotor or blade carrier is balanced before resuming mowing. (SGM-5)



OPERATION

Perform turns with the skid steer and mower at slow speeds to determine how the skid steer handles a turn. Determine the safe speed to maintain proper control of the skid steer when making turns. When turning with an attached mower, the overall working length of the unit is increased. Allow additional clearance for the mower when making turns. OPS-SS-0009



To avoid overturns, drive the skid steer with care and at safe speeds, especially when operating over rough ground, crossing ditches or slopes, and turning corners. Use extreme caution when operating on steep slopes. Travel at a slow speed when going downhill. DO NOT coast or free-wheel downhill. When operating the tractor and mower across slopes and inclines, through ditches, and other uneven terrain conditions, it is important to maintain sufficient deck to ground clearance. Blade contact with the ground may cause soil, rocks and other debris to be thrown out from under the mower resulting in possible injury and/or property damage. Blades hitting the ground also produces a severe shock load on the mower and to the mower blades resulting in possible damage and premature wear.

WARNING

Many varied objects, such as wire, cable, rope, or chains, can become entangled in the operating parts of the mower head. These items could then swing outside the housing at greater velocities than the blades. Such a situation is extremely hazardous and could result in serious injury or even death. Inspect the cutting area for such objects before mowing. Remove any like object from the site. Never allow the cutting blades to contact such items. (SGM-6)

9.1 Foreign Debris Hazards

Before mowing, inspect the area to make sure there are no foreign objects that the mower blades could hit or become entangled with. Remove all foreign objects and debris. If objects are too big to remove, mark them clearly and be sure to prevent the mower blades from contacting them. OPS-SS-0010



OPERATION

If you hit a solid object or foreign debris, stop the mower and skid steer at once. Immediately idle the engine speed and disengage the auxiliary hydraulics to stop the mower blades from turning. Wait for all mower rotating motion to stop, then raise the mower and move the skid steer and implement off the object. Inspect the area and remove, or mark the location of the debris. Inspect the condition of the mower and make any needed repairs immediately. Make sure the blades are not damaged and the carrier is balanced before resuming operation.

9.2 Bystander/Passersby Precautions

If a bystander comes within 100 yards of the skid steer while the mower is being operated, stop the skid steer at once, idle the engine and stop the mower. Do not engage the mower again until all bystanders are well past the 100 yard distance. OPS-SS-0029



Rotary Mowers are capable under adverse conditions of throwing objects for great distances (300 feet or more) and causing serious injury or death. Follow safety messages carefully.



STOP MOWING IF PASSERSBY ARE WITHIN 100 YARDS UNLESS:

- Front and Rear Deflectors, Chain Guards, or Bands are installed and in good, workable condition;
- Mower sections or Wings are running close to and parallel to the ground without exposed Blades;
- Passersby are outside the existing thrown-object zone;
- All areas have been thoroughly inspected and all foreign material such as rocks, cans, glass, and general debris has been removed.

NOTE: *Where there are grass and weeds high enough to hide debris that could be struck by the blades, the area should be: inspected and large debris removed, mowed at an intermediate height, inspected, closely with any remaining debris being removed, and mowed again at desired final height. (This will also reduce power required to mow, reduce wear and tear on the Mower drivetrain, spread cut material better, reduce streaking, and make the final cut more uniform).* (SRM-1)

9.3 Engaging the Mower

Before engaging the mower, make certain that the area is clear of bystanders and passersby. Refer to the skid steer operator's manual to determine the procedure to engage the front auxiliary hydraulics. If you here unusual noises or feel abnormal vibrations, disengage the mower immediately. Inspect the mower to determine the cause of the noise or vibration and repair the problem immediately. OPS-SS-0030

OPERATION



Use extreme caution when raising the Mower above ground level. Stop the Blades from turning when the Mower is raised and passersby are within 100 yards. Raising the Mower exposes the Cutting Blades which creates a potentially serious hazard and can cause serious injury by objects thrown from the Blades or by contact with the Blades. (SPU-1)



Do not put hands or feet under mower decks. Blade Contact can result in serious injury or even death. Stay away until all motion has stopped and the decks are securely blocked up. (SGM-9)



OPERATION

9.4 Operating Speed and Ground Speed

Ground speed for mowing will depend upon the height, type, and density of vegetation to be cut. Recommended speed for efficient mower performance is between 2 and 5 mph. Operate the mower at its full rated speed to maintain blade speed for a clean cut. Refer to the skid steer operator's manual and its instrument panel for the engine speed required to provide the rated operating speed. Make sure that the mower is operating at its full rated speed before entering the vegetation to be cut. If it becomes necessary to temporarily regulate engine speed, increase or decrease the throttle gradually.

Ground speed is achieved by transmission speed and not by the engine speed. The operator may be required to experiment to determine the best travel speed which provides the best performance from the mower and most efficient skid steer operation. As the severity of cutting conditions increase, the ground speed should be decreased while maintaining the rated mower operating speed. OPS-SS-0012



The Mower shaft speed must not - **UNDER ANY CIRCUMSTANCES** - exceed 1150 RPM. (SPU-7)



Mow at the speed that you can safely operate and control the Power Unit and Mower. Safe mowing speed depends on terrain condition and grass type, density, and height of cut. Normal ground speed range is from 0 to 5 mph. Use slow mowing speeds when operating on or near steep slopes, ditches, drop-offs, overhead obstructions, power lines, or when debris and foreign objects are to be avoided. (SPU-29)

OPERATION

9.5 Operating the Mower

Only operate the mower from the skid steer operator's seat with the seatbelt securely fastened.

The mower is designed to cut vegetation up to 2" in diameter. Sharp blades will produce a cleaner cut and require less power. Travel at a speed that allows the mower sufficient time to cut through the vegetation and maintain the mower operating speed to prevent overloading the mower and skid steer. Choose a driving pattern that provides the maximum pass length and minimizes turning.

Avoid mowing in the reverse direction when possible. In situations where the mower must be backed to access areas to be cut, make sure there are no persons or other foreign debris behind the mower before mowing in reverse. When mowing in reverse, operate the skid steer and mower at a reduced ground speed to ensure skid steer and mower control is maintained. OPS-SS-0013



WARNING Mow only in conditions where you have clear visibility in daylight or with adequate artificial lighting. Never mow in darkness or foggy conditions where you cannot clearly see at least 100 yards in front and to the sides of the Power Unit and mower. Make sure that you can clearly see and identify passersby, steep slopes, ditches, drop-offs, overhead obstructions, power lines, debris and foreign objects. If you are unable to clearly see these types of items discontinue mowing. (SPU-27)



WARNING Never mow in the reverse direction. The Power Unit's operator protective structure obstructs the operator's visibility of the unit's path when traveling in the reverse direction. (SPU-8)

Stay alert and watch for trees, low hanging limbs, power lines, and other overhead obstacles and solid ground objects while you are operating. Use care to avoid hitting these items.

Large, dense, or wet vegetation may need to be mowed in two or more passes to achieve a uniform cut. In such conditions, raise the cutting height up to 18" on the first pass.

Then lower the mower to the desired height and mow the vegetation a second time. If possible, select a mowing pattern that is at a 90 degree angle to the first pass to reduce streaking and provide a more even cut.

9.6 Shutting Down the Mower

To shut down the mower, first bring the skid steer to a complete stop. Then slow down the mower by reducing the engine speed before disengaging the auxiliary hydraulics.

Park the skid steer on a level surface, place the transmission in park or neutral and apply the parking brake, lower the attached mower to the ground, shut down the engine, remove the key, and wait for all motion to come to a complete stop before exiting the skid steer. OPS-SS-0031

OPERATION

10. DISCONNECTING THE MOWER FROM THE SKID STEER



Always shut the Power Unit completely down, place the transmission in park, and set the parking brake before you or anyone else attempts to connect or disconnect the Implement and Power Unit hitches. (SPU-32)

Before disconnecting the mower, the auxiliary hydraulics must be disengaged and blade rotation at a complete stop. Lower the mower to the ground. If the mower is not resting securely on the ground, block the mower up securely before attempting to disconnect it from the skid steer hitch.

- Completely shut down the mower and skid steer and secure the skid steer in position by applying the parking brake. Wait for all movement to come to a complete stop before exiting the skid steer. Never extend any part of your body from the operator's area to operate latches or to disconnect hydraulic lines or the height limiting safety chain.
- Disconnect the mower hydraulic lines from the skid steer auxiliary hydraulic ports. Connect mower couplers together to prevent hydraulic line contamination.
- Remove the height limiting safety chain from the front of the skid steer chassis.
- Pull the latching handles upward to release the latch pins from the mower hitch tabs.
- Board the skid steer, fasten your seatbelt, and start the engine. Tilt the mounting plate forward and back away from the mower at the same time. The mower should be released from the skid steer at this point. OPS-SS-0014



OPERATION

OPERATION

11. MOWER STORAGE

Properly preparing and storing the mower at the end of the season is critical to maintaining its appearance and to help ensure years of dependable service. The following are suggested storage procedures:

1. Thoroughly clean all debris off the mower to prevent damage from rotting grass and standing water.
2. Lubricate all mower grease points and fill spindle oil level as detailed in the maintenance section.
3. Tighten all bolts and pins to the recommended torque.
4. Check the mower for worn and damaged parts. Perform repairs and make replacements immediately so that the mower will be ready for use at the start of the next season.
5. Store the mower in a clean, dry place with the mower housing resting securely on blocks or at ground level.
6. Keep the hydraulic hose ends from sitting in water, dirt and other contaminants. Connect the mower's hydraulic lines together to prevent dirt and other contamination from entering the hydraulic system.
7. Use spray touch-up enamel where necessary to prevent rust and to maintain the appearance of the mower.



Never allow children to play on or around Power Unit or Implement. Children can slip or fall off the Equipment and be injured or killed. Children can cause the Implement to shift or fall crushing themselves or others. (SPU-24)

12. TRANSPORTING THE SKID STEER AND MOWER

Inherent dangers of operating the skid steer and mower and the possibility of accidents are not left behind when you finish mowing an area. One must also use good judgement and safe operation practices when transporting the skid steer and mower between locations. By using good judgement and following safe transport procedures, the possibility of accidents while moving between locations can be substantially minimized. OPS-SS-0032

OPERATION



Never allow children or other persons to ride on the Power Unit or Implement. Falling off can result in serious injury or death. (SPU-16)



Before transporting the skid steer and mower, idle the skid steer engine, disengage the auxiliary hydraulics and wait for all mower moving parts to come to a complete stop. When transporting, only raise the deck enough to clear ground obstacles. Never raise the mower to a height that impairs the operator's vision to the front of the mower.

12.1 Transporting on Public Roadways



Never allow children or other persons to ride on the Power Unit or Implement. Falling off can result in serious injury or death. (SPU-16)



Make certain that the "Slow Moving Vehicle" (SMV) sign is installed in such a way as to be clearly visible and legible. When transporting the Equipment use the Power Unit flashing warning lights and follow all local traffic regulations. (SPU-13)

Check with your local department of transportation to determine if it is legal to drive a skid steer on a public roadway. Extreme caution should be used when transporting the skid steer and mower on public roadways. The skid steer must be equipped with all required safety warning features including a SMV emblem and flashing warning lights to alert drivers of the skid steer's presence. Remember that roadways are primarily designed for automotive drivers and most drivers will not be looking out for you, therefore, you must look out for them. Check your side view mirrors frequently and remember that vehicles will approach quickly because of the skid steer's slower speed. Be extremely cautious when the piece of equipment that you are towing is wider than the skid steer tire width and/or extends beyond your lane of the road.

When operating on public roads, have consideration for other road users. Pull to the side of the road occasionally to allow all following traffic to pass. Do not exceed the legal speed limit set in your country for agricultural and industrial type equipment. Always stay alert when transporting the skid steer and mower on public roads. Use caution and reduce speed if other vehicles or pedestrians are in the area.

OPERATION

OPERATION

12.2 Hauling the Skid Steer and Mower

Before transporting a loaded skid steer and mower, measure the height and width dimensions and gross weight of the complete loaded unit. Ensure that the load will be in compliance with the legal limits set for the areas that will be traveled through.

Use adequately sized and rated trailers and equipment to transport the skid steer and mower. Consult an authorized dealer to determine the proper equipment required. Using adequately sized chains, heavy duty straps, cables and/or binders, securely tie down both the front and rear of the skid steer utilizing the proper tie down locations as specified by the skid steer manufacturer.

Arrange the chains so that when tightened, the chains are pulling downward and against themselves. Carefully tighten the securing chains or other fasteners used as much as possible using boomers or binders to apply maximum tension. Use extreme care when attaching and removing the securing devices as the extreme tension involved when released has the potential to inflict serious injury.

While hauling the skid steer and mower, make occasional stops to check that the skid steer and mower have not moved or shifted and that the securing chains have maintained tension. If during transport a hard braking, sharp turning, or swerving action was performed, stop at the next safe location to inspect the security of the load. OPS-SS-0015



OPERATION

13. TROUBLESHOOTING GUIDE

TROUBLE	POSSIBLE CAUSE	POSSIBLE REMEDY
Excessive Vibration	1. Check for loose nuts on bladeholder and blades.	Tighten if loose.
	2. Check to see if blades are free swinging.	Free Blades so they swing.
	3. Check for even wear on each blade tip. Were both blades changed at the same time?	Weigh Blades. Weight should be within 1 oz. Always replace both blades.
	4. Blade broken.	Replace blades, in set.
	5. Blade carrier bent.	Replace carrier.
	6. Blade hub not properly	Remove hub, check tapered shaft, clean and replace.
	7. New blade or bolts matched with worn blade or bolts.	Replace blades or bolts in sets.
Not Cutting Clean	1. Blades dull.	Sharpen or replace blades.
	2. Carrier RPM too low.	Hydraulic flow of mower motor power unit output are not compatible. See operation section of mower and skid steer for hydraulic specifications
	3. Ground speed too fast.	Reduce ground speed by shifting to a lower gear.
	4. Blades locked back.	Free blades.
	5. Blades riding up due to blade bolt wear or loose bolts.	Replace blade bolts.
Streaking Conditions	1. Conditions too wet for cutting.	Allow grass to dry before cutting. Slow ground speed of tractor but keep engine running at full PTO rpm. Cutting lower may help.
	2. Dull blades.	Sharpen or replace blades.
	3. Height of cutter lower at rear or front.	See Cutting Height Instructions.

OPERATION

OPERATION

TROUBLE	POSSIBLE CAUSE	POSSIBLE REMEDY
Blade Bolts	<ol style="list-style-type: none">1. Bolts not tightened.2. Bolt hole elongated or oversized.3. Locknut worn out.	Tighten bolts to 250 ft.lbs. Replace Bushing or Blade Carrier. Replace Locknut.
Blades Wears Too Fast	<ol style="list-style-type: none">1. Cutting in sandy conditions.2. Cutting in rocky conditions.	Increase cutting height. Increase cutting height.
Blade Carrier Won't Turn	<ol style="list-style-type: none">1. Pressure applied to wrong side of motor.	Reverse flow direction.
Blade carrier turns wrong direction	<ol style="list-style-type: none">1. Check valve installed on wrong side of motor	Move check valve to opposite side of motor

MAINTENANCE SECTION

Maintenance Section 5-1

MAINTENANCE

Before operating the mower, make sure it is properly lubricated and thoroughly inspected. Only a minimum of time and effort is required to regularly lubricate and maintain this machine to provide long life and trouble free operation.

LUBRICATION INFORMATION

Do not let excess grease collect on or around parts, particularly when operating in sandy areas. The accompanying illustration shows lubrication parts. The chart gives the frequency of lubrication in hours, based on normal operating conditions. Severe or unusual conditions may require more frequent lubrication.

LUBRICATION SCHEDULE

The mower must be serviced daily to achieve the best operation and longest life. Good quality grease from a hand grease gun in all grease fittings should be sufficient.

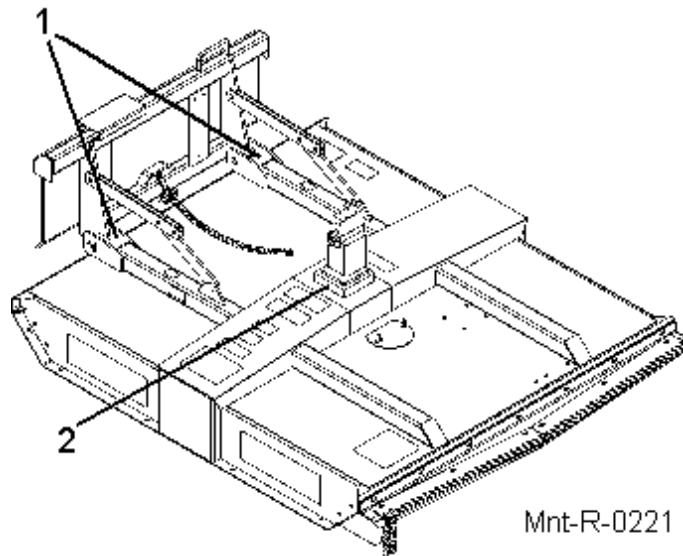

ITEM	DESCRIPTION	FREQUENCY
1	Hitch Pivot	8 hours
2	Spindle	Check oil level every 8hours, fill to check plug level as needed.

MAINTENANCE

SPINDLE LUBRICATION

To check the grease level in the spindle, place the mower head on a flat level surface. Remove the filler plug, the oil should be level with the bottom of the oil level check plug and should not require additional lubricant unless the spindle is cracked or a seal is leaking. If required, oil should be added until it runs out hole. Recommended lubricant is NLGI 000 Grease, Alamo Industrial P/N 00769030, Mobil 000 EP023, or equivalent.

Note: Make sure that the mower is level when checking oil level in the spindle.

Note: Do Not overfill the spindle. Overfilling will cause pressure to build up and cause seals to leak.



SPINDLE FILLER/CHECK PLUG

HYDRAULIC LINES, COUPLERS, & ADAPTERS

Keep all hoses and adapters tight. Repair any leaks immediately. Do not overtighten hose end fittings. Tighten to specifications only. (See Chart Below)

RECOMMENDED HOSE END TORQUE VALUES FOR 37 DEGREE ANGLE STEEL HOSE END FITTINGS

DASH SIZE	NOMINAL SIZE (IN.)	TORQUE (IN.LBS.)	VALUE* (FT.LBS.)
-4	1/4	140	12
-6	3/8	230	19
-8	1/2	450	38
-10	5/8	650	54
-12	3/4	900	75
-16	1	1200	100
-20	1-1/4	1600	133
-24	1-1/2	2000	167
-32	2	2800	233

* Straight threads do not always seal better when higher torques are used. Too much torque causes distortion and may lead to leakage.

Mnt-R-0222

MAINTENANCE

BLADE SERVICING

Inspect blades before each use to determine that they are properly installed and in good condition. Replace any blade that is bent, excessively nicked, worn, or has any other damage. Small nicks can be ground out when sharpening.

Important

When sharpening blades, grind each blade the same amount to maintain balance. The difference in blade weights should not exceed 1 ounce. Unbalanced blades will cause excessive vibration which can damage spindle bearings. Vibration may also cause structural cracks in the mower.

WARNING

Use only original equipment blades on this mower. They are made of special heat-treated alloy steel. Substitute blades may not meet specifications and may fail in a hazardous manner that could cause injury.

BLADE SHARPENING

DANGER

Replace bent or broken blades with new blades. NEVER ATTEMPT TO STRAIGHTEN, WELD, OR WELD HARDFACING ON BLADES SINCE THIS WILL LIKELY CRACK OR OTHERWISE DAMAGE THE BLADE WITH SUBSEQUENT FAILURE AND POSSIBLE SERIOUS INJURY FROM THROWN BLADES. (SGM-10)

Always sharpen both blades at same time to maintain balance. Follow original sharpening pattern as shown in **Image 4**. Always sharpen blades by grinding. DO NOT heat and pound out edge. Do not sharpen blade to a razor edge, but leave a 1/16" blunt edge. Do not sharpen back side of blade.

WARNING

Avoid personal injury. Always block the mower up to prevent it from falling when the blades and/or carrier are being serviced.

WARNING

Avoid personal injury. Always wear safety glasses and face protection when grinding blades.

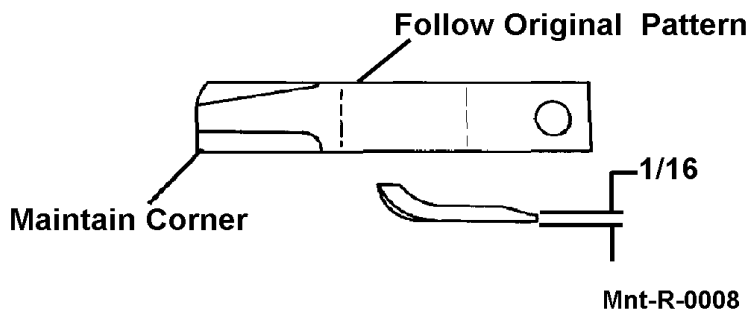

IMAGE 4. Blade Maintenance

MAINTENANCE

BLADE REMOVAL

To remove blades for sharpening or replacement, remove the cover plate on deck of mower near Hydraulic Motor. Remove lock nut from blade bolt.

NOTE: *Inspect lock nut after removal and replace if threads are damaged.* Always replace nut when replacing blade bolt. When installing blades be sure and check blade bolt pivot diameter for wear. Replace bolt if worn more than 1/4 inch at any point. See Image. Tighten lock nut to 250 ft. lbs.

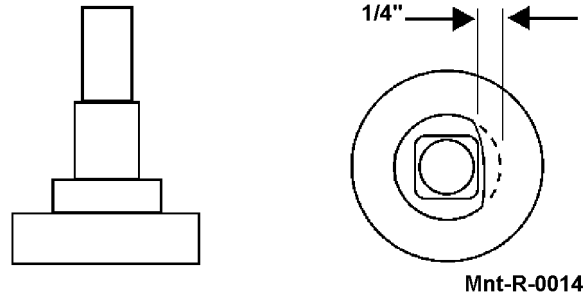

Maximum Bolt Wear



Avoid personal injury. Blade and/or blade carrier removal should be done only with the power unit engine shut off, key removed, in park, parking brake on, the auxiliary hydraulics are disengaged, and the mower securely blocked up.

BLADE CARRIER REMOVAL

Remove cotter pin and loosen slotted nut on spindle shaft. Loosen but do not remove the nut until the blade carrier is loosened. Use a suitable 2 jaw gear puller to pull carrier off tapered spindle shaft. If gear puller is not available use long bar inserted through blade bolt access hole with end against rotor bar. Strike opposite end of bar with sledge hammer. Rotate blade carrier 180 degrees and repeat process.

BLADE CARRIER INSTALLATION

Clean the bore on blade carrier and surface of output shaft. Position carrier on the gearbox output shaft and install washer and slotted nut.

Tighten nut holding blade carrier to minimum 400 ft. pounds, strike the carrier near the hub several times with a heavy hammer to seat the hub. Use a suitable spacer over the nut to prevent damage to the nut and threads. Retighten the nut to 400 ft. pounds. Install cotter pin and spread.

Important

Always recheck spindle output shaft slotted blade carrier retaining nut torque after a few hours operation.



Never work under the Implement, the framework, or any lifted component unless the Implement is securely supported or blocked up to prevent sudden or inadvertent falling which could cause serious injury or even death. (SG-14)



MAINTENANCE

STORAGE

Your mower represents an investment from which you should get the greatest possible benefit. Therefore, when the season is over, the mower should be thoroughly checked and prepared for storage so that a minimum amount of work will be required to put it back into operation for the next season. The following are suggested storage procedures:

1. Thoroughly clean the mower.
2. Lubricate the cutter as covered in Maintenance Section.
3. Tighten all bolts and pins to the recommended torque.
4. Check the mower for worn or damaged parts. Make replacements immediately.
5. Store the mower in a clean, dry place with the mower head resting on blocks.
6. Use spray touch-up enamel where necessary to prevent rust and maintain the appearance of the mower.



PROPER TORQUE FOR FASTENERS

The chart lists the correct tightening torque for fasteners. When bolts are to be tightened or replaced, refer to this chart to determine the grade of bolts and the proper torque except when specific torque values are assigned in manual text.





RECOMMENDED TORQUE IN FOOT POUNDS UNLESS OTHERWISE STATED IN THE MANUAL *

NOTE: These values apply to fasteners as received from supplier, dry or when lubricated with normal engine oil. They do not apply if special graphited or molydisulphide greases or other extreme pressure lubricants are used. This applies to both UNF fine and UNC coarse threads.

Proper Torque values for bolts that are measured in Inches

Bolt Diameter			
	Head Marking No Marks Grade Two Pound - Foot Value Dry	Head Marking Three Lines Grade Five Pound - Foot Value Dry	Head Marking Six Lines Grade Eight Pound - Foot Value Dry
1/4"	5.5	9	12.5
5/16"	11	18	26
3/8"	20	33	46
7/16"	32	52	75
1/2"	60	80	115
9/16"	70	115	160
5/8"	100	160	225
3/4"	175	280	400
7/8"	175	450	650
1"	270	675	975
1-1/8"	375	850	1350
1-1/4"	530	1200	1950
1-3/8"	700	1550	2550
1-1/2"	930	2100	3350

Proper Torque values for Metric bolts

Bolt Diameter				
	Head Marking 4.8 Pound - Foot Value Dry	Head Marking 8.8 or 9.8 Pound - Foot Value Dry	Head Marking 10.9 Pound - Foot Value Dry	Head Marking 12.9 Pound - Foot Value Dry
6mm	4.5	8.5	12	14.5
8mm	11	20	30	36
10mm	21	40	60	70
12mm	37	70	105	120
14mm	60	110	165	190
16mm	92	175	255	300
18mm	125	250	350	410
20mm	180	350	500	580
22mm	250	475	675	800
24mm	310	600	850	1000
27mm	450	875	1250	1500
30mm	625	1200	1700	2000

*To get Newton-Meters multiply pound-foot of torque by 1.356

ALAMO-INDUSTRIAL LIMITED WARRANTY

1. LIMITED WARRANTIES

- 1.01. Alamo Industrial warrants for one year from the purchase date to the original non-commercial, governmental, or municipal purchaser ("Purchaser") and warrants for six months to the original commercial or industrial purchaser
- 1.02. Manufacturer will replace for the Purchaser any part or parts found, upon examination at one of its factories, to be defective under normal use and service due to defects in material or workmanship.
- 1.03. This limited warranty does not apply to any part of the goods which has been subjected to improper or abnormal use, negligence, alteration, modification, or accident, damaged due to lack of maintenance or use of wrong fuel, oil, or lubricants, or which has served its normal life. This limited warranty does not apply to any part of any internal combustion engine, or expendable items such as blades, shields, guards, or pneumatic tires except as specifically found
- 1.04. Except as provided herein, no employee, agent, Dealer, or other person is authorized to give any warranties of any nature on behalf of Manufacturer.

2. REMEDIES AND PROCEDURES.

- 2.01. This limited warranty is not effective unless the Purchaser returns the Registration and Warranty Form to Manufacturer within 30 days of purchase.
- 2.02. Purchaser claims must be made in writing to the Authorized Dealer ("Dealer") from whom Purchaser purchased the goods or an approved Authorized Dealer ("Dealer") within 30 days after Purchaser learns of the facts on which the claim is based.
- 2.03. Purchaser is responsible for returning the goods in question to the Dealer.
- 2.04. If after examining the goods and/or parts in question, Manufacturer finds them to be defective under normal use and service due to defects in material or workmanship, Manufacturer will:
 - (a) Repair or replace the defective goods or part(s) or
 - (b) Reimburse Purchaser for the cost of the part(s) and reasonable labor charges (as determined by Manufacturer) if Purchaser paid for the repair and/or replacement prior to the final determination of applicability of the warranty by Manufacturer.

The choice of remedy shall belong to Manufacturer.

- 2.05. Purchaser is responsible for any labor charges exceeding a reasonable amount as determined by Manufacturer and for returning the goods to the Dealer, whether or not the claim is approved. Purchaser is responsible for the transportation cost for the goods or part(s) from the Dealer to the designated factory.

3. LIMITATION OF LIABILITY.

- 3.01. MANUFACTURER DISCLAIMS ANY EXPRESS (EXCEPT AS SET FORTH HEREIN) AND IMPLIED WARRANTIES WITH RESPECT TO THE GOODS INCLUDING, BUT NOT LIMITED TO, MERCHANTABILITY AND FITNESS FOR A PARTICULAR PURPOSE.
- 3.02. MANUFACTURER MAKES NO WARRANTY AS TO THE DESIGN, CAPABILITY, CAPACITY, OR SUITABILITY FOR USE OF THE GOODS.
- 3.03. EXCEPT AS PROVIDED HEREIN, MANUFACTURER SHALL HAVE NO LIABILITY OR RESPONSIBILITY TO PURCHASER OR ANY OTHER PERSON OR ENTITY WITH RESPECT TO ANY LIABILITY, LOSS, OR DAMAGE CAUSED OR ALLEGED TO BE CAUSED DIRECTLY OR INDIRECTLY BY THE GOODS INCLUDING, BUT NOT LIMITED TO, ANY INDIRECT, SPECIAL, CONSEQUENTIAL, OR INCIDENTAL DAMAGES RESULTING FROM THE USE OR OPERATION OF THE GOODS OR ANY BREACH OF THIS WARRANTY. NOT WITHSTANDING THE ABOVE LIMITATIONS AND WARRANTIES, MANUFACTURER'S LIABILITY HEREUNDER FOR DAMAGES INCURRED BY PURCHASER OR OTHERS SHALL NOT EXCEED THE PRICE OF THE GOODS.
- 3.04. NO ACTION ARISING OUT OF ANY CLAIMED BREACH OF THIS WARRANTY OR TRANSACTIONS UNDER THIS WARRANTY MAY BE BROUGHT MORE THAN TWO (2) YEARS AFTER THE CAUSE OF ACTION HAS OCCURRED.

4. MISCELLANEOUS.

- 4.01. Proper Venue for any lawsuits arising from or related to this limited warranty shall be only in Guadalupe County, Texas.
- 4.02. Manufacturer may waive compliance with any of the terms of this limited warranty, but no waiver of any terms shall be deemed to be a waiver of any other term.
- 4.03. If any provision of this limited warranty shall violate any applicable law and is held to be unenforceable, then the invalidity of such provision shall not invalidate any other provisions herein.
- 4.04. Applicable law may provide rights and benefits to purchaser in addition to those provided herein.

KEEP FOR YOUR RECORDS

ATTENTION: Purchaser should fill in the blanks below for his reference when buying repair parts and/or for proper machine identification when applying for warranty.

Alamo Industrial Implement Model _____

Serial Number _____

Date Purchased _____

Dealer _____

ATTENTION: _____

READ YOUR OPERATOR'S MANUAL

ALAMO INDUSTRIAL
An Alamo Group Company
Post Office Drawer 549
Seguin, Texas 78156
830-379-1480

HC-0002





TO THE OWNER/OPERATOR/DEALER

To keep your implement running efficiently and safely, read your manual thoroughly and follow these directions and the Safety Messages in this Manual. The Table of Contents clearly identifies each section where you can easily find the information you need.

The OCCUPATIONAL SAFETY AND HEALTH ACT (1928.51 Subpart C) makes these minimum safety requirements of tractor operators:

REQUIRED OF THE OWNER:

1. Provide a Roll-Over-Protective Structure that meets the requirements of this Standard; and
2. Provide Seatbelts that meet the requirements of this paragraph of this Standard and SAE J4C; and
3. Ensure that each employee uses such Seatbelt while the tractor is moving; and
4. Ensure that each employee tightens the Seatbelt sufficiently to confine the employee to the protected area provided by the ROPS.

REQUIRED OF THE OPERATOR

1. Securely fasten seatbelt if the tractor has a ROPS.
2. Where possible, avoid operating the tractor near ditches, embankments, and holes.
3. Reduce speed when turning, crossing slopes, and on rough, slick, or muddy surfaces.
4. Stay off slopes too steep for safe operation.
5. Watch where you are going - especially at row ends, on roads, and around trees.
6. Do not permit others to ride.
7. Operate the tractor smoothly - no jerky turns, starts, or stops.
8. Hitch only to the drawbar and hitch points recommended by the tractor manufacturer.
9. When the tractor is stopped, set brakes securely and use park lock, if available.

- Keep children away from danger all day, every day...
- Equip tractors with rollover protection (ROPS) and keep all machinery guards in place...
- Please work, drive, play and live each day with care and concern for your safety and that of your family and fellow citizens.



BC-0001