



ArchiTech™ by Networx™

FOR MORTISE LOCKS USING SURFACE-MOUNTED NETWORKX CONTROL UNITS MOUNTING AND INSTALLATION INSTRUCTIONS

© NAPCO Security Technologies, Inc. 2015

WI2090A 05/15

DESCRIPTION

These instructions detail the hardware installation procedure for the ArchiTech **mortise door locks** using the **Surface-Mounted Networkx Control Units** for hollow metal and solid wood doors.

Installation instructions for the **Door Contact Sensor**, **Door Contact Magnet** (installed in the door jamb) and the **Oval** and **Rectangular Proximity Readers** are also included.

PARTS OVERVIEW

For reference, the images in Fig. A below display each component (not to scale). In addition to the various screws included with your mortise lock, please be aware that two types of **Proximity Readers** are available (either **Oval** or **Rectangular**) but only one type is included with your lock. Furthermore, one of two types of **Door Contact Magnets** (installed in door jamb) are included (either 3/8" or 3/4" diameter). We recommend taking the time to read through these instructions, find and familiarize yourself with each component before you begin your installation.

As detailed in the instructions that follow, the **Proximity Reader** wire, the **Door Contact Sensor** wire and the **Mortise Lock Motor Wire** are routed through the door and are plugged into the **Surface-Mounted Networkx Control Unit**. The **Mortise Lock Motor Wire** can easily be routed within hollow metal doors. For solid wood doors, a **Mortise Drill Jig** (part #N9511DJ) **must** be used to drill a hole pathway within the solid wood door to route the **Mortise Lock Motor Wire**.

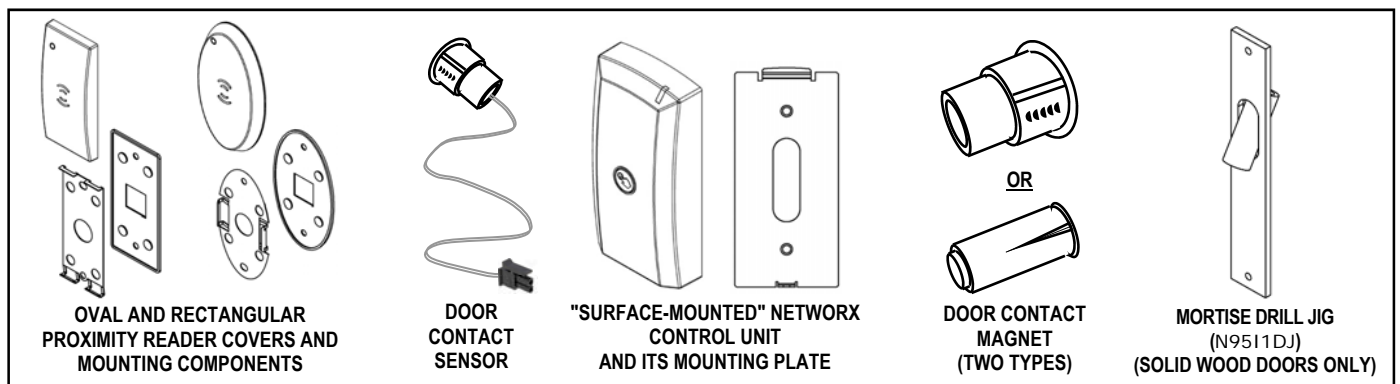

FIG. A: OVERVIEW OF BASIC PARTS (NOT TO SCALE)

REQUIRED TOOLS

In addition to the standard door prep kit tools used to install a mortise lock into a metal or wood door (Phillips and flat head screwdrivers, etc.), you will need: A small **level**, and the following drill bit sizes: **5/8"**, **3/8"**, **3/4"** and **7/64"**.

DOOR PREP: INITIAL STEPS

1. INSPECT THE DOOR BEVEL

Inspect the door for a bevel and, if beveled, determine which side is "longer" in width and which side is "shorter" in width (see "top view" example in Fig. 1). For beveled doors, be sure to use the correct marks printed on the template for the correct length of the outside door surface (either the "long" or "short" side of the door).

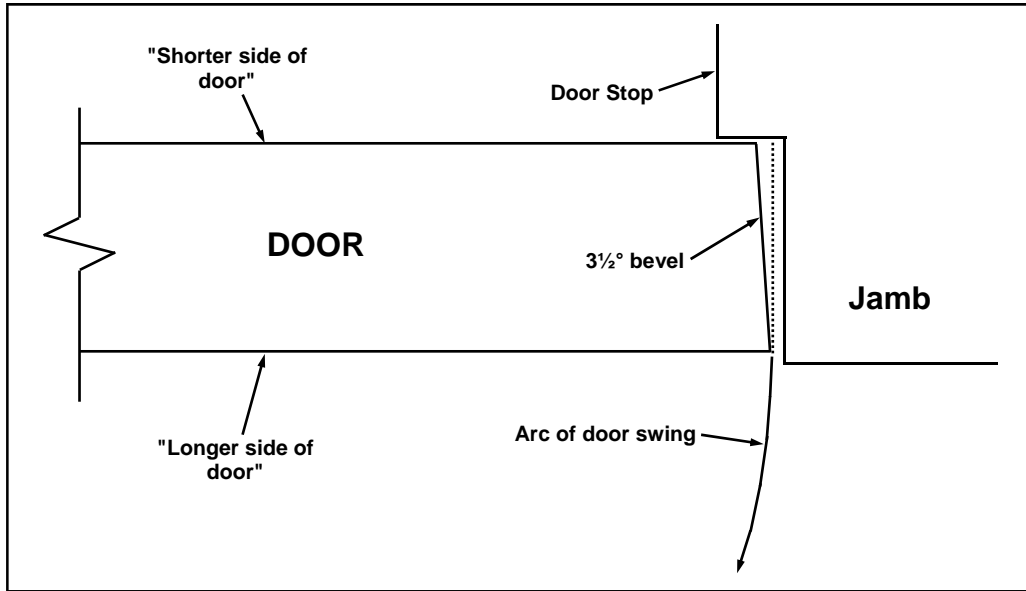

FIG. 1: EXAMPLE OF BEVELED DOOR (TOP VIEW)

2. PREP DOOR FOR MORTISE LOCK

If not done already, use standard door prep kit tools and the instructions included with the mortise lock to prep the door and door jamb as required. These include mortising the door edge for the latch plate and mortising the door jamb for the strike plate.

Do not install the lock hardware yet.

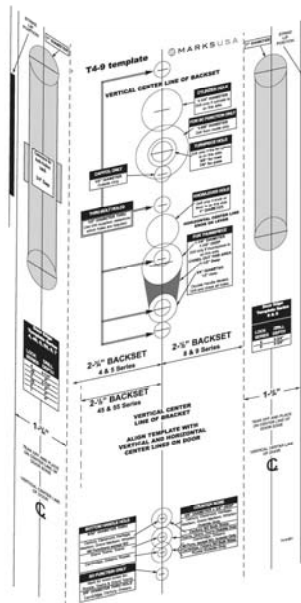

FIG. 2: USE TEMPLATE PROVIDED

3. TAPE ON DOOR: "PROXIMITY READER" TEMPLATE (WI2102)

Remember, the **Proximity Reader** is always located on the outside ("unprotected" side) door surface.

Fold and place the template (WI2102) on the **outside door edge** (see arrow in Fig. 3 for an example). Align the template with the "**HORIZONTAL CENTER LINE OF LEVER**" as shown on the template. Tape the template in place.

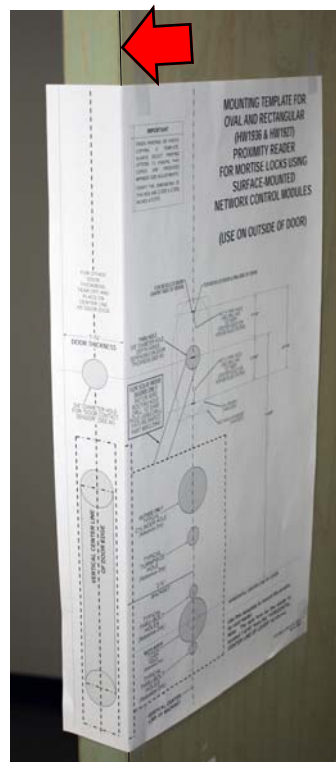

FIG. 3: EXAMPLE OF OUTSIDE DOOR EDGE (ARROW)

4. MARK TEMPLATE "PROXIMITY READER" HOLES

On the outside door surface, mark the two holes for the **Proximity Reader** mounting screws.

Mark the center of the **5/8" Diameter Thru-Hole** (used for the **Mortise Lock Motor Wire, Proximity Reader and Door Contact Sensor** wires). Do NOT remove the template yet.

TIP: Take special notice of this **5/8" Diameter Thru-Hole**, as it is an essential hole for this installation and is referenced several times throughout these instructions.

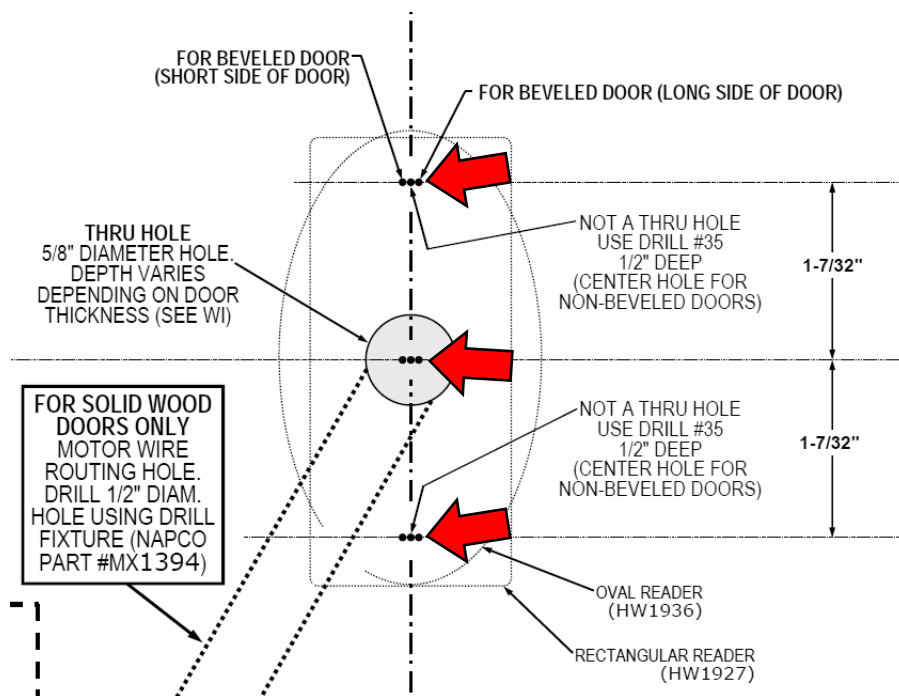

FIG. 4. EXAMPLE CLOSE UP OF WI2102 TEMPLATE FOR THE "PROXIMITY READER"

5. MARK TEMPLATE "DOOR CONTACT SENSOR" HOLE

Mark the 3/4" **Door Contact Sensor** hole in the center edge of the door (adjust for the door thickness). Carefully remove the template.

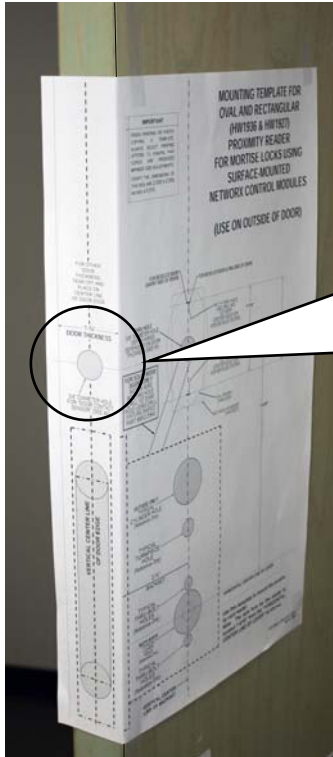

FIG. 5: DOOR CONTACT SENSOR HOLE ON DOOR EDGE

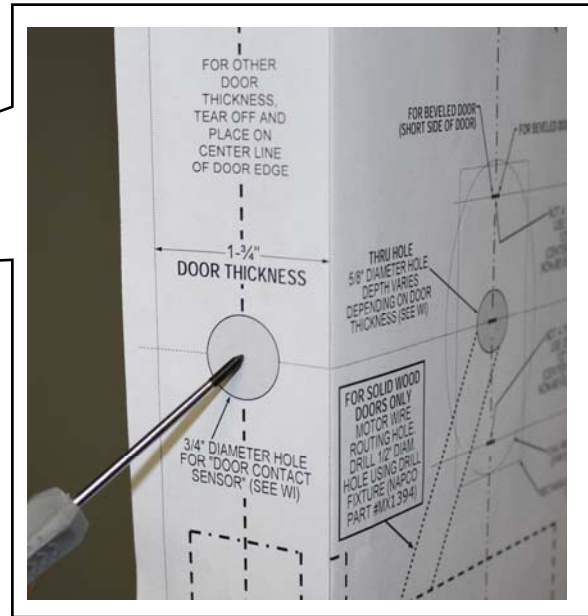

FIG. 5A: HOLE LOCATION DEPENDS ON DOOR THICKNESS

6. MARK "DOOR CONTACT MAGNET" ON JAMB

The **Door Contact Magnet** must be installed in the door jamb such that when the door is closed, the **Door Contact Sensor** is located *directly opposite* the **Magnet**. Install as follows:

- 6A. Open the door and temporarily place a piece of tape across the center of the mark made for the **Door Contact Sensor** in the previous step. This tape signifies the height (from the floor) of the **Door Contact Sensor**.
- 6B. Close the door. Transfer this height to the door jamb with a light pencil mark.
- 6C. Determine the center location on the jamb directly opposite the **Door Contact Sensor** when the door is closed. Open the door and measure the distance from the door edge to the center of the **Door Contact Sensor** (0.875" or $\frac{7}{8}$ "). Transfer this distance to the door jamb, measured from the door stop.

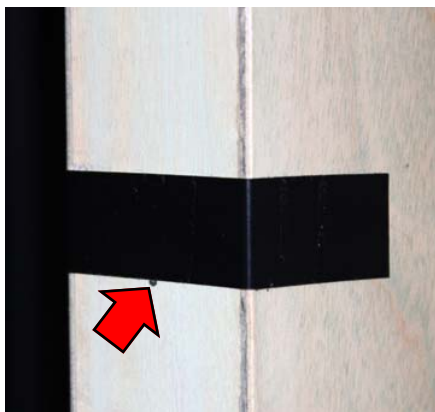

FIG. 6A: TAPE SIGNIFIES "HEIGHT FROM FLOOR"



FIG. 6B: CLOSE DOOR AND TRANSFER HEIGHT TO JAMB



FIG. 6C: LOCATE MAGNET IN JAMB CENTERED DIRECTLY OPPOSITE THE SENSOR WHEN DOOR IS CLOSED

7. TAPE ON DOOR: "SURFACE-MOUNTED NETWORKX CONTROL UNIT" TEMPLATE (WI2103)

The **Surface-Mounted Networkx Control Unit** (see Fig. A on page 1) is always mounted on the inside ("protected" side) door surface.

Fold and place the template (WI2103) on the **inside door edge**. Align the template with the "**HORIZONTAL CENTER LINE OF LEVER**" as shown on the template. Tape the template in place.

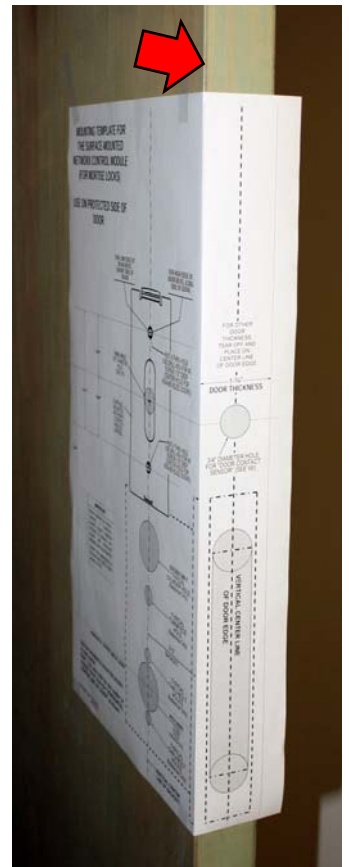

FIG. 7: EXAMPLE OF INSIDE DOOR EDGE (ARROW)

8. MARK TEMPLATE "SURFACE-MOUNTED NETWORKX CONTROL UNIT" HOLES

On the inside ("protected") door surface, mark the two **Control Unit Mounting Plate** (Fig. 8) holes using the correct markings printed on the template (if door is beveled, use correct markings for beveled doors as described in step 1).

The center of the **5/8" Diameter Thru-Hole** was already marked on the *outside* surface in step 4; for the *inside* door surface, mark the center of this same **5/8" Diameter Thru-Hole**. This **5/8" Diameter Thru-Hole** is used for the **Mortise Lock Motor Wire, Proximity Reader and Door Contact Sensor wires**.

Carefully remove the template.

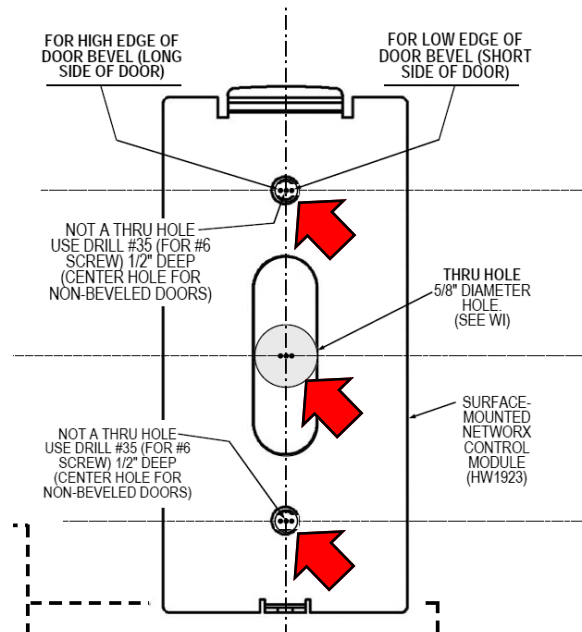

FIG. 8: MARK THE TWO "CONTROL UNIT MOUNTING PLATE" HOLES (ARROWS)

DOOR PREP: DRILL HOLES

IMPORTANT: Remove all burrs from wire holes. *Sharp edges can eventually wear away wire insulation.*

9. DRILL THE FOLLOWING HOLES IN THE DOOR

9A. Use 7/64" drill bit:

On the outside ("unprotected side") door surface, drill the two pilot holes for the **Proximity Reader** mounting screws (NOT thru-holes, drill only into the door surface).

9B. Use 7/64" drill bit:

On the inside ("protected side") door surface, drill the two pilot holes for the **Control Unit Mounting Plate** mounting screws (NOT thru-holes). Drill only into the inside door surface.

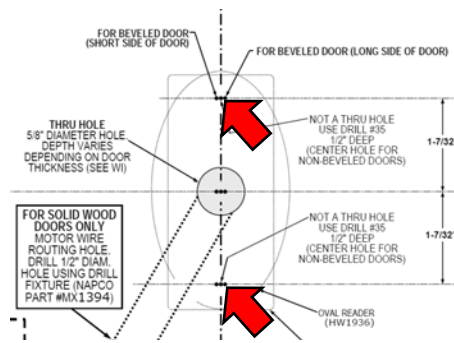

FIG. 9A: 7/64" PILOT HOLE ON OUTSIDE DOOR SURFACE FOR PROXIMITY READER

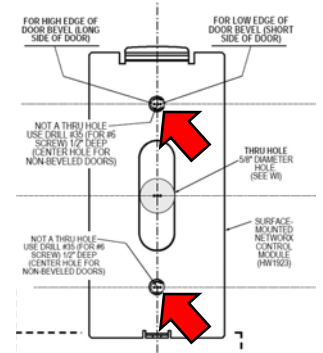

FIG. 9B: 7/64" PILOT HOLE ON INSIDE DOOR SURFACE FOR CONTROL UNIT PLATE

9C. Use 5/8" drill bit: **5/8" Diameter Thru-Hole.**

Drill straight through the door.

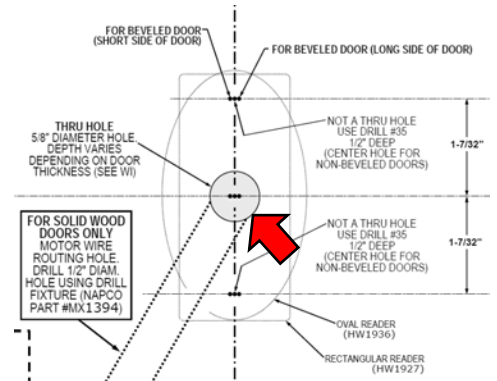

FIG. 9C: 5/8" DIAMETER THRU-HOLE

9D. Use 3/4" drill bit: **3/4" Door Contact Sensor hole** in edge of the door (for solid wood doors, drill until the hole intersects with the **5/8" Diameter Thru-Hole**).

(5/8" DIAMETER THRU-HOLE, DRILLED IN STEP 9C)



FIG. 9D: 3/4" DOOR CONTACT SENSOR HOLE IN EDGE OF THE DOOR

10. DRILL "DOOR CONTACT MAGNET" HOLE IN JAMB

10A. Find the **Door Contact Magnet**. The type provided will be either **Type A** (3/4" dia.) or **Type B** (3/8" dia.) as shown in one of the two images in Fig. 10A below.

10B. Drill into the door jamb as follows:

For Hardwood Jambs:

- For the thicker "Type A" contact (below left image): Drill a 3/4" hole 7/8" deep into the jamb (marked in step 6).
- For the thinner "Type B" contact (below right image): Drill a 3/8" hole 7/8" deep into the jamb (marked in step 6).

For Hollow Metal Jambs:

- Use either a 3/4" or 3/8" bit (depending on **Door Contact Magnet** Type A or Type B) to drill a hole into the surface of the jamb.

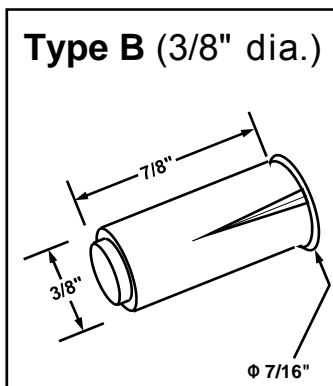
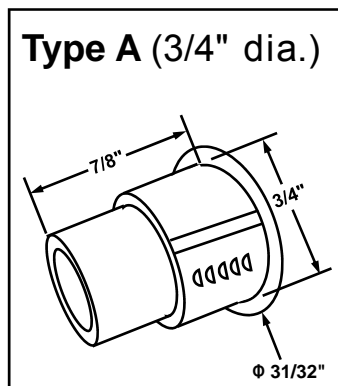

FIG. 10A: FIND THE "DOOR CONTACT MAGNET" PROVIDED, EITHER TYPE A (3/4" DIAMETER) OR TYPE B (3/8" DIAMETER)

FIG. 10B: DRILL DOOR JAMB HOLE (EITHER 3/8" OR 3/4" DEPENDING ON TYPE)

10C. Insert the magnetic **Door Contact Magnet** in the jamb hole; the contact sits almost flush with the jamb when fully inserted. In some cases, an adhesive may be needed to ensure a secure fit.



FIG. 10C: DOOR CONTACT MAGNET INSTALLED IN DOOR JAMB

DECISION: HOW TO ROUTE THE MORTISE LOCK MOTOR WIRE?



The **Mortise Lock** body includes a **Mortise Lock Motor Wire** plug that must be routed to and plugged into the **Surface-Mounted Networkx Control Unit** that is mounted on the inside ("protected side") of the door. HOW this **Motor Wire** is routed depends on whether the door is *solid* or *hollow*.

Hollow Metal Doors:

- Simply route the **Mortise Lock Motor Wire** within the hollow metal door. Skip to step 12.

Solid Wood Doors:

- Use the **Mortise Drill Jig** (part #N9511DJ) to drill a pathway for the wire *within* the solid wood door (from the **Mortise Lock** body to the **5/8" Diameter Thru-Hole**). Skip to step 11, below.

11. USING THE MORTISE DRILL JIG

The **Mortise Drill Jig** (part #N9511DJ) **MUST** be used with solid wood doors. For hollow metal doors, skip to step 12.

PURPOSE OF THE MORTISE DRILL JIG

The **Mortise Drill Jig** is used to drill a diagonal 1/2" hole through solid wood doors to provide path for the **Mortise Lock Motor Wire** to run within the door and to be plugged into the back of the **Surface-Mounted Networkx Control Unit**.

In the steps that follow, the **Jig** will be secured to the edge of the door (in the same location as the mortise lock faceplate). The hole will be drilled within the door, as shown in profile on the template WI2102 and also in the Fig. 11 "side view" showing where this **Mortise Drill Jig** is positioned and the path of this drilled interior hole.

11A. FASTEN DRILL JIG TO DOOR

The **Mortise Drill Jig** (part #N9511DJ) is placed into the edge of the door, into the same mortised opening that will be used for the **Mortise Lock**. Proceed as follows: Insert the **Jig** into the **Mortise Lock** opening as shown in Fig. 11A. Secure the **Jig** with the screws provided to prevent the **Jig** from shifting when in use.

Insert supplied 1/2-inch diameter wood drill bit into the **Mortise Drill Jig** and drill the hole until the **5/8" Diameter Thru-Hole** is reached.

When finished, remove the **Jig**.

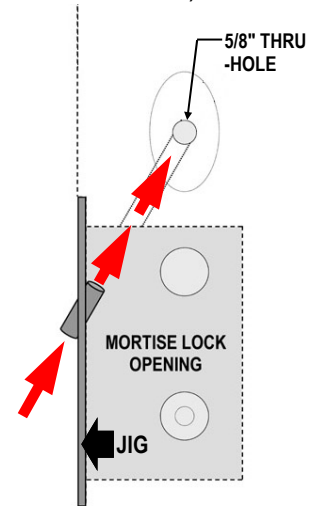

FIG. 11: SIDE VIEW: DRILL JIG (N9511DJ) DRILL HOLE INSIDE DOOR



FIG. 11A: MORTISE DRILL JIG PLACEMENT

12. INSTALL THE "MORTISE LOCK BODY"

Insert the **Mortise Lock Body** into the door while feeding the **Mortise Lock Motor Wire** through to the **5/8" Diameter Thru-Hole** and then to the inside ("protected") side of the door.

Note: The **Mortise Lock Motor Wire** plug sleeve color is *yellow*.

Referencing the lock installation instructions, secure the **Mortise Lock** with the mounting hardware provided.

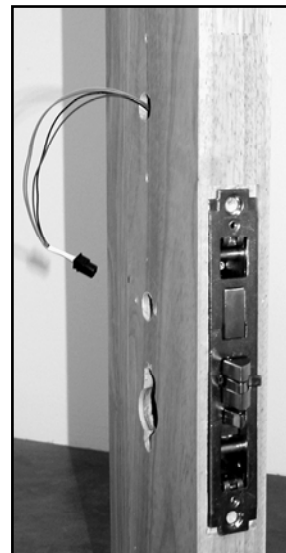

FIG. 12: ROUTE MORTISE LOCK WIRES THRU TO THE PROTECTED SIDE OF THE DOOR

13. INSTALL "DOOR CONTACT SENSOR" IN DOOR EDGE

Insert the **Door Contact Sensor** wires into its 3/4" hole in the door edge and through to the **5/8" Diameter Thru-Hole** and then to the inside ("protected") side of the door.

Note: The **Door Contact Sensor** plug sleeve color is *white*.



FIG. 13: ROUTE TO THE INSIDE ("PROTECTED") SIDE OF THE DOOR

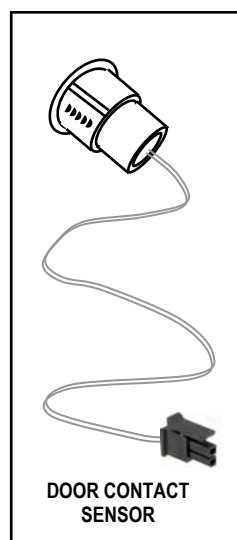

FIG. 13A

PROXIMITY READER INSTALLATION

Find the reader type provided, either rectangular or oval. If you have a **Rectangular Proximity Reader**, go to step 15. If you have an **Oval Proximity Reader**, go to step 14 below.

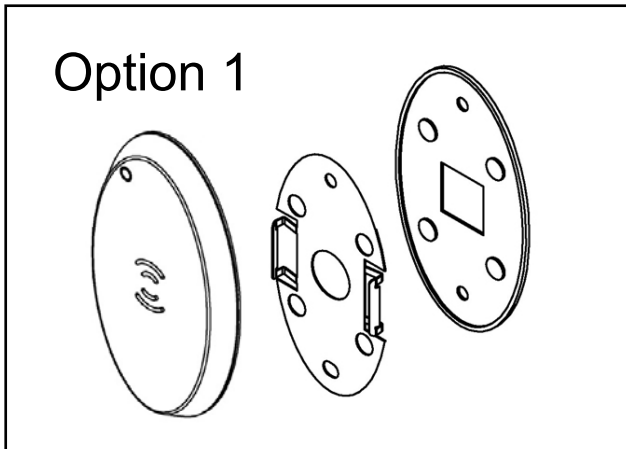

FIG. C: OVAL PROXIMITY READER
(GO TO STEP 14 BELOW)

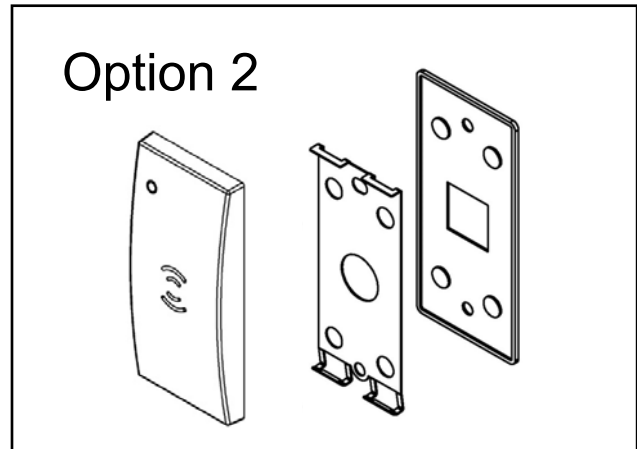
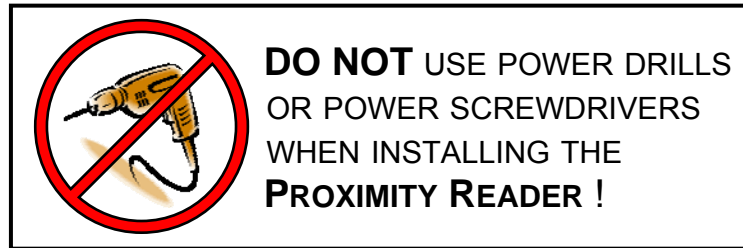

FIG. D: RECTANGULAR PROXIMITY READER
(GO TO STEP 15)



14. OVAL PROXIMITY READER INSTALLATION

If you have a "Rectangular" Proximity Reader, go to step 15.

Note that the **Oval Mounting Plate** is symmetrical, and therefore has no "top" or "bottom".

14A. INSTALL THE "OVAL RUBBER GASKET" AND THE "OVAL MOUNTING PLATE"

See Fig. 14A. Place the **Oval Rubber Gasket** against the door surface, over the **5/8" Diameter Thru-Hole** that was drilled into the door in step 9C.

Place the **Oval Mounting Plate** on top of the **Oval Rubber Gasket**, and secure (*snug-tight only, do not over-tighten*) using the two Phillips Pan Head screws appropriate for the door type as follows:

- **For Metal Doors:** #6-32 x 1/2" long Type F thread cutting Phillips head (part #SC212);
- **For Wood Doors:** #6 x 1/2" long Type A Phillips head (part #SC265)

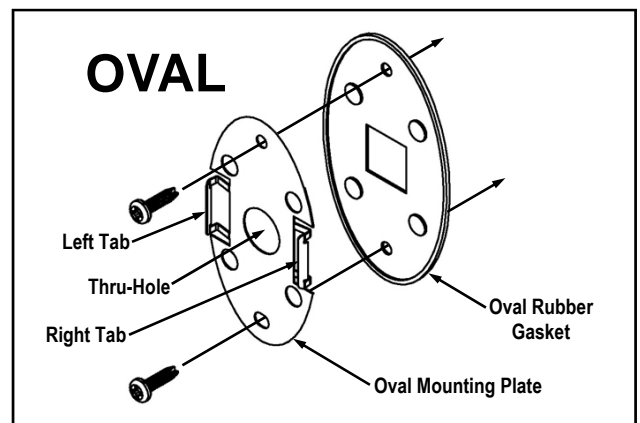

FIG. 14A: "OVAL MOUNTING PLATE" (WITH LEFT AND RIGHT "TABS") AND THE "OVAL RUBBER GASKET"

Again, do **NOT** over-tighten these screws; over-tightening will cause undesired deformation of the **Rubber Gasket**.

14B. RUN THE OVAL PROXIMITY READER WIRES

From the outside ("unprotected" side) of the door, feed the **Proximity Reader** wire fully into the **5/8" Diameter Thru-Hole** to the inside ("protected" side) of the door. *Do not pinch wire.*

Note: The **Oval Proximity Reader** plug sleeve color is *orange*.



FIG. 14B: FEED THE WIRE INTO THE 5/8" DIAMETER THRU-HOLE (FROM "OUTSIDE" TO "INSIDE")

14C. INSTALL OVAL PROXIMITY READER COVER

The **Oval Proximity Reader** cover "snaps" into place, as follows:

- a. Hook the **Reader** on the **Left Tab** of the **Mounting Plate**.
- b. Keep thumb pressure on left side.



FIG. 14C

- c. Press firmly on the right side of the **Reader** until it "snaps" into place.

Note: A spare **Mounting Plate** and **Rubber Gasket** are provided if needed. *Be careful not to pinch any wires.*



FIG. 14CC

15. RECTANGULAR PROXIMITY READER INSTALLATION

The **Rectangular Mounting Plate** IS NOT symmetrical, and therefore does have a "top" and a "bottom". Note the two **Top Tabs** and two **Bottom Tabs** shown in Fig. 15A:

15A. INSTALL THE "RECTANGULAR RUBBER GASKET" AND THE "RECTANGULAR MOUNTING PLATE"

See Fig. 15A. Place the **Rectangular Rubber Gasket** over the **5/8" Diameter Thru-Hole** that was drilled into the door in step 9C, then place the **Rectangular Mounting Plate** on top of the **Rectangular Rubber Gasket**, and secure (*snug-tight only, do not over-tighten*) using the two Phillips Pan Head screws appropriate for the door type as follows:

- **For Metal Doors:** #6-32 x 1/2" long Type F thread cutting Phillips head (part #SC212);
- **For Wood Doors:** #6 x 1/2" long Type A Phillips head (part #SC265)

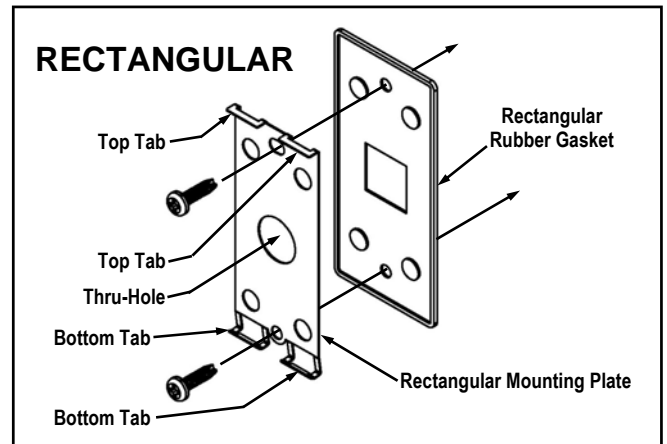

FIG. 15A: "RECTANGULAR PROXIMITY READER MOUNTING COMPONENTS"

Again, do **NOT** over-tighten these screws; over-tightening will cause undesired deformation of the **Rubber Gasket**.

15B. RUN THE RECTANGULAR PROXIMITY READER WIRES

From the outside ("unprotected" side) of the door, feed the **Rectangular Proximity Reader** wire fully into the **5/8" Diameter Thru-Hole** to the inside ("protected" side) of the door. *Do not pinch wire.*

Note: The **Rectangular Proximity Reader** plug sleeve color is *orange*.

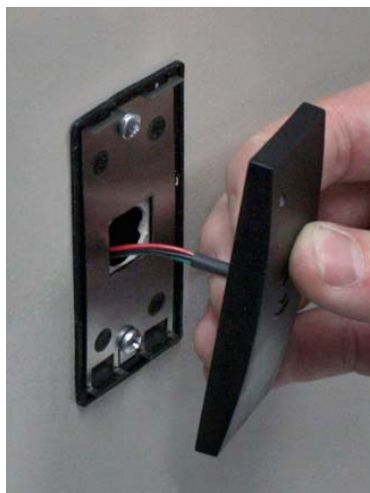

FIG. 15B: FEED THE WIRE INTO THE 5/8" DIAMETER THRU-HOLE (FROM "OUTSIDE" TO "INSIDE")

15C. INSTALL RECTANGULAR PROXIMITY READER COVER

The **Rectangular Proximity Reader** cover "snaps" into place, as follows:

- a. Hook the **Rectangular Proximity Reader** on the two **Top Tabs** on the top of the **Rectangular Mounting Plate** (see Fig 15C).



FIG. 15C

- b. Press firmly on the bottom of the **Rectangular Proximity Reader** until it "snaps" into place.

Be careful not to pinch any wires.



FIG. 15CC

16. INSTALL "CONTROL UNIT MOUNTING PLATE"

Locate the two pilot holes for the **Control Unit Mounting Plate** mounting screws that were drilled into the inside ("protected") door surface in step 9B.

Important! See Fig 16 to determine which end is the "TOP".

Place the **Control Unit Mounting Plate** against the inside ("protected" side) door surface and secure using the two Phillips Flat Head screws appropriate for the door type as follows:

- **For Metal Doors:** #6-32 x 5/8" long Type 23 thread cutting Phillips Flat head, U-cut (part #SC682);
- **For Wood Doors:** #6 x 3/4" long undercut self-tapping Type A (part #SC596)

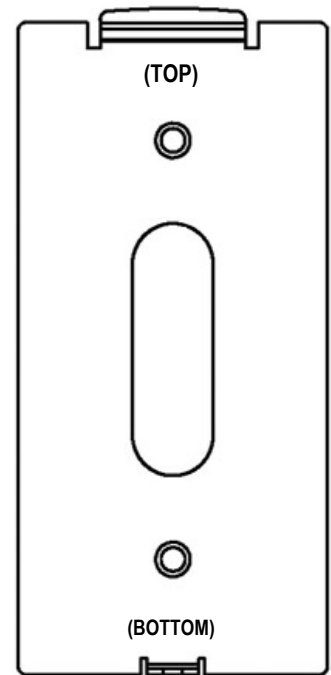
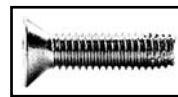

FIG. 16:
CONTROL UNIT MOUNTING
PLATE

17. CONNECT PLUGS IN THE "SURFACE-MOUNTED NETWORKX CONTROL UNIT"

Match the plug wire sleeve colors to the corresponding socket dot colors (see Fig. 17). **Note:** The rear of the **Surface-Mounted Networkx Control Unit** has five (5) sockets, *but only three (3) are used*.

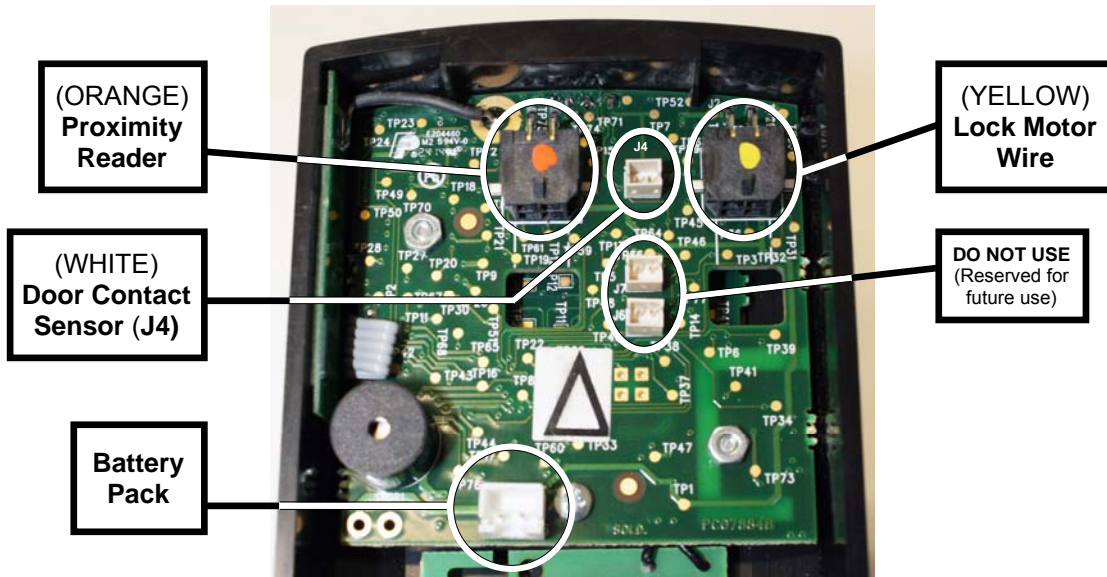

FIG. 17: CONTROL UNIT CONNECTIONS

18. CONNECT THE BATTERY PACK

See Fig. 18 for the location of the **Battery Pack** socket. Place the **Battery Pack** into the rear of the **Surface-Mounted Networkx Control Unit** with the flat side up, as shown in Fig. 18:

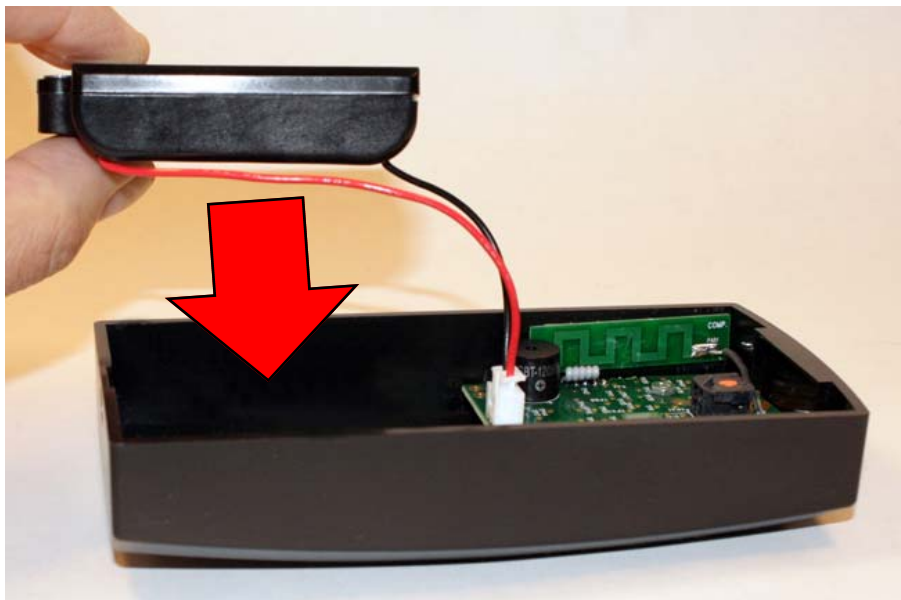

FIG. 18: INSTALL BATTERY PACK WITH FLAT SIDE UP

19. MOUNT THE "SURFACE-MOUNTED NETWORKX CONTROL UNIT"

Before mounting, we recommend feeding all of the previously connected wires back into the door.

- a. Hook the top of the **Surface-Mounted Networkx Control Unit** into the top of the **Control Unit Mounting Plate** and press the bottom until flush with the door surface.
- b. Insert the "Dog Point" screw into the bottom of the **Surface-Mounted Networkx Control Unit** (#6-32 Allen Head countersunk U-cut Dog Point screw, part #SC681 as shown in Fig. 19). First thread this screw by hand using the knurled head for grip, then tighten with the "rounded head" of the supplied Allen key.

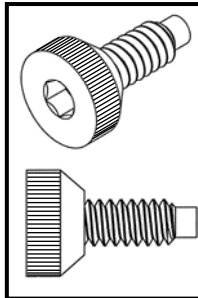

FIG. 19: "DOG POINT" SCREW



FIG. 19A: INSERT "DOG POINT" SCREW HERE

ArchiTech Networkx Limited Warranty

NAPCO Security Technologies, Inc. (NAPCO) warrants its products to be free from manufacturing defects in materials and workmanship for twenty four months following the date of manufacture. NAPCO will, within said period, at its option, repair or replace any product failing to operate correctly without charge to the original purchaser or user.

This warranty shall not apply to any equipment, or any part thereof, which has been repaired by others, improperly installed, improperly used, abused, altered, damaged, subjected to acts of God, or on which any serial numbers have been altered, defaced or removed. Seller will not be responsible for any dismantling or reinstallation charges, environmental wear and tear, normal maintenance expenses, or shipping and freight expenses required to return products to NAPCO. Additionally, this warranty shall not cover scratches, abrasions or deterioration due to the use of paints, solvents or other chemicals.

THERE ARE NO WARRANTIES, EXPRESS OR IMPLIED, WHICH EXTEND BEYOND THE DESCRIPTION ON THE FACE HEREOF. THERE IS NO EXPRESS OR IMPLIED WARRANTY OF MERCHANTABILITY OR A WARRANTY OF FITNESS FOR A PARTICULAR PURPOSE. ADDITIONALLY, THIS WARRANTY IS IN LIEU OF ALL OTHER OBLIGATIONS OR LIABILITIES ON THE PART OF NAPCO.

Any action for breach of warranty, including but not limited to any implied warranty of merchantability, must be brought within the six months following the end of the warranty period.

IN NO CASE SHALL NAPCO BE LIABLE TO ANYONE FOR ANY CONSEQUENTIAL OR INCIDENTAL DAMAGES FOR BREACH OF THIS OR ANY OTHER WARRANTY, EXPRESS OR IMPLIED, EVEN IF THE LOSS OR DAMAGE IS CAUSED BY THE SELLER'S OWN NEGLIGENCE OR FAULT.

In case of defect, contact the security professional who installed and maintains your security system. In order to exercise the warranty, the product must be returned by the security professional, shipping costs prepaid and insured to NAPCO. After repair or replacement, NAPCO assumes the cost of returning products under warranty. NAPCO shall have no obligation under this warranty, or otherwise, if the product has been repaired by others, improperly installed, improperly used, abused, altered, damaged, subjected to accident, nuisance, flood, fire or acts of God, or on which any serial numbers have been altered, defaced or removed. NAPCO will not be responsible for any dismantling, reassembly or reinstallation charges, environmental wear and tear, normal maintenance expenses, or shipping and freight expenses required to return products to NAPCO. Additionally, this warranty shall not cover scratches, abrasions or deterioration due to the use of paints, solvents or other chemicals.

This warranty contains the entire warranty. It is the sole warranty and any prior agreements or representations, whether oral or written, are either merged herein or are expressly cancelled. NAPCO neither assumes, nor authorizes any other person purporting to act on its behalf to modify, to change, or to assume for it, any other warranty or liability concerning its products.

In no event shall NAPCO be liable for an amount in excess of NAPCO's original selling price of the product, for any loss or damage, whether direct, indirect, incidental, consequential, or otherwise arising out of any failure of the product. Seller's warranty, as hereinabove set forth, shall not be enlarged, diminished or affected by and no obligation or liability shall arise or grow out of Seller's rendering of technical advice or service in connection with Buyer's order of the goods furnished hereunder.

NAPCO RECOMMENDS THAT THE ENTIRE SYSTEM BE COMPLETELY TESTED WEEKLY.

Warning: Despite frequent testing, and due to, but not limited to, any or all of the following; criminal tampering, electrical or communications disruption, it is possible for the system to fail to perform as expected. NAPCO does not represent that the product/system may not be compromised or circumvented; or that the product or system will prevent any personal injury or property loss by burglary, robbery, fire or otherwise; nor that the product or system will in all cases provide adequate warning or protection. A properly installed and maintained alarm may only reduce risk of burglary, robbery, fire or otherwise but it is not insurance or a guarantee that these events will not occur. CONSEQUENTLY, SELLER SHALL HAVE NO LIABILITY FOR ANY PERSONAL INJURY, PROPERTY DAMAGE, OR OTHER LOSS BASED ON A CLAIM THE PRODUCT FAILED TO GIVE WARNING. Therefore, the installer should in turn advise the consumer to take any and all precautions for his or her safety including, but not limited to, fleeing the premises and calling police or fire department, in order to mitigate the possibilities of harm and/or damage.

NAPCO is not an insurer of either the property or safety of the user's family or employees, and limits its liability for any loss or damage including incidental or consequential damages to NAPCO's original selling price of the product regardless of the cause of such loss or damage.

Some states do not allow limitations on how long an implied warranty lasts or do not allow the exclusion or limitation of incidental or consequential damages, or differentiate in their treatment of limitations of liability for ordinary or gross negligence, so the above limitations or exclusions may not apply to you. This Warranty gives you specific legal rights and you may also have other rights which vary from state to state.