

3.4 – Base Station equipment installation

Considerations

- The rack containing the DBS sub-rack assembly and DC/DC PSUs is for indoor installation.
- The 7390BS indoor rack will be positioned according to user needs and technical constraints (e.g., respect of minimum distances, connections layout, RBS/DBS connection accessibility, power supply).
- The power supply is to be connected after installation of the 7390BS indoor rack, at the time of its commissioning (cf. *Chapter 5 – Commissioning the Base Station (7390BS)*).

Definition of racks

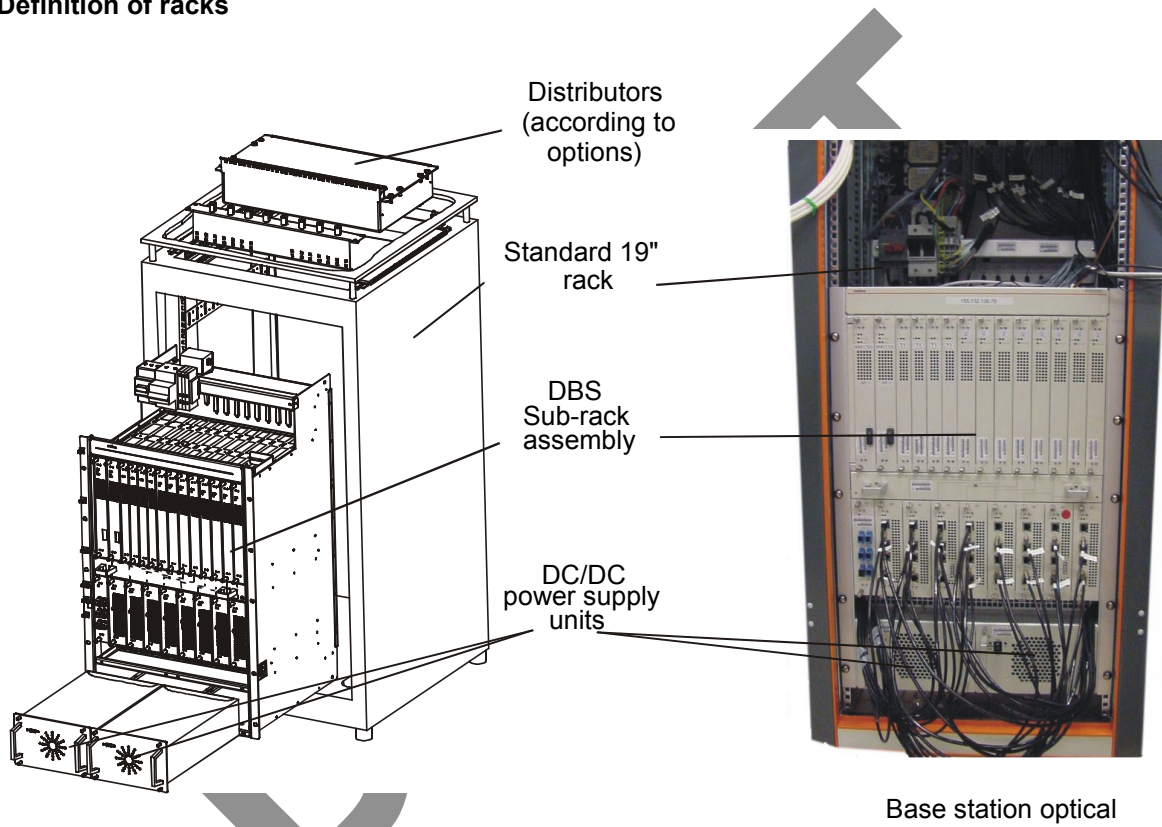

Figure 87 – Example of configuration of a 7390BS station in a standard rack

3.4.1 – Mechanical installation

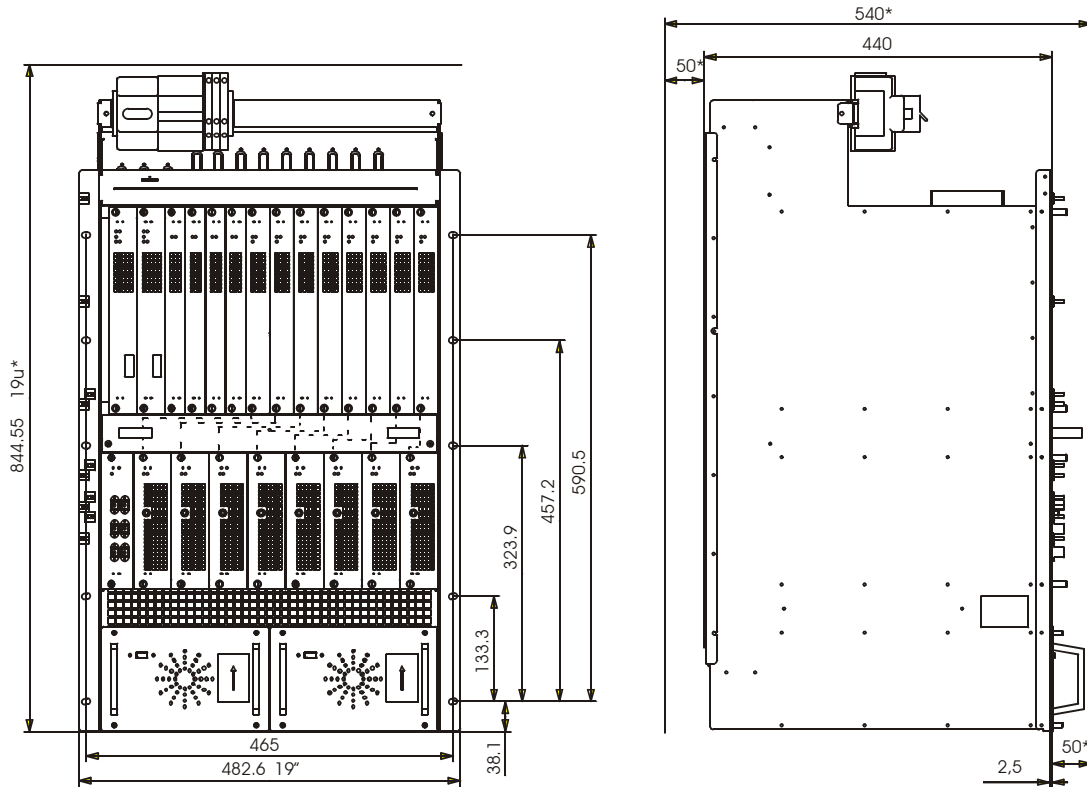

Figure 88 – Chassis dimensions and clearances (dimensions in mm)

- Respect the requested clearances for the wiring, in order to avoid damage to the connectors (marked with an*).

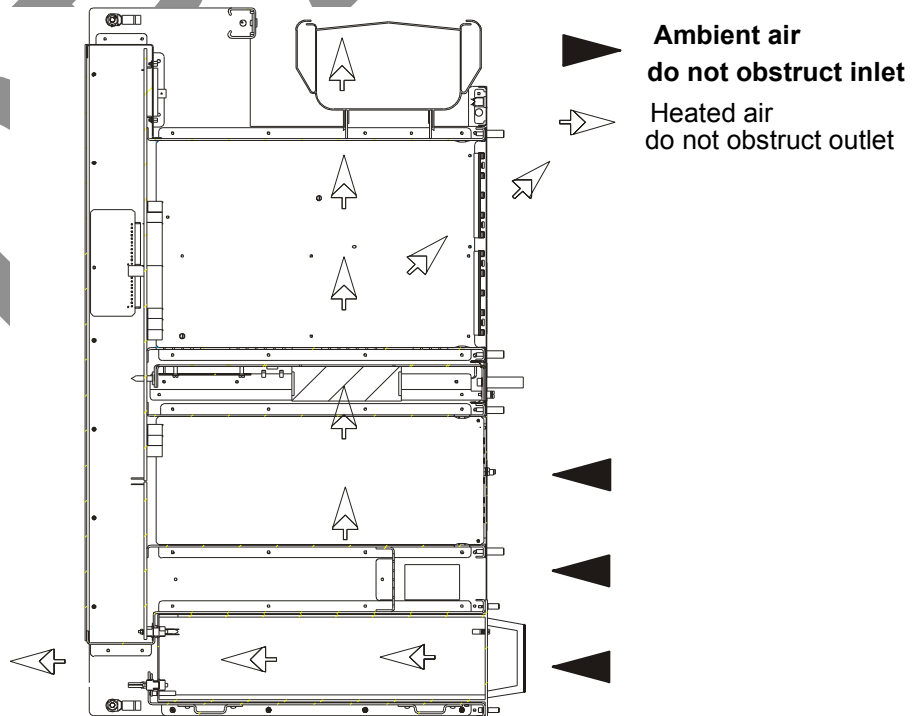

Figure 89 – Ventilation of the DBS chassis (cross-section)

- The installation of rack (optional) and chassis must enable the ventilation shown *Figure 89 – Ventilation of the DBS chassis (cross-section)*. Do not obstruct the air inlets and outlets.

Stages

1. Choose the location where the equipment is to be assembled and unpack the standard rack. If its top cover is fitted, remove it (quarter-turn screw).

Note: place the rack in such a way that the cable connections are accessible before the rack is installed definitively.

2. Unpack the DBS chassis assembly and install it inside the rack. Fix and screw into place.
3. Unpack the DC/DC PSUs; install and plug them in the DBS chassis.
4. Carry out the electrical connection, cf. § 3.4.2 – *Electrical connection*.
5. Carry out the client terminal connections, cf. § 3.4.3 – *Customer access connections (circuits interfaces)* and 3.4.4 – *Client access connections (ATM network interface)*.
6. Connect the X-Pol RBS/DBS connection cable(s).

3.4.2 – Electrical connection



Considerations

- The DBS chassis is supplied from the rated DC voltage of 48 V (minimum 35 V, maximum 60 V).
- The cable connecting the external DC power source to the DBS sub-rack will have a minimum cross-section of 3x10 mm² and a maximum length of 20 meters.
- The rack must be grounded to the general grounding system. For this, the rack mechanism will be connected by a cable with a minimum cross-section of 16 mm², attached using a 6 mm bolt.
- For the power supply block diagram, refer to *Figure 90 – DBS chassis power supply*.

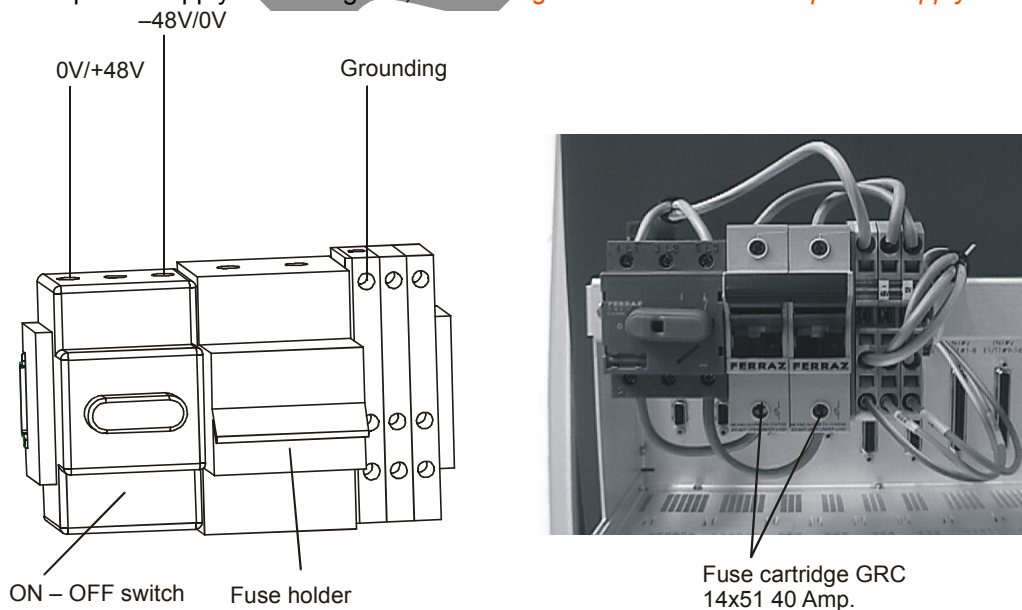



Figure 90 – DBS chassis power supply

Note: The user can connect +48 V or -48 V to ground.

Stages (*Figure 92 – DBS sub-rack power connection*)

1. Connect the switch at the top of the DBS sub-rack to the external DC power source. You are recommended to pass the power supply cable via the top of the rack.

	ATTENTION: DO NOT CONNECT THE GROUNDING CABLE TO THE SWITCH BUT TO THE YELLOW/GREEN TERMINAL BLOCK
---	---

2. Ground the DBS sub-rack.

Note: a ground strip is fixed to the backplane and ensures its grounding. The rack and subrack ground are screwed together, thus no special grounding is required for the rack.

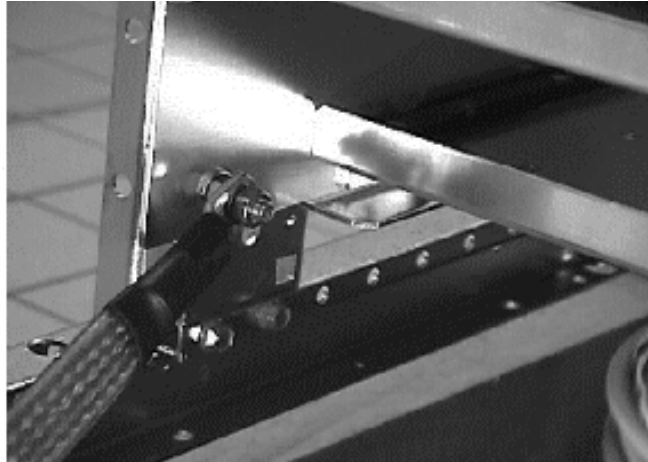

Figure 91 – DBS sub-rack ground connection

Earthing must be done very carefully in order to assure good operation of the DBS.

3. Make sure that the fuses are inserted in the fuse-holder. Before changing fuse, make sure that the switch is set to OFF.

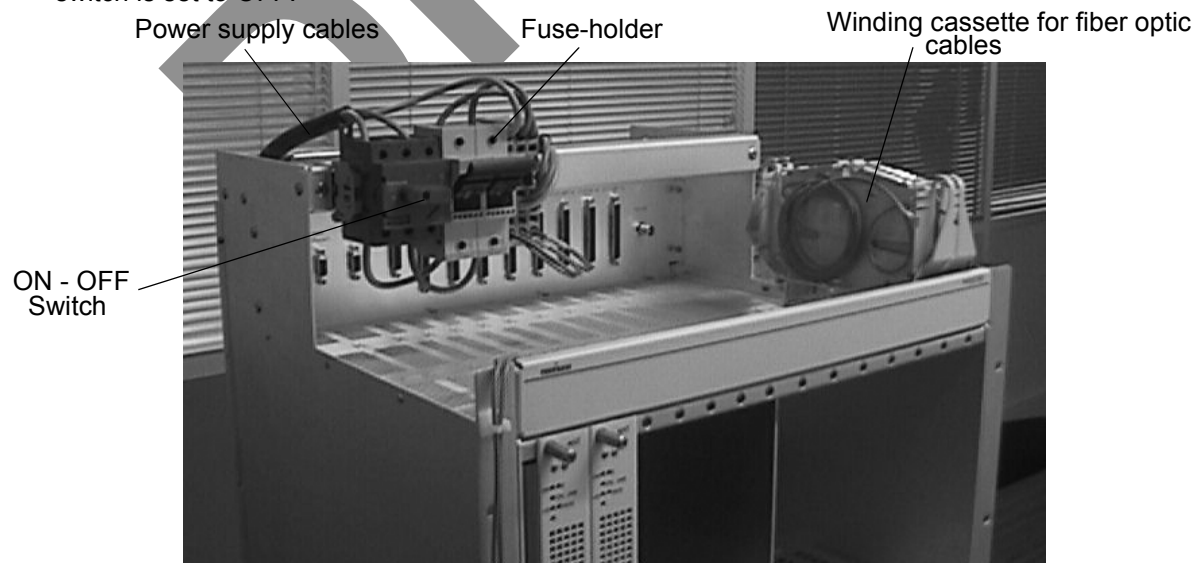

Figure 92 – DBS sub-rack power connection

3.4.3 – Customer access connections (circuits interfaces)

Considerations

This connection involves the use of:

- either direct **connectors** TNT1 to TNT4, (corresponding to TNT board plug into the chassis) at the top of the DBS sub-rack, if no distribution frames (cf. § 3.4.3.1 – *Direct connections to the connectors of the top panel of the DBS chassis.*);
- or the optional **distribution frames** at the top of the DBS sub-rack in the standard rack (coaxial cables for the 75 ohm links, balanced pair cables for the 120 ohm links cf. § 3.4.3.2 – *Connections to 75 ohm coaxial distributors* and § 3.4.3.3 – *Connections to 120 ohm distributors*).

Note: the provided equipment is already connected and parts of the installation kit.

	ALL CUSTOMER ACCESS CABLES MUST BE SHIELDED TYPE
--	---

3.4.3.1 – Direct connections to the connectors of the top panel of the DBS chassis.

Note: All connectors are female connectors.

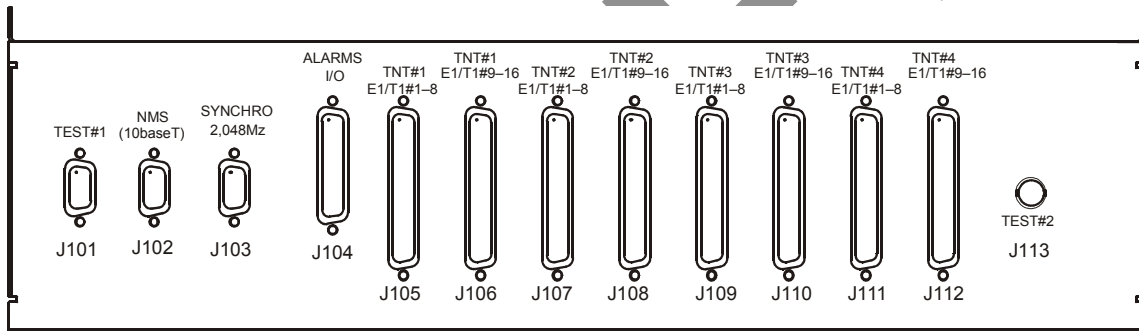
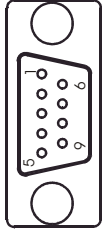

Figure 93 – Top panel DBS connections: connectors location

	DO NOT REMOVE THE COVER ON CONNECTOR TEST J113
--	---

CONNECTOR TEST#1 J101



- Pin 01: SDA_Fdp
- Pin 02: ground
- Pin 03: ground
- Pin 04: PC_RS232_Rx_1
- Pin 05: PC_RS232_Rx_0
- Pin 06: SCL_Fdp
- Pin 07: ground
- Pin 08: PC_RS232_Tx_1
- Pin 09: PC_RS232_Tx_0

CONNECTOR NMS J102

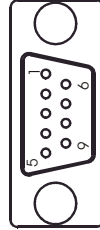

- Pin 01: not connected
- Pin 02: ground
- Pin 03: ground
- Pin 04: ground
- Pin 05: not connected
- Pin 06: 10BT_RxD_M
- Pin 07: 10BT_RxD_P
- Pin 08: 10BT_TxD_M
- Pin 09: 10BT_TxD_P

CONNECTOR SYNCHRO J103

Clock signals have no polarity
 —> P and M not significant

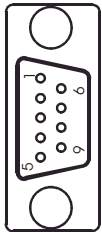

- Pin 01: Clk_2M_Out_P (do not connect)
- Pin 02: ground
- Pin 03: ground
- Pin 04: ground
- Pin 05: Clk_2M_In_M (clock input)
- Pin 06: Clk_2M_Out_M (do not connect)
- Pin 07: ground
- Pin 08: ground
- Pin 09: Clk_2M_In_P (clock input)

CONNECTOR J113

DO NOT CONNECT



**TEST#2
 J113**

	<p>Do not connect pins 01 and 06 (clock output: 75 ohms load, 06 connected to ground)</p>
--	---

Figure 94 – DBS connections, assignment of access points (1)

CONNECTOR ALARM J104

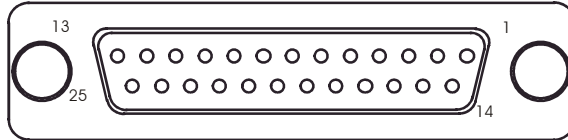

ALARMS

Pin 01: I_AL_0	Remote signaling input 1	
Pin 02: I_AL_2	Remote signaling input 3	
Pin 03: I_AL_4	Remote signaling input 5	
Pin 04: I_AL_6	Remote signaling input 7	
Pin 05: ground		
Pin 06: ground		
Pin 07: ATT_B	ATTENDED alarm relay idle	} Red 'UG' and 'NUG' LEDs (not managed in NR 2.2)
Pin 08: NURG_B	NON-URGENT alarm relay idle	
Pin 09: URG_B	URGENT alarm relay idle	
Pin 10: CMD_4_B	Remote control # 4 idle	
Pin 11: CMD_3_B	Remote control # 3 idle	
Pin 12: CMD_2_B	Remote control # 2 idle	
Pin 13: CMD_1_B	Remote control # 1 idle	
Pin 14: I_AL_1	Remote signaling input 2	
Pin 15: I_AL_3	Remote signaling input 4	
Pin 16: I_AL_5	Remote signaling input 6	
Pin 17: I_AL_7	Remote signaling input 8	
Pin 18: Ground		
Pin 19: ATT_A	ATTENDED alarm common relay	} Red 'UG' and 'NUG' LEDs (not managed in NR 2.2)
Pin 20: NURG_A	NON-URGENT alarm common relay	
Pin 21: URG_A	URGENT alarm common relay	
Pin 22: CMD_4_A	Common remote control # 4	
Pin 23: CMD_3_A	Common remote control # 3	
Pin 24: CMD_2_A	Common remote control # 2	
Pin 25: CMD_1_A	Common remote control # 1	

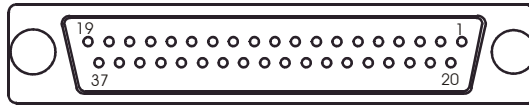

**TNT#1
E1/T1#1-8
J105**

Pin 01: ground
 Pin 02: Input_1_P_1
 Pin 03: Input_2_P_1
 Pin 04: Input_3_P_1
 Pin 05: Input_4_P_1
 Pin 06: Input_5_P_1
 Pin 07: Input_6_P_1
 Pin 08: Input_7_P_1
 Pin 09: Input_8_P_1
 Pin 10: ground
 Pin 11: ground
 Pin 12: Output_1_P_1
 Pin 13: Output_2_P_1
 Pin 14: Output_3_P_1
 Pin 15: Output_4_P_1
 Pin 16: Output_5_P_1
 Pin 17: Output_6_P_1
 Pin 18: Output_7_P_1
 Pin 19: Output_8_P_1
 Pin 20: ground
 Pin 21: Input_1_M_1
 Pin 22: Input_2_M_1
 Pin 23: Input_3_M_1
 Pin 24: Input_4_M_1
 Pin 25: Input_5_M_1
 Pin 26: Input_6_M_1
 Pin 27: Input_7_M_1
 Pin 28: Input_8_M_1
 Pin 29: ground
 Pin 30: Output_1_M_1
 Pin 31: Output_2_M_1
 Pin 32: Output_3_M_1
 Pin 33: Output_4_M_1
 Pin 34: Output_5_M_1
 Pin 35: Output_6_M_1
 Pin 36: Output_7_M_1
 Pin 37: Output_8_M_1

**TNT#1
E1/T1#9-16
J106**

ground
 Input_9_P_2
 Input_10_P_2
 Input_11_P_2
 Input_12_P_2
 Input_13_P_2
 Input_14_P_2
 Input_15_P_2
 Input_16_P_2
 ground
 ground
 Output_9_P_2
 Output_10_P_2
 Output_11_P_2
 Output_12_P_2
 Output_13_P_2
 Output_14_P_2
 Output_15_P_2
 Output_16_P_2
 ground
 Input_9_M_2
 Input_10_M_2
 Input_11_M_2
 Input_12_M_2
 Input_13_M_2
 input_14_M_2
 Input_15_M_2
 Input_16_M_2
 ground
 Output_9_M_2
 Output_10_M_2
 Output_11_M_2
 Output_12_M_2
 Output_13_M_2
 Output_14_M_2
 Output_15_M_2
 Output_16_M_2

**TNT#2
E1/T1#1-8
J107**

ground
 Input_1_P_3
 Input_2_P_3
 Input_3_P_3
 Input_4_P_3
 Input_5_P_3
 Input_6_P_3
 Input_7_P_3
 Input_8_P_3
 ground
 ground
 Output_1_P_3
 Output_2_P_3
 Output_3_P_3
 Output_4_P_3
 Output_5_P_3
 Output_6_P_3
 Output_7_P_3
 Output_8_P_3
 ground
 Input_1_M_3
 Input_2_M_3
 Input_3_M_3
 Input_4_M_3
 Input_5_M_3
 input_6_M_3
 Input_7_M_3
 Input_8_M_3
 ground
 Output_1_M_3
 Output_2_M_3
 Output_3_M_3
 Output_4_M_3
 Output_5_M_3
 Output_6_M_3
 Output_7_M_3
 Output_8_M_3

**TNT#2
E1/T1#9-16
J108**

ground
 Input_9_P_4
 Input_10_P_4
 Input_11_P_4
 Input_12_P_4
 Input_13_P_4
 Input_14_P_4
 Input_15_P_4
 Input_16_P_4
 ground
 ground
 Output_9_P_4
 Output_10_P_4
 Output_11_P_4
 Output_12_P_4
 Output_13_P_4
 Output_14_P_4
 Output_15_P_4
 Output_16_P_4
 ground
 Input_9_M_4
 Input_10_M_4
 Input_11_M_4
 Input_12_M_4
 Input_13_M_4
 input_14_M_4
 Input_15_M_4
 Input_16_M_4
 ground
 Output_9_M_4
 Output_10_M_4
 Output_11_M_4
 Output_12_M_4
 Output_13_M_4
 Output_14_M_4
 Output_15_M_4
 Output_16_M_4

P = + / M = -

Figure 95 – DBS connections, assignment of access points (2)

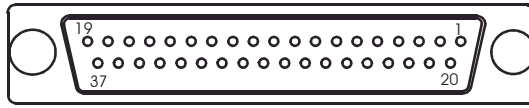

**TNT#3
E1/T1#1-8
J109**

**TNT#3
E1/T1#9-16
J110**

**TNT#4
E1/T1#1-8
J111**

**TNT#4
E1/T1#9-16
J112**

Pin 01: ground
 Pin 02: Input_1_P_5
 Pin 03: Input_2_P_5
 Pin 04: Input_3_P_5
 Pin 05: Input_4_P_5
 Pin 06: Input_5_P_5
 Pin 07: Input_6_P_5
 Pin 08: Input_7_P_5
 Pin 09: Input_8_P_5
 Pin 10: ground
 Pin 11: ground
 Pin 12: Output_1_P_5
 Pin 13: Output_2_P_5
 Pin 14: Output_3_P_5
 Pin 15: Output_4_P_5
 Pin 16: Output_5_P_5
 Pin 17: Output_6_P_5
 Pin 18: Output_7_P_5
 Pin 19: Output_8_P_5
 Pin 20: ground
 Pin 21: Input_1_M_5
 Pin 22: Input_2_M_5
 Pin 23: Input_3_M_5
 Pin 24: Input_4_M_5
 Pin 25: Input_5_M_5
 Pin 26: Input_6_M_5
 Pin 27: Input_7_M_5
 Pin 28: Input_8_M_5
 Pin 29: ground
 Pin 30: Output_1_M_5
 Pin 31: Output_2_M_5
 Pin 32: Output_3_M_5
 Pin 33: Output_4_M_5
 Pin 34: Output_5_M_5
 Pin 35: Output_6_M_5
 Pin 36: Output_7_M_5
 Pin 37: Output_8_M_5

ground
 Input_9_P_6
 Input_10_P_6
 Input_11_P_6
 Input_12_P_6
 Input_13_P_6
 Input_14_P_6
 Input_15_P_6
 Input_16_P_6
 ground
 ground
 Output_9_P_6
 Output_10_P_6
 Output_11_P_6
 Output_12_P_6
 Output_13_P_6
 Output_14_P_6
 Output_15_P_6
 Output_16_P_6
 ground
 Input_9_M_6
 Input_10_M_6
 Input_11_M_6
 Input_12_M_6
 Input_13_M_6
 input_14_M_6
 Input_15_M_6
 Input_16_M_6
 ground
 Output_9_M_6
 Output_10_M_6
 Output_11_M_6
 Output_12_M_6
 Output_13_M_6
 Output_14_M_6
 Output_15_M_6
 Output_16_M_6

ground
 Input_1_P_7
 Input_2_P_7
 Input_3_P_7
 Input_4_P_7
 Input_5_P_7
 Input_6_P_7
 Input_7_P_7
 Input_8_P_7
 ground
 ground
 Output_1_P_7
 Output_2_P_7
 Output_3_P_7
 Output_4_P_7
 Output_5_P_7
 Output_6_P_7
 Output_7_P_7
 Output_8_P_7
 ground
 Input_1_M_7
 Input_2_M_7
 Input_3_M_7
 Input_4_M_7
 Input_5_M_7
 input_6_M_7
 Input_7_M_7
 Input_8_M_7
 ground
 Output_1_M_7
 Output_2_M_7
 Output_3_M_7
 Output_4_M_7
 Output_5_M_7
 Output_6_M_7
 Output_7_M_7
 Output_8_M_7

ground
 Input_9_P_8
 Input_10_P_8
 Input_11_P_8
 Input_12_P_8
 Input_13_P_8
 Input_14_P_8
 Input_15_P_8
 Input_16_P_8
 ground
 ground
 Output_9_P_8
 Output_10_P_8
 Output_11_P_8
 Output_12_P_8
 Output_13_P_8
 Output_14_P_8
 Output_15_P_8
 Output_16_P_8
 ground
 Input_9_M_8
 Input_10_M_8
 Input_11_M_8
 Input_12_M_8
 Input_13_M_8
 input_14_M_8
 Input_15_M_8
 Input_16_M_8
 ground
 Output_9_M_8
 Output_10_M_8
 Output_11_M_8
 Output_12_M_8
 Output_13_M_8
 Output_14_M_8
 Output_15_M_8
 Output_16_M_8

P = + / M = -

Figure 96 – DBS connections, assignment of access points (3)

3.4.3.2 – Connections to 75 ohm coaxial distributors

Connections are made beneath the roof of the standard rack or on the front panel for a different type of rack.

Optional cables and distributors are in the installation set.

1.6 / 5.6, 75 ohm distributor for 16 E1 / T1, ref: 3CC08061AAxx.

- One distributor per TNT board.
- TNT connectors (J105 to J112) connected to the top panel of the DBS subrack with (n) 3CC11236AAxx cable(s).

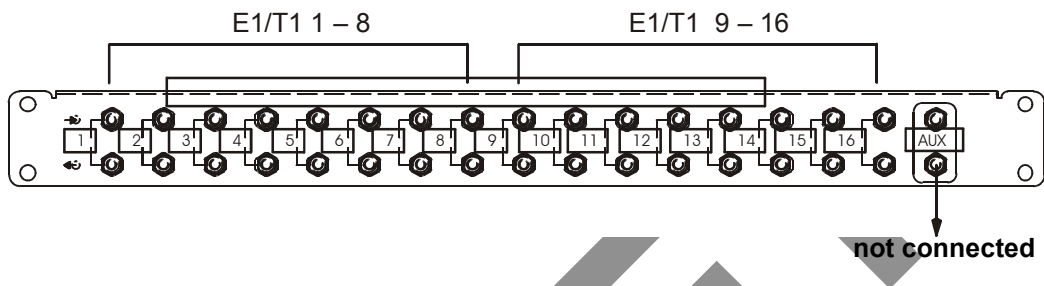

Figure 97 – 1.6/5.6, 75 ohm distributor

75 ohm BNC distributor for 16 E1 / T1 ref.: 3CC08061ABxx.

- One distributor per TNT board.
- TNT connectors (J105 to J112) connected to the top panel of the DBS subrack with (n) 3CC11237AAxx cable(s).

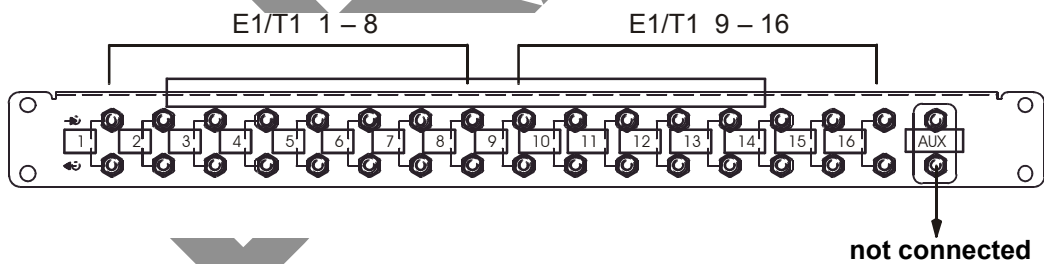

Figure 98 – BNC 75 ohm distributor