

## CT9077W2

### 7" Tablet



Scan for more user manual details

It's important to read this instruction prior to using your new product for the first time.

## SAFETY PRECAUTIONS



Equipment tested for compliance as a complete unit

This device complies with Part 15 of the FCC Rules. Operation is subject to the following two conditions: (1) This device may not cause harmful interference, and (2) this device must accept any interference received, including interference that may cause undesired operation.

This equipment has been tested and found to comply with the limits for a Class B digital device, pursuant to Part 15 of FCC Rules. These limits are designed to provide reasonable protection against harmful interference in a residential installation. This equipment generates, uses, and can radiate radio frequency energy and, if not installed and used in accordance with the instructions, may cause harmful interference to radio communications.

However, there is no guarantee that interference will not occur in a particular installation. If this equipment does cause harmful interference to radio or television reception, which can be determined by turning the equipment off and on, the user is encouraged to try to correct the interference by one or more of the following measures:

- Reorient or relocate the receiving antenna.
- Increase the separation between the equipment and receiver.
- Connect the equipment into an outlet on a circuit different from that to which the receiver is connected.
- Consult the dealer or an experienced radio/TV technician for help.

**Warning:** Changes or modifications not expressly approved by the party responsible for compliance (MLB International Inc., P.O. Box 1535, Buffalo, NY 14226, Tel: 516-236-4556) could void the user's authority to operate the equipment.

**Caution:** Use of controls or adjustments or performance of procedures other than those specified may result in hazardous radiation exposure.

**Warning:** The AC/DC adaptor is used as disconnect device.

The AC/DC adaptor of apparatus should not be obstructed OR should be easily accessed during intended use. To be completely disconnect the power input, the AC/DC adaptor of apparatus shall be disconnected from the mains.

### Trademark Information

Google Play, YouTube and other marks are trademarks of Google Inc.

The Android robot is reproduced or modified from work created and shared by Google and used according to terms described in the Creative Commons 3.0 Attribution License.

The Wi-Fi CERTIFIED Logo is a certification mark of the Wi-Fi Alliance. The Wi-Fi Protected Setup Mark is a mark of the Wi-Fi Alliance.

### For Your Safety

The AC power plug is polarized and only fits into AC power outlets one way. If the plug won't go into the outlet completely, turn the plug over and try to insert it the other way. If it still won't fit, contact a qualified electrician to change the outlet, or use a different one. Do not attempt to bypass this safety feature.

### Service Information

This product should be serviced only by those specially trained in appropriate servicing techniques. For instructions on how to obtain service, refer to the warranty included in this guide.

# IMPORTANT SAFETY INSTRUCTIONS

## PLEASE READ AND SAVE THIS FOR FUTURE REFERENCE



Some of the following information may not apply to your particular product; however, as with any electronic product, precautions should be observed during handling and use.

- Read these instructions.
- Keep these instructions.
- Heed all warnings.
- Follow all instructions.
- Do not use this apparatus near water.
- Clean only with dry cloth.
- Do not block any ventilation openings. Install in accordance with the manufacturer's instructions.
- Do not install near any heat sources such as radiators, heat registers, stoves, or other apparatus (including amplifiers) that produce heat.
- The AC power plug is polarized and only fits into AC power outlets one way. If the plug won't go into the outlet completely, turn the plug over and try to insert it the other way. If it still won't fit, contact a qualified electrician to change the outlet, or use a different one. Do not attempt to bypass this safety feature.
- Protect the power cord from being walked on or pinched particularly at plugs, convenience receptacles, and the point where they exit from the apparatus.
- Only use attachments / accessories specified by the manufacturer.
- Unplug this apparatus during lightning storms or when unused for long periods of time.
- Refer all servicing to qualified service personnel. Servicing is required when the apparatus has been damaged in any way, such as power-supply cord or plug is damaged, liquid has been spilled or objects have fallen into the apparatus, the apparatus has been exposed to rain or moisture, does not operate normally, or has been dropped.

## ADDITIONAL SAFETY INFORMATION

- The AC/DC adaptor and apparatus shall not be exposed to dripping or splashing and no objects filled with liquids, such as vases, shall be placed on the apparatus.
- Always leave sufficient space around the product for ventilation. Do not place product in or on a bed, rug, in a bookcase or cabinet that may prevent air flow through vent openings.
- Do not place lighted candles, cigarettes, cigars, etc. on the product.
- Connect power cord only to AC power source as marked on the product.
- Care should be taken so that objects do not fall into the product.
- Do not attempt to disassemble the cabinet. This product does not contain customer serviceable components.
- To reduce the risk of fire or electric shock, do not expose this apparatus to rain or moisture.
- Do not play your headset at high volume. Hearing experts warn against extended high-volume play.

## Switch On/Unlock

Switch on and unlock: When the device is in the OFF mode, press and hold "POWER" key to enter the startup screen, then the screen is in locked mode. And press and pull the  icon to the unlocked position (the  icon appears), then the screen will unlock.

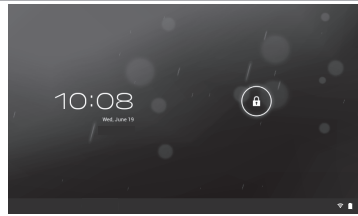

## Power Save Mode/Lock Screen/Switch OFF

Press the "POWER" key shortly after starting up, the unit will enter power save and locked mode.

Switch OFF: When the device is in Home menu, press and hold the "POWER" key for about 2 seconds, and the screen will display the Power off interface, choose the "OK" to confirm, the system will shut down.

**Note:** When the device has low battery, it will alarm continuously and shut down automatically if the device is not being charged and the device cannot start up. Please check if the battery is low, and try it again after the battery is charged.

## Battery Management and Charging

Charge the battery for about 4 hours to make sure the battery is fully charged before the first time of use.

Insert the micro port of the battery adapter into DC slot on the device, and connect the other side with the power socket. The desktop icon of the battery will keep rolling, which shows it is charging, please wait until the battery is fully charged, and do not disconnect the power while charging. Once the battery is fully charged, the fully charged icon  on the desktop will appear. When the battery is exhausted completely, please charge at least one minute before starting up.

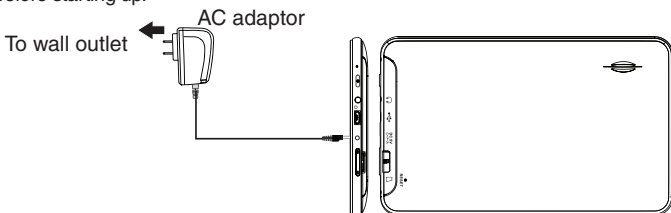







**Note:** In order to keep the battery working in best condition, please pay attention to the following:

- Please do not charge the battery in high temperatures.
- Do not wait for the batter to be fully depleted before charging again. Keep the battery charged as needed.
- The included AC adaptor is for use with this unit only. Do not use it with other equipment.

## Operation of the Function Icons

### Function Icon Definitions:

Icon	Function Instruction	Icon	Function Instruction
	Back to Home menu		Note when connect with PC via USB.
	Show current power status		App menu
	Return		Open the list of apps that you have used recently.

### Overview of Controls

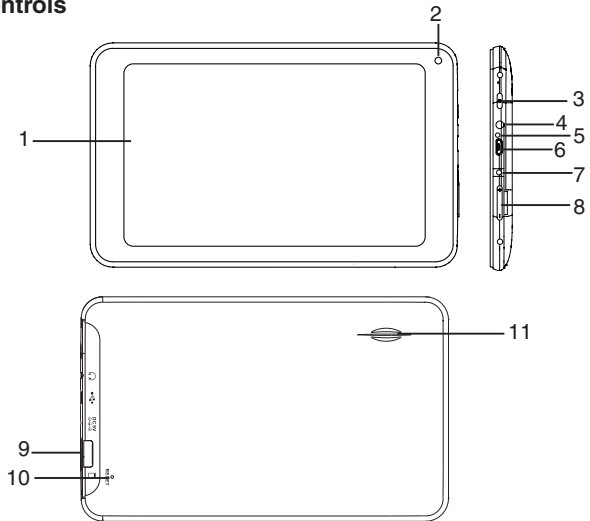

1. **Display**
2. **Front Camera**
3. **POWER Button:** Press the button shortly to enter standby/wake up mode, press for a few seconds to switch On/Off the unit.
4. **Earphone Jack:** Stereo earpiece jack.
5. **Microphone Jack**
6. **USB Slot:** MINI USB Port, connect to a PC.
7. **DC Socket:** Connect with 5V DC charger.
8. **Volume+/- Key:** Press to adjust the volume.
9. **Card Slot:** TF card slot (Micro SD Card Slot).
10. **Reset**
11. **Speaker**

## Connecting to Wireless Networks

### Wi-Fi

**Turn on the Wi-Fi:** Tap the App menu  to enter, then tap “Settings” to enter the setting interface. Under **WIRELESS & NETWORKS** make sure slide the option to **ON**.

**Connect to a network:** If the Wi-Fi is set to ON, the system will find the available Wi-Fi automatically. Please refer to the right picture, the available Wi-Fi will be shown on the right, then you can select an available one to connect(if required, you need input password).

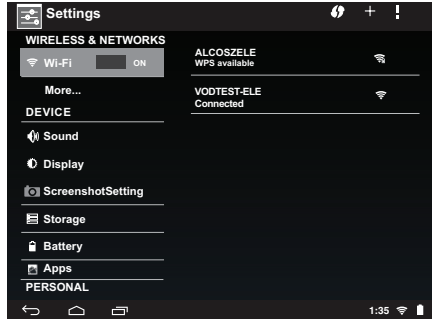

You can see the network connection status when you press the network name. There will be a Wi-Fi icon  to showing the level of signal.

### VPN Virtual Private Network

You can create virtual private network (VPN) and connect to your private network securely through a public network, such as the internet. You must set a lock screen PIN or password before you can use credential storage.

Add VPN network and follow the instructions on the screen.

## USB Function

### Read USB

Insert the USB into the Mini USB port and press the **Explorer** in the App menu, maybe you will need an additional adapter cable to connect between the USB and the device, press “USB” and enter USB.

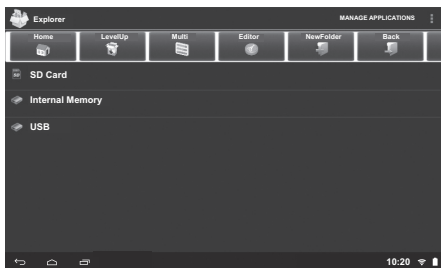

## App Menu

App icons are shortcuts placed on the screen and used to open applications installed on your tablet.

To see all apps, touch the Apps menu icon.

To open an app, touch the icon.

### Camera Function

You can use camera to take videos, pictures.

Select the **Camera** icon to use the functionality.

### Multimedia Music /Video

In the App menu tap the  icon to play audio. When no music files are in the playlists, the system will automatically load the music files from the card to the playlists after turning on the unit (the device supports the following audio file format: MP3, WAV, AAC, OGG & WMA).

If two or more songs are in the music play list area, slide up/down on the touch screen to go page up/down.

Tap video icon to play video.

**Note:** Audio player can play WAV recorded files.

### Photos

In the App menu, tap the picture browsing icon: 



## Photo Browser Button Descriptions

Add Pictures (This device supports BMP, JPEG, PNG & GIF format). Open the corresponding folder to find the image file and add the picture you want. Tap the photo setting, and the photo can be set as your wallpaper:

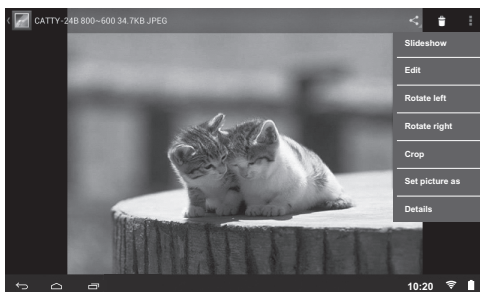

## Explorer

In the App menu, tap the **Explorer** icon to enter the Management Interface, you can copy, delete, move, rename etc. file or folder.

For example, to copy a file, select the file, then press and hold it. A operation menu will appear, and select "Copy", then enter the folder you want to paste. Tap Editor in the top of Management Interface, a operation menu will appear, select "Paste" to paste.

To store additional files, you must insert a memory card. Your device accepts micro SD™ or micro SDHC™ memory cards with maximum capacities of 32 GB (depending on memory card manufacturer and type).

## App Menu (Network Applications)

### Email

When Wi-Fi connection is in normal (for details refer to the Wi-Fi setting section), tap the **Email** icon in App menu to enter Email and you can send or receive Email.

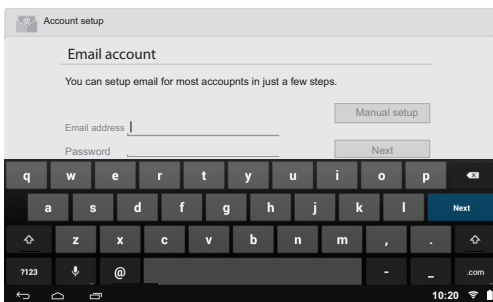

### Google

When the Wi-Fi connection is in normal (for details refer to the Wi-Fi setting section), tap the **Google Search™** icon to enter the interface, and click the address bar and input the website and click "Go" to enter a corresponding website.

**Note:** The Explorer uses the popular third-party explorer software, please follow the explorer's standard operating mode to operate.



**Note:** Other items like YouTube™, Google Maps™ etc., you can tap the relevant icon to enter, and then follow the on-screen instructions and apply them.

## Download apps on Google Play™

The Play Store provides many apps that you can download and install in your tablet.

1. On the App menu, touch the **Play Store** icon.
2. To search for an app, touch the **Google Search**™ icon, and then type a keyword to search.
3. Touch an available app to select it and then touch **Install** to download and install the app.

## App Menu (Other Function)

### Using the Calendar

1. Tap the **App menu** icon, and then tap the **Calendar** icon.
2. To add the Calendar to the Home screen, tap and hold the Calendar icon until it appears on the Home screen.
3. To access the calendar, tap the **Calendar** icon, and then follow the on-screen instructions.

**Note:** for other apps, please refer to the Calendar and follow the on-screen instructions.

### Settings

#### WIRELESS & NETWORKS

**Wi-Fi**—Enable or disable **Wi-Fi**, and connect to a wireless network so that you can check email, search the Web, or access social media websites.

More...—Enable or disable **VPN**.

#### DEVICE

**Sound**—Set **Volumes**, **Default notification**, and enable or disable **Touch sounds** and **Screen lock sound**.

**Display**—Set **Brightness**, **Wallpaper**, **Sleep** and **Font size**.

**ScreenshotSetting**—Set **Select delay time to capture the screen**, **Set the location of screenshot storage** and enable or disable **Show the screenshot button in the statusbar**.

**Storage**—View available space in **INTERNAL STORAGE**, **NAND FLASH**, **SD CARD** and **USB STORAGE** /set the related items.

**Battery**—View battery status.

**Apps**—View downloaded apps and running apps. To view information or uninstall an app, tap the relevant app.

## **PERSONAL**

**Location services**—Enable or disable **Google's location service**, **Location & Google search**.

**Security**—Set preferences for **SCREEN SECURITY**, **PASSWORDS**, **DEVICE ADMINISTRATION**, and **CREDENTIAL STORAGE**.

**Language & input**—Set preferences for **Language**, **KEYBOARD & INPUT METHODS**, **SPEECH**, and **MOUSE/TRACKPAD**.

**Backup & reset**—Set preferences for **BACKUP & RESTORE**, and **PERSONAL DATA**.

## **ACCOUNTS**

You can add an email account or another type of account.

## **SYSTEM**

**Date & time**—Enable or disable **Automatic date & time**, and select preferences for date, time, time zone, time format, and date format.

**Accessibility**—Select preferences for **SERVICE** and **SYSTEM**.

**Developer options**—Enable or disable various **Developer options**.

### **About tablet**

Check System updates, Status, Legal information etc.

## **Desktop Function Icon Settings**

### **Add, Move or Delete Desktop Icon**

Tap the  icon in home menu to enter App menu, then display the whole application icons by page.

To add an app to the Home menu, touch and hold the app until the Home menu appears, and then slide it to the location where you want it to be.

To remove an app from the Home menu, touch and hold the app, and then drag it to the "X Remove" icon at the top of the screen.

## **PC Connectivity**

Connect your device to a PC with a USB cable in various USB connection modes. By connecting the device to a PC, you can transfer files or transfer data to or from your device directly.

**Note:** When you copy file into tablet from your PC, you should set the **Storage** to "Mass Storage" in **Setting**.