



AT-TQ4600

Enterprise-class Wireless Access Point
with IEEE802.11a/b/g/n/ac Dual Radio



Installation Guide

Copyright © 2014 Allied Telesis, Inc.

All rights reserved.

This product includes software licensed under the BSD License. As such, the following language applies for those portions of the software licensed under the BSD License:

Redistribution and use in source and binary forms, with or without modification, are permitted provided that the following conditions are met:

- * Redistributions of source code must retain the above copyright notice, this list of conditions and the following disclaimer.
- * Redistributions in binary form must reproduce the above copyright notice, this list of conditions and the following disclaimer in the documentation and/or other materials provided with the distribution.
- * Neither the name of Allied Telesis, Inc. nor the names of the respective companies above may be used to endorse or promote products derived from this software without specific prior written permission.

THIS SOFTWARE IS PROVIDED BY THE COPYRIGHT HOLDERS AND CONTRIBUTORS "AS IS" AND ANY EXPRESS OR IMPLIED WARRANTIES, INCLUDING, BUT NOT LIMITED TO, THE IMPLIED WARRANTIES OF MERCHANTABILITY AND FITNESS FOR A PARTICULAR PURPOSE ARE DISCLAIMED. IN NO EVENT SHALL THE COPYRIGHT HOLDER OR CONTRIBUTORS BE LIABLE FOR ANY DIRECT, INDIRECT, INCIDENTAL, SPECIAL, EXEMPLARY, OR CONSEQUENTIAL DAMAGES (INCLUDING, BUT NOT LIMITED TO, PROCUREMENT OF SUBSTITUTE GOODS OR SERVICES; LOSS OF USE, DATA, OR PROFITS; OR BUSINESS INTERRUPTION) HOWEVER CAUSED AND ON ANY THEORY OF LIABILITY, WHETHER IN CONTRACT, STRICT LIABILITY, OR TORT (INCLUDING NEGLIGENCE OR OTHERWISE) ARISING IN ANY WAY OUT OF THE USE OF THIS SOFTWARE, EVEN IF ADVISED OF THE POSSIBILITY OF SUCH DAMAGE.

Copyright (c) [dates as appropriate to package] by The Regents of the University of California - All rights reserved.

Copyright (c) 2000-2003 by Intel Corporation - All rights reserved. Copyright (c) 1997-2003, 2004 by Thomas E. Dickey <dickey@invisible-island.net> - All rights reserved. Copyright (c) 2001-2009 by Brandon Long (ClearSilver is now licensed under the New BSD License.) Copyright (c) 1984-2000 by Carnegie Mellon University - All rights reserved.

Copyright (c) 2002,2003 by Matt Johnston - All rights reserved. Copyright (c) 1995 by Tatu Ylonen <ylo@cs.hut.fi> - All rights reserved. Copyright 1997-2003 by Simon Tatham. Portions copyright by Robert de Bath, Joris van Rantwijk, Delian Delchev, Andreas Schultz, Jeroen Massar, Wez Furlong, Nicolas Barry, Justin Bradford, and CORE SDI S.A.

Copyright (c) 1989, 1991 by Free Software Foundation, Inc. (GNU General Public License, Version 2, June 1991).

Copyright (c) 2002-2005 by Jouni Malinen <jkmaline@cc.hut.fi> and contributors. Copyright (c) 1991, 1999 by Free Software Foundation, Inc. (GNU Lesser General Public License, Version 2.1, February 1999). Copyright (c) 1998-2002 by Daniel Veillard - All rights reserved. Copyright (c) 1998-2004 by The OpenSSL Project - All rights reserved.

Copyright (c) 1995-1998 by Eric Young (eay@cryptsoft.com) - All rights reserved.

This product also includes software licensed under the GNU General Public License available from:

<http://www.gnu.org/licenses/gpl2.html>

Allied Telesis is committed to meeting the requirements of the open source licenses including the GNU General Public License (GPL) and will make all required source code available.

If you would like a copy of the GPL source code contained in this product, please send us a request by registered mail including a check for US\$15 to cover production and shipping costs, and a CD with the GPL code will be mailed to you.

GPL Code Request

Allied Telesis Labs (Ltd)

PO Box 8011

Christchurch, New Zealand

No part of this publication may be reproduced without prior written permission from Allied Telesis, Inc.

Allied Telesis and the Allied Telesis logo are trademarks of Allied Telesis, Incorporated. All other product names, company names, logos or other designations mentioned herein are trademarks or registered trademarks of their respective owners.

Allied Telesis, Inc. reserves the right to make changes in specifications and other information contained in this document without prior written notice. The information provided herein is subject to change without notice. In no event shall Allied Telesis, Inc. be liable for any incidental, special, indirect, or consequential damages whatsoever, including but not limited to lost profits, arising out of or related to this manual or the information contained herein, even if Allied Telesis, Inc. has been advised of, known, or should have known, the possibility of such damages.

Electrical Safety and Emissions Standards

This product meets the following standards.

Federal Communications Commission Interference Statement

Declaration of Conformity

Manufacturer Name: Allied Telesis, Inc.

Declares that the product: **Wireless access point with PoE powered device function**

Model Number: **AT-TQ4600**

This device complies with Part 15 of the FCC Rules. Operation is subject to the following two conditions: (1) This device may not cause harmful interference, and (2) this device must accept any interference received, including interference that may cause undesired operation.

This equipment has been tested and found to comply with the limits for a Class B digital device, pursuant to Part 15 of the FCC Rules. These limits are designed to provide reasonable protection against harmful interference in a residential installation. This equipment generates, uses and can radiate radio frequency energy and, if not installed and used in accordance with the instructions, may cause harmful interference to radio communications. However, there is no guarantee that interference will not occur in a particular installation. If this equipment does cause harmful interference to radio or television reception, which can be determined by turning the equipment off and on, the user is encouraged to try to correct the interference by one of the following measures:

- Reorient or relocate the receiving antenna.
- Increase the separation between the equipment and receiver.
- Connect the equipment into an outlet on a circuit different from that to which the receiver is connected.
- Consult the dealer or an experienced radio/TV technician for help.

FCC Caution: Any changes or modifications not expressly approved by the party responsible for compliance could void the user's authority to operate this equipment.

This transmitter must not be co-located or operating in conjunction with any other antenna or transmitter.

Radiation Exposure Statement:

This equipment complies with FCC radiation exposure limits set forth for an uncontrolled environment. This equipment should be installed and operated with minimum distance 20cm between the radiator & your body.

European Union Restriction of the Use of Certain Hazardous Substances (RoHS) in Electrical and Electronic Equipment

This Allied Telesis RoHS-compliant product conforms to the European Union Restriction of the Use of Certain Hazardous Substances (RoHS) in Electrical and Electronic Equipment. Allied Telesis ensures RoHS conformance by requiring supplier Declarations of Conformity, monitoring incoming materials, and maintaining manufacturing process controls.

Note

For additional regulatory statements, refer to Appendix B, "Regulatory Statements" on page 51.

Safety and Electromagnetic Emissions Certificates

| | |
|-------------------------------------|--|
| Standard Compliance | RoHS compliant European Union RoHS (Directive 2011/65/EU of the European Parliament and of the Council of 8 June 2011 on the restriction of the use of certain hazardous substances in electrical and electronic equipment.) |
| Certificates | CE EAC FCC/IC KC RCM Wi-Fi CERTIFIED |
| Electromagnetic Compatibility (EMC) | EN 301 489-1 EN 301 489-17 EN 55022 EN 55024 EN 61000-3-2 EN 61000-3-3 EN 61000-4-2 EN 61000-4-3 EN 61000-4-4 EN 61000-4-5 EN 61000-4-6 EN 61000-4-11 AS/NZS CISPR 22 FCC 47 CFR Part 15, Subpart B ICES-003 |
| Medical (EMC) | EN 60601-1-2 |

| | |
|-----------------|---|
| Radio Equipment | EN 300 328 EN 301 893 AS/NZS 4268 FCC 47 CFR Part 15, Subpart C FCC 47 CFR Part 15, Subpart E FCC part 2 RSS210 RSS-Gen RSS-102 |
| Safety | EN 60950-1 IEC 60950-1 TUV-T UL 60950-1 |

Translated Safety Statements

Important: The  indicates that a translation of the safety statement is available in a PDF document titled "Translated Safety Statements" on the Allied Telesis website at <http://www.alliedtelesis.com/support>.

Contents

| | |
|--|-----------|
| Preface | 13 |
| Safety Symbols Used in this Document | 14 |
| Contacting Allied Telesis | 15 |
| Chapter 1: Overview | 17 |
| Features | 18 |
| Rear Panel Components | 19 |
| LAN Port | 21 |
| Power over Ethernet | 21 |
| Connector Type | 21 |
| Speed | 21 |
| Duplex Mode | 21 |
| Maximum Distance | 21 |
| Cable Requirements | 21 |
| Automatic MDIX Detection | 22 |
| Port Pinouts | 22 |
| LEDs | 23 |
| Reset Button | 24 |
| Chapter 2: Installing the Access Point | 25 |
| Reviewing Safety Precautions | 26 |
| Unpacking the AT-TQ4600 Access Point | 28 |
| Installing the Access Point on a Table | 29 |
| Installing the Access Point on a Wall or Ceiling | 33 |
| Guidelines | 33 |
| Attaching the Mounting Bracket to the Access Point | 34 |
| Installing the Access Point to a Wall or Ceiling | 35 |
| Cabling the Access Point | 36 |
| Kensington Lock | 37 |
| Starting the Initial Management Session on the Access Point | 38 |
| Starting the Initial Management Session with a Direct Connection | 39 |
| Starting the Initial Management Session without a DHCP Server | 40 |
| Starting the Initial Management Session with a DHCP Server | 40 |
| Setting the Country Setting | 42 |
| Appendix A: Technical Specifications | 45 |
| Physical Specifications | 45 |
| Environmental Specifications | 45 |
| Power Specifications | 46 |
| LAN Port | 47 |
| Safety and Electromagnetic Emissions Certifications | 49 |
| Appendix B: Regulatory Statements | 51 |
| Federal Communication Commission Interference Statement | 52 |
| Industry Canada Statement | 54 |
| Europe - EU Declaration of Conformity | 56 |

Figures

| | |
|--|----|
| Figure 1: Rear Panel Components | 19 |
| Figure 2: AT-TQ0091 AC/DC Power Adapter | 28 |
| Figure 3: Installing the Rubber Feet | 29 |
| Figure 4: Connecting the Network Cable for Table or Desktop Installation | 30 |
| Figure 5: Connecting the Power Cable from the AT-TQ0091 AC/DC Adapter | 31 |
| Figure 6: Removing an AC Plug from the AT-TQ0091 AC/DC Power Adapter | 31 |
| Figure 7: Installing an AC Plug on the AT-TQ0091 AC/DC Power Adapter | 32 |
| Figure 8: Ventilation Slots | 33 |
| Figure 9: Inserting the Mounting Bracket | 34 |
| Figure 10: Attaching the Mounting-Bracket Screw | 35 |
| Figure 11: Kensington Lock | 37 |
| Figure 12: Logon Window | 39 |
| Figure 13: Modify Wireless Settings Window | 42 |
| Figure 14: Pin Layout for the RJ-45 Connector on the LAN Port | 47 |

Tables

| | |
|---|----|
| Table 1. Components on the Rear Panel | 19 |
| Table 2. Twisted Pair Cable for the LAN Port | 22 |
| Table 3. LEDs on the AT-TQ4600 Access Point | 23 |
| Table 4. AT-TQ4600 Physical Specifications | 45 |
| Table 5. Environmental Specifications | 45 |
| Table 6. AT-TQ4600 Maximum Power Consumption | 46 |
| Table 7. AT-TQ0091 Power Adapter | 46 |
| Table 8. LAN Port Specifications | 47 |
| Table 9. MDI Pin Signals (10Base-T or 100Base-TX) | 47 |
| Table 10. MDI-X Pin Signals (10Base-T or 100Base-TX) | 48 |
| Table 11. 1000Base-T Connector Pinouts | 48 |
| Table 12. Safety and Electromagnetic Emissions Certificates | 49 |

Preface

This guide contains the hardware installation instructions for the AT-TQ4600 Wireless Access Point. This preface contains the following sections:

- “Safety Symbols Used in this Document” on page 14
- “Contacting Allied Telesis” on page 15

Safety Symbols Used in this Document

This document uses the following conventions.

Note

Notes provide additional information.



Caution

Cautions inform you that performing or omitting a specific action may result in equipment damage or loss of data.



Warning

Warnings inform you that performing or omitting a specific action may result in bodily injury.

Contacting Allied Telesis

If you need assistance with this product, you may contact Allied Telesis technical support by going to the Support & Services section of the Allied Telesis web site at **www.alliedtelesis.com/support**. You can find links for the following services on this page:

- ❑ 24/7 Online Support — Enter our interactive support center to search for answers to your product questions in our knowledge database, check support tickets, learn about Return Merchandise Authorizations (RMAs), and contact Allied Telesis technical experts.
- ❑ USA and EMEA phone support — Select the phone number that best fits your location and customer type.
- ❑ Hardware warranty information — Learn about Allied Telesis warranties and register your product online.
- ❑ Replacement Services — Submit an RMA request via our interactive support center.
- ❑ Documentation — View the most recent installation and user guides, software release notes, white papers, and data sheets for your products.
- ❑ Software Downloads — Download the latest software releases for your managed products.

For sales or corporate information, go to **www.alliedtelesis.com/purchase**.

Chapter 1

Overview

This chapter describes the hardware components of the AT-TQ4600 Wireless Access Point. This chapter contains the following sections:

- ❑ “Features” on page 18
- ❑ “Rear Panel Components” on page 19
- ❑ “LAN Port” on page 21
- ❑ “LEDs” on page 23
- ❑ “Reset Button” on page 24

Features

The main features of the product are listed here:

- Dual radio: 2.4 GHz and 5 GHz
- IEEE 802.11a/b/g/n/ac
- 3x3:3ss MIMO with internal omni antennas
- Maximum capacity 2.4 GHz: 450 Mbps
- Maximum capacity 5 GHz: 1300 Mbps
- Wireless Distribution System (WDS) bridges
- Access point clustering
- Rogue access point detection
- Multiple SSIDs
- One 10/100/1000Base-T Ethernet port with Auto-Negotiation, auto MDI/MDIX, and IEEE 802.3at Power over Ethernet (PoE)
- IEEE 802.3 (10Base-T), IEEE 802.3u (100Base-TX), and IEEE 802.3ab (1000Base-T) compliance on the Ethernet port
- MAC address filtering for wireless access security
- Broadcast and multicast rate limiting
- Virtual access points for multiple broadcast domains
- DHCP client
- RADIUS accounting with external RADIUS server
- Network Time Protocol (NTP) client
- Domain name server (DNS) client
- IEEE 802.1x authentication
- WPA-Personal and WPA-Enterprise with WPA, WPA2, TKIP, and CCMP (AES) authentication and encryption
- Static WEP encryption
- HTTP and HTTPS web browser management
- SNMPv1 and v2c management
- Quality of Service
- Event log
- Syslog client
- Table, wall, or ceiling installation

Rear Panel Components

The rear panel components of the AT-TQ4600 Access Point are illustrated in Figure 1.

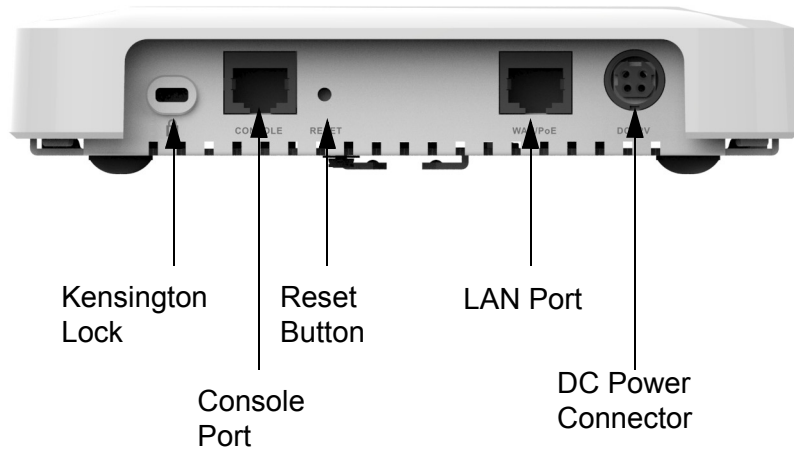

Figure 1. Rear Panel Components

The components are listed in Table 1.

Table 1. Components on the Rear Panel

| Field | Description |
|-----------------|--|
| Kensington Lock | Lock to secure the access point. For information, refer to “Kensington Lock” on page 37. |
| Console Port | The Console port is for manufacturing purposes only. |
| Reset Button | The Reset button returns the parameter settings on the access point to their default settings. For information, refer to “Reset Button” on page 24. |
| LAN Port | The LAN port connects the access point to your wired network. It supports PoE. If you connect the port to an Ethernet switch that supports PoE, you do not have to use the AC/DC adapter to power the device. For information, refer to “LAN Port” on page 21. |

Table 1. Components on the Rear Panel (Continued)

| Field | Description |
|--------------------|---|
| DC Power Connector | This connector is for the AT-TQ0091 Power Adapter. The access point can be powered with PoE on the LAN port or the power adapter. The AT-TQ0091 Power Adapter does not come with the access point. It must be ordered separately from Allied Telesis. |

LAN Port

The LAN port is used to connect the device to your Local Area Network (LAN), typically through an Ethernet switch.

Power over Ethernet

The AT-TQ4600 Access Point supports Power over Ethernet (PoE) on the LAN port. The unit is a PoE class 4 powered device with a maximum power consumption of 16 watts. When the port is connected to a PoE Ethernet switch, the unit receives its power over the network cable that carries the network traffic. If you use the PoE feature, you do not need to use the AC/DC power adapter that has to be purchased separately.

Connector Type

The LAN port has an 8-pin RJ-45 connector. The port uses four pins at 10 or 100 Mbps and all eight pins at 1000 Mbps. The pin assignments are listed in “LAN Port” on page 47.

Speed

The LAN port can operate at 10, 100, or 1000 Mbps. The speed is set automatically with Auto-Negotiation. You cannot disable Auto-Negotiation on the port.

Note

The LAN port should be connected to a network device that also adjusts its speed with Auto-Negotiation. If the network device does not support Auto-Negotiation, the LAN port operates at 10 Mbps, which may reduce network performance.

Duplex Mode

The LAN port can operate in either half- or full-duplex mode at 10 or 100 Mbps, and full-duplex mode at 1000 Mbps. The port is IEEE 802.3u-compliant and uses Auto-Negotiation to set the duplex mode. (You cannot disable Auto-Negotiation on the port.)

Note

The LAN port should be connected to a network device that also sets its duplex mode with Auto-Negotiation. If the network device does not support Auto-Negotiation, the LAN port operates at half-duplex mode. This may result in a duplex mode mismatch if the network device is operating at full duplex.

Maximum Distance

The LAN port has a maximum operating distance of 100 meters (328 feet).

Cable Requirements

The cable requirements for the LAN port are listed in Table 2 on page 22.

Table 2. Twisted Pair Cable for the LAN Port

| Cable Type | 10Mbps | | 100Mbps | | 1000Mbps | |
|--|---------|-----|---------|-----|----------|-----|
| | Non-PoE | PoE | Non-PoE | PoE | Non-PoE | PoE |
| Standard TIA/EIA 568-B-compliant Category 3 shielded or unshielded cabling with 100 ohm impedance and 16 MHz frequency. | Yes | No | No | No | No | No |
| Standard TIA/EIA 568-A-compliant Category 5 shielded or unshielded cabling with 100 ohm impedance and 100 MHz frequency. | Yes | Yes | Yes | Yes | No | No |
| Standard TIA/EIA 568-B-compliant Enhanced Category 5 (Cat 5e) shielded or unshielded cabling with 100 ohm impedance and 100 MHz frequency. | Yes | Yes | Yes | Yes | Yes | Yes |
| Standard TIA/EIA 568-B-compliant Category 6 or 6a shielded cabling. | Yes | Yes | Yes | Yes | Yes | Yes |

Automatic MDIX Detection

The 10/100/1000 Mbps twisted-pair port is IEEE 802.3ab compliant and features automatic MDIX detection when operating at 10 or 100 Mbps. (Automatic MDIX detection does not apply to 1000 Mbps.) This feature automatically configures the port to MDI or MDI-X depending on the wiring configuration of the port on the Ethernet switch.

You may not disable automatic MDIX detection. For automatic MDIX detection to work properly, it must also be present on the Ethernet switch. The LAN port defaults to MDIX if it is connected to a network device that does not support automatic MDIX detection.

Port Pinouts

Refer to Table 9 on page 47 for the port pinouts of the LAN port when it is operating at 10 or 100 Mbps in the MDI configuration and Table 10 on page 48 for the MDI-X configuration. Refer to Table 11 on page 48 for the port pinouts when the port is operating at 1000 Mbps.

LEDs

The LEDs on the AT-TQ4600 Access Point are described in Table 3.

Table 3. LEDs on the AT-TQ4600 Access Point

| LED | State | Description |
|--------|----------------|---|
| PWR | Solid Green | The unit is receiving DC power that is within the normal operating range. |
| | Off | The power supply is not receiving power from either the AC/DC power adapter or a PoE Ethernet switch. |
| SYS | Solid Amber | The access point is loading its firmware or there is a system fault. |
| | Off | The unit is operating normally. |
| LAN | Solid Green | The Ethernet port is operating at 1000 Mbps. |
| | Flashing Green | The Ethernet port is operating at 1000 Mbps with link activity. |
| | Solid Amber | The Ethernet port is operating at 10/100 Mbps. |
| | Flashing Amber | The Ethernet port is operating at 10/100 Mbps with link activity. |
| 2.4GHz | Solid Green | The 2.4GHz radio is sending and receiving radio waves. |
| 5GHz | Solid Green | The 5GHz radio is sending and receiving radio waves. |

Note

You may turn off the LEDs with the management software.

Reset Button

The Reset button on the rear panel is used to return the parameter settings of the unit to their default values. You might use the button if you want to discard the current configuration of the device or because you forgot the password to the manager account and cannot manage the unit.

You may disable the button using the management software. If the unit is installed in a non-secure area, you might want to disable the button to prevent unauthorized individuals from pressing it and potentially disrupting the operations of your wireless network.

The Reset button is recessed to prevent it from being accidentally pressed. To press the button, use a pointed object, such as the end of a straightened paper clip. Hold the button for five seconds and release. The access point resets and loads its default configuration in a process that takes one minute to complete. In its default configuration, the access point attempts to contact a DHCP server from its LAN port for its IP address configuration. If it receives a response, it configures its IP address according to the settings from the DHCP server. If it does not receive a response, it uses the default address 192.168.1.230 and subnet mask 255.255.255.0. For instructions on how to start a management session when the access point is at its default configuration, refer to “Starting the Initial Management Session on the Access Point” on page 38.

Chapter 2

Installing the Access Point

This chapter describes how to install the AT-TQ4600 Wireless Access Point. This chapter contains the following sections:

- ❑ “Reviewing Safety Precautions” on page 26
- ❑ “Unpacking the AT-TQ4600 Access Point” on page 28
- ❑ “Installing the Access Point on a Table” on page 29
- ❑ “Installing the Access Point on a Wall or Ceiling” on page 33
- ❑ “Kensington Lock” on page 37
- ❑ “Starting the Initial Management Session on the Access Point” on page 38
- ❑ “Setting the Country Setting” on page 42

Note

The non-US model of this product has a country code setting that must be set during the initial management session of the unit. The setting ensures that the unit operates in compliance with the laws and regulations of your country or region.

For the US model, the country code is preset and cannot be changed. Per FCC regulations, the country code setting for all WiFi products marketed in the US must be fixed to US operational channels only.

Reviewing Safety Precautions

Please review the following safety precautions before you begin to install the access point.

Note

The  indicates that a translation of the safety statement is available in a PDF document titled “Translated Safety Statements” on the Allied Telesis website at <http://www.alliedtelesis.com/support>.



Warning

To prevent electric shock, do not remove the cover. No user-serviceable parts inside. This unit contains hazardous voltages and should only be opened by a trained and qualified technician. To avoid the possibility of electric shock, disconnect electric power to the product before connecting or disconnecting the LAN cables.  E1



Warning

Do not work on equipment or cables during periods of lightning activity.  E2



Warning

Power cord is used as a disconnection device. To de-energize equipment, disconnect the power cord.  E3

Note

Pluggable Equipment. The socket outlet shall be installed near the equipment and shall be easily accessible.  E5



Caution

Air vents must not be blocked and must have free access to the room ambient air for cooling.  E6

**Warning**

Operating Temperature. This product is designed for a maximum ambient temperature of 40°C with the AC/DC adapter or with Power over Ethernet.

**Warning**

To reduce the risk of electric shock, the PoE port on this product must not connect to cabling that is routed outside the building where this device is located. ⚡ E40

**Warning**

This equipment is intended for indoor use only.

Note

All Countries: Install product in accordance with local and National Electrical Codes. ⚡ E8

Note

This product is not approved for use in a computer room as defined in the Standard for Protection of Electronic Computer/Data Processing Equipment, ANSI/NFPA 75.

Note

If you are not using PoE to power to the unit, use only an approved AC/DC adapter.

Note

You should verify that your PoE network adheres to the standards of a separated extra-low voltage (SELV) circuit before using the PoE feature on the wireless access point.

Unpacking the AT-TQ4600 Access Point

As you unpack the access point, check the shipping container for the components the following items:

- ❑ One AT-TQ4600 Wireless Access Point
- ❑ One AT-TQ4600 Wireless Access Point Quick Install Guide
- ❑ Four rubber feet with one mounting-bracket screw
- ❑ One bracket for wall or ceiling mounting

If any item is missing or damaged, contact your Allied Telesis sales representative for assistance.

If you are not using the PoE feature on the LAN port of the access point to power the device, you need to separately order the AT-TQ0091 AC/DC Power Adapter. The adapter comes with four regional AC plugs. (One of the AC plugs comes pre-installed on the adapter.) Refer to Figure 2.

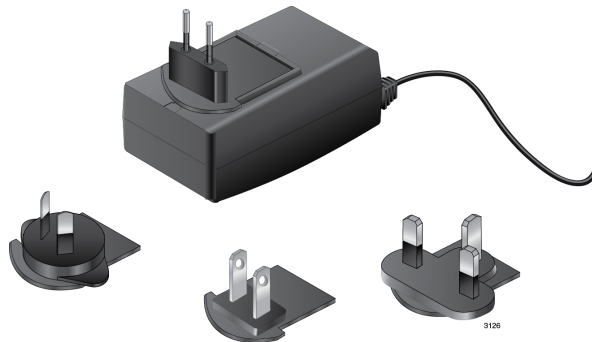

Figure 2. AT-TQ0091 AC/DC Power Adapter

Do one of the following:

- ❑ To install the unit on a table, go to “Installing the Access Point on a Table” on page 29.
- ❑ To install the unit on a wall or ceiling, go to “Installing the Access Point on a Wall or Ceiling” on page 33.

Installing the Access Point on a Table

To install the access point on a table, perform the following procedure:

1. Place the access point upside down on the table or desk selected for the device.
2. Install the rubber feet that come with the wireless access point by adhering the feet to the bottom panel. See Figure 3.

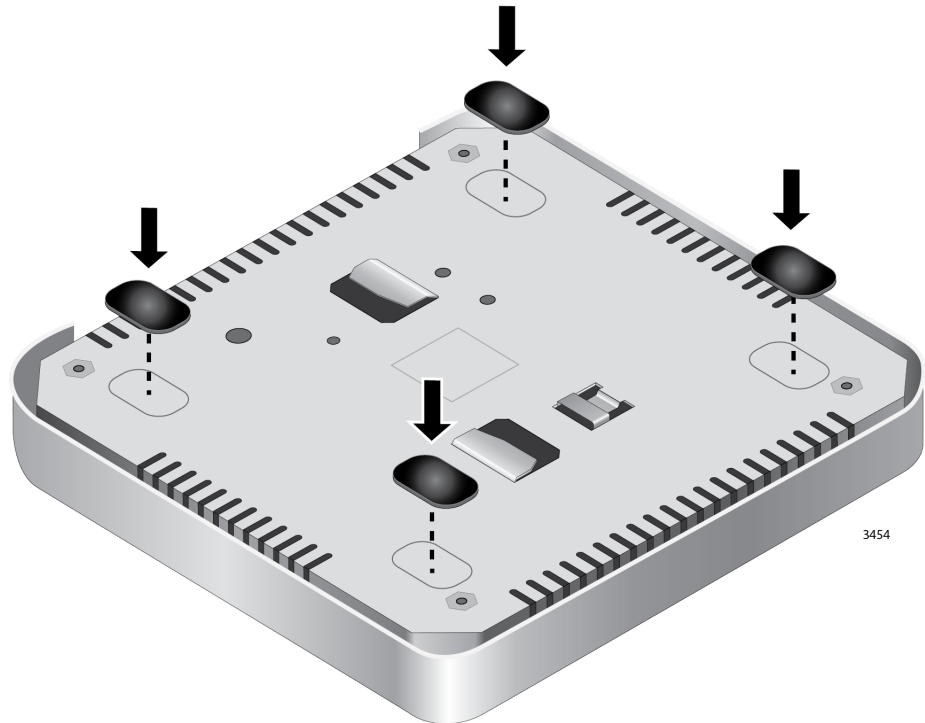

Figure 3. Installing the Rubber Feet

3. Turn the access point right side up on the table.
4. Connect a network cable to the LAN port (labeled WAN/PoE) on the rear panel of the access point. Refer to Figure 4 on page 30. The specifications of the cable are listed in Table 2 on page 22.



Figure 4. Connecting the Network Cable for Table or Desktop Installation

5. If you have not already done so, connect the other end of the network cable to a port on an Ethernet switch.
6. Do one of the following:
 - If the access point is to be powered with the AT-TQ0091 AC/DC Power Adapter, continue with this procedure to attach the power adapter.
 - If the access point is to be powered with the PoE feature on the LAN Port, the installation procedure is complete. Go to “Kensington Lock” on page 37 or “Starting the Initial Management Session on the Access Point” on page 38.
7. Connect the DC power cable from the AT-TQ0091 AC/DC Power Adapter to the DC 12V connector on the rear panel of the access point. Refer to Figure 5 on page 31.



Figure 5. Connecting the Power Cable from the AT-TQ0091 AC/DC Adapter

8. Check the AC plug on the AC/DC Power Adapter to see if it is the correct plug for your region. If it is not the correct plug, remove it by pushing down on the release tab and sliding it from the slot on the adapter. Refer to Figure 6.

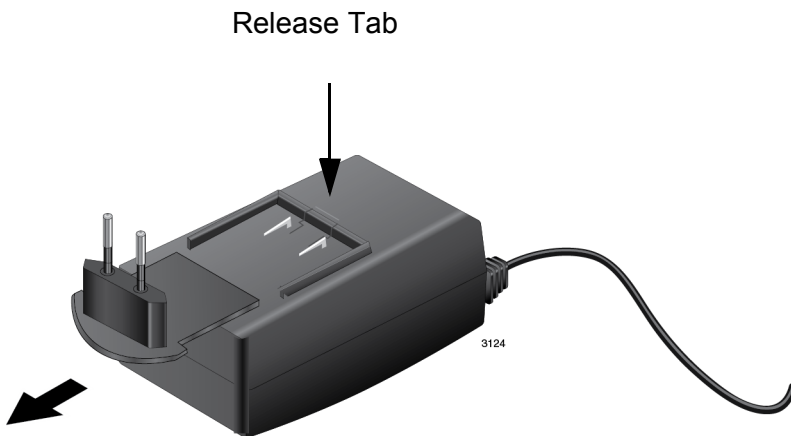

Figure 6. Removing an AC Plug from the AT-TQ0091 AC/DC Power Adapter

9. Slide the correct AC plug for your region into the slot on the adapter until it clicks into place. Refer to Figure 7 on page 32.



Figure 7. Installing an AC Plug on the AT-TQ0091 AC/DC Power Adapter

10. Connect the AC plug on the power cord to an appropriate AC power source. Refer to Table 7 on page 46 for the power specifications of the power adapter.

After installing the access point on the table or desk, go to “Kensington Lock” on page 37 or “Starting the Initial Management Session on the Access Point” on page 38.

Installing the Access Point on a Wall or Ceiling

This procedure contains the following sections.

- “Guidelines” on page 33
- “Attaching the Mounting Bracket to the Access Point” on page 34
- “Installing the Access Point to a Wall or Ceiling” on page 35
- “Cabling the Access Point” on page 36

Guidelines

Please review the following guidelines before installing the access point on a wall or ceiling:

- The selected location must not block the ventilation slots around the base of the unit. Refer to Figure 8.

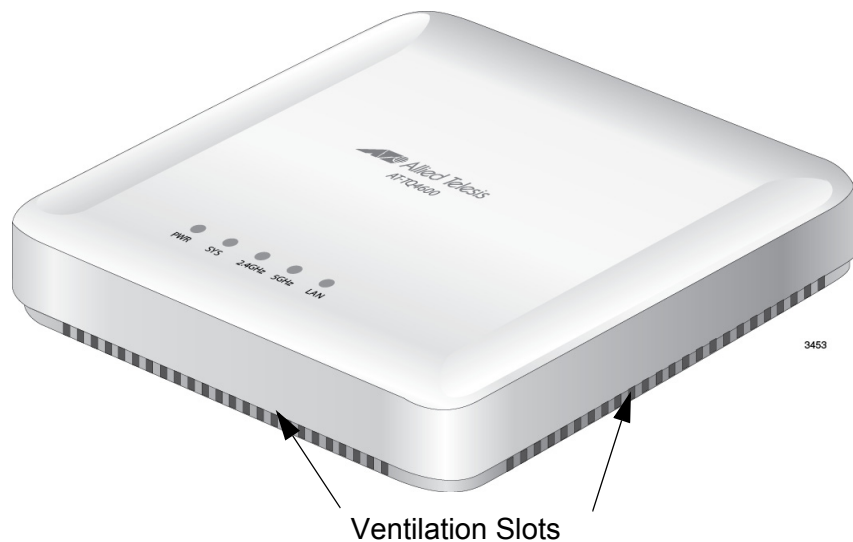

Figure 8. Ventilation Slots

- You should verify that the wall or ceiling material is strong enough to support the weight of the access point.
- One mounting-bracket screw is provided for attaching the mounting bracket to the unit. You must provide the two equipment rack screws that secure the bracket (through the bracket ears) to the wall or ceiling.
- The location must have an AC power source if you are using the AT-TQ0091 Power Adapter.

Attaching the Mounting Bracket to the Access Point

To attach the mounting bracket to the access point, perform the following:

1. Insert the mounting bracket under the clips on the bottom of the access point to lock the bracket in place, as shown in Figure 9.

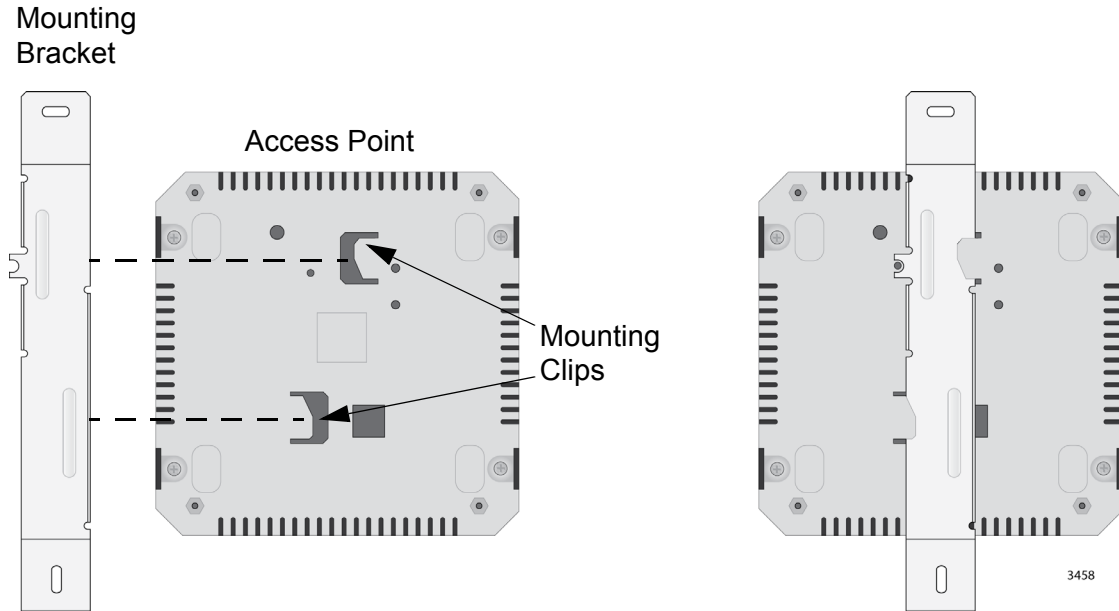

Figure 9. Inserting the Mounting Bracket

2. Attach the mounting-bracket screw through the cut-out in the mounting bracket to the bottom of the access point, as shown in Figure 10 on page 35.

Mounting-Bracket Screw

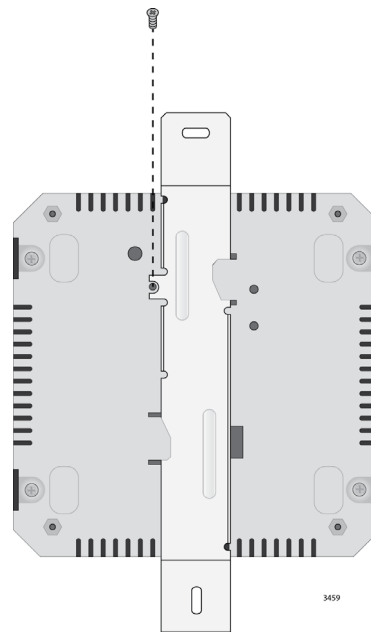

Figure 10. Attaching the Mounting-Bracket Screw

Installing the Access Point to a Wall or Ceiling

To attach the access point and mounting bracket to a wall or ceiling, perform the following:

Note

If you are using wall anchors, start with Step 1. If you are not using wall anchors, start with Step 4.

1. To install wall anchors, hold the access point at the selected wall or ceiling location, and with a pencil or pen, mark the locations of the two screw holes that are to be used to secure the access point through the two ears of the mounting bracket.
2. If necessary, pre-drill the holes for the anchors.
3. Install the wall anchors.
4. Have someone hold the bottom of the access point against the selected wall or ceiling location while you secure it to the wall or ceiling with two self-tapping screws (not provided with the access point).

**Cabling the
Access Point**

To install cabling on the access point, perform the following:

1. If the access point is to be powered with the AT-TQ0091 Power Adapter, connect the DC cable from the adapter to the DC 12V port on the access point. Refer to Figure 5 on page 31.
2. If you have not already done so, connect the network cable from the wireless access point to a port on an Ethernet switch.
3. Do one of the following:
 - ❑ If the access point is using PoE, the installation is complete. Go to “Kensington Lock” on page 37 or “Starting the Initial Management Session on the Access Point” on page 38.
 - ❑ If the access point is using the AT-TQ0091 AC/DC Power Adapter, perform the rest of this procedure to check and, if necessary, change the AC plug on the adapter.
4. Check the AC plug on the AT-TQ0091 AC/DC Power Adapter to see if it is the correct plug for your region. If it is not the correct plug, remove it by pushing down on the release tab and sliding it from the slot on the adapter. Refer to Figure 6 on page 31.
5. Slide the correct plug for your region into the slot on the adapter until it clicks into place. Refer to Figure 7 on page 32.
6. Connect the adapter to an appropriate AC power source. Refer to Table 7 on page 46 for the power specifications of the power adapter.

After installing the access point on a wall or ceiling, go to “Kensington Lock” on page 37 or “Starting the Initial Management Session on the Access Point” on page 38.

Kensington Lock

A Kensington lock can be used to secure the device when it is installed on a wall, ceiling, or table. The lock is located on the rear panel (see Figure 11.)

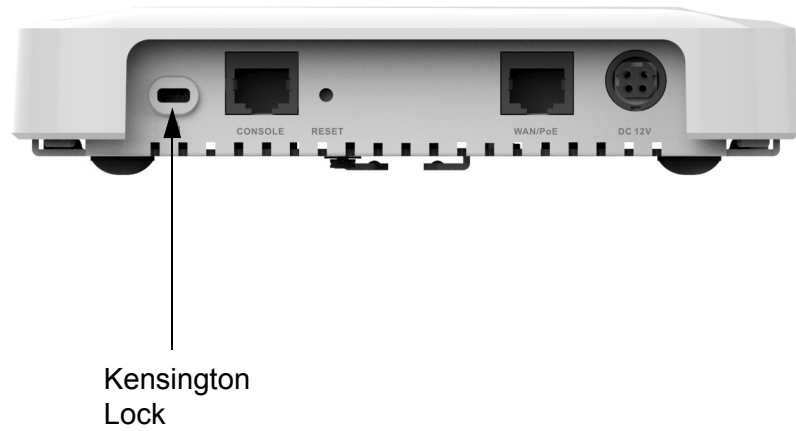

Figure 11. Kensington Lock

Starting the Initial Management Session on the Access Point

When you power on the access point for the first time, it queries the subnet on the LAN port for a DHCP server. If a DHCP server responds to its query, the unit uses the IP address the server assigns to it. If there is no DHCP server, the access point uses the default IP address 192.168.1.230.

There are a several ways to start the initial management session on the access point. One way is to establish a direct connection between your computer and the unit by connecting an Ethernet cable to the Ethernet port on the computer and the LAN port on the access point. This procedure requires changing the IP address on your computer to make it a member of the same subnet as the default IP address on the access point. You might perform this procedure if your network does not have a DHCP server and you want to configure the access point before connecting it to your network.

The initial management session may also be performed while the device is connected to your network. However, if your network does not have a DHCP server, you still have to change the IP address of your computer to match the subnet of the default address of the access point. Furthermore, if your network is divided into virtual LANs (VLANs), you have to be sure to connect the access point and your computer to ports on an Ethernet switch that are members of the same VLAN.

If your network has a DHCP server, use the IP address the server assigns it to start the management session.

The instructions for starting the initial management session are found in the following sections:

- ❑ “Starting the Initial Management Session with a Direct Connection” on page 39
- ❑ “Starting the Initial Management Session without a DHCP Server” on page 40
- ❑ “Starting the Initial Management Session with a DHCP Server” on page 40

Note

The initial management session of the access point has to be conducted through the LAN port because the default setting for the radios is off.

Starting the Initial Management Session with a Direct Connection

To start the management session with a direct Ethernet connection between your computer and the access point, perform the following procedure:

Note

If the unit is using PoE for power, and you did not order an AC/DC adapter with the unit, you cannot perform this procedure because it requires removing the network cable from the LAN port. Instead, perform one of the other procedures in this section to start the initial management session.

1. Connect one end of a network cable to the LAN port on the access point and the other end to the Ethernet network port on your computer. (This requires removing the network cable that you connected to the LAN port earlier in these instructions.)
2. Change the IP address on your computer to 192.168.1.*n*, where *n* is a number from 1 to 254, but not 230. Refer to the documentation that accompanies your computer for instructions on how to set the IP address.
3. Set the subnet mask on your computer to 255.255.255.0.
4. Power on the access point.
5. Start the web browser on your computer.
6. Enter the IP address 192.168.1.230 in the URL field of the browser.

You should now see the logon window, shown in Figure 12.



Figure 12. Logon Window

7. Enter "manager" for the username and "friend" for the password. The username and password are case-sensitive.

Starting the Initial Management Session without a DHCP Server

This procedure explains how to start the initial management session on the access point when the LAN port is connected to an Ethernet switch on a network that does not have a DHCP server. To start the management session, perform the following procedure:

1. If your network has VLANs, check to be sure that your computer and the access point are connected to ports on the Ethernet switch that are members of the same VLAN. This might require accessing the management software on the switch and listing the VLANs and their port assignments. For example, if the access point is connected to a port that is a member of the Sales VLAN, your computer must be connected to a port that is also a member of that VLAN. If your network is small and does not have VLANs or routers, you may connect your computer to any port on the Ethernet switch.
2. Change the IP address on your computer to 192.168.1.*n*, where *n* is a number from 1 to 254, but not 230. Refer to the documentation that accompanies your computer for instructions on how to set the IP address.
3. Set the subnet mask on your computer to 255.255.255.0.
4. Power on the access point.
5. Start the web browser on your computer.
6. Enter the IP address 192.168.1.230 in the URL field of the browser.

You should now see the logon window, shown in Figure 12 on page 39.
7. Enter “manager” for the username and “friend” for the password. The username and password are case-sensitive.

Starting the Initial Management Session with a DHCP Server

This procedure explains how to start the initial management session on the access point when the LAN port is connected to a network that has a DHCP server. This procedure assumes that you have already configured the DHCP server to assign the access point all the necessary configuration information (for example, IP address and default gateway) for your network. To start the management session, perform the following procedure:

1. Power on the access point.
2. Start the web browser on your computer.
3. Enter the IP address of the access point in the URL field of the browser. This is the IP address assigned to the unit by the DHCP server. If you do not know the address, refer to the DHCP server.
4. You should now see the logon window in Figure 12 on page 39.

5. Enter “manager” for the username and “friend” for the password. The username and password are case-sensitive.

Setting the Country Setting

You should set the country setting during the initial management session of the access point to ensure that the device operates in compliance with the codes and regulations of your region or country.

Note

The non-US model of this product has a country code setting that must be set during the initial management session of the unit. The setting ensures that the unit operates in compliance with the laws and regulations of your country or region.

For the US model, the country code is preset and cannot be changed. Per FCC regulations, the country code setting for all WiFi products marketed in the US must be fixed to US operational channels only.

To set the country setting, perform the following procedure:

1. Select Wireless Settings from the Manage menu.

The access point displays the Modify wireless settings window, shown in Figure 13.

Basic Settings Manage Cluster Status Services Maintenance

Modify wireless settings

Country JP - Japan

Radio 1 On Off
 MAC Address 00:1A:EB:39:85:20
 Mode IEEE 802.11b/g/n
 Channel 3
 Station Isolation

Radio 2 On Off
 MAC Address 00:1A:EB:39:85:30
 Mode IEEE 802.11a/n
 Channel Auto
 Station Isolation

Click "Update" to save the new settings.

Figure 13. Modify Wireless Settings Window

2. Select the Country pull-down menu and select your country or region.

Note

If the Country pull-down menu is deactivated and cannot be changed, the country parameter was set when the unit was manufactured. If the setting is not correct for your country or region, contact your Allied Telesis sales representative for assistance.

The access point displays a confirmation prompt.

3. Click OK to change the country setting or Cancel to cancel the procedure.

If you click OK, the access point changes the country setting and disables both radios on the access point.

This procedure does not require clicking the Update button.

You must now reboot the access point. The new country setting is not active until the unit is rebooted. To reboot the unit, either power off and on the unit or continue with these steps:

4. From the Maintenance menu, select Configuration.
5. Click the Reboot button in the To Reboot the Access Point section of the "Manage the Access Point's Configuration" window.
6. When the access point displays a confirmation prompt, click OK to reboot the unit or Cancel to cancel the procedure.
7. To resume managing the unit, wait for it to complete initializing its management software and then start a new management session.

For more instructions on how to configure the features of the access point, refer to the AT-TQ4600 *Wireless Access Point User's Guide*.

Appendix A

Technical Specifications

This appendix contains the following sections:

- “Physical Specifications” on page 45
- “Environmental Specifications” on page 45
- “Power Specifications” on page 46
- “LAN Port” on page 47
- “Safety and Electromagnetic Emissions Certifications” on page 49

Physical Specifications

Table 4. AT-TQ4600 Physical Specifications

| | |
|------------------------|--|
| Dimensions (W x D x H) | 170.0 mm x 170.0 mm x 35.0 mm (6.7 in. x 6.7 in. x 1.4 in.) |
| Weight | 0.47 kg (1 lb.) |

Environmental Specifications

Table 5. Environmental Specifications

| | |
|--|-----------------------------------|
| Operating Temperature of the Access Point When Using PoE | 0° C to 40° C (32° F to 104° F) |
| Operating Temperature of the Access Point When Using the AC/DC Adapter | 0° C to 40° C (32° F to 104° F) |
| Storage Temperature | -20° C to 60° C (-4° F to 140° F) |
| Operating Humidity | 5% to 80% non-condensing |
| Storage Humidity | 5% to 95% non-condensing |

Power Specifications

Table 6. AT-TQ4600 Maximum Power Consumption

| | |
|-----------|----------|
| AT-TQ4600 | 16 watts |
|-----------|----------|

Table 7. AT-TQ0091 Power Adapter

| | |
|-----------------------------------|------------------------------------|
| Input Range | 100~240 Vac |
| Input Frequency | 47-63 Hz |
| Input Power Consumption (no load) | <0.3W max. |
| Output Voltage | +12 VDC |
| Output Current | 2A max. |
| Manufacturer | Elementech International Co., Ltd. |
| Model | AU12412030 |

LAN Port

Table 8. LAN Port Specifications

| | |
|--------------|--|
| Connector | RJ-45 |
| Standards | IEEE 802.3 (10Base-T) IEEE 802.3u (100Base-TX) IEEE 802.3ab (1000Base-T) |
| PoE standard | IEEE 802.3at (class 4) |

Figure 14 illustrates the pin layout of the LAN port.

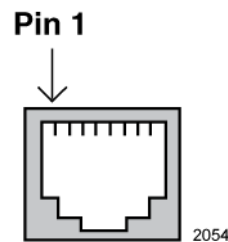

Figure 14. Pin Layout for the RJ-45 Connector on the LAN Port

Table 9 lists the pin signals when the port is operating in the MDI configuration at 10 or 100 Mbps.

Table 9. MDI Pin Signals (10Base-T or 100Base-TX)

| Pin | Signal |
|-----|--------|
| 1 | TX+ |
| 2 | TX- |
| 3 | RX+ |
| 6 | RX- |

Table 10 lists the pin signals for the MDI-X configuration at 10 or 100 Mbps.

Table 10. MDI-X Pin Signals (10Base-T or 100Base-TX)

| Pin | Signal |
|-----|--------|
| 1 | RX+ |
| 2 | RX- |
| 3 | TX+ |
| 6 | TX- |

Table 11 lists the pin signals when the LAN port is operating at 1000 Mbps.

Table 11. 1000Base-T Connector Pinouts

| Pin | Pair | Signal |
|-----|------|------------|
| 1 | 1 | TX and RX+ |
| 2 | 1 | TX and RX- |
| 3 | 2 | TX and RX+ |
| 4 | 3 | TX and RX+ |
| 5 | 3 | TX and RX- |
| 6 | 2 | TX and RX- |
| 7 | 4 | TX and RX+ |
| 8 | 4 | TX and RX- |

Safety and Electromagnetic Emissions Certifications

Table 12. Safety and Electromagnetic Emissions Certificates

| | |
|-------------------------------------|--|
| Standard Compliance | RoHS compliant European Union RoHS (Directive 2011/65/EU of the European Parliament and of the Council of 8 June 2011 on the restriction of the use of certain hazardous substances in electrical and electronic equipment.) |
| Certificates | CE EAC FCC/IC KC RCM Wi-Fi CERTIFIED |
| Electromagnetic Compatibility (EMC) | EN 301 489-1 EN 301 489-17 EN 55022 EN 55024 EN 61000-3-2 EN 61000-3-3 EN 61000-4-2 EN 61000-4-3 EN 61000-4-4 EN 61000-4-5 EN 61000-4-6 EN 61000-4-11 AS/NZS CISPR 22 FCC 47 CFR Part 15, Subpart B ICES-003 |
| Medical (EMC) | EN 60601-1-2 |
| Radio Equipment | EN 300 328 EN 301 893 AS/NZS 4268 FCC 47 CFR Part 15, Subpart C FCC 47 CFR Part 15, Subpart E FCC part 2 RSS210 RSS-Gen RSS-102 |

Table 12. Safety and Electromagnetic Emissions Certificates (Continued)

| | |
|--------|--|
| Safety | EN 60950-1 IEC 60950-1 TUV-T UL 60950-1 |
|--------|--|

Appendix B

Regulatory Statements

This appendix contains the following regulatory statements:

- “Federal Communication Commission Interference Statement” on page 52
- “Industry Canada Statement” on page 54
- “Europe - EU Declaration of Conformity” on page 56

Federal Communication Commission Interference Statement

This device complies with Part 15 of the FCC Rules. Operation is subject to the following two conditions: (1) This device may not cause harmful interference, and (2) this device must accept any interference received, including interference that may cause undesired operation.

This equipment has been tested and found to comply with the limits for a Class B digital device, pursuant to Part 15 of the FCC Rules. These limits are designed to provide reasonable protection against harmful interference in a residential installation. This equipment generates, uses and can radiate radio frequency energy and, if not installed and used in accordance with the instructions, may cause harmful interference to radio communications. However, there is no guarantee that interference will not occur in a particular installation. If this equipment does cause harmful interference to radio or television reception, which can be determined by turning the equipment off and on, the user is encouraged to try to correct the interference by one of the following measures:

- Reorient or relocate the receiving antenna.
- Increase the separation between the equipment and receiver.
- Connect the equipment into an outlet on a circuit different from that to which the receiver is connected.
- Consult the dealer or an experienced radio/TV technician for help.

FCC Caution: Any changes or modifications not expressly approved by the party responsible for compliance could void the user's authority to operate this equipment.

This transmitter must not be co-located or operating in conjunction with any other antenna or transmitter.

Radiation Exposure Statement

This equipment complies with FCC radiation exposure limits set forth for an uncontrolled environment. This equipment should be installed and operated with minimum distance 20cm between the radiator & your body.

Country Code Selection (WiFi Devices)

Note

The non-US model of this product has a country code setting that must be set during the initial management session of the unit. The setting ensures that the unit operates in compliance with the laws and regulations of your country or region.

For the US model, the country code is preset and cannot be changed. Per FCC regulations, the country code setting for all WiFi products marketed in the US must be fixed to US operational channels only.

Industry Canada Statement

This device complies with RSS-210 of the Industry Canada Rules. Operation is subject to the following two conditions: (1) This device may not cause harmful interference, and (2) this device must accept any interference received, including interference that may cause undesired operation.

Ce dispositif est conforme à la norme CNR-210 d'Industrie Canada applicable aux appareils radio exempts de licence. Son fonctionnement est sujet aux deux conditions suivantes: (1) le dispositif ne doit pas produire de brouillage préjudiciable, et (2) ce dispositif doit accepter tout brouillage reçu, y compris un brouillage susceptible de provoquer un fonctionnement indésirable.

This Class A digital apparatus complies with Canadian ICES-003.

Cet appareil numérique de la Classe A est conforme à la norme NMB-003 du Canada.

Caution:

(i) the device for operation in the band 5150-5250 MHz is only for indoor use to reduce the potential for harmful interference to co-channel mobile satellite systems;

(ii) the maximum antenna gain permitted for devices in the bands 5250-5350 MHz and 5470-5725 MHz shall comply with the e.i.r.p. limit; and

(iii) the maximum antenna gain permitted for devices in the band 5725-5825 MHz shall comply with the e.i.r.p. limits specified for point-to-point and non point-to-point operation as appropriate.

(iv) Users should also be advised that high-power radars are allocated as primary users (i.e. priority users) of the bands 5250-5350 MHz and 5650-5850 MHz and that these radars could cause interference and/or damage to LE-LAN devices.

Avertissement:

Le guide d'utilisation des dispositifs pour réseaux locaux doit inclure des instructions précises sur les restrictions susmentionnées, notamment:

(i) les dispositifs fonctionnant dans la bande 5 150-5 250 MHz sont réservés uniquement pour une utilisation à l'intérieur afin de réduire les risques de brouillage préjudiciable aux systèmes de satellites mobiles utilisant les mêmes canaux;

(ii) le gain maximal d'antenne permis pour les dispositifs utilisant les bandes 5 250-5 350 MHz et 5 470-5 725 MHz doit se conformer à la limite de p.i.r.e.;

(iii) le gain maximal d'antenne permis (pour les dispositifs utilisant la bande 5 725-5 825 MHz) doit se conformer à la limite de p.i.r.e. spécifiée pour l'exploitation point à point et non point à point, selon le cas.

(iv) De plus, les utilisateurs devraient aussi être avisés que les utilisateurs de radars de haute puissance sont désignés utilisateurs principaux (c.-à-d., qu'ils ont la priorité) pour les bandes 5 250-5 350 MHz et 5 650-5 850 MHz et que ces radars pourraient causer du brouillage et/ou des dommages aux dispositifs LAN-EL.

Radiation Exposure Statement:

This equipment complies with IC radiation exposure limits set forth for an uncontrolled environment. This equipment should be installed and operated with minimum distance 20cm between the radiator & your body.

Déclaration d'exposition aux radiations:

Cet équipement est conforme aux limites d'exposition aux rayonnements IC établies pour un environnement non contrôlé. Cet équipement doit être installé et utilisé avec un minimum de 20 cm de distance entre la source de rayonnement et votre corps.

Europe - EU Declaration of Conformity

This device complies with the essential requirements of the R&TTE Directive 1999/5/EC. The following test methods have been applied in order to prove presumption of conformity with the essential requirements of the R&TTE Directive 1999/5/EC:

- EN60950-1

Safety of Information Technology Equipment

- EN 300 328

Electromagnetic compatibility and Radio spectrum Matters (ERM); Wideband Transmission systems; Data transmission equipment operating in the 2,4 GHz ISM band and using spread spectrum modulation techniques; Harmonized EN covering essential requirements under article 3.2 of the R&TTE Directive,

- EN 301 893

Broadband Radio Access Networks (BRAN); 5 GHz high performance RLAN; Harmonized EN covering essential requirements of article 3.2 of the R&TTE Directive

- EN 301 489-1

Electromagnetic compatibility and Radio Spectrum Matters (ERM); ElectroMagnetic Compatibility (EMC) standard for radio equipment and services; Part 1: Common technical requirements.

- EN 301 489-17

Electromagnetic compatibility and Radio spectrum Matters (ERM); ElectroMagnetic Compatibility (EMC) standard for radio equipment and services; Part 17: Specific conditions for 2,4 GHz wideband transmission systems and 5 GHz high performance RLAN equipment

This device is a 5GHz wideband transmission system (transceiver), intended for use in all EU member states and EFTA countries, except in France and Italy where restrictive use applies.

In Italy the end-user should apply for a license at the national spectrum authorities in order to obtain authorization to use the device for setting up outdoor radio links and/or for supplying public access to telecommunications and/or network services.

This device may not be used for setting up outdoor radio links in France and in some areas the RF output power may be limited to 10 mW EIRP in the frequency range of 2454 - 2483.5 MHz. For detailed information the end-user should contact the national spectrum authority in France.

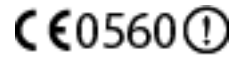

| | |
|-----------------------|--|
| Česky [Czech] | Allied Telesis tímto prohlašuje, že tento wireless access point je ve shodě se základními požadavky a dalšími příslušnými ustanoveními směrnice 1999/5/ES. |
| Dansk [Danish] | Undertegnede Allied Telesis erklærer herved, at følgende udstyr wireless access point overholder de væsentlige krav og øvrige relevante krav i direktiv 1999/5/EF. |
| Deutsch [German] | Hiermit erklärt Allied Telesis, dass sich das Gerät wireless access point in Übereinstimmung mit den grundlegenden Anforderungen und den übrigen einschlägigen Bestimmungen der Richtlinie 1999/5/EG befindet. |
| Eesti [Estonian] | Käesolevaga kinnitab Allied Telesis seadme wireless access point vastavust direktiivi 1999/5/EÜ põhinõuetele ja nimetatud direktiivist tulenevatele teistele asjakohastele sätetele. |
| English | Hereby, Allied Telesis, declares that this wireless access point is in compliance with the essential requirements and other relevant provisions of Directive 1999/5/EC. |
| Español [Spanish] | Por medio de la presente Allied Telesis declara que el wireless access point cumple con los requisitos esenciales y cualesquiera otras disposiciones aplicables o exigibles de la Directiva 1999/5/CE. |
| Ελληνική [Greek] | ΜΕ ΤΗΝ ΠΑΡΟΥΣΑ Allied Telesis ΔΗΛΩΝΕΙ ΟΤΙ wireless access point ΣΥΜΜΟΡΦΩΝΕΤΑΙ ΠΡΟΣ ΤΙΣ ΟΥΣΙΩΔΕΙΣ ΑΠΑΙΤΗΣΕΙΣ ΚΑΙ ΤΙΣ ΛΟΙΠΕΣ ΣΧΕΤΙΚΕΣ ΔΙΑΤΑΞΕΙΣ ΤΗΣ ΟΔΗΓΙΑΣ 1999/5/ΕΚ. |
| Français [French] | Par la présente Allied Telesis déclare que l'appareil wireless access point est conforme aux exigences essentielles et aux autres dispositions pertinentes de la directive 1999/5/CE. |
| Italiano [Italian] | Con la presente Allied Telesis dichiara che questo wireless access point è conforme ai requisiti essenziali ed alle altre disposizioni pertinenti stabilite dalla direttiva 1999/5/CE. |
| Latviski [Latvian] | Ar šo Allied Telesis deklarē, ka wireless access point atbilst Direktīvas 1999/5/EK būtiskajām prasībām un citiem ar to saistītajiem noteikumiem. |

| | |
|-------------------------------|--|
| Lietuvių [Lithuanian] | Šiuo Allied Telesis deklaruoja, kad šis wireless access point atitinka esminius reikalavimus ir kitas 1999/5/EB Direktyvos nuostatas. |
| Nederlands [Dutch] | Hierbij verklaart Allied Telesis dat het toestel wireless access point in overeenstemming is met de essentiële eisen en de andere relevante bepalingen van richtlijn 1999/5/EG. |
| Malti [Maltese] | Hawnhekk, Allied Telesis, jiddikjara li dan wireless access point jikkonforma mal-ħtiġijiet essenzjali u ma provvedimenti oħrajn relevanti li hemm fid-Dirrettiva 1999/5/EC. |
| Magyar [Hungarian] | Alulírott, Allied Telesis nyilatkozom, hogy a wireless access point megfelel a vonatkozó alapvető követelményeknek és az 1999/5/EC irányelv egyéb előírásainak. |
| Polski [Polish] | Niniejszym Allied Telesis oświadcza, że wireless access point jest zgodny z zasadniczymi wymogami oraz pozostałymi stosownymi postanowieniami Dyrektywy 1999/5/EC. |
| Português [Portuguese] | Allied Telesis declara que este wireless access point está conforme com os requisitos essenciais e outras disposições da Directiva 1999/5/CE. |
| Slovensko [Slovenian] | Allied Telesis izjavlja, da je ta wireless access point v skladu z bistvenimi zahtevami in ostalimi relevantnimi določili direktive 1999/5/ES. |
| Slovensky [Slovak] | Allied Telesis týmto vyhlasuje, že wireless access point spĺňa základné požiadavky a všetky príslušné ustanovenia Smernice 1999/5/ES. |
| Suomi [Finnish] | Allied Telesis vakuuttaa täten että wireless access point tyyppinen laite on direktiivin 1999/5/EY oleellisten vaatimusten ja sitä koskevien direktiivin muiden ehtojen mukainen. |
| Svenska [Swedish] | Härmed intygar Allied Telesis att denna wireless access point står i överensstämmelse med de väsentliga egenskapskrav och övriga relevanta bestämmelser som framgår av direktiv 1999/5/EG. |