



IN-DASH GPS NAVIGATION RECEIVER

INA-W900



iPhone 3GS
16GB 32GB



iPhone 3G
8GB 16GB



iPhone
4GB 8GB 16GB



MP3 AAC



- **OWNER'S MANUAL**
Please read before using this equipment.
- **MODE D'EMPLOI**
Veuillez lire avant d'utiliser cet appareil.
- **MANUAL DE OPERACIÓN**
Léalo antes de utilizar este equipo.

ALPINE ELECTRONICS MARKETING, INC.
1-1-8 Nishi Gotanda,
Shinagawa-ku,
Tokyo 141-0031, Japan
Phone 03-5496-8231

ALPINE ELECTRONICS OF AMERICA, INC.
19145 Gramercy Place, Torrance,
California 90501, U.S.A.
Phone 1-800-ALPINE-1 (1-800-257-4631)
1-888-NAV-HELP (1-888-628-4357)

ALPINE ELECTRONICS OF CANADA, INC.
777 Supertest Road, Toronto,
Ontario M3J 2M9, Canada
Phone 1-800-ALPINE-1 (1-800-257-4631)
1-888-NAV-HELP (1-888-628-4357)

ALPINE ELECTRONICS OF AUSTRALIA PTY. LTD.
161-165 Princes Highway, Hallam
Victoria 3803, Australia
Phone 03-8787-1200

ALPINE ELECTRONICS GmbH
Wilhelm-Wagenfeld-Str. 1-3, 80807 München, Germany
Phone 089-32 42 640

ALPINE ELECTRONICS OF U.K. LTD.
Alpine House
Fletchamstead Highway, Coventry CV4 9TW, U.K.
Phone 0870-33 33 763

ALPINE ELECTRONICS FRANCE S.A.R.L.
(RCS PONTOISE B 338 101 280)
98, Rue de la Belle Etoile, Z.I. Paris Nord II,
B.P. 50016, 95945 Roissy Charles de Gaulle
Cedex, France
Phone 01-48638989

ALPINE ITALIA S.p.A.
Viale C. Colombo 8, 20090 Trezzano
Sul Naviglio (MI), Italy
Phone 02-484781

ALPINE ELECTRONICS DE ESPAÑA, S.A.
Portal de Gamarra 36, Pabellón, 32
01013 Vitoria (Alava)-APDO 133, Spain
Phone 945-283588

ALPINE ELECTRONICS (BENELUX) GmbH
Leuvensesteenweg 510-B6,
1930 Zaventem, Belgium
Phone 02-725-13 15

EN

FR

ES

Contents

Operating Instructions

PRECAUTIONS AND NOTICES

IMPORTANT INFORMATION 5
 USER AGREEMENT 6
 END USER LICENSE AGREEMENT
 (Microsoft) 6

WARNING

Points to Observe for Safe Usage 8
WARNING 8
CAUTION 8
PRECAUTIONS 9
Discs Playable on This Unit 10

Getting Started

Accessory List 14
 Location of Controls 14
 Turning Power On or Off 14
 Inserting/Ejecting a Disc 15
 Inserting/Removing the SD Memory Card 15
 Adjusting the Monitor Viewing Angle 15
 Adjusting the Volume 15
 Lowering Volume Quickly 15
 How to view the Display 16
 Soft button operation 16
 Recalling the Source 16
 Displaying the Numeric Keypad
 Input Screen 17

Navigation

Basic Operation 17
 Turning the Navigation System On 17
 Navigation Main Menu 18
 Map Functions 18
 From the Map Display 19
 Setting a Destination 19
 Finding Local Places 20
 Setting Waypoints 20

Input a Destination 20
 Go to Menu 20
 Set a Destination by Address 21
 Set a Destination by Place 22
 Set a Destination by History 23
 Set a Destination from the
 Address Book 24
 Set a Destination by Coordinates 24
 Set a Destination by Intersection 24
 Destination Options 25
 Finding Nearby Places 25
 Finding Alternative Routes to the
 Destination 26
 Setting a Destination as Home 26
 Saving a Destination into the
 Address Book 26
 Setting Waypoints 26
 ROUTE 28
 Viewing Turn List During Guidance 28
 Finding an Alternate Route 28
 Finding a Detour 28
 Editing Waypoints 29
 Canceling Route 29
 Home 29
 Going Home 29
 GUIDEVIEW WINDOW™ Function 29
 Turn on the GUIDEVIEW WINDOW™
 Mode 29
 GUIDEVIEW WINDOW™ Display 29
 Settings 30
 Settings Menu 30
 Customizing Display 31
 Customizing Map 31
 Customizing Navigation Tool 32
 Setting Audio 32
 Regional Settings 32
 Information 33
 Information Menu 33
 Viewing Dashboard 33
 Viewing GPS Status 33
 Viewing System Information 34

Radio

Listening to the Radio	34
Presetting Stations Manually	35
Presetting Stations Automatically	35
Tuning to Preset Stations	35
Storing the tag information (HD Radio™ mode only)	35
Changing the Display (HD Radio™ mode only)	36
Receiving a Multicast (HD Radio™ mode only)	36

CD/MP3/WMA/AAC

Playback	37
Repeat Play	37
M.I.X. (Random Play)	37
Selecting Folders (concerning MP3/WMA/AAC)	37
About MP3/WMA/AAC	38

DVD

Playing a Disc	39
To display the DVD mode screen	40
If a menu screen appears	40
Displaying the Top Menu Screen	41
Displaying the Menu Screen	41
Displaying the Menu Operation Mode Screen	41
Searching by Program	41
Searching by Playlist	41
Stopping Playback (PRE STOP)	41
Stopping Playback	41
Fast-forwarding/Fast-reversing	41
Finding the Beginnings of Chapters	42
Playing Still Frames (Pausing)	42
Forward/reverse frame-by-frame Playback	42
Slow Motion Playback	42
Selecting Program (SKIP)	42
Selecting Playlist (SKIP)	42
Repeat Playback	42
Searching by Title/Program/Playlist	43
Searching Directly by Chapter Number	43
Switching the Angle	43
Switching the Audio Tracks	43

Switching the Subtitles (Subtitle Language)	44
Switching from the disc menu	44

Other Useful Features

Adjusting the Audio	44
Search Function	45
Switching Display Modes	46

Setup

DVD Setup

DVD Setup Operation	47
Changing the language setting	47
Setting of the Menu Language	48
Setting of the Audio Language	48
Setting of the Subtitle Language	48
Changing the Country Code Setting	48
Setting the Rating Level (Parental Lock)	48
Setting the Downmix Mode	49
Setting the TV Screen Mode	49
Playing MP3/WMA/AAC Data (File Play Mode)	49

RADIO Setup

Digital SEEK Setting (HD Radio™ mode only)	50
---	----

DISPLAY Setup

Display Setup Operation	50
Visual EQ Setting Operation	51
Setting the Brightness of the Backlighting	51
Adjusting the Minimum Level of Backlight	52
Setting the Function Guide display ON/OFF	52
Switching the Font Back Display Color	52
Adjusting the Touch Panel	52

GENERAL Setup

General Setup Operation	52
Displaying the Time	53
Sound (Beep) Guide Function	53
Setting the Scroll	53
Adjusting the Dimmer of Button Lighting at Night	53

SYSTEM Setup

System Setup Operation	53
Setting the External Device	
Interrupt Mode	54
Setting the Interrupt Icon Display	54
Switching the function of the remote sensor	54
Setting the Rear Camera Input	54
Setting the AUX Mode	55
Adjusting the External Input	
Audio Level	55
Switching the Visual Input	
Signal System	55
Setting the Picture Output	55
Setting the BLUETOOTH Connection (BLUETOOTH IN)	55
Setting the AUX+ Mode	55
Adjusting the AUX+ Audio Level	55
Setting the Rear Entertainment System	55

Sirius Setup

Sirius Setup Operation	56
Clearing the Lock of Channels	56
Clearing the Setting of Hidden Channels	56
Setting the Favorite Sports Team announcement	56
Setting the Sirius Seek (S-Seek) Alert	57

IMPRINT Operation (Optional)

Changing MultEQ mode	58
Adjusting Sound Setting in Manual Mode	58
Storing Settings in the Memory	61
Calling up the Preset Memory	61
Setting the Subwoofer	61
About Time Correction	62
About the Crossover	63

BLUETOOTH Operation (Optional)

Setup Before Using	64
About BLUETOOTH	64
Before Using Hands-Free Function	64
How to connect to a BLUETOOTH compatible device (Pairing)	64
BLUETOOTH Setup	64
BLUETOOTH Setup Operation	64
Hands-Free Phone Control	66
About the Hands-Free Phone	66
Answering a Call	66
Hanging up the Telephone	66

Adjusting the volume when receiving a Call	66
Redial Function	66
Call Switching Operation	67
Call History	67
Redialing a Number in Dialed Calls History	67
Dialing a Number in Received Calls History	67
Dialing a Number in Missed Calls History	67
Dialing a Number In the Phone Book (Phone Book)	67
Voice Dial Operation	68
Dialing a Number Using Direct Dial Input	68
BLUETOOTH Audio Function	68
BLUETOOTH Audio Operation	68

Auxiliary Device (Optional)

Operating Auxiliary Devices (Optional)	69
--	----

Rearview Camera Operation (Optional)

Switching the Rear Camera Screen (Optional)	70
Displaying the rear view video while the car is in reverse	70
Displaying the rear view video manually	70

Changer (Optional)

Controlling CD Changer (Optional)	70
Multi-Changer Selection (Optional)	71

SAT Radio Receiver (Optional)

Receiving Channels with the SAT Receiver (Optional)	71
Tuning in to Categorized Programs	72
Changing the Display	72
Checking the SAT Radio ID Number	72
Storing Channel Presets	72
Receiving Stored Channels	72
Search Function (XM mode)	73
Search Function (Sirius mode)	73
Selecting the Channel directly	73
Receiving Weather or Traffic information from SAT Radio	73

Storing the desired Song/Artist (Sirius mode only)	74
Storing desired Sports Teams (Sirius mode only)	74
Activating the stored Alert (Sirius mode only)	74
Offset Playback Function (Sirius mode only)	74

USB Memory (Optional)

BANK Function (USB memory only)	75
Playback	75
Repeat Play	75
Random Play Shuffle (M.I.X.)	76
Searching for a desired Song	76
Searching by artist name	76
Selecting Playlist/Artist/Album/ Genre/Composer	76
Select the desired Folder (Folder up/down)	77
Creating the playlist from the Artist/Album information of the current song	77
About MP3/WMA/AAC File of USB Memory	77

iPhone/iPod (Optional)

Playback	77
Searching for a desired Song	78
Searching by artist name	78
Selecting Playlist/Artist/Album/Genre/ Composer/Episode/Category	78
Random Play Shuffle (M.I.X.)	79
Repeat Play	79

Information

About DVDs	79
Terminology	80
List of Language Codes	81
List of Country Codes	82
In Case of Difficulty	84
Specifications	89

Installation and Connections

Warning	90
Caution	90
Precautions	90
Installation	91
Connections	94
System Example	97

LIMITED WARRANTY

Operating Instructions

PRECAUTIONS AND NOTICES

IMPORTANT INFORMATION

PLEASE READ CAREFULLY BEFORE USING THIS PRODUCT

This product is intended to provide turn by turn instructions to get you to a desired destination. Please make certain that all persons using this navigation system carefully read these precautions and the following instructions fully.

- *This product is not a substitute for your personal judgment. Any route suggestions made by this navigation system may never supersede any local traffic regulations or your personal judgment and/or knowledge of safe driving practices. Do not follow route suggestions if the navigation system instructs you to perform an unsafe or illegal maneuver, places you in an unsafe situation, or routes you into an area which you consider unsafe.*
- *Glance at the screen only when necessary and safe to do so. If prolonged viewing of the screen is necessary, pull over in a safe and legal manner and location.*
- *Do not input destinations, change settings, or access any functions requiring a prolonged view of the monitor and/or remote control while you are driving. Pull over in a safe and legal manner and location before attempting to access the system.*
- *Do not use the navigation system to route you to emergency services. Not all locations of emergency services such as police and fire stations, hospitals and clinics are contained in the database. Please use your own judgment and ask for directions in these situations.*
- *The map database used in the navigation system is the most recent map data available at the time of production. Because of changes in streets and neighborhoods, there may be situations where the navigation system is not able to route you to your desired destination. In these cases, use your own judgment.*
- *The map database is designed to provide you with route suggestions and does not take into account the relative safety of a suggested route or of factors which may affect the time required to reach your destination. The system does not reflect road closures or construction, road characteristics (i.e. type of road surface, slope or grade, weight or height restrictions, etc.), traffic congestion, weather conditions, or any other factors which may affect the safety or timing of your driving experience. Use your own personal judgment if the navigation system is unable to provide you with an alternate route.*
- *There may be situations where the navigation system displays the vehicle's location erroneously. Use your own driving judgment in this situation, taking into account current driving conditions. Please be aware that in this situation the navigation system should correct the vehicle's position automatically. However, there may be times where you may have to correct the position yourself. If this is the case, pull over in a safe and legal manner and location before attempting operation.*
- *Make certain that the volume level of the navigation system is set to a level which still allows you to hear outside traffic and emergency vehicles.*

If there is anything in the manual about the operation of the navigation system which you are uncertain about, please contact your local Alpine authorized navigation dealer or Alpine at 1-888-NAV-HELP (1-888-628-4357) before using the navigation system.

FCC COMPLIANCE STATEMENT

This equipment has been tested and found to comply with the limits for a Class B digital device, pursuant to part 15 of the FCC Rules. These limits are designed to provide more reasonable protection against harmful interference in a residential installation, and are more stringent than "outdoor" requirements.

Operation is subject to the following two conditions: (1) This device may not cause harmful interference, and (2) this device must accept any interference received, including interference that may cause undesired operation.

This equipment generates, uses, and can radiate radio frequency energy and, if not installed and used in accordance with the instructions, may cause harmful interference to radio communications. However, there is no guarantee that interference will not occur in a particular installation. If this equipment does cause harmful interference to radio or television reception, which can be determined by turning the equipment off and on, you are encouraged to try to correct the interference by one of the following measures:

- *Reorient or relocate the receiving antenna.*
- *Increase the separation between the equipment and the receiver.*
- *Connect the equipment into an outlet on a circuit different from that to which the receiver is connected.*
- *Consult an experienced radio/TV technician.*

USER AGREEMENT

In using this Navigation System (hereinafter referred to as "System"), which includes Alpine Electronics, Inc. ("Alpine") Specifications, Space Machine, Inc. ("Space Machine") Software and NAVTEQ North America, LLC. ("NAVTEQ") Database, you are bound by the terms and conditions set forth below. By breaking the seal on the System and using your copy of the System, you have demonstrated your agreement to the terms and conditions of this Agreement. You should, therefore, make sure that you read and understand the following provisions.

The System may not be copied, duplicated or otherwise modified, in whole or in part, without the express written permission of Alpine, Space Machine and NAVTEQ. The System may not be transferred or sublicensed to any third party for profit, rent or loan or licensed for reuse in any manner. The System may not be decompiled, reverse engineered or otherwise disassembled, in whole or in part. The System may not be used in a network or by any other manner of simultaneous use in multiple systems. The System is intended solely for personal use (or internal use where the end-user is a business) by the consumer. The System is not to be used for commercial purposes. Neither Alpine, Space Machine nor NAVTEQ guarantees to the customer that the System meet the specific objectives of the user. Neither Alpine, Space Machine nor NAVTEQ shall be responsible for any damages caused by the use of the System to the actual user and to any third party. The warranty on the System shall not extend to an exchange or refund due to misspelling, omission of letters, or any other cosmetic discrepancy in layout found in the System. The right to use the System shall expire either when the user destroys this software, or when any of the terms for use is violated and Alpine, Space Machine and/or NAVTEQ exercise the option to revoke the license to use this software. The terms and conditions hereof apply to all subsequent users and owners as well as to the original purchaser.

The NAVTEQ Database may include or reflect data of licensors, including Her Majesty The Queen in right of CANADA. Such data is licensed on an "AS IS" basis. The licensors, including Her Majesty The Queen, make no guarantees, representations or warranties respecting such data, either express or implied, arising by law or otherwise, accuracy or fitness for a particular purpose. The licensors, including Her Majesty The Queen, shall not be liable in respect of any claim, demand or action, irrespective of the nature of the cause of the claim, demand or action alleging any loss, injury or damages, direct or indirect, which may result from the use or possession of the data or the NAVTEQ database. The licensors, including Her Majesty The Queen, shall not be liable in any way for loss of revenues or contracts, or any other consequential loss of any kind resulting from any defect in the data or the NAVTEQ database. End User shall indemnify and save harmless the licensors, including Her Majesty The Queen and the minister, and their officers, employees and agents from and against any claim, demand or action, irrespective of the nature of the cause of the claim, demand or action, alleging loss, costs, expenses, damages or injuries (including injuries resulting in death) arising out of the use or possession of the data or the NAVTEQ database.

END USER LICENSE AGREEMENT (Microsoft)

You have acquired a device ("DEVICE") that includes software licensed by Alpine Electronics, Inc. (collectively "ALPINE") from an affiliate of Microsoft Corporation (collectively "MS"). Those installed software products of MS origin, as well as associated media, printed materials, and "online" or electronic documentation ("SOFTWARE") are protected by international intellectual property laws and treaties. The SOFTWARE is licensed, not sold. All rights reserved.

IF YOU DO NOT AGREE TO THIS END USER LICENSE AGREEMENT ("EULA"), DO NOT USE THE DEVICE OR COPY THE SOFTWARE INSTEAD, PROMPTLY CONTACT ALPINE FOR INSTRUCTIONS ON RETURN OF THE UNUSED DEVICE(S) FOR A REFUND. ANY USE OF THE SOFTWARE, INCLUDING BUT NOT LIMITED TO USE ON THE DEVICE, WILL CONSTITUTE YOUR AGREEMENT TO THIS EULA (OR RATIFICATION OF ANY PREVIOUS CONSENT).

GRANT OF SOFTWARE LICENSE,

This EULA grants you the following license: You may use the SOFTWARE only on the DEVICE.

NOT FAULT TOLERANT.

THE SOFTWARE IS NOT FAULT TOLERANT. ALPINE HAS INDEPENDENTLY DETERMINED HOW TO USE THE SOFTWARE IN THE DEVICE, AND MS HAS RELIED UPON ALPINE TO CONDUCT SUFFICIENT TESTING TO DETERMINE THAT THE SOFTWARE IS SUITABLE FOR SUCH USE.

NO WARRANTIES FOR THE SOFTWARE,

THE SOFTWARE is provided "AS IS" and with all faults. THE ENTIRE RISK AS TO SATISFACTORY QUALITY, PERFORMANCE, ACCURACY, AND EFFORT (INCLUDING LACK OF NEGLIGENCE) IS WITH YOU. ALSO, THERE IS NO WARRANTY AGAINST INTERFERENCE WITH YOUR ENJOYMENT OF THE SOFTWARE OR AGAINST INFRINGEMENT. IF YOU HAVE RECEIVED ANY WARRANTIES REGARDING THE DEVICE OR SOFTWARE THOSE WARRANTIES DO NOT ORIGINATE FROM, AND ARE NOT BINDING ON, MS.

NO LIABILITY FOR CERTAIN DAMAGES.

EXCEPT AS PROHIBITED BY LAW, MS SHALL HAVE NO LIABILITY FOR ANY INDIRECT, SPECIAL, CONSEQUENTIAL OR THE SOFTWARE. THIS LIMITATION SHALL APPLY EVEN IF ANY REMEDY FAILS OF ITS ESSENTIAL PURPOSE. IN NO EVENT SHALL MS BE LIABLE FOR ANY AMOUNT IN EXCESS OF U.S. TWO HUNDRED FIFTY DOLLARS (U.S. \$250.00).

LIMITATIONS ON REVERSE ENGINEERING, DECOMPILATION, AND DISASSEMBLY

You may not reverse engineer, decompile, or disassemble the SOFTWARE, except and only to the extent that such activity is expressly permitted by applicable law notwithstanding this limitation.

ADDITIONAL SOFTWARE/SERVICES.

The SOFTWARE may permit ALPINE, MS, Microsoft Corporation or their affiliates to provide or make available to you SOFTWARE updates, supplements, add-on components, or Internet – base service components of the SOFTWARE after the date you obtain your initial copy of the SOFTWARE (“Supplemental Components”).

- If ALPINE provides or makes available to you Supplemental Components and no other EULA terms are provided along with the Supplemental Components, then the terms of this EULA shall apply.
- If MS, Microsoft Corporation or their affiliates make available Supplemental Components, and no other EULA terms are provided, then the terms of this EULA shall apply, except that MS, Microsoft Corporation or affiliate entity providing the Supplemental Component(s) shall be licensor of the Supplemental Component(s).
- ALPINE, MS, Microsoft Corporation and their affiliates reserve the right to discontinue any Internet-based services provided to you or made available to you through the use of the SOFTWARE.

RECOVERY MEDIA.

If SOFTWARE is provided by ALPINE on separate media and labeled “Recovery Media” you may use the Recovery Media solely to restore or reinstall the SOFTWARE originally installed on the DEVICE.

UPGRADES.

If the SOFTWARE is provided by ALPINE separate from the DEVICE on separate media or via web download or other means, and is labeled “For Upgrade Purposes Only” you may install one (1) copy of such SOFTWARE onto the DEVICE as a replacement copy for the existing SOFTWARE, and use it in accordance with this EULA, including any additional EULA terms accompanying the upgrade SOFTWARE.

TERMINATION.

Without prejudice to any other rights, ALPINE or MS may terminate this EULA if you fail to comply with the terms and conditions of this EULA. In such event, you must destroy all copies of the SOFTWARE and all of its component parts.

INTELLECTUAL PROPERTY RIGHTS.

All title and intellectual property rights in and to the SOFTWARE (including but not limited to any images, photographs, animations, video, audio, music, text and “applets,” incorporated into the SOFTWARE), the accompanying printed materials, and any copies of the SOFTWARE, are owned by MS, Microsoft Corporation, their affiliates or suppliers. The SOFTWARE is licensed, not sold.

You may not copy the printed materials accompanying the SOFTWARE. All title and intellectual property rights in and to the content which may be accessed through use of the SOFTWARE is the property of the respective content owner and may be protected by applicable copyright or other intellectual property laws and treaties. This EULA grants you no rights to use such content. All rights not specifically granted under this EULA are reserved by MS, Microsoft Corporation, their affiliates and suppliers. Use of any on-line services which may be accessed through the SOFTWARE may be governed by the respective terms of use relating to such services. If this SOFTWARE contains documentation that is provided only in electronic form, you may print one copy of such electronic documentation.

TRADEMARKS.

This EULA does not grant you any rights in connection with any trademarks or service marks of ALPINE MS, Microsoft Corporation, their affiliates or suppliers.

PRODUCT SUPPORT.

Product support for the SOFTWARE is not provided by MS, its parent corporation Microsoft Corporation, or their affiliates or subsidiaries. For product support, please refer to ALPINE support number provided in the documentation for the DEVICE. Should you have any questions concerning this EULA, or if you desire to contact ALPINE for any other reason, please refer to the address provided in the documentation for the DEVICE.

SOFTWARE TRANSFER ALLOWED BUT WITH RESTRICTIONS.

You may permanently transfer rights under this EULA only as part of a permanent sale or transfer of the Device, and only if the recipient agrees to this EULA. If the SOFTWARE is an upgrade, any transfer must also include all prior versions of the SOFTWARE.

EXPORT RESTRICTION.

You acknowledge that SOFTWARE is of US-origin. You agree to comply with all applicable international and national laws that apply to the SOFTWARE, including the U.S. Export Administration Regulations, as well as end-user, end-use and country destination restrictions issued by U.S. and other governments. For additional information on exporting the SOFTWARE, see <http://www.microsoft.com/exporting/>

WARNING

Points to Observe for Safe Usage

- *Read this manual carefully before using this disc and system components. They contain instructions on how to use this product in a safe and effective manner. Alpine cannot be responsible for problems resulting from failure to observe the instructions in this manual.*
- *This manual uses various pictorial displays to show you how to use this product safely and to alert you to potential dangers resulting from improper connections and operation. Following are the meanings of these pictorial displays. It is important to fully understand the meanings of these pictorial displays in order to use this manual and the system properly.*



WARNING

This symbol means important instructions. Failure to heed them can result in serious injury or death.

INSTALL THE PRODUCT CORRECTLY SO THAT THE DRIVER CANNOT WATCH TV/VIDEO UNLESS THE VEHICLE IS STOPPED AND THE EMERGENCY BRAKE IS APPLIED.

It is dangerous (and illegal in many states) for the driver to watch TV/Video while driving a vehicle. Installing this product incorrectly enables the driver to watch TV/Video while driving. This may cause a distraction, preventing the driver from looking ahead, thus causing an accident. The driver or other people could be severely injured.

DO NOT WATCH VIDEO WHILE DRIVING.

Watching the video may distract the driver from looking ahead of the vehicle and cause an accident.

DO NOT OPERATE ANY FUNCTION THAT TAKES YOUR ATTENTION AWAY FROM SAFELY DRIVING YOUR VEHICLE.

Any function that requires your prolonged attention should only be performed after coming to a complete stop. Always stop the vehicle in a safe location before performing these functions. Failure to do so may result in an accident.

DO NOT FOLLOW ROUTE SUGGESTIONS IF THE NAVIGATION SYSTEM INSTRUCTS YOU TO PERFORM AN UNSAFE OR ILLEGAL MANEUVER, OR PLACES YOU IN AN UNSAFE SITUATION OR AREA.

This product is not a substitute for your personal judgment. Any route suggestions by this system should never supersede any local traffic regulations or your personal judgment or knowledge of safe driving practice.

KEEP THE VOLUME AT A LEVEL WHERE YOU CAN STILL HEAR OUTSIDE NOISES WHILE DRIVING.

Excessive volume levels that obscure sounds such as emergency vehicle sirens or road warning signals (train crossings, etc.) can be dangerous and may result in an accident. LISTENING AT LOUD VOLUME LEVELS IN A CAR MAY ALSO CAUSE HEARING DAMAGE.

MINIMIZE DISPLAY VIEWING WHILE DRIVING.

Viewing the display may distract the driver from looking ahead of the vehicle and cause an accident.

DO NOT DISASSEMBLE OR ALTER.

Doing so may result in an accident, fire or electric shock.

USE ONLY IN CARS WITH A 12 VOLT NEGATIVE GROUND.

(Check with your dealer if you are not sure.) Failure to do so may result in fire, etc.

KEEP SMALL OBJECTS SUCH AS BATTERIES OUT OF THE REACH OF CHILDREN.

Swallowing them may result in serious injury. If swallowed, consult a physician immediately.

USE THE CORRECT AMPERE RATING WHEN REPLACING FUSES.

Failure to do so may result in fire or electric shock.

DO NOT BLOCK VENTS OR RADIATOR PANELS.

Doing so may cause heat to build up inside and may result in fire.

USE THIS PRODUCT FOR MOBILE 12V APPLICATIONS.

Use for other than its designed application may result in fire, electric shock or other injury.

DO NOT PLACE HANDS, FINGERS OR FOREIGN OBJECTS IN INSERTION SLOTS OR GAPS.

Doing so may result in personal injury or damage to the product.



CAUTION

This symbol means important instructions. Failure to heed them can result in injury or material property damage.

HALT USE IMMEDIATELY IF A PROBLEM APPEARS.

Failure to do so may cause personal injury or damage to the product. Return it to your authorized Alpine dealer or the nearest Alpine Service Center for repairing.

KEEP FINGERS AWAY WHILE THE MOTORIZED FRONT PANEL OR MOVING MONITOR IS IN MOTION.

Failure to do so may result in personal injury or damage to the product.

PRECAUTIONS

Product Cleaning

Use a soft dry cloth for periodic cleaning of the product. For more severe stains, please dampen the cloth with water only. Anything else has the chance of dissolving the paint or damaging the plastic.

Temperature

Be sure the temperature inside the vehicle is between +45°C (+113°F) and 0°C (+32°F) before turning your unit on.

Moisture Condensation

You may notice the disc playback sound wavering due to condensation. If this happens, remove the disc from the player and wait about an hour for the moisture to evaporate.

Damaged Disc

Do not attempt to play cracked, warped, or damaged discs. Playing a bad disc could severely damage the playback mechanism.

Maintenance

If you have problems, do not attempt to repair the unit yourself. Return it to your Alpine dealer or the nearest Alpine Service Station for servicing.

Never Attempt the Following

Do not grip or pull out the disc while it is being pulled back into the player by the automatic reloading mechanism.

Do not attempt to insert a disc into the unit when the unit power is off.



Inserting Discs

Your player accepts only one disc at a time for playback. Do not attempt to load more than one disc.

Make sure the label side is facing up when you insert the disc.

“Disc Error” will be displayed on your player if you insert a disc incorrectly. If “Disc Error” continues to be displayed even though the disc has been inserted correctly, push the RESET switch with a pointed object such as a ballpoint pen.

Playing a disc while driving on a very bumpy road may result in skips, but this will not scratch the disc or damage the player.

Irregular Shaped Discs

Be sure to use round shaped discs only for this unit and never use any special shaped discs.

Use of special shaped discs may cause damage to the mechanism.



New Discs

To prevent the disc from jamming, “Disc Error” is displayed if discs with irregular surfaces are inserted or if discs are inserted incorrectly. When a new disc is ejected immediately after initial loading, use your finger to feel around the inside of the center hole and outside edge of the disc. If you feel any small bumps or irregularities, this could inhibit proper loading of the disc. To remove the bumps, rub the inside edge of the hole and outside edge of the disc with a ballpoint pen or other such instrument, then insert the disc again.

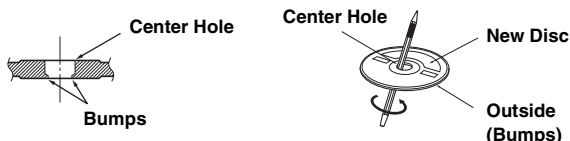

Installation Location

Make sure the INA-W900 will not be installed in a location subjected to:

- Direct sun and heat
- High humidity and water
- Excessive dust
- Excessive vibrations

Correct Handling

Do not drop the disc while handling. Hold the disc so you will not leave fingerprints on the surface. Do not affix tape, paper, or gummed labels to the disc. Do not write on the disc.

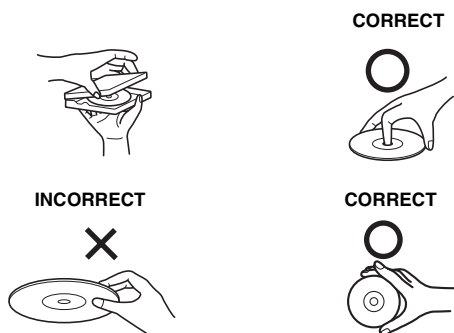

Disc Cleaning

Fingerprints, dust, or soil on the surface of the disc could cause the DVD player to skip. For routine cleaning, wipe the playing surface with a clean, soft cloth from the center of the disc to the outer edge. If the surface is heavily soiled, dampen a clean, soft cloth in a solution of mild neutral detergent before cleaning the disc.



Disc Accessories

There are various accessories available on the market for protecting the disc surface and improving sound quality. However, most of them will influence the thickness and/or diameter of the disc. Using such accessories can cause operational problems. We recommend not using these accessories on discs played in Alpine DVD players.

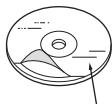

Transparent Sheet

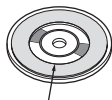

Disc Stabilizer

- After turning the system off, a slight ghost of the image will remain temporarily. This is an effect peculiar to LCD technology and is normal.
- In cold temperature conditions, the screen may lose contrast temporarily. After a short warm-up period, it will return to normal.

Alpine products equipped with the Ai-NET bus, connected to the INA-W900, can be operated from the INA-W900. Depending on the products connected, the functions and displays will vary. For details, consult your Alpine dealer.

Operation of some of the functions of this unit is very complex. Because of this, it was deemed necessary to place these functions into a special screen. This will restrict operation of these functions to times when the vehicle is parked. This ensures the focus of the driver's attention will be on the road and not on the INA-W900. This has been done for the safety of the driver and passengers. Audio Processor Adjustments cannot be made if the car is moving. The car must be parked and the parking brake must be engaged for the procedure described in the Owner's Manual to be valid. The warning "CAN'T OPERATE WHILE DRIVING" will be displayed if any attempts are made to perform these operations while driving.

- *The INA-W900 draws minimal current even when its power switch is turned off. If the switched power (ignition) lead of the INA-W900 is connected directly to the positive (+) post of the vehicle's battery, the battery may be discharged. An SPST (Single-Pole, Single-Throw) switch (sold separately) can be added to simplify this procedure. Then, you can simply place it in the OFF position when you leave the vehicle. Turn the SPST switch back ON before using the INA-W900. For connecting the SPST switch, refer to the "Connection Diagram of SPST Switch (sold separately)" (page 93). If the power (ignition) lead is unswitched, it must be disconnected from the battery post should the vehicle be left unused for an extended period of time.*

Discs Playable on This Unit

Playable Discs

The discs listed below can be played on this unit.

	Mark (logo)	Recorded Content	Disc size
DVD Video		Audio + Video	12 cm*
			8 cm
Music CD		Audio	12 cm
			8 cm (CD single)

* Two-layer DVD disc compatible

The formatted discs listed below can be played on this unit.

	CD-R/ CD-RW	DVD-R/ DVD-RW	DVD+R/ DVD+RW
CD Format	○		
MP3 Format ("mp3")	○	○	○
WMA Format ("wma")	○	○	○
AAC Format ("aac", "m4a")	○	○	○
DVD Video Format		○	○
DVD-VR Format		○	

- Discs that are not finalized cannot be played back.

Discs that cannot be played

DVD-ROMs, DVD-RAMs, CD-ROMs (excluding MP3/WMA/AAC files), photo CDs, etc.

DualDisc

This unit is not compatible with DualDisc.

Using a DualDisc may cause unit malfunction, and may cause disc damage when the disc is inserted/ejected.

DVD region number (playable region number)

This DVD player will play back any disc whose region number is 1 (or All). DVDs with a region number other than those listed below, cannot be played on this DVD player.



Using compact discs (CD/CD-R/CD-RW)

If you use unspecified compact discs, correct performance cannot be guaranteed.

You can play CD-Rs (CD-Recordables)/CD-RWs (CD-ReWritables) which have been recorded only on audio devices. You can also play CD-Rs/CD-RWs containing MP3/WMA/AAC formatted audio files.

- Some of the following discs may not play on this unit:
Flawed discs, discs with fingerprints, discs exposed to extreme temperatures or sunlight (e.g., left in the car or this unit), discs recorded under unstable conditions, discs on which a recording failed or a re-recording was attempted, copy-protected CDs which do not conform to the audio CD industry standard.
- Use discs with MP3/WMA/AAC files written in a format compliant with this unit. For details, see pages 38 and 39.

To customers using CD-R/CD-RW

- If a CD-R/CD-RW cannot be played back, make sure the last recording session was closed (finalized).
- Finalize the CD-R/CD-RW if necessary, and attempt playback again.

Tips for making your own discs

The INA-W900 plays DVD Video and Audio CD and has a built in MP3/WMA/AAC decoder.

The following information is designed to help you create your own music CDs (either Audio CD or MP3/WMA/AAC encoded CD-R/RW files).

What is the difference between an Audio and MP3/WMA/AAC CD?

An Audio CD is the same format as the commercial CDs you buy in the store (also known as CD-DA). MP3 (MPEG-1 Audio Layer 3)/WMA (Windows Media Audio)/AAC (Advanced Audio Coding) is a data file that uses a compression scheme to reduce the size of the music file*.

Hybrid Audio CD and Data (MP3/WMA/AAC) CD-R/RW discs:

The INA-W900 can read either sector on the disc. Choose CD-DA to play the CD audio section or MP3/WMA/AAC to play the MP3/WMA/AAC section*.

Multisession CD-R/RW:

Once a recording has been stopped, this is considered one session. If the disc is not closed (finalized), additional data may be added. Once this additional data has been recorded, this becomes a "multisession" CD. The INA-W900 can only read multisession DATA Formatted discs (MP3/WMA/AAC files - Not Audio CD files).

Properly formatted MP3/WMA/AAC Discs:

Use ISO9660 formatting to insure proper playback. You may use standard ISO naming Level 1 (8.3 DOS standard), Level 2 (32 characters) or Joliet (Windows or Macintosh long filenames) file naming conventions*.

* Please consult the Owner's manual for additional information.

On handling compact discs (CD/CD-R/CD-RW)

- Do not touch the surface.
- Do not expose the disc to direct sunlight.
- Do not affix stickers or labels.
- Clean the disc when it is dusty.
- Make sure that the disc is smooth and flat.
- Do not use commercially available disc accessories.

Do not leave the disc in the car or the unit for a long time. Never expose the disc to direct sunlight.

Heat and humidity may damage the disc and you may not be able to play it again.

Using DVD-Rs/DVD-RWs/DVD+Rs/DVD+RWs

- This unit is compatible with discs recorded in the standard DVD-Video and DVD-VR (DVD-R/DVD-RW only) formats.
- Note that discs not finalized (processed to enable to play on playback-only DVD players) cannot be played on this DVD player.
- Some discs may not play back, depending on the recording device and disc format.
- Discs or files utilizing copy protection, may not be playable.
- Some recording systems may not properly format copied files to enable proper playback.
- In the following cases, the disc may not play on this unit: discs recorded by certain DVD recorders, certain irregular discs, flawed discs, dirty discs, when the pickup lens of this DVD player is dirty, or when moisture condensation has occurred inside the unit.
- Be sure to follow all cautions included with your DVD-Rs/DVD-RWs/DVD+Rs/DVD+RWs discs.
- Do not put stickers, seals, or tape on the label side of DVD-Rs/DVD-RWs/DVD+Rs/DVD+RWs.
- Compared to the regular discs, DVD-Rs/DVD-RWs/DVD+Rs/DVD+RWs are more affected by heat, moisture, and direct sunlight. If left in a car, etc., damage may occur and it might not play on this unit.
- The operable temperature range for disc playback is as follows:
DVD-R/DVD-RW: -25 ~ +70°C
DVD+R/DVD+RW: +5 ~ +55°C

Disc terminology

Title

If titles are programmed for the DVD, these are the largest units of division of the information recorded on the disc.

Chapter

Each Title may also be divided into smaller divisions, called chapters. These can be specific scenes or musical selections.

Protecting the USB connector

- Only an iPhone/iPod, USB memory or Portable audio player can be connected to the USB connector on this unit. Correct performance using other USB products cannot be guaranteed.
- If the USB connector is used, be sure to use only the supplied connector cable with the unit. A USB hub is not supported.
- Depending on the connected USB memory device, the unit may not function or some functions may not be performed.
- The audio file format that can be played back on the unit is MP3/WMA/AAC.
- Artist/song name, etc., can be displayed. Certain, special characters may not be correctly displayed.



CAUTION

Alpine accepts no responsibility for lost data, etc., even if data, etc., is lost while using this product.

On Handling USB Memory

- This unit can control a memory storage device that supports the USB Mass Storage Class (MSC) protocol. Playable audio file formats are MP3, WMA and AAC.
- USB memory function is not guaranteed. Use USB memory according to the terms of agreement. Read the USB memory Owner's Manual thoroughly.
- Avoid usage or storage in the following locations:
 - Anywhere in the car exposed to direct sunlight or high temperatures.
 - Anywhere the possibility of high humidity or corrosive substances are present.
- Fix the USB memory in a location where driver operation will not be hindered.
- USB memory may not function correctly at high or low temperature.
- Use only certified USB memory. Note that even certified USB memory, may not function correctly depending on its type or state.
- Depending on the settings of the USB memory type, memory state or encoding software, the unit may not play back or display properly.
- Files protected by DRM (Digital Rights Management), cannot be played back on this unit. These include AAC formatted files purchased from the iTunes Store and WMA or other files with some form of copyright protection.
- USB memory may take time to start playback. If there is a particular file other than audio in the USB memory, it may take considerable time before the file is played back or searched.
- The unit can play back "mp3", "wma" or "m4a" file extensions.
- Do not add the above extensions to a file other than audio data. This non-audio data will not be recognized. The resulting playback may contain noise that can damage speakers and/or amplifiers.
- It is recommended to back up important data on a personal computer.
- Do not remove the USB device while playback is in progress. Change SOURCE to something other than USB, then remove the USB device to prevent possible damage to its memory.

On Handling Portable audio player

- The unit can control a Portable audio player with the USB interface. Playable audio file formats are MP3 and WMA.
- Portable audio player function is not guaranteed. Use Portable audio player according to the terms of agreement. Read the Portable audio player Owner's Manual thoroughly.
- Avoid usage or storage in the following locations:
 - Anywhere in the car exposed to direct sunlight or high temperatures.
 - Anywhere the possibility of high humidity or corrosive substances are present.
- Fix the Portable audio player in a location where driver operation will not be hindered.
- Portable audio player may not function correctly at high or low temperature.
- Depending on the settings of the Portable audio player type, memory state or encoding software, the unit may not play back or display properly.
- If the Portable audio player has an MSC/MTP setting, set to MTP.
- A Portable audio player in which data is stored by USB Mass Storage may not be playable on the unit.
- Depending on the Portable audio player settings, USB Mass Storage may be supported. For setting, refer to the Owner's Manual of the player.
- The unit can play back MP3/WMA files synchronized by Windows Media Player (Ver. 10 or 11), and are then forwarded to the player. The "mp3" or "wma" extensions are playable.
- If data is not synchronized by Windows Media Player and is forwarded in another way, the unit may not be able to correctly play back the files.
- WMDRM10 is supported by the unit.
- A file that is copy-protected (copyright protection) cannot be played back.
- It is recommended to back up important data on a personal computer.
- Do not remove the USB device while playback is in progress. Change SOURCE to something other than USB, then remove the USB device to prevent possible damage to its memory.

- *This product incorporates copyright protection technology that is protected by U.S. patents and other intellectual property rights. Use of this copyright protection technology must be authorized by Macrovision, and is intended for home and other limited viewing uses only unless otherwise authorized by Macrovision. Reverse engineering or disassembly is prohibited.*
- *Manufactured under license from Dolby Laboratories. Dolby and the double-D symbol are trademarks of Dolby Laboratories.*
- *Manufactured under license under U.S. Patent #'s: 5,451,942; 5,956,674; 5,974,380; 5,978,762; 6,487,535 & other U.S. and worldwide patents issued & pending. DTS and the Symbol are registered trademarks, & DTS 2.0 Channel and the DTS logos are trademarks of DTS, Inc. Product includes software. © DTS, Inc. All Rights Reserved.*
- *Windows Media, and the Windows logo are trademarks, or registered trademarks of Microsoft Corporation in the United States and/or other countries.*
- *iPod and iTunes are trademarks of Apple Inc., registered in the U.S. and other countries.*
- *iPhone is a trademark of Apple Inc.*
- *"Made for iPod" means that an electronic accessory has been designed to connect specifically to iPod and has been certified by the developer to meet Apple performance standards.*
- *"Works with iPhone" means that an electronic accessory has been designed to connect specifically to iPhone and has been certified by the developer to meet Apple performance standards.*
- *Apple is not responsible for the operation of this device or its compliance with safety and regulatory standards.*
- *The BLUETOOTH® word mark and logos are registered trademarks owned by the Bluetooth SIG, Inc. and any use of such marks by Alpine Electronics, Inc. is under license.*
- *HD Radio™ and the HD and HD Radio Ready logos are proprietary trademarks of iBiquity Digital Corp.*
- *"MPEG Layer-3 audio coding technology licensed from Fraunhofer IIS and Thomson."*
- *Audyssey MultEQ XT is a registered trademark of Audyssey Laboratories Inc.*
- *"Supply of this product only conveys a license for private, non-commercial use and does not convey a license nor imply any right to use this product in any commercial (i.e. revenue-generation) real time broadcasting (terrestrial, satellite, cable and/or any other media), broadcasting/streaming via internet, intranets and/or other networks or in other electronic content distribution systems, such as pay-audio or audio-on-demand applications. An independent license for such use is required. For details, please visit <http://www.mp3licensing.com>"*

©2009 NAVTEQ. All rights reserved.

Portions ©2009, Microsoft Corporation. All Rights Reserved.

Getting Started

Accessory List

• Head unit	1
• Power cable.....	1
• Mounting sleeve	1
• Bracket key	2
• Flush Head Screw (M5x8)	6
• Screw (M5x8)	8
• Face plate.....	1
• Mounting Position Seal	2
• GPS Antenna	1
• Pre OUT Cable	1
• AUX I/O Cable	1
• AV extension cable	1
• USB extension cable	1
• USB 30P cable	1
• Owner's Manual	1 set

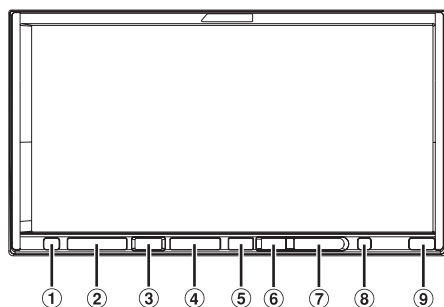

Optional Remote Control Interface Box

This unit is operable using the vehicle's secondary radio controls. An Alpine Remote Control Interface Box (optional) is required. For details, contact your Alpine dealer.

Location of Controls

- 1 ▲ button**
Recalls the Eject/Tilt screen.
If the disc does not eject after touching [Eject] of Disc, press and hold ▲ for at least 3 seconds.
- 2 ∨/∧ button**
Press to adjust the volume.
- 3 MUTE/PHONE button**
Lowers the volume by 20 dB instantly. Press the button again to cancel.
Press and hold for at least 2 seconds to display the Telephone Menu screen.
(When the optional BLUETOOTH INTERFACE (KCE-400BT) is connected and BLUETOOTH IN is set to Adapter.)
- 4 SOURCE/⏻ button**
Turns the power on. Press and hold for at least 3 seconds to turn the power off.
Recalls the SOURCE selection screen.

- 5 AUDIO [] button**
Return to the AV main source screen that is displayed before the Setup, Navigation, Telephone, Camera mode, etc. is started.
Turn on GUIDEVIEW WINDOW™ mode (page 29) when the current screen is audio source screen (Radio, CD, iPod, etc.). Press again to turn if off.
Press and hold for at least 2 seconds to recall the weather channel or traffic channel.
(When the XM or Sirius Receiver Box is connected.)
- 6 MAP button**
Recall the navigation map screen.
- 7 NAVI MENU button**
Recall the navigation menu screen.
- 8 RESET switch**
Be sure to press the RESET switch when using the unit for the first time, after installing the CD changer, after changing the car battery, etc.
Turn off the unit power, press RESET with a ballpoint pen or similar pointed object.
- 9 Remote Sensor**
Point the optional remote control transmitter towards the remote sensor within a range of 2 meters.

About the button descriptions used in this Owner's Manual

- The buttons found on the face of the unit are expressed in bold (e.g. **SOURCE/⏻**). The buttons found on the touch-screen display are shown in bold within brackets, [] (e.g. [**Exit**]).
- This Owner's Manual explains mainly the function of soft buttons, when a soft button and a unit button have the same function.

Turning Power On or Off

Some of this unit's functions cannot be performed while the vehicle is in motion. Be sure to stop your vehicle in a safe location and apply the parking brake, before attempting these operations.

- 1 Press SOURCE/⏻ to turn on the unit.**
 - The unit can be turned on by pressing any button.
- 2 Press and hold SOURCE/⏻ for at least 3 seconds to turn off the unit.**
 - Some operation of the unit cannot be performed while the vehicle is in motion. In this case, be sure to first stop your vehicle and apply the parking brake, then perform the operation.
 - The INA-W900 is a precision device. With gentle handling, its unique capabilities can be enjoyed for a long time.

Inserting/Ejecting a Disc

1 Press **▲** on the unit.

The display changes to the Eject/Tilt screen.

2 Insert a disc:

Touch [Open] on the Eject/Tilt screen.

The movable monitor will open, then insert a disc into the disc slot. Inserting a disc will close the monitor automatically.

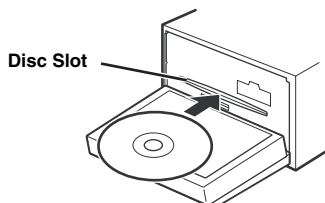

Eject the disc:

Touch [Eject] of Disc on the Eject/Tilt screen.

The movable monitor will open. Then the disc is ejected.

After remove the disc, touch [Close] to close the movable monitor.

- Touching [Exit] returns to the earlier main source screen.
- Do not apply shock to the movable monitor when it is open as it may result in malfunction of the unit.
- The monitor may be dim during low temperature and immediately after turning on the power. The brightness will return to normal as time elapses.
- The monitor will stop at the set tilt angle when closing.

CAUTION

Keep hands (or any other object) away from the monitor while it is opening or closing to avoid damage or injury. The back of the movable monitor will get very warm under normal operating conditions. This is not a malfunction. Do not touch.

Inserting/Removing the SD Memory Card

You can update the software and map of navigation system by using an optional SD memory card. To insert and take out the SD memory card, follow the instructions below.

1 After opening the movable monitor, open the cover of SD memory card slot.

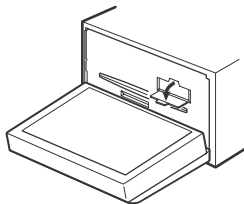

Insert the SD memory card

2 Insert your SD memory card until it clicks.

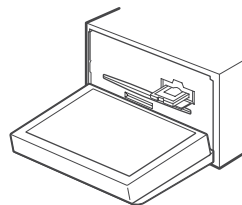

Remove the SD memory card

2 Push the SD memory card that is inserted.

The SD memory card is pulled out.

3 Close the cover of SD memory card slot.

4 Close the moveable monitor.

Adjusting the Monitor Viewing Angle

Adjust the monitor's angle for better visibility.

1 Press **▲** on the unit.

The display changes to the Eject/Tilt screen.

2 Touch [**▲**] or [**▼**] of Tilt to adjust the desired monitor angle.

The monitor angle can be adjusted in 5 stages.

3 Touch [Exit] to return to the previous screen.

- If the monitor touches an obstacle while the angle is being adjusted, it will stop immediately.
- The screen color will vary when viewed at certain angles. Adjust the screen angle for the best viewing position.
- If the voltage of the vehicle's battery power is low, the screen may blink when the screen angle is changed. This is normal and not a malfunction.

Adjusting the Volume

Adjust the volume by pressing **▼** or **▲**.

Volume decreases/increases continuously by pressing and holding **▼** or **▲**.

Volume: 0 - 35

Lowering Volume Quickly

Activating the Audio Mute function will instantly lower the volume level by 20 dB.

Press **MUTE** to activate the MUTE mode.

The audio level will decrease by about 20 dB.

Pressing **MUTE** again will bring the audio back to its previous level.

How to view the Display

Soft button operation

- Be sure to touch the button lightly with the pad of your finger on the display to protect the display.
- If you touch a button and there is no reaction, remove your finger from the display, and try again.

About the button descriptions used in this Owner's Manual

- Soft buttons, ones found in the display, are shown in bold enclosed in brackets, [] (e.g. [Exit]).
- Whenever a soft button and a head unit button have the same function, the explanations in this Owner's Manual will describe the function of the soft button.

Recalling the Source

Here is an example explanation for the Radio mode display on how to recall a source.

1 Press **SOURCE/** on the unit.

The SOURCE selection screen is displayed.

Display example for SOURCE selection screen

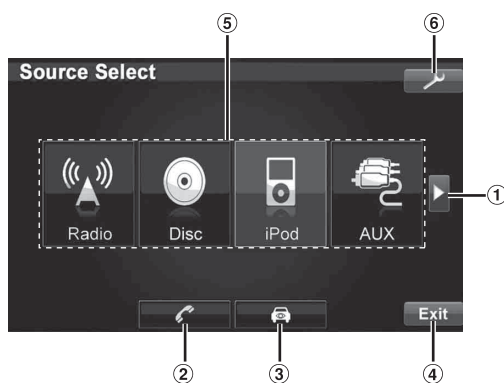

- ① Changes the items of source selection list.
- ② Changes to the Telephone Menu screen. (When the optional BLUETOOTH INTERFACE (KCE-400BT) is connected and "BLUETOOTH IN" is set to Adapter (page 55).)
- ③ Displays the rear view camera. (When an optional rearview camera HCE-C107D, etc. is connected and Camera IN is set to ON).
- ④ Changes to main source screen.
- ⑤ Displays the source selection list. (The kind of source modes that are displayed varies depending on connection and setting).
- ⑥ Changes to SETUP main screen.

2 Touch [Radio].

The screen changes to the Radio mode main display.

- If your desired source is not displayed on the screen, touch [▶] to change the items of the source selection list first. Then touch the desired source key.

Display example for FM Radio main screen

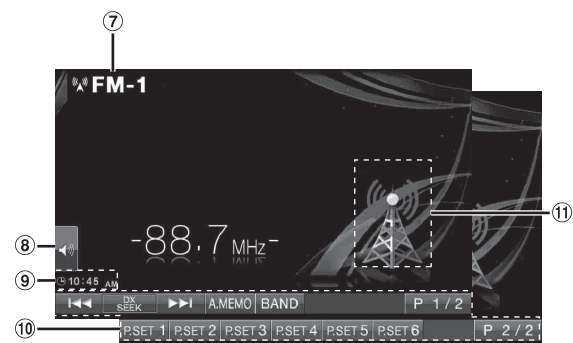

- ⑦ Displays the source name, such as radio band, etc., that is selected.
- ⑧ Changes to the Bass^{*1}, Treble^{*1} and Subwoofer^{*2} Level adjustment screen directly. When an optional IMPRINT audio processor (PXA-H100) is connected to this unit, MEDIA XPANDER level may also be adjusted directly.
 - If the optional IMPRINT audio processor (PXA-H100) is connected, Defeat and MultiEQ must be set to OFF to adjust the MEDIA XPANDER directly.
- ⑨ Displays the time.
- ⑩ Function Guide: The function guide display varies depending on each source. The contents of the function guide change by touching [P1/2]^{*3}, [P1/3]^{*3} or [P1/4]^{*3} on the function guide, and many other operations can be performed.
- ⑪ Displays the icon of current source or artwork image^{*4}. If the GUIDEVIEW WINDOW™ mode is activated, the information of Navigation system will be displayed in this area.

^{*1} Adjustment cannot be performed when DEFEAT is set to ON.

^{*2} Adjustment cannot be performed when SUBWOOFER is set to OFF (page 45).

^{*3} Display may vary depending on the connected devices.

^{*4} If the playing song contains artwork data, the artwork image can be displayed (Only for USB Audio and iPod mode).

Displaying the Numeric Keypad Input Screen

The numeric keypad input screen is displayed when the DVD mode is selected for searching a title or chapter. It can also be used for entering a country code or password for DVD setup, and for selecting a channel number in the SAT Radio mode etc.

- 1 Touch **[10KEY]** on the selected source screen.
- 2 Touch the desired numeric key.

Display example for numeric keypad

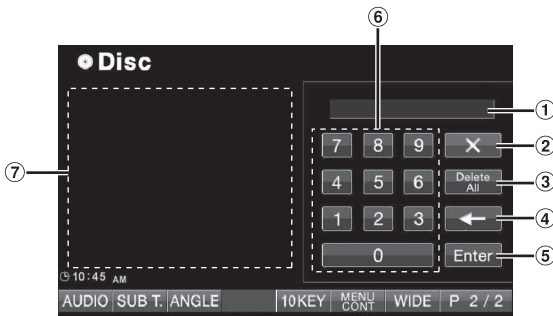

- ① Input screen area
- ② Closes numeric keypad input screen
- ③ All input numbers will be deleted.
- ④ Previous number will be deleted.
- ⑤ Input number is confirmed.
- ⑥ Numeric keypad
- ⑦ The numeric keypad input screen closes when the area is touched while displayed.

- 3 Touch **[Enter]** to confirm your entry.

Navigation

Basic Operation

The INA-W900 GPS Navigation Receiver provides an easy-to-use user interface, clear, easy-to-understand spoken driving instructions, and award winning design.

INA-W900 is built upon Alpine's history of navigation success in North America. Please read this manual carefully. If you have any further questions about INA-W900's operation, feel free to call Alpine at 1-888-NAV-HELP (628-4357) for technical assistance.

Turning the Navigation System On

With this system, every time when the ignition key is turned to the ACC or ON positions and navigation mode is activated, the opening screen will be displayed automatically.

- 1 Press **MAP** or **NAVI MENU** on the unit to activate the navigation system.
- 2 Every time you boot up the system, both the language selection menu and **IMPORTANT!** are displayed on the screen. Touch the desired language.



After the language has been selected, important information is displayed in each language. Be sure to read the important information.

- 3 After you have read this important information, touch **[I Accept]**.
The map or Navigation Main Menu screen is displayed.

Navigation Main Menu

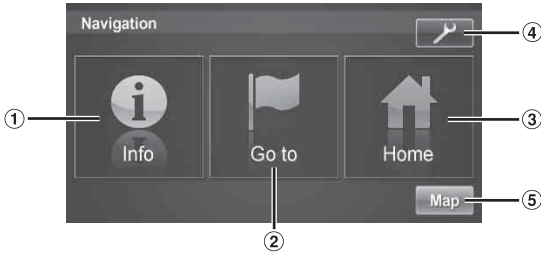

1 Info Button

Touch this to check information such as:

- GPS receiver status
- Speed and trip information

See pages 33-34.

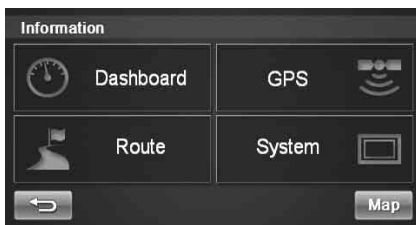

2 Go to Button

Touch this to start entering a destination. See pages 20-25.

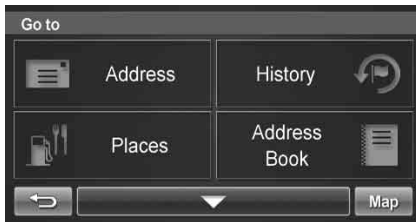

3 Home Button

Press this to go to a saved home location. See page 29.

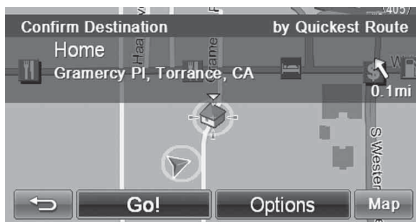

4 Settings Button

Press this to change system settings. See pages 30-33.

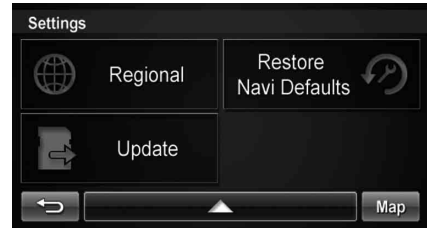

5 Map Button

Touch this to go to the map. See page 18.



Map Functions



1 Next Maneuver Arrow and Voice Prompt Button



Repeating the Announcement

Touch this icon to repeat the guide announcement. (Same as Next Maneuver Arrow)

2 Route Button



Touch this icon and it will take you to the route menu.

- When not in the guidance mode, only the current position can be seen. Zoom buttons, Map Orientation button and Main Menu are available.

③ Estimate Time Display

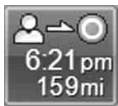

This icon displays Estimated Time Remaining, Estimated Time of Arrival or Direction to Destination. See page 32 to change this setting.

- The time estimates are based on the average speed. The estimate time will vary depending on vehicle speed. The arrow always points toward the destination.

④ Map Orientation

Touch this icon to switch between North Up, Heading Up and 3D View.



North Up

In north up view, north is always at the top of the display. This makes it easy to determine your current heading with respect to the map.



Heading Up

In heading-up view, the current direction is always pointing to the top of the display. This makes it easy to see the direction of the next turn on the map.



3D View

The 3D View offers you a more realistic perspective by tilting the map and displaying it with a horizon line. Streets are displayed as you approach them instead of from a birds-eye view.

⑤ GPS Status Bar



GPS Signal Strength

⑥ Current Position

⑦ Switch Guidance Map

- You can choose between full map and arrow only in guidance mode.



Switch Arrow Only

Displays three successive arrow maneuvers all the way to your destination while providing turn-by-turn guidance prompts.



Switch Full Map

Shows a full-screen map of the area while providing turn-by-turn guidance prompts.

⑧ Zoom Out Button



Touch this icon to zoom out.

⑨ Zoom In Button



Touch this icon to zoom in.

⑩ Main Menu Button

⑪ Next Street Name

⑫ Highway Exit Button

When the vehicle is on a Highway, the screen is displayed. Highway exit information is displayed as a list in order of close proximity to current position. You can also set a waypoint, etc., by touching the desired Highway Exit.

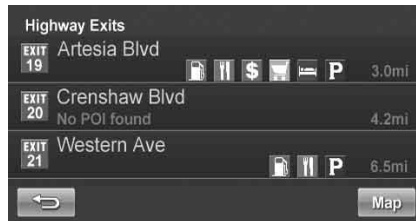

From the Map Display

Setting a Destination

- 1 Touch anywhere on map screen.
- 2 The vehicle arrow changes to a crosshair cursor.

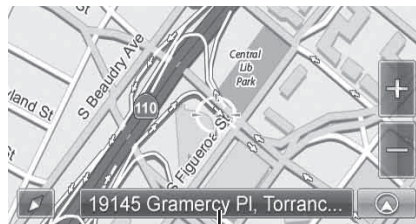

Position bar

- 3 Move the cursor to the new desired street.
 - Use Map Zoom button to zoom out the map if the destination is far from the current location.
- 4 Touch the selected position bar on the bottom of the screen.
- 5 Select Set as Destination.



- 6 Touch [Go!] on the Confirm Destination Screen.

- To use destination options on the Confirm Destination Screen, see pages 25-27 for details. To cancel, touch Previous Screen icon .

Finding Local Places

- 1 Touch anywhere on map screen.
The vehicle arrow changes to a crosshair cursor.
- 2 Touch the selected position bar on the bottom of the screen.
- 3 Select Find Nearby Places.
- 4 Select the desired category and the desired place.

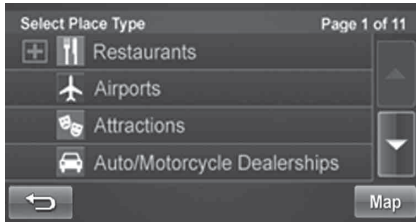

- 5 Touch [Go!] on the Confirm Destination Screen.

- To use destination options on the Confirm Destination Screen, see pages 25-27 for details. See Find Local Places on pages 22-23 for finding places through Places menu.

Setting Waypoints

- 1 Touch anywhere on map screen.
- 2 The vehicle arrow changes to a crosshair cursor.
- 3 Move the cursor to the desired waypoint.
- 4 Touch the selected position bar on the bottom of the screen.
- 5 Select Set as Waypoint and the destination will automatically be added to the Waypoint List.



- 6 Touch [Go!].

- To add another waypoint, see page 27.

Input a Destination

Go to Menu

Go to Main Menu → Go to

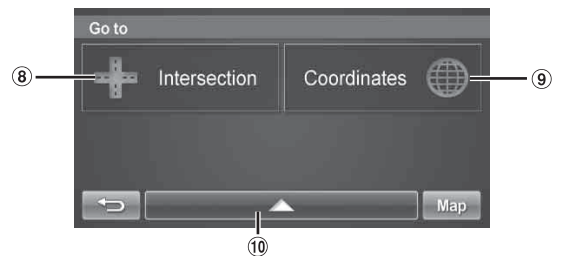
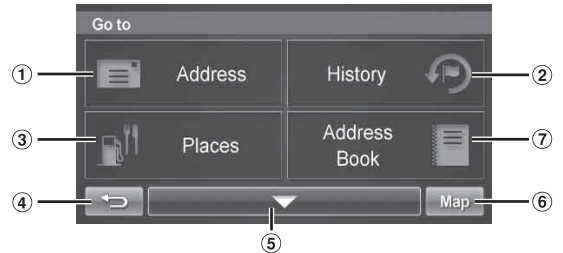

- 1 Address Button

Search by typing an address. See page 21.



- Last 4 Streets/Last 4 Cities:
The last four street names and city names searched are stored in memory.
You can reselect a street name/city name from this list.

- 2 History Button

Select from recent destinations. See page 23.



③ **Places Button**

Select places. See pages 22-23.



④ **Returns to the previous screen.**

⑤ **Page List Down**

⑥ **Map Button**

Press this to go to the map. See page 18.

⑦ **Address Book Button**

Select from saved destinations. See page 24.

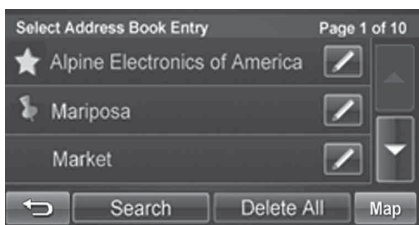

⑧ **Intersection Button**

Set destination by intersection. See pages 24-25.



- Last 4 Streets/Last 4 Cities:
The last four street names and city names searched are stored in memory.
You can reselect a street name/city name from this list.

⑨ **Coordinates Button**

Set destination using geographic coordinates. See page 24.



⑩ **Page List Up**

Set a Destination by Address

There are several ways to set a destination. You can set a destination directly from the map (page 19) or select Go to from the main menu.

Go to Main Menu → Go to → Address

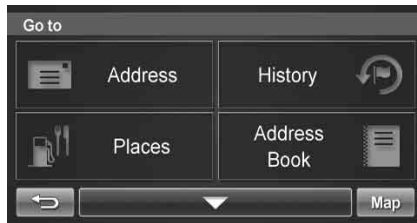

Finding a Destination by Entering Street Name First

1 **Select by Street.**

2 **Type the street name and touch [OK].**



If there are multiple matches, the system automatically displays a short list of street names. Type only the name of the street. Prefix and suffix of the street are not necessary. The list of applicable street names appears.

3 **Select the desired street name from the list.**



4 **Type the address number and touch [OK].**



5 Type the desired city.

If there are multiple matches, the system lists cities containing the street name and address number that you keyed in.

6 The Confirm Destination Screen appears. Touch [Go!] to calculate the route.



7 See pages 25-27, to see more details about Options on the confirmation destination screen.

Finding a Destination by City Name First

1 Select by City.

2 Type the city name and touch [OK].



If there are multiple matches, the system automatically displays a short list of city names. Select the desired city.

3 Type the characters of the street name and touch [OK].

4 The list of applicable street names appears. Select the desired street.

5 Type the address number and touch [OK].

6 The Confirm Destination Screen appears. Touch [Go!] to calculate the route.

Set a Destination by Place

You can select from approximately 6 million place locations stored inside your INA-W900 GPS Navigation System.

Go to Main Menu → Go to → Places



Finding a Place From Here or Near Your Destination

- *Last 4 names and Last 4 types* takes you to a list from the last 4 places/types you have previously entered.
- *If you find a place near your destination:*
When you arrive at a destination, a destination name (POI search), address and telephone number are displayed in the display bar. If you want to display a trip summary, touching the arrow in the display bar, and [Summary] will display a detailed trip summary.

Display bar



By Name

1 Select by Name.



2 Type the desired place name. Touch [OK].



A list of place names appears.

3 Use the arrow to the right of the list to scroll up and down the list.

4 Select the desired place.

For emergency locations such as Police Stations, Hospitals, etc., please verify availability before proceeding to such locations.

5 The Confirm Destination Screen appears. Touch [Go!] to calculate a route.

By Type

1 Select by Type.

2 Select a desired type.

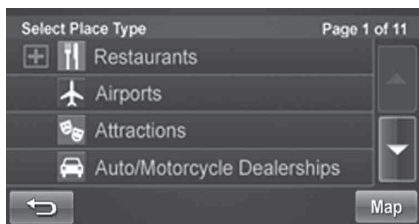

3 There are 37 Place categories to choose from including ATMs, Banks, Gas Stations, Grocery Stores, Hotels, Parking Lots, Restaurants and more.

4 Follow steps 3 through 5 of the instructions above.

Finding a Place From City Center

1 Select From City Center.

2 Select by City.



• Last 4 Cities takes you straight to the list of cities you have previously entered.

3 Type a city name and select a city.

4 You can choose by Name or by Type.

5 Follow steps from “by Name” or “by Type” on page 22.

Finding a Place along Your Route

1 Select Along Route.

2 Select the desired place type button. Touch [OK].

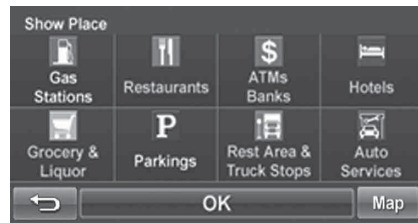

• Highlighted button means it is selected. You can select multiple place types. Touch the button again to turn the selection on or off.

3 A list of places appears

Select the desired place.

4 Touch [Go!].

Set a Destination by History

Go to Main Menu → Go to → History

1 The list of recent destinations appears. Select the destination.



2 The Confirm Destination Screen appears. Touch [Go!] to calculate the route.

• To use destination options on the Confirm Destination Screen, see pages 25-27 for details.

Deleting All History

Go to Main Menu → History

1 Touch [Clear All].

2 Touch [Clear All] to delete all previous destinations.

Set a Destination from the Address Book

Go to Main Menu → Go to → Address Book

1 Select the desired destination.

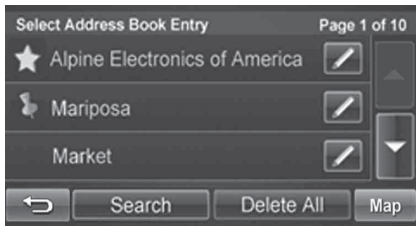

2 The Confirm Destination Screen appears. Touch [Go!] to calculate the route.

Editing Address Book

The lockout function applies to Setup Menu and Edit Address Book. To edit address book, your vehicle must be parked with the ignition key in the ACC or ON position. To do this, follow the procedures below.

- 1 Bring your vehicle to a complete stop at a safe location. Engage the parking brake.
- 2 Keep pushing the foot brake and release the parking brake once then engage it again.
- 3 When the parking brake is engaged for the second time, release the foot brake.

- For automatic transmission vehicles, place the transmission lever in the Park position.

Go to Main Menu → Go to → Address Book

1 Select the destination you would like to modify.

2 Touch  to edit your entry.

3 Edit Name, Phone Number and Icon or delete the selected destination.

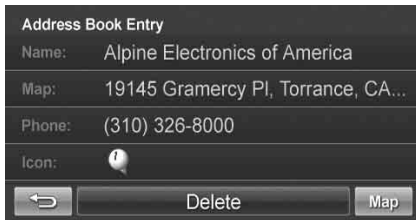

- Select Delete All to delete all addresses saved in the address book.

Set a Destination by Coordinates

Go to Main Menu → Go to → Coordinates

1 Enter the Latitude of your destination. Touch [OK].



2 Enter the Longitude of your destination. Touch [OK].



3 The Confirm Destination Screen appears. Touch [Go!] to calculate the route.

- To use destination options on the Confirm Destination Screen, see pages 25-27 for details.

Set a Destination by Intersection

Go to Main Menu → Go to → Intersection



Finding a Intersection by Entering a Street Name First

1 Select by Street.

2 Type in the first street name. Touch [OK].

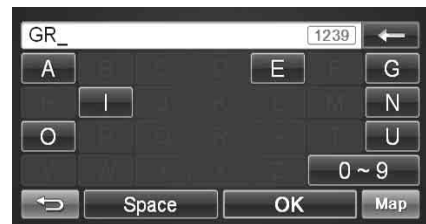

The list of applicable street names appears. Select the desired street and input the address number.

3 Input the second street name.

If there is only one street crossing with the first street, the name of the street automatically appears.

4 Confirm City name if there are more than one city with the same intersection.

- 5 The Confirm Destination Screen appears. Touch [Go!] to calculate the route.



- To use other functions on the Confirm Destination Screen, see pages 25-27 for details.

Finding an Intersection by Entering a City Name First

If you know the city name of the intersection you are searching, select by City. The choice of the street is narrowed down automatically. This saves time in entering the street information.

- 1 Select by City.
- 2 Type the city name, then select the city from the list.

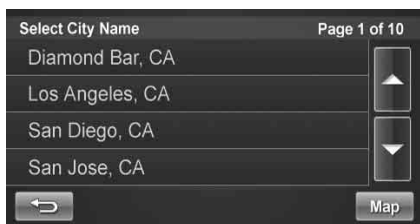

- 3 Input the first street name.
- 4 Input the second street name.
- 5 The Confirm Destination Screen appears. Touch [Go!] to calculate the route.

- Last 4 Street and Last 4 Cities takes you to a list of the last 4 entries.

Destination Options

The Destination Options Menu allows you to find places nearby, find alternative routes to get to your destination, set a destination as your home, save a destination in the address book, and create waypoints.

To get to the Destination Options Menu, enter your desired destination by using the method on pages 20-25 in order to get to the Confirm Destination Screen.

Select Options.



Finding Nearby Places

- 1 Touch [Find Nearby Places].

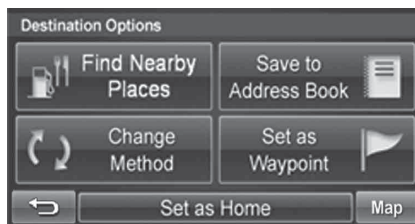

- 2 Select a desired place type.
- 3 Select a desired place name.
- 4 Touch [Go!] to calculate the route.

- To find local places directly from the map, go to page 20.

Finding Alternative Routes to the Destination

- 1 Touch [Change Method].
- 2 Select a method below.



Avoid Freeway
 Avoid Toll Road
 Use Time Restricted Road
 Avoid Ferry

- 3 Select Quickest or Shortest.
- 4 Touch [OK].

Setting a Destination as Home

- 1 Touch [Set as Home].
- 2 Touch [OK] or type desired name and touch [OK].

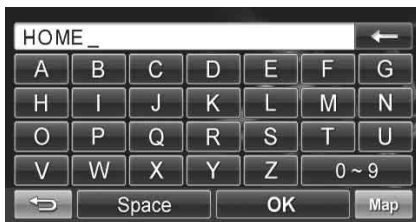

- 3 Select desired icon. If there is no desired icon, touch [No Icon].

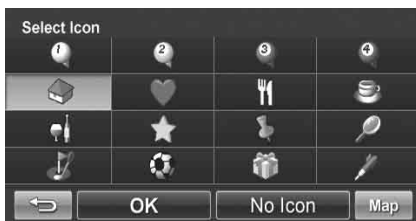

- 4 Touch [OK].

Saving a Destination into the Address Book

- 1 Touch [Save to Address Book].

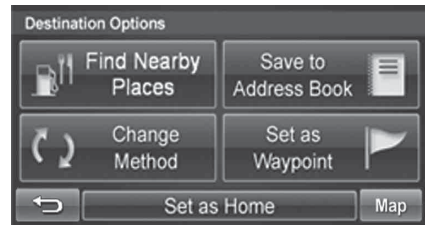

- 2 Type in desired name. Touch [OK].
- 3 Select an icon. If there is no desired icon, touch [No Icon].
- 4 Touch [OK].

Setting Waypoints

You can set up to 3 waypoints between your current location and your destination. The final destination must be set before entering any waypoints.

Adding a Waypoint

- 1 Touch [Set as Waypoint] and the destination is automatically added to the Waypoint List.



- 2 Touch [Go!] to calculate the route.

Adding another Waypoint

- 1 Before you touch [Go!] at the Waypoint List screen, touch [+ Add Waypoint].
- 2 Enter the waypoint with any method just as finding a destination. (pages 20-25)

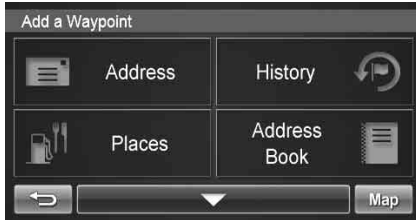

- 3 Touch [Set as Waypoint] to confirm.
- 4 The system returns to the Waypoint List screen. Touch [Go!] to calculate the new route.

Setting a Waypoint Directly from the Map

See page 20.

Optimizing Your Route

- 1 Touch [Set as Waypoint]. The Waypoint List appears.
- 2 Touch [Options]. Waypoint options screen appears.
- 3 Touch [Optimize Route].



- 4 The system takes you back to the Waypoint List screen with optimal route. Touch [Go!] to calculate the route.

Deleting a Waypoint

- 1 Select the desired waypoint to delete from the list.
- 2 Touch [Delete].

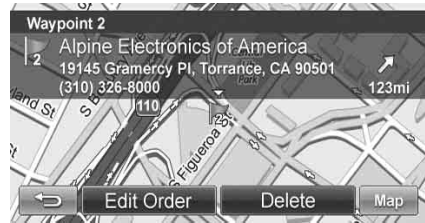

Deleting All Waypoints

- 1 Touch [Options].
- 2 Touch [Delete All Waypoints]. Touch [Delete All] to confirm.

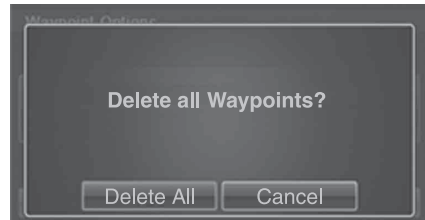

- 3 If all waypoints are deleted, will return to the waypoint list. To get back to the Map screen, touch [Map] to get back to the map.

Editing Order of Waypoints

- 1 Main Menu → Info → Route → Edit Waypoint or from the Map → Route Button → Edit Waypoint
- 2 At the Waypoint List Screen, select the desired waypoint to edit.
- 3 Touch [Edit Order].

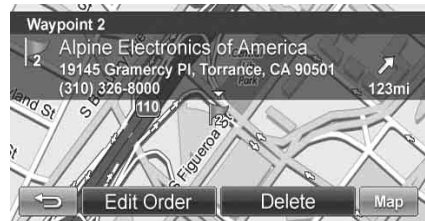

- Use the Up and Down buttons to move the waypoint.

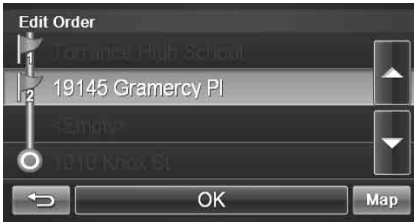

- Touch [OK] and the system returns to the Waypoint List screen.

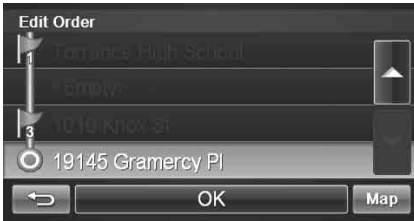

- Touch [Go!] to calculate the route.

ROUTE

Viewing Turn List During Guidance

You can view a list of street names and upcoming turns and streets.

Main Menu → Info → Route

or

directly from the Map 

- Touch [View Turn List].

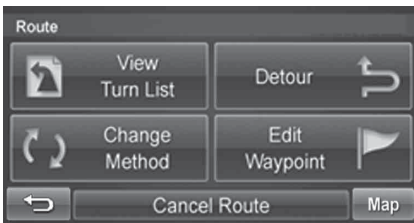

- A list of upcoming streets and turns appears on the screen.

To preview a specific point, select a street name/maneuver on the list.

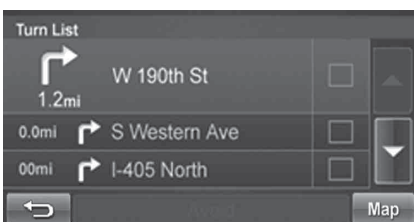

Finding an Alternate Route

- On Route screen, touch [Change Method].

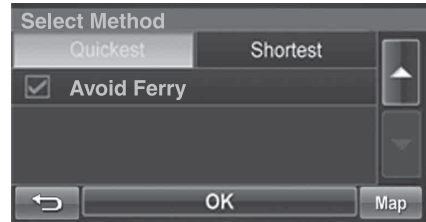

- You can select and re-calculate an alternate route based on Quickest Route or Shortest Route and select Avoid Freeway, Toll Road, Time Restricted Road or Ferry.

Finding a Detour

By Distance

- On Route screen, touch [Detour].
- Choose detour from 1/2 mile, 1 mile, 2 miles or 5 miles.

The system automatically calculates and displays a detoured route.



Avoiding a Particular Street

- 1 Touch [View Turn List].
- 2 List of upcoming streets and turns appears on the screen. Select the street name, and touch its check box.

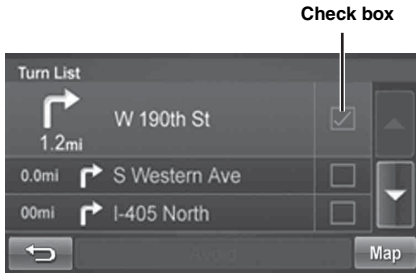

- 3 Touch [Avoid].

Editing Waypoints

To edit waypoints, see page 27.

Canceling Route

From Route screen, touch [Cancel Route].

- After canceling the route, you cannot select Route Menu until the next destination has been set. To set next the destination, see Go to Menu on page 20.

Home

You can go Home from anywhere once the Home Address is set. See page 26 to set a destination as Home.

Going Home

Go to Main Menu → Home

- 1 Touch [Go!] to calculate the route.



GUIDEVIEW WINDOW™ Function

This function allows you to get the navigation information from the normal screen of Audio Source promptly.

Turn on the GUIDEVIEW WINDOW™ Mode

Go to any audio source screen, press AUDIO  hardkey to turn on GUIDEVIEW WINDOW™. Press again to turn it off.

GUIDEVIEW WINDOW™ Display

Start-Up

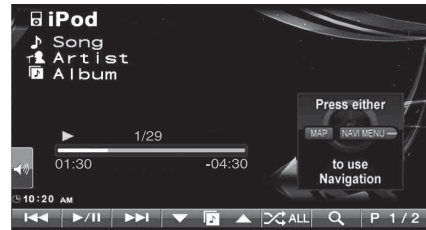

Press either Map or NAVI MENU hardkey to use navigation system.

Non Guidance



- ① Compass will display vehicle moving direction by red arrow based on the North direction at the top of screen.
- ② The Current street name that the vehicle is matched on to is displayed.
If no GPS signal, the text "Locating GPS Satellites" will be displayed.
If your vehicle is off segment, nothing is displayed in the current street name location.

Route Guidance

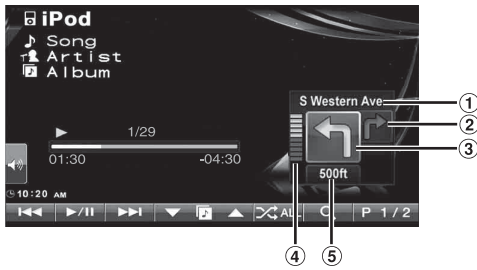

- ① The street name of the next maneuver is displayed in the top portion of the screen.
- ② Second immediate maneuver arrow is displayed only for double maneuvers along the route.
- ③ The maneuver arrow is displayed for the upcoming guidance.
- ④ A countdown bar is displayed when approaching the maneuver.
- ⑤ The distance to the maneuver is displayed at the bottom of the arrow.

Confirm Route



If any action confirmation is required, press either MAP or NAVI MENU hardkey to complete the confirmation.

Rerouting

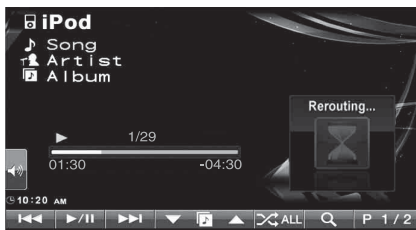

It will be displayed when the rerouting is calculated.

Settings

Settings Menu

The lockout function applies to Setup Menu and Edit Address Book. To enable setup menu, your vehicle must be parked with the ignition key in the ACC or ON position. To do this, follow the procedures below.

- 1 Bring your vehicle to a complete stop at a safe location. Engage the parking brake.
- 2 Keep pushing the foot brake and release the parking brake once then engage it again.
- 3 When the parking brake is engaged for the second time, release the foot brake.

- For automatic transmission vehicles, place the transmission lever in the Park position.

Go to Main Menu →

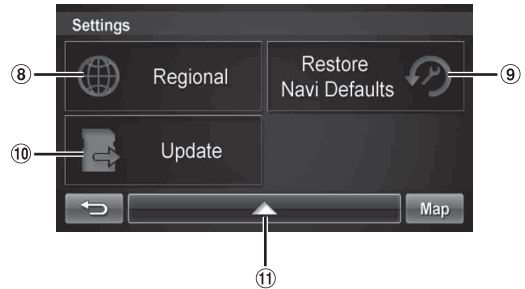
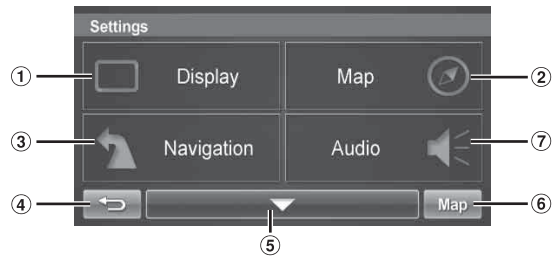

① Display Button

For display settings, see page 31.

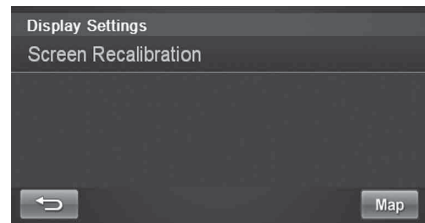

② Map Button

For map settings, see page 31.

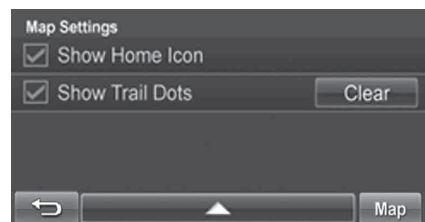
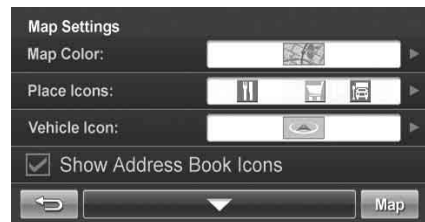

③ **Navigation Button**

For navigation settings, see page 32.

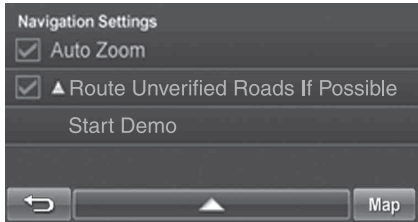
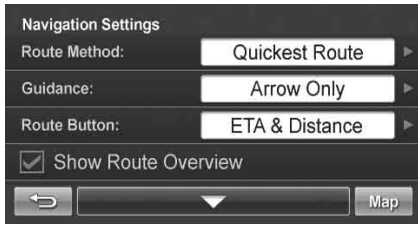

④ **Returns to the previous screen.**

⑤ **Page List Down**

⑥ **Map Button**

Press this to go to the map. See page 18.

⑦ **Audio Button**

For audio settings, see page 32.

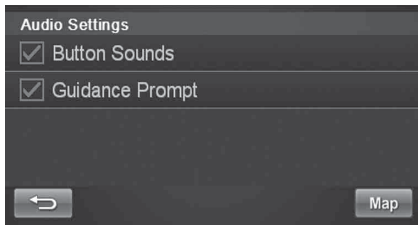

⑧ **Regional Button**

For Regional settings, see page 32.



⑨ **Restore Navi Defaults Button**

This allows you to delete all stored information and default back to the original factory settings.



⑩ **Update Button**

For Update operation, refer to ALPINE website.

- Please do not shut off power or remove the SD card during the update.

⑪ **Page List Up**

Customizing Display

Go to Main Menu → → Display

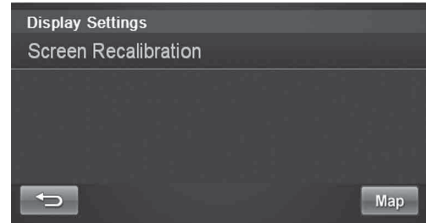

- The Day/Night mode map color will be changed automatically based on sunrise and sunset time.

Screen Recalibration

This allows you to recalibrate the touch screen for better accuracy.

Customizing Map

You can customize map color, vehicle icon, and place icons on the map.

Go to Main Menu → → Map

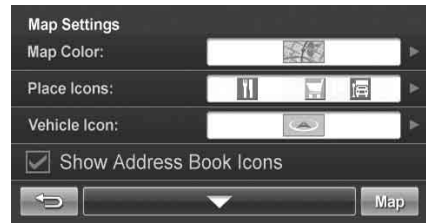

- Touch [OK] to complete the setting.

Displaying and Editing Icons on the Map

Place Icons, the Home Icon and Icons used in the Address Book can be turned on and off from the Display Setup Menu.

Showing Trail Dots

The Trail feature allows you to turn on and off trail dots that appear wherever the vehicle icon traverses. This is especially helpful for off-road enthusiasts.

Customizing Navigation Tool

Go to Main Menu →  → Navigation

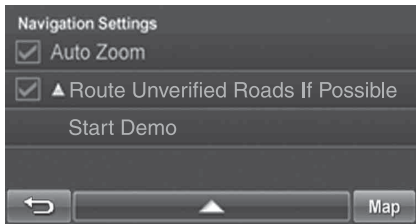
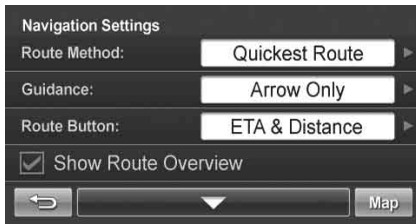

Route Method

You can change the default routing method.

See page 28 for details.

Guidance Map

You can choose between full map and arrow only in guidance mode.

Route Button

You can choose between 3 different route buttons.

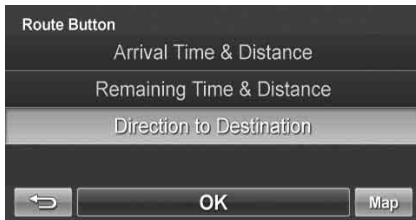

Arrival time & distance to destination.

Remaining time & distance to destination.

Direction of destination.

Show Route Overview

This button allows you to view the full route after the destination has been calculated and before the guidance begins.

Auto Zoom

This button, when selected, allows the map to automatically zoom in when approaching maneuver.

Route Unverified Roads if Possible

This button avoids using roads not verified by the map provider.

Start Demo

You can watch a navigation demonstration with the system's voice and screen guidance.

- Set a destination before using this function.

Setting Audio

Go to Main Menu →  → Audio

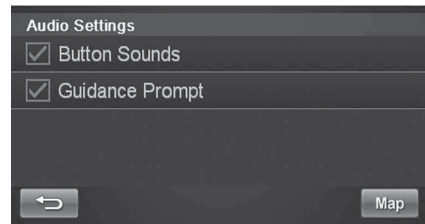

Button Sounds

This allows you to turn button sounds ON or OFF.

Guidance Prompt

This allows you to turn ON or OFF the guidance prompts.

Regional Settings

Go to Main Menu →  → Regional



Language

You can select a Language from English, French and Spanish.



Units

You can set the Units of Measure to read in kilometers or miles.

Clock

You can set the Clock to 12 or 24 hour style and set Daylight Savings to fit your region.

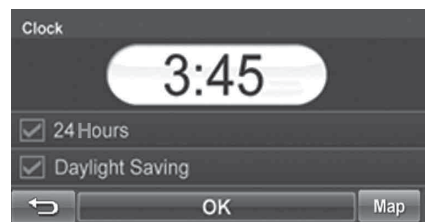

Time Zone

You can set the Time Zone to fit your region.



Information

Information Menu

Go to Main Menu → Info

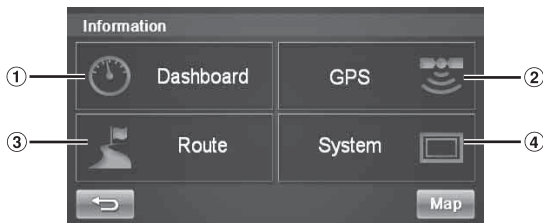

1 Dashboard Button

For viewing dashboard, see page 33.

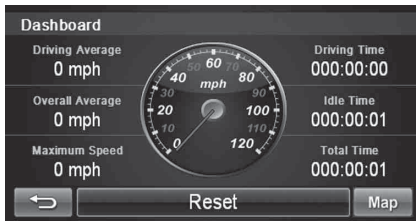

2 GPS Button

For viewing GPS, see page 33.

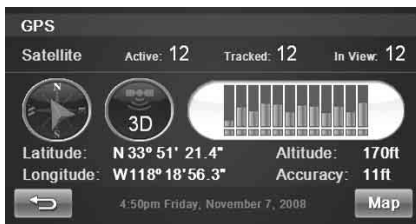

3 Route Button

For changing the route, see page 28.



4 System Button

For viewing system information, see page 34.

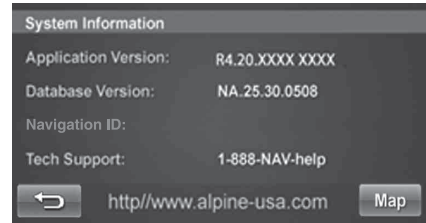

Viewing Dashboard

Go to Main Menu → Info → Dashboard

The odometer displays the speed and time traveled.

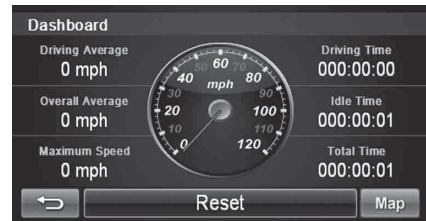

Driving Average	Average speed.
Overall Average	Average speed (includes idle time).
Maximum Speed	Maximum speed reached.
Driving Time	Time vehicle has been moving.
Idle Time	Time vehicle has been stopped (not moving).
Total Time	Total elapsed time (driving time plus idle time).

Viewing GPS Status

This feature allows you to view GPS satellite signal information. You can view the dynamic location information received from satellite, such as, signal strength, compass (direction information), latitude/longitude, approximate altitude.

An explanation of the messages is shown below.

Go to Main Menu → Info → GPS

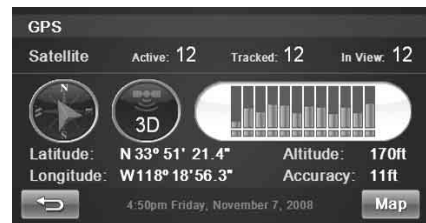

The following messages are displayed while the GPS receiver is tracking satellites:

Locating GPS Satellites

The INA-W900 searches the sky looking for GPS satellites.

Acquiring GPS Signal

The INA-W900 acquires positioning information transmitted from 1 to 3 tracked satellites while searching for more satellites (minimum 4 of needed).

Fixing GPS Position

The INA-W900 requires continuous signals from 4 or more tracked satellites (for 30 seconds) in order to accurately fix your position.

Temporary Poor GPS Coverage

Thunderstorms, dense foliage or surrounding tall buildings may cause temporary loss of position fix (acceptable if under 30 seconds).

Poor GPS Signal, Lost Position Fix

You may have entered an area where consistently poor GPS signal (lasting 30 seconds or more) makes it impossible to maintain a position fix.

No Line of Sight, Lost GPS Tracking

You are in an area where line of sight to GPS satellites has been blocked.

Viewing System Information

You can check software application, database version, and other information on this screen.

Go to Main Menu → Info → System

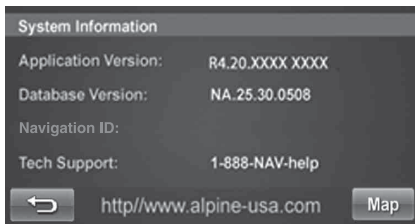

- Make a note of this information and refer to it whenever you communicate with customer support.

Radio

Display example for FM Radio main screen

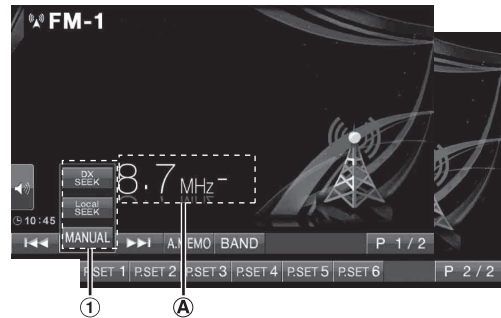

- ① [DX SEEK]* button: Displays the tuning mode selection list.
- Ⓐ Displays the preset number/frequency

* The button displays the current tuning mode.

This unit cannot receive HD Radio signals (digital terrestrial radio). In order to activate the digital radio functions described below, an optional HD Radio Tuner module must be connected through the Ai-NET bus.

Listening to the Radio

- 1 Press **SOURCE**/ ϕ on the unit.
The SOURCE selection screen is displayed.

Receiving Analog Radio signals:

- 2 Touch **[Radio]**.
The radio mode is activated and the display changes to the Radio Mode screen.
If the optional HD Radio Tuner module is connected, the digital radio mode is activated and the display changes to the HD Radio Tuner Mode screen.

- 3 Touch **[BAND]** to select the desired radio band.
Each press changes the bands as follows:

FM-1 → FM-2 → AM → FM-1

- 4 Touch **[DX SEEK]*** to choose the tuning mode.

DX SEEK Local SEEK MANUAL



- There are two modes you can select for auto tuning, DX and Local:
 - DX (Distance) mode;
Both strong and weak stations will be tuned in.
 - Local mode;
Only strong stations will be tuned in.
The initial setting is DX.

5 Touch [**◀◀**], [**▶▶**] or [**◀**], [**▶**] to change the radio frequency up or down respectively.

In manual mode, touch and hold to change the frequency continuously.

- “Digital” is displayed when a digital radio station is received. Refer to “Digital SEEK Setting (HD Radio™ mode only)” on page 50.

Presetting Stations Manually

1 Tune in a desired radio station you wish to store in the preset memory by manual or automatic seek tuning.

2 Touch [**P1/2**]* to change the function guide.

* [P 1/3] is displayed in the HD Radio mode.

3 Touch and hold any one of the preset buttons [**P.SET 1**] through [**P.SET 6**] for at least 2 seconds. The selected station is stored.

4 Repeat the procedure to store up to 5 other stations onto the same band.

To use this procedure for other bands, simply select the desired band and repeat the procedure.

A total of 18 stations can be stored in the preset memory (6 stations for each band; FM1, FM2 or AM).

- If a preset memory has already been set in the same preset number, it will be cleared and the new station will be memorized.

Presetting Stations Automatically

The tuner can automatically seek and store 6 strong stations in the selected band in order of signal strength.

After selecting the desired band, touch and hold [**A.MEMO**] for at least 2 seconds.

The tuner automatically seeks and stores 6 strong stations into [P.SET 1] to [P.SET 6] in order of signal strength.

When the automatic storing has been completed, the tuner goes to the station stored in [P.SET 1].

- If no stations are stored, the tuner will return to the original station you were listening to before the automatic storing procedure began.

Tuning to Preset Stations

You can tune in the preset stations in memory on each band using the preset number.

1 After selecting the desired band, touch [**P1/2**]* to change the function guide.

* [P 1/3] is displayed in the HD Radio mode.

2 Touch any one of the preset buttons [**P.SET 1**] through [**P.SET 6**] that has a station stored to it. The preset station is received.

Storing the tag information (HD Radio™ mode only)

iTunes Tagging lets you tag songs heard on HD Radio stations. Using your new INA-W900 in conjunction with an optional HD Radio Tuner module, you can preview, buy and download later, songs from your iTunes tagged playlist the next time you sync your iPhone/iPod. If the unit is connected to a Tagging compatible device, you can use the iTunes Tagging function. For details, refer to the Owner’s Manual of the Tagging compatible device.

Display example for HD Radio mode main screen



When a desired song is heard on an HD Radio station, touch [**Tag**] to save its tag information.

Then you can preview, buy, and download it later from your iTunes Tagged playlist the next time you sync your iPod.

Changing the Display (HD Radio™ mode only)

Text information, such as Station name, Song title, Artist, etc., is displayed while receiving a digital radio station.

Touch **[INFO.]** on the HD Radio Tuner mode main screen.

Each time you touch this button, the display changes as shown below.

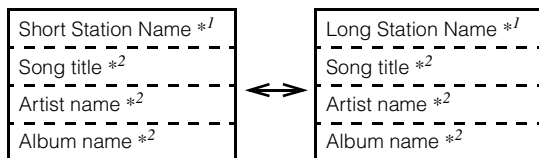

*1 Displays Short Station Name / Long Station Name in the Station Information Service Data.

*2 Displays Song title / Artist / Album in the main program Service Data.

Receiving a Multicast (HD Radio™ mode only)

Multicasting is the ability to broadcast multiple program streams over a single FM frequency. This increases the amount and diversity of content choices. A maximum of eight multicast station channels can be selected on this unit.

When a radio station multicast is received, the “Multicast” indicator lights.

- 1 Touch [Q] in the HD Radio Tuner mode.**
The program list is displayed.
- 2 Touch [▶] of the desired program type.**
The selected program is received.
- 3 Touch [▼] or [▲] of [P] on the function guide.**
The sub channel of the received radio station is changed.

CD/MP3/WMA/AAC

Display example for MP3/WMA/AAC main screen

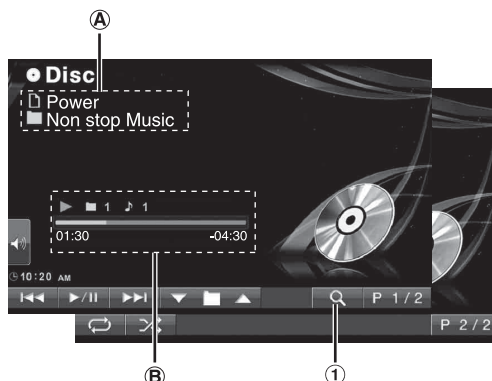

① [Q] button: Refer to page 45

Ⓐ CD:
Displays the Track text*1/Disc text*1.

• If there is neither Track nor Disc name information, “NO TEXT” will be displayed.

MP3/WMA/AAC:
Displays the Title name/Artist name/Album name.

Ⓑ CD:
Displays the disc number*2/track number/elapsed time.

MP3/WMA/AAC:
Displays the disc number*3/folder number/track number/
elapsed playback time.

*1 Displayed when a CD text disc is inserted.

*2 Displayed when a CD changer is connected.

*3 Displayed when an MP3 compatible CD changer is connected.

Playback

1 Press SOURCE/⏻ on the unit.
The SOURCE selection screen is displayed.

2 Touch the source icon of [DISC].
The display shows the DISC mode screen.

When a CD/MP3/WMA/AAC is inserted into the DISC SLOT of this unit, with the label side facing up, the unit starts to play the CD/MP3/WMA/AAC.

3 Touch [◀◀] or [▶▶] to select the desired track (file).

Returning to the beginning of the current track (file):
Touch [◀◀].

Fast reverse :
Touch and hold [◀◀].

Advancing to the beginning of the next track (file) :
Touch [▶▶].

Fast forward :
Touch and hold [▶▶].

To pause playback

Touch [▶/||].

Touching [▶/||] again will resume playback.

Inserting/Ejecting a Disc

Refer to "Inserting/Ejecting a Disc" (page 15).

- The INA-W900 model includes a built-in MP3/WMA/AAC unit. You can play CD-ROMs, DVD-ROMs, CD-Rs, CD-RWs, DVD-Rs, DVD-RWs, DVD+Rs and DVD+RWs containing MP3/WMA/AAC files on this unit. Use the format compliant with this unit. For further information about playing or storing MP3/WMA/AAC files, refer to pages 38 and 39 before using the unit.
- WMA format files that are protected by DRM (Digital Rights Management), AAC format files that have been purchased from iTunes Music Store and files that are copy-protected (copyright protection) cannot be played back on this unit.
- The unit can play discs containing both audio data and MP3/WMA/AAC data.
- The track display for CD audio data playback is the track numbers recorded on the disc.
- Three-inch (8 cm) CDs can be used.
- "Playing MP3/WMA/AAC Data (File Play Mode)" is mentioned on page 49.
- If an MP3/WMA/AAC disc with many files and folders is played, it takes a little longer than normal to start playback.
- Touch [Q] to activate the search mode. For operations, refer to "Search Function" on page 45. However, the search mode function does not work in the CD changer mode.
- The playback time may not be correctly displayed when a VBR (Variable Bit Rate) recorded file is played back.

Repeat Play

Touch [↺] to play back repeatedly the track currently being played.

The track (file) will be played repeatedly.

Touch [↺] again and select OFF to deactivate Repeat play.

CD: ↺ → ↺ ⊙ *1 → (off) → ↺
(Repeat One)

MP3/WMA/AAC:

- 1 Touch [P1/2]*3 to change the function guide.
- 2 Touch [↺] and select the desired Repeat play.

↺ → ↺ ■ *2 → ↺ ⊙ *1 → (off) → ↺
(Repeat One)

*1 If a CD Changer or an MP3 compatible CD changer is connected and the Repeat Disc mode is selected, the unit repeatedly plays back all tracks (files) on the disc selected.

*2 Only files in a folder are repeatedly played back.

*3 Display may vary depending on the connected devices.

M.I.X. (Random Play)

Touch [⌘] during playback.

The tracks (files) on the disc will be played back in a random sequence.

To cancel M.I.X. play, touch [⌘].

CD: ⌘ → ⌘ ALL *1 → (off) → ⌘

MP3/WMA/AAC:

- 1 Touch [P1/2]*4 to change the function guide.
- 2 Touch [⌘] and select the desired M.I.X. play.

⌘ ■ *3 → ⌘ *2 → (off) → ⌘ ■ *3

*1 If a CD Changer equipped with the ⌘ ALL function is connected, ⌘ ALL will also be selectable. In this mode, the tracks on all the CDs in the current magazine will be included in the random playback sequence.

*2 If an MP3 compatible CD changer is connected, all files in a disc are played back in random sequence, and playback shifts to the next disc.

*3 Only files in a folder are played back in random sequence in the ⌘ ■ mode.

*4 Display may vary depending on the connected devices.

- If the search mode (page 45) is activated, the M.I.X. play mode will be canceled.

Selecting Folders (concerning MP3/WMA/AAC)

Touch [▼] or [▲] to select the folder.

About MP3/WMA/AAC

CAUTION

Except for private use, duplicating audio data (including MP3/WMA/AAC data) or distributing, transferring, or copying it, whether for free or for a fee, without permission of the copyright holder is strictly prohibited by the Copyright Act and by international treaty.

What is MP3?

MP3, whose official name is "MPEG-1, 2, 2.5 Audio Layer 3", is a compression standard prescribed by the ISO, the International Standardization Organization and MPEG which is a joint activity institution of the IEC.

MP3 files contain compressed audio data. MP3 encoding is capable of compressing audio data at extremely high ratios, reducing the size of music files to as much as one-tenth their original size. This is achieved while still maintaining near CD quality. The MP3 format realizes such high compression ratios by eliminating the sounds that are either inaudible to the human ear or masked by other sounds.

What is AAC?

AAC is the abbreviation for "Advanced Audio Coding", and is a basic format of audio compression used by MPEG2 or MPEG4.

What is WMA?

WMA, or "Windows Media™ Audio," is compressed audio data. WMA is similar to MP3 audio data and can achieve CD quality sound with small file sizes.

Method for creating MP3/WMA/AAC files

Audio data is compressed using software with MP3/WMA/AAC codecs. For details on creating MP3/WMA/AAC files, refer to the user's manual for that software.

MP3/WMA/AAC files that are playable on this device have the file extensions.

MP3: "mp3"

WMA: "wma" (ver. 7.1, 8, 9, 9.1 and 9.2 are supported)

AAC: "m4a"

WMA is not supported for the following files, Windows Media Audio Professional, Windows Media Audio 9 Voice or Windows Media Audio 9 Pro Lossless.

There are many different versions of the AAC format. Confirm that the software being used conforms to the acceptable formats listed above. It's possible that the format may be unplayable even though the extension is valid.

Playback of AAC files encoded by iTunes is supported.

Supported playback sampling rates and bit rates

MP3

Sampling rates: 48 kHz, 44.1 kHz, 32 kHz, 24 kHz, 22.05 kHz, 16 kHz, 12 kHz, 11.025 kHz, 8 kHz

Bit rates: 32 - 320 kbps

WMA

Sampling rates: 48 kHz, 44.1 kHz, 32 kHz

Bit rates: 48 - 192 kbps

AAC

Sampling rates: 48 kHz, 44.1 kHz, 32 kHz, 24 kHz, 22.05 kHz, 16 kHz, 12 kHz, 11.025 kHz, 8 kHz

Bit rates: 16 - 320 kbps

This device may not play back correctly depending on sampling rates.

ID3 tags/WMA tags

If tag data is in an MP3/WMA/AAC file, this device can display the title (track title), artist name, and album name ID3 tag/WMA tag data (maximum 128 characters).

This device can only display single-byte alphanumeric characters and the underscore. For non-supported characters, "NO SUPPORT" is displayed.

The number of characters may be limited, or not correctly displayed, depending on the tag information.

Playing back MP3/WMA/AAC

MP3/WMA/AAC files are prepared, then written to a CD-R, CD-RW (DVD-R/DVD-RW) using CD-R writing software. A disc can hold up to 1024 files/256 folders (including Root Folders), and the maximum number of folders is 255. Playback may not be performed if a disc exceeds the limitations described above.

Media supported

The media that this device can play back are CD-ROMs, CD-Rs, and CD-RWs, DVD-Rs and DVD-RWs.

Corresponding File Systems

This device supports discs formatted with ISO9660 Level 1 or Level 2.

Under the ISO9660 standard, there are some restrictions to remember.

The maximum nested folder depth is 8 (including the root directory). The number of characters for a folder/file name is limited.

Valid characters for folder/file names are letters A-Z (all caps), numbers 0-9, and '_' (underscore).

This device can play back discs in Joliet, Romeo, etc., and other standards that conform to ISO9660. However, sometimes the file names, folder names, etc., are not displayed correctly.

Formats supported

This device supports CD-ROM XA, Mixed Mode CD, Enhanced CD (CD-Extra) and Multi-Session.

This device cannot correctly play back discs recorded with Track At Once or packet writing.

Order of files

Files are played back in the order that the writing software writes them to the disc. Therefore, the playback order may not be what's expected. Verify the writing order in the software's documentation. The playback order of the folders and files is as follows. (The following numbers may differ from actually displayed numbers.)

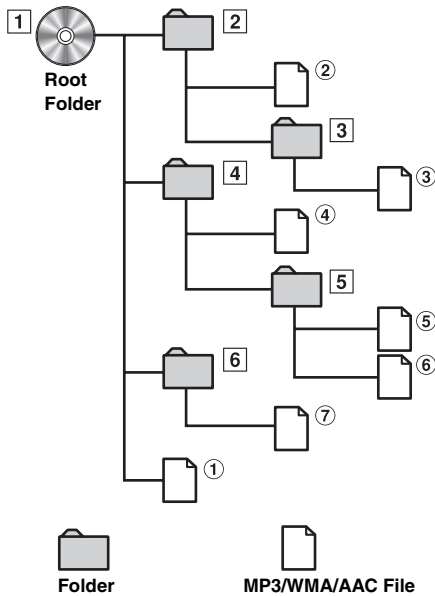

Terminology

Bit rate

This is the “sound” compression rate specified for encoding. The higher the bit rate, the higher the sound quality, but also the larger the files.

Sampling rate

This value shows how many times per second the data is sampled (recorded). For example, music CDs use a sampling rate of 44.1 kHz, so the sound is sampled (recorded) 44,100 times per second. The higher the sampling rate, the higher the sound quality, but also the larger the volume of data.

Encoding

Converting music CDs, WAVE (AIFF) files, and other sound files into the specified audio compression format.

Tag

Song information such as track titles, artist names, album names, etc., written into MP3/WMA/AAC files.

Root folder

The root folder (or root directory) is found at the top of the file system. The root folder contains all folders and files. It is created automatically for all burned discs.

DVD

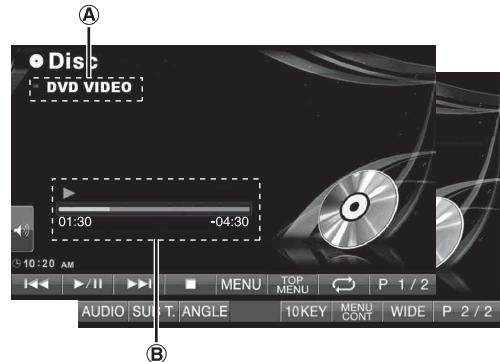

Display example for DVD Video main screen



- Ⓐ Displays the disc (DVD VIDEO, PROGRAM/PLAYLIST (DVD-VR)) being played back.
- Ⓑ Displays the elapsed playback time.

- Some operations cannot be carried out depending on the disc or playback screen.
- Displays of the function guide [P1/2], etc., may vary depending on the connected device(s).

Disc types that can be used for each heading are represented by the following marks.

-  DVD Commercial Video discs (used for the distribution of movies, etc.) or a DVD-R/DVD-RW, DVD+R/DVD+RW recorded in a video mode can be used.
-  DVD-R/DVD-RW discs recorded in DVD-VR mode can be used.

Playing a Disc

INA-W900 has a built-in DVD player. When an optional Alpine DVD/Video CD/CD player (or DVD changer) is connected to the INA-W900, you can control it from the INA-W900 (except some operations).

WARNING

It is dangerous (and illegal in many states) for the driver to watch the DVD/TV/Video while driving the vehicle. The driver may be distracted from looking ahead and an accident could occur.

Install the INA-W900 correctly so that the driver cannot watch DVD/TV/Video unless the vehicle is stopped and the emergency brake is applied.

If the INA-W900 is not installed correctly, the driver will be able to watch the DVD/TV/Video while driving the vehicle and may be distracted from looking ahead causing an accident. The driver or other people could be severely injured.

To display the DVD mode screen

(DVD-V) (DVD-VR)

To watch a video source, your vehicle must be parked with the ignition key in the ACC or ON position. To do this, follow the procedures below.

- 1 Push the foot brake to bring your vehicle to a complete stop at a safe location. Engage the parking brake.
 - 2 Keep pushing the foot brake and release the parking brake once then engage it again.
 - 3 While the parking brake is being engaged the second time, release the foot brake.
- For automatic transmission vehicles, place the transmission lever in the Park position.

Now, the locking system for the DVD mode operation has been released. Engaging the parking brake can reactivate the DVD mode, as long as the car's ignition has not been turned off. It is not necessary to repeat the above procedure (1 through 3), of "To display the DVD mode screen."

Each time the ignition is turned OFF, perform the procedure of "To display the DVD mode screen."

- If you try to activate the auxiliary device while driving, the display will show the warning-**PICTURE OFF FOR YOUR SAFETY**.

⚠ Caution

- Not all functions will operate for every DVD. See the individual DVD's instructions for details on the features supported.
- Fingerprints on a disc may adversely affect playback. If a problem occurs, remove the disc and check for fingerprints on the playback side. Clean the disc if necessary.
- If you switch the power or Ignition key OFF or change sources during playback, playback will continue where you left off when you resume playback.
- If you try to perform an invalid operation (based on the type of disc being played), the following mark is displayed on the monitor screen: ⊘

- **Play Position Memory Function**
Even if you turn power off or switch the Ignition key to OFF during playback or change the source, playback will continue from the point where playback stopped when the power is turned ON again.

- 1 Press **SOURCE/⏻** on the unit.
The SOURCE selection screen is displayed.

- 2 Touch **[DISC]**.
The display shows the DISC mode screen.
Insert a disc with the label side facing up. The unit starts to play the disc.

- The operation screen changes to the visual screen in the DVD mode for 5 seconds after an operation has been performed. Touch the display panel to display the operation screen again.
- The display mode can be changed by touching **[WIDE]**.
For operation, see "Switching Display Modes" on page 46.

Inserting/Ejecting a Disc

Refer to "Inserting/Ejecting a Disc" (page 15).

- The reverse side of a double-sided DVD will not be played automatically.
Remove the disc, turn it over, and reinsert it.
- DO NOT insert discs containing maps for the navigation system. Doing so could result in damage.
- Refer also to "DVD Setup" (page 47 to 49).
- Be sure the remote input lead is connected to the remote output lead of this unit when a DVD changer or DVD player is connected. If not correctly connected, touch operation cannot be performed.

If a menu screen appears

On DVD mode, menu screens may appear automatically. If this happens, perform the operation described below to start playback.

Direct Menu Operations (DVD-V)

- 1 Touch the DVD menu directly.
 - Some operations cannot be performed depending on the disc.

Menu Operations (DVD-V)

- 1 Touch **[Control]** to display the operation keys.

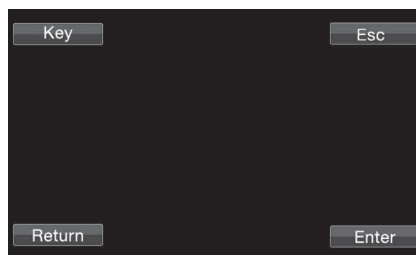

- 2 Touch **[Key]**.
The menu operation mode will be displayed.

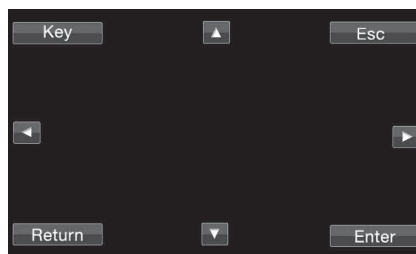

- 3 Select a desired menu item by touching **[▲]**, **[▼]**, **[◀]** or **[▶]**.
- 4 Touch **[Enter]** to confirm the selected item.

Numeric Keypad Input Operations (DVD-V)

- 1 Touch **[Control]** to display the operation keys.

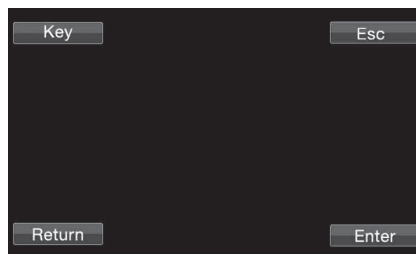

- 2 Touch **[Key]**.
The menu operation mode appears.
- 3 Touch **[Key]** again.
The numeric keypad input mode screen appears.

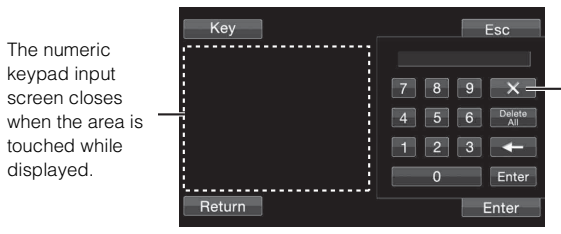

The numeric keypad input screen closes when the area is touched while displayed.

Touch **[X]** to close the numeric keypad input screen.

- 4 Touch a desired number.
- 5 Touch **[Enter]** on the numeric keypad mode screen to confirm your selection.

Displaying the Top Menu Screen DVD-V

When a DVD contains two or more titles, the top menu screen appears.

Touch [TOP MENU] on the DVD mode main screen.

The top menu screen appears.

- To perform necessary operations, see “If a menu screen appears” on page 40.

Displaying the Menu Screen DVD-V

With a DVD having two or more menus, a menu screen will appear for the programs available, in addition to the main programs.

Touch [MENU] on the DVD mode main screen.

The menu screen appears.

- To perform necessary operations, see “If a menu screen appears” on page 40.

Displaying the Menu Operation Mode Screen DVD-V

- 1 Touch **[P1/2]** on the DVD mode main screen.
The function guide changes.

- 2 Touch **[MENU CONT.]**.
The menu operation mode screen appears.

- For further operation, see “If a menu screen appears” on page 40.

Searching by Program DVD-VR

- 1 Touch **[TOP MENU]** on the DVD mode main screen while playing a DVD-VR disc.
The program search list screen is displayed.

- 2 Touch **[▶]** of the program you want to play.
The selected program is played back, and then returns to the DVD mode main screen.

Searching by Playlist DVD-VR

- 1 Touch **[MENU]** on the DVD mode main screen while playing DVD-VR disc.
The playlist search list screen is displayed.

- 2 Touch **[▶]** of the playlist you want to play.
The selected playlist is played back, and then returns to the DVD mode main screen.

- Only discs containing a Playlist can be operated.

Stopping Playback (PRE STOP)

DVD-V DVD-VR

Press the stop button during playback to stop playback. That position is stored in the memory.

- 1 Touch **[■]** once during playback.

“Pre Stop” is displayed.

- 2 Touch **[▶/||]** in the Pre Stop mode.

Playback starts from the position at which it was stopped.

- For some discs, the position at which playback was stopped may not be accurate.

Stopping Playback DVD-V DVD-VR

Touch [■] twice or touch and hold [■] for at least 2 seconds during playback.

“Stop” is displayed, and playback stops.

- Playback starts from the beginning when **[▶/||]** is touched while playback is stopped.

Fast-forwarding/Fast-reversing

DVD-V DVD-VR

DVD-Video, DVD-VR:

- 1 During playback, touch and hold **[◀◀]** (Fast-reverse) or **[▶▶]** (Fast-forward).

When touched and held for more than 1 second, the disc is forwarded/reversed at double speed. When held for 5 more seconds or longer, the disc is forwarded/reversed at 8 times the normal speed. When held for 10 seconds or longer, the disc is forwarded/reversed at 21 times the normal speed.

- 2 Stop touching **[◀◀]** or **[▶▶]** to return to normal playback.

- No sound is played back during fast-forwarding/fast-reversing.
- For DVD mode, the menu screen may reappear during fast-forwarding/fast-reversing.
- This operation may not be possible on certain discs.

Finding the Beginnings of Chapters

DVD-V DVD-VR

During playback, touch [◀◀] or [▶▶].

The chapter switches each time the button is touched, and playback of the selected chapter starts.

- ▶▶: Touch this to start playback from the beginning of the following chapter.
- ◀◀: Touch this to start playback from the beginning of the current chapter.

- Some DVDs do not have chapters.

Supplementary explanations

“Chapters” are divisions of movies or musical selections on DVDs.

Playing Still Frames (Pausing)

DVD-V DVD-VR

1 During playback, touch [▶/||].

2 Touch [▶/||] to resume playback.

- No sound is played during the still frame mode.
- The image or sound may stop temporarily when playback starts from the pause mode. This is not a malfunction.

Forward/reverse frame-by-frame Playback

DVD-V DVD-VR

1 In the pause mode, touch [◀◀] or [▶▶].

The picture advances or reverses by one frame each time the button is touched.

2 Touch [▶/||] to return to normal mode.

- No sound is output during forward/reverse frame-by-frame playback.
- Reverse frame-by-frame cannot be carried out on the DVD-VR disc.

Slow Motion Playback

DVD-V DVD-VR

1 When [◀◀] or [▶▶] is touched and held while in the pause mode, the 1/8th speed slow motion playback mode is set.

When held in for 5 more seconds, the slow motion speed switches to 1/2 the normal speed.

2 Stop touching [◀◀] or [▶▶] to pause, and touch [▶/||] to play back.

- No sound is played during slow motion playback.
- Reverse slow motion playback is not available on the DVD-VR disc.
- 1/2, 1/8 are approximate speeds. The actual speed differs from disc to disc.

Selecting Program (SKIP) DVD-VR

1 Touch [P1/3] twice while playing a DVD-VR disc.
The program function guide is displayed.

2 Touch [P] * [▼] or [▲] to select a program.

- * To switch the function guide display [▼] or [▲] to [P] [▼] or [▲], play back the program. For details, refer to “Searching by Program” (page 41).

Selecting Playlist (SKIP) DVD-VR

1 Touch [P1/3] twice while playing a DVD-VR disc.
The playlist function guide is displayed.

2 Touch [P] * [▼] or [▲] to select a playlist.

- * To switch the function guide display [P] [▼] or [▲] to [P] [▼] or [▲], play back the playlist. For details, refer to “Searching by Playlist” (page 41).

Repeat Playback DVD-V DVD-VR

Use this function to play the disc’s titles, chapters or tracks, etc., repeatedly.

DVD Video

Touch [↺] on the touch screen.

The repeat mode switches every time the button is touched.

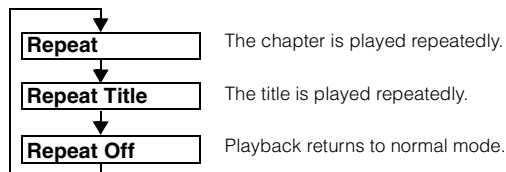

- Display may vary depending on the connected devices.
- The REPEAT mode is always turned off when [↺] is touched and held for at least 2 seconds.

DVD-VR

Touch [↺] on the touch screen.

The repeat mode switches every time the button is touched.

The Program mode*2:

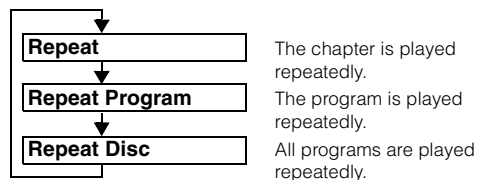

- The chapter is played repeatedly.
- The program is played repeatedly.
- All programs are played repeatedly.

The Playlist mode*2:

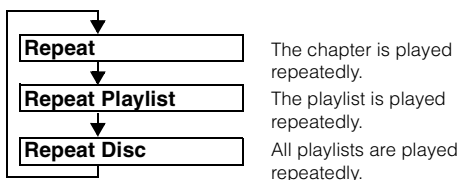

*2 To switch the Program mode display to the Playlist mode display on the DVD mode main screen, play back via program or playlist search. Refer to "Searching by Program" or "Searching by Playlist" (page 41).

- Only discs containing a Playlist can be displayed.

Searching by Title/Program/Playlist



Use this function to easily find positions on the DVD using the DVD's titles, programs or playlists.

- 1 Touch **[P1/2]*** while playback is stopped.
The function guide appears.

* Touch [P1/3] while playing a DVD-VR disc.

- 2 Touch **[10KEY]**.
The numeric keypad input mode screen appears.
 - 3 Enter a desired title, program or playlist by touching its title, group, program or playlist number.
See page 40 for operation of the numeric keypad.
 - 4 Confirm your selection by touching **[Enter]**.
Playback will start from the title number selected.
- To switch the Program mode display to the Playlist mode display on the DVD mode main screen, play back via program or playlist search. Refer to "Searching by Program" or "Searching by Playlist" (page 41).
 - This function cannot be used on discs on which no title numbers are recorded.
 - Playback starts from the beginning of the chapter/track number in the state of Pre Stop.
 - Some disc may not accept any operation.

Searching Directly by Chapter Number



Use this function to easily move to the beginnings of the chapters or tracks on the disc.

- 1 Touch **[P1/2]*** in any mode other than stop mode.
The function guide will appear.
- * Touch [P1/3] while playing a DVD-VR disc.
- 2 Touch **[10KEY]**.
The numeric keypad input mode screen will appear.
 - 3 Touch and enter the chapter number you want to play.
See page 40 for operation of the numeric keypad.

- 4 Touch **[Enter]** to confirm your selection.
Playback will start from the selected chapter or track.

- This function is not available for a disc on which chapters or tracks are not stored.

Switching the Angle

On DVDs in which scenes have been filmed from multiple angles, the angle can be switched during playback.

- 1 During playback, touch **[P1/2]**.
The function guide changes.
 - 2 Touch **[ANGLE]**.
The angle switches between the angles recorded on the disc every time the button is touched.
- Some time may be required for the angle to change.
 - Depending on the disc, the angle may switch in one of two ways.
 - Seamless: The angle switches smoothly.
 - Non-seamless: When the angle is switched, a still picture is displayed first, after which the angle switches.

Switching the Audio Tracks

DVDs with multiplex audio or audio languages allow switching the sound during playback.

- 1 During playback, touch **[P1/2]**.
 - 2 Touch **[AUDIO]**.
The sound switches between the alternate audio tracks recorded on the disc every time the button is touched.
- The alternate track selected becomes the default setting every time the power is turned on or the disc is replaced. If the disc does not include that track, the disc's default language is selected instead.
 - Not all discs will allow changing the alternate audio tracks during playback. In these cases, select audio tracks from the DVDs menu.
 - There may be a delay before the selected alternate track begins to play.

DVD-VR disc with multiplex audio

- 1 During playback, touch **[P1/3]**.
The function guide changes.
- 2 Touch and hold **[AUDIO]** for at least 2 seconds.
The left and right channels will be output as shown below, each time the button is touched.
AUDIO LL → AUDIO RR → AUDIO LR → AUDIO LL

Switching the Subtitles (Subtitle Language) DVD-V DVD-VR

With DVDs on which multiple subtitle languages are recorded, the subtitle language can be switched during playback; moreover, subtitles can be hidden.

1 During playback, touch [P1/2]*.

The function guide changes.

* Touch [P1/3] while playing a DVD-VR disc.

2 Touch [SUBT.].

Touching this button repeatedly selects sequentially the subtitle languages recorded on the disc, and then turns the subtitles OFF.

- There may be a delay before the selected subtitle appears.
- Not all discs will allow changing the subtitles during playback. In these cases, select subtitles from the DVDs menu.
- The subtitle language selected becomes the default setting every time the power is turned on or the disc is replaced. If the disc does not include that language, the disc's default language is selected instead. However, the subtitle language may differ depending on the disc.
- For some discs, the subtitles will be displayed even when this is set to OFF. However, the subtitle language may differ depending on the disc.
- Switches the subtitles ON/OFF while playing a DVD-VR disc.

Switching from the disc menu DVD-V

For some discs, the audio language, angle and subtitles can be switched from the disc menu.

1 Touch [MENU] or [TOP MENU] to display the menu.

2 Select an item to confirm it.

See "If a menu screen appears" on page 40.

Other Useful Features

Adjusting the Audio

1 Press SOURCE/⏻ on the unit.

The SOURCE selection screen is displayed.

2 Touch [] on the main source screen.

The SETUP main screen is displayed.

3 Touch [] of Audio Setup.

The Audio Setup screen appears.

Display Example for Audio Adjustment Screen

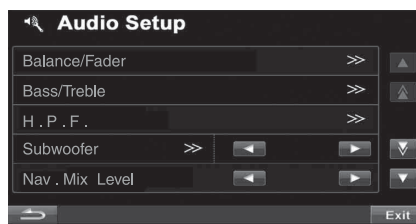

- Touching [▲] or [▼] will scroll the list one line at a time.
- Touching [▲] or [▼] will scroll the list one page at a time.
- Touching [Exit] will change to the main source screen.
- Touching [↶] to return to the previous screen.

Adjusting Balance/Fader

Touch [] of Balance/Fader, the adjusting screen of Balance/Fader will be displayed.

Display Example for Balance/Fader Screen

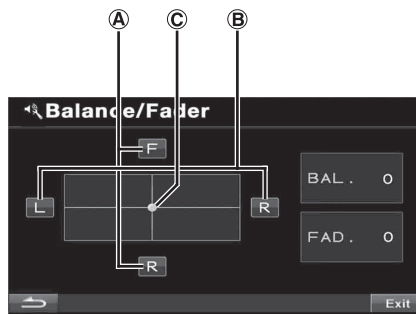

Ⓐ Adjusting the Fader

Touch [F] or [R] to adjust the volume of the front and rear speakers.

Setting range: F15 to R15

- If an optional IMPRINT audio processor (PXA-H100) is connected to this unit and you have set the 2.2ch (3WAY)/4.2ch (FRONT/REAR/SUBW.) switch to 2.2ch (3WAY), you cannot adjust the FADER mode. For details, refer to the Owner's Manual of PXA-H100.

Ⓑ Adjusting the Balance

Touch [L] or [R] to adjust the sound volume of the left and right speakers.

Setting range: L15 to R15

Ⓒ Adjusting the Balance/Fader Directly

Touch and move [○] to a desired setting.

Or touch a desired setting range, and [○] will move to that location.

Touch [L] or [R] of Balance and [F] or [R] of Fader for fine-tuning.

Turning Defeat ON or OFF

Touch [▼] to display the Defeat adjusting screen.

Touch [◀] or [▶] of Defeat to set to ON or OFF.

If you set the Defeat to ON, MX of the optional IMPRINT audio processor (PXA-H100) is turned OFF and EQ is returned to the initial setting.

Adjusting Nav. Mix Level

Touch [◀] or [▶] of Nav. Mix LEVEL to adjust the volume of navigation interruption.

Setting range: 0 to 15

Adjusting the Subwoofer Level

Touch [◀] or [▶] of Subwoofer to set the subwoofer ON/OFF.

Touch [≫] to display the Subwoofer output adjusting screen after setting the Subwoofer to ON.

Touch [◀] or [▶] to adjust the Subwoofer output.

Setting range: 0 to 15

- The Subwoofer System, Subwoofer Phase and Subwoofer Channel may be set when an optional IMPRINT audio processor (PXA-H100) is connected. For details, refer to "Setting the Subwoofer" on page 61.

Adjusting H.P.F. (Highpass Filter)

Touch [≫] to display the H.P.F. adjusting screen.

Touch [◀] or [▶] of the desired speaker.

Setting range: OFF, 80 Hz, 120 Hz, 160 Hz

- Select OFF when no adjustment is required.
- When an IMPRINT audio processor (PXA-H100) is connected, the display changes from "H.P.F." to the "A.Processor" item. For details on operation, refer to "IMPRINT Operation (Optional)" on page 58.

Adjusting Bass/Treble

You can change the bass/treble frequency emphasis to create your own tonal preference.

Touch [≫] to display the Bass/Treble adjusting screen.

Touch [▲] or [▼] on the scroll bar to scroll the setup items line by line.

- Adjustment cannot be performed when an IMPRINT audio processor (PXA-H100) is connected or Defeat is set to ON.

Setting the Bass level

You can emphasize or weaken the bass frequency.

Touch [◀] or [▶] of Bass Level to select the desired bass level.

Setting range: -7 to +7

Setting the Bass Center Frequency

The displayed bass frequency is emphasized.

Touch [◀] or [▶] of Bass Freq. to select the desired bass center frequency.

Setting range: 60 Hz, 80 Hz, 100 Hz, 200 Hz

Setting the Bass Bandwidth

Changes the boosted bass bandwidth to wide or narrow. A wider setting will boost a wide range of frequencies above and below the center frequency. A narrower setting will boost only frequencies near the center frequency.

Touch [◀] or [▶] of Bass Bandwidth to select the desired bass band width.

Setting range: Wide1 to Wide4

- The bass level settings will be individually memorized for each source (FM, AM, CD, etc.) until the setting is changed. The bass frequency and bass bandwidth settings adjusted for one source are effective for all other sources (FM, AM, CD etc.).

Setting the treble level

You can emphasize the treble frequency.

Touch [◀] or [▶] of Treble Level to select the desired treble level.

Setting range: -7 to +7

Setting the Treble Center Frequency

The displayed treble frequency is emphasized.

Touch [◀] or [▶] of Treble Freq to select the desired treble center frequency.

Setting range: 10 kHz, 12.5 kHz, 15 kHz, 17.5 kHz

- The treble level settings will be individually memorized for each source (FM, AM, CD, etc.) until the setting is changed. The Treble frequency settings adjusted for one source are effective for all other sources (FM, AM, CD, etc.).

Setting the Loudness

Loudness introduces a special low- and high-frequency emphasis at low listening levels. This compensates for the ear's decreased sensitivity to bass and treble sound.

Touch [◀] or [▶] of Loudness to set to ON or OFF.

- This adjustment cannot be performed when an optional IMPRINT audio processor (PXA-H100) is connected.

Search Function

Touch [Q] on the function guide while in the CD or MP3/WMA/AAC mode.

Search list screen is displayed.

Select a desired track or folder

Touch [▶] for direct playback.

When a hierarchical list is prepared, [≫] will be displayed. Touch [≫] to display the respective hierarchy list screens.

Display Example for USB Memory Search Screen

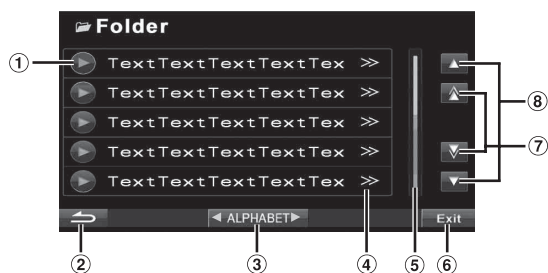

- ① Select directly by touching [▶], and its track (or folder/file) is played back.
- ② Touch [←] to return to the previous list screen.
- ③ Titles are listed alphabetically, and can be skipped every 200 titles with the same beginning with alphabetical character. If there are fewer than 200 titles, titles beginning with the next alphabetical character are selected. e.g. press **ALPHABET** [▶], switch to the section beginning with alphabet B from A. (Only applicable to English alphabetic characters.)
- ④ [>>] is displayed if there is a hierarchical list.
- ⑤ The direct search bar can be used to search for a folder, song, etc. more efficiently. By touching anywhere on the direct search bar, or touching and dragging the position mark to a desired place, you can quickly target any song.
- ⑥ Touching [Exit] will change to the main source screen.
- ⑦ Scroll the list one page at a time by touching [▲] or [▼].
- ⑧ Scroll the list one line at a time by touching [▲] or [▼].

- *The search function does not work on the DVD or CD changer. If [TOP MENU] or [MENU] is touched in the DVD-VR mode, the unit changes to the search function. Refer to “Searching by Program” and “Searching by Playlist” (page 41).*

Internal CD player mode

- 1 The track list* screen appears.
- 2 Touch [▶] of a desired track text*.
The selected track will be played back.

* If the CD is text compatible only.

- “NO TEXT” is displayed in the track text list if there is no text on the disc.

Switching Display Modes

After carrying out the steps 1 to 3 of “To display the DVD mode screen” explained on page 47, perform the operation described below.

While your vehicle is parked, touch [WIDE] on the visual source screen.

Each touch changes the display modes as follows:

Mode 1 → Mode 2 → Mode 3 → Mode 1
(WIDE) (CINEMA) (NORMAL) (WIDE)



In Mode 1 (Wide), the monitor displays a normal picture wider to fit in a wide-screen monitor by evenly stretching out the picture horizontally.

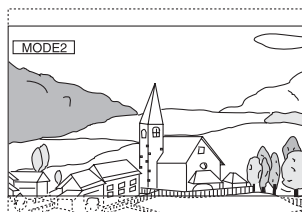

In Mode 2 (Cinema), the monitor displays a normal picture by stretching out the picture horizontally and vertically. This mode is good for displaying a cinema type picture at the 16:9 ratio.

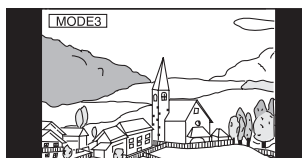

In Mode 3 (Normal), the monitor displays a normal picture at the center of the screen with a vertical black band at each side.

Setup

DVD Setup

DVD Setup Operation

To display the DVD mode screen:

To watch a video source, your vehicle must be parked with the ignition key in the ACC or ON position. To do this, follow the procedure below.

- 1 Bring your vehicle to a complete stop at a safe location. Engage the parking brake.
- 2 Keep pushing the foot brake and release the parking brake once then engage it again.
- 3 When the parking brake is engaged for the second time, release the foot brake.

- For automatic transmission vehicles, place the transmission lever in the Park position.

Now, the locking system for the DVD mode operation has been released. Engaging the parking brake can reactivate the DVD mode, as long as the car's ignition has not been turned off. It is not necessary to repeat the above procedure (1 through 3) of "To display the DVD mode screen." Each time the ignition is turned OFF, perform the procedure of "To display the DVD mode screen."

The DVD Setup operation can be carried out after removing the disc from the unit.

The following steps 1 to 6 are common operations to each "Setting item" of DVD Setup. Refer to each section for details.

- 1 Press SOURCE/⏻ on the unit.**
The SOURCE selection screen is displayed.
- 2 Touch [↵] on the main source screen.**
The SETUP main screen is displayed.
- 3 Touch [➤] of Source Setup.**
The Source Setup screen appears.
- 4 Touch [➤] of DVD Setup.**
The DVD setup screen appears.
- 5 Touch [◀], [▶], etc., of the desired item to change its setting.**

Setting items:

Menu Language / Audio Language / SUBT. Language / Country Code / Parental / Downmix Mode / TV Screen / File Play Mode

Display example for DVD setup screen

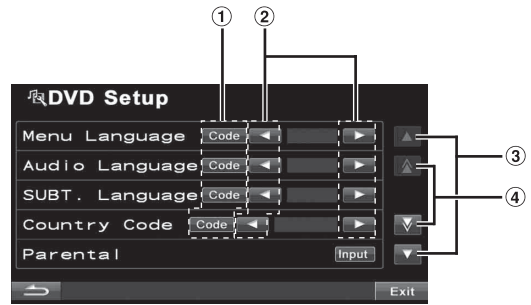

- ① Touch [CODE] to display the numeric keypad input screen.
- ② Touch [◀] or [▶] to set a desired language.
- ③ Touch [▲] or [▼] to scroll a setting item list by one Line.
- ④ Touch [↵] or [↶] to scroll a setting item list by one page.

Display example for the numeric keypad input screen

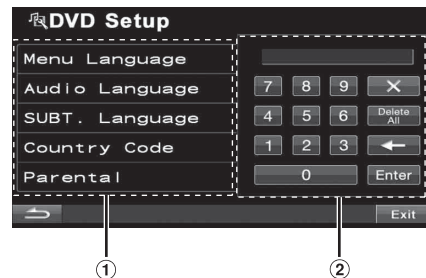

- ① The numeric keypad input screen closes when the area is touched while displayed.
 - ② Numeric keypad input screen
The numeric keypad is used if you want to play back in a language other than that displayed, or to input your parental lock password, etc.
- 6 Touch [↶] to return to the previous screen.**
Touch [Exit] to return to the main source screen that was displayed before the setup operation was started.
- Immediately after changing the settings of DVD mode (while the system is writing data automatically) do not turn the ignition key (engine key) to OFF. Otherwise, the settings may not be changed.

Changing the language setting

The audio language, subtitle language and menu language can be set according to your preferences.

Once set, this becomes the default language. This function is convenient when you always want to listen in English. (The language setting is not effective on some discs. If not, the default language is set from the factory.)

- When the settings are changed, the old settings are overwritten. Make a note of the current settings before making changes. The memory is cleared when the vehicle's battery is disconnected.
- To temporarily change the language of the current disc, either do so from the DVD menu or by using the operation described in the section "Switching the Audio Tracks" (page 43).
- If the disc does not include the selected language, the disc's default language is set.

Setting of the Menu Language

Set the language used for the menus (title menu, etc.).

Setting item: Menu Language

Setting contents: Auto / EN / JP / DE / ES / FR / IT / SE / RU / CN

- When "Auto" is selected, the primary menu language among the recorded ones is played.

To play in a language other than those displayed

- 1 Touch [Code].
The numeric keypad screen is displayed.
- 2 Touch the 4-digit numeral of the language number.
As for the language number, refer to "List of Language Codes" (page 81).
- 3 Touch [Enter] to memorize the number.

Setting of the Audio Language

Set the audio language produced from the speakers.

Setting item: Audio Language

Setting contents: Auto / EN / JP / DE / ES / FR / IT / SE / RU / CN

- When "Auto" is selected, the primary audio language among the recorded ones is played.

To play in a language other than those displayed

- 1 Touch [Code].
The numeric keypad screen is displayed.
- 2 Touch the 4-digit numeral of the language number.
As for the language number, refer to "List of Language Codes" (page 81).
- 3 Touch [Enter] to memorize the number.

Setting of the Subtitle Language

Set the language of the subtitles displayed on the screen.

Setting item: SUBT. Language

Setting contents: Auto / EN / JP / DE / ES / FR / IT / SE / RU / CN

- When "Auto" is selected, the primary subtitle language among the recorded ones is played.

To play in a language other than those displayed

- 1 Touch [Code].
The numeric keypad screen is displayed.
- 2 Touch the 4-digit numeral of the language number.
As for the language number, refer to "List of Language Codes" (page 81).
- 3 Touch [Enter] to memorize the number.

Changing the Country Code Setting

Set the country number of which you want to set the rating level (Parental lock).

Setting item: Country Code

Setting contents: Auto / Other

- Auto: The primary country code among those recorded is played.
- Other: The setting content changes to "Other" if the desired country code is input.

- When the settings are changed, the old settings are overwritten. Make a note of the current settings before making changes. The settings are cleared when the vehicle's battery is disconnected.

- 1 Touch [Code].
- 2 Touch [Delete All] or [←].
Delete the displayed country number.
- 3 Touch the 4-digit country code.
As for the country number, refer to "List of Country Codes" (page 82 and 83).
- 4 Touch [Enter] to memorize the code.

Setting the Rating Level (Parental Lock)

This function can help restrict the viewing of movies to children of appropriate age levels only.

Setting item: Parental

Setting content: Input

- When the settings are changed, the old settings are overwritten. Make a note of the current settings before making changes. The memory is cleared when the vehicle's battery is disconnected.
- On unrated DVDs, playback will not be restricted even if the rating level is set.
- If you want to play back DVD software with the parental lock feature and its use is currently restricted, change the rating level and the country number in order to play back the DVD.
- Once set, this rating level remains in memory until changed. To enable playback of discs of higher rating levels or to cancel the parental lock, the setting must be changed.
- Not all DVDs provide a Parental Lock feature. If you are unsure about a DVD, play it first to confirm. Do not leave DVDs accessible to young children for whom you deem them inappropriate.

- 1 Touch [Input].
The numeric keypad screen is displayed.
- 2 Touch the numeric keypad to input a 4-digit password.
The initial number is 1111. Input number are displayed as "*".
- 3 Touch [Enter] to memorize the number.
The Parental screen appears.

Set the rating level of PARENTAL

- 4 Touch [▶] of Parental to turn on.
- 5 Touch [◀] or [▶] of Parental Level to select the rating level (1 to 8).
Select "OFF" to cancel the parental lock or if you do not want to set a rating level. The smaller the number, the higher the rating level.
- 6 Touch [↶] to return to the previous screen.

Changing the password

- 4 Touch [Input] of Password Change.
The numeric keypad screen is displayed.
- 5 Touch the input screen to enter a new 4-digit password.
 - *Keep a note of the number somewhere safe in case you should forget it.*
- 6 Touch [Enter] to memorize the number.
- 7 Touch [↶] to return to the previous screen.

Changing the rating level temporarily

Some discs may request that you change the rating level set in the default settings during playback. In this case, the message appears on the monitor screen "Parental Level Change OK? [YES] [NO]."

If this screen appears, change the level as follows:

- **To change parental level and play, touch [YES].**
When [YES] is touched, the numeric keypad input screen is displayed. Input the 4-digit password in "Setting the Rating Level (Parental Lock)" you set, then touch [ENT].
- **To play without changing the parental level, touch [NO].**
(When [NO] is touched, playback will be at the parental level set in "Setting the Rating Level (Parental Lock).")

Setting the Downmix Mode

This function applies to Dolby Digital, DTS stream sound.

Setting item: Downmix Mode

Setting contents: Surround / Stereo

- Surround: Surround compatible Downmix
Stereo: Stereo Downmix

Setting the TV Screen Mode

Use the procedure described below to modify the output screen according to the type of TV monitor (rear monitor) being used. This setting can also be applied for the INA-W900.

If the rear monitor is not connected, the screen setting is 16:9.

Setting item: TV Screen

Setting contents: 4:3 LB / 4:3 PS / 16:9

- *For some discs, the picture may not be set to the selected screen size. (For details, refer to the explanation on the disc's jacket.)*

4:3 LETTER BOX:

Select this when connected to a conventional 4:3 size (normal TV aspect ratio) monitor. There may be black stripes visible at the top and bottom of the screen (when playing a 16:9 size movie). The width of these stripes will depend upon the original aspect ratio of the theatrical release of the movie.



4:3 PAN-SCAN:

Select this when connected to a conventional 4:3 size monitor. The picture will fill the entire TV screen. However, due to the mismatch in aspect ratio, parts of the movie at the extreme left and right sides will not be visible (when playing a 16:9 size movie).



16:9 WIDE:

Select this when connected to a wide screen TV. This is the factory setting.



Playing MP3/WMA/AAC Data (File Play Mode)

When using discs containing both audio data and MP3/WMA/AAC data.

Setting item: File Play Mode

Setting contents: CD / CMPM

- CD: Plays only the audio data on discs containing both audio data and MP3/WMA/AAC data.
- CMPM: Plays only the MP3/WMA/AAC files on discs containing both audio data and MP3/WMA/AAC data.

- *Insert the disc when playback is stopped and remove the disc from the unit before setting.*
- *When an MP3-compatible CD changer is used, this setting cannot be applied.*

RADIO Setup

Digital SEEK Setting (HD Radio™ mode only)

After carrying out the steps 1 to 3 of “To display the General mode screen” explained on page 52, perform the operation described below.

- 1 Press SOURCE/⏻ on the unit.**
The SOURCE selection screen is displayed.
- 2 Touch [↵] on the main source screen.**
The SETUP main screen is displayed.
- 3 Touch [≫] of Source Setup.**
The Source Setup screen appears.
- 4 Touch [≫] of Radio Setup.**
The Radio Setup screen appears.
- 5 Touch [◀] or [▶] to select ON/OFF of Digital Seek.**
ON: SEEK UP/DOWN is used only for the digital radio station.
OFF: SEEK UP/DOWN is used for DIGITAL and ANALOG radio stations. However, the strong signals have priority during SEEK.
- 6 Touch [↶] to return to the previous screen.**
Touch [Exit] to return to the main source screen that was displayed before the setup operation was started.

DISPLAY Setup

Display Setup Operation

To display the Display mode screen:

To watch a video source, your vehicle must be parked with the ignition key in the ACC or ON position. To do this, follow the procedures below.

- 1 Bring your vehicle to a complete stop at a safe location. Engage the parking brake.
- 2 Keep pushing the foot brake and release the parking brake once then engage it again.
- 3 When the parking brake is engaged for the second time, release the foot brake.

- For automatic transmission vehicles, place the transmission lever in the Park position.

Now, the locking system for the Display mode operation has been released. Engaging the parking brake can reactivate the Display mode, as long as the car's ignition has not been turned off. It is not necessary to repeat the above procedure (1 through 3) of “To display the Display mode screen.” Each time the ignition is turned OFF, perform the procedure of “To display the Display mode screen.”

The following steps 1 to 5 are common operations to each “Setting item” of DISPLAY Setup. Refer to each section for details.

- 1 Press SOURCE/⏻ on the unit.**
The SOURCE selection screen is displayed.
 - 2 Touch [↵] on the main source screen.**
The SETUP main screen is displayed.
 - 3 Touch [≫] of Display Setup.**
The Display Setup screen appears.
 - 4 Touch [◀], [▶] or [≫] etc., of the desired item to change its setting.**
- Setting items:**
Visual EQ / Dimmer / Dimmer Low Level / Function Guide Fade / Base Color / Screen Alignment
- 5 Touch [↶] to return to the previous screen.**
Touch [Exit] to return to the main source screen that was displayed before the setup operation was started.
- Immediately after changing the settings of Display Mode (While the system is writing data automatically) do not turn the ignition key (engine key) to OFF. Otherwise, the settings may not be changed.

Visual EQ Setting Operation

The visual setting of Bright, color, contrast, etc. can be adjusted in this mode.

Setting item: Visual EQ

Further setting items:

Visual EQ* ↔ Bright ↔ Color* ↔ Tint* ↔ Contrast ↔ Sharp* ↔ User Memory*

* The setting is unavailable in navigation mode.

Touch [◀] or [▶] etc., of the desired item to change its setting.

- The settings are available in the visual source mode only.
- The further setting items can be changed by touching [▲]/[▼].
- Only one setting item can be displayed on each page, you can select the desired brightness, picture tint, etc through the screen displayed.

Selecting the Visual EQ Mode (Factory's setting)

You can select a mode suitable for the subject image.

Further setting item: Visual EQ

Setting contents: OFF (FLAT) / Night M. / Soft / Sharp / Contrast / P-1 / P-2

OFF (FLAT):	Initial Setting
Night M.:	Suitable for movies in which dark scenes frequently appear.
Soft:	Suitable for CGs and animated films.
Sharp:	Suitable for old movies where images are not clearly shown.
Contrast:	Suitable for recent movies.
P-1:	Recalls the Visual EQ mode being stored on preset No.P-1 from "Storing Visual EQ" (page 51).
P-2:	Recalls the Visual EQ mode being saved on preset No.P-2 from "Storing Visual EQ" (page 51).

- To return to the default video settings, set this function to OFF. Any Visual EQ selection or changes made are reset their initial settings.
- If any adjustments are made to the existing Visual EQ selections (Night M., etc.), "Custom" is displayed.

Adjusting Brightness

Further setting item: Bright

Setting content: -15 ~ +15

You can adjust the brightness between Min (-15) and Max (+15). When it reaches the minimum or maximum point, the display shows "Min" or "Max" respectively.

- When any Visual EQ Preset is selected, the brightness is automatically adjusted according to the car's interior lighting as long as AUTO is set in "Setting the Brightness of the Backlighting" (page 51).

Adjusting Color of Picture

Further setting item: Color

Setting content: -15 ~ +15

You can adjust the color between Min (-15) and Max (+15). When it reaches the minimum or maximum point, the display shows "Min" or "Max" respectively.

- Color adjustment can be made only in DVD and AUX modes.

Adjusting Tint of Picture

Further setting item: Tint

Setting content: G15 ~ R15

Adjust the color from G15 to R15. "G Max" or "R Max" is displayed at the maximum of each color.

- Tint adjustment can be made only in DVD and AUX modes.
- When setting PAL, you can not adjust the TINT.

Adjusting Image Contrast

Further setting item: Contrast

Setting content: -15 to +15

Contrast adjustment range is -15 to +15. "Low" and "High" appear as the minimum and maximum values specified.

Adjusting Picture Quality

Further setting item: Sharp

Setting content: -15 to +15

Picture quality adjustment range is -15 to +15. "Soft" and "Hard" appear as the minimum and maximum values specified.

- Picture quality adjustment can be made only in DVD and AUX modes.

Storing Visual EQ

You can store the settings made for "Adjusting Image Brightness, Tint, Depth, Picture Quality and Contrast."

Further setting item: User Memory

Setting contents: P-1 / P-2

- 1 After completing "Adjusting Brightness, Tint, Depth, Picture Quality, and Contrast" (page 51), touch [◀] or [▶] of User Memory and then select preset No. "P-1" or "P-2" to which the settings are to be stored.
 - 2 After selecting a preset No., touch [Memory]. The adjusted Visual EQ mode is stored by the above operations.
- You can recall the Visual EQ mode stored here from P-1 or P-2 of "Selecting the Visual EQ Mode (Factory's setting)" (page 51).

Setting the Brightness of the Backlighting

Backlighting is provided by a fluorescent light built into the liquid crystal panel. The illumination control adjusts the brightness of the backlighting based on the car ambient lighting for easier viewing.

Setting item: Dimmer

Setting contents: OFF / ON / Auto

OFF:	Deactivate Auto Dimmer mode to keep the background illumination of the monitor bright.
ON:	Keep the background illumination of the monitor dark.
Auto:	Adjust the brightness of the background illumination of the monitor automatically to the brightness of the car interior.

- When ON or Auto is set, the setting is also applied for the button lighting in "Adjusting the Dimmer of Button Lighting at Night" (page 53).

Adjusting the Minimum Level of Backlight

You can adjust the brightness of the backlight (LOW). This function could be used, for instance, to change the screen brightness while traveling at night.

Setting item: Dimmer Low Level

Setting contents: -15 to +15

You can adjust the level between Min (-15) and Max (+15). When it reaches the minimum or maximum point, the display shows "Min" or "Max" respectively.

Setting the Function Guide display ON/OFF

When on is set, the function guide will be hidden automatically after no operation is performed for 5 seconds.

Setting item: Function Guide Fade

Setting contents: OFF / ON

Switching the Font Back Display Color

You can choose from 4 different display colors for the font back (source title, shortcut display, etc.).

Setting item: Base Color



Setting contents: Blue / Red / Green / Amber



Adjusting the Touch Panel

Adjustment becomes necessary when the display position on the LCD and the touch position on the touch panel do not match.

Setting item: Screen Alignment

Setting contents:  / Reset

- 1 Touch [] of Screen Alignment.
The adjustment screen appears.
- 2 Accurately touch the  mark provided in the lower left corner of the screen.
The screen changes to the adjustment screen.
- 3 Accurately touch the  mark provided in the upper right corner of the screen.
This completes adjustment, and returns to the Display setup mode screen.

- If you have touched a location other than the  mark, touch [Reset] to restore the adjustment screen to the initial setting.
- If you touch [] on the adjustment screen, no adjustment is done and the Display setup screen is restored.

GENERAL Setup

General Setup Operation

To display the General mode screen:





To watch a video source, your vehicle must be parked with the ignition key in the ACC or ON position. To do this, follow the procedures below.

- 1 Bring your vehicle to a complete stop at a safe location. Engage the parking brake.
- 2 Keep pushing the foot brake and release the parking brake once then engage it again.
- 3 When the parking brake is engaged for the second time, release the foot brake.

- For automatic transmission vehicles, place the transmission lever in the Park position.

Now, the locking system for the General mode operation has been released. Engaging the parking brake can reactivate the General mode, as long as the car's ignition has not been turned off. It is not necessary to repeat the above procedure (1 through 3) of "To display the General mode screen."
Each time the ignition is turned OFF, perform the procedure of "To display the General mode screen."

The following steps 1 to 5 are common operations to each "Setting item" of GENERAL Setup. Refer to each section for details.

- 1 **Press SOURCE/ on the unit.**
The SOURCE selection screen is displayed.
- 2 **Touch [] on the main source screen.**
The SETUP main screen is displayed.
- 3 **Touch [] of General Setup.**
The General Setup screen appears.
- 4 **Touch [] or [] of the desired item to change its setting.**

Setting items:

Clock / Beep / Auto Scroll / LED Dimmer Level

- 5 **Touch [] to return to the previous screen.**
Touch [Exit] to return to the main source screen that was displayed before the setup operation was started.
- Immediately after changing the settings of General Mode (While the system is writing data automatically) do not turn the ignition key (engine key) to OFF. Otherwise, the settings may not be changed.

Displaying the Time

The clock indication on the monitor display is turned on or off respectively.

Setting item: Clock

Setting contents: OFF / ON

- The clock of the unit will be automatically updated according to the data that the Navigation System provides, and cannot be adjusted manually.
- If the GPS antenna is not connected correctly, the clock indication on the unit may be wrong because the time information cannot be received. In this case, it is suggested to set "Clock" to "OFF".

Sound (Beep) Guide Function

Setting item: Beep

Setting contents: OFF / ON

OFF: Deactivate the Sound Guide mode. The sound guide beep will not be produced when a button on the unit is pressed.

ON: Activate the Sound Guide mode.

Setting the Scroll

Scroll display is available if CD text, folder name, file name or tag information is entered.

Setting item: Auto Scroll

Setting contents: OFF / ON

OFF: Turns off the AUTO scroll mode. Scroll display is done once as a track is changed.

ON: Turns on the AUTO scroll mode. Scroll display is repeated as long as the mode is turned on.

- The display scrolls on the unit when the screen is filled up.
- Song, artist and album name, etc. scrolls when an iPhone/iPod is connected.
- Short/Long Station name, Song, Artist, and album name scrolling are displayed in HD Radio mode.

Adjusting the Dimmer of Button Lighting at Night

You can adjust the brightness of the button lighting at night with the dimmer.

Setting item: LED Dimmer Level

Setting level: -2 to +2

SYSTEM Setup

System Setup Operation

To display the System mode screen:

To watch a video source, your vehicle must be parked with the ignition key in the ACC or ON position. To do this, follow the procedures below.

- 1 Bring your vehicle to a complete stop at a safe location. Engage the parking brake.
- 2 Keep pushing the foot brake and release the parking brake once then engage it again.
- 3 When the parking brake is engaged for the second time, release the foot brake.

- For automatic transmission vehicles, place the transmission lever in the Park position.

Now, the locking system for the System mode operation has been released. Engaging the parking brake can reactivate the System mode, as long as the car's ignition has not been turned off. It is not necessary to repeat the above procedure (1 through 3) of "To display the System mode screen." Each time the ignition is turned OFF, perform the procedure of "To display the System mode screen."

The following steps 1 to 5 are common operations to each "Setting item" of SYSTEM Setup. Refer to each section for details.

- 1 Press SOURCE/⏻ on the unit.**
The SOURCE selection screen is displayed.
- 2 Touch [↵] on the main source screen.**
The SETUP main screen is displayed.
- 3 Touch [≫] of System Setup.**
The System Setup screen appears.
- 4 Touch [◀] or [▶] etc., of the desired item to change its setting.**

Setting items:

IN Int. Mute^{*1} / IN Int. Icon / Remote Sensor^{*2} / Camera IN / AUX IN / AUX IN Level^{*3} / AUX IN Signal^{*3} / AUX OUT / BLUETOOTH IN / AUX+ IN / AUX+ Level^{*4} / Rear Source^{*2}

^{*1} Displayed only when BLUETOOTH IN is OFF.

^{*2} Displayed only when AUX OUT is ON.

^{*3} Not displayed when OFF is set in "Setting the AUX Mode" (page 55).

^{*4} Not displayed when OFF is set in "Setting the AUX+ Mode" (page 55).

- 5 Touch [↶] to return to the previous screen.**

Touch [Exit] to return to the main source screen that was displayed before the setup operation was started.

- Immediately after changing the settings of System Mode (while the system is writing data automatically) do not turn the ignition key (engine key) to OFF. Otherwise, the settings may not be changed.

Setting the External Device Interrupt Mode

If an Alpine Ai-NET Auxiliary Input Adapter (KCA-801B) is connected to the INA-W900, an Auxiliary Source will be allowed to interrupt the current audio source. For example, you can listen to a portable MP3 player through your car audio system even with a CD changer connected and playing. The CD changer will automatically mute when switched to the AUX Input. For further details on how to use the Alpine KCA-801B, see your authorized Alpine dealer.

Setting item: *IN Int. Mute*
Setting contents: *OFF / ON*

- OFF: The volume level can be adjusted in Interrupt mode.
- ON: Sound will not be output. The icon that is set in "Setting the Interrupt Icon Display" is displayed.

- The auxiliary device being connected must have an Interrupt wire with a negative trigger for this function to operate automatically. Otherwise, a separate switch needs to be added to switch it manually.*

Setting the Interrupt Icon Display

The unit can display the icon of an external device, such as a telephone, whenever a phone call comes in to tell you there is a phone call.

Setting item: *IN Int. Icon*
Setting contents: *INT / TEL*

- INT: The INT icon appears on the display.
- TEL: When the external device (telephone) sends the interrupt signal, the telephone icon appears on the display.

Switching the function of the remote sensor

For remote control operation, the remote sensor of the external device (monitor, etc.) can be switched, as you prefer.

Setting item: *Remote Sensor*
Setting contents: *Front / Rear*

- Front: The remote sensor of this unit is effective.
 - Rear: The remote sensor of the external monitor connected to AUX OUT of this unit becomes effective. The remote control operates the source connected to the AUX OUT terminals.
- The touch panel rear monitor sensor has priority over the remote control sensor. If the rear monitor (connected to the Alpine rear monitor output via the Monitor control lead) is touched, the command is executed regardless of the remote control sensor switch setting. Note, however, that the remote control sensor that has been set takes priority if it has been 5 seconds since last touching the panel.*
 - When an optional DVD changer or DVD player is connected, and the remote control sensor is set to Rear, some soft button operations ([■] STOP, etc.) cannot be performed. In this case, set the remote control sensor to Front.*

Setting the Rear Camera Input

With an optional rear camera connected, rear view video is output to the monitor. When the rear camera is connected, set this item to ON.

Setting item: *Camera IN*
Setting contents: *OFF / ON*

After setting this item to ON, touch [>>], the following further items can be adjusted.

Rear camera guide line display setting

You can set whether the rear camera guide line is displayed or not.

Further Setting item: *Guide Line*
Setting contents: *OFF/ON*

Adjusting the Rear Camera Guide Line

You can adjust the rear camera guide line position.

Further Setting item: *Guide Line Adjustment*

1 Touch [>>] of Guide Line Adjustment.

The guide line adjustment screen is displayed.

2 Touch the guide line you intend to adjust.

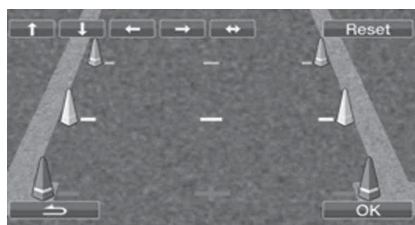

3 Touch [↑], [↓], [←] or [→] to adjust the position of the guide.

After moving the guide, when you touch [↔], the guides in the horizontal row are aligned in a row.

4 After the adjustment is completed, touch [OK].

You can touch [Reset] during adjustment to return to the setting prior to adjustment.

Setting the AUX Mode

Setting item: AUX IN

Setting contents: OFF / ON / DVD / Game / EXT. DVD. / DVD CHG

- OFF: AUX source is not displayed.
ON: AUX source is displayed.

- OFF is not displayed when the optional DVD player or DVD changer is connected. During System setup, although the AUX name can be changed, it is not displayed on the source selection screen.
- When OFF is selected, the settings related to AUX cannot be changed from this unit.
- The selected source name is displayed instead of AUX source name. Select SOURCE to switch to the guide function of each mode.

Adjusting the External Input Audio Level

After setting to ON in "Setting the AUX Mode", this setting can be carried out.

Setting item: AUX IN Level

Setting contents: Low / High

- Low: Decreases the external input audio level.
High: Increases the external input audio level.

Switching the Visual Input Signal System

After setting to ON in "Setting the AUX Mode", this setting can be carried out.

Setting item: AUX IN Signal

Setting contents: NTSC / PAL

- The video input type can be changed.

Setting the Picture Output

Outputs the picture of the source selected on the INA-W900 connected to the rear monitor.

Setting item: AUX OUT

Setting contents: OFF/ON

- OFF: The "Remote Sensor" and "Rear Source" items are not displayed on the System Setup screen.
ON: The "Remote Sensor" and "Rear Source" items are displayed on the System Setup screen.

Setting the BLUETOOTH Connection (BLUETOOTH IN)

Setting item: BLUETOOTH IN

Setting contents: OFF / Adapter

- OFF: Select to ignore any external interrupts.
Adapter: Select when the optional BLUETOOTH box is connected. The TEL screen of the BLUETOOTH is displayed. When an external interruption occurs, the display changes to the TEL screen.

Setting the AUX+ Mode

An external device (such as a portable music player) can be connected to the Bluetooth interface connector of this unit. A special Conversion cable (KCE-237B) is necessary to adapt the Bluetooth interface connector as an AUX IN.

Setting item: AUX+ IN

Setting contents: OFF / ON

- OFF: AUX+ source is not displayed
ON: AUX+ source is displayed

- When OFF is selected, the settings related to AUX+ cannot be changed from this unit.

Adjusting the AUX+ Audio Level

After setting to ON in "Setting the AUX+ Mode", this setting can be carried out.

Setting item: AUX+ Level

Setting contents: Low / High

- Low: Decreases the external input audio level.
High: Increases the external input audio level.

Setting the Rear Entertainment System

The rear entertainment function independently routes different sources to the front and the rear inside a car. For example, while listening to the radio or other audio source in the front, DVD can be enjoyed in the rear with the optional rear monitor and headphones.

Setting item: Rear Source

Setting contents: OFF / Disc / iPod / DVD CHG. / EXT.DVD / AUX

- Select OFF to cancel the rear entertainment mode.
- The display of setting contents may vary depending on the setting and connected device.

Sirius Setup

Sirius Setup Operation

The operation can be performed when the optional Sirius receiver box is connected.

To display the Sirius mode screen:

To watch a video source, your vehicle must be parked with the ignition key in the ACC or ON position. To do this, follow the procedures below.

- 1 Bring your vehicle to a complete stop at a safe location. Engage the parking brake.
- 2 Keep pushing the foot brake and release the parking brake once then engage it again.
- 3 When the parking brake is engaged for the second time, release the foot brake.

- For automatic transmission vehicles, place the transmission lever in the Park position.

Now, the locking system for the Sirius mode operation has been released. Engaging the parking brake can reactivate the Sirius mode, as long as the car's ignition has not been turned off. It is not necessary to repeat the above procedure (1 through 3) of "To display the Sirius mode screen."

Each time the ignition is turned OFF, perform the procedure of "To display the Sirius mode screen."

The following steps 1 to 6 are common operations to each "Setting item" of Sirius Setup. Refer to each section for details.

- 1 **Press SOURCE/⏻ on the unit.**
The SOURCE selection screen is displayed.
- 2 **Touch [⏻] on the main source screen.**
The SETUP main screen is displayed.
- 3 **Touch [➤] of Source Setup.**
The Source Setup screen appears.
- 4 **Touch [➤] of Sirius Setup.**
The Sirius adjustment screen appears.
- 5 **Touch [➤] of the desired item to change its setting.**

Setting items:

Clear Lock / Clear Skip / Sports / S-Seek Alert Settings

- 6 **Touch [↶] to return to the previous screen.**
Touch [Exit] to return to the main source screen that was displayed before the setup operation was started.

Clearing the Lock of Channels

The connected optional Sirius receiver box may have the ability to lock out channels with password protection. The locked channels cannot be accessed with this unit. However, the following operation will clear the lock to receive these channels as normal.

Setting item: Clear Lock

- 1 **Touch [➤] of the Clear Lock.**
A message is displayed.
 - 2 **Touch [YES] to clear the lock of all the locked channels.**
Touch [NO] to cancel.
- You cannot lock a channel from this unit. Please operate from the optional Sirius receiver box. For details, refer to the owner's manual of the Sirius receiver box.

Clearing the Setting of Hidden Channels

The optional SIRIUS Receiver Box may have the ability to create an undesired channel list. Using the channel UP/DOWN operation skips the channels in this list automatically. The following operation will prevent the skipping of the listed channels.

Setting item: Clear Skip

- 1 **Touch [➤] of the Clear Skip.**
A message is displayed.
 - 2 **Touch [YES] to clear the setting of all the hidden channels.**
Touch [NO] to cancel.
- You cannot hide a channel from this unit. Please operate from the Sirius receiver box. For details, refer to the owner's manual of the optional Sirius receiver box.

Setting the Favorite Sports Team announcement

The following operation sets the announcement for your favorite sports team.

One team from each league can be stored on the unit.

Setting item: Sports

- 1 **Touch [➤] of the Sports.**
The display changes to Sports setting screen.
- 2 **Touch [◀] or [▶] of the Game Alert to select ON.**
The received announcement for all stored sports teams is set. If OFF is set, no announcements will be made.
- 3 **Touch [➤] of the Favorite Teams.**
The display changes to League selection screen.
- 4 **Touch [➤] of your desired league.**
The display changes to the team list of the selected league.

5 Touch [▶] of your favorite team.

The selection key is displayed.

6 Touch [◀] or [▶] of the desired announcement type.

Initial: Announces when a game starts.

Score: At the beginning of the game, the announcement interrupts; announces every time the score changes.

- Select “None” on the list if you do not want to store in memory. ALERT interruption does not occur.

Setting the Sirius Seek (S-Seek) Alert

The following operations can be performed to manage the stored Songs, Artists and Sports teams information. (About how to store the information, refer to “Storing the desired Song/Artist (Sirius mode only)” on page 74 and “Storing desired Sports Teams (Sirius mode only)” on page 74.)

Setting item: S-Seek Alert Settings

Touch [≫] of the S-Seek Alert Settings.

The display changes to S-Seek Alert Settings menu screen.

Setting the announcement individually for a Song/Artist/Sport Team

You can manage the stored Alert (Songs, Artists, Sports teams) individually by this setting.

1 Touch [≫] of the Memory Recall.

The Memory Recall List screen is displayed.

Display example for Memory Recall List screen

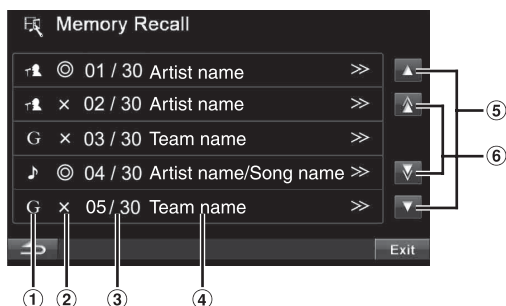

- ① Displays the type of the stored Memory Recall.
 - ♪ : Song Memory Recall
 - 👤 : Artist Memory Recall
 - G : Sports team Memory Recall
- ② Displays the ON/OFF of Memory Recall Alert.
 - ◎ : ON
 - ✕ : OFF
- ③ Displays the sequence number of stored item and the total items can be stored.
- ④ Displays the song, artist or team name.
- ⑤ Scroll the list one line at a time by touching [▲] or [▼].
- ⑥ Scroll the list one page at a time by touching [▲] or [▼].

2 Touch [≫] of the desired song, artist or team.

The Memory Recall setting screen is displayed.

3 Touch [◀] or [▶] of the Song Seek, Artist Seek or Game.

Set to ON if you want to receive this alert announcement.

Set to OFF if you do not want to receive this announcement.

- If Game is set, touch [◀] or [▶] to select the interruption type (Initial/Score/OFF).
- Touching [≫] of Delete after step 2 will delete this Memory Recall.
- You can change the type of Memory Recall from song to artist by touching [≫] of Seek Artist only after step 2. If you want to enjoy other songs of this artist. (Only for the song type memory recall).

Setting ON/OFF of all Songs/Artists Memory Recall Alert

Determines whether the received announcement of all stored Songs/Artist is set or not.

Touch [◀] or [▶] of the S-Seek Alert to select ON/OFF.

ON: Set to receive announcements.

OFF: No announcements.

Deleting all stored Sirius Seek Alert

The operation will delete all stored songs, artists and teams memory recall information.

1 Touch [≫] of the Delete All S-Seek.

A message is displayed.

2 Touch [YES] to clear the information of all stored memory recall.

Touch [NO] to cancel.

IMPRINT Operation (Optional)

Alpine introduces IMPRINT - the world's first technology that thoroughly eliminates in-car acoustic problems that normally degrade sound quality, which enables us to experience music the way the artist intended. When the IMPRINT audio processor (PXA-H100) (sold separately) is connected to this unit, MultEQ and the following sound adjustment can be performed.

To display the IMPRINT mode screen:

To watch a video source, your vehicle must be parked with the ignition key in the ACC or ON position. To do this, follow the procedures below.

- 1 Bring your vehicle to a complete stop at a safe location. Engage the parking brake.
- 2 Keep pushing the foot brake and release the parking brake once then engage it again.
- 3 When the parking brake is engaged for the second time, release the foot brake.

• For automatic transmission vehicles, place the transmission lever in the Park position.

Now, the locking system for the IMPRINT mode operation has been released. Engaging the parking brake can reactivate the IMPRINT mode, as long as the car's ignition has not been turned off. It is not necessary to repeat the above procedure (1 through 3) of "To display the IMPRINT mode screen."
Each time the ignition is turned OFF, perform the procedure of "To display the IMPRINT mode screen."

Changing MultEQ mode

MultEQ, developed by Audyssey Labs, automatically corrects the audio for the listening environment. The system is optimized for selected positions in the vehicle. To accomplish this, MultEQ must take measurements of the vehicles response characteristics. For details on the set up procedure, consult your authorized Alpine dealer.

- 1 Press **SOURCE/⏻** on the unit.
The SOURCE selection screen is displayed.
- 2 Touch **[↵]** on the main source screen.
The SETUP main screen is displayed.
- 3 After touching **[▼]** to display the IMPRINT Setup adjusting item, touch **[>>>]** of IMPRINT Setup, the MultEQ mode selection screen will be displayed.
- 4 Touch **[◀]** or **[▶]** to change the setting.

Setting contents: OFF / Curve 1 / Curve 2

- OFF: Adjusting the audio settings manually to create your own preference.
- Curve1/
Curve2: Correcting the audio for the listening environment automatically.

- The Curve mode can be selected only when curve 1 and curve 2 are stored.
- When MultEQ is set to Curve 1 or Curve 2, Media Xpander, X-Over, T.Corr, Subwoofer Phase, Subwoofer Channel, TW Setup, P-EQ, G-EQ and F-EQ can not be adjusted.

Adjusting Sound Setting in Manual Mode

You can change these sound settings to create your own preference when the MultEQ mode is set to OFF (Manual Mode).

Use steps 1 to 6 to select one of the Sound menu modes to modify. See the applicable section below for details about the selected item.

- 1 Check whether the Defeat mode is off.
- 2 Press **SOURCE/⏻** on the unit.
The SOURCE selection screen is displayed.
- 3 Touch **[↵]** on the source selection screen.
The SETUP main screen is displayed.
- 4 Touch **[>>>]** of Audio Setup.
The Audio Setup screen appears.
- 5 Touch **[A.Processor]**.
The A.Processor SETUP screen appears.
- 6 Touch **[◀], [▶]** or **[>>>]**, etc., of the desired item to change its setting.

Setting items: Media Xpander / X-Over / T.Corr / T.Corr Parameter / G-EQ / P-EQ / F-EQ / TW Setup*

* This function can be operable only when PXA-H100 (sold separately) is connected and 2.2ch (3WAY) mode is set. For details, refer to the Owner's Manual of PXA-H100.

- Touching **[Exit]** will change to the main source screen.
- Touching **[↶]** to return to the previous screen.
- Media Xpander, F-EQ, P-EQ and G-EQ Adjustment are inoperable when Defeat is set to ON.

Equalizer Presets (F-EQ)

10 typical equalizer settings and 6 user's preset setting are preset at the factory for a variety of musical source material.

Setting item: F-EQ

- 1 Touch **[>>>]** of F-EQ.
The F-EQ setup screen appears.
 - 2 Touch **[◀]** or **[▶]** of the desired type to set to ON.
Flat / Pops / Rock / News / Jazz&Blues / Electrical Dance / Hip Hop&Rap / Easy Listening / Country / Classical / User1 / User2 / User3 / User4 / User5 / User6
- Only one type can be set to ON.
 - By selecting User's 1 to 6, you can recall the stored preset number in "Adjusting the Graphic Equalizer Curve (G-EQ)" (page 60) or "Adjusting the Parametric Equalizer Curve (P-EQ)" (page 59).

Setting the Response Slope for the High Range Speaker (TW Setup)

Depending on the response characteristics of the speaker, care should be taken when setting the response slope of the high range speaker to FLAT in 2.2ch (3WAY) mode (see "Adjusting the Crossover Settings (X-OVER)" on page 60), as speaker damage may result.

Setting item: TW Setup

Touch [◀] or [▶] of TW Setup to select Factory's or User's.

Factory's: As protection from possible speaker damage, FLAT cannot be set for the response slope of the high range speaker in 2.2ch (3WAY) mode.

User's: The FLAT setting is possible in 2.2ch (3WAY) mode.

- The TW Setup mode can only be selected if the FRONT/REAR/SUBW. (4.2CH)/3WAY (2.2CH) switch on the IMPRINT audio processor (PXA-H100) is set to 3WAY (2.2CH).

Setting the MX Level (Media Xpander)

MX (Media Xpander) makes vocals or instruments sound distinct regardless of the music source. The FM radio, CD, USB memory and iPhone/iPod, will be able to reproduce the music clearly even in cars with a lot of road noise.

Setting item: Media Xpander

1 Touch [◀] or [▶] of Media Xpander to select ON or OFF.

OFF: Turns off the MX effect of every music source.

ON: Turns on the specified MX mode.

2 Touch [≫] after setting to ON.

The Media Xpander setup screen appears.

3 Touch [◀] or [▶] of the desired MX mode.

- Music source (such as radio broadcasts and CDs, excluding AM radio) level can be set.

MX CD (OFF, CD MX 1 to 3)

CD mode processes a large quantity of data. This data is used to reproduce the sound cleanly by making use of the data quantity.

MX CMPM (OFF, CMPM MX 1 to 3) / MX SAT (OFF, SAT MX 1 to 3)

This corrects information that was omitted at the time of compression. This reproduces a well-balanced sound close to the original.

MX FM (OFF, FM MX 1 to 3)

The medium to high frequencies become more clear, and produces well balanced sound in all the bands.

MX DVD (OFF, MOVIE MX 1 to 2)

The dialog portion of the video is reproduced more clearly.

(DVD MUSIC)

This disc contains a large quantity of data such as music clip. MX uses this data to reproduce the sound accurately.

MX AUX (OFF, CMPM MX, MOVIE MX, MUSIC MX)

Choose the MX mode (CMPM, MUSIC, or MOVIE) that corresponds to the media connected.

- When OFF is selected, MX effect of each MX mode will be OFF.
- Each music source, such as radio, CD and MP3 can have its own MX setting.
- MX mode does not function when MX is ON for AM radio.
- MX CMPM is applied for MP3/WMA/AAC and iPhone/iPod.
- MX SAT is applied for XM, Sirius and HD Radio reception.
- The MX setting can be performed only when a source is currently selected.

Adjusting the Parametric Equalizer Curve (P-EQ)

You can modify the Equalizer settings to create a response curve more appealing to your personal taste.

Setting item: P-EQ

1 Select L+R by touching [▶] of P-EQ.

When graphic EQ is set to L+R, the setting will be turned off.

2 Touch [≫] of P-EQ after selecting L+R.

The P-EQ list screen appears.

3 Adjust the P-EQ to your preference.

Adjusting the Band

Touch [◀] or [▶] of Band to select the band to be adjusted.

Band 1 / Band 2 / Band 3 / Band 4 / Band 5

Adjusting the Frequency

Touch [◀] or [▶] of Freq. to adjust the frequency of the selected band.

Adjustable frequency bands:
20 Hz to 20 kHz (in 1/3 octave steps)

Band-1: 20 Hz~80 Hz (63 Hz)
Band-2: 50 Hz~200 Hz (150 Hz)
Band-3: 125 Hz~3.2 kHz (400 Hz)
Band-4: 315 Hz~8 kHz (1 kHz)
Band-5: 800 Hz~20 kHz (2.5 kHz)

Adjusting the Level

Touch [◀] or [▶] of Level to adjust the level of selected band.

Adjustable level: -6 to +6 dB

Setting the Bandwidth

Touch [◀] or [▶] of Q to select the bandwidth.

Adjustable bandwidth: 1, 1.5, 3

4 To adjust another band, repeat step 3 and adjust all bands.

- The frequencies of adjacent bands cannot be adjusted within 4 steps.
- While adjusting the Parametric EQ, you should consider the frequency response of the connected speakers.
- When the parametric EQ is adjusted, the adjustment for graphic EQ becomes ineffective.

Adjusting the Graphic Equalizer Curve (G-EQ)

You can modify the equalizer settings to create a response curve more appealing to your personal taste.

Setting item: G-EQ

- 1 Select L+R by touching [▶] of G-EQ.**
When parametric EQ is set to L+R, this setting will be turned off.
- 2 Touch [≫] of G-EQ after selecting L+R.**
The G-EQ list screen appears.
- 3 Adjust the G-EQ to your preference.**

Adjusting the Band

Touch [◀] or [▶] of Band to select the band to be adjusted.

Band-1 (63 Hz) / Band-2 (150 Hz) / Band-3 (400 Hz) /
Band-4 (1 kHz) / Band-5 (2.5 kHz) / Band-6 (6.3 kHz) /
Band-7 (17.5 kHz)

Adjusting the Level

Touch [◀] or [▶] of Level to adjust the level of selected band.

Adjustable output level: -6 to +6 dB

- 4 To adjust another band, repeat step 3, and then adjust all bands.**

- When graphic EQ is adjusted, the adjustment for parametric EQ becomes ineffective.

Setting the Time Correction Unit (T.Corr Parameter)

You can change the unit, (cm or inch) of time correction.

Touch [◀] or [▶] of T.Corr Parameter to select cm or Inch.

Setting item: T.Corr Parameter

cm ↔ Inch

cm: The unit of time correction is cm.

Inch: The unit of time correction is Inch.

Adjusting the Time Correction (T.Corr)

Before performing the following procedures, refer to "About Time Correction" (page 62).

Setting item: T.Corr

- 1 Touch [≫] of T.Corr.**
The T.Corr adjustment screen appears.
- 2 Adjust the distance (0.0 to 336.6 cm) of a desired speaker by touching the respective [◀] or [▶] button.**

$L = (\text{distance to farthest speaker}) - (\text{distance to other speakers})$

Refer to "Time Correction Value List" on page 62.

- 3 Repeat step 2 to set another speaker.**
Set these values to achieve simultaneous sound propagation to the listening position from all speakers.

Adjusting the Crossover Settings (X-OVER)

Before performing the following procedures, refer to "About the Crossover" (page 63).

Setting item: X-Over

- 1 Touch [◀] or [▶] of X-Over to select L+R or L/R.**
L+R: Sets the same adjustment values for the left and right channels.
L/R: Different adjustment values can be set for the left and right channels.
- 2 Touch [≫] of X-Over.**
A speaker list on the X-Over screen is displayed.
- 3 Touch [≫] of the band to be adjusted.**
The screen changes to the X-Over screen to be adjusted.

4.2ch (FRONT/REAR/SUBW.) System

4.2ch (FRONT/REAR/SUBW.) System / (L+R)

Setting contents:

Low (SUB-W) / Mid (REAR) / High (FRONT)

4.2ch (FRONT/REAR/SUBW.) System / (L/R)

Setting contents:

Low (SUB-W)-L / Low (SUB-W)-R / Mid (REAR)-L /
Mid (REAR)-R / High (FRONT)-L / High (FRONT)-R

- 4 Adjust the crossover to your preference.**

Selecting the Cut-Off Frequency

Touch [◀] or [▶] of Freq., then select the cut-off frequency (crossover point).

The adjustable bandwidth differs depending on the speaker (channel).

4.2ch (FRONT/REAR/SUBW.) System

Setting contents:

Low (SUB-W) 20 Hz~200Hz

Mid (REAR) 20 Hz~200Hz

High (FRONT) 20 Hz~200Hz

Adjusting the Slope

Touch [◀] or [▶] of Slope, then adjust the HPF or LPF slope.

Adjustable slope: FLAT, -6 dB/oct., -12 dB/oct., -18 dB/oct.,
-24 dB/oct.

Adjusting the Level

Touch [◀] or [▶] of Level, then adjust the HPF or LPF level.

Adjustable output level: -12 to 0 dB.

- 5 Repeat steps 3 to 4 to make adjustment to the other bands.**

2.2ch (3WAY) System

2.2ch (3WAY) System / (L+R)

Setting contents:

Low / Mid-L / Mid-H / High

2.2ch (3WAY) System / (L/R)

Setting contents:

Low-L / Low-R / Mid-L-L / Mid-L-R / Mid-H-L /

Mid-H-R / High-L / High-R

4 Adjust the crossover to your preference.

Selecting the Cut-Off Frequency

Touch [◀] or [▶] of Freq., then select the cut-off frequency (crossover point).

The adjustable bandwidth differs depending on the speaker (channel).

2.2ch (3WAY) System

Setting contents:

Low / Mid-L	20 Hz~200 Hz
Mid-H	20 Hz~20 kHz
High	(1 kHz~20 kHz) ^{*1} /(20 Hz~20 kHz) ^{*2}

^{*1} When Factory's is selected, refer to "Setting the Response Slope for the High Range Speaker (TW Setup)" (page 59).

^{*2} When User's is selected, refer to "Setting the Response Slope for the High Range Speaker (TW Setup)" (page 59).

Adjusting the Level

Touch [◀] or [▶] of Level, then adjust the HPF or LPF level.

Adjustable output level: -12 to 0 dB.

Adjusting the Slope

Touch [◀] or [▶] of Slope, then adjust the HPF or LPF slope.

Adjustable slope: FLAT*, -6 dB/oct., -12 dB/oct., -18 dB/oct., -24 dB/oct.

* FLAT can be set for the HIGH slope only when User's is selected in "Setting the Response Slope for the High Range Speaker (TW Setup)" (page 59). Depending on the response characteristics of the speaker, care should be taken when setting the response slope to FLAT, as speaker damage may result. With this unit, a message is displayed when the response slope for the high range speaker is set to FLAT.

5 Repeat steps 3 to 4 to make adjustment to the other bands.

- While adjusting the X-Over, you should consider the frequency response of the connected speakers.
- About the 2.2ch (3WAY)/4.2ch (FRONT/REAR/SUBW.) system You can switch the system mode with the 2.2ch (3WAY)/4.2ch (FRONT/REAR/SUBW.) switch on the PXA-H100. For details, refer to the Owner's Manual of PXA-H100.

Storing Settings in the Memory

Adjustment or setting contents of X-Over, T.Corr and P/G-EQ can be stored.

Contents that can be stored vary depends on the audio processor used.

- 1 Check whether the Defeat mode is off.
- 2 Touch [MEMORY] on the A.PROCESSOR list display.
- 3 Within 5 seconds, touch any one of the preset buttons [P.SET 1] through [P.SET 6] on the A.Processor list screen.
The setting contents are stored.

- The stored contents will not be deleted even when the battery power cord is detached.
- This operation cannot be performed when a typical equalizer setting (e.g. Pops) is selected in "Equalizer Presets (F-EQ)" (page 58).

Calling up the Preset Memory

- 1 Check whether the Defeat mode is off.
- 2 Touch any one of the preset buttons [P.SET 1] through [P.SET 6] on the A.Processor list display to select the preset memory.

- It takes a few moments to call up the preset memory.

Setting the Subwoofer

- 1 Press SOURCE/⏻ on the unit.
The SOURCE selection screen is displayed.
- 2 Touch [⌂] on the source selection screen.
The SETUP main screen is displayed.
- 3 Touch [≫] of Audio Setup.
The Audio Setup screen appears.
- 4 Touch [◀] or [▶] of Subwoofer to set the subwoofer ON/OFF.
- 5 Touch [≫] of Subwoofer after setting the Subwoofer to ON.
The Subwoofer Setup screen appears.

Setting items:

Level / Phase* / System / Channel*

- * Only when Mult EQ OFF mode is selected.

Adjusting the Subwoofer Level

Touch [◀] or [▶] of Level to adjust the Subwoofer output.

Setting range: 0 to 15

Setting the Subwoofer System

When the subwoofer is on, you can select either System1 or System2 for the desired subwoofer effect.

Touch [◀] or [▶] of System to select System 1 or System 2

- System 1 : Subwoofer level changes according to the main volume setting.
- System 2 : Subwoofer level change is different from the main volume setting. For example, even at low volume settings, the subwoofer is still audible.

Setting the Subwoofer Phase

Touch [◀] or [▶] of Phase to select 0° or 180°

The subwoofer output phase is toggled SUBWOOFER NORMAL (0°) or SUBWOOFER REVERSE (180°).

Setting the Subwoofer Channel

You can set the subwoofer output to stereo or monaural. Make sure to set the correct output for your subwoofer type.

Touch [◀] or [▶] of Channel to select Stereo or Mono.

- Stereo: Subwoofer stereo (L/R) output
- Mono: Subwoofer monaural output

About Time Correction

The distance between the listener and the speakers in a car vary widely due to the complex speaker placement. This difference in the distances from the speakers to the listener creates a shift in the sounds image and frequency characteristics. This is caused by the time delay between the sound reaching the listener's right versus the left ear.

To correct this, this unit is able to delay the audio signal to the speakers closest to the listener. This effectively creates a perception of increased distance for those speakers. The listener can be placed at an equal distance between the left and right speakers for optimum staging. The adjustment will be made for each speaker in 3.4cm steps.

Example 1. Listening Position: Front Left Seat

Adjust the time correction level of the front left speaker to a high value and the rear right to a low value.

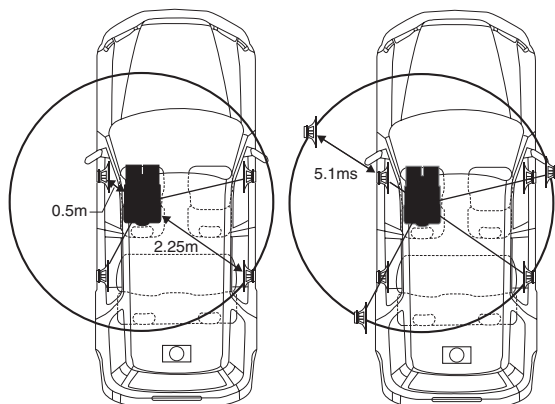

The sound is not balanced because the distance between the listening position and the various speakers is different. The difference in distance between the front left speaker and the rear right speaker is 1.75 m (68-7/8"). Here we calculate the time correction value for the front left speaker in the diagram on the above.

Conditions:

Farthest Speaker – listening position : 2.25 m (88-9/16")

Front left speaker – listening position : 0.5 m (19-11/16")

Calculation: $L = 2.25\text{ m} - 0.5\text{ m} = 1.75\text{ m}$ (68-7/8")

Time correction = $1.75 \div 343^{*1} \times 1000 = 5.1$ (ms)

**1 Speed of sound: 343 m/s (765 mph) at 20°C*

In other words, giving the front left speaker a time correction value of 5.1 ms makes it seem as if its distance from the listener is the same as the distance to the farthest speaker.

Time correction eliminates the differences in the time required for the sound to reach the listening position.

The time of the front left speaker is corrected by 5.1 ms so that its sound reaches the listening position at the same time as the sound of other speakers.

Example 2. Listening Position: All Seats

Adjust the time correction level of each speaker to almost the same level.

- 1** Sit in the listening position (driver's seat, etc.) and measure the distance (in meters) between your head and the various speakers.
- 2** Calculate the difference between the distance correction value to the farthest speaker and the other speakers.

$L = (\text{distance to farthest speaker}) - (\text{distance to other speakers})$

These values are the time correction values for the different speakers. Setting these values to make each sound reach the listening position at the same time as the sound of other speakers.

Time Correction Value List

Delay Number	Time Difference (ms)	Distance (cm)	Distance (inch)	Delay Number	Time Difference (ms)	Distance (cm)	Distance (inch)
0	0.0	0.0	0.0	51	5.1	173.4	68.3
1	0.1	3.4	1.3	52	5.2	176.8	69.7
2	0.2	6.8	2.7	53	5.3	180.2	71.0
3	0.3	10.2	4.0	54	5.4	183.6	72.4
4	0.4	13.6	5.4	55	5.5	187.0	73.7
5	0.5	17.0	6.7	56	5.6	190.4	75.0
6	0.6	20.4	8.0	57	5.7	193.8	76.4
7	0.7	23.8	9.4	58	5.8	197.2	77.7
8	0.8	27.2	10.7	59	5.9	200.6	79.1
9	0.9	30.6	12.1	60	6.0	204.0	80.4
10	1.0	34.0	13.4	61	6.1	207.4	81.7
11	1.1	37.4	14.7	62	6.2	210.8	83.1
12	1.2	40.8	16.1	63	6.3	214.2	84.4
13	1.3	44.2	17.4	64	6.4	217.6	85.8
14	1.4	47.6	18.8	65	6.5	221.0	87.1
15	1.5	51.0	20.1	66	6.6	224.4	88.4
16	1.6	54.4	21.4	67	6.7	227.8	89.8
17	1.7	57.8	22.8	68	6.8	231.2	91.1
18	1.8	61.2	24.1	69	6.9	234.6	92.5
19	1.9	64.6	25.5	70	7.0	238.0	93.8
20	2.0	68.0	26.8	71	7.1	241.4	95.1
21	2.1	71.4	28.1	72	7.2	244.8	96.5
22	2.2	74.8	29.5	73	7.3	248.2	97.8
23	2.3	78.2	30.8	74	7.4	251.6	99.2
24	2.4	81.6	32.2	75	7.5	255.0	100.5
25	2.5	85.0	33.5	76	7.6	258.4	101.8
26	2.6	88.4	34.8	77	7.7	261.8	103.2
27	2.7	91.8	36.2	78	7.8	265.2	104.5
28	2.8	95.2	37.5	79	7.9	268.6	105.9
29	2.9	98.6	38.9	80	8.0	272.0	107.2
30	3.0	102.0	40.2	81	8.1	275.4	108.5
31	3.1	105.4	41.5	82	8.2	278.8	109.9
32	3.2	108.8	42.9	83	8.3	282.2	111.2
33	3.3	112.2	44.2	84	8.4	285.6	112.6
34	3.4	115.6	45.6	85	8.5	289.0	113.9
35	3.5	119.0	46.9	86	8.6	292.4	115.2
36	3.6	122.4	48.2	87	8.7	295.8	116.6
37	3.7	125.8	49.6	88	8.8	299.2	117.9
38	3.8	129.2	50.9	89	8.9	302.6	119.3
39	3.9	132.6	52.3	90	9.0	306.0	120.6
40	4.0	136.0	53.6	91	9.1	309.4	121.9
41	4.1	139.4	54.9	92	9.2	312.8	123.3
42	4.2	142.8	56.3	93	9.3	316.2	124.6
43	4.3	146.2	57.6	94	9.4	319.6	126.0
44	4.4	149.6	59.0	95	9.5	323.0	127.3
45	4.5	153.0	60.3	96	9.6	326.4	128.6
46	4.6	156.4	61.6	97	9.7	329.8	130.0
47	4.7	159.8	63.0	98	9.8	333.2	131.3
48	4.8	163.2	64.3	99	9.9	336.6	132.7
49	4.9	166.6	65.7				
50	5.0	170.0	67.0				

About the Crossover

Crossover (X-Over):

This unit is equipped with an active crossover. The crossover limits the frequencies delivered to the outputs. Each channel is controlled independently. Thus, each speaker pair can be driven by the frequencies for which they have been optimally designed.

The crossover adjusts the HPF (high pass filter) or LPF (low pass filter) of each band, and also the slope (how fast the filter rolls off the highs or lows).

Adjustments should be made according to the reproduction characteristics of the speakers. Depending on the speakers, a passive network may not be necessary. If you are unsure about this point, please consult your authorized Alpine dealer.

4.2ch (FRONT/REAR/SUB.W.) mode

	Cut-off frequency (1/3 octave steps)		Slope		Level
	HPF	LPF	HPF	LPF	
Low range speaker	----	20 Hz - 200 Hz	----	FLAT, 6, 12, 18, 24 dB/oct.	0 to -12 dB
Rear high range speaker	20 Hz - 200 Hz	----	FLAT, 6, 12, 18, 24 dB/oct.	----	0 to -12 dB
Front high range speaker	20 Hz - 200 Hz	----	FLAT, 6, 12, 18, 24 dB/oct.	----	0 to -12 dB

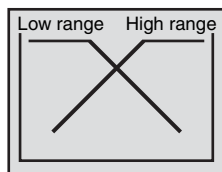

(Different from actual display)

2.2ch (3WAY) mode

	Cut-off frequency (1/3 octave steps)		Slope		Level
	HPF	LPF	HPF	LPF	
Low range speaker	----	20 Hz - 200 Hz	----	FLAT, 6, 12, 18, 24 dB/oct.	0 to -12 dB
Mid range speaker	20 Hz - 200 Hz	20 Hz - 20 kHz	FLAT, 6, 12, 18, 24 dB/oct.	FLAT, 6, 12, 18, 24 dB/oct.	0 to -12 dB
High range speaker	1 kHz - 20 kHz, (20 Hz ~ 20 kHz)*	----	FLAT* 6, 12, 18, 24 dB/oct.	----	0 to -12 dB

* Only when selecting User's in "Setting the Response Slope for the High Range Speaker (TW Setup)" (page 59).

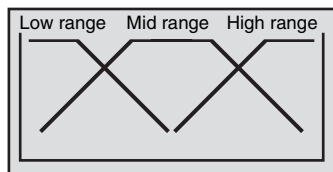

(Different from actual display)

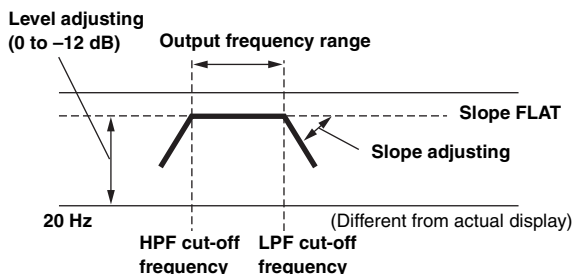

- **HPF (high pass filter):** Cuts the lower frequencies and allows the higher frequencies to pass.
 - **LPF (low pass filter):** Cuts the higher frequencies and allows the lower frequencies to pass.
 - **Slope:** The level change (in dB) for a frequency change of one octave.
 - The higher the slope value, the steeper the slope becomes.
 - Adjust the slope to FLAT to bypass the HP or LP filters.
 - Do not use a tweeter without the HPF on or set to a low frequency, as it may cause damage to the speaker due to the low frequency content.
 - You cannot adjust the crossover frequency higher than the HPF or lower than the LPF.
 - Adjustment should be made according to the recommended crossover frequency of the connected speakers. Determine the recommended crossover frequency of the speakers. Adjusting to a frequency range outside that recommended may cause damage to the speakers. For the recommended crossover frequencies of Alpine speakers, refer to the respective Owner's Manual.
- We are not responsible for damage or malfunction of speakers caused by using the crossover outside the recommended value.

BLUETOOTH Operation (Optional)

When the optional BLUETOOTH INTERFACE (KCE-400BT) is connected to this unit, the following operation can be performed.

Setup Before Using

About BLUETOOTH

BLUETOOTH is a wireless technology allowing communication between a mobile device or personal computer over short distances. This enables a hands-free call or data transmission between BLUETOOTH compatible devices. BLUETOOTH transmission is available in the unlicensed 2.4 GHz spectrum if the distance between devices is within 10 meters. For details, refer to the BLUETOOTH Home page (<http://www.BLUETOOTH.com/>).

- Depending on the BLUETOOTH version, a BLUETOOTH compatible device may not be able to communicate with this unit.
- Proper function of this unit with all BLUETOOTH compatible devices is not guaranteed. For handling of the BT compatible device, consult your ALPINE dealer or ALPINE website.
- Depending on the surroundings, BLUETOOTH wireless connection may be unstable.
- When you place a call, or perform setup operations, be sure to stop your car in a safe place.
- Depending on the connected BLUETOOTH compatible device(s), the function may differ. Also refer to the Owner's Manual of the connected device(s).

Before Using Hands-Free Function

Before using the hands-free phone/audio function, the following settings need to be made.

- 1 Set "BLUETOOTH IN" to Adapter (page 55).
- 2 Turn the ignition key off (ACC OFF) and on again (ACC ON).

- Before using a hands-free phone, it must be paired with this unit. Refer to "BLUETOOTH Setup" (pages 64-66).

How to connect to a BLUETOOTH compatible device (Pairing)

For details on the control from a BLUETOOTH compatible device, refer to the Owner's Manual of the BLUETOOTH compatible device.

- 1 Set a BLUETOOTH connection from a BLUETOOTH compatible device.
- 2 The PIN code ("0000") is displayed on the unit.
- 3 Input the PIN code ("0000") in a BLUETOOTH compatible device.
- 4 If this unit is successfully connected to a BLUETOOTH compatible device, "Connected" is displayed, and then the unit returns to normal mode.
 - Set "Setting the Search Mode" (page 65) to Visible Mode ON to enable this unit to recognize a mobile phone. For mobile phone passkey (passcode) input operation, refer to the mobile's Owner's Manual. Additionally, the mobile phone can be searched directly from this unit. Refer to "Registering the BLUETOOTH Device" (page 65).
 - If a BLUETOOTH compatible device is successfully connected, the next time when the ignition key of the car is turned to on, the unit will automatically connect to the previously connected device. However, the connection may fail. If the auto connection fails, try the connection manually.

BLUETOOTH Setup

BLUETOOTH Setup Operation

The following steps 1 to 6 are common to the various BLUETOOTH functions. For details, refer to each individual function.

- While calling, or in the BLUETOOTH Audio source, BLUETOOTH Setup operation cannot be performed.
- Set "BLUETOOTH IN" to Adapter (page 55), and then perform BLUETOOTH Setup operation.

- 1 Press **SOURCE/⏻** on the unit.
The SOURCE selection screen is displayed.
- 2 Touch [**📶**] on the main source screen.
The SETUP main screen is displayed.
- 3 Touch [**>>**] of Source Setup.
The Source Setup screen appears.
- 4 Touch [**>>**] of BLUETOOTH Setup.
The BLUETOOTH Setup screen appears.
- 5 Touch [**◀**], [**▶**] or [**>>**] of the desired item to change its setting.

Setting items:

Paired Devices / Device Search / Clear Device / Service Provider / Visible Mode / Auto Answer / Speaker Select / MIC Input / Firmware Version / Firmware Update

- 6 Touch [**⏪**] on the left side of screen to return to the previous screen.

Touch [Exit] to return to the main source screen that was displayed before the setup operation was started.

Setting the BLUETOOTH Device

Select one of 5 connected BLUETOOTH compatible devices that you previously registered.

Setting item: Paired Devices

Touch a BLUETOOTH compatible device to use (change connection) from the Paired Device list.

- If the connection is successfully changed, "Connected/(Device name)" is displayed for 2 seconds, and then the display returns to the Setup screen.
- If you input the wrong passcode or communications fail, "Failed" is displayed.
- If you want to connect another BLUETOOTH compatible device, after disconnecting the current BLUETOOTH compatible device, connect the BLUETOOTH compatible device you want to change to.
- The registration number 5 is deleted when you set ignition from ACC to OFF. If all the 5 positions have been registered, you cannot register the 6th device. To register another device, you need to delete one of the devices from position 1 to 5 first.

Registering the BLUETOOTH Device

The BLUETOOTH device is used when a connectable BLUETOOTH compatible device is searched and connected from this unit, or a new BLUETOOTH compatible device is registered.

Setting item: Device Search

- 1 When Device Search is selected, "Now Searching" is displayed, and searching starts.**
- 2 Touch the device name to be connected from the Device Search list.**
- 3 If the adapter is successfully connected to a BLUETOOTH compatible device, a paired device name and a registered number (No. 1 to 5) are displayed, and then the unit returns to normal mode.**

- If a mobile phone is registered for the first time: Input a passcode when the numeric keypad screen is displayed, then input the same passcode in the BLUETOOTH compatible device to make the pairing. After the pairing is completed, the unit will automatically connect to the BLUETOOTH compatible device.
- If you input the wrong passcode or communications fail, "Failed" is displayed.
- A passcode input on the unit is maximum 4-digit. If a passcode on the BLUETOOTH compatible device exceeds 4 digits, reset the passcode and make this setting again.

Deleting a BLUETOOTH Device from the list

You can delete the history of a previously connected BLUETOOTH compatible device.

Setting item: Clear Device

- 1 Touch the BLUETOOTH compatible device you want to delete from the Clear Device list.**
A message is displayed.
 - 2 Touch [Yes] if you want to delete.**
- Touching [No] will cancel the setting.
 - The registration number 5 is deleted once the ignition key goes from ACC to off.

Displaying the phone service provider name

Setting item : Service Provider

The service provider name of the connected BLUETOOTH compatible device will be displayed. If a BLUETOOTH compatible device is not connected, "ID UNSENT" will be displayed.

- Depending on the character type some phone service provider name cannot be displayed.

Setting the Search Mode

You can set whether KCE-400BT can be recognized or not from a BLUETOOTH compatible device. Normally set this to Visible Mode ON.

Setting item: Visible Mode

- ON: Enables recognition of KCE-400BT from the BLUETOOTH compatible device.
- OFF: Disables recognition of KCE-400BT from the BLUETOOTH compatible device.

- Depending on the mobile phone, it may be necessary to input a passcode. For inputting the mobile phone's passcode, refer to the mobile phone's Owner's Manual.

Setting the Received Calls automatically (Auto Answer)

When a call is received, you can set whether to receive it automatically or not.

Setting item: Auto Answer

- ON: When a call is received, it will be taken automatically after about 5 seconds.
- OFF: When a call is received, it will not be received automatically. If a message is displayed and [📞] is touched when a call is received, you can receive the call.

- If the received call setting on the mobile phone is on, the call will be answered automatically even though this setting is set to OFF.

Selecting the output speaker

You can select the connected speaker in car to output the sound signal of telephone.

Setting item : Speaker Select

- All: The sound be output from all of speakers in car.
- F-L: The sound only be output from the front left speaker.
- F-R: The sound only be output from the front right speaker.
- F-LR: The sound be output from the front left and front right speaker.

- The setting cannot be adjusted during a phone call. Adjust the setting before placing a call.
- When an IMPRINT audio processor (PXA-H100) is connected, the default setting All will be set and cannot be adjusted.

Adjusting the volume for the microphone input

You can emphasize or weaken the microphone input volume level.

Setting item : MIC Input

Turn the Rotary encoder to select the desired volume level (0 ~15).

- *The setting cannot be adjusted during a phone call. Adjust the setting before placing a call.*
- *The setting can be adjusted only when the BLUETOOTH compatible device is connected.*

Displaying the firmware version

Setting item : Firmware Version

The current firmware version of KCE-400BT will be displayed.

Updating the firmware

Setting item : Firmware Update

Future BLUETOOTH firmware update of KCE-400BT (for phone compatibility) at customer end will be available for this unit.

For information to update your BLUETOOTH firmware, please visit Alpine America home page (<http://www.alpine-usa.com>).

Hands-Free Phone Control

About the Hands-Free Phone

Hands-free calls are possible when using a HSP (Head Set Profile) and HFP (Hands-Free Profile) compatible mobile phone with this unit.

- *Avoid performing a hands-free call in heavy traffic or on narrow or winding streets.*
- *Close the windows while calling to reduce background noise.*
- *If both calling parties are using hands-free devices, or the call is made in a noisy location, difficulty hearing the other person's voice is normal.*
- *Depending on telephone line conditions or certain mobile devices used, voices may sound unnatural.*
- *When using a microphone, speak as directly as you can into the microphone to pick up the best sound quality.*
- *Certain mobile phone features are dependent on the capabilities and settings of your service provider's network. Additionally, certain features may not be activated by your service provider, and/or the provider's network settings may limit the feature's functionality. Always contact your service provider about feature availability and functionality.*

All features, functionality, and other product specifications, as well as the information contained in the Owner's Manual are based upon the latest available information and are believed to be accurate at the time of printing.

Alpine reserves the right to change or modify any information or specifications without notice or obligation.

Answering a Call

Incoming calls are announced by the received call ring tone and a displayed message (Caller name/PHONE No.).

Touch [].

The call starts.

- **Indicator  (Signal Strength):**
While calling, the indicator will display the current signal strength of mobile phone. While in the mode other than Calling, the unit cannot read the signal strength of the mobile phone exactly. In this case, the indicator displays the signal strength of last call.
- *When "Setting the Received Calls automatically (Auto Answer)" (page 65) is set to ON, you can receive a call automatically.*
- *While calling, the source sound on the unit is muted. After calling, playback will resume.*

Hanging up the Telephone

Touch [].

The call finishes.

Adjusting the volume when receiving a Call

While calling, you can adjust the volume. The adjusted volume level is stored.

Press / on the unit to adjust the volume.

- *You may need to increase volume from your regular audio listening source level. However, increasing the volume excessively may result in feedback. If feedback is noticed as feedback is directly related to the volume, turn down the volume as low as acceptable to eliminate it. Positioning the microphone in a direction away from the main car speakers (e.g. clipped on sun visor) may also reduce feedback at high volume.*

Redial Function

You can redial the person you have previously called.

After finishing a call, touch [] on the screen within 5 seconds.

The telephone is redialed.

Call Switching Operation

While making a call, this function allows you to initiate the transfer of the audio between the mobile phone and the speakers in the car.

While calling, touch [🔊↔📞] to switch the call sound between the unit and mobile phone.

- Depending on the mobile phone, this operation may not be performed.

Call History

Call History is recorded for the last dialed/received/missed calls. There are various ways of making calls based on the “Call History”. The following steps 1 to 3 are common to the various ways of making these calls. For details, refer to each individual category for making calls.

1 Press and hold MUTE/PHONE for at least 2 seconds.

The Telephone Menu screen is displayed.

2 Touch [➤] of the desired item to place the call.

Setting items:

Dialed Calls / Received Calls / Missed Calls / Phone Book / Dial Input / Voice Dial

- The adapter will update the information in the Call History automatically each time a mobile phone is connected or receiving/dialing a call. At this time, if you select any outgoing mode, “Now Updating” will be displayed.
- It may take some time for the list to be displayed, and also directly after connection, the list may not be brought up to date.

3 Touch [⏪] to return to the previous screen.

Touch [Exit] to return to the main source screen that was displayed before the setup operation was started.

- If you place a call directly from the paired mobile phone, the phone number is not displayed, you cannot redial from the unit in this case.

Redialing a Number in Dialed Calls History

Previously dialed telephone numbers are stored in dialed calls history. You can redial a number by searching from dialed calls history.

Setting item: Dialed Calls

Touch [Call] of the person name or the telephone number you want to call from the Dialed Calls list.

The call is placed.

Dialing a Number in Received Calls History

Telephone numbers from received calls are stored in the received calls history. You can redial these numbers by searching here.

Setting item: Received Calls

Touch [Call] of the person name or the telephone number you want to call from the Received Calls list.

The call is placed.

Dialing a Number in Missed Calls History

Telephone numbers for received calls that are missed, are stored in the missed calls history. You can redial these numbers by searching here.

Setting item: Missed Calls

Touch [Call] of the person name or the telephone number you want to call from the Missed Calls list.

The call is placed.

Dialing a Number In the Phone Book (Phone Book)

Up to 1,000 telephone numbers are downloadable to the BLUETOOTH compatible unit from a mobile phone. Dial a call by selecting a person from the phone book list.

Setting item: Phone Book

Display example for Phone book screen

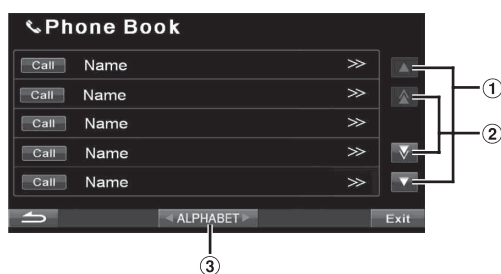

- ① Scroll the list one line at a time by touching [▲] or [▼].
- ② Scroll the list one page at a time by touching [▲] or [▼].
- ③ The names in Phone Book are listed alphabetically. The listing can be skipped to the next alphabetical character. e.g. touch ALPHABET [▶] to move to the names beginning with B from those beginning with A. (Only applicable to English alphabetic characters.)

Touch [Call] of the person name or the telephone number you want to call from the Phone Book list.

The call is placed.

- If one name has several numbers registered in the telephone book, choose and touch [Call] of the desired number after touching [>>>] of the name, the telephone will be called. Touch [Call] of the name directly, the default number of the name will be called. Depending on the connected mobile phone, this function may not be performed.
- If a name cannot be obtained via the phone book, only the telephone number (default number) is displayed. If both name and number cannot be obtained, "ID UNSENT" will be displayed.
- If the call history or phonebook of the mobile phone is added or deleted while it is connected to the unit, the list displayed on the unit may not be brought up to date. If it is not updated, you cannot correctly place a call.

Voice Dial Operation

You can call the telephone by performing voice operation.

Setting item: Voice Dial

- 1 Touch [▼] to display the item of Voice Dial.
 - 2 Touch [>>>] of Voice Dial.
A message is displayed.
 - 3 Touch [Yes] to activate the voice dial mode.
The voice dial mode is activated, and "Speak" is displayed.
- Touch [No] will return to the Telephone Menu screen.
- 4 Say the telephone number*, name* you want to call into the microphone.

* The number and name depend on the voice dial information stored in the mobile phone.

- If the voice dial fails, the unit will return to normal mode in 30 seconds.
- You can perform this operation only when a voice dial compatible mobile phone is connected. If the mobile phone is not compatible with the voice dial, "Failed" is displayed for 2 seconds.
- The Voice Dial function performance depends on the recognition range of the mobile phone and mounting location of the microphone. Note when the microphone is mounted.
- This operation cannot be performed when the current source is BLUETOOTH Audio.
- Voice dial operation depends on the function of the mobile phone. For details, refer to the Owner's Manual of the mobile phone.

Dialing a Number Using Direct Dial Input

You can place a call by inputting the telephone number directly by the numeric keypad screen on the unit.

Setting item: Dial Input

Display example for the Dial Input screen

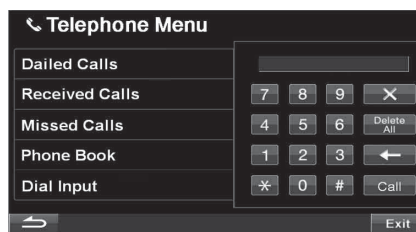

The numeric keypad screen is displayed. Touch (input) the telephone number, and then touch [Call].

The call is placed.

- About the numeric keypad
 - ✕ : closes the numeric keypad input screen.
 - Delete All: deletes all input numbers.
 - ← : deletes a previous number.
- The speed dial is recalled and the telephone is called by directly inputting the number which is registered with the speed dial on the mobile phone on the numeric keypad screen of this unit (SPEED DIAL).

BLUETOOTH Audio Function

BLUETOOTH Audio Operation

Audio information of a BLUETOOTH compatible mobile phone, a portable player, etc., is controllable/playable wirelessly* from this unit.

- * To play back audio, a mobile phone or a portable player conforming to A2DP (Advanced Audio Distribution Profile) or AVRCP (Audio/Video Remote Control Profile) is required. Not all functions work with all devices.
- During a call, sound on the BLUETOOTH audio source is muted.

Recalling the BLUETOOTH audio source

- 1 Press SOURCE/⏻ on the unit.
The SOURCE selection screen is displayed.
- 2 Touch [▶] until the source icon of BT Audio is displayed.
- 3 Touch the [BT Audio] icon.
The BT Audio source is activated and the display changes to the BT Audio main screen.

Selecting the desired Song

Touch [⏮].

Returns the beginning of the song being played back.

Touch [▶▶].

Forwards the next song.

Pausing

Touch [⏸/||].

A playback stops. Touching again will resume a playback.

Auxiliary Device (Optional)

- If the AUX mode is not displayed on the main menu, set AUX IN to ON by following “Setting the AUX Mode” (page 55).
- If the AUX+ source is not displayed on the main menu, set AUX+ IN to ON by following “Setting the AUX+ Mode” (page 55).
- The display mode changes by touching [WIDE] for AUX mode. For operation, refer to “Switching Display Modes” on page 46.

Operating Auxiliary Devices (Optional)

To operate your devices connected to the AUX terminals on the rear panel of INA-W900 (AUX mode) or to the BLUETOOTH Interface connector by using an optional Conversion cable (KCE-237B) (AUX+ mode), follow the procedure described below.

WARNING

It is dangerous (and illegal in many states) for the driver to watch the Video while driving the vehicle. The driver may be distracted from looking ahead and an accident could occur.

Install the INA-W900 correctly so that the driver cannot watch Video unless the vehicle is stopped and the emergency brake is applied.

If the INA-W900 is not installed correctly, the driver will be able to watch the Video while driving the vehicle and may be distracted from looking ahead and cause an accident. The driver or other people could be severely injured.

To activate your auxiliary devices:

To watch a video source, your vehicle must be parked with the ignition key in the ACC or ON position. To do this, follow the procedure below.

- 1 Bring your vehicle to a complete stop at a safe location. Engage the parking brake.
- 2 Keep pushing the foot brake and release the parking brake once then engage it again.
- 3 When the parking brake is engaged for the second time, release the foot brake.

- For automatic transmission vehicles, place the transmission lever in the Park position.

Now, the locking system for the AUX mode operation has been released. Engaging the parking brake can reactivate the AUX mode, as long as the car's ignition has not been turned off. It is not necessary to repeat the above procedure (1 through 3), of “To activate your auxiliary devices.”

Each time the ignition is turned OFF, perform the procedure of “To activate your auxiliary devices.”

- If you try to activate the auxiliary device while driving, the display will show the warning-**PICTURE OFF FOR YOUR SAFETY.**

1 Press SOURCE/⏻ on the unit.

The SOURCE selection screen is displayed.

2 Touch [AUX]^{*1} or [AUX+].

The external input screen is displayed.

3 Touch [NTSC/PAL]^{*2} to change the video input type.

^{*1} The name that is given as the source name in “Setting the AUX Mode” on page 55 is displayed.

^{*2} Cannot be performed in AUX+ mode.

Rearview Camera Operation (Optional)

When the optional rearview camera HCE-C107D, etc. is connected, rear view video can be output to the monitor.

- A rearview camera with RCA Output connector cannot be connected to this unit.
- Be sure to set "Camera IN" to ON before using the rearview camera, refer to "Setting the Rear Camera Input" on page 54.



Switching the Rear Camera Screen (Optional)

The rear view video will be displayed for the two situations as below.

Displaying the rear view video while the car is in reverse

- 1 Shift the gear lever to the reverse (R) position.**
The rear view image is displayed while the car remains in reverse.
 - 2 If you shift the gear lever to a position other than reverse (R), the monitor returns to the previous screen.**
- Be sure to also check behind the car visually. Use the camera image to assist in showing conditions behind the car.
 - This function is effective when the reverse wire is properly connected.

Displaying the rear view video manually

- 1 Press SOURCE/⏻ on the unit.**
The SOURCE selection screen is displayed.
- 2 Touch  (CAMERA).**
The Camera mode is activated and the rear view video is displayed.
- 3 Touch [Guide On] or [Guide Off] to set whether the rear camera guide line is displayed.**
Touch  to return to the previous screen.

Changer (Optional)

Controlling CD Changer (Optional)

An optional 6-disc or 12-disc CD Changer may be connected to the INA-W900 if it is Ai-NET compatible. With a CD Changer connected to the Ai-NET input of the INA-W900, the CD Changer will be controllable from the INA-W900.

If you connect a changer compatible with MP3, you can play CD-ROMs, CD-Rs, and CD-RWs containing MP3 files on the INA-W900.

Using the KCA-410C (Versatile Link Terminal) multiple changers can be controlled by the INA-W900.

See the Multi-Changer Selection section for selecting the CD Changers (explained on page 71).

- 1 Press SOURCE/⏻ on the unit.**
The SOURCE selection screen is displayed.

- 2 Touch [CD CHG.].**
The display changes to the CD changer mode screen.

When a 6 Disc CD Changer is connected;

- 1 Touch [P1/2]*.
The Function Guide display appears.

* When an MP3 compatible CD changer or DVD changer is connected, touch repeatedly until the disc number is displayed.

- 2 Touch any one of the select buttons [DISC 1] through [DISC 6].
DISC 1 through DISC 6 select the discs from the first disc to 6th disc.

When an MP3 compatible CD changer is connected;

- 1 Touch [P1/3] twice to change the Function Guide display.
- 2 Touch any one of the select buttons [DISC 1] through [DISC 6].
DISC 1 through DISC 6 select the discs from the first disc to 6th disc.

When a 12-Disc CD Changer is connected;

- You can select the disc numbers 1 to 6 in the same manner as for 6-disc Changer.
- Touch [P1/3] twice to select disc numbers 7 to 12.
The function guide display changes so that DISC 7 through DISC 12 represent disc numbers 7 to 12.

- After selecting the desired disc, you can operate in the same way as for the CD player. For details, see the CD/MP3/WMA/AAC section.
- When an MP3 compatible CD changer is connected, the unit can play discs containing both audio data and MP3 data.
- The DVD changer (optional) is controllable from the INA-W900 as well as the CD changer.

Multi-Changer Selection (Optional)

When using KCA-410C (Versatile Link Terminal), you can connect two changers.

- 1 In changer mode, touch [CHG SEL] or press BAND on the remote control (sold separately) to select the next changer (connected CD changers or KCA-420i).**
 - 2 To operate the selected changer, see "CD/MP3/WMA/AAC" section.**
- To operate the selected changer, see "CD/MP3/WMA/AAC" (pages 36-39).

SAT Radio Receiver (Optional)

SAT Receiver: XM or Sirius Receiver

When an optional XM or Sirius Receiver Box is connected via the Ai-NET bus, the following operations may be performed. However, the XM Receiver and Sirius Receiver cannot be connected at the same time.

Receiving Channels with the SAT Receiver (Optional)

About SAT Radio

Satellite Radio* is the next generation of audio entertainment, with over to 100 digital channels. For a small monthly fee, subscribers can hear crystal-clear music, sports, news and talk, coast-to-coast via satellite. For more information, visit XM's website at www.xmradio.com, and Sirius' website at www.Sirius.com.

To receive SAT Radio, the separately sold XM Direct™ or Sirius Satellite Radio Tuner and an appropriate Ai-NET Interface Adapter will be required. For details, consult you nearest ALPINE dealer.

* XM and its corresponding logos are trademarks of XM Satellite Radio Inc.

* Sirius and its corresponding logos are trademarks of Sirius Satellite Radio Inc.

• The SAT Receiver controls on the INA-W900 are operative only when a SAT Receiver is connected.

- 1 Press SOURCE/⏻ on the unit.**
The SOURCE selection screen is displayed.
- 2 Touch the [XM] or [Sirius] icon.**
The XM or Sirius main screen display appears.
- 3 Touch [P1/3] twice for XM mode or [P1/3] once for Sirius mode.**
The function guide is displayed.
- 4 Touch [BAND] to select the desired band.**

XM radio:

XM-1 → XM-2 → XM-3 → XM-1

Sirius radio:

Sirius-1 → Sirius-2 → Sirius-3 → Sirius-1

- 5 Touch [NO.] or [NAME] to select the channel number tuning.**
Each time it is pressed, the tuning mode is changed.
channel number tuning ↔ channel name tuning
- 6 Touch [◀ NO.] / [NO. ▶] or [◀ NAME] / [NAME ▶] to select the desired channel. Touching and holding either button will change channels continuously.**

• To customers when connecting the Sirius Tuner Box:
For detailed functions, refer to the Sirius Tuner Box installation manual.

Tuning in to Categorized Programs

Quickly find a group of channels in a desired category. The categories are listed in the order designated by Sirius or XM Radio.

- 1 Touch **CATEGORY** [▼] or [▲] to select a desired category in the XM or Sirius mode.
- 2 Touch and hold **CATEGORY** [▼] or [▲] for at least 2 seconds to activate the category mode.
The "Category" indicator lights up.
- 3 Touch [◀ **NO.**] / [**NO.** ▶] to select a desired channel.
The first channel of the selected category is tuned.
 - The channels can only be changed within the current category.
- 4 Touch and hold **CATEGORY** [▼] or [▲] for at least 2 seconds to turn off the category mode, or if no operation is performed for 13 seconds, the category mode will be automatically canceled.

Changing the Display

Text information, such as the channel name, artist name/feature, and song/program title, is available with each XM or Sirius channel. The unit can display this text information as explained below.

Touch [INFO.] in the XM or Sirius mode.

Each time you touch this button, the display changes as shown below.

In XM mode:

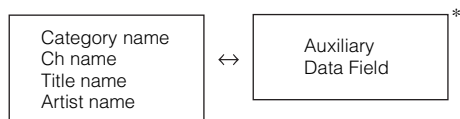

* If all of Auxiliary Data Field Characters cannot be displayed, touch [INFO.] to display the other characters.

In Sirius mode:

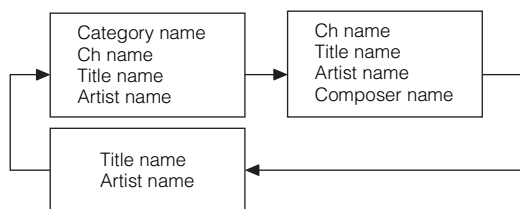

Checking the SAT Radio ID Number

A unique Radio ID number is required to subscribe to SAT Radio programming. Each third party XM or Sirius radio comes with this number.

XM Radio:

This number is an 8 character alphanumeric number. It is printed on a label found on the SAT Receiver.

Sirius Radio:

This number is a 12 digits number. It is printed on a label found on the SAT Receiver.

It can also be displayed on the screen of the INA-W900 in the following way.

- 1 While receiving SAT Radio, touch **NO.** [◀] or [▶] to select channel "0" for XM and channel "0" or "255" for Sirius.
The unit displays the ID number.
- 2 To cancel the ID number display, change the channel.
 - You can check the ID number printed on a label on your third party, SAT Radio Receiver package.

Storing Channel Presets

- 1 Touch [P1/3] after selecting a desired band.
The Function Guide is switched.
- 2 Touch and hold any one of the preset buttons [P.SET 1] through [P.SET 6] for at least 2 seconds.
The selected channel is stored.
- 3 Repeat the procedure to store up to 5 other channels onto the same band.
To use this procedure for other bands, simply select the desired band and repeat the procedure.
A total of 18 channels can be stored in the preset memory (6 channels for each band; XM1, XM2 and XM3 or Sirius-1, Sirius-2 and Sirius-3).
 - If you store a channel in a preset already being used, the current channel will be replaced with the new one.

Receiving Stored Channels

- 1 Touch [P1/3] after selecting a desired band.
The Function Guide is switched.
- 2 Touch any one of the preset buttons [P.SET 1] through [P.SET 6] that has your desired satellite channel in memory.

Search Function (XM mode)

1 In XM mode, touch [Q].
SEARCH menu list is displayed.

2 Select the desired Search menu.

Setting items:

Category / Channel

Searching by Category

- 1 Touch [>>>] of Category.
The Category search screen is displayed.
- 2 Touch [>>>] to change to channel name search screen of the selected category.
- 3 Touch [▶] to receive the selected channel name.

• You can change the category directly by touching **CATEGORY [▼]** or **[▲]** on the channel name search screen.

Searching by Channel Name

- 1 Touch [>>>] of Channel.
The channel name search screen is displayed.
- 2 Touch [▶] to receive the selected channel name.

Search Function (Sirius mode)

1 Touch [Q] in the Sirius mode.
SEARCH menu list is displayed.

2 Select the desired Search menu.

Setting items:

Category / Channel / S-Seek List*¹ / Game Zone*²

Searching by Category

- 1 Touch [>>>] of Category.
The Category search screen is displayed.
- 2 Touch [>>>] to change to channel name search screen of the selected category.
- 3 Touch [▶] to receive the selected channel name.

• You can change the category directly by touching **CATEGORY [▼]** or **[▲]** on the channel name search screen.

Searching by Channel Name

- 1 Touch [>>>] of Channel.
The channel name search screen is displayed.
- 2 Touch [▶] to receive the selected channel name.

• Touch **[INFO.]** on the channel name search screen, the information (artist names, song names) of the broadcasting channels will be displayed. You can choose the desired channel from the artist name list or song name list.

Each time you touch this button, the display changes as below.

Channel name → Artist name → Song name →
Channel name

Searching by S-Seek List

- 1 Touch [>>>] of S-Seek List*¹.
The artist names and song names that you have stored and are currently playing will be displayed in a list.
- 2 Touch [▶] of the desired artist/song.
The channel of the selected artist/song being broadcast is received.

• Touch **[INFO.]** on the S-Seek List screen, the information can be changed between artist name and song name.

Searching by Game Zone

- 1 Touch [>>>] of Game Zone*².
The sport teams that you have stored and the game is currently broadcasting will be displayed in a list.
- 2 Touch [▶] of the desired team.
The channel of the selected game being broadcast is received.

• Touch **[INFO.]** on the Game Zone screen, the information can be changed between team names and instant score.

*¹ Displayed only when the stored song or artist is broadcasting.

*² Displayed only when the game of stored team is broadcasting.

Selecting the Channel directly

You can directly select the channel number on the display of the numeric keypad.

1 Touch [P1/3] twice in the XM or Sirius mode.
The function guide appears.

2 Touch [10KEY].
The numeric keypad input screen is displayed.

3 Touch to input the channel number.

4 Touch [Enter].
The selected channel is received.

• When 3 digits are input in the Sirius mode, step 4 is not necessary.

Receiving Weather or Traffic information from SAT Radio

1 Touch and hold [NO.] or [NAME] for at least 2 seconds in the XM or Sirius mode.
The received weather or traffic channel is stored.

2 Press and hold AUDIO button on the unit.
The stored Weather or Traffic channel is recalled.

3 Touch [↶].
Returns to the normal mode.

• Stored channels can also be recalled by pressing and holding **AUDIO**, even in modes other than XM or Sirius mode.
• Channels other than Weather or Traffic information can also be stored and recalled.

Storing the desired Song/Artist (Sirius mode only)

This feature allows you to store information in the Receiver's memory about the currently tuned programming- artist or song. When stored, a message is displayed to announce when stored songs are being broadcast on another radio station, should you wish to listen to it. (Refer to "Activating the stored Alert (Sirius mode only)" on page 74.)

1 Touch [P1/3] twice to store an artist or song currently being received.

The function guide is changed.

2 Touch [MEMORY].

The Memory type selection screen is displayed.

3 Touch [>>] of Store Song or Store Artist to select the store type.

A "Song Stored X Used/Y Empty" pop up screen is displayed.

X is the total number of listings stored in memory, and Y is the total number of memory listings still available for storage.

- "Unable to Store" appears in the display if there is no song title and artist name information.
- If there is no memory space, "Memory Full" is displayed for 3 seconds, and then the display changes to the Memory Recall list. Touch [>>] of the song or artist you want to rewrite, message is displayed. If "Yes" is touched, the song or artist is rewritten and stored. If "No" is touched, it is canceled.
- If [MEMORY] is touched and held for at least 2 seconds, the display changes to the Memory Recall list screen. You can manage the stored songs and artist individually. Refer to "Setting the announcement individually for a Song/Artist/Sport Team" on page 57.

Storing desired Sports Teams (Sirius mode only)

Store a desired sports team from one of the available leagues Sirius covers. When stored, their game status and results are announced when other stations are being listened to, and if you wish, you can go to the station where the game is being broadcast. (Refer to "Activating the stored Alert (Sirius mode only)" on page 74.)

1 Touch [P1/3] twice to store a game currently being broadcast.

The function guide is changed.

2 Touch [MEMORY].

The display changes to the team selection screen. Both the team and opponent team names are displayed.

3 Touch [>>] of the team you want to store.

The announcement type selection screen is displayed.

4 Touch [>>] of the desired announcement type.

Initial Game Alert: Announce when a game starts.

All Score Updates: At the beginning of the game, the announcement interrupts; announces every time the score changes.

A "Game Stored X Used/Y Empty" pop-up screen is displayed.

X is the total number of listings stored in memory, and Y is the total number of memory listings still available for storage.

- "Unable to Store" will be displayed if the above information of teams cannot be stored.
- Touching and holding [MEMORY] for at least 2 seconds will change to the Memory Recall list screen. You can manage the stored teams individually. Refer to "Setting the announcement individually for a Song/Artist/Sport Team" on page 57.

Activating the stored Alert (Sirius mode only)

When stored sports team, song or artist is being broadcast, a message appears and it is announced. The broadcasting channel can be received.

1 When stored information is broadcast, after displaying "Song Alert", "Artist Alert" or "Game Alert", the screen changes to the S-Seek list*¹ or Game Zone list*² display.

2 Touch [▶] of the channel on the list you want to receive.

The display changes to the selected channel and the channel is received.

- If [↶] is touched, return to the previous screen.
- If no operation is performed for 10 seconds, or [Exit] is touched, the screen returns to the normal mode screen.

*¹ Only for Song Alert and Artist Alert.

*² Only for Game Alert.

Offset Playback Function (Sirius mode only)

If the Sirius radio is interrupted by another source (e.g., telephone call, etc.), the current channel is saved using the memory playback function. At the end of the interruption, use this function to listen to the part of the broadcast that was missed.

1 Touch [P1/3] twice.

The function guide changes.

2 Touch [▶/||] while receiving the broadcasting program you want to store.

The "Pause" indicator lights up.

3 Touch [▶/||] again during PAUSE.

The "Play" indicator lights up and offset playback commences.

- The time difference between the real broadcasting time and the offset playback time is displayed.

4 If [■] is touched, offset playback stops and the display returns to the main screen.

- To fast reverse, touch and hold [◀◀]. and to fast forward, touch and hold [▶▶].
- Touching [◀◀] or [▶▶] will move a track up/down.

USB Memory (Optional)

A USB memory or Portable audio player can be connected to the INA-W900 through the USB Connector of this unit.

If a USB memory device or Portable audio player is connected to the unit, MP3/WMA/AAC files of USB memory and MP3/WMA files of Portable audio player can be played back.

BANK Function (USB memory only)

What is a Bank?

A bank is a unit of up to 1,000 songs, which is stored in memory. "Banking" refers to the action of building up a bank (of songs) from the songs available in USB memory.

About Banking

While a bank is being built up, "BANKING" is displayed. If another bank is selected when unit power is turned on, the ACC position is set, or USB connection is made, banking will start. It can take anywhere from a few seconds to up to 10 minutes for banking to complete. This depends on the number of files and folders in USB memory.

Available operations while Banking

- Search functions, such as album search or tag information (artist display, etc.) are available during the banking process. However, during such time, tag information display changes.
- Regular fast-forwarding and next song selection is available.
- During Banking, the played back song order may differ from the song order in USB memory.

This unit has the BANK function that automatically divides every 1,000 songs stored in USB memory into individual banks to make searching and playing back a song easier. A maximum of 1,000 songs for one bank can be stored according to the order stored in USB memory. A maximum of 10 banks (10,000 songs) can be recognized. BANK1 (songs 1 to 1,000) is set as the default. If you want to search beyond 1,000 songs, perform the following operation to select a different bank.

BANK No.	Song number
BANK1	1~1,000
BANK2	1,001~2,000
⋮	⋮
BANK10	9,001~10,000

1 Touch [P1/2] to change the function guide.

2 Touch BANK [▼] or [▲] to select the desired BANK.

Each operation can be performed in the selected bank.

- *Even if the files are contained in the same folder, they may be saved as different BANK.*

Playback

1 Press SOURCE/⏻ on the unit.
The SOURCE selection screen is displayed.

2 Touch [USB Audio].
The USB mode is activated and the display changes to the USB screen.

3 Touch [◀◀] or [▶▶] to select the desired track (file).

Returning to the beginning of the current track (file):
Touch [◀◀].

Fast backward (Only for USB memory):
Touch and hold [◀◀].

Advancing to the beginning of the next track (file):
Touch [▶▶].

Fast forward (Only for USB memory):
Touch and hold [▶▶].

4 To pause playback, touch [▶/||].
Touching [▶/||] again will resume playback.

- *WMA format files that are protected by DRM (Digital Rights Management), AAC format files that have been purchased from iTunes Music Store and files that are copy-protected (copyright protection) cannot be played back on this unit.*
- *The playback time may not be correctly displayed when a VBR (Variable Bit Rate) recorded file is played back.*
- *If there is tag information, artist name/album name/track name is displayed.*
- *ID3 tag/WMA tag*
If an MP3/WMA/AAC file contains ID3 tag/WMA tag information, the ID3 tag/WMA tag information is displayed (e.g., song name, artist name, and album name). All other tag data is ignored.
- *"NO SUPPORT" is scroll displayed when text information is not compatible with this unit.*
- *Before disconnecting USB memory, be sure to change to another source or set to pause.*

Repeat Play

Only Repeat One is available for this mode.

Repeat One: A single song is repeatedly played back.

1 Touch [P1/2].
The function guide is displayed.

2 Touch [↻].
The file will be played repeatedly.

↻	↔	(off)
(Repeat One)		(Repeat the list being played back)

3 To cancel repeat play, touch [↻].

Random Play Shuffle (M.I.X.)

The Shuffle function of the USB memory or Portable audio player is displayed as M.I.X. on the INA-W900.

Shuffle ALL:

All songs in the USB memory or Portable audio player are played back in random sequence. Any one song does not play back again until all songs have been played back.

Shuffle Songs:

Song shuffle randomly plays back songs within a selected category (playlist, album, etc.). The songs within the category are played just once until all songs have been played.

1 Touch [⌂] after touching [P1/2].

The songs will be played back in random sequence.

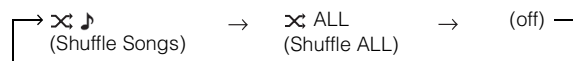

2 To cancel M.I.X. play, touch [⌂].

- When a song is played back during Random (M.I.X.) play, the song can be played back again randomly even if not all songs on the USB Memory have been played back.

Searching for a desired Song

A USB memory or Portable audio player can contain hundreds of songs. By using file tag information and keeping these songs organized in playlists, this unit's search functions will ease song searches. Each music category has its own individual hierarchy. Use the Playlists/Artists/Albums/Songs/Genres/Composers/Folders/Files search mode to narrow searches based on the table below.

Hierarchy 1	Hierarchy 2	Hierarchy 3	Hierarchy 4
Playlists	Songs	—	—
Artists*	Albums*	Songs	—
Albums*	Songs	—	—
Songs	—	—	—
Genres*	Artists*	Albums*	Songs
Composers*	Albums*	Songs	—
Folders	Files	—	—
Files	—	—	—

For example: Searching by Artist name

The following example explains how an ARTISTS search is performed. Another search mode can be used for the same operation, although the hierarchy differs.

Searching by artist name

1 Touch [Q].

The search mode is activated, and the search list screen appears.

- Touching [Q] for at least 2 seconds will return to last search mode.

2 Touch [➤] of Artists.

The Artists search screen is displayed.

3 Select the desired artist.

To play back the artist directly

- Touch [▶] next to the artist's name. All songs of the selected artist are played back.

To search for the album of an artist

- Touch [➤] of the selected artist. The Albums search screen of the selected artist is displayed.
- Touch [▶] next to the desired album's name. All songs of the selected album are played back.

To search for a song in the album of an artist

- Touch [➤] of the desired album in "To search for the album of an artist" in step 2. The Songs search screen of the selected album is displayed.
- Touch [▶] next to the desired song's name. The selected song is played back.

- Titles are listed alphabetically, and can be skipped every 200 titles with the same beginning alphabetical character. If there are fewer than 200 titles, titles beginning with the next alphabetical character are selected. e.g. touch ALPHABET [▶] switch to the section beginning with alphabet B from A. (Only applicable to English alphabetic characters.)
- Touching [▶] of ALL will play back all songs in the list when you are in a hierarchy with an asterisk "*" (see table on left).
- Touching [➤] of ALL will display the search list in the next hierarchy.
- When search is made during M.I.X. play, the M.I.X. play mode will be canceled.
- In the search mode, you can scroll the list one page at a time by touching [▲] or [▼].

Selecting Playlist/Artist/Album/Genre/Composer

Playlist/Artist/Album/Genre/Composer can be easily changed.

For example, if you listen to a song from a selected album, the album can be changed.

Touch [▼] or [▲] to select the desired (Playlist) / (Artist) / (Album) / (Genre) / (Composer).

- If search selection mode is not activated, a Song search is not possible.
- If an album is selected from an artist search, the album can be searched.
- During shuffle (M.I.X.) playback, this operation is not possible.

Select the desired Folder (Folder up/down)

If you listen to a file from a selected folder, the folder can be changed.

Touch ■ [▼] or [▲] to select the folder.

Creating the playlist from the Artist/Album information of the current song

When a song is played back, a playlist about all the songs with the same Artist or Album stored in the USB memory or Portable audio player can be created.

1 Touch [P1/2] when a song is played back.
The function guide changes.

2 Touch [X-RPT ARTIST] or [X-RPT ALBUM] to create the playlist.

- According to the artist/album information of the current song, a playlist containing all the songs with the same artist/album (within the same BANK) are made into a playlist. The playlist begins playback immediately.

About MP3/WMA/AAC File of USB Memory

Playing back MP3/WMA/AAC

MP3/WMA/AAC files are prepared, then stored to a USB memory. A media player or jukebox can also be used to sync music to a portable device. This unit can recognize at least 256 folders (including root folder) and 10,000 files per folder stored in USB memory. Playback may not be performed if a USB memory/Portable audio player exceeds the limitations described above. Do not make a file's playback time more than 1 hour.

Media supported

This device can play back USB memory/Portable audio player media.

Corresponding File Systems

This device supports FAT 12/16/32 for USB memory device/Portable audio player.

iPhone/iPod (Optional)

An iPhone/iPod can be connected to this unit, by using the USB connection cable. When this unit is connected by using the cable, the controls on the iPod are not functional.

- Internet or telephone functions, etc., of the iPhone or iPod touch are not controllable from the unit, but these functions can be controlled using the iPhone or iPod touch itself.
- If you connect an iPhone to this unit, it can be used as an iPod. If you use iPhone as a hands-free phone, you need the optional BLUETOOTH INTERFACE (KCE-400BT).
- This unit does not support the iPod FULL SPEED connection. Therefore, even if you connect an iPhone/iPod using the FULL SPEED connection cable (KCE-433iV) on the BLUETOOTH INTERFACE (KCE-400BT), you cannot operate the iPhone/iPod.
- To watch the video screen of the video file in the iPod (iPhone, iPod touch, iPod classic, iPod with Video, Third generation iPod nano and fourth generation iPod nano), do the operation as described below.

Your vehicle must be parked with the ignition key in the ACC or ON position. To do this, follow the procedure below.

- 1 Push the foot brake to bring your vehicle to a complete stop at a safe location. Engage the parking brake.
- 2 Keep pushing the foot brake and release the parking brake once then engage it again.
- 3 While the parking brake is being engaged the second time, release the foot brake.

- For automatic transmission vehicles, place the transmission lever in the Park position.

About iPhone/iPod models usable with this unit

- Confirmed devices regarding Made for iPod. Correct function of earlier versions cannot be guaranteed.
iPod touch (2nd generation): Ver.3.0
iPod nano (4th generation): Ver.1.0.2
iPod classic (120 GB only): Ver.2.0.1
iPod touch (1st generation): Ver.3.0
iPod nano (3rd generation): Ver.1.1.3 PC
iPod classic (80 GB, 160 GB only): Ver.1.1.2 PC
iPod nano (2nd generation): Ver.1.1.3
iPod with video: Ver.1.3
iPod nano (1st generation): Ver.1.3.1
- Confirmed devices regarding Works with iPhone. Correct function of earlier versions cannot be guaranteed.
iPhone 3GS: Ver.3.1
iPhone 3G: Ver.3.0
iPhone: Ver.3.0

Playback

- 1 Press SOURCE/⏻ on the unit.**
The SOURCE selection screen is displayed.
- 2 Touch [iPod].**
The display shows the iPod mode screen.
- 3 Touch [◀◀] or [▶▶] to select the desired song.**

Return to the beginning of the current song:

Touch [⏮].

Fast backward the current song:

Touch and hold [⏮].

Advance to the beginning of the next song:

Touch [⏭].

Fast forward the current song:

Touch and hold [⏭].

4 To pause playback, touch [⏸ / ⏹].

Touching [⏸ / ⏹] again will resume playback.

- If a song is playing on the iPod when it is connected to the INA-W900, it will continue playing after the connection.
- An episode may have several chapters. The chapter can be changed by pressing [⏮] or [⏭].
- Display mode can be changed by touching [WIDE] when an iPod compatible video is connected. For details, refer to "Switching Display Modes" (page 46).
- If the artist, album or song name, created in iTunes, has too many characters, songs may not be played back when connected to the INA-W900. Therefore, a maximum of 250 characters is recommended. The maximum number of characters for the head unit is 128 (128 byte).
- Some characters may not be correctly displayed.
- "NO SUPPORT" is displayed when text information is not compatible with the INA-W900.

Searching for a desired Song

An iPhone/iPod can contain hundreds of songs. By keeping these songs organized in playlists, the INA-W900 can use these to ease song searches.

Using the search mode's individual hierarchy, you can narrow down your search as shown in the table below.

<MUSIC Search Menu>

Hierarchy 1	Hierarchy 2	Hierarchy 3	Hierarchy 4
Playlists	Songs	—	—
Artists*	Albums*	Songs	—
Albums*	Songs	—	—
Songs	—	—	—
Podcasts	Episodes	—	—
Genres*	Artists*	Albums*	Songs
Composers*	Albums*	Songs	—
Audiobooks	—	—	—

- Video search mode depends on the iPhone/iPod. If the specification of the iPhone/iPod is changed, the search mode on this unit will also be changed.

For example: Searching by Artist name

The following example explains how an ARTISTS search is performed. Another search mode can be used for the same operation, although the hierarchy differs.

Searching by artist name

1 Touch [Q].

The search mode is activated, and the search list screen appears.

- Touching [Q] for at least 2 seconds will return to last search mode.

2 Touch [⏭] of Music.

- When an iPod compatible video is connected. Videos mode can also be selected to playback video files stored in iPhone/iPod. If Videos mode is selected, the Video Playlists/Movies/Music Videos/TV Shows/Video Podcasts/Rentals search mode may be used depending on the connected iPhone/iPod.

3 Touch [⏭] of Artists.

The Artists search screen is displayed.

4 Select the desired artist.

To play back the artist directly

- 1 Touch [▶] next to the artist's name.
All songs of the selected artist are played back.

To search for the album of an artist

- 1 Touch [⏭] of the selected artist.
The Albums search screen of the selected artist is displayed.
- 2 Touch [▶] next to the desired album's name.
All songs of the selected album are played back.

To search for a song in the album of an artist







- 1 Touch [⏭] of the desired album in "To search for the album of an artist" in step 2.
The Songs search screen of the selected album is displayed.
- 2 Touch [▶] next to the desired song's name.
The selected song is played back.

- Touching [▶] of ALL will play back all songs in the list when you are in a hierarchy with an asterisk "*" (see table on left).
- Touching [⏭] of ALL will display the search list in the next hierarchy.
- Titles are listed alphabetically, and can be skipped every 200 titles with the same beginning with alphabetical character. If there are fewer than 200 titles, titles beginning with the next alphabetical character are selected. e.g. press ALPHABET [▶], switch to the section beginning with alphabet B from A.
(Only applicable to English alphabetic characters.)
- When search is made during M.I.X. play, the M.I.X. play mode will be canceled.

Selecting Playlist/Artist/Album/Genre/Composer/Episode/Category

Playlist/Artist/Album/Genre/Composer/Episode/Category*² can be easily changed.

For example, if you listen to a song from a selected album, the album can be changed.

Press [▼] or [▲] to select the desired  (Playlist) /  (Artist) /  (Album) /  (Genre) /  (Composer) /  (Episode) / Category*².

*² Category can be changed only when play back the video files of iPhone/iPod.

- If search selection mode is not activated, a Song search is not possible.
- If an album is selected from an artist search, the album can be searched.
- If Playlist/Artist/Album/Genre/Composer/Episode are not searched, this operation is not possible.

Random Play Shuffle (M.I.X.)

The Shuffle function of the iPod is displayed as M.I.X. on the INA-W900.

Shuffle ALL:

All songs in the iPod are played back in random sequence. Any one song does not play back again until all songs have been played back.

Shuffle Albums:

The songs on each album are played back in proper order. Upon completion of all the songs on the album, the next album is selected randomly. This continues until all albums have been played.

Shuffle Songs:

Song shuffle randomly plays back songs within a selected category (playlist, album, etc.). The songs within the category are played just once until all songs have been played.

1 Touch [⌘ ALL]*.

The songs will be played back in random sequence.

⌘ ALL ↔ (off)
(Shuffle ALL)

Touch [⌘] after touching [P1/2].

→ ⌘ [Album Icon] → ⌘ [Song Icon] → (off)
(Shuffle Albums) (Shuffle Songs)

2 To cancel M.I.X. play, touch [⌘ ALL] or [⌘].

- If a song is selected in the album search mode before selecting Shuffle (M.I.X.), the songs will not play back randomly even when Shuffle album is selected.

* This operation cannot be performed when play back the video files of iPhone/iPod.

Repeat Play

Only Repeat One is available for the iPod.

Repeat One: A single song is repeatedly played back.

1 Touch [P1/2].

The function guide is displayed.

2 Touch [↻].

The file will be played repeatedly.

↻ ↔ (off)
(Repeat One) (Repeat the list being played back)

3 To cancel repeat play, touch [↻].

- During repeat playback, no other songs are selectable by touching [◀◀] or [▶▶].

Information

About DVDs

Music CDs and DVDs have grooves (tracks) in which the digital data is recorded. The data is represented as microscopic pits recorded into the track – these pits are read by a laser beam to play the disc. On DVDs, the density of the tracks and pits is twice that of CDs, so DVDs can contain more data in less space.

CDs

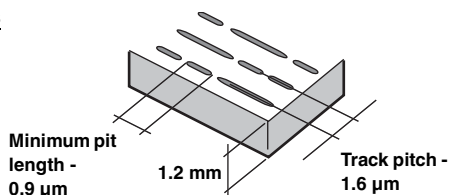

DVDs

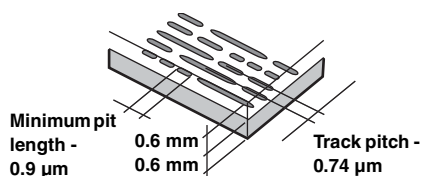

A 12 cm disc can contain one movie or about four hours of music. In addition, DVDs provide sharp picture quality with vivid colors thanks to a horizontal resolution of over 500 lines (compared to less than 300 for VHS tape).

In addition, DVDs offer a variety of functions.

Multiple audio* (page 43)

Movies can be recorded in up to eight languages. The desired language can be selected from the unit.

Subtitles function* (page 44)

Movies can include subtitles in up to 32 languages. The desired subtitle language can be selected from the unit.

Multi angle function* (page 43)

When the DVD contains a movie shot from multiple angles, the desired angle can be selected from the unit.

Multi story function*

With this function, a single movie includes various story lines. You can select different story lines to view various versions of the same movie.

Operation differs from disc to disc. Story line selection screens including instructions appear during the movie. Just follow the instructions.

* These functions differ from disc to disc. For details, refer to the disc's instructions.

Terminology

Dolby Digital

Dolby Digital is a digital audio compression technology developed by Dolby Laboratories that allows large quantities of audio data to be efficiently recorded on discs.

The INA-W900 performs Dolby Digital 2-channel decoding when it outputs analog audio signals.

DTS

This is a home-use digital sound format of the DTS Sound System. This is a high quality sound system, developed by DTS, Inc. for use in movie theaters.

The INA-W900 has a built-in DTS 2-channel audio decoder. Analog audio outputs are available.

Rating levels (parental lock)

This is a function of the DVD for restricting the viewing age as stipulated by laws in different countries. The way in which viewing is restricted differs from DVD to DVD. Sometimes the DVD cannot be played at all, other times certain scenes are skipped, and other times certain scenes are replaced with other scenes.

List of Language Codes

(For details, see page 47.)

Abbreviation	Code	Language	Abbreviation	Code	Language	Abbreviation	Code	Language
AA	6565	Afar	IE	7369	Interlingue	RN	8278	Kirundi
AB	6566	Abkhazian	IK	7375	Inupiak	RO	8279	Romanian
AF	6570	Afrikaans	IN	7378	Indonesian	RU	8285	Russian
AM	6577	Amharic	IS	7383	Icelandic	RW	8287	Kinyarwanda
AR	6582	Arabic	IT	7384	Italian	SA	8365	Sanskrit
AS	6583	Assamese	IW	7387	Hebrew	SD	8368	Sindhi
AY	6589	Aymara	JP	7465	Japanese	SG	8371	Sangho
AZ	6590	Azerbaijani	JL	7473	Yiddish	SH	8372	Serbo-Croatian
BA	6665	Bashkir	JW	7487	Javanese	SI	8373	Singhalese
BE	6669	Byelorussian	KA	7565	Georgian	SK	8375	Slovak
BG	6671	Bulgarian	KK	7575	Kazakh	SL	8376	Slovenian
BH	6672	Bihari	KL	7576	Greenlandic	SM	8377	Samoan
BI	6673	Bislama	KM	7577	Cambodian	SN	8378	Shona
BN	6678	Bengali, Bangla	KN	7578	Kannada	SO	8379	Somali
BO	6679	Tibetan	KO	7579	Korean	SQ	8381	Albanian
BR	6682	Breton	KS	7583	Kashmiri	SR	8382	Serbian
CA	6765	Catalan	KU	7585	Kurdish	SS	8383	Siswati
CO	6779	Corsican	KY	7589	Kirghiz	ST	8384	Sesotho
CS	6783	Czech	LA	7665	Latin	SU	8385	Sundanese
CY	6789	Welsh	LN	7678	Lingala	SV	8386	Swedish
DA	6865	Danish	LO	7679	Laothian	SW	8387	Swahili
DE	6869	German	LT	7684	Lithuanian	TA	8465	Tamil
DZ	6890	Bhutani	LV	7686	Latvian, Lettish	TE	8469	Telugu
EL	6976	Greek	MG	7771	Malagasy	TG	8471	Tajik
EN	6978	English	MI	7773	Maori	TH	8472	Thai
EO	6979	Esperanto	MK	7775	Macedonian	TI	8473	Tigrinya
ES	6983	Spanish	ML	7776	Malayalam	TK	8475	Turkmen
ET	6984	Estonian	MN	7778	Mongolian	TL	8476	Tagalog
EU	6985	Basque	MO	7779	Moldavian	TN	8478	Setswana
FA	7065	Persian	MR	7782	Marathi	TO	8479	Tonga
FI	7073	Finnish	MS	7783	Malay	TR	8482	Turkish
FJ	7074	Fiji	MT	7784	Maltese	TS	8483	Tsonga
FO	7079	Faroese	MY	7789	Burmese	TT	8484	Tatar
FR	7082	French	NA	7865	Nauru	TW	8487	Twi
FY	7089	Frisian	NE	7869	Nepali	UK	8575	Ukrainian
GA	7165	Irish	NL	7876	Dutch	UR	8582	Urdu
GD	7168	Scots Gaelic	NO	7879	Norwegian	UZ	8590	Uzbek
GL	7176	Galician	OC	7967	Occitan	VI	8673	Vietnamese
GN	7178	Guarani	OM	7977	(Afan) Oromo	VO	8679	Volapuk
GU	7185	Gujarati	OR	7982	Oriya	WO	8779	Wolof
HA	7265	Hausa	PA	8065	Punjabi	XH	8872	Xhosa
HI	7273	Hindi	PL	8076	Polish	YO	8979	Yoruba
HR	7282	Croatian	PS	8083	Pashto, Pushto	ZH	9072	Chinese
HU	7285	Hungarian	PT	8084	Portuguese	ZU	9085	Zulu
HY	7289	Armenian	QU	8185	Quechua			
IA	7365	Interlingua	RM	8277	Rhaeto-Romance			

List of Country Codes

(For details, see page 48.)

Abbreviation	Code	Country	Abbreviation	Code	Country	Abbreviation	Code	Country
AD	6568	Andorra	DM	6877	Dominica	KI	7573	Kiribati
AE	6569	United Arab Emirates	DO	6879	Dominican Republic	KM	7577	Comoros
AF	6570	Afghanistan	DZ	6890	Algeria	KN	7578	Saint Kitts and Nevis
AG	6571	Antigua and Barbuda	EC	6967	Ecuador	KP	7580	Korea, Democratic People's Republic of
AI	6573	Anguilla	EE	6969	Estonia			
AL	6576	Albania	EG	6971	Egypt	KR	7582	Korea, Republic of
AM	6577	Armenia	EH	6972	Western Sahara	KW	7587	Kuwait
AN	6578	Netherlands Antilles	ER	6982	Eritrea	KY	7589	Cayman Islands
AO	6579	Angola	ES	6983	Spain	KZ	7590	Kazakhstan
AQ	6581	Antarctica	ET	6984	Ethiopia	LA	7665	Lao People's Democratic Republic
AR	6582	Argentina	FI	7073	Finland			
AS	6583	American Samoa	FJ	7074	Fiji	LB	7666	Lebanon
AT	6584	Austria	FK	7075	Falkland Islands	LC	7667	Saint Lucia
AU	6585	Australia	FM	7077	Micronesia, Federated States of	LI	7673	Liechtenstein
AW	6587	Aruba	FO	7079	Faeroe Islands	LK	7675	Sri Lanka
AZ	6590	Azerbaijan	FR	7082	France	LR	7682	Liberia
BA	6665	Bosnia and Herzegovina	GA	7165	Gabon	LS	7683	Lesotho
BB	6666	Barbados	GB	7166	United Kingdom	LT	7684	Lithuania
BD	6668	Bangladesh	GD	7168	Grenada	LU	7685	Luxembourg
BE	6669	Belgium	GE	7169	Georgia	LV	7686	Latvia
BF	6670	Burkina Faso	GF	7170	French Guiana	LY	7689	Libyan Arab Jamahiriya
BG	6671	Bulgaria	GH	7172	Ghana	MA	7765	Morocco
BH	6672	Bahrain	GI	7173	Gibraltar	MC	7767	Monaco
BI	6673	Burundi	GL	7176	Greenland	MD	7768	Moldova, Republic of
BJ	6674	Benin	GM	7177	Gambia	MG	7771	Madagascar
BM	6677	Bermuda	GN	7178	Guinea	MH	7772	Marshall Islands
BN	6678	Brunei Darussalam	GP	7180	Guadeloupe	MK	7775	Macedonia, The former Yugoslav Republic of
BO	6679	Bolivia	GQ	7181	Equatorial Guinea			
BR	6682	Brazil	GR	7182	Greece	ML	7776	Mali
BS	6683	Bahamas	GS	7183	South Georgia and the South Sandwich Islands	MM	7777	Myanmar
BT	6684	Bhutan				MN	7778	Mongolia
BV	6686	Bouvet Island	GT	7184	Guatemala	MO	7779	Macau
BW	6687	Botswana	GU	7185	Guam	MP	7780	Northern Mariana Islands
BY	6689	Belarus	GW	7187	Guinea-Bissau	MQ	7781	Martinique
BZ	6690	Belize	GY	7189	Guyana	MR	7782	Mauritania
CA	6765	Canada	HK	7275	Hong Kong	MS	7783	Montserrat
CC	6767	Cocos (Keeling) Islands	HM	7277	Heard Island and McDonald Islands	MT	7784	Malta
CD	6768	Congo, the Democratic Republic of the				MU	7785	Mauritius
CF	6770	Central African Republic	HN	7278	Honduras	MV	7786	Maldives
CG	6771	Congo	HR	7282	Croatia	MW	7787	Malawi
CH	6772	Switzerland	HT	7284	Haiti	MX	7788	Mexico
CI	6773	Cote d'Ivoire	HU	7285	Hungary	MY	7789	Malaysia
CK	6775	Cook Islands	ID	7368	Indonesia	MZ	7790	Mozambique
CL	6776	Chile	IE	7369	Ireland	NA	7865	Namibia
CM	6777	Cameroon	IL	7376	Israel	NC	7867	New Caledonia
CN	6778	China	IN	7378	India	NE	7869	Niger
CO	6779	Colombia	IO	7379	British Indian Ocean Territory	NF	7870	Norfolk Island
CR	6782	Costa Rica	IQ	7381	Iraq	NG	7871	Nigeria
CU	6785	Cuba	IR	7382	Iran, Islamic Republic of	NI	7873	Nicaragua
CV	6786	Cape Verde	IS	7383	Iceland	NL	7876	Netherlands
CX	6788	Christmas Island	IT	7384	Italy	NO	7879	Norway
CY	6789	Cyprus	JM	7477	Jamaica	NP	7880	Nepal
CZ	6790	Czech Republic	JO	7479	Jordan	NR	7882	Nauru
DE	6869	Germany	JP	7480	Japan	NU	7885	Niue
DJ	6874	Djibouti	KE	7569	Kenya	NZ	7890	New Zealand
DK	6875	Denmark	KG	7571	Kyrgyzstan	OM	7977	Oman
			KH	7572	Cambodia	PA	8065	Panama

Abbreviation	Code	Country	Abbreviation	Code	Country	Abbreviation	Code	Country
PE	8069	Peru	SJ	8374	Svalbard and Jan Mayen	TW	8487	Taiwan, Province of China
PF	8070	French Polynesia	SK	8375	Slovakia	TZ	8490	Tanzania, United Republic of
PG	8071	Papua New Guinea	SL	8376	Sierra Leone	UA	8565	Ukraine
PH	8072	Philippines	SM	8377	San Marino	UG	8571	Uganda
PK	8075	Pakistan	SN	8378	Senegal	UM	8577	United States Minor Outlying Islands
PL	8076	Poland	SO	8379	Somalia	US	8583	United States
PM	8077	Saint Pierre and Miquelon	SR	8382	Suriname	UY	8589	Uruguay
PN	8078	Pitcairn	ST	8384	Sao Tome and Principe	UZ	8590	Uzbekistan
PR	8082	Puerto Rico	SV	8386	El Salvador	VA	8665	Holy See (Vatican City State)
PT	8084	Portugal	SY	8389	Syrian Arab Republic	VC	8667	Saint Vincent and the Grenadines
PW	8087	Palau	SZ	8390	Swaziland	VE	8669	Venezuela
PY	8089	Paraguay	TC	8467	Turks and Caicos Islands	VG	8671	Virgin Island, British
QA	8165	Qatar	TD	8468	Chad	VI	8673	Virgin Islands, U.S
RE	8269	Reunion	TF	8470	French Southern Territories	VN	8678	Viet Nam
RO	8279	Romania	TG	8471	Togo	VU	8685	Vanuatu
RU	8285	Russian Federation	TH	8472	Thailand	WF	8770	Wallis and Futuna
RW	8287	Rwanda	TJ	8474	Tajikistan	WS	8783	Samoa
SA	8365	Saudi Arabia	TK	8475	Tokelau	YE	8969	Yemen
SB	8366	Solomon Islands	TM	8477	Turkmenistan	YT	8984	Mayotte
SC	8367	Seychelles	TN	8478	Tunisia	YU	8985	Yugoslavia
SD	8368	Sudan	TO	8479	Tonga	ZA	9065	South Africa
SE	8369	Sweden	TP	8480	East Timor	ZM	9077	Zambia
SG	8371	Singapore	TR	8482	Turkey	ZW	9087	Zimbabwe
SH	8372	Saint Helena	TT	8484	Trinidad and Tobago			
SI	8373	Slovenia	TV	8486	Tuvalu			

In Case of Difficulty

If you encounter a problem, please turn the power off, then on again. If the unit is still not functioning normally, please review the items in the following checklist. This guide will help you isolate the problem if the unit is at fault. Otherwise, make sure the rest of your system is properly connected, or then consult your authorized Alpine dealer or Alpine directly at 1-888-NAV-HELP (1-888-628-4357).

Basic

No function or display.

- Vehicle's ignition is off.
 - If connected according to the instructions, the unit will not operate with the vehicle's ignition off.
- Improper power lead connections.
 - Check power lead connections.
- Blown fuse.
 - Check the fuse on the battery lead of the unit; replace with the proper value if necessary.
- Internal micro-computer malfunctioned due to interference noise, etc.
 - Press the RESET switch with a ballpoint pen or other pointed article.
 - Press any button to power on this unit.

No sound or unnatural sound.

- Incorrect setting of volume/balance/fader controls.
 - Readjust the controls.
- Connections are not properly or securely made.
 - Check the connections and firmly connect.

Screen not displayed.

- Brightness control is set at the minimum position.
 - Adjust the Brightness control.
- Temperature in the vehicle is too low.
 - Increase the vehicle's interior temperature to operation temperature range.
- Connections to the DVD, CD player, navigation system are not securely made.
 - Check the connections and firmly connect.

Movement of displayed picture is abnormal.

- Temperature in the vehicle is too high.
 - Allow the vehicle's interior temperature to cool.

Unclear or noisy display.

- TFT-LCD MODULE is worn out.
 - Replace the TFT-LCD MODULE.

The remote control is inoperative.

- The remote control sensor setting of "Rear Entertainment Function" is not set to this unit.
 - Set for this unit.

Navigation

The vehicle's position is erroneous.

- The GPS reception is poor.
 - Drive the vehicle in an area of good GPS reception to allow the unit to recalibrate itself. Move to a location where strong GPS reception is possible.

No operation

- Moisture condensation
 - Allow enough time for the condensation to evaporate (about 1 hour).
- Ambient Temperature
 - Make sure the temperature inside the vehicle is between 0°C and 45°C (32°F and 113°F).

Radio

Unable to receive stations.

- No antenna, or open connection in the antenna cable.
 - Make sure the antenna is properly connected; replace the antenna or cable if necessary.

Unable to tune stations in the seek mode.

- You are in a weak signal area.
 - Make sure the tuner is in DX mode.
- If the area you are in is a primary signal area, the antenna may not be grounded and connected properly.
 - Check your antenna connections; make sure the antenna is properly grounded at its mounting location.
- The antenna may not be the proper length.
 - Make sure the antenna is fully extended; if broken, replace the antenna with a new one.

Broadcast is noisy.

- The antenna is not the proper length.
 - Extend the antenna fully; replace it if it is broken.
- The antenna is poorly grounded.
 - Make sure the antenna is grounded properly at its mounting location.
- The station signal is weak and noisy.
 - If above solution does not work, tune in another station.

CD/MP3/WMA/AAC/DVD

Disc playback sound is wavering.

- Moisture condensation in the disc Module.
 - Allow enough time for the condensation to evaporate (about 1 hour).

Disc insertion not possible.

- A disc is already in the DVD player.
 - Eject the disc and remove it.
- The disc is being improperly inserted.
 - Make sure the disc is being inserted following the instructions in the CD/MP3/WMA/AAC, DVD Player Operation section.

Unable to fast forward or backward the disc.

- The disc has been damaged.
 - Eject the disc and discard it; using a damaged disc in your unit can cause damage to the mechanism.

Disc playback sound skips due to vibration.

- Improper mounting of the unit.
 - Securely re-mount the unit.
- Disc is very dirty.
 - Clean the disc.
- Disc has scratches.
 - Change the disc.
- The pick-up lens is dirty.
 - Do not use a commercially available lens cleaner disc. Consult your nearest Alpine dealer.

Disc playback sound skips without vibration.

- Dirty or scratched disc.
 - Clean the disc; damaged disc should be replaced.

CD-R/CD-RW playback not possible.

- Close session (finalization) has not been performed.
 - Perform finalization and attempt playback again.

Error displays.

- Mechanical error.
 - Touch [Eject] of Disc on the Eject/Tilt screen. After the error indication disappears, insert the disc again. If the above-mentioned solution does not solve the problem, consult your nearest Alpine dealer.

MP3/WMA/AAC is not played back.

- Writing error occurred. The CD format is not compatible.
 - Make sure the CD has been written in a supported format. Refer to "About MP3/WMA/AAC" (pages 38 and 39), then rewrite in the format supported by this device.

Unit does not operate.

- Monitor's power is not turned on.
 - Turn on the monitor's power.
- Condensation.
 - Wait a while (about 1 hour) for the condensation to dry.

No picture is produced.

- Monitor's mode is not switched to the mode you want to see.
 - Switch to the mode you want to see.
- Monitor's parking brake lead is not connected.
 - Connect the monitor's parking brake wire and set the parking brake. (For details, refer to the monitor's instructions.)

Playback does not start.

- Disc is loaded upside-down.
 - Check the disc and load it with the labeled side facing upward.
- Disc is dirty.
 - Clean the disc.
- A disc not able to play back with this unit is loaded.
 - Check if the disc is able to be played back.
- Parental lock is set.
 - Cancel the parental lock or change the rating level.

Picture is unclear or noisy.

- Disc is being fast-forwarded or fast-reversed.
 - The picture may be slightly disturbed, but this is normal.
- Vehicle's battery power is weak.
 - Check the battery power and wiring.
(The unit may malfunction if the battery power is under 11 volts with a load applied.)

Image stops sometimes.

- Disc is scratched.
 - Replaced with a non-scratched disc.

Indication for CD/MP3/WMA/AAC

No Disc

- No disc is inserted.
 - Insert a disc.
- Although a disc is inserted, "No Disc" is displayed and the unit does not start to play or eject the disc.
 - Remove the disc by following these steps.
Press  for at least 3 seconds.

Loading Error

Eject Error

- Mechanism error.
 - 1) Touch [Eject] of Disc on the Eject/Tilt screen and eject the disc. If not ejecting, consult your Alpine dealer.
 - 2) When the error indication remains after ejecting, touch [Eject] of Disc on the Eject/Tilt screen again. If the error indication still does not turn off after trying to touch [Eject] of Disc on the Eject/Tilt screen, for a few times, consult your Alpine dealer.
- Disc was forcibly pulled out by hand during Auto Loading.
 - When the error indication remains after loading, try to load again.
If the error indication still does not turn off after pressing for a few times, consult your Alpine dealer.

Disc Error

- Scratched disc, contaminated disc/poor recording/disc incompatible with this unit.
 - Touch [Eject] of Disc on the Eject/Tilt screen.
- Change the disc.

Protect

- A copy-protected WMA file was played back.
 - You can only play back non-copy-protected files.

Unsupported

- A sampling rate/bit rate not supported by the unit is used.
 - Use a sampling rate/bit rate is supported by the unit.

Indication for DVD/CD

No Disc

- No disc is inserted.
 - Insert a disc.
- Although a disc is inserted, "No Disc" is displayed and the unit does not start to play or eject the disc.
 - Remove the disc by following these steps.
Press  for at least 3 seconds.



- Button operation on the unit or remote control is not possible.
 - For some discs or playing modes, certain operations are not possible. This is not a malfunction.
-

Regional Code Violation

- Disc does not match regional code number.
 - Load a disc that matches the regional code number.
-

Loading Error

Eject Error

- Mechanism error.
 - 1) Touch **[Eject]** of Disc on the Eject/Tilt screen and eject the disc.
 - If not ejecting, consult your Alpine dealer.
 - 2) When the error indication remains after ejecting, touch **[Eject]** of Disc on the Eject/Tilt screen again.
 - If the error indication still does not turn off after touching **[Eject]** of Disc on the Eject/Tilt screen for a few times, consult your Alpine dealer.
-

Disc Error

- Scratched disc, contaminated disc/poor recording/disc incompatible with this unit.
 - Touch **[Eject]** of Disc on the Eject/Tilt screen.
 - Change the disc.
-

Eject disc before using DVD-Setup

- The DVD setup operation was attempted when a disc is inserted in the unit.
 - Eject the disc before the DVD setup operation.
-

Indication for CD changer

Hi-Temp

- Protective circuit is activated due to high temperature.
 - The indicator will disappear when the temperature returns to within operation range.
-

Error 01

- Malfunction in the CD Changer.
 - Consult your Alpine dealer. Press the magazine eject button and pull out the magazine.
 - Check the indication. Insert the magazine again.
 - If the magazine cannot be pulled out, consult your Alpine dealer.
 - Magazine ejection not possible.
 - Press the magazine eject button. If the magazine does not eject, consult your Alpine dealer.
-

Error 02

- A disc is left inside the CD Changer.
 - Press the eject button to activate the eject function. When the CD Changer finishes the eject function, insert an empty CD magazine into the CD Changer to receive the disc left inside the CD Changer.
-

No Magazine

- No magazine is loaded into the CD Changer.
 - Insert a magazine.
-

No Disc

- No indicated disc.
 - Choose another disc.
-

Indication for SAT Receiver Mode

Check XM Tuner (XM mode)

- MiniTuner missing/ disconnected or no communication between the unit and XM Radio.
 - Check the XM Tuner.

Check Antenna (XM mode)

Antenna Error (Sirius mode)

- The XM or Sirius antenna is not connected to the XM or SIRIUS radio module.
 - Check whether the XM or Sirius antenna cable is attached securely to the XM or Sirius radio module.

No Signal (XM mode)

Acquiring Signal (Sirius mode)

- XM or Sirius signal is too weak at the current location.
 - Wait until the car reaches a location with a stronger signal.

Loading (XM mode)

- Radio is acquiring audio or program information.
 - Wait until the radio has received the information.

Channel Off Air (XM mode)

- The channel currently selected has stopped broadcasting.
 - Select another channel.

Chan Unavailable (XM mode)

Invalid Channel (Sirius mode)

- The user has selected a channel number that does not exist.
 - The unit will revert back to the previously selected channel.

Ch Unauthorized (XM mode)

- The user has selected a channel number that is not authorized.
 - The unit will revert back to the previously selected channel or channel 1.

FW Updating (Sirius mode)

- Radio's firmware is being updated. During firmware update, audio will be muted until update is completed.
 - Wait until the update is completed. After completion, automatically re-tune to previous channel.

SUB Updating (Sirius mode)

- The subscribed program is being updated. During update, audio will be muted until update is completed.
 - Wait until the update is completed. After completion, follow the indication "SUB Updated Press Any Key" to press any key on the unit to continue, the unit automatically re-tune to previous channel.

Updating Channels (Sirius mode)

- The Receiver is updating the Sirius channel line up. During update audio will be muted until update is completed.
 - Wait until the channel update is completed. After completion, the unit automatically re-tune to previous channel.

Indication for iPhone/iPod Mode

Current Error

- Abnormal current is run to the USB connector device.
 - Attempt to connect another iPhone/iPod.

USB Device Error

- An iPhone/iPod that is not supported by the unit is connected.
 - Connect an iPhone/iPod that is supported by the unit.
 - Reset the iPod.

No USB Device

- An iPhone/iPod is not connected.
 - Make sure the iPhone/iPod is correctly connected and the cable is not excessively bent.

No Song

- There are no songs in the iPhone/iPod.
 - Download songs to the iPhone/iPod and connect to the INA-W900.

Error 01

- Communication error.
 - Turn the ignition key off, and then set to ON again.
 - Check the display by reconnecting between the iPhone/iPod and the unit, using the iPhone/iPod cable.

Error 02

- Caused by the iPhone/iPod Software Version not being compatible with this unit.
 - Update the iPhone/iPod Software Version to be compatible with this unit.

Error 03

- The iPhone/iPod is not verified.
 - Change another iPhone/iPod.
-

Indication for USB memory/Portable audio player mode

Current Error

- Abnormal current is run to the USB connector device. USB memory/Portable audio player is a malfunction or it is shorted.
 - Connect another USB memory/Portable audio player.
-

USB Device Error

- A USB device/Portable audio player that is not supported by the unit is connected.
 - Attempt to connect another USB memory/Portable audio player.
-

No USB Device

- A USB memory/Portable audio player is not connected.
 - Make sure the USB memory device/Portable audio player is correctly connected and the cable of Portable audio player is not excessively bent.
-

No Song

- There are no songs in the USB memory/Portable audio player.
 - Download songs to the USB memory/Portable audio player and connect to this unit.
-

Unsupported

- A sampling rate/bit rate not supported by the unit is used.
 - Use a sampling rate/bit rate that is supported by the unit.
-

Protect

- A copy-protected WMA file was played back.
 - You can only play back non-copy-protected files.
 - Make sure the Portable audio player is set to MTP.
-

Error 01

- Communication error.
 - Turn the ignition key off, and then set to ON again.
 - Check the display by reconnecting between the USB memory/Portable audio player and the unit.
-

Error 02

- Caused by the Portable audio player Software Version not being compatible with this unit.
 - Update the Portable audio player Software Version to be compatible with this unit.
-

Error 03

- The Portable audio player is not verified.
 - Change another Portable audio player.
-

Specifications

MONITOR SECTION

Screen Size	7.0"
LCD Type	Transparent type TN LCD
Operation System	TFT active matrix
Number of Picture Elements	1,152,000 pcs. (800 × 3 × 480)
Effective Number of Picture Elements	99% or more
Illumination System	LED

FM TUNER SECTION

Tuning Range	87.7 – 107.9 MHz
Mono Usable Sensitivity	9 dBf (0.8 μ V/75 ohms)
50 dB Quieting Sensitivity	9 dBf (0.8 μ V/75 ohms)
Alternate Channel Selectivity	80 dB
Signal-to-Noise Ratio	60 dB
Stereo Separation	30 dB
Capture Ratio	2.0 dB

AM TUNER SECTION

Tuning Range	530 – 1,710 kHz
Usable Sensitivity	22.5 μ V/27 dBf

NAVIGATION SECTION

Received Frequency	1.57542 \pm 1.023MHz
Receiving Sensitivity	-130dBm

USB SECTION

USB requirements	USB 1.1/2.0
Max. Power Consumption	500mA
USB Class	USB (Play From Device)/ USB (Mass Storage Class)
File System	FAT12/16/32
MP3 Decoding	MPEG-1/2 AUDIO Layer-3
WMA Decoding	Windows Media™ Audio
AAC Decoding	AAC-LC format “.m4a” file
Number of Channels	2-Channel (Stereo)
Frequency Response*	5-20,000 Hz (\pm 1 dB)
Total Harmonic Distortion	0.008% (at 1 kHz)
Dynamic Range	95 dB (at 1 kHz)
Signal-to-Noise Ratio	105 dB
Channel Separation	85 dB (at 1 kHz)

*Frequency response may differ depending on the encoder software/bit rate.

CD/DVD SECTION

Frequency Response	5 – 20,000 Hz
Wow & Flutter (% WRMS)	Below measurable limits
Total Harmonic Distortion	0.02% (at 1 kHz)
Dynamic Range	95 dB (at 1 kHz)
Channel Separation	65 dB (at 1 kHz)
Signal system	NTSC/PAL
Horizontal resolution	500 lines or greater
Video output level	1Vp-p (75 ohms)
Video S/N ratio	DVD: 60 dB

Audio S/N ratio	More than 95 dB
-----------------	-----------------

PICKUP

Wave length	DVD: 666 nm CD: 785 nm
Laser power	CLASS II

GENERAL

Power Requirement	14.4 V DC (11–16 V allowable)
Operating temperature	+32°F to +113°F (0°C to +45°C)
Power Output	18 W RMS \times 4*
* Primary amplifier ratings per CEA-2006 Standard	
• Power output: measured at 4 Ohms and \leq 1% THD+N	
• S/N: 80 dBA (reference: 1 W into 4 Ohms)	
Output Voltage	2,000 mV/10 k ohms
Bass	\pm 14 dB at 60 Hz
Treble	\pm 14 dB at 10 kHz
Weight	2.7 kg (5 lbs. 15 oz)
Audio output level	
Preout (Front, Rear):	2 V/10 k ohms (max.)
Preout (Subwoofer):	2 V/10 k ohms (max.)
AUX OUT:	1.2 V/10 k ohms
Ai-NET:	850 mV

CHASSIS SIZE (Monitor section)

Width	178 mm (7")
Height	100 mm (3-15/16")
Depth	160.5 mm (6-3/8")

- Due to continuous product improvement, specifications and design are subject to change without notice.
- The LCD panel is manufactured using an extremely high precision manufacturing technology. Its effective pixel ratio is over 99.99%. This means that there is a possibility that 0.01% of the pixels could be either always ON or OFF.

CAUTION

CAUTION-Laser radiation when open, DO NOT STARE INTO BEAM

(Bottom side of player)

Installation and Connections

Before installing or connecting the unit, please read the following and pages 5 to 10 of this manual thoroughly for proper use.

Warning

MAKE THE CORRECT CONNECTIONS.

Failure to make the proper connections may result in fire or product damage.

USE ONLY IN CARS WITH A 12 VOLT NEGATIVE GROUND.

(Check with your dealer if you are not sure.) Failure to do so may result in fire, etc.

BEFORE WIRING, DISCONNECT THE CABLE FROM THE NEGATIVE BATTERY TERMINAL.

Failure to do so may result in electric shock or injury due to electrical shorts.

DO NOT ALLOW CABLES TO BECOME ENTANGLED IN SURROUNDING OBJECTS.

Arrange wiring and cables in compliance with the manual to prevent obstructions when driving. Cables or wiring that obstruct or hang up on places such as the steering wheel, gear lever, brake pedals, etc. can be extremely hazardous.

DO NOT SPLICE INTO ELECTRICAL CABLES.

Never cut away cable insulation to supply power to other equipment. Doing so will exceed the current carrying capacity of the wire and result in fire or electric shock.

DO NOT DAMAGE PIPE OR WIRING WHEN DRILLING HOLES.

When drilling holes in the chassis for installation, take precautions so as not to contact, damage or obstruct pipes, fuel lines, tanks or electrical wiring. Failure to take such precautions may result in fire.

DO NOT USE BOLTS OR NUTS IN THE BRAKE OR STEERING SYSTEMS TO MAKE GROUND CONNECTIONS.

Bolts or nuts used for the brake or steering systems (or any other safety-related system), or tanks should NEVER be used for installations or ground connections. Using such parts could disable control of the vehicle and cause fire etc.

KEEP SMALL OBJECTS SUCH AS BATTERIES OUT OF THE REACH OF CHILDREN.

Swallowing them may result in serious injury. If swallowed, consult a physician immediately.

DO NOT INSTALL IN LOCATIONS WHICH MIGHT HINDER VEHICLE OPERATION, SUCH AS THE STEERING WHEEL OR GEARSHIFT.

Doing so may obstruct forward vision or hamper movement etc. and results in serious accident.

Caution

HAVE THE WIRING AND INSTALLATION DONE BY EXPERTS.

The wiring and installation of this unit requires special technical skill and experience. To ensure safety, always contact the dealer where you purchased this product to have the work done.

USE SPECIFIED ACCESSORY PARTS AND INSTALL THEM SECURELY.

Be sure to use only the specified accessory parts. Use of other than designated parts may damage this unit internally or may not securely install the unit in place. This may cause parts to become loose resulting in hazards or product failure.

ARRANGE THE WIRING SO IT IS NOT CRIMPED OR PINCHED BY A SHARP METAL EDGE.

Route the cables and wiring away from moving parts (like the seat rails) or sharp or pointed edges. This will prevent crimping and damage to the wiring. If wiring passes through a hole in metal, use a rubber grommet to prevent the wire's insulation from being cut by the metal edge of the hole.

DO NOT INSTALL IN LOCATIONS WITH HIGH MOISTURE OR DUST.

Avoid installing the unit in locations with high incidence of moisture or dust. Moisture or dust that penetrates into this unit may result in product failure.

Precautions

- Be sure to disconnect the cable from the (-) battery post before installing your INA-W900. This will reduce any chance of damage to the unit in case of a short-circuit.
- Be sure to connect the color coded leads according to the diagram. Incorrect connections may cause the unit to malfunction or damage to the vehicle's electrical system.
- When making connections to the vehicle's electrical system, be aware of the factory installed components (e.g. on-board computer). Do not tap into these leads to provide power for this unit. When connecting the INA-W900 to the fuse box, make sure the fuse for the intended circuit of the INA-W900 has the appropriate amperage. Failure to do so may result in damage to the unit and/or the vehicle. When in doubt, consult your Alpine dealer.
- The INA-W900 uses female RCA-type jacks for connection to other units (e.g. amplifier) having RCA connectors. You may need an adaptor to connect other units. If so, please contact your authorized Alpine dealer for assistance.
- Be sure to connect the speaker (-) leads to the speaker (-) terminal. Never connect left and right channel speaker cables to each other or to the vehicle body.
- The Display must be completely retracted in the casing when installing. If it is not, problems may occur.
- When installing in automobiles, make sure the Display can open/close without coming in contact with the gear shift.

IMPORTANT

Please record the serial number of your unit in the space provided below and keep it as a permanent record. The serial number plate is located on the bottom of the unit.

SERIAL NUMBER: _____
INSTALLATION DATE: _____
INSTALLATION TECHNICIAN: _____
PLACE OF PURCHASE: _____

Installation

Caution

Do not block the unit's fan or heat sink, thus preventing air circulation. If blocked, heat will accumulate inside the unit and may cause a fire.

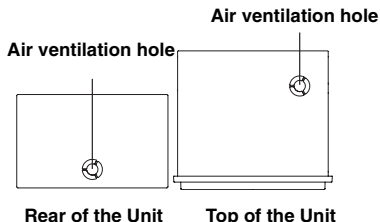

Caution concerning the installation location

- 1 Before installing, make sure that the opening and closing of the display will not interfere with operation of the gear shift.

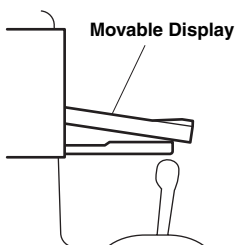

2 Angle of installation

About the installation angle, please install as horizontally as possible within the following angle range. If the installation angle is beyond the range, the current position may not be correctly displayed and a maloperation may be caused for the navigation mode.

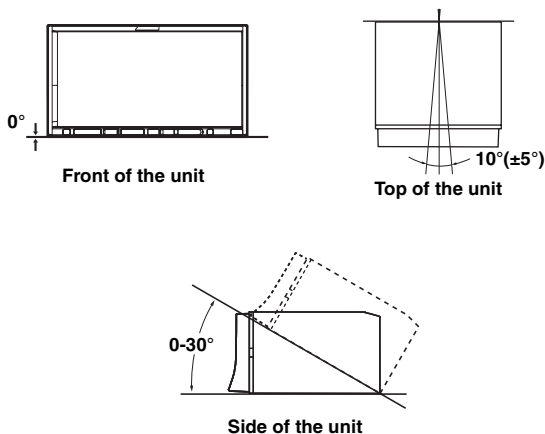

- 3 Remove the mounting sleeve from the main unit (see "Removal" on page 92).

The unit can be installed in the mounting sleeve in three positions by aligning its mounting holes (A to C) on the sides of the unit. Position A will be used in most cases. If B or C are to be used, the hole positions need to be modified.

First, determine the mounting position in the mounting sleeve, then affix the supplied seal (refer to "How to use a Seal" (page 92)).

Slide the unit into the mounting sleeve and secure it.

- If B or C is used, make sure that there is a enough space depthwise before installing the unit. If the unit is forcibly pushed into the mounting sleeve, damage may occur.

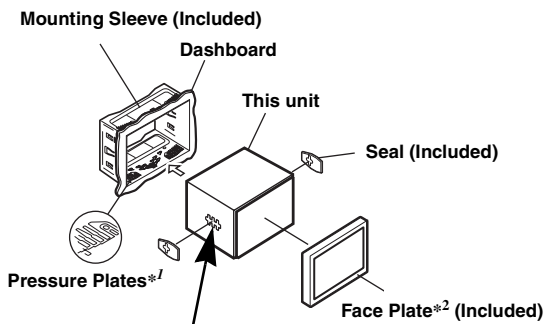

<Mounting Hole Position>

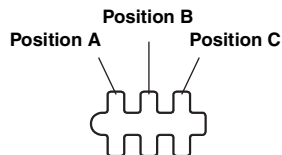

- Depending on the position chosen, the front panel will protrude differently.

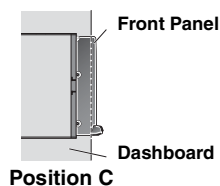
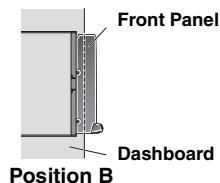
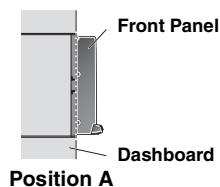

*1 If the installed mounting sleeve is loose in the dashboard, the pressure plates may be bent slightly to remedy the problem.

How to use a Seal

If A is used for installation:

Affix the seal so that mounting holes B and C are covered.

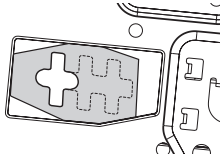

If B is used for installation:

Affix the seal so that mounting holes A and C are covered.

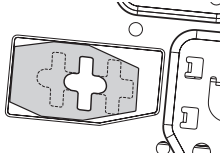

If C is used for installation:

Affix the seal so that the mounting holes A and B are covered.

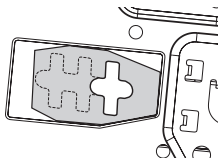

Installing the Face Plate

^{*2} If A is used, the supplied face plate may be mounted.

If B is used, the face plate must be modified before installing it.

To modify the face plate, consult your Alpine dealer.

If C is used, the face plate cannot be mounted. Consult your Alpine dealer.

4

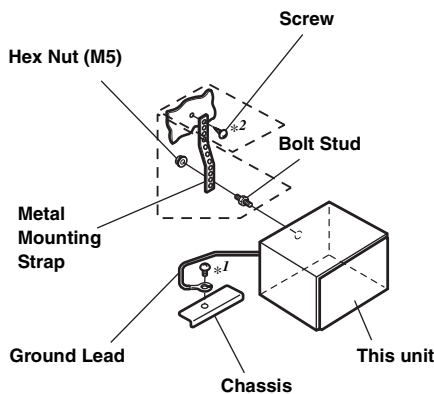

Reinforce the head unit with the metal mounting strap (not supplied). Secure the ground lead of the unit to a clean metal spot using a screw (^{*1}) already attached to the vehicle's chassis.

- For the screw marked "^{*2}", use an appropriate screw for the chosen mounting location.

Connect each input lead coming from an amplifier or equalizer to the corresponding output lead coming from the left rear of the INA-W900. Connect all other leads of the INA-W900 according to details described in the CONNECTIONS section.

- 5 Slide the INA-W900 into the dashboard until it clicks. This ensures that the unit is properly locked and will not accidentally come out from the dashboard.

Removal

1. Insert the bracket keys into the unit, along the guides on either side. The unit can now be removed from the mounting sleeve.

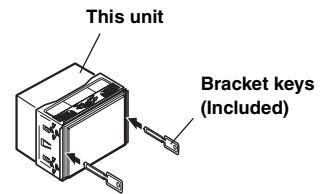

2. Pull the unit out, keeping it unlocked as you do so.

<JAPANESE CAR>

Take the face plate off, and secure the ground lead of the unit to a clean metal spot using a screw (^{*}) already attached to the car's chassis.

Attach the Original Mounting Bracket to each side of the INA-W900, using the screws supplied with INA-W900.

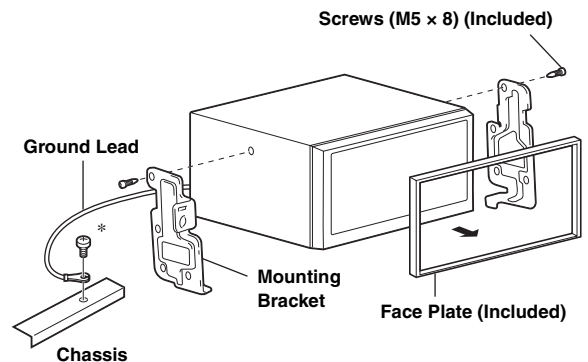

Install the GPS antenna

<For inside vehicle>

1. Stick the ground pad at the center of dash board and close to windshield with one inch distance.
2. Attach GPS antenna to the center of ground pad. (the cable side faces the back of vehicle)

<For outside vehicle>

At the front or back of vehicle roof.

Wiring the GPS antenna cable

Do not bend or fold the GPS antenna cable.

- When installing the INA-W900 to the vehicle, make sure the back of unit and the cable must not be bent.

Connect the GPS antenna

Securely connect the GPS antenna connector to INA-W900.

Connection of USB extension cable (included)

Connect the USB extension cable to the USB connector of the unit, and then secure the connection using the lock case supplied with USB extension cable as shown below.

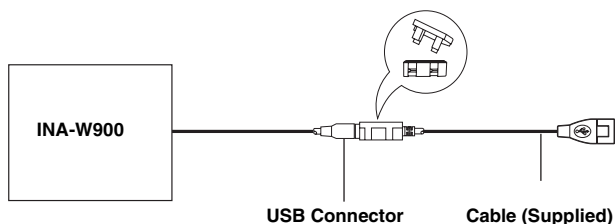

Foot Brake Lead / Parking Brake Lead Connection

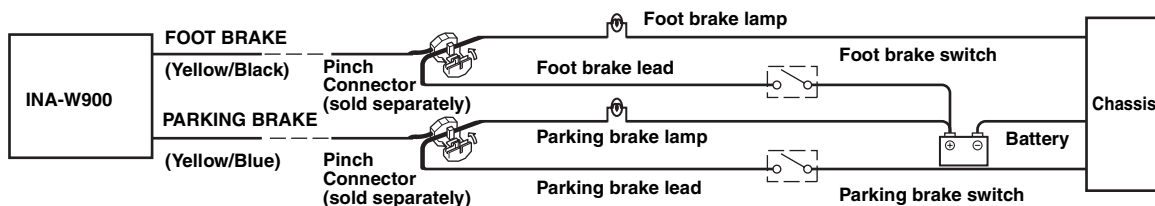

Connection Diagram of SPST Switch (sold separately)

(If the ACC power supply is not available)

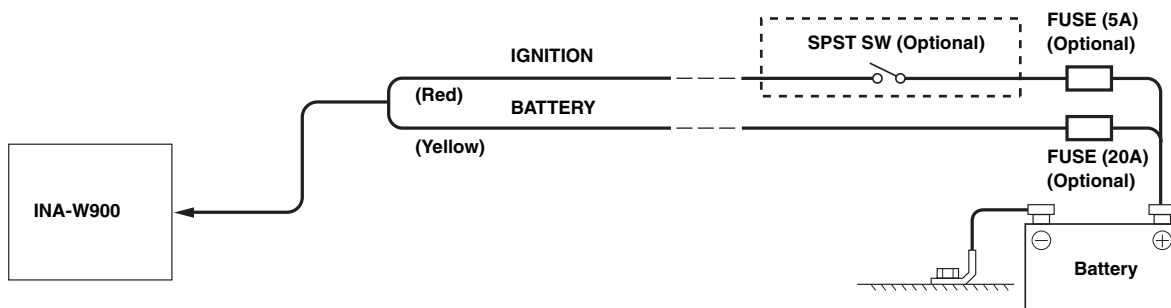

- If your vehicle has no ACC power supply, add an SPST (Single-Pole, Single-Throw) switch (sold separately) and fuse (sold separately).
- The diagram and the fuse amperage shown above are in the case when INA-W900 is used individually.
- If the switched power (ignition) lead of the INA-W900 is connected directly to the positive (+) post of the vehicle's battery, the INA-W900 draws some current (several hundred milliamperes) even when its switch is placed in the OFF position and the battery may be discharged.

To prevent external noise from entering the audio system.

- Locate the unit and route the leads at least 10 cm away from the car harness.
- Keep the battery power leads as far away from other leads as possible.
- Connect the ground lead securely to a bare metal spot (remove any paint, dirt or grease if necessary) of the car chassis.
- If you add an optional noise suppressor, connect it as far away from the unit as possible. Your Alpine dealer carries various noise suppressors, contact them for further information.
- Your Alpine dealer knows best about noise prevention measures so consult your dealer for further information.

Connections

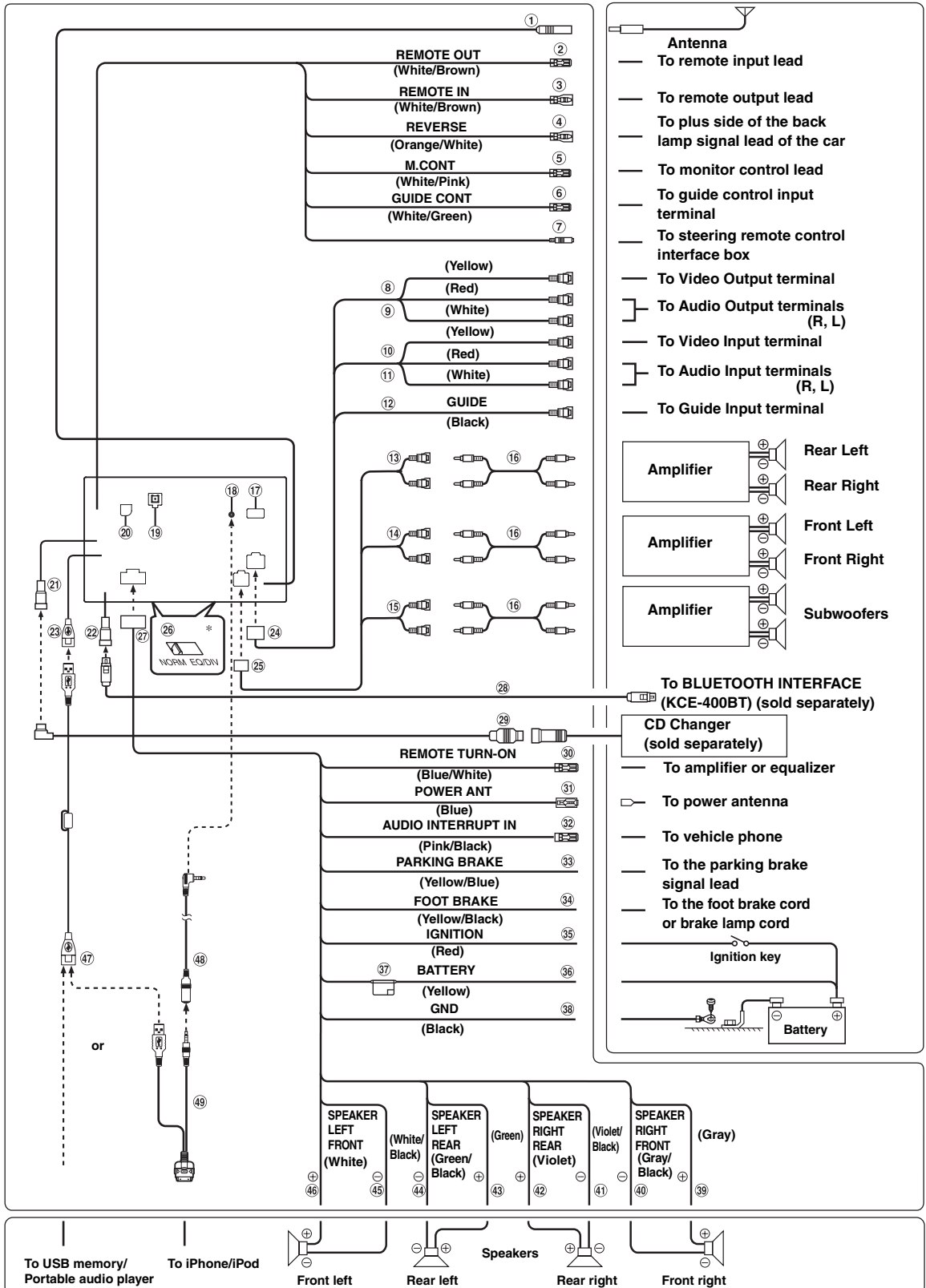

• Set the system switch to "NORM" when only a changer is connected (when the Ai-NET compatible equalizer is not used). When the IMPRINT audio processor is connected, set to EQ/DIV position.

* The two system switches are located on the bottom of the unit.

- ① **Radio Antenna Receptacle**
- ② **Remote Control Output Lead (White/Brown)**
Connect this lead to the remote control input lead. This lead outputs the controlling signals from the remote control.
- ③ **Remote Control Input Lead (White/Brown)**
Connect the external Alpine product to the remote control output lead.
- ④ **Reverse Lead (Orange/White)**
Use only when a back-up camera is connected. Connect to the plus side of the car's reverse lamp. This lamp illuminates when the transmission is shifted into reverse (R).
With this lead properly wired, the video picture automatically switches to the back-up camera whenever the car is put into reverse (R).
- ⑤ **Monitor Control Lead (White/Pink)**
Connect this to the Monitor Control Lead of the touch panel-compatible rear monitor.
- ⑥ **Guide Control Lead (White/Green)**
Use when an optional External Audio Processor with guide control input terminal is connected.
- ⑦ **Steering Remote Control Interface Connector**
To steering remote control interface box.
For details about connections, consult your nearest Alpine dealer.
- ⑧ **Video Input Connector (AUX INPUT) (Yellow)**
Input the video.
- ⑨ **Audio Input Connectors (AUX INPUT)**
RED is right and WHITE is left input the audio.
- ⑩ **Video Output Connector (AUX OUTPUT) (Yellow)**
Output the video.
- ⑪ **Audio Output Connectors (AUX OUTPUT)**
RED is right and WHITE is left output the audio.
- ⑫ **Guide Connector (Black)**
Output the audio signal of navigation interruption.
When connecting an IMPRINT Audio processor (PXA-H100), connect this lead to the Guide Input terminal with an optional RCA Extension cable.
- ⑬ **Rear Output/Input RCA Connectors**
It can be used as Rear Output or Input RCA Connectors.
- ⑭ **Front Output/Input RCA Connectors**
It can be used as Front Output or Input RCA Connectors.
- ⑮ **Subwoofer RCA Connectors**
RED is right and WHITE is left.
- ⑯ **RCA Extension Cable (sold separately)**
- ⑰ **Direct CAMERA Input Connector**
Use when the optional rearview camera HCE-C107D, etc. is connected.
- ⑱ **iPod AUDIO/VIDEO Input Connector**
Connect this to the AV extension cable.
- ⑲ **GPS Antenna Receptacle**
To GPS Antenna.
- ⑳ **MSN Connector**
To MSN Direct Box HCE-900m.

• *MSN Direct feature is ready on future update.*
- ㉑ **Ai-NET Connector**
Connect this to the output or input connector of another device (CD Changer, Equalizer, etc.) equipped with Ai-NET.

• *Be sure to set "Setting the Connected Head Unit (MODEL SETUP)" to "DVD CHG", when the DHA-S690 is connected.*
- ㉒ **BLUETOOTH interface Connector**
Connect this to an optional BLUETOOTH INTERFACE (KCE-400BT). To use a hands-free mobile phone, an optional BLUETOOTH INTERFACE (KCE-400BT) connection is required. For details on connection, refer to the Owner's Manual of the BLUETOOTH INTERFACE (KCE-400BT). You can also connect this to an external device (such as a portable player) by using conversion cable (KCE-237B) for building up the AUX IN (sold separately).

• *Refer to "Setting the AUX+ Mode" (page 55).*
AUX+ ON: When the external device is connected.
AUX+ OFF: When set to OFF, AUX+ source cannot be selected.
- ㉓ **USB Connector**
- ㉔ **AUX I/O Connector**
- ㉕ **RCA Output/Input Connector**
- ㉖ **System Switch**
When connecting an IMPRINT Audio Processor (PXA-H100) or divider using Ai-NET feature, place the two switches in the EQ/DIV position. When no device is connected, leave the switches in the NORM position.

• *Do not make the two switches to different settings.*
• *Be sure to turn the power off to the unit before changing the switch position.*
- ㉗ **Power Supply Connector**
- ㉘ **KCE-400BT Connection Cable (Included with KCE-400BT)**
- ㉙ **Ai-NET Cable (Included with CD Changer)**
- ㉚ **Remote Turn-On Lead (Blue/White)**
Connect this lead to the remote turn-on lead of your amplifier or signal processor.
- ㉛ **Power Antenna Lead (Blue)**
Connect this lead to the +B terminal of your power antenna, if applicable.

• *This lead should be used only for controlling the vehicle's power antenna. Do not use this lead to turn on an amplifier or a signal processor, etc.*
- ㉜ **Audio Interrupt In Lead (Pink/Black)**
- ㉝ **Parking Brake Lead (Yellow/Blue)**
Connect this lead to the power supply side of the parking brake switch to transmit the parking brake status signals to the INA-W900.
- ㉞ **Foot Brake Lead (Yellow/Black)**
Connect to the vehicle's foot brake lead or brake lamp lead.
- ㉟ **Switched Power Lead (Ignition) (Red)**
Connect this lead to an open terminal on the vehicle's fuse box or another unused power source which provides (+) 12V only when the ignition is turned on or in the accessory position.
- ㊱ **Battery Lead (Yellow)**
Connect this lead to the positive (+) post of the vehicle's battery.
- ㊲ **Fuse Holder (10A)**

- ③⑧ **Ground Lead (Black)**
Connect this lead to a good chassis ground on the vehicle.
Make sure the connection is made to bare metal and is
securely fastened using the sheet metal screw provided.
- ③⑨ **Right Front (+) Speaker Output Lead (Gray)**
- ④⑩ **Right Front (-) Speaker Output Lead (Gray/Black)**
- ④① **Right Rear (-) Speaker Output Lead (Violet/Black)**
- ④② **Right Rear (+) Speaker Output Lead (Violet)**
- ④③ **Left Rear (+) Speaker Output Lead (Green)**
- ④④ **Left Rear (-) Speaker Output Lead (Green/Black)**
- ④⑤ **Left Front (-) Speaker Output Lead (White/Black)**
- ④⑥ **Left Front (+) Speaker Output Lead (White)**
- ④⑦ **USB extension cable (Included)**
- ④⑧ **AV extension cable (Included)**
- ④⑨ **USB 30P cable (Included)**

System Example

Connect the Ai-NET compatible Imprint audio processor (PXA-H100) DVD player and changer.

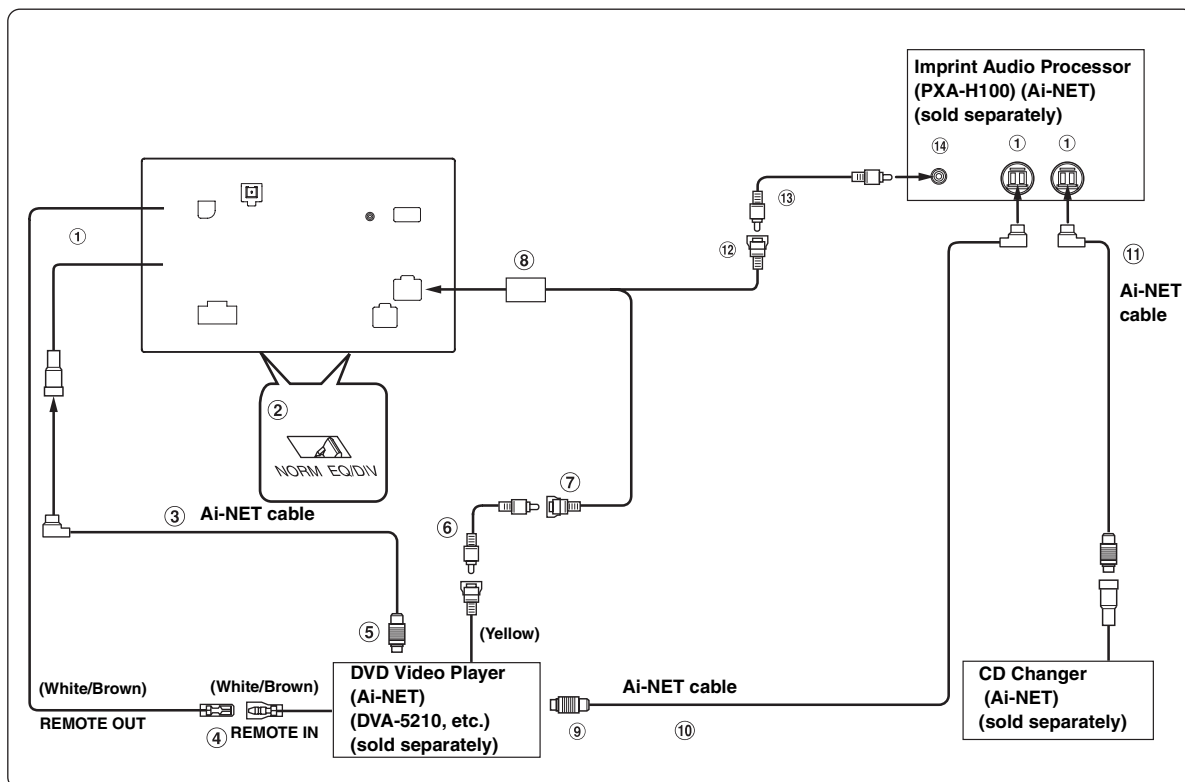

- ① **Ai-NET Connector**
Connect this to the output or input connector of other product equipped with Ai-NET.
- ② **System Switch**
When connecting an IMPRINT audio processor or divider using Ai-NET feature, place the two switches in the EQ/DIV position. When no device is connected, leave the switches in the NORM position.
 - Do not make the two switches to different settings.
 - Be sure to turn the power off to the unit before changing the switch position.
- ③ **Ai-NET Cable (Included with DVD video player)**
- ④ **Remote Control Output Lead (White/Brown)**
Connect this lead to the remote control input lead. This lead outputs the controlling signals from the remote control.
- ⑤ **To Ai-NET Connector (Gray)**
- ⑥ **RCA Extension Cable (Included with DVD video player)**
- ⑦ **Video Input Connector (AUX INPUT) (Yellow)**
Connect the video output lead of a DVD video player or DVD changer to this terminal.
- ⑧ **AUX I/O Connector**
- ⑨ **To Ai-NET Connector (Black)**
- ⑩ **Ai-NET Cable (Included with IMPRINT Audio Processor (PXA-H100))**
- ⑪ **Ai-NET Cable (Included with CD Changer)**
- ⑫ **Guide Connector (Yellow)**
Output the audio signal of navigation interruption.
- ⑬ **RCA Extension Cable (sold separately)**
- ⑭ **Guide Input terminal**

When Connecting External Equipment

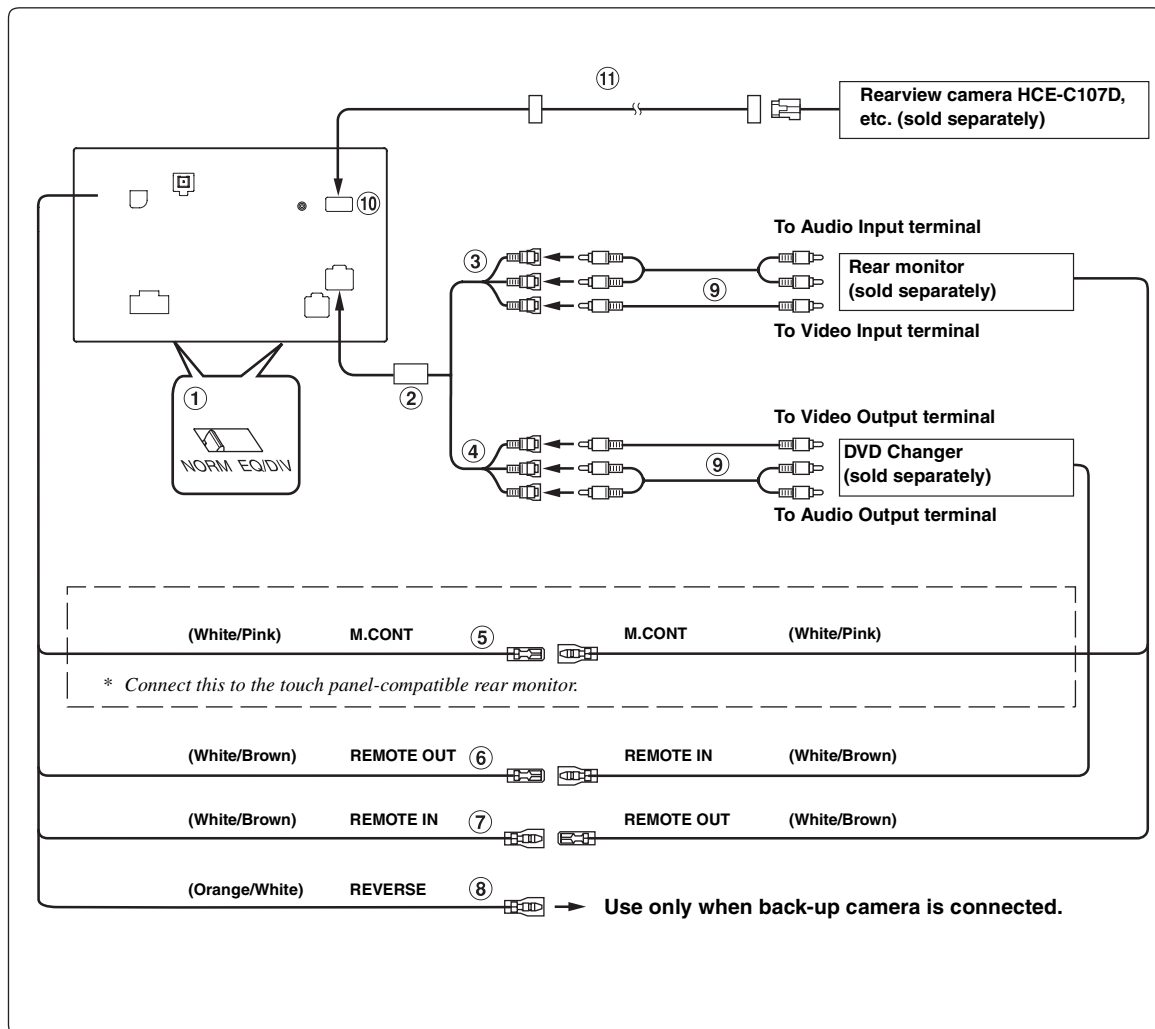

① System Switch

When connecting an IMPRINT audio processor or divider using Ai-NET feature, place the two switches in the EQ/DIV position. When no device is connected, leave the switches in the NORM position.

- Do not make the two switches to different settings.
- Be sure to turn the power off to the unit before changing the switch position.

② AUX I/O Camera In Connector

③ Video/Audio Output Connectors (AUX OUTPUT)

Use when connecting an optional monitor etc.

④ Video/Audio Input Connectors (AUX INPUT)

⑤ Monitor Control Lead (White/Pink)

Connect this to the Monitor Control Lead of the touch panel-compatible rear monitor.

⑥ Remote Control Output Lead (White/Brown)

Connect this lead to the remote control input lead. This lead outputs the controlling signals from the remote control.

⑦ Remote Control Input Lead (White/Brown)

⑧ Reverse Lead (Orange/White)

Use only when a back-up camera is connected. Connect to the plus side of the car's reverse lamp. This lamp illuminates when the transmission is shifted into reverse (R). With this lead properly wired, the video picture automatically switches to the back-up camera whenever the car is put into reverse (R).

⑨ RCA Extension Cable (sold separately)

⑩ Direct CAMERA Input Connector

Use when the optional rearview camera HCE-C107D, etc. is connected.

⑪ Camera extension cable (Included with Rear camera)



LIMITED WARRANTY

ALPINE ELECTRONICS OF AMERICA, INC. AND ALPINE OF CANADA INC. ("Alpine"), are dedicated to quality craftsmanship and are pleased to offer this Warranty. We suggest that you read it thoroughly. Should you have any questions, please contact your Dealer or contact Alpine at one of the telephone numbers listed below.

● PRODUCTS COVERED:

This Warranty covers Car Audio Products and Related Accessories ("the product"). Products purchased in the Canada are covered only in the Canada. Products purchased in the U.S.A. are covered only in the U.S.A.

● LENGTH OF WARRANTY:

This Warranty is in effect for one year from the date of the first consumer purchase.

● WHO IS COVERED:

This Warranty only covers the original purchaser of the product, who must reside in the United States, Puerto Rico or Canada.

● WHAT IS COVERED:

This Warranty covers defects in materials or workmanship (parts and labor) in the product.

● WHAT IS NOT COVERED:

This Warranty does not cover the following:

- ① Damage occurring during shipment of the product to Alpine for repair (claims must be presented to the carrier).
- ② Damage caused by accident or abuse, including burned voice coils caused by over-driving the speaker (amplifier level is turned up and driven into distortion or clipping). Speaker mechanical failure (e.g. punctures, tears or rips). Cracked or damaged LCD panels. Dropped or damaged hard drives.
- ③ Damage caused by negligence, misuse, improper operation or failure to follow instructions contained in the Owner's manual.
- ④ Damage caused by act of God, including without limitation, earthquake, fire, flood, storms or other acts of nature. Any cost or expense related to the removal or reinstallation of the product.
- ⑤ Service performed by an unauthorized person, company or association.
- ⑥ Any product which has the serial number defaced, altered or removed.
- ⑦ Any product which has been adjusted, altered or modified without Alpine's consent.
- ⑧ Any product not distributed by Alpine within the United States, Puerto Rico or Canada.
- ⑨ Any product not purchased from an Authorized Alpine Dealer.

● HOW TO OBTAIN WARRANTY SERVICE:

- ① You are responsible for delivery of the product to an Authorized Alpine Service Center or Alpine for repair and for payment of any initial shipping charges. Alpine will, at its option, repair or replace the product with a new or reconditioned product without charge. If the repairs are covered by the warranty, and if the product was shipped to an Authorized Alpine Service Center or Alpine, Alpine will pay the return shipping charges.
- ② You should provide a detailed description of the problem(s) for which service is required.

- ③ You must supply proof of your purchase of the product.
- ④ You must package the product securely to avoid damage during shipment. To prevent lost packages it is recommended to use a carrier that provides a tracking service.

● HOW WE LIMIT IMPLIED WARRANTIES:

ANY IMPLIED WARRANTIES INCLUDING FITNESS FOR USE AND MERCHANTABILITY ARE LIMITED IN DURATION TO THE PERIOD OF THE EXPRESS WARRANTY SET FORTH ABOVE AND NO PERSON IS AUTHORIZED TO ASSUME FOR ALPINE ANY OTHER LIABILITY IN CONNECTION WITH THE SALE OF THE PRODUCT.

● HOW WE EXCLUDE CERTAIN DAMAGES:

ALPINE EXPRESSLY DISCLAIMS LIABILITY FOR INCIDENTAL AND CONSEQUENTIAL DAMAGES CAUSED BY THE PRODUCT. THE TERM "INCIDENTAL DAMAGES" REFERS TO EXPENSES OF TRANSPORTING THE PRODUCT TO THE ALPINE SERVICE CENTER, LOSS OF THE ORIGINAL PURCHASER'S TIME, LOSS OF THE USE OF THE PRODUCT, BUS FARES, CAR RENTALS OR OTHERS COSTS RELATING TO THE CARE AND CUSTODY OF THE PRODUCT. THE TERM "CONSEQUENTIAL DAMAGES" REFERS TO THE COST OF REPAIRING OR REPLACING OTHER PROPERTY WHICH IS DAMAGED WHEN THIS PRODUCT DOES NOT WORK PROPERLY. THE REMEDIES PROVIDED UNDER THIS WARRANTY ARE EXCLUSIVE AND IN LIEU OF ALL OTHERS.

● HOW STATE/PROVINCIAL LAW RELATES TO THE WARRANTY:

This Warranty gives you specific legal rights, and you may also have other rights which vary from state to state and province to province. In addition, some states/provinces do not allow limitations on how long an implied warranty lasts, and some do not allow the exclusion or limitation of incidental or consequential damages. Accordingly, limitations as to these matters contained herein may not apply to you.

● IN CANADA ONLY:

This Warranty is not valid unless your Alpine car audio product has been installed in your vehicle by an Authorized Installation Center, and this warranty stamped upon installation by the installation center.

● HOW TO CONTACT CUSTOMER SERVICE:

Should the product require service, please call the following number for your nearest Authorized Alpine Service Center.

CAR AUDIO	1-800-ALPINE-1 (1-800-257-4631)
NAVIGATION	1-888-NAV-HELP (1-888-628-4357)

Or visit our website at: <http://www.alpine-usa.com>

ALPINE ELECTRONICS OF AMERICA, INC., 19145 Gramercy Place, Torrance, California 90501, U.S.A.

ALPINE ELECTRONICS OF CANADA, INC., 777 Supertest Road, Toronto, Ontario M3J 2M9, Canada

Do not send products to these addresses.

Call the toll free telephone number or visit the website to locate a service center.