

FOR CAR USE ONLY/NUR FÜR AUTOMOBIL GEBRAUCH/POUR APPLICATION AUTOMOBILE UNIQUEMENT/PARA USO EN AUTOMÓVILES/SOLO PER L'UTILIZZO IN AUTOMOBILE/ENDAST FÖR BILBRUK/ALLEEN VOOR GEBRUIK IN DE AUTO/ТОЛЬКО ДЛЯ ИСПОЛЬЗОВАНИЯ В АВТОМОБИЛЯХ/DO UŻYCIA TYLKO W SAMOCHODZIE/ΓΙΑ ΧΡΗΣΗ ΜΟΝΟ ΣΕ ΑΥΤΟΚΙΝΗΤΟ



## Mobile Media Station IVE-W530BT



- **OWNER'S MANUAL**  
Please read before using this equipment.
- **BEDIENUNGSANLEITUNG**  
Lesen Sie diese Bedienungsanleitung bitte vor Gebrauch des Gerätes.
- **MODE D'EMPLOI**  
Veuillez lire avant d'utiliser cet appareil.
- **MANUAL DE OPERACIÓN**  
Léalo antes de utilizar este equipo.
- **ISTRUZIONI PER L'USO**  
Si prega di leggere prima di utilizzare il attrezzatura.
- **ANVÄNDARHANDLEDNING**  
Innan du använder utrustningen bör du läsa igenom denna användarhandledning.
- **GEBRUIKERSHANDLEIDING**  
Lees deze aanwijzingen aandachtig alvorens dit toestel te gebruiken.
- **РУКОВОДСТВО ПО ЭКСПЛУАТАЦИИ**  
Прочтите настоящее руководство перед началом использования оборудования.
- **INSTRUKCJA OBSŁUGI**  
Prosimy zapoznać się z tą instrukcją przed przystąpieniem do użytkowania urządzenia.
- **ΕΓΧΕΙΡΙΔΙΟ ΧΡΗΣΤΗ**  
Παρακαλούμε διαβάστε το πριν χρησιμοποιήσετε τη συσκευή.

**ALPINE ELECTRONICS MARKETING, INC.**  
1-7, Yukigaya-Otsukamachi, Ota-ku,  
Tokyo 145-0067, JAPAN  
Phone: 03-5499-4531

**ALPINE ELECTRONICS OF AMERICA, INC.**  
19145 Gramercy Place, Torrance,  
California 90501, U.S.A.  
Phone 1-800-ALPINE-1 (1-800-257-4631)

**ALPINE ELECTRONICS OF CANADA, INC.**  
777 Superstest Road, Toronto,  
Ontario M3J 2M9, Canada  
Phone 1-800-ALPINE-1 (1-800-257-4631)

**ALPINE ELECTRONICS OF AUSTRALIA PTY. LTD.**  
161-165 Princes Highway, Hallam  
Victoria 3803, Australia  
Phone 03-8787-1200

**ALPINE ELECTRONICS GmbH**  
Wilhelm-Wagenfeld-Str. 1-3, 80807 München, Germany  
Phone 089-32 42 640

**ALPINE ELECTRONICS OF U.K. LTD.**  
Alpine House  
Fletchamstead Highway, Coventry CV4 9TW, U.K.  
Phone 0870-33 33 763

**ALPINE ELECTRONICS FRANCE S.A.R.L.**  
(RCS PONTOISE B 338 101 280)  
98, Rue de la Belle Etoile, Z.I. Paris Nord II,  
B.P. 50016, 95945 Roissy Charles de Gaulle  
Cedex, France  
Phone 01-48638989

**ALPINE ITALIA S.p.A.**  
Viale C. Colombo 8, 20090 Trezzano  
Sul Naviglio (MI), Italy  
Phone 02-484781

**ALPINE ELECTRONICS DE ESPAÑA, S.A.**  
Portal de Gamarra 36, Pabellón, 32  
01013 Vitoria (Alava)-APDO 133, Spain  
Phone 945-283588

**ALPINE ELECTRONICS (BENELUX) GmbH**  
Leuvensesteenweg 510-B6,  
1930 Zaventem, Belgium  
Phone 02-725-13 15

EN

DE

FR

ES

IT

SE

NL

RU

PL

GR



# Contents

## Operating Instructions

### WARNING

<b>WARNING</b> .....	<b>6</b>
<b>CAUTION</b> .....	<b>6</b>
<b>PRECAUTIONS</b> .....	<b>7</b>
<b>Discs Playable on This Unit</b> .....	<b>8</b>

### Getting Started

Accessory List .....	12
Location of Controls .....	12
Turning Power On or Off .....	13
Adjusting the Volume .....	13
Lowering Volume Quickly .....	13
How to view the Display .....	13
TOUCH PANEL operation .....	13
Recalling the Source .....	13
Displaying the Numeric Keypad Input Screen .....	14

### Radio

Listening to the Radio .....	15
Presetting Stations Manually .....	15
Presetting Stations Automatically .....	15
Tuning to Preset Stations .....	15

### RDS Operation

Turning AF (Alternative Frequencies) On or Off .....	16
Receiving Traffic Information .....	16
PTY (Programme Type) Tuning .....	16
Receiving Traffic Information While Playing CD or Radio .....	17
Priority News .....	17
Displaying Radio Text .....	17

### CD/MP3/WMA/AAC

Playback .....	18
Repeat Play .....	18
M.I.X. (Random Play) .....	19
Selecting Folders (concerning MP3/WMA/AAC) .....	19

About MP3/WMA/AAC .....	19
-------------------------	----

### DVD

Playing a Disc .....	21
To display the DVD mode screen .....	21
If a menu screen appears .....	22
Displaying the Top Menu Screen .....	23
Displaying the Menu Screen .....	23
Displaying the Menu Operation Mode Screen .....	23
Numeric Keypad Input Operation .....	23
Select a Track/File/Chapter .....	23
Select a Folder/Title .....	23
Stopping Playback (Pre Stop) .....	24
Stopping Playback .....	24
Fast-forwarding/Fast-reversing .....	24
Finding the Beginnings of Chapters/Files .....	24
Playing Still Frames (Pausing) .....	24
Slow Motion Playback .....	24
Selecting Folders .....	25
Repeat Playback .....	25
Searching by Title/Folder Number .....	25
Searching Directly by Chapter, File Number .....	25
Switching the Angle .....	26
Switching the Audio Tracks .....	26
Switching the Subtitles (Subtitle Language) .....	26
Switching from the disc menu .....	26
About DivX .....	27

### Other Useful Features

Adjusting the Audio .....	27
Search Function .....	29
Rear Selection Function .....	29
Switching Display Modes .....	30
Switching the Visual Source Only (Simultaneous Function) .....	30
Cancelling the Simultaneous Function .....	30
Blackout Mode On and Off .....	30

# Setup

<b>DVD Setup</b>	
DVD Setup Operation .....	31
Changing the language setting .....	31
Setting of the Menu Language .....	31
Setting of the Audio Language .....	31
Setting of the Subtitle Language .....	32
Setting the Downmix Mode .....	32
Setting the TV Screen .....	32
Setting the DOLBY Dynamic Range .....	32
Displaying DivX® Disc Information .....	32
<b>Source Setup</b>	
Source Setup Operation .....	33
Radio Setup .....	33
<b>Display Setup</b>	
Display Setup Operation .....	34
Setting the Brightness of the Backlighting .....	34
Adjusting the Minimum Level of Backlight .....	34
Turn the Function Guide ON/OFF (Function Guide Fade) .....	35
Switching the Font Background Colour .....	35
Adjusting the Touch Panel .....	35
Setting the VISUAL Button .....	35
<b>Visual EQ™</b>	
Visual EQ Setting Operation .....	35
Selecting the Visual EQ Mode (Factory's setting) .....	36
Adjusting Brightness .....	36
Adjusting Colour of Picture .....	36
Adjusting Tint of Picture .....	36
Adjusting Image Contrast .....	36
Adjusting Picture Quality .....	36
Storing Visual EQ .....	36
<b>General Setup</b>	
General Setup Operation .....	37
Displaying the Time .....	37
Setting the Clock Display .....	37
Setting the Time .....	37
Setting Summer Time .....	37
Demonstration Function .....	37
Sound (Beep) Guide Function .....	37
Setting the Beep Level .....	38
Setting the Scroll .....	38
Changing the Russian Font .....	38
Adjusting the Dimmer of Button Lighting at Night .....	38

Setting Security code .....	38
-----------------------------	----

<b>System Setup</b>	
System Setup Operation .....	39
Setting the Rear Camera Input .....	39
Setting the Navigation Mode .....	40
Setting the Navigation Interruption .....	40
Setting the AUX Mode .....	40
Setting the AUX Front Mode .....	41
Setting the Picture/Sound Output .....	41
Setting the BLUETOOTH Connection (BLUETOOTH IN) .....	41
Changing the Lighting Colour of Buttons .....	41
<b>BT Hands Free Calling</b>	
Setup Before Using .....	42
About BLUETOOTH .....	42
Before Using Hands-Free Function .....	42
How to connect to a BLUETOOTH compatible device (Pairing) .....	42
BLUETOOTH Setup .....	43
BLUETOOTH Setup Operation .....	43
Hands-Free Phone Control .....	44
About the Hands-Free Phone .....	44
Answering a Call .....	45
Hanging up the Telephone .....	45
Adjusting the volume when receiving a Call .....	45
Redial Function .....	45
Call waiting function .....	45
Call Switching Operation .....	46
Call History .....	46
Redialing a Number in Dialed Calls History .....	46
Dialing a Number in Received Calls History .....	46
Dialing a Number in Missed Calls History .....	46
Dialing a Number In the Phone Book (Phone Book) .....	47
Dialing a Number Using Direct Dial Input .....	48
Voice Dial Operation .....	48
BLUETOOTH Audio Function .....	48
BLUETOOTH Audio Operation .....	48
<b>Rearview Camera Operation (Optional)</b>	
Switching the Rear Camera Screen (Optional) .....	49

Displaying the rear view video while the car is in reverse .....	49
Displaying the rear view video manually .....	49
<b>Navigation System (Optional)</b>	
Switching the Navigation Screen (Optional) .....	49
<b>Auxiliary Device (Optional)</b>	
Operating Auxiliary Devices (Optional) .....	50
<b>TUE-T200DVB Operation (Optional)</b>	
Operating the TUE-T200DVB (Optional) .....	50
<b>USB Memory (Optional)</b>	
BANK Function .....	51
Playback .....	52
Repeat Play .....	52
Random Play Shuffle (M.I.X.) .....	52
Searching for a desired Song .....	53
Searching by Playlist name .....	53
Selecting the desired Playlist .....	53
Select the desired Folder (Folder up/down) .....	53
<b>iPod/iPhone (Optional)</b>	
Connecting an iPod/iPhone .....	54
Setting the iPod Control .....	54
Playback .....	54
Searching for a desired Song .....	55
Searching by artist name .....	55
Selecting Playlist/Artist/Album/Genre/ Composer/Episode/Category .....	55
Random Play Shuffle (M.I.X.) .....	56
Repeat Play .....	56
<b>Information</b>	
About DVDs .....	56
List of Language Codes .....	57
In Case of Difficulty .....	58
Specifications .....	62

---

# Installation and Connections

<b>Warning</b> .....	<b>63</b>
<b>Caution</b> .....	<b>63</b>
<b>Precautions</b> .....	<b>63</b>
Installation .....	64
Mounting the Microphone .....	65
Connections .....	67
System Example .....	69

---

---

# Operating Instructions

## WARNING



**This symbol means important instructions. Failure to heed them can result in serious injury or death.**

---

### **INSTALL THE PRODUCT CORRECTLY SO THAT THE DRIVER CANNOT WATCH TV/VIDEO UNLESS THE VEHICLE IS STOPPED AND THE EMERGENCY BRAKE IS APPLIED.**

It is dangerous for the driver to watch TV/Video while driving a vehicle. Installing this product incorrectly enables the driver to watch TV/Video while driving. This may cause a distraction, preventing the driver from looking ahead, thus causing an accident. The driver or other people could be severely injured.

---

### **DO NOT WATCH VIDEO WHILE DRIVING.**

Watching the video may distract the driver from looking ahead of the vehicle and cause an accident.

---

### **DO NOT OPERATE ANY FUNCTION THAT TAKES YOUR ATTENTION AWAY FROM SAFELY DRIVING YOUR VEHICLE.**

Any function that requires your prolonged attention should only be performed after coming to a complete stop. Always stop the vehicle in a safe location before performing these functions. Failure to do so may result in an accident.

---

### **KEEP THE VOLUME AT A LEVEL WHERE YOU CAN STILL HEAR OUTSIDE NOISES WHILE DRIVING.**

Excessive volume levels that obscure sounds such as emergency vehicle sirens or road warning signals (train crossings, etc.) can be dangerous and may result in an accident. LISTENING AT LOUD VOLUME LEVELS IN A CAR MAY ALSO CAUSE HEARING DAMAGE.

---

### **MINIMIZE DISPLAY VIEWING WHILE DRIVING.**

Viewing the display may distract the driver from looking ahead of the vehicle and cause an accident.

---

### **DO NOT DISASSEMBLE OR ALTER.**

Doing so may result in an accident, fire or electric shock.

---

### **USE ONLY IN CARS WITH A 12 VOLT NEGATIVE GROUND.**

(Check with your dealer if you are not sure.) Failure to do so may result in fire, etc.

---

### **KEEP SMALL OBJECTS SUCH AS BOLTS OR SCREWS OUT OF THE REACH OF CHILDREN.**

Swallowing them may result in serious injury. If swallowed, consult a physician immediately.

---

### **USE THE CORRECT AMPERE RATING WHEN REPLACING FUSES.**

Failure to do so may result in fire or electric shock.

---

### **DO NOT BLOCK VENTS OR RADIATOR PANELS.**

Doing so may cause heat to build up inside and may result in fire.

---

### **USE THIS PRODUCT FOR MOBILE 12V APPLICATIONS.**

Use for other than its designed application may result in fire, electric shock or other injury.

---

### **DO NOT PLACE HANDS, FINGERS OR FOREIGN OBJECTS IN INSERTION SLOTS OR GAPS.**

Doing so may result in personal injury or damage to the product.



**This symbol means important instructions. Failure to heed them can result in injury or material property damage.**

---

### **HALT USE IMMEDIATELY IF A PROBLEM APPEARS.**

Failure to do so may cause personal injury or damage to the product. Return it to your authorized Alpine dealer or the nearest Alpine Service Centre for repairing.

# PRECAUTIONS

## Product Cleaning

Use a soft dry cloth for periodic cleaning of the product. For more severe stains, please dampen the cloth with water only. Anything else has the chance of dissolving the paint or damaging the plastic.

## Temperature

Be sure the temperature inside the vehicle is between +45°C (+113°F) and 0°C (+32°F) before turning your unit on.

## Moisture Condensation

You may notice the disc playback sound wavering due to condensation. If this happens, remove the disc from the player and wait about an hour for the moisture to evaporate.

## Damaged Disc

Do not attempt to play cracked, warped, or damaged discs. Playing a bad disc could severely damage the playback mechanism.

## Maintenance

If you have problems, do not attempt to repair the unit yourself. Return it to your Alpine dealer or the nearest Alpine Service Station for servicing.

## Never Attempt the Following

Do not grip or pull out the disc while it is being pulled back into the player by the automatic reloading mechanism.

Do not attempt to insert a disc into the unit when the unit power is off.



## Inserting Discs

Your player accepts only one disc at a time for playback. Do not attempt to load more than one disc.

Make sure the label side is facing up when you insert the disc. "Disc Error" will be displayed on your player if you insert a disc incorrectly.

Playing a disc while driving on a very bumpy road may result in skips, but this will not scratch the disc or damage the player.

## Irregular Shaped Discs

Be sure to use round shaped discs only for this unit and never use any special shaped discs.

Use of special shaped discs may cause damage to the mechanism.



## New Discs

To prevent the CD from jamming, "Disc Error" is displayed if discs with irregular surfaces are inserted or if discs are inserted incorrectly. When a new disc is ejected immediately after initial loading, use your finger to feel around the inside of the centre hole and outside edge of the disc. If you feel any small bumps or irregularities, this could inhibit proper loading of the disc. To remove the bumps, rub the inside edge of the hole and outside edge of the disc with a ballpoint pen or other such instrument, then insert the disc again.

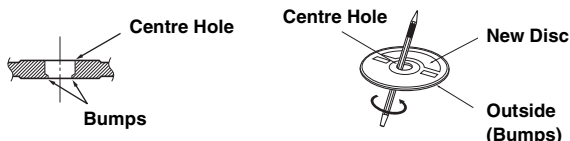

## Installation Location

Make sure the IVE-W530BT will not be installed in a location subjected to:

- Direct sun and heat
- High humidity and water
- Excessive dust
- Excessive vibrations

## Correct Handling

Do not drop the disc while handling. Hold the disc so you will not leave fingerprints on the surface. Do not affix tape, paper, or gummed labels to the disc. Do not write on the disc.

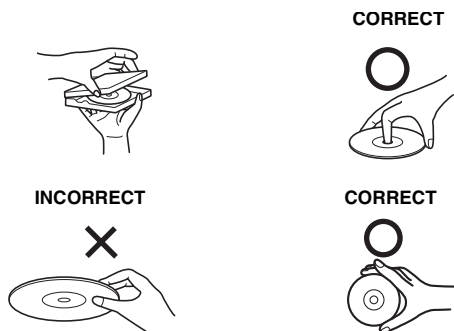

## Disc Cleaning

Fingerprints, dust, or soil on the surface of the disc could cause the DVD player to skip. For routine cleaning, wipe the playing surface with a clean, soft cloth from the centre of the disc to the outer edge. If the surface is heavily soiled, dampen a clean, soft cloth in a solution of mild neutral detergent before cleaning the disc.



## Disc Accessories

There are various accessories available on the market for protecting the disc surface and improving sound quality. However, most of them will influence the thickness and/or diameter of the disc. Using such accessories can cause the disc to be out of standard specifications and may create operational problems. We recommend not using these accessories on discs played in Alpine DVD players.

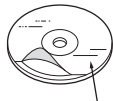

Transparent Sheet

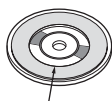

Disc Stabilizer

## Handling the Detachable Front Panel

- Do not expose to rain or water.
  - Do not drop or subject to shock.
- 
- After turning the system off, a slight ghost of the image will remain temporarily. This is an effect peculiar to LCD technology and is normal.
  - In cold temperature conditions, the screen may lose contrast temporarily. After a short warm-up period, it will return to normal.

Operation of some of the functions of this unit is very complex. Because of this, it was deemed necessary to place these functions into a special screen. This will restrict operation of these functions to times when the vehicle is parked. This ensures the focus of the driver's attention will be on the road and not on the IVE-W530BT. This has been done for the safety of the driver and passengers. The car must be parked and the parking brake must be engaged for the procedure described in the Owner's Manual to be valid. The warning "Can't operate while driving", will be displayed if any attempts are made to perform these operations while driving.

- The IVE-W530BT draws minimal current even when its power switch is turned off. If the switched power (ignition) lead of the IVE-W530BT is connected directly to the positive (+) post of the vehicle's battery, the battery may be discharged. An SPST (Single-Pole, Single-Throw) switch (sold separately) can be added to simplify this procedure. Then, you can simply place it in the OFF position when you leave the vehicle. Turn the SPST switch back ON before using the IVE-W530BT. For connecting the SPST switch, refer to the "Connection Diagram of SPST Switch (Sold Separately)" (page 66). If the power (ignition) lead is unswitched, it must be disconnected from the battery post should the vehicle be left unused for an extended period of time.

## Discs Playable on This Unit

### Playable discs

The discs listed below can be played on this unit.

	Mark (logo)	Recorded content	Disc size
DVD Video		Audio + Video	12 cm*
Music CD		Audio	12 cm
DivX®		Audio + Video	12 cm

\* Two-layer DVD disc compatible

The formatted discs listed below can be played on this unit.

	CD-R/ CD-RW	DVD-R/ DVD-RW	DVD+R/ DVD+RW
CD Format	○		
MP3 Format ("mp3")	○	○	○
WMA Format ("wma")	○	○	○
AAC Format ("mp4", "m4a")	○	○	○
DVD Video Format		○	○
DivX Format ("avi", "div", "divx")	○	○	○

Discs that are not finalised cannot be played back



---

## Discs that cannot be played

DVD-ROMs, DVD-RAMs, CD-ROMs (excluding MP3/WMA/AAC files), photo CDs, etc.

---

## DualDisc

This unit is not compatible with DualDisc.

Using a DualDisc may cause unit malfunction, and may cause disc damage when the disc is inserted/ejected.

---

## DVD region number (playable region number)

This DVD player will play back any disc whose region number is 2 (or All). DVDs with a region number other than those listed below, cannot be played on this DVD player.



---

## Using compact discs (CD/CD-R/CD-RW)

If you use unspecified compact discs, correct performance cannot be guaranteed.

You can play CD-Rs (CD-Recordable)/CD-RWs (CD-ReWritable) which have been recorded only on audio devices. You can also play CD-Rs/CD-RWs containing MP3/WMA/AAC formatted audio files.

- Some of the following discs may not play on this unit:  
Flawed discs, discs with fingerprints, discs exposed to extreme temperatures or sunlight (e.g., left in the car or this unit), discs recorded under unstable conditions, discs on which a recording failed or a re-recording was attempted, copy-protected CDs which do not conform to the audio CD industry standard.
- Use discs with MP3/WMA/AAC files written in a format compliant with this unit. For details, see pages 19 and 20.

To customers using CD-R/CD-RW

- If a CD-R/CD-RW cannot be played back, make sure the last recording session was closed (finalised).
- Finalise the CD-R/CD-RW if necessary, and attempt playback again.

---

## Tips for making your own CDs

The IVE-W530BT plays DVD Video, Audio CD, DivX® and has a built in MP3/WMA/AAC decoder.

The following information is designed to help you create your own music CDs (either Audio CD or MP3/WMA/AAC encoded CD-R/RW files).

### What is the difference between an Audio and MP3/WMA/AAC CD?

An Audio CD is the same format as the commercial CDs you buy in the store (also known as CD-DA). MP3 (MPEG-1 Audio Layer 3)/WMA (Windows Media Audio)/AAC (Advanced Audio Coding) is a data file that uses a compression scheme to reduce the size of the music file.\*

### Hybrid Audio CD and Data (MP3/WMA/AAC) CD-R/RW discs:

The IVE-W530BT can only read CD-DA sector on the disc.\*

### Multi-session CD-R/RW:

Once a recording has been stopped, this is considered one session. If the disc is not closed (finalised), additional data may be added. Once this additional data has been recorded, this becomes a “multi-session” CD. The IVE-W530BT can only read multi-session DATA Formatted discs (MP3/WMA/AAC files - Not Audio CD files).

### Properly formatted MP3/WMA/AAC Discs:

Use ISO9660 formatting to insure proper playback. You may use standard ISO naming Level 1 (8.3 DOS standard), Level 2 (32 characters) or Joliet (Windows or Macintosh long filenames) file naming conventions\*.

\* Please consult the Owner’s manual for additional information.

---

## On handling compact discs (CD/CD-R/CD-RW)

- Do not touch the surface.
- Do not expose the disc to direct sunlight.
- Do not affix stickers or labels.
- Clean the disc when it is dusty.
- Make sure that the disc is smooth and flat.
- Do not use commercially available disc accessories.

### Do not leave the disc in the car or the unit for a long time. Never expose the disc to direct sunlight.

Heat and humidity may damage the disc and you may not be able to play it again.

---

---

## Using DVD-Rs/DVD-RWs/DVD+Rs/DVD+RWs

- This unit is compatible with discs recorded in the standard DVD-Video (DVD-R/DVD-RW only) formats.
- Note that discs not finalised (processed to enable to play on playback-only DVD players) cannot be played on this DVD player.
- Some discs may not play back, depending on the recording device and disc format.
- Discs or files utilizing copy protection, may not be playable. Some recording systems may not properly format copied files to enable proper playback.
- In the following cases, the disc may not play on this unit: discs recorded by certain DVD recorders, certain irregular discs, flawed discs, dirty discs, when the pickup lens of this DVD player is dirty, or when moisture condensation has occurred inside the unit.
- Be sure to follow all cautions included with your DVD-Rs/DVD-RWs/DVD+Rs/DVD+RWs discs.
- Do not put stickers, seals, or tape on the label side of DVD-Rs/DVD-RWs/DVD+Rs/DVD+RWs.
- Compared to the regular discs, DVD-Rs/DVD-RWs/DVD+Rs/DVD+RWs are more affected by heat, moisture, and direct sunlight. If left in a car, etc., damage may occur and it might not play on this unit.
- The operable temperature range for disc playback is as follows:  
DVD-R/DVD-RW: -25 ~ +70°C  
DVD+R/DVD+RW: +5 ~ +55°C

---

## Disc terminology

### Title

If titles are programmed for the DVD, these are the largest units of division of the information recorded on the disc.

### Chapter

Each Title may also be divided into smaller divisions, called chapters. These can be specific scenes or musical selections.

---

## Protecting the USB connector

- Only an iPod/iPhone or USB memory can be connected to the USB connector on this unit. Correct performance using other USB products cannot be guaranteed.
- If the USB connector is used, be sure to use only the supplied connector cable with the unit. A USB hub is not supported.
- Depending on the connected USB memory device, the unit may not function or some functions may not be performed.
- The audio file format that can be played back on the unit is MP3/WMA/AAC.
- Artist/song name, etc., can be displayed, however characters may not be correctly displayed.



## CAUTION

*Alpine accepts no responsibility for lost data, etc., even if data, etc., is lost while using this product.*

---

## On Handling USB Memory

- This unit can control a memory storage device that supports the USB Mass Storage Class (MSC) protocol. Playable audio file formats are MP3, WMA and AAC.
- USB memory function is not guaranteed. Use USB memory according to the terms of agreement. Read the USB memory Owner's Manual thoroughly.
- Fix the USB memory in a location where driver operation will not be hindered.
- USB memory may not function correctly at high or low temperature.
- Use only certified USB memory. Note that even certified USB memory, may not function correctly depending on its type or state.
- Depending on the settings of the USB memory type, memory state or encoding software, the unit may not play back or display properly.
- Files protected by DRM (Digital Rights Management), cannot be played back on this unit. These include AAC formatted files purchased from the iTunes Store and WMA or other files with some form of copyright protection.
- USB memory may take time to start playback. If there is a particular file other than audio in the USB memory, it may take considerable time before the file is played back or searched.
- The unit can play back "mp3", "wma", "m4a" or "divx" file extensions.
- Do not add the above extensions to a file other than audio data. This non-audio data will not be recognised. The resulting playback may contain noise that can damage speakers and/or amplifiers.
- It is recommended to back up important data on a personal computer.
- Do not remove the USB device while playback is in progress. Change SOURCE to something other than USB, then remove the USB device to prevent possible damage to its memory.

- *This item incorporates copy protection technology that is protected by U.S. patents and other intellectual property rights of Rovi Corporation. Reverse engineering and disassembly are prohibited.*
- *Manufactured under license from Dolby Laboratories. Dolby and the double-D symbol are trademarks of Dolby Laboratories.*
- *Windows Media and the Windows logo are trademarks, or registered trademarks of Microsoft Corporation in the United States and/or other countries.*
- *iPhone, iPod, iPod classic, iPod nano, and iPod touch are trademarks of Apple Inc., registered in the U.S. and other countries.*
- *“Made for iPod,” and “Made for iPhone,” mean that an electronic accessory has been designed to connect specifically to iPod, or iPhone, respectively, and has been certified by the developer to meet Apple performance standards. Apple is not responsible for the operation of this device or its compliance with safety and regulatory standards. Please note that the use of this accessory with iPod, or iPhone may affect wireless performance.*
- *The BLUETOOTH® word mark and logos are registered trademarks owned by the Bluetooth SIG, Inc. and any use of such marks by Alpine Electronics, Inc. is under license.*
- *“MPEG Layer-3 audio coding technology licensed from Fraunhofer IIS and Thomson”*
- *“Supply of this product only conveys a license for private, non-commercial use and does not convey a license nor imply any right to use this product in any commercial (i.e. revenue-generation) real time broadcasting (terrestrial, satellite, cable and/or any other media), broadcasting/streaming via internet, intranets and/or other networks or in other electronic content distribution systems, such as pay-audio or audio-on-demand applications. An independent license for such use is required. For details, please visit <http://www.mp3licensing.com>”*
- *DivX®, DivX Certified® and associated logos are trademarks of Rovi Corporation or its subsidiaries and are used under license.*

# Getting Started

## Accessory List

- Head unit ..... 1
- Power Cable ..... 1
- Mounting Sleeve ..... 1
- Bracket key ..... 2
- Flush Head Screw (M5 × 8) ..... 6
- Screw (M5 × 8) ..... 8
- Rubber Cap ..... 1
- Hex Bolt ..... 1
- Front Frame ..... 1
- USB extension cable ..... 1
- Microphone ..... 1
- Owner's Manual ..... 1 set

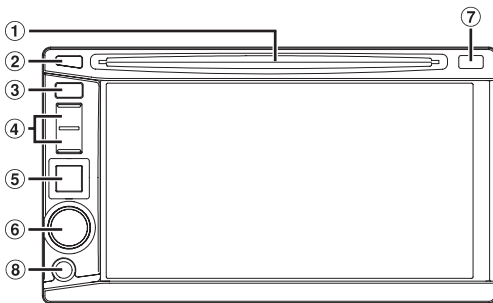

### Connectable to Remote Control Interface Box

You can operate this unit from the vehicle's control unit when an Alpine Remote Control Interface Box (optional) is connected. For details, contact your Alpine dealer.

## Location of Controls

- ① **DISC Slot**
- ② **▲ button**  
Ejects a disc.
- ③ **☎ (Phone) button**
  - Press to display the Telephone Menu screen.
  - Press and hold for at least 2 seconds to activate Voice Dial mode.  
(When BLUETOOTH IN is set to HFP or HFP+AUDIO (page 41).)
- ④ **Track tune button**  
Press to select the desired Radio preset station/track/file/ chapter.
- ⑤ **SOURCE/⏻ button**
  - Turns the power on.
  - Press and hold for at least 3 seconds to turn the power off.
  - Recalls the SOURCE selection screen.
- ⑥ **Rotary encoder/MUTE/TA**
  - Adjust the volume by turning to the left or right.
  - Press to activate/deactivate mute mode.
  - Press and hold for at least 2 seconds to activate/deactivate the Traffic Information mode.
- ⑦ **Remote Sensor/Dimmer Sensor**
  - Point the optional remote control transmitter towards the remote sensor within a range of 2 meters.
  - Senses the brightness of the car interior.
- ⑧ **Front AUX Input Terminal**  
Connects a portable music player, etc., to the system. For details, see "Operating Auxiliary Devices (Optional)" (page 50).

- *The buttons on the face of this unit are shown in bold (e.g. **SOURCE/⏻**). The onscreen buttons that appear in the display are shown in bold enclosed by [ ] (e.g. **[BAND]**).*

## Turning Power On or Off

Some of this unit's functions cannot be performed while the vehicle is in motion. Be sure to stop your vehicle in a safe location and apply the parking brake, before attempting these operations.

### 1 Press **SOURCE/⏻** to turn on the unit.

- The unit can be turned on by pressing any button on the unit except **▲** (Eject).
- When the security code is set, you have to input the password when the system is connected to a battery and turned on for the first time. For details, refer to "Setting Security code" on page 38.

### 2 Press and hold **SOURCE/⏻** for at least 3 seconds to turn off the unit.

## Adjusting the Volume

Adjust the volume by turning the **Rotary encoder**.

Volume: 0 - 35

## Lowering Volume Quickly

Activating this function will instantly lower the volume level by 20 dB.

### Press **Rotary encoder (MUTE)**.

The audio level decreases by about 20 dB.

Pressing **Rotary encoder (MUTE)** again brings the audio back to its previous level.

## How to view the Display

### TOUCH PANEL operation

- To protect the display, touch the onscreen button with the tip of your finger.
- If you touch a button and there is no reaction, remove your finger from the display once, and try again.
- If you touch two buttons at the same time, a malfunction may occur.

#### **Onscreen buttons are expressed as follows in this Owner's Manual.**

- Onscreen buttons are shown in bold, enclosed in [ ] (e.g. **[BAND]**).

## Recalling the Source

Here is an example explanation for the Radio mode display on how to recall a source.

### 1 Press **SOURCE/⏻**.

The SOURCE selection screen is displayed.

#### Display example for SOURCE selection screen

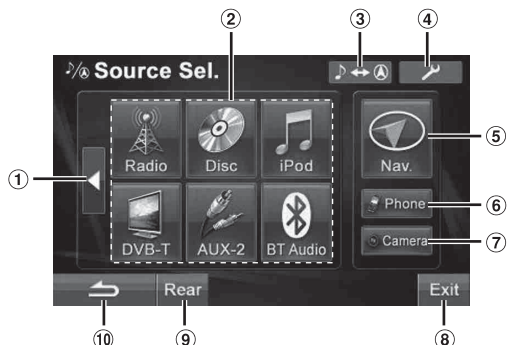

- ① Changes the item of source selection list. (Depending on the source quantity, this button may not be displayed.)
  - ② Displays the source modes that can be selected.
  - ③ [**↔**] button: Changes to Navigation screen. (Available only when ON is set in "Setting the Navigation Mode" (page 40) and "Navi" is set in "Setting the VISUAL Button" on page 35).  
[**V.Sel**] button: Changes to VISUAL selection screen. (When V.Sel is set in "Setting the VISUAL Button" on page 35.)
  - ④ Changes to SETUP main screen.
  - ⑤ Changes to Navigation main screen. (When "ON" is set in "Setting the Navigation Mode" (page 40).)
  - ⑥ Changes to the Telephone Menu screen. (When "BLUETOOTH IN" is set to other than OFF (page 41).)
  - ⑦ Displays the rear view video. (When an optional rearview camera is connected and Camera IN is set to ON (page 39).)
  - ⑧ Turns off the Source Select screen, and returns to previous source screen.
  - ⑨ Changes to the Rear selection screen when "Setting the Picture/Sound Output" (page 41) is set to ON.
  - ⑩ Returns to the previous screen.
- The kind of source modes that are displayed varies depending on connection and setting

### 2 Touch **[Radio]**.

The radio mode is activated and the display changes to the Radio Mode screen.

### Display example for FM Radio main screen

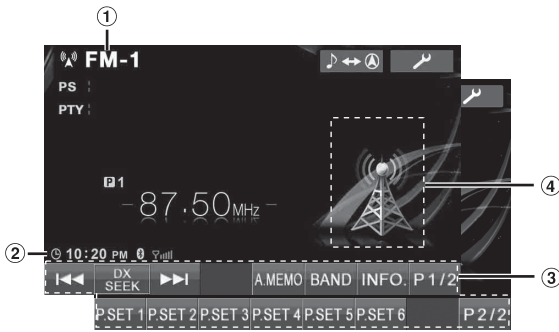

- ① Displays the source name, such as radio band, etc., that is selected.
- ② Displays the time, BLUETOOTH indicator, etc.
- ③ Function Guide:  
The function guide display varies depending on each source.  
The contents of the function guide change by touching [P1/2]\* or [P1/3]\* on the function guide, and many other operations can be performed.
- ④ Displays the image of current source.

\* Display may vary depending on the connected devices.

### 3 Press **SOURCE/⏻** to change to another source screen, and select the desired source from the **SOURCE** selection screen.

- The screen can be changed to the **SETUP** selection screen by touching [↵].

## Displaying the Numeric Keypad Input Screen

The numeric keypad input screen is displayed when the DVD or CD mode, etc. is selected for searching a title, chapter or track, etc.

- 1 Touch [**10KEY**] on the main source screen.
- 2 Touch the desired numeric key.

Display example for numeric keypad (DVD mode)

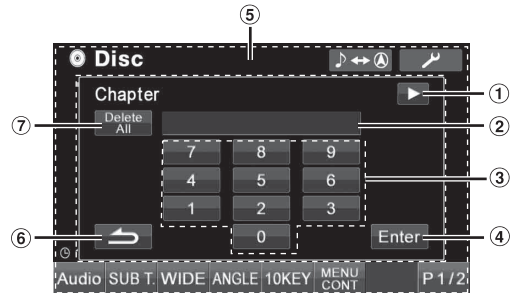

- ① Change select mode (File/Chapter, etc.) or quit numeric keypad input screen.
- ② Input screen area.
- ③ Numeric keypad.
- ④ Input number is confirmed.
- ⑤ The numeric keypad input screen closes if the area is touched while being displayed.
- ⑥ Close numeric keypad input screen.
- ⑦ All input numbers will be deleted.

### 3 Touch [**Enter**] to confirm your entry.

# Radio

Display example for FM Radio main screen

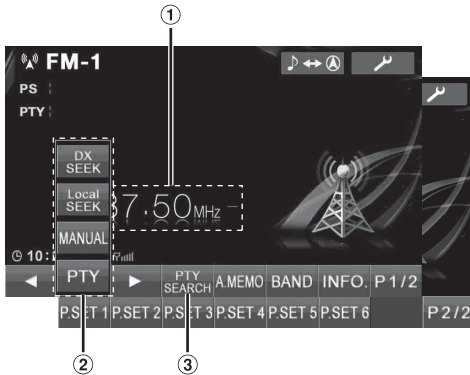

- ① Displays the preset number/frequency
- ② [DX SEEK]\*<sup>1</sup> button: Displays the tuning mode selection list.
- ③ [PTY SEARCH]\*<sup>2</sup> button: Search for a station by PTY (Programme Type) Tuning, refer to "PTY (Programme Type) Tuning" (page 16).

\*<sup>1</sup> The button displays the current tuning mode.

\*<sup>2</sup> The button displays only when the tuning mode of PTY is selected.

## Listening to the Radio

- 1 **Press SOURCE/⏻.**  
The SOURCE selection screen is displayed.
- 2 **Touch [Radio].**  
The radio mode is activated and the display changes to the Radio Mode screen.
- 3 **Touch [BAND] to select the desired radio band.**  
Each press changes the bands as follows:  
FM-1 → FM-2 → FM-3 → MW → LW → FM-1
- 4 **Touch [DX SEEK] to choose the tuning mode.**  

DX SEEK	Local SEEK	MANUAL	PTY

  - There are two modes you can select for auto tuning, DX and Local:
  - DX (Distance) mode;  
Both strong and weak stations will be tuned in.
  - Local mode;  
Only strong stations will be tuned in.  
The initial setting is DX.
- 5 **Touch [◀◀], [▶▶] or [◀], [▶] to change the radio frequency up or down respectively.**  
When touched and held in the manual mode, the frequency changes continuously.

## Presetting Stations Manually

- 1 **Tune in a desired radio station you wish to store in the preset memory by manual or automatic seek tuning.**
- 2 **Touch [P1/2] to change the function guide.**
- 3 **Touch and hold any one of the preset buttons [P.SET 1] through [P.SET 6] for at least 2 seconds.**  
The selected station is stored.
- 4 **Repeat the procedure to store up to 5 other stations onto the same band.**  
To use this procedure for other bands, simply select the band desired and repeat the procedure.

A total of 30 stations can be stored in the preset memory (6 stations for each band; FM1, FM2, FM3, MW and LW).

- If a preset memory has already been set in the same preset number, it will be cleared and the new station will be memorized.

## Presetting Stations Automatically

The tuner can automatically seek and store 6 strong stations in the selected band in order of signal strength.

**After selecting the desired band, touch and hold [A.MEMO] for at least 2 seconds.**

The tuner automatically seeks and stores 6 strong stations into [P.SET 1] to [P.SET 6] in order of signal strength. When the automatic storing has been completed, the tuner goes to the station stored in [P.SET 1].

- If no stations are stored, the tuner will return to the original station you were listening to before the automatic storing procedure began.

## Tuning to Preset Stations

You can tune in the preset stations in memory on each band using the preset number.

- 1 **After selecting the desired band, touch [P1/2] to change the function guide.**
- 2 **Touch any one of the preset buttons [P.SET 1] through [P.SET 6] that has a station stored to it.**  
The preset station is received.

# RDS Operation

## Turning AF (Alternative Frequencies) On or Off

The RDS (Radio Data System) is a radio information system using the 57 kHz subcarrier of regular FM broadcast. The RDS allows you to receive a variety of information such as traffic information, station names, and to automatically re-tune to a stronger transmitter that is broadcasting the same programme.

### 1 Touch [ ] on the main screen.

The SETUP selection screen is displayed.

### 2 Touch the title bar of Source Setup.

The Source Setup screen appears.

### 3 Touch the title bar of RDS Setup.

The RDS Setup screen appears.

### 4 Touch [AF] to select the AF (Alternative Frequency) ON or OFF mode.

- RDS SETUP mode will not be displayed when the band of radio is set to MW or LW.
- When the AF ON mode is selected, the unit automatically tunes to a strong signal station in the AF list.
- Use the AF OFF mode when automatic re-tuning is not required.

### 5 Touch [ ] to return to the previous screen.

- Touching [Exit] will turn off the Setup screen, and return to previous main screen.

#### Tips

- If the unit receives the PTY31 (Emergency Broadcast) signal, the unit will show "Alarm" in the display only when PTY31 is set to on. For operation, refer to "Setting PTY31 (Emergency Broadcast) Reception" (page 33).
- The RDS digital data includes the following:

PI	Programme Identification
PS	Programme Service Name
AF	List of Alternative Frequencies
TP	Traffic Programme
TA	Traffic Announcement
PTY	Programme Type
EON	Enhanced Other Networks
- Refer to page 33 about "PI Seek Setting", "Receiving RDS Regional (Local) Stations", "Switching the Display Language of PTY (Programme Type)" and "Setting PTY31 (Emergency Broadcast) Reception".

## Receiving Traffic Information





Press and hold **Rotary encoder (TA)** for at least **2 seconds** to turn on the Traffic Information mode.

When the traffic information station is tuned in, the TA indicator lights up.

Traffic information is heard only when it is being broadcast. If traffic information is not being broadcast, the unit is set in the standby mode.

When a traffic information broadcast begins, the unit automatically receives it and the display shows "T. Info".

When traffic information broadcast is over, the unit will automatically set in the standby mode.

- If the traffic information broadcast signal falls below a certain level, the unit remains in the receiving mode for 1 minute. If the signal remains below a certain level for over 70 seconds, "TA" blinks in the display.
- If you do not want to listen to the traffic information being received, lightly press **SOURCE**/ or touch [  ]/[PTY]/[NEWS]/[  ]/[  ]/[V.Se] to skip that traffic information message. The T. INFO mode will remain in the ON position to receive the next traffic information message.
- If the volume level is changed while receiving traffic information, the changed volume level will be memorized. When traffic information is received next time, the volume level will be automatically adjusted to the level memorized.

## PTY (Programme Type) Tuning

### RDS SETUP mode

#### 1 Touch [PTY] on the screen.

### FM Radio mode

#### 1 Touch [DX SEEK]\* to choose the PTY tuning mode.

The PTY mode is activated.

The Programme Type of the station being currently received will be displayed.

#### 2 Touch [ ] or [ ] after activating the PTY mode to choose the desired programme type while "PTY" (programme type) is displayed.

Each press scrolls the programme type by one.



## RDS SETUP mode

- 3 Touch **[PTY]** after selecting the programme type to start searching for a station of the selected programme type.

## FM Radio mode

- 3 Touch **[PTY SEARCH]** after selecting the programme type to start searching for a station of the selected programme type.  
If no station is found, "NO PTY" will be displayed.

\* The button displays the current tuning mode.

## Receiving Traffic Information While Playing CD or Radio

The example explained here is how to receive the traffic information broadcast during CD playback.

- 1 In the CD mode, press and hold **Rotary encoder (TA)** for at least 2 seconds to turn on the **Traffic information mode**.  
The unit automatically starts to search the receivable traffic broadcasts.  
When the traffic information broadcast is searched out, the CD mode is switched to the Radio mode and the unit receives the traffic information broadcast.
  - When the traffic information broadcast starts, the unit automatically mutes the CD.
  - When the traffic information broadcast finishes, the unit automatically returns to the original source you were playing before the traffic information broadcast began.
  - *The receiver is equipped with the EON (Enhanced Other Networks) function so if the station being received does not broadcast the traffic information, the receiver automatically tunes in the related station that broadcasts the traffic information.*
- 2 When the traffic information broadcast has finished, the unit returns to the CD mode.

## Priority News

This function allows you to preset to give priority to the News programme. You will never miss the News programme as the unit automatically gives priority to the News programme whenever it begins broadcasting, and interrupts the programme you are currently listening. This feature is functional when your unit is set to a mode other than the LW and MW modes.

- 1 Touch **[NEWS]** to activate the **PRIORITY NEWS mode**.  
The "NEWS" indicator appears in the display. Touch **[NEWS]** again to deactivate the Priority News mode and return to the programme you were previously listening.
- 2 Touch **[↶]** to return to the previous screen.

## Displaying Radio Text

Text messages from a radio station can be displayed.

- 1 Tune in a radio station that transmits text messages.
- 2 Touch **[INFO.]** in the FM radio mode to activate the **Radio Text mode**.  
The display shows "WAIT" for a few seconds.
- 3 To change the Radio Text display, touch **[INFO.]**.
  - *If there is no receivable text message or the unit cannot receive a text message properly, the display shows "NO TEXT".*

# CD/MP3/WMA/AAC

Display example for MP3/WMA/AAC main screen

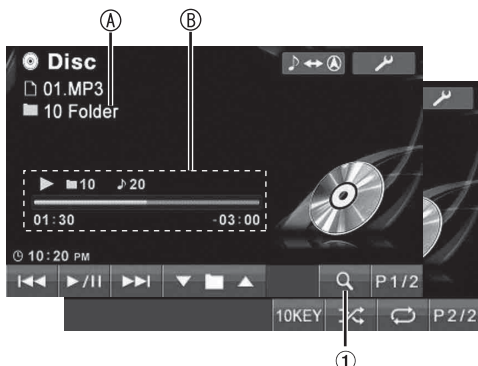

① [Q] button: Refer to page 29

Ⓐ CD:

Displays the Track text\*/Disc text\*.

- If there is neither Track nor Disc name information, "NO TEXT" will be displayed.

**MP3/WMA/AAC:**

After displaying the file name in the upper line, the track name is displayed if there is ID3 tag information. After displaying the folder name in the lower line, the album name/artist name are displayed if there is ID3 tag information.

Ⓑ CD:

Displays play state/track number/progress bar/elapsed time/remain time.

**MP3/WMA/AAC:**

Displays play state/folder number/track number/progress bar/elapsed playback time/remain time.

\* Displayed when a CD text disc is inserted.

## Playback

### 1 Press SOURCE/⏻.

The SOURCE selection screen is displayed.

### 2 Touch [Disc].

The display shows the Disc screen.

When a CD/MP3/WMA/AAC is inserted into the DISC SLOT of the IVE-W530BT, with the label side facing up, the unit starts to play the CD/MP3/WMA/AAC.

### 3 Touch [◀◀] or [▶▶] to select the desired track (file).

**Returning to the beginning of the current track (file):**

Touch [◀◀].

**Fast reverse:**

Touch and hold [◀◀◀].

**Advancing to the beginning of the next track (file):**

Touch [▶▶].

**Fast forward:**

Touch and hold [▶▶▶].

**To pause playback**

Touch [▶/||].

Touching [▶/||] again will resume playback.

**To eject the disc**

Press ▲.

- If the disc does not eject, press and hold ▲ for at least 3 seconds.
- The IVE-W530BT model include a built-in MP3/WMA/AAC unit. You can play CD-ROMs, CD-Rs, and CD-RWs containing MP3/WMA/AAC files on this unit. Use the format compliant with this unit. For further information about playing or storing MP3/WMA/AAC files, refer to pages 19 and 20 before using the unit.
- Any file protected by DRM (Digital Rights Management) copy protection, cannot be played back on this unit.
- The unit can play discs containing both audio data and MP3/WMA/AAC data.
- The track display for CD audio data playback is the track numbers recorded on the disc.
- Three-inch (8cm) CD's cannot be used.
- If an MP3/WMA/AAC disc with many files and folders is played, it takes a little longer than normal to start playback.
- Touch [Q] to activate the search mode. For operations, refer to "Search Function" on page 29.
- Touch [10KEY] to activate direct search mode. For operations, refer to "Numeric Keypad Input Operation" on page 23.
- The playback time may not be correctly displayed when a VBR (Variable Bit Rate) recorded file is played back.
- If the disc is left in the unit after pressing ▲, the disc is automatically pulled back into the unit and paused. In this case, start playback by touching [▶/||] or eject again and remove the disc within 15 seconds.

## Repeat Play

**Touch [↺] to play back repeatedly the track currently being played.**

The track (file) will be played repeatedly.

Touch [↺] again and select OFF to deactivate Repeat play.

CD: ↺ → (off) → ↺  
(Repeat one)

MP3/WMA/AAC:

- 1 Touch [P1/2]\*<sup>1</sup> to change the function guide.
- 2 Touch [↺] and select the desired Repeat play.

↺ → ↺ ■\*<sup>2</sup> → (off) → ↺  
(Repeat one) (Repeat folder)

\*<sup>1</sup> Display may vary depending on the connected devices.

\*<sup>2</sup> Only files in a folder are repeatedly played back.

## M.I.X. (Random Play)

### Touch [⏮] during playback.

The tracks (files) on the disc will be played back in a random sequence.

To cancel M.I.X. play, touch [⏮].

CD: ⏮ → (off) → ⏮

MP3/WMA/AAC:

- 1 Touch [P1/2]<sup>\*1</sup> to change the function guide.
- 2 Touch [⏮] and select the desired M.I.X. play.

⏮ ■<sup>\*2</sup> → ⏮ ■<sup>\*3</sup> → (off) → ⏮ ■<sup>\*2</sup>

<sup>\*1</sup> Display may vary depending on the connected devices.

<sup>\*2</sup> Only files in a folder are played back in random sequence in the M.I.X. Folder mode.

<sup>\*3</sup> All files in a disc are played back in random sequence.

- If the search mode (page 29) is activated, the M.I.X. Play mode will be cancelled.

## Selecting Folders (concerning MP3/WMA/AAC)

Touch ■ [▼] or [▲] to select the folder.

## About MP3/WMA/AAC

### CAUTION

Except for private use, duplicating audio data (including MP3/WMA/AAC data) or distributing, transferring, or copying it, whether for free or for a fee, without permission of the copyright holder is strictly prohibited by the Copyright Act and by international treaty.

### What is MP3?

MP3, whose official name is "MPEG Audio Layer 3," is a compression standard prescribed by the ISO, the International Standardization Organization and MPEG which is a joint activity institution of the IEC.

MP3 files contain compressed audio data. MP3 encoding is capable of compressing audio data at extremely high ratios, reducing the size of music files to as much as one-tenth their original size. This is achieved while still maintaining near CD quality. The MP3 format realises such high compression ratios by eliminating the sounds that are either inaudible to the human ear or masked by other sounds.

### What is WMA?

WMA, or "Windows Media™ Audio," is compressed audio data. WMA is similar to MP3 audio data.

### What is AAC?

AAC is the abbreviation for "Advanced Audio Coding," and is a basic format of audio compression used by MPEG2 or MPEG4.

### Method for creating MP3/WMA/AAC files

Audio data is compressed using software with MP3/WMA/AAC codecs. For details on creating MP3/WMA/AAC files, refer to the user's manual for that software.

MP3/WMA/AAC files that can be played back by this device have the following file extensions:

MP3: "mp3"

WMA: "wma" (ver. 2, 8, 9 are supported)

AAC: "m4a", "mp4"

WMA is not supported for the following files, Windows Media Audio Professional or Windows Media Audio 9 Pro Lossless.

There are many different versions of the AAC format. Confirm that the software being used conforms to the acceptable formats listed above. It's possible that the format may be unplayable even though the extension is valid. Playback of AAC files encoded by iTunes is supported.

### Supported playback sampling rates and bit rates

#### MP3

Sampling rates: 48 kHz, 44.1 kHz, 32 kHz, 24 kHz, 22.05 kHz, 16 kHz, 12 kHz, 11.025 kHz, 8 kHz

Bit rates: 32 - 320 kbps

#### WMA

Sampling rates: 48 kHz, 44.1 kHz, 32 kHz

Bit rates: 48 - 320 kbps

#### AAC

Sampling rates: 48 kHz, 44.1 kHz, 32 kHz

Bit rates: 32 - 192 kbps

This device may not play back correctly depending on sampling rates.

### ID3 tags/WMA tags

This device supports ID3 tag v1 and v2, and WMA tag. If tag data is in an MP3/WMA/AAC file, this device can display the title (track title), artist name, and album name ID3 tag/WMA tag data (maximum 64 characters).

This device can only display single-byte alphanumeric characters and the underscore. For non-supported characters, "No Support" is displayed.

The number of characters may be limited, or not correctly displayed, depending on the tag information.

## Producing MP3/WMA/AAC discs

MP3/WMA/AAC files are prepared, then written to a CD-R or CD-RW (DVD-R/DVD-RW) using CD-R writing software. A disc can hold up to 1,000 files/255 folders (including Root Folders), and the maximum number of folders is 255. Playback may not be performed if a disc exceeds the limitations described above.

## Media supported

The media that this device can play back are CD-ROMs, CD-Rs, CD-RWs, DVD-Rs and DVD-RWs.

## Corresponding File Systems

This device supports discs formatted with ISO9660 Level 1 or Level 2.

Under the ISO9660 standard, there are some restrictions to remember.

The maximum nested folder depth is 8 (including the root directory). The number of characters for a folder/file name is limited.

Valid characters for folder/file names are letters A-Z (all caps), numbers 0-9, and '\_' (underscore).

This device also can play back discs in Joliet, etc., and other standards that conform to ISO9660. However, sometimes the file names, folder names, etc., are not displayed correctly.

## Formats supported

This device can read CD-DA sector from Mixed Mode CD or Enhanced CD (CD-Extra).

This device cannot correctly play back discs recorded with Track At Once or packet writing.

## Order of files

Files are played back in the order that the writing software writes them to the disc. Therefore, the playback order may not be what's expected. Verify the writing order in the software's documentation. The playback order of the folders and files is as follows. (The following numbers may differ from actually displayed numbers.)

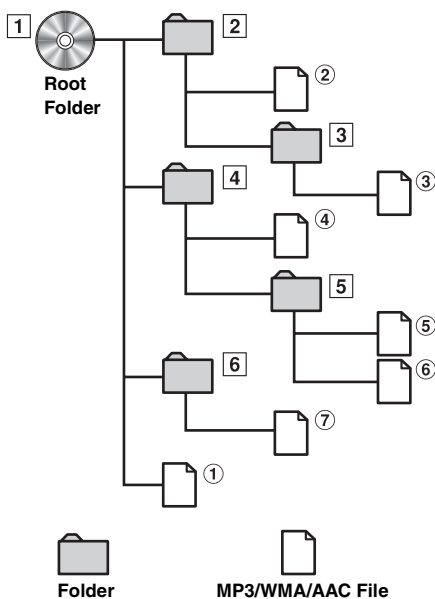

## Terminology

### Bit rate

This is the "sound" compression rate specified for encoding. The higher the bit rate, the higher the sound quality, but also the larger the files.

### Sampling rate

This value shows how many times per second the data is sampled (recorded). For example, music CDs use a sampling rate of 44.1 kHz, so the sound is sampled (recorded) 44,100 times per second. The higher the sampling rate, the higher the sound quality, but also the larger the volume of data.

### Encoding

Converting music CDs, WAVE (AIFF) files, and other sound files into the specified audio compression format.

### Tag

Song information such as track titles, artist names, album names, etc., written into MP3/WMA/AAC files.

### Root folder

The root folder (or root directory) is found at the top of the file system. The root folder contains all folders and files. It is created automatically for all burned discs.

# DVD

Display example for DVD Video main screen

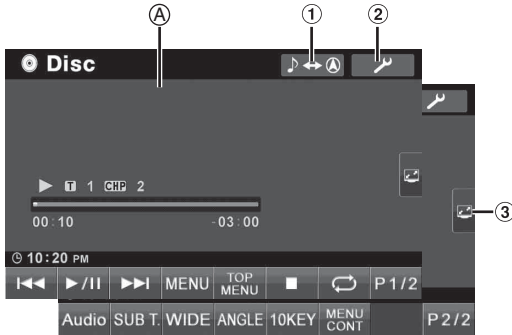

- ① [Navigation] button: Changes to Navigation screen.
- ② [Setup] button: Displays the SETUP selection screen.
- ③ [Full Screen] button: Changes to full screen.
- Ⓐ Displays the disc (DVD VIDEO) being played back. Displays tag information for DivX®.

- If [Search] on the DivX® mode screen is touched, the search list screen is displayed. Refer to “Search Function” (page 29).
- Some operations cannot be carried out depending on the disc or playback screen.
- Displays of the function guide [P1/2], etc., may vary depending on the connected device(s).

Disc types that can be used for each heading are represented by the following marks.

DVD-V

DVD Commercial Video discs (used for the distribution of movies, etc.) or a DVD-R/DVD-RW, DVD+R/DVD+RW recorded in a video mode can be used.

DivX

CD-R/CD-RW/DVD-R/DVD-RW/DVD+R/DVD+RW discs and USB memory that are recorded in the DivX® mode can be used.

## Playing a Disc DVD-V DivX

IVE-W530BT has a built-in DVD player. When an optional Alpine DVD/CD player is connected to the IVE-W530BT, you can control it from the IVE-W530BT (except some operations).

### WARNING

It is dangerous for the driver to watch the TV/DVD/Video while driving the vehicle. The driver may be distracted from looking ahead and an accident could occur.

Install the IVE-W530BT correctly so that the driver cannot watch TV/DVD/Video unless the vehicle is stopped and the emergency brake is applied.

If the IVE-W530BT is not installed correctly, the driver will be able to watch the TV/DVD/Video while driving the vehicle and may be distracted from looking ahead causing an accident. The driver or other people could be severely injured.

### To display the DVD mode screen

DVD-V DivX

- If you try to activate the auxiliary device while driving, the display will show the warning-Picture off for your safety.

### Caution

- Not all functions will operate for every DVD. See the individual DVD's instructions for details on the features supported.
- Fingerprints on a disc may adversely affect playback. If a problem occurs, remove the disc and check for fingerprints on the playback side. Clean the disc if necessary.
- If you switch the power or Ignition Key OFF or change sources during playback, playback will continue where you left off when you resume playback.
- If you try to perform an invalid operation (based on the type of disc being played), the following mark is displayed on the monitor screen:

- Play Position Memory Function  
Even if you turn power off or switch the Ignition Key to OFF during playback or change the source, playback will continue from the point where playback stopped when the power is turned ON again.

## 1 Press **SOURCE**/⏻.

The SOURCE selection screen is displayed.

## 2 Touch **[Disc]**\*.

The display shows the Disc screen.

Insert a disc with the label side facing up. The unit starts to play the disc.

When an optical Alpine DVD player is connected, insert a disc into the DVD/CD player, and the player starts playing.

\* When you want to play a DivX file from a USB device, touch **[USB]**.

- The operation screen changes to the visual screen in the DVD mode for 5 seconds after an operation has been performed. Touch the display panel to display the operation screen again.
- The display mode can be changed by touching **[WIDE]**. For operation, see "Switching Display Modes" on page 30.

### To eject the disc

Press **▲**.

- The reverse side of a double-sided DVD will not be played automatically.  
Remove the disc, turn it over, and reinsert it.
- If the disc does not eject, press and hold **▲** for at least 3 seconds.
- Do not insert discs containing maps for the navigation system. Doing so could result in damage.
- Be sure that the remote input lead is connected to the remote output lead of this unit when a DVD player is connected. If not correctly connected, touching operation cannot be performed.
- Refer also to "DVD Setup" (pages 31 to 32).
- If the disc is left in the unit after pressing **▲**, the disc is automatically pulled back into the unit and stopped. In this case, start playback by touching **[▶/||]** or eject again and remove the disc within 15 seconds.
- While "Index reading" is displayed by DivX®, the fast-forwarding/fast-reversing and repeat functions, etc. cannot be used.

### If a menu screen appears

On DVDs, menu screens may appear automatically. If this happens, perform the operation described below to start playback.

#### Direct Menu Operations **(DVD-V)**

1 Touch the DVD menu directly.

- Some operations cannot be performed depending on the disc.

#### Menu Operations **(DVD-V)**

1 Touch screen to display the operation keys.



2 Touch **[Key]**.

The menu operation mode will be displayed.

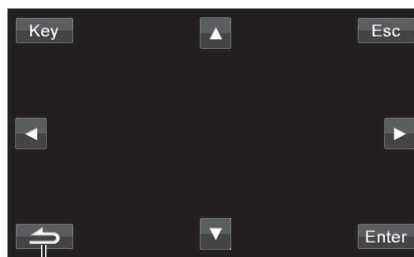

Touch **[↩]** to return to the previous display.  
(Operation may not be possible, depending on the disc.)

3 Select a desired menu item by touching **[▲]**, **[▼]**, **[◀]** or **[▶]**.

4 Touch **[Enter]** to confirm the selected item.

#### Numeric Keypad Input Operations **(DVD-V)**

1 Touch screen to display the operation keys.



2 Touch **[Key]**.

The menu operation mode appears.

3 Touch **[Key]** again.

The numeric keypad input mode screen appears.

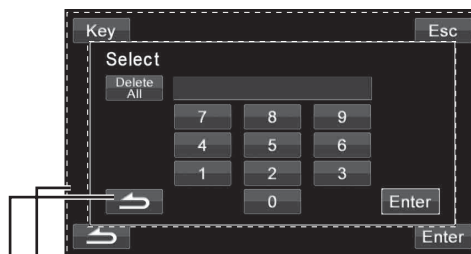

The numeric keypad input screen closes when the area is touched while being displayed.

Touch **[↩]** to close the numeric keypad input screen.

4 Touch a desired number.

5 Touch **[Enter]** on the numeric keypad mode screen to confirm your selection.

## Displaying the Top Menu Screen (DVD-V)

When a DVD contains two or more titles, the top menu screen appears.

**Touch [TOP MENU] on the DVD mode main screen.**

The top menu screen appears.

- To perform necessary operations, see "If a menu screen appears" on page 22.

## Displaying the Menu Screen (DVD-V)

With a DVD having two or more menus, a menu screen will appear for the programmes available, in addition to the main programmes.

**Touch [MENU] on the DVD mode main screen.**

The menu screen appears.

- To perform necessary operations, see "If a menu screen appears" on page 22.

## Displaying the Menu Operation Mode Screen (DVD-V)

- 1 Touch [P1/2]\* on the DVD mode main screen.**  
The function guide changes.

\* The display differs, depending on the disc (mode).

- 2 Touch [MENU CONT].**  
The menu operation mode screen appears.

- For further operation, see "If a menu screen appears" on page 22.

## Numeric Keypad Input Operation

You can quickly find the desired track/file or folder by inputting its track/file or folder Number in this mode.

### Select a Track/File/Chapter

- 1 Touch [P1/2]\* in the CD/MP3/WMA/AAC/DVD (except stop) mode to change to the function guide.**

\* The display differs, depending on the source (mode).

- 2 Touch [10KEY].**  
The numeric keypad input mode screen appears.

- 3 Touch and input a desired number.**

- 4 Touch [Enter] to confirm.**  
The selected Track/File/Chapter is selected.

- For CD, during Track select mode, touch [▶], etc. to quit.
- For MP3/WMA/AAC/DVD, during File/Chapter select mode, touch [▶] again to change to Folder/Title select mode.

### Select a Folder/Title

- 1 Touch [P1/2]\* in the MP3/WMA/AAC/DVD stop mode to change to the function guide.**

\* The display differs, depending on the source (mode).

- 2 Touch [10KEY].**  
The numeric keypad input mode screen appears.

- 3 Touch and input a desired number.**

- 4 Touch [Enter] to confirm.**  
The first file/chapter in the selected Folder/Title begins to play back.

- During File/Chapter select mode, touch [▶] again to change to Folder/Title select mode.
- During Folder/Title select mode, touch [▶], etc. to quit.

---

## Stopping Playback (Pre Stop)

DVD-V DivX

Press the stop button during playback to stop playback. That position is stored in the memory.

### 1 Touch [■] once during playback.

"Pre Stop" is displayed.

### 2 Touch [▶/||] in the Pre Stop mode.

Playback starts from the position at which it was stopped.

- For some discs, the position at which playback was stopped may not be accurate.

---

## Stopping Playback

DVD-V DivX

### Touch [■] twice during playback.

"Stop" is displayed, and playback stops.

- Playback starts from the beginning when [▶/||] is touched while playback is stopped.

---

## Fast-forwarding/Fast-reversing

DVD-V DivX

DVD-Video, DivX®:

### 1 During playback, touch and hold [◀◀] (Fast-reverse) or [▶▶] (fast-forward).

When touched and held for more than 0.5 second, the disc is forwarded/reversed at double speed. When held for 5 more seconds or longer, the disc is forwarded/reversed at 10 times the normal speed. When held for 10 seconds or longer, the disc is forwarded/reversed at 20 times the normal speed.

### 2 Stop touching [◀◀] or [▶▶] to return to normal playback.

- No sound is played during fast-forwarding/fast-reversing.
- For DVDs, the menu screen may reappear during fast-forwarding/fast-reversing.
- Operation may not be possible, depending on the disc.

---

## Finding the Beginnings of Chapters/Files

DVD-V DivX

### During playback, touch [◀◀] or [▶▶].

The chapter/track/file switches each time the button is touched, and playback of the selected chapter/track/file starts.

▶▶: Touch this to start playback from the beginning of the following chapter, track or file.

◀◀: Touch this to start playback from the beginning of the current chapter, track or file.

- Some DVDs do not have chapters.

### Supplementary explanation

"Chapters" are divisions of movies or musical selections on DVDs.

"Tracks" are divisions of musical selections on music CDs.

---

## Playing Still Frames (Pausing)

DVD-V DivX

### 1 During playback, touch [▶/||].

### 2 Touch [▶/||] to resume playback.

- No sound is played during the still frame mode.
- The image or sound may stop temporarily when playback starts from the pause mode. This is not a malfunction.

---

## Slow Motion Playback

DVD-V DivX

### 1 When [▶▶] is touched and held while in the pause mode, the 1/3th speed slow motion playback mode is set.

### 2 Stop touching [▶▶] to pause, and touch [▶/||] to play back.

- No sound is played during slow motion playback.
- 1/3 is approximate speeds. The actual speed differs from disc to disc.



## Selecting Folders DivX

Touch **■** [**▼**] or [**▲**] to select the folder.

## Repeat Playback DVD-V DivX

Use this function to play the disc's chapters, tracks etc., repeatedly.

### DVD Video

- 1 Touch **[↺]**.  
The repeat mode switches every time the button is touched.

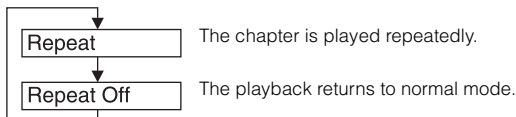

- Display may vary depending on the connected devices.

### DivX®

- 1 Touch **[↺]** after touching **[P1/2]\***.  
The repeat mode switches every time the button is touched.

\* Touch **[P1/3]** while playing a DivX from USB Flash Memory.

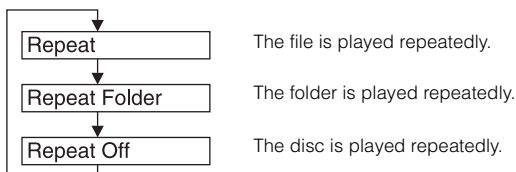

- The REPEAT mode is always turned off when **[↺]** is touched and held for at least 2 seconds.

## Searching by Title/Folder Number

DVD-V DivX

Use this function to easily find positions on the DVD using the DVD's titles.

- 1 Touch **[P1/2]\*1/\*2** while playback is stopped.  
The function guide appears.  
*\*1 The display differs, depending on the disc (mode).*  
*\*2 Touch **[P1/3]** while playing a DivX from USB Flash Memory.*
- 2 Touch **[10KEY]**.  
The numeric keypad input mode screen appears.
- 3 Enter a desired title by touching its title number.  
See page 22 for operation of the numeric keypad.
- 4 Confirm your selection by touching **[Enter]**.  
Playback will start from the title number selected.

- This function cannot be used on discs on which no title numbers are recorded.
- Playback starts from the beginning of the chapter/track number in the state of Pre Stop.
- Some disc may not accept any operation.

## Searching Directly by Chapter, File Number DVD-V DivX

Use this function to easily move to the beginnings of the chapters or files on the disc.

- 1 Touch **[P1/2]\*1/\*2** in any mode other than stop mode.  
The function guide will appear.  
*\*1 The display differs, depending on the disc (mode).*  
*\*2 Touch **[P1/3]** while playing a DivX from USB Flash Memory.*
  - 2 Touch **[10KEY]**.  
The numeric keypad input mode screen appears.
  - 3 Touch and enter the chapter or track number you want to play.  
See page 22 for operation of the numeric keypad.
  - 4 Touch **[Enter]** to confirm your selection.  
Playback will start from the selected chapter or track.
- This function is not available for a disc on which chapters or tracks are not stored.

---

## Switching the Angle DVD-V

---

On DVDs in which scenes have been filmed from multiple angles, the angle can be switched during playback.

### 1 During playback, touch [P1/2]\*.

The function guide changes.

\* The display differs, depending on the disc (mode).

### 2 Touch [ANGLE].

The angle switches between the angles recorded on the disc every time the button is touched.

- Some time may be required for the angle to change.
- Depending on the disc, the angle may switch in one of two ways.
  - Seamless: The angle switches smoothly.
  - Non-seamless: When the angle is switched, a still picture is displayed first, after which the angle switches.

---

## Switching the Audio Tracks DVD-V DivX

---

DVDs with multiplex audio or audio languages allow switching the sound during playback.

### 1 During playback, touch [P1/2]\*1/\*2.

\*1 The display differs, depending on the disc (mode).

\*2 Touch [P2/3] while playing a DivX from USB Flash Memory.

### 2 Touch [AUDIO].

The sound switches between the alternate audio tracks recorded on the disc every time the button is touched.

- The alternate track selected becomes the default setting every time the power is turned on or the disc is replaced. If the disc does not include that track, the disc's default language is selected instead.
- Not all discs will allow changing the alternate audio tracks during playback. In these cases, select audio tracks from the DVDs menu.
- There may be a delay before the selected alternate track begins to play.

---

## Switching the Subtitles (Subtitle Language) DVD-V DivX

---

With DVDs on which multiple subtitle languages are recorded, the subtitle language can be switched during playback; moreover, subtitles can be hidden.

### 1 During playback, touch [P1/2]\*1/\*2.

The function guide changes.

\*1 The display differs, depending on the disc (mode).

\*2 Touch [P2/3] while playing a DivX from USB Flash Memory.

### 2 Touch [SUBT.].

Touching this button repeatedly selects sequentially the subtitle languages recorded on the disc, and then turns the subtitles OFF.

- There may be a delay before the selected subtitle appears.
- Not all discs will allow changing the subtitles during playback. In these cases, select subtitles from the DVDs menu.
- The subtitle language selected becomes the default setting every time the power is turned on or the disc is replaced. If the disc does not include that language, the disc's default language is selected instead. However, the subtitle language may differ depending on the disc.
- For some discs, the subtitles will be displayed even when this is set to OFF. However, the subtitle language may differ depending on the disc.

---

## Switching from the disc menu DVD-V

---

For some discs, the audio language, angle and subtitles can be switched from the disc menu.

### 1 Touch [MENU] or [TOP MENU] to display the menu.

### 2 Select an item to confirm it.

See "If a menu screen appears" on page 22.

## About DivX

DivX® is a codec (software) programme to compress moving images while maintaining image quality using a highly advanced encoding.

- Official DivX® Certified product
- Plays all versions of DivX® video (including DivX® 5) with standard playback of DivX® media files
- DivX®, DivX Certified® and associated logos are trademarks of Rovi Corporation or its subsidiaries and are used under license. DivX Certified® to play DivX® video, including premium content.

The unit can play back CD-R/CD-RW/DVD-R/DVD-RW/DVD+R/DVD+RW discs and USB Flash Memory that are recorded in the DivX® mode with extension "avi", "divx" or "div".

### The optimum size for DivX® disc playback is as follows:

Screen Size: 32 to 720 pixel (horizontal) × 32 to 576 pixel (vertical)

With an aspect ratio other than 16:9, black bars may be displayed on the left and right sides, or at the top and bottom of the screen.

Image bit rate: "Peak 8 Mbps" Home Theatre Profile supported

### The following audio recording systems are supported:

MPEG1 Layer III	32 to 320 kbps
MPEG2 Layer III	8 to 160 kbps
MPEG2.5 Layer III	8 to 160 kbps

### ABOUT DIVX VIDEO:

DivX® is a digital video format created by DivX, LLC, a subsidiary of Rovi Corporation. This is an official DivX Certified® device that plays DivX video. Visit [divx.com](http://divx.com) for more information and software tools to convert your files into DivX videos.

### ABOUT DIVX VIDEO-ON-DEMAND:

This DivX Certified® device must be registered in order to play purchased DivX Video-on-Demand (VOD) movies. To obtain your registration code, locate the DivX VOD section in your device setup menu. Go to [vod.divx.com](http://vod.divx.com) for more information on how to complete your registration.

## Other Useful Features

### Adjusting the Audio

- 1 Touch [↵] on the main screen.**  
The SETUP selection screen is displayed.
- 2 Touch the title bar of Audio Setup.**  
The Audio Setup screen appears.

#### Display Example for Audio Adjustment Screen

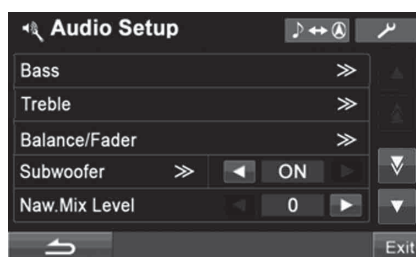

- Touching [↵] will return to the previous display.
- Scroll the list one line at a time by touching [▲] or [▼].
- Scroll the list one page at a time by touching [▲] or [▼].

#### Setting the Bass Control

You can change the Bass Frequency emphasis to create your own tonal preference. Touch the title bar of Bass to display the Bass adjusting screen.

- Adjustment cannot be performed when Defeat is set to ON.

#### Setting the Bass level

You can emphasise or weaken the bass frequency. Touch [◀] or [▶] of Level to select the desired bass level.

Setting range: -7 to +7

### Setting the Bass Centre Frequency

The displayed bass frequency is emphasised.

Touch [◀] or [▶] of Freq. to select the desired bass centre frequency.

Setting range: 60 Hz, 80 Hz, 100 Hz, 200 Hz

### Setting the Bass Bandwidth

Changes the boosted bass bandwidth to wide or narrow.

A wider setting will boost a wide range of frequencies above and below the centre frequency. A narrower setting will boost only frequencies near the centre frequency.

Touch [◀] or [▶] of Q to select the desired bass band width.

Setting range: 1, 1.25, 1.5, 2

- The bass level settings will be individually memorised for each source (FM, MW, LW, CD, etc.) until the setting is changed. The bass frequency and bass band width settings adjusted for one source are effective for all other sources (FM, MW, LW, CD, etc.).
- The function is inoperable when Defeat is set to ON.

### Setting the Treble Control

You can change the Treble Frequency emphasis to create your own tonal preference.

Touch the title bar of Treble to display the Treble adjusting screen.

- Adjustment cannot be performed when Defeat is set to ON.

### Setting the Treble level

You can emphasise the treble frequency.

Touch [◀] or [▶] of Level to select the desired treble level.

Setting range: -7 to +7

### Setting the Treble Centre Frequency

The displayed treble frequency is emphasised.

Touch [◀] or [▶] of Freq. to select the desired treble centre frequency.

Setting range: 10 kHz, 12.5 kHz, 15 kHz, 17.5 kHz

- The treble level settings will be individually memorised for each source (FM, MW, LW, CD, etc.) until the setting is changed. The Treble frequency settings adjusted for one source are effective for all other sources (FM, MW, LW, CD, etc.).
- The function is inoperable when Defeat is set to ON.

### Adjusting Balance/Fader

Touch the title bar of Balance/Fader.

The display changes to the Balance/Fader adjusting screen.

#### Display Example for Balance/Fader Screen

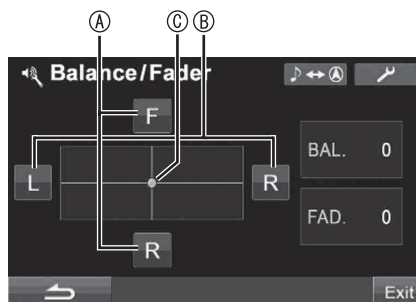

#### A Adjusting the Fader

Touch [F] or [R] to adjust the volume of the front and rear speakers.

Setting range: F15 to R15

#### B Adjusting the Balance

Touch [L] or [R] to adjust the sound volume of the left and right speakers.

Setting range: L15 to R15

#### C Adjusting the Balance/Fader Directly

Touch and move [○] to a desired setting.

Or touch a desired setting range, and [○] will move to that location.

Touch [L] or [R] of Balance and [F] or [R] of Fader for fine-tuning.

### Subwoofer On and Off

Touch [◀] or [▶] of Subwoofer to set to ON or OFF.

OFF: Subwoofer output is off.

ON: Subwoofer output is on.

## Adjusting the Subwoofer Level

When ON is set in "Subwoofer On and Off", the item can be adjusted.

- 1 Touch the title bar of Subwoofer.  
The display changes to the Subwoofer Adjusting screen.
- 2 Touch [◀] or [▶] of Level to adjust the subwoofer output.

Setting range: 0 to 15

## Setting the Subwoofer System

When ON is set in "Subwoofer On and Off", the item can be adjusted.

- 1 Touch the title bar of Subwoofer.  
The display changes to the Subwoofer Adjusting screen.
- 2 Touch [◀] or [▶] of System to select to System 1 or System 2.

**System 1:** Subwoofer level changes according to the main volume setting.

**System 2:** Subwoofer level change is different from the main volume setting. For example, even at low volume settings, the subwoofer is still audible.

## Adjusting Nav. Mix Level

Touch [◀] or [▶] of Nav. Mix Level to adjust the volume of navigation interruption.

Setting range: 0 to 15

- *This adjustment becomes available when Nav. Mix is turned ON in "Setting the Navigation Interruption" (page 40).*
- *Adjustment cannot be performed when Defeat is set to ON.*

## Adjusting Highpass Filter

When Defeat is set to OFF, touch the title bar of H.P.F. to adjust screen.

Touch [◀] or [▶] of Front H.P.F. to adjust the front speaker.

Setting range: OFF, 60 Hz, 80 Hz, 100 Hz

Touch [◀] or [▶] of Rear H.P.F. to adjust the rear speaker.

Setting range: OFF, 60 Hz, 80 Hz, 100 Hz

- *Select OFF when no adjustment is required.*

## Turning Defeat ON or OFF

Touch [◀] or [▶] of Defeat to set to ON or OFF.

---

## Search Function

- 1 Touch [Q] on the function guide while in the CD or MP3/WMA/AAC or DivX® mode.

The search list screen is displayed.

### Select a desired track or folder

Touch [▶] for direct playback.

When a hierarchical list is prepared, >> will be displayed. Touch the title bar to display the respective hierarchy list screens.

## Display Example for Search Screen

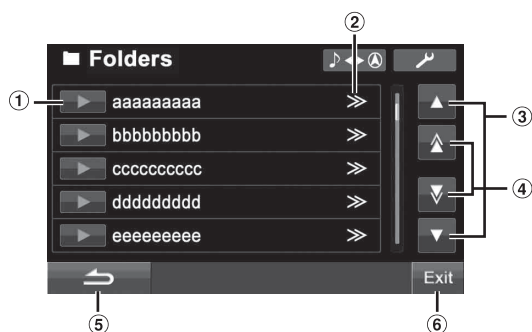

- ① Select directly by touching [▶], and its track (or folder/file) is played back.
- ② >> is displayed if there is a hierarchical list.
- ③ Scroll the list one line at a time by touching [▲] or [▼].
- ④ Scroll the list one page at a time by touching [▲] or [▼].
- ⑤ Touch [↶] to return to the previous list screen.
- ⑥ Touching [Exit] will turn off the search screen, and return to previous main screen.

## Internal CD player mode

- 1 The track list\* screen appears.
- 2 Touch [▶] of a desired track text\*.  
The selected track will be played back.

\* If the CD is text compatible only.

- "TRACK" is displayed in the track text list if there is no text on the disc.

## Internal MP3/WMA/AAC/DivX® Player mode

- 1 The folder list screen appears.  
Select a desired folder and then touch the title bar.  
(>> appears only when a file is present in the selected folder.)  
The file list screen is displayed.
- Touch [▶] to play back the folder directly.
- 2 Touch [▶] of a desired file name.  
The selected file will be played back.

---

## Rear Selection Function

The rear entertainment function independently routes different sources to the front and the rear inside a car. For example, while listening to the radio or other audio source in the front, DVD can be enjoyed in the rear with the optional rear monitor and headphones.

- 1 Press SOURCE/⏻.  
The SOURCE selection screen is displayed.

## 2 Touch [Rear].

The Rear selection screen appears.

- This function cannot be used when "Setting the Picture/Sound Output" (page 41) is set to OFF in the System Setup.
- If [Main] on the Rear Select screen is touched, the screen changes to the main source screen.

## 3 Touch the desired source such as visual (auxiliary input, built-in DVD, etc.) to select.

- Touch [Off] to cancel the rear entertainment function.
- When the AUX1 IN is set to OFF and AUX2 IN is set to iPod Video, the AUX source is not displayed. Refer to "Setting the AUX Mode" (page 40).
- Some sources such as DVB-T (TUE-T250DV), etc., can be displayed on the rear monitor only when they are the same as the main source.

## Switching Display Modes

While your vehicle is parked, touch [WIDE] on the visual source screen.

Each touch changes the display modes as follows:

Mode 1 → Mode 2 → Mode 3 → Mode 1  
(WIDE) (CINEMA) (NORMAL) (WIDE)



In Mode 1 (Wide), the monitor displays a normal picture wider to fit in a wide-screen monitor by evenly stretching out the picture horizontally.



In Mode 2 (Cinema), the monitor displays a normal picture by stretching out the picture horizontally and vertically. This mode is good for displaying a cinema type picture at the 16:9 ratio.



In Mode 3 (Normal), the monitor displays a normal picture at the centre of the screen with a vertical black band at each side.

## Switching the Visual Source Only (Simultaneous Function)

You can watch the video portion of another source while listening to the current source.

### 1 Touch [V.Sel].

The VISUAL selection screen is displayed.

### 2 Touch desired visual source.

The visual source is switched to the selected one.

## Cancelling the Simultaneous Function

### 1 Touch [V.Sel].

### 2 Touch [Normal].

The simultaneous function is cancelled.

- To apply the setting, set to V.Sel in "Setting the VISUAL Button" (page 35).
- The simultaneous function cannot be used when the Audio source is in the navigation mode. When Navi is set in "Setting the VISUAL Button" (page 35), only the navigation screen can be recalled.
- When the AUX1 IN is set to OFF and AUX2 IN is set to iPod Video, the AUX source is not displayed. Refer to "Setting the AUX Mode" (page 40).

## Blackout Mode On and Off

When Blackout mode is turned on, the monitor display will turn off to reduce power consumption.

This additional power enhances the sound quality.

### 1 Touch [V.Sel].

The VISUAL selection screen is displayed.

### 2 Touch [Off].

The backlit-display portion goes out.

### 3 Touch [Off] again to cancel the display backlight.

- To apply the setting, set to V.Sel in "Setting the VISUAL Button" (page 35).
- If any button on the unit is pressed or main screen is touched during Blackout mode, the function will be displayed for 5 seconds. This confirms the operation as well as allowing for additional functions before returning to Blackout mode.

# Setup

## DVD Setup

### DVD Setup Operation

The Parking Brake must be engaged to access the DVD mode screen. Attempting to access this screen while driving will display the warning-Can't operate while driving.

The following steps 1 to 5 are common operations to each "Setting item" of DVD Setup. Refer to each section for details.

- 1 Touch [↶] on the main screen.**  
The SETUP selection screen is displayed.
- 2 Touch the title bar of Source Setup.**  
The Source Setup screen appears.
- 3 Touch the title bar of DVD Setup.**  
The DVD Setup screen appears.
- 4 Touch [◀] or [▶], etc., of the desired item to change its setting.**

#### Setting items:

Menu Language / Audio Language / SUBT. Language / Downmix Mode / TV Screen / DOLBY / DivX Info.

#### Display example for DVD setup screen

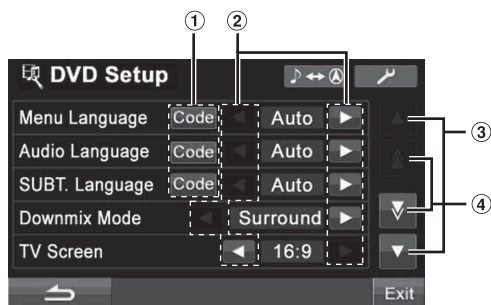

- ① Touch [Code] to display the numeric keypad input screen.
- ② Touch [◀] or [▶] to set a desired language/item.
- ③ Touch [▲] or [▼] to scroll a setting item list by one Line.
- ④ Touch [▲] or [▼] to scroll a setting item list by one page.

### 5 Touch [↶] to return to the previous screen.

- Touching [Exit] will turn off the DVD Setup screen, and return to previous main screen.
- Immediately after changing the settings of DVD mode (while the system is writing data automatically) do not turn the ignition key (engine key) to OFF. Otherwise, the settings may not be changed.
- Depending on the DVD, the setting is effective after the disc has been ejected and reinserted.

### Changing the language setting

The audio language, subtitle language and menu language can be set according to your preferences.

Once set, this becomes the default language. This function is convenient when you always want to listen in English. (The language setting is not effective on some discs. If not, the default language is set from the factory.)

- When the settings are changed, the old settings are overwritten. Make a note of the current settings before making changes. The settings are cleared when the vehicle's battery is disconnected.
- To temporarily change the language of the current disc, either do so from the DVD menu or by using the operation described in the section "Switching the Audio Tracks" (page 26).
- If the disc does not include the selected language, the disc's default language is set.

### Setting of the Menu Language

Set the language used for the menus (title menu, etc.).

#### Setting item: Menu Language

Setting contents: Auto / EN / JP / DE / ES / FR / IT / SE / RU / CN

- When "Auto" is selected, the primary menu language among the recorded ones is played.

### Setting of the Audio Language

Set the audio language produced from the speakers.

#### Setting item: Audio Language

Setting contents: Auto / EN / JP / DE / ES / FR / IT / SE / RU / CN

- When "Auto" is selected, the primary audio language among the recorded ones is played.

## Setting of the Subtitle Language

Set the language of the subtitles displayed on the screen.

**Setting item:** *SUBT. Language*

**Setting contents:** *Auto / EN / JP / DE / ES / FR / IT / SE / RU / CN*

- When "Auto" is selected, the primary subtitle language among the recorded ones is played.

**To play in a language other than those displayed**

- 1 Touch [Code].  
The numeric keypad screen is displayed.
- 2 Touch the 4-digit numeral of the language number.  
As for the language number, refer to "List of Language Codes" (page 57).
- 3 Touch [Enter] to memorize the number.

## Setting the Downmix Mode

This function applies to Dolby Digital sound.

**Setting item:** *Downmix Mode*

**Setting contents:** *Surround / Stereo*

- Surround: Surround compatible Downmix  
Stereo: Stereo Downmix

## Setting the TV Screen

Use the procedure described below to modify the output screen according to the type of TV monitor (rear monitor) being used.

This setting can also be applied for the IVE-W530BT.

If the rear monitor is not connected, the screen setting is 16:9.

**Setting item:** *TV Screen*

**Setting contents:** *4:3 LB / 4:3 PS / 16:9*

- For some discs, the picture may not be set to the selected screen size. (For details, refer to the explanation on the disc's jacket.)

**4:3 LETTER BOX:**

Select this when connected to a conventional 4:3 size (normal TV aspect ratio) monitor. There may be black stripes visible at the top and bottom of the screen (when playing a 16:9 size movie). The width of these stripes will depend upon the original aspect ratio of the theatrical release of the movie.



**4:3 PAN-SCAN:**

Select this when connected to a conventional 4:3 size monitor. The picture will fill the entire TV screen. However, due to the mismatch in aspect ratio, parts of the movie at the extreme left and right sides will not be visible (when playing a 16:9 size movie).



**16:9 WIDE:**

Select this when connected to a wide screen TV. This is the factory setting.



## Setting the DOLBY Dynamic Range

The DOLBY Dynamic Range can be chosen.

**Setting item:** *DOLBY*

**Setting contents:** *RF / Line / OFF*

## Displaying DivX® Disc Information DivX

**Setting item:** *DivX Info.*

If the title bar of DivX Info. is touched, a DivX® file registered code or deactivate code is displayed.

- During DISC/USB/iPod playing mode, the above information will not be displayed.



# Source Setup

## Source Setup Operation

The Parking Brake must be engaged to access the Source mode screen. Attempting to access this screen while driving will display the warning-Can't operate while driving.

The following steps 1 to 5 are common operations to each "Setting item" of Source Setup. Refer to each section for details.

- 1 Touch [↵] on the main screen.**  
The SETUP selection screen is displayed.
- 2 Touch the title bar of Source Setup.**  
The Source Setup screen appears.
- 3 Touch the title bar of your desired Setup mode.**  
DVD Setup<sup>\*1</sup> / Radio Setup / BLUETOOTH Setup<sup>\*2</sup> / RDS Setup<sup>\*3</sup>
- 4 Touch [◀], [▶] or the title bar, etc. of the desired item to change its setting.**

### Radio Setup:

RDS Clock DISP / FM Level / PI Seek / RDS Regional / PTY Language / PTY31

### BLUETOOTH Setup:

Paired Devices / Device Search / Clear Device / Service Provider / Visible Mode / Auto Answer / Speaker Select / MIC Input / Firmware Version / Firmware Update / BT Menu Language / Shortcut Memory

- For BLUETOOTH Setup details, refer to "BLUETOOTH Setup" (page 43).

- 5 Touch [↵] to return to the previous screen.**

## Radio Setup

"Radio Setup" is selected on the source setup main menu in step 3.

### RDS Time Display

When ON is selected, the clock is adjusted automatically based on the time data sent from the RDS broadcast.

#### Setting item: RDS Clock DISP

#### Setting contents: OFF / ON

OFF: To adjust it manually.

ON: Adjust the clock automatically based on the time data. In this case, the clock cannot be adjusted manually. To adjust it manually, select OFF.

### Adjusting Source Signal Levels

If the difference in volume level between the CD and FM radio is too great, adjust the FM signal level as follows.

#### Setting item: FM Level

#### Setting contents: Low / High

### PI Seek Setting

#### Setting item: PI Seek

#### Setting contents: OFF / Auto

### Receiving RDS Regional (Local) Stations

When OFF is selected, the unit automatically keeps receiving the related local RDS station.

#### Setting item: RDS Regional

#### Setting contents: OFF / ON

### Switching the Display Language of PTY (Programme Type)

You can select one of the patterns of the display languages.

#### Setting item: PTY Language

#### Setting contents: GB / NL / F / D / I / E

### Setting PTY31 (Emergency Broadcast) Reception

PTY31 (Emergency Broadcast) reception can be set to ON/OFF.

#### Setting item: PTY31

#### Setting contents: OFF / ON

- The unit automatically gives priority to an Emergency Broadcast whenever it begins, and interrupts the programme you are currently listening to when PTY31 is set to ON.
- The unit will show "Alarm" in the display during PTY31 reception.

# Display Setup

## Display Setup Operation

The Parking Brake must be engaged to access the Display mode screen. Attempting to access this screen while driving will display the warning-Can't operate while driving.

The following steps 1 to 4 are common operations to each "Setting item" of Display Setup. Refer to each section for details.

- 1 Touch [SETUP] on the main screen.**  
The SETUP selection screen is displayed.
- 2 Touch the title bar of Display Setup.**  
The Display Setup screen appears.
- 3 Touch [LEFT] or [RIGHT] etc., of the desired item to change its setting.**

### Setting items:

Visual EQ\*<sup>1</sup> / Dimmer / Screen Dimmer Level\*<sup>2</sup> / Function Guide Fade / Base Color / Screen Alignment / Visual Key

\*<sup>1</sup> For details, refer to "Visual EQ Setting Operation" on page 35.

\*<sup>2</sup> Not displayed when "Dimmer" is set to "OFF".

- 4 Touch [BACK] to return to the previous screen.**
- Touching [Exit] will turn off the Display Setup screen, and return to previous main screen.
  - Immediately after changing the settings of Display Mode (While the system is writing data automatically) do not turn the ignition key (engine key) to OFF.  
Otherwise, the settings may not be changed.

## Setting the Brightness of the Backlighting

Backlighting is provided by a fluorescent light built into the liquid crystal panel. The illumination control adjusts the brightness of the backlighting based on the car ambient lighting for easier viewing.

### Setting item: Dimmer

#### Setting contents: Auto / ON / OFF

- Auto:** Adjust the brightness of the background illumination of the monitor automatically to the brightness of the car interior.
- ON:** Keep the background illumination of the monitor dark.
- OFF:** Deactivate Auto Dimmer mode to keep the background illumination of the monitor bright.

- When ON or Auto is set, the setting is also applied for the button lighting in "Adjusting the Dimmer of Button Lighting at Night" (page 38).

## Adjusting the Minimum Level of Backlight

You can adjust the brightness of the backlight (LOW). This function could be used, for instance, to change the screen brightness while travelling at night.

### Setting item: Screen Dimmer Level

#### Setting content: -15 to +15

You can adjust the level between MIN (-15) and MAX (+15). When it reaches the minimum or maximum point, the display shows "MIN" or "MAX" respectively.

## Turn the Function Guide ON/OFF (Function Guide Fade)

By setting to ON, the function guide will be hidden if no operation is performed for 5 seconds in Radio source, USB source, etc. To display the function guide, touch the screen slightly.

**Setting item: Function Guide Fade**

**Setting contents: OFF / ON**

- In DVD play mode, the function guide will be hidden if there is no operation for 5 seconds even if you set OFF.

## Switching the Font Background Colour

You can choose from 4 different colours for the font background.

**Setting item: Base Color**





**Setting contents: Blue / Red / Green / Amber**

## Adjusting the Touch Panel

Adjustment becomes necessary when the display position on the LCD and the touch position on the touch panel do not match.

**Setting item: Screen Alignment**



**Setting contents:  / Reset**

- 1 Touch the title bar of Screen Alignment.  
The adjustment screen appears.
  - 2 Accurately touch the  mark provided in the lower left corner of the screen.  
The screen changes to the adjustment screen.
  - 3 Accurately touch the  mark provided in the upper right corner of the screen.  
This completes adjustment, and returns to the Display Setup mode screen.
- If you have touched a location other than the  mark, touch [Reset] to restore the adjustment screen to the initial setting.
  - If you touch  on the adjustment screen, no adjustment is done and the Display Setup screen is restored.

## Setting the VISUAL Button

**Setting item: Visual Key**

**Setting contents: Navi / V.Sel**

- Navi: When Navi is set,  will appear on the upper right screen. Touch  to switch to the navigation screen directly. (Only when an Alpine optional RGB Navigation is connected.)
- V.Sel: When V.Sel is set, [V.Sel] will appear on the upper right screen. Recalls the VISUAL selection screen by touching [V.Sel] on the main source screen.

## Visual EQ™

### Visual EQ Setting Operation

The following steps 1 to 4 are common operations to each "Setting item" of Visual EQ setting. Refer to each section for details

- 1 After steps 1 and 2 in "Display Setup Operation" (page 34) have been performed, touch the title bar of Visual EQ.



The Visual EQ screen appears.

- 2 Select a desired setting item by touching [] or [].

**Setting items:**

Visual EQ\* ↔ Bright ↔ Color\* ↔ Tint\* ↔ Contrast ↔  
Sharp\* ↔ User Memory\*

- \* The setting is available in the visual source mode. (except navigation screen)

- 3 Change the setting on the selected item by touching its [] or [].

- 4 Touch [] to return to the previous screen.

- Touching [Exit] will turn off the Display Setup screen, and return to previous main screen.
- Only one setting item can be displayed on each page, you can select the desired brightness, picture tint, etc. through the screen shown.

## Selecting the Visual EQ Mode (Factory's setting)

You can select a mode suitable for the subject image.

**Setting item:** *Visual EQ*

**Setting contents:** *OFF (FLAT) / Night M. / Soft / Sharp / Contrast / P-1 / P-2*

OFF (FLAT):	Initial Setting
Night M.:	Suitable for movies in which dark scenes frequently appear.
Soft:	Suitable for CGs and animated films.
Sharp:	Suitable for old movies where images are not clearly shown.
Contrast:	Suitable for recent movies.
P-1:	Recalls the Visual EQ mode being stored on preset No.P-1 from "Storing Visual EQ" (page 36).
P-2:	Recalls the Visual EQ mode being saved on preset No.P-2 from "Storing Visual EQ" (page 36).

- *To return to the initial setting, after selecting any one of the setting contents (Night M. to Contrast) and adjusting a desired brightness, picture tint, etc., set this function to OFF.*
- *If your desired brightness, picture tint, etc., are adjusted after selecting any one of the setting contents (Night M. to Contrast), "Custom" is displayed.*

## Adjusting Brightness

**Setting item:** *Bright*

**Setting content:** *-15 ~ +15*

You can adjust the brightness between MIN (-15) and MAX (+15). When it reaches the minimum or maximum point, the display shows "MIN" or "MAX" respectively.

- *When any Visual EQ Preset is selected, the brightness is automatically adjusted according to the car's interior lighting as long as Auto is set in "Setting the Brightness of the Backlighting" (page 34).*

## Adjusting Colour of Picture

**Setting item:** *Color*

**Setting content:** *-15 ~ +15*

You can adjust the colour between MIN (-15) and MAX (+15). When it reaches the minimum or maximum point, the display shows "MIN" or "MAX" respectively.

- *Colour adjustment can be made only in the iPod video, DVD, USB Video, AUX modes.*
- *Colour adjustment cannot be made if a Navigation system with the RGB feature is connected.*

## Adjusting Tint of Picture

**Setting item:** *Tint*

**Setting content:** *G15 ~ R15*

Adjust the colour from G15 to R15. "G MAX" or "R MAX" is displayed at the maximum of each colour.

- *Tint adjustment can be made only in the iPod video, DVD, USB Video, AUX modes.*
- *When the picture from the external input is set to PAL, you cannot adjust the Tint.*
- *Tint adjustment cannot be made if a Navigation system with the RGB feature is connected.*

## Adjusting Image Contrast

**Setting item:** *Contrast*

**Setting content:** *-15 to +15*

Adjustment of contrast is done in the range of -15 to +15. "HIGH" and "LOW" appear as the maximum and minimum values specified.

## Adjusting Picture Quality

**Setting item:** *Sharp*

**Setting content:** *-5 to +15*

Picture quality adjustment range is -5 to +5. "SOFT" and "HARD" appear as the minimum and maximum values specified.

- *Picture quality adjustment can be made only in the iPod video, DVD, USB Video, AUX modes.*
- *Picture quality adjustment cannot be made if a Navigation system with the RGB feature is connected.*

## Storing Visual EQ

You can store the settings made for "Adjusting Image Brightness, Tint, Depth, Picture Quality and Contrast."

**Setting item:** *User Memory*

**Setting contents:** *P-1 / P-2*

- 1 After completing "Adjusting Brightness, Tint, Colour, Sharpness, and Contrast" (page 36), touch [◀] or [▶] of User Memory and then select preset number "P-1" or "P-2" to which the settings are to be stored.
  - 2 After selecting a preset No., touch [L-Memory]. The adjusted Visual EQ mode is stored by the above operations.
- *You can recall the Visual EQ mode stored here from P-1 or P-2 of "Selecting the Visual EQ Mode (Factory's setting)" (page 36).*

# General Setup

## General Setup Operation

The Parking Brake must be engaged to access the General mode screen. Attempting to access this screen while driving will display the warning-Can't operate while driving.

The following steps 1 to 4 are common operations to each "Setting item" of General Setup. Refer to each section for details.

- 1 Touch [↵] on the main screen.**  
The SETUP selection screen is displayed.
- 2 Touch the title bar of General Setup.**  
The General Setup screen appears.
- 3 Touch [◀], [▶] or the title bar of setting item, etc., of the desired item to change its setting.**

### Setting items:

Clock / Clock Mode\*<sup>1</sup> / Clock Adjust\*<sup>1</sup> / Summer Time\*<sup>1</sup> / Demonstration / Beep / Beep Level\*<sup>2</sup> / Auto Scroll / Language Sel. / Dimmer Level\*<sup>3</sup> / Security Code

\*<sup>1</sup> Displayed only when "Clock" is set to "ON".

\*<sup>2</sup> When Beep is ON, the item is displayed.

\*<sup>3</sup> Not displayed when "OFF" is set in "Setting the Brightness of the Backlighting" (page 34).

- 4 Touch [↵] to return to the previous screen.**
  - Touching [Exit] will turn off the General Setup screen, and return to previous main screen.
  - Immediately after changing the settings of General Mode (While the system is writing data automatically) do not turn the ignition key (engine key) to OFF.  
Otherwise, the settings may not be changed.

## Displaying the Time

The clock indication on the monitor display is turned on or off respectively.

**Setting item: Clock**

**Setting contents: OFF / ON**

## Setting the Clock Display

You can select the clock display type, 12-hour or 24-hour, depending on your preference.

**Setting item: Clock Mode**

**Setting contents: 24h / 12h**

## Setting the Time

**Setting item: Clock Adjust**

**Further setting items: Hour / Minute / Time Adjust**

**Setting contents: 0-23 / 0-59 / Reset**

**Hour:** Adjust the hour.

**Minute:** Adjust the minute.

**Reset:** If the clock shows less than 30 minutes past, the minute will be "0"; more than 30, the hour advances.

- The clock-adjusting mode is cancelled when the power is turned off, when [↵] or [Exit] is touched.
- Clock adjustment can be made when "RDS Time Display" (page 33) is set to OFF.

## Setting Summer Time

**Setting item: Summer Time**

**Setting contents: OFF / ON**

**ON:** Place the Summer Time mode ON. The time advances by one hour.

**OFF:** Return to the ordinary time.

## Demonstration Function

This unit is equipped with a demonstration function capable of showing basic operations of respective sources on the monitor display.

**Setting item: Demonstration**

**Setting contents: OFF / ON**

**ON:** Turns on the demonstration mode to show the basic operations.

**OFF:** Turns off the demonstration mode.

- The demonstration operation is automatically repeated until the function is turned off.

## Sound (Beep) Guide Function

**Setting item: Beep**

**Setting contents: OFF / ON**

**ON:** Activate the Sound Guide mode.

**OFF:** Deactivate the Sound Guide mode. The sound guide beep will not be produced when a button is pressed/touched.

## Setting the Beep Level

After set to ON in "Setting the Beep", this setting can be performed.

**Setting item: Beep Level**  
**Setting content: 0 to +15**

## Setting the Scroll

Scroll display is available if CD text, folder name, file name or tag information is entered.

**Setting item: Auto Scroll**  
**Setting contents: OFF / ON**

- OFF: Turns off the AUTO scroll mode. Scroll display is done once as a track is changed.
- ON: Turns on the AUTO scroll mode. Scroll display is repeated as long as the mode is turned on.

- The display scrolls on the unit when the screen is filled up.
- Song, artist and album name, etc. scrolls when an iPod/iPhone is connected.

## Changing the Russian Font

Three types of font can be selected.

**Setting item: Language Sel.**  
**Setting contents: Mode1 / Mode2 / Mode3**

- Mode1: Normal Font Display (ISO8859-1).
- Mode2: Russian Font Display (WINDOWS-1251).  
You cannot use this font for display in RDS, Tuner mode.
- Mode3: European Font Display (WINDOWS-1252).

## Adjusting the Dimmer of Button Lighting at Night

You can adjust the brightness of the button lighting at night with the dimmer.

**Setting item: Dimmer Level**  
**Setting content: -2 to +2**

## Setting Security code

You can set the system to be unusable without entering a password. When you set this setting to ON and set a password, the password input is required when the system is connected to a battery and turned on for the first time.

**Setting item: Security Code**  
**Setting contents: ON / OFF**

### Setting the password

- 1 Touch **[ON]**.
- 2 After the confirmation message appears, touch **[Yes]**.  
The password setting screen is displayed.
- 3 Enter a password, then touch **[OK]**.

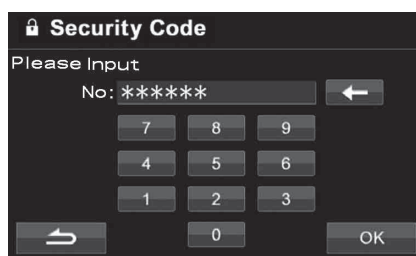

- Enter the 6-digit number.
- Input numbers are displayed as "\*".

- 4 Enter the same password again, then touch **[OK]**.  
The password is set and the system returns to the General Setup screen.

- If you forget a registered password, you can not use this unit. In this case, service will be required.

### Clearing the password

- 1 Touch **[OFF]**.  
The password setting screen is displayed.
  - 2 Enter the password you have set, then touch **[OK]**.  
The password is cleared and the system returns to the General Setup screen.
- Input numbers are displayed as "\*".

# System Setup

## System Setup Operation

The Parking Brake must be engaged to access the System mode screen. Attempting to access this screen while driving will display the warning-Can't operate while driving.

The following steps 1 to 4 are common operations to each "Setting item" of System Setup. Refer to each section for details.

- 1 Touch [SETUP] on the main screen.**  
The SETUP selection screen is displayed.
- 2 Touch the title bar of System Setup.**  
The System Setup screen appears.
- 3 Touch [LEFT] or [RIGHT] of the desired item to change its setting.**

#### Setting items:

Camera IN / Nav. IN / Nav. Mix\* / AUX1 IN / AUX2 IN / AUX Front / AUX Out / BLUETOOTH IN / Illumi Color

\* When ON is set in "Setting the Navigation Mode" (page 40), the item is displayed.

- 4 Touch [BACK] to return to the previous screen.**
- Touching [Exit] will turn off the System Setup screen, and return to previous main screen.
  - Immediately after changing the settings of System Mode (While the system is writing data automatically) do not turn the ignition key (engine key) to OFF.  
Otherwise, the settings may not be changed.

## Setting the Rear Camera Input

With an optional rear camera connected, rear view video is output to the monitor.

#### Setting item: Camera IN

#### Setting contents: OFF / ON

- OFF: The Camera mode is not displayed in the mode switching screen.
- ON: Use when the optional rearview camera is connected to the CAMERA Input Connector.

- By shifting to reverse (R), the rear pictures are output.  
This function is effective when the reverse wire is properly connected.

After setting this item to ON, touch the title bar of Camera IN, the following further setting items can be adjusted.

#### Setting the Rear Camera Signal Input

The video input signal type can be chosen.

#### Further Setting item: Camera Signal

#### Setting contents: NTSC/PAL / Auto

- NTSC/PAL: Choose the video input signal type manually.
- Auto: The suitable video input signal type will be automatically chosen between NTSC and PAL.

- When set to Auto, unstable display may occur while playing back certain black and white video signal. In this case, select NTSC or PAL mode manually.

#### Rear camera guide line display setting

You can set whether the rear camera guide line is displayed or not.

#### Further Setting item: Guide Line

#### Setting contents: OFF / ON

## Adjusting the Rear Camera Guide line

You can adjust the rear camera guide line position.

### Further Setting item: Guide Line Adjustment

#### 1 Touch the title bar of Guide Line Adjustment.

The Guide Line Adjustment screen is displayed.

#### 2 When you touch the guide pylon to be adjusted, a border appears around the pylon.

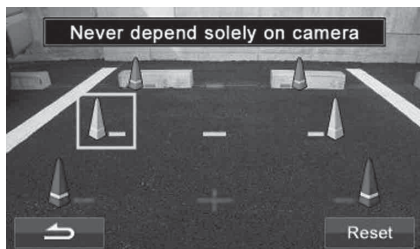

#### 3 Drag and drop the selected pylon or centre guide to adjust its position.

#### 4 After the adjustment is completed, touch [↩].

You can touch [Reset] during adjustment to return to the default adjustment.

## Camera mute setting

You can set whether to mute the source volume when the camera video is displayed.

### Further Setting item: Camera Mute

Setting Contents: OFF / ON

## Setting the Navigation Mode

When you connect an optional navigation equipment, set it to ON.

### Setting item: Nav. IN

Setting contents: OFF / ON

ON: Navigation source is displayed.

OFF: Navigation source is not displayed. The settings related to the navigation can not be changed from this unit.

## Setting the Navigation Interruption

With an Alpine navigation system connected to the IVE-W530BT, the voice guidance of the navigation system will be mixed with the radio or CD play.

### Setting item: Nav. Mix

Setting contents: OFF / ON

OFF: The navigation interruption mode is turned off.

ON: The navigation interruption mode is on.

See "Adjusting Nav. Mix Level" under "Adjusting the Audio" on page 29 to set the navigation interruption volume level.

- The volume level for voice prompts during navigation guidance is set by adjusting its volume while the prompts are announced. When the announcement finishes, the normal audio volume and the previous audio screen are restored. The voice prompt volume is always at or below the current listening volume. If a navigation announcement cuts in while adjusting the audio level, it always resets to the current level regardless of the audio level setting.
- This setting is effective when Nav.IN of SYSTEM list screen is ON.

## Setting the AUX Mode

### Setting item: AUX1 IN

Setting contents: OFF / ON

OFF: AUX-1 source is not displayed.

ON: AUX-1 source is displayed.

- When OFF is selected, the settings related to AUX-1 cannot be changed from this unit.

After setting this item to ON, touch the title bar of AUX1 IN, the following further setting items can be adjusted.

## Adjusting the AUX1 name Mode

### Further Setting items: Primary / Secondary<sup>\*1</sup>

Setting contents: OFF<sup>\*2</sup> / AUX<sup>\*3</sup> / DVD / GAME / TV / DVB-T<sup>\*3</sup> / NAV.

<sup>\*1</sup> When TUE-T200DVB (sold separately) is connected, you can use it to connect one more External Input device. Setting the Secondary name can change the source name display of this device.

<sup>\*2</sup> The setting is only available for Secondary.

<sup>\*3</sup> The setting is only available for Primary.

- You can set Secondary name only when Primary name is set to DVB-T. And you cannot set the same name as in Primary name.
- When OFF is selected, the settings related to AUX cannot be changed from this unit.
- The selected name is displayed on the Visual and Rear selection screen.
- Only when an Alpine TV tuner is connected, you can operate the displayed function guide from this unit.
- The selected source name is displayed instead of AUX source name. Select SOURCE to switch to the guide function of each mode.

### Setting item: AUX2 IN

Setting contents: iPod Video / AUX

iPod Video: Set when an iPhone or a video compatible iPod is connected to the iPod (V)/AUX Input Connector.

AUX: Set when an optional AV/RCA interface cable (4-pole mini AV plug to 3-RCA) is connected. A DVD player etc., with RCA audio/video output can be connected to this unit. In this case, the iPod video will not be displayed.

- When the current source is iPod video or AUX-2, this setting cannot be adjusted.



After setting this item to AUX, touch the title bar of AUX2 IN, the following further setting items can be adjusted.

### **Adjusting the AUX2 name Mode**

**Further Setting items: Primary**

**Setting contents: AUX / DVD / GAME / TV / DVB-T / NAV.**

- The selected name is displayed on the Visual and Rear selection screen.
- Only when an Alpine TV tuner is connected, you can operate the displayed function guide from this unit.
- The selected source name is displayed instead of AUX source name. Select SOURCE to switch to the guide function of each mode.

Touch the title bar of AUX1 IN or AUX2 IN, the following further setting items can be adjusted.

### **Adjusting the External Input Audio Level**

**Further Setting item: Level**

**Setting contents: Low / High**

- Low: Decreases the external input audio level.  
High: Increases the external input audio level.

- For AUX1, this setting item is adjustable only when AUX1 IN is set to ON.
- For AUX2, this setting item is adjustable only when AUX2 IN is set to AUX.

### **Switching the Visual Input Signal System**

**Further Setting item: Signal**

**Setting contents: NTSC/PAL / Auto**

- The video input type can be changed.
- When set to Auto, unstable display may occur while playing back certain black and white video signal. In this case, select NTSC or PAL mode manually.
- For AUX1, this setting item is adjustable only when AUX1 IN is set to ON.
- For AUX2, this setting item is adjustable only when AUX2 IN is set to AUX.

## **Setting the AUX Front Mode**

You can input the audio of an external device (such as a Portable audio player) to the Front AUX Input Terminal of this unit.

**Setting item: AUX Front**

**Setting contents: ON / OFF**

- ON: AUX Front source is displayed.  
OFF: AUX Front source is not displayed.

- When OFF is selected, the setting related to AUX Front source cannot be changed from this unit.

After setting this item to ON, touch the title bar of AUX Front, the following further setting item can be adjusted.

### **Adjusting the Front AUX Input Audio Level**

**Further Setting item: Level**

**Setting contents: Low / High**

- Low: Decreases the front aux input audio level.  
High: Increases the front aux input audio level.

- This setting item is adjustable only when AUX Front is set to ON.

## **Setting the Picture/Sound Output**

Outputs the picture/Sound of the source selected on the IVE-W530BT connected to the rear monitor.

**Setting item: AUX Out**

**Setting contents: OFF / ON**

- ON: The "Rear" item is displayed on the Source Selection screen. Touch [Rear] to change to the REAR select screen, and then touch the desired source. The selected source picture is output on the rear monitor.
- OFF: The "Rear" item is not displayed on the SOURCE select screen.

## **Setting the BLUETOOTH Connection (BLUETOOTH IN)**

**Setting item: BLUETOOTH IN**

**Setting contents: OFF / HFP / HFP+Audio**

- OFF: Select to ignore any external interrupts.
- HFP: Select when you want to pair your BLUETOOTH compatible phone with this unit.
- HFP+Audio: Select when you want to use BLUETOOTH Audio function.

- For details on BLUETOOTH operation, refer to "BT Hands Free Calling" on page 42.

## **Changing the Lighting Colour of Buttons**

**Setting item: Illumi Color**

**Setting contents: Blue / Red / Green / Amber**

- Blue: Lighting colour is blue.
- Red: Lighting colour is red.
- Green: Lighting colour is green.
- Amber: Lighting colour is amber.

# BT Hands Free Calling

## Setup Before Using

### About BLUETOOTH

BLUETOOTH is a wireless technology allowing communication between a mobile device or personal computer over short distances. This enables a hands-free call or data transmission between BLUETOOTH compatible devices. BLUETOOTH transmission is available in the unlicensed 2.4 GHz spectrum if the distance between devices is within 10 meters. For details, refer to the BLUETOOTH Home page (<http://www.BLUETOOTH.com/>).

- Depending on the BLUETOOTH version, a BLUETOOTH compatible device may not be able to communicate with this unit.
- Proper function of this unit with all BLUETOOTH compatible devices is not guaranteed. For handling of the BT compatible device, consult your ALPINE dealer or ALPINE website.
- Depending on the surroundings, BLUETOOTH wireless connection may be unstable.
- When you place a call, or perform setup operations, be sure to stop your car in a safe place.
- Depending on the connected BLUETOOTH compatible device(s), the function may differ. Also refer to the Owner's Manual of the connected device(s).

### Before Using Hands-Free Function

Before using the hands-free phone/audio function, the following settings need to be made.

**Set "BLUETOOTH IN" to HFP or HFP+Audio (page 41).**

- Before using a hands-free phone, it must be paired with this unit. Refer to "BLUETOOTH Setup" (pages 43-44).

### How to connect to a BLUETOOTH compatible device (Pairing)

For details on the control from a BLUETOOTH compatible device, refer to the Owner's Manual of the BLUETOOTH compatible device.

- 1 Set a BLUETOOTH connection from a BLUETOOTH compatible device.
- 2 The PIN code ("0000") is displayed on the screen.
- 3 Input the PIN code ("0000") in a BLUETOOTH compatible device.
- 4 If this unit is successfully connected to a BLUETOOTH compatible device, "Connected/ (Device name)" is displayed, and then the unit returns to normal mode.

- When pairing a BLUETOOTH compatible device with SSP (Secure Simple Pairing), a message "Connect/(Security Code)/Yes/No" will be displayed, touch [Yes] to connect.
- Set "Setting the Search Mode" (page 44) to Visible Mode ON to enable this unit to recognise a mobile phone. For mobile phone passkey (passcode) input operation, refer to the mobile's Owner's Manual. Additionally, the mobile phone can be searched directly from this unit. Refer to "Registering the BLUETOOTH Device" (page 43).
- If a BLUETOOTH compatible device is successfully paired, the next time when the ignition key of the car is turned to on, the unit will automatically connect to the previously connected device. However, the connection may fail. If the auto connection fails, try the connection manually.

# BLUETOOTH Setup

## BLUETOOTH Setup Operation

The following steps 1 to 5 are common to the various BLUETOOTH functions. For details, refer to each individual function.

- While calling, or in the BLUETOOTH Audio source, BLUETOOTH Setup operation cannot be performed.
- When BLUETOOTH IN is set to other than OFF, the following operation can be performed.

- 1 Touch [ ] on the main screen.**  
The SETUP selection screen is displayed.
  - 2 Touch the title bar of Source Setup.**  
The Source Setup screen appears.
  - 3 Touch the title bar of BLUETOOTH Setup.**  
The BLUETOOTH Setup screen appears.
  - 4 Touch [◀], [▶] or the title bar of the desired item to change its setting.**
- Setting items:**  
Paired Devices / Device Search / Clear Device / Service Provider / Visible Mode / Auto Answer / Speaker Select / MIC Input / Firmware Version / Firmware Update / BT Menu Language / Shortcut Memory
- 5 Touch [↶] to return to the previous screen.**  
Touch [Exit] to return to the main source screen that was displayed before the setup operation was started.

### Setting the BLUETOOTH Device

Select one of 3 connected BLUETOOTH compatible devices that you previously registered.

#### Setting item: Paired Devices

**Touch a BLUETOOTH compatible device to use (change connection) from the Paired Device list.**

- If the connection is successfully changed, "Connected/(Device name)" is displayed for 2 seconds, and then the display returns to the Setup screen.
- If you input the wrong passcode or communications fail, "Failed" is displayed.
- If you want to connect another BLUETOOTH compatible device, after disconnecting the current BLUETOOTH compatible device, connect the BLUETOOTH compatible device you want to change to.
- Up to 3 BLUETOOTH compatible devices can be registered to this unit. If all 3 positions have been registered, you cannot register a 4th device. To register another device, you need to delete one of the devices from position 1 to 3 first.

### Registering the BLUETOOTH Device

The BLUETOOTH device is used when a connectable BLUETOOTH compatible device is searched and connected from this unit, or a new BLUETOOTH compatible device is registered.

#### Setting item: Device Search

- 1 When Device Search is selected, "Now Searching" is displayed, and searching starts.**
- 2 Touch the device name to be connected from the Device Search list.**
- 3 If this unit is successfully connected to a BLUETOOTH compatible device, "Connected/(Device name)" is displayed, and then the unit returns to normal mode.**

- If a mobile phone is registered for the first time: Input a passcode when the numeric keypad screen is displayed, then input the same passcode in the BLUETOOTH compatible device to make the pairing. Or a confirmation prompt (Connect (6-digit code number)) will appear on this unit, then touch [Yes]. After the pairing is completed, the unit will automatically connect to the BLUETOOTH compatible device.
- If you input the wrong passcode or communications fail, "Failed" is displayed.
- A passcode input on the unit is maximum 4-digit. If a passcode on the BLUETOOTH compatible device exceeds 4 digits, reset the passcode and make this setting again.

### Deleting a BLUETOOTH Device from the list

You can delete the history of a previously connected BLUETOOTH compatible device.

#### Setting item: Clear Device

- 1 Touch the BLUETOOTH compatible device you want to delete from the Clear Device list.**  
A message is displayed.
- 2 Touch [Yes] if you want to delete.**
  - Touching [No] will cancel the setting.

## **Displaying the phone service provider name**

### **Setting item: Service Provider**

The service provider name of the connected BLUETOOTH compatible device will be displayed. If a BLUETOOTH compatible device is not connected, "ID UNSENT" will be displayed.

- *Depending on the character type some phone service provider name cannot be displayed.*

## **Setting the Search Mode**

You can set whether this unit can be recognised or not from a BLUETOOTH compatible device. Normally set this to Visible Mode ON.

### **Setting item: Visible Mode**

- ON: Enables recognition of this unit from the BLUETOOTH compatible device.
- OFF: Disables recognition of this unit from the BLUETOOTH compatible device.

## **Setting the Received Calls automatically (Auto Answer)**

When a call is received, you can set whether to receive it automatically or not.

### **Setting item: Auto Answer**

- ON: When a call is received, it will be taken automatically after about 5 seconds.
- OFF: When a call is received, it will not be received automatically. If a message is displayed and [↵] is touched when a call is received, you can receive the call.

- *If the received call setting on the mobile phone is on, the call will be answered automatically even though this setting is set to OFF.*

## **Selecting the output speaker**

You can select the connected speaker in car to output the sound signal of telephone.

### **Setting item: Speaker Select**

- All: The sound outputs from all of speakers in car.
- F-L: The sound only outputs from the front left speaker.
- F-R: The sound only outputs from the front right speaker.
- F-LR: The sound outputs from the front left and front right speaker.

- *The setting cannot be adjusted during a phone call. Adjust the setting before placing a call.*

## **Adjusting the volume for the microphone input**

You can emphasise or weaken the microphone input volume level.

### **Setting item: MIC Input**

Touch [◀] or [▶] to select the desired volume level (0 ~15).

- *The setting cannot be adjusted during a phone call. Adjust the setting before placing a call.*
- *The setting can be adjusted only when the BLUETOOTH compatible device is connected.*

## **Displaying the firmware version**

### **Setting item: Firmware Version**

The current firmware version will be displayed.

## **Updating the firmware**

### **Setting item: Firmware Update**

For information to update your BLUETOOTH firmware, please visit your local Alpine web site or choose your country from Alpine Europe top page (<http://www.alpine-europe.com>).

## **Setting the BLUETOOTH Menu language**

The BLUETOOTH Menu can be switched within 8 languages (EN/DE/ES/FR/IT/NL/RU/TH).

### **Setting item: BT Menu Language**

For example, if you want the BLUETOOTH Menu to be displayed as German, select DE with above procedure.

## **Deleting a preset number from the Shortcut Memory**

### **Setting item: Shortcut Memory**

Touch [Delete] of the preset number to delete preset shortcut dial number.

- *About how to store the telephone number as shortcut dial, refer to "Preset a number in the Phone Book (Shortcut Dial)" on page 47.*

---

# **Hands-Free Phone Control**

---

## **About the Hands-Free Phone**

Hands-free calls are possible when using a HSP (Head Set Profile) and HFP (Hands-Free Profile) compatible mobile phone with this unit.

- *Avoid performing a hands-free call in heavy traffic or on narrow or winding streets.*
- *Close the windows while calling to reduce background noise.*
- *If both calling parties are using hands-free devices, or the call is made in a noisy location, difficulty hearing the other person's voice is normal.*
- *Depending on telephone line conditions or certain mobile devices used, voices may sound unnatural.*
- *When using a microphone, speak as directly as you can into the microphone to pick up the best sound quality.*
- *Certain mobile phone features are dependent on the capabilities and settings of your service provider's network. Additionally, certain features may not be activated by your service provider, and/or the provider's network settings may limit the feature's functionality. Always contact your service provider about feature availability and functionality.*

*All features, functionality, and other product specifications, as well as the information contained in the Owner's Manual are based upon the latest available information and are believed to be accurate at the time of printing.*

*Alpine reserves the right to change or modify any information or specifications without notice or obligation.*

## Answering a Call

Incoming calls are announced by the received call ring tone and a displayed message (Caller name/PHONE No.).

### Touch [↗].

The call starts.

- **Indicator  (Signal Strength):**  
While calling, the indicator will display the current signal strength of your mobile phone. While in a mode other than Calling, the unit cannot read the signal strength of the mobile phone exactly. In this case, the indicator displays the signal strength of the last call.
- When "Setting the Received Calls automatically (Auto Answer)" (page 44) is set to ON, you can receive a call automatically.
- While calling, the source sound on the unit is muted.  
After calling, playback will resume.

## Hanging up the Telephone

### Touch [↖].

The call finishes.

## Adjusting the volume when receiving a Call

While calling, you can adjust the volume. The adjusted volume level is stored.

### Turn the **Rotary encoder** to adjust the volume.

- You may need to increase volume from your regular audio listening source level. However, increasing the volume excessively may result in feedback. If feedback is noticed as feedback is directly related to the volume, turn down the volume as low as acceptable to eliminate it. Positioning the microphone in a direction away from the main car speakers (e.g. clipped on sun visor) may also reduce feedback at high volume.

## Redial Function

You can redial the person you have previously called.

### After finishing a call, touch [↗↗] on the screen within 5 seconds.

The telephone is redialed.

## Call waiting function

If a second call is received during a current call, you can have the first caller wait momentarily while you take the second call. When you are finished with one call, you can switch to the other one.

- 1 If a second call is received during the current call (caller1), the number of second caller (caller2) is displayed instead of the current caller's information. Touch [↗], the call waiting mode is activated. In this case, caller1 is on hold, while you take caller2.

### Display example for the 2nd incoming call screen

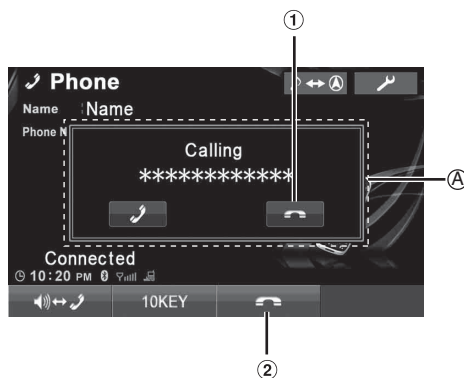

- (A) Second call message
- (1) Hang up the first call and the second incoming call is answered.
- (2) Hang up the second incoming call.

### Display example for the 2nd incoming call screen



- (B) Feedback of the connected second call
- 2 By touching [↗↗1] on the call waiting screen, you can switch between the calling person and the person on hold.

## Call Switching Operation

While making a call, this function allows you to initiate the transfer of the audio between the mobile phone and the speakers in the car.

**While calling, touch [🔊]↔️🔊] to switch the call sound between the unit and mobile phone.**

- Depending on the mobile phone, this operation may not be performed.

## Call History

Call History is recorded for the last dialed/received/missed calls. There are various ways of making calls based on the “Call History”. The following steps 1 to 2 are common to the various ways of making these calls. For details, refer to each individual category for making calls.

**1 Check that “HFP” or “HFP+Audio” is selected in “Setting the BLUETOOTH Connection (BLUETOOTH IN)” (page 41).**

**2 Press [📞].**

The Telephone Menu screen is displayed.

**Display example for Telephone Menu screen**

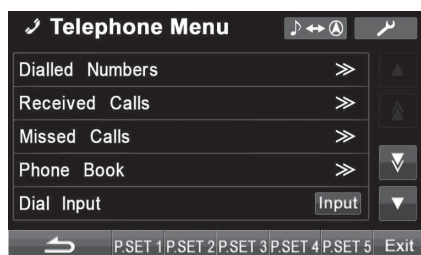

- During SOURCE selection screen, you can also switch to Telephone Menu screen by touching [Phone] icon.

**3 Touch the title bar of the desired item to place the call.**

**Setting items:**

When “BT Menu Language” is set to “EN”, the Telephone Menu is displayed as:

Dialed Numbers / Received Calls / Missed Calls / Phone Book / Dial Input / Voice Dial

When “BT Menu Language” is set to “DE”, the Telephone Menu is displayed as:

Gewählte Nummern / Angenommene Anrufe / Verpasste Anrufe / Telefonbuch / Nummer wählen / Sprachwahl

When “BT Menu Language” is set to “ES”, the Telephone Menu is displayed as:

Llamadas Realizadas / Llamadas Recibidas / Llamadas Perdidas / Agenda / Marcación Directa / Marcación por Voz

When “BT Menu Language” is set to “FR”, the Telephone Menu is displayed as:

Números composés / Appels reçus / Appels manqués / Répertoire / Clavier / Composition vocale

When “BT Menu Language” is set to “IT”, the Telephone Menu is displayed as:

Chiamate Effettuate / Chiamate Ricevute / Chiamate Perse / Rubrica / Tastiera / Chiamata Vocale

When “BT Menu Language” is set to “NL”, the Telephone Menu is displayed as:

Gekozen numbers / Ontvangen oproepen / Gemiste oproepen / Telefoonboek / Manuele ingave / Voice Dial

When “BT Menu Language” is set to “RU”, the Telephone Menu is displayed as:

Набранные номера / Принятые вызовы / Пропущенные вызовы / Телефонная книга / Набор номера / Голосовой набор

When “BT Menu Language” is set to “TH”, the Telephone Menu is displayed as:

รายการโทรออก / รายการรับสาย / สายที่ไม่ได้รับ / สมุดโทรศัพท์ / หมายเลข / โทรออกด้วยเสียง

- For details, refer to “Setting the BLUETOOTH Menu language” on page 44.
- It may take some time for the list to be displayed, and also directly after connection, the list may not be brought up to date.

**4 Touch [↶] to return to the previous screen.**

Touch [Exit] to return to the main source screen that was displayed before the setup operation was started.

- If you place a call directly from the paired mobile phone, the phone number is not displayed, you cannot redial from the unit in this case.

## Redialing a Number in Dialed Calls History

Previously dialed telephone numbers are stored in dialed calls history. You can redial a number by searching from dialed calls history.

**Setting item: Dialed Numbers**

**Touch [Call] of the person name or the telephone number you want to call from the Dialed Calls list.**

The call is placed.

## Dialing a Number in Received Calls History

Telephone numbers from received calls are stored in the received calls history. You can redial these numbers by searching here.

**Setting item: Received Calls**

**Touch [Call] of the person name or the telephone number you want to call from the Received Calls list.**

The call is placed.

## Dialing a Number in Missed Calls History

Telephone numbers for received calls that are missed, are stored in the missed calls history. You can redial these numbers by searching here.

**Setting item: Missed Calls**

**Touch [Call] of the person name or the telephone number you want to call from the Missed Calls list.**

The call is placed.

## Dialing a Number In the Phone Book (Phone Book)

Up to 1,000 telephone numbers are downloadable to the BLUETOOTH compatible unit from a mobile phone. Dial a call by selecting a person from the phone book list.

**Setting item: Phone Book**

*Display example for Phone book screen*

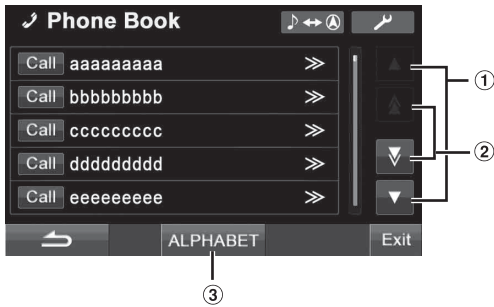

- ① Scroll the list one line at a time by touching [▲] or [▼].
- ② Scroll the list one page at a time by touching [▲] or [▼].
- ③ Activate alphabet search function. For details, refer to "Alphabet Search Function" on page 47.

**Touch [Call] of the person name or the telephone number you want to call from the Phone Book list.**

The call is placed.

- If one name has several numbers registered in the telephone book, choose and touch [Call] of the desired number after touching the name, the telephone will be called. Touch [Call] of the name directly, the default number of the name will be called. Depending on the connected mobile phone, this function may not be performed.
- If a name cannot be obtained via the phone book, only the telephone number (default number) is displayed. If both name and number cannot be obtained, "ID UNSENT" will be displayed.
- If the call history or phonebook of the mobile phone is added or deleted while it is connected to the unit, the list displayed on the unit may not be brought up to date. If it is not updated, you cannot correctly place a call.

### Alphabet Search Function

You can search for a desired name in phone book list by its' initial letter.

- 1 **During Phone Book mode, touch [ALPHABET].**  
The Alphabet search screen is displayed.

*Display example for Alphabet Search screen*

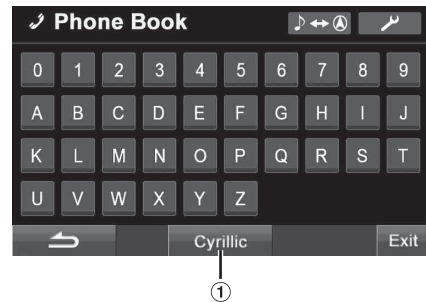

- ① When Mode2 is set in "Changing the Russian Font" (page 38), [Cyrillic] button will appear. Touch [Cyrillic] to change to Russian font keypad screen. Touch [ABC] to return to normal alphanumeric keypad screen.

- 2 **Touch the desired number or letter.**

The numbers/names stored in phone book which begin with the selected number/letter are searched.

- This function is also applicable for iPod/USB search mode.

### Preset a number in the Phone Book (Shortcut Dial)

Assign numbers that you dial frequently to presets for quick recall.

- 1 **Touch a name or number you want to preset from the Phone Book list.**

- 2 **Touch [Preset].**

A "Save as Preset (No)" pop-up screen is displayed.

The phone number you selected is stored in presets.

- You can delete the preset shortcut dial number. For details, refer to "Deleting a preset number from the Shortcut Memory" on page 44.
- A total of 5 phone numbers can be stored in the preset memory for each mobile phone in the paired device list. If a mobile phone is deleted from the paired device list, the stored preset numbers of this mobile phone are deleted, even when it is paired again.

### Dialing the preset number

**During Telephone Menu screen, touch any one of preset buttons (1 through 5) that has had a preset number stored in the Phone Book mode.**

The stored preset number is dialed directly.

## Dialing a Number Using Direct Dial Input

You can place a call by inputting the telephone number directly by the numeric keypad screen on the unit.

**Setting item: Dial Input**

**Display example for the Dial Input screen**

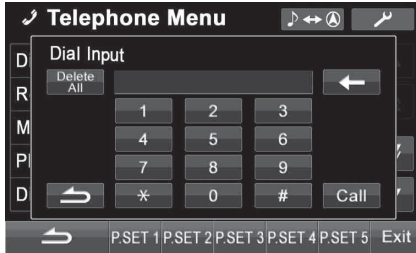

**The numeric keypad screen is displayed. Touch (input) the telephone number, and then touch [Call].**

The call is placed.

- About the numeric keypad  
[→]: closes the numeric keypad input screen.  
[Delete All]: deletes all input numbers.  
[←]: deletes a previous number.

## Voice Dial Operation

You can call the telephone by performing voice operation.

**Setting item: Voice Dial**

- 1 Touch [▼] to display the item of Voice Dial.**
- 2 Touch the title bar of Voice Dial.**  
A message is displayed.
- 3 Touch [Yes] to activate the voice dial mode.**  
The voice dial mode is activated.
- 4 Say the telephone number\*, name\* you want to call into the microphone.**

\* The number and name depend on the voice dial information stored in the mobile phone.

- If the voice dial fails, the unit will return to normal mode in 30 seconds.
- You can perform this operation only when a voice dial compatible mobile phone is connected. If the mobile phone is not compatible with the voice dial, "No Support" is displayed for 2 seconds.
- The Voice Dial function performance depends on the recognition range of the mobile phone and mounting location of the microphone. Note when the microphone is mounted.
- Voice dial operation depends on the function of the mobile phone. For details, refer to the Owner's Manual of the mobile phone.

## BLUETOOTH Audio Function

### BLUETOOTH Audio Operation

Audio information of a BLUETOOTH compatible mobile phone, a portable player, etc., is controllable/playable wirelessly\* from this unit.

\* To play back audio, a mobile phone or a portable player conforming to A2DP (Advanced Audio Distribution Profile) or AVRCP (Audio/Video Remote Control Profile) is required.  
Not all functions work with all devices.

- During a call, sound on the BLUETOOTH audio source is muted.
- There are times when it cannot be operated with the device which you use.

### Recalling the BLUETOOTH audio source

- 1 Press SOURCE/⏻.**  
The SOURCE selection screen is displayed.
- 2 Touch the [BT Audio] icon.**  
The BT Audio source is activated and the display changes to the BT Audio main screen.

### Selecting the desired Song

Touch [⏮].  
Returns the beginning of the song being played back.

Touch [⏭].  
Forwards the next song.  
Touching and holding [⏮] or [⏭] will fast backward/fast forward track continuously.

### Pausing

Touch [⏸/⏹].  
A playback stops. Touching again will resume a playback.



# Rearview Camera Operation (Optional)

When an optional rearview camera is connected, rear view video can be output to the monitor.

- Be sure to set "Camera IN" to "ON" before using the Rearview Camera, refer to "Setting the Rear Camera Input" on page 39.

## Switching the Rear Camera Screen (Optional)

The rear view video will be displayed for the two situations as below.

### Displaying the rear view video while the car is in reverse

- 1 Shift the gear lever to the reverse (R) position.**  
The rear view image is displayed while the car remains in reverse.
- 2 If you shift the gear lever to a position other than reverse (R), the monitor returns to the previous screen.**
  - Be sure to also check behind the car visually. Use the camera image to assist in showing conditions behind the car.
  - This function is effective when the reverse wire is properly connected.
  - No sound output during Camera view display when ON is set in "Camera mute setting" (page 40).

### Displaying the rear view video manually

- 1 Press SOURCE/☺.**  
The SOURCE selection screen is displayed.
- 2 Touch [Camera].**  
The Camera mode is activated and the rear view video is displayed.
- 3 Touch [Guide ON] or [Guide OFF] to set whether the rear camera guide line is displayed.**
- 4 Touch [↩] to access to Visual selection screen, and then touch [Normal] to return to previous main screen.**

# Navigation System (Optional)

## Switching the Navigation Screen (Optional)

If an optional Alpine Navigation System is connected to the IVE-W530BT, the Navigation screen can be displayed on this unit.

- 1 Press SOURCE/☺.**  
The SOURCE selection screen is displayed.
- 2 Touch [Nav.].**  
The Navigation screen is displayed.  
The operation is possible with the supplied navigation remote control.  
For navigation operation, refer to the Owner's Manual of the navigator.
  - You can touch [V.Sel] to activate the Visual Sel. screen, and then touch [Nav.]. The navigation mode is activated from the Visual Sel. mode without interrupting normal audio. For details, refer to "Switching the Visual Source Only (Simultaneous Function)" on page 30.
  - You can also directly access to Navigation screen by pressing [▶↔⊕] on main source screen. For details, refer to "Recalling the Source" on page 13.
  - If the Navigation mode menu is not displayed on the main menu screen, select ON in "Setting the Navigation Mode" (page 40).
  - When the Navigation System is on and in guidance mode, the voice prompts and navigation map interrupts the current audio source.

# Auxiliary Device (Optional)

## Operating Auxiliary Devices (Optional)

To operate your devices connected to the AUX1, AUX2 or Front AUX terminals, follow the procedure described below.

### WARNING

**It is dangerous for the driver to watch the TV/Video while driving the vehicle. The driver may be distracted from looking ahead and an accident could occur.**

**Install the IVE-W530BT correctly so that the driver cannot watch TV/Video unless the vehicle is stopped and the emergency brake is applied.**

**If the IVE-W530BT is not installed correctly, the driver will be able to watch the TV/Video while driving the vehicle and may be distracted from looking ahead and cause an accident. The driver or other people could be severely injured.**

- If you try to activate the auxiliary device while driving, the display will show the warning-Picture off for your safety.

- 1 Press SOURCE/⏻.**  
The SOURCE selection screen is displayed.
- 2 Touch [Aux-1]\*, [Aux-2] or [Front AUX].**  
The external input screen is displayed.
- 3 Touch [NTSC/PAL] to change the video input.**  
This step is not applicable to Front AUX mode.

- \* The name which is given as the source name in "Setting the AUX Mode" on page 40 is displayed.
- If the AUX mode is not displayed on the main menu, set AUX1 IN to ON or AUX2 IN to AUX by following "Setting the AUX Mode" (page 40). Or set AUX Front to ON by following "Setting the AUX Front Mode" on page 41.
- The setting of switching NTSC/PAL, which you have set in this section, can be used in same way in "Setting the AUX Mode" on page 40.
- The display mode changes by touching [WIDE].  
For operation, refer to "Switching Display Modes" on page 30.

# TUE-T200DVB Operation (Optional)

## Operating the TUE-T200DVB (Optional)

Operable when optional TUE-T200DVB is connected.

When DVB-T is selected in "Setting the AUX Mode" (page 40), the source is displayed in SOURCE selection screen.

- 1 While your vehicle is parked, press SOURCE/⏻.**  
The SOURCE selection screen is displayed.
- 2 Touch [DVB-T].**  
The DVB-T screen is displayed.
- 3 Perform the desired operation.**

### Channel Number UP/Down or Favourite Channel Number Up/Down

Touch [CH.]\* to select changing the Channel or the Favourite Channel.  
Touch CH. [◀] or [▶] to move the Channel number Up/Down.  
Touch FAV [◀] or [▶] to move the Favourite Channel number Up/Down.

\* The button displays the current changing mode ([CH.] or [FAV]).

### Calling up Main Menu Screen

Touch [MENU] to call up the main menu screen.

### Calling up Menu Operation Mode

Touch [MENU CONT] to call up the menu operation mode.

### Switching the Source

Touch [A/V].  
The source switches with each touch.

### Calling up Electronic Programme Guide (EPG)

Touch [EPG] to call up the Electronic Programme Guide.

## Scanning Mode

### 1 Touch [P1/3].

The function guide appears.

### 2 Touch [SCAN] to start the auto scan procedure.

- For detail, refer to the Owner's Manual of the TUE-T200DVB (sold separately).

## Video Menu Operation of TUE-T200DVB

### 1 Touch [P1/3] twice.

The direct touch mode screen is displayed.

- When the optional TUE-T200DVB is connected, you can control it by the touch key (except the [Control] key) on the display screen of the unit.

### 2 Touch [Control].

Return to DVB-T main screen.

- If no operation is performed for 5 seconds, the screen will automatically switch to the full screen mode.

# USB Memory (Optional)

A USB memory can be connected to this unit through the USB Connector of this unit.

If a USB memory device is connected to the unit, MP3/WMA/AAC/DivX files of USB memory can be played back.

## BANK Function

### What is a Bank?

A bank is a unit of up to 1,000 songs, which is stored in memory. "Banking" refers to the grouping of songs available in USB Memory, in banks of 1,000 songs each.

### About Banking

While a bank is being built up, "Banking" is displayed. Banking occurs whenever a USB Memory device is connected or after power to the head unit turns on.

It can take anywhere from a few seconds to up to several minutes for banking to complete. This depends on the number of files and folders in USB Memory.

This unit has the BANK function that automatically divides every 1,000 songs stored in USB memory into individual banks to make searching and playing back a song easier. A maximum of 1,000 songs for one bank can be stored according to the order stored in USB memory. A maximum of 20 banks (20,000 songs) can be recognised. BANK1 (songs 1 to 1,000) is set as the default. If you want to search beyond 1,000 songs, perform the following operation to select a different bank.

BANK No.	Song number
BANK1	1~1,000
BANK2	1,001~2,000
⋮	⋮
BANK20	19,001~20,000

### 1 Touch [P1/2] to change the function guide.

### 2 Touch BANK [▼] or [▲] to select the desired BANK.

Each operation can be performed in the selected bank.

- Even if the files are contained in the same folder, they may be saved as different BANK.

## Playback

- 1 Press **SOURCE**/.  
The SOURCE selection screen is displayed.
- 2 Touch **[USB]**, the USB mode is activated and the display changes to the USB screen.
- 3 Touch [] or [] to select the desired track (file) within current Bank.

**Returning to the beginning of the current track (file):**

Touch [].

**Fast backward:**

Touch and hold [].

**Advancing to the beginning of the next track (file):**

Touch [].

**Fast forward:**

Touch and hold [].

- If the next/previous file is a video file or during repeat play mode, fast-forward/fast-backward only applies to current file.
- If the Playlist search mode was used to select a song, fast-forward/fast-backward only applies to current file.
- Fast-forward/fast-backward is valid in current folder.

- 4 To pause playback, touch [].

Touching [] again will resume playback.

- Any file protected by DRM (Digital Rights Management) copy protection, cannot be played back on this unit.
- The playback time may not be correctly displayed when a VBR (Variable Bit Rate) recorded file is played back.
- If there is tag information, artist name/album name/track name is displayed.
- Touch [**10KEY**] to activate direct search mode. For operations, refer to "Numeric Keypad Input Operation" on page 23.
- ID3 tag/WMA tag  
If an MP3/WMA/AAC file contains ID3 tag/WMA tag information, the ID3 tag/WMA tag information is displayed (e.g., song name, artist name, and album name). All other tag data is ignored.
- Nothing will be displayed when text information is not compatible with this unit.
- This unit plays back DivX files in the USB Memory with the same controls and modes as playback of DVD containing DivX. For details, refer to "DVD" on page 21.

## Repeat Play

The Repeat function of the USB Memory is displayed as on the IVE-W530BT.

Repeat One : A single song is repeatedly played back.

Repeat Folder : Only files in a folder are repeatedly played back.

- 1 Touch [**P1/2**].  
The function guide is displayed.

- 2 Touch [].  
The file will be played repeatedly.



- 3 To cancel repeat play, touch [].

## Random Play Shuffle (M.I.X.)

The Shuffle function of the USB memory is displayed as on the IVE-W530BT.

**Shuffle Folder** :

Only files in a folder are played back in random sequence in the M.I.X. Folder mode.

**Shuffle ALL** :

Song shuffle randomly plays back within the selected Bank.

- 1 Touch [] after touching [**P1/2**].  
The songs will be played back in random sequence.

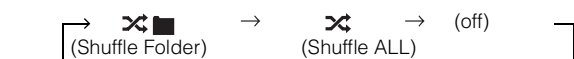

- 2 To cancel M.I.X. play, touch [].

## Searching for a desired Song

A USB memory can contain hundreds of songs. By keeping these songs organised in playlists, this unit can use these to ease song searches. Using the search mode's individual hierarchy, you can narrow down your search as shown in the table below.

Hierarchy 1	Hierarchy 2
Playlists*	Files
Folders	Files
Files	—

\* Only files with an "m3u" extension pertain to Playlist search.

### For example: Searching by Playlist name

The following example explains how a Playlist search is performed. Another search mode can be used for the same operation, although the hierarchy differs.

### Searching by Playlist name

#### 1 Touch [Q].

The search mode is activated, and the search list screen appears.

#### 2 Touch the title bar of Playlists.

The Playlist search screen is displayed.

#### 3 Select the desired playlist.

### To play back the playlist directly

- 1 Touch [▶] next to the playlist's name.  
All files of the selected playlist are played back.

### To search for the file of a playlist

- 1 Touch the title bar of the selected playlist.  
The Files search screen of the selected playlist is displayed.
- 2 Touch [▶] next to the desired file's name.  
The selected file is played back.

- In the search mode, you can scroll the list one page at a time by touching [▲] or [▼].
- In the search mode, a search can be made quickly by Alphabet search function to find the desired playlist or file, etc. For details, refer to "Alphabet Search Function" on page 47.

## Selecting the desired Playlist

Touch  [▼] or [▲] to select the desired Playlist.

## Select the desired Folder (Folder up/down)

If you listen to a file from a selected folder, the folder can be changed.

Touch  [▼] or [▲] to select the folder.

# iPod/iPhone (Optional)

## Connecting an iPod/iPhone

An iPod/iPhone can be connected to this unit, by using the USB connection cable. When this unit is connected by using the cable, the controls on the iPod are not functional.

- Other applications (Internet function, etc.) of the iPhone or iPod touch are not controllable from the unit; however, these functions can be controlled from the iPhone or iPod touch itself.
- An iPhone connected to this unit operates as an iPod. The iPhone can be used as a hands-free device using the integrated Bluetooth module.
- Video is only viewable from a video capable iPhone/iPod. The AUX2 IN must be set to "iPod Video" (see "Setting the AUX Mode" on page 40), and the Parking Brake must be engaged.
- *For automatic transmission vehicles, place the transmission lever in the Park position.*

### iPod/iPhone models usable with this unit

- Confirmed devices regarding Made for iPod. Correct function of earlier versions cannot be guaranteed.

iPod touch (4th generation): Ver. 5.1  
iPod nano (6th generation): Ver. 1.2  
iPod touch (3rd generation): Ver. 4.2.1  
iPod nano (5th generation): Ver. 1.0.2  
iPod classic (160 GB) (Late 2009): Ver. 2.0.4  
iPod touch (2nd generation): Ver. 4.2.1  
iPod nano (4th generation): Ver. 1.0.4  
iPod classic (120 GB): Ver. 2.0.1  
iPod touch (1st generation): Ver. 3.1.3  
iPod nano (3rd generation): Ver. 1.1.3  
iPod classic (80 GB, 160 GB): Ver. 1.1.2  
iPod nano (2nd generation): Ver. 1.1.3  
iPod with video: Ver. 1.3  
iPod nano (1st generation): Ver. 1.3.1

- Confirmed devices regarding Works with iPhone. Correct function of earlier versions cannot be guaranteed.

iPhone4S: Ver. 5.1  
iPhone4: Ver. 5.1  
iPhone 3GS: Ver. 5.1  
iPhone 3G: Ver. 4.2.1  
iPhone: Ver. 3.1.3

- For clarity in identifying your model of iPod, please see Apple's own document "Identifying iPod models" at <http://support.apple.com/kb/HT1353>.

## Setting the iPod Control

When an iPod/iPhone is connected, operate it from its own controls or from the head unit.

- 1 **Touch [App] after touching [P1/2] on the iPod mode screen.**  
"App Mode" appears on the upper left corner of the screen.
  - 2 **In the App Mode screen, touching [App] again will switch to the HU mode.**  
"iPod" appears on the upper left corner of the screen.
- *When using the App Mode, make sure the USB 30P cable is connected to the iPod(V)/AUX Input Connector correctly by using the AV extension cable.*  
For "iPod": Operate the iPod/iPhone via this unit.  
For "App Mode": Operate the iPod/iPhone using its own controls. When App Mode is selected, all function guide except [App] and [WIDE] (video mode only) will disappear.
  - *Depending upon the iPod used, App Mode may not be selectable. Or, if iPod is selected, operation must still be from the head unit.*

## Playback

- 1 **Press SOURCE/ϕ.**  
The SOURCE selection screen is displayed.
- 2 **Touch [iPod].**  
The display shows the iPod mode screen.
- 3 **Touch [◀◀] or [▶▶] to select the desired song.**  
**Return to the beginning of the current song:**  
Touch [◀◀].  
**Fast backward the current song:**  
Touch and hold [◀◀].  
**Advance to the beginning of the next song:**  
Touch [▶▶].  
**Fast forward the current song:**  
Touch and hold [▶▶].
- 4 **To pause playback, touch [▶/||].**  
Touching [▶/||] again will resume playback.

- If a song is playing on the iPod/iPhone when it is connected to this unit, it will continue playing after the connection.
- If the artist, album, genres, composers, titles, created in iTunes, has too many characters, songs may not be played back when connected to this unit. Therefore, a maximum of 64 characters is recommended. The maximum number of characters for the head unit is 66 (64 byte).
- Some characters may not be correctly displayed.
- If an iPhone or a video-compatible iPod is connected, touching [WIDE] on the function guide will change the display mode. For operation, refer to "Switching Display Modes" (page 30).
- If you listen to an episode from a selected podcast or audiobook, the episode can be changed by pressing [Ⓢ] (Episodes) [▼] or [▲].
- An episode may have several chapters. The chapter can be changed by pressing [◀◀] or [▶▶].

## Searching for a desired Song

An iPod/iPhone can contain hundreds of songs. By keeping these songs organized in playlists, this unit can use these to ease song searches. Using the search mode's individual hierarchy, you can narrow down your search as shown in the table below.

### <MUSIC Search Menu>

Hierarchy 1	Hierarchy 2	Hierarchy 3	Hierarchy 4
Playlists	Songs	—	—
Artists*	Albums*	Songs	—
Albums*	Songs	—	—
Songs	—	—	—
Podcasts	Episodes	—	—
Genres*	Artists*	Albums*	Songs
Composers*	Albums*	Songs	—
Audiobooks	—	—	—

- Video search mode depends on the iPod/iPhone. If the specification of the iPod/iPhone is changed, the search mode on this unit will also be changed.

### For example: Searching by Artist name

The following example explains how an Artist search is performed. Another search mode can be used for the same operation, although the hierarchy differs.

### Searching by artist name

- 1 Touch [Q].**  
The search mode is activated, and the search list screen appears.
- 2 Touch the title bar of Music.**  
The Music search screen is displayed.
  - If Video mode is selected, the Video playlists/Movies/Music Videos/TV Shows/Video Podcasts search mode may be used depending on the connected iPod/iPhone (Only for iPhone or iPod compatible Video).
  - If you want to select Video search mode, set AUX2 IN to iPod Video in advance. Refer to "Setting the AUX Mode" on page 40.
- 3 Touch the title bar of Artists.**  
The Artist search screen is displayed.
- 4 Select the desired artist.**

### To play back the artist directly

- 1 Touch [▶] next to the artist's name.  
All songs of the selected artist are played back.

### To search for the album of an artist

- 1 Touch the title bar of the selected artist.  
The Album search screen of the selected artist is displayed.
- 2 Touch [▶] next to the desired album's name.  
All songs of the selected album are played back.







### To search for a song in the album of an artist

- 1 Touch the title bar of the desired album in "To search for the album of an artist" in step 2.  
The Song search screen of the selected album is displayed.
  - 2 Touch [▶] next to the desired song's name.  
The selected song is played back.
- Touching [▶] of ALL will play back all songs in the list when you are in a hierarchy with an asterisk\* (see table on the left column).
  - Touching the title bar of ALL will display the search list in the next hierarchy.
  - If Alphabet search Function is activated in the search mode, a search can be made quickly by Alphabet search function to find the desired artist or song, etc. For details, refer to "Alphabet Search Function" on page 47.
  - When search is made during M.I.X. play, the M.I.X. play mode will be cancelled.
  - In search mode, touch [↶] to return to the previous menu.
  - In search mode, touch [Exit] to return to iPod main screen.

## Selecting Playlist/Artist/Album/Genre/Composer/Episode/Category

Playlist/Artist/Album/Genre/Composer/Episode/Category\* can be easily changed.

For example, if you listen to a song from a selected album, the album can be changed.

- 1 Press [▼] or [▲] to select the desired**  
 (Playlist) /  (Artist) /  (Album) /  (Genre) /  (Composer) /  (Episode) / Category\*.

\* Category can be changed only when playback the video files of iPod/iPhone.

- If search selection mode is not activated, a Song search is not possible.
- During shuffle (M.I.X.) playback, this operation is not possible.
- If Playlist/Artist/Album/Genre/Composer/Episode are not searched, this operation is not possible.

## Random Play Shuffle (M.I.X.)

The Shuffle function of the iPod is displayed as  on the IVE-W530BT.

### Shuffle Albums :

Album shuffle playback plays back all songs in order, then randomly selects the next album. All songs of that album are played back in order, and so on. Any one album is played just once.

### Shuffle Songs :

Song shuffle randomly plays back certain selected songs. Any one song plays back just once until all songs have been played back.

#### 1 Touch [] after touching [P1/2].

 →  → (off)  
(Shuffle Albums) (Shuffle Songs)

#### 2 To cancel M.I.X. play, touch [].

- If a song is selected in the album search mode before selecting Shuffle (M.I.X.), the songs will not play back randomly even when Shuffle album is selected.

## Repeat Play

Only Repeat One is available for the iPod.

Repeat One: A single song is repeatedly played back.

#### 1 Touch [P1/2].

The function guide is displayed.

#### 2 Touch [].

The file will be played repeatedly.

 ↔ (off)  
(Repeat One) (Repeat the list being played back)

#### 3 To cancel repeat play, touch [].

- Depending on the connected iPod, track up/down may be not available during Repeat play.

## Information

### About DVDs

Music CDs and DVDs have grooves (tracks) in which the digital data is recorded. The data is represented as microscopic pits recorded into the track – these pits are read by a laser beam to play the disc. On DVDs, the density of the tracks and pits is twice that of CDs, so DVDs can contain more data in less space.

#### CDs

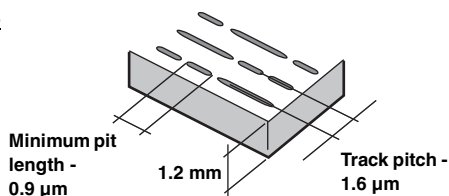

#### DVDs

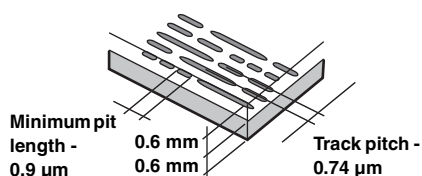

A 12 cm disc can contain one movie or about four hours of music.

In addition, DVDs provide sharp picture quality with vivid colours thanks to a horizontal resolution of over 500 lines (compared to less than 300 for VHS tape).

#### In addition, DVDs offer a variety of functions.

##### Multiple audio\* (page 26)

Movies can be recorded in up to eight languages. The desired language can be selected from the unit.

##### Subtitles function\* (page 26)

Movies can include subtitles in up to 32 languages. The desired subtitle language can be selected from the unit.

##### Multi angle function\* (page 26)

When the DVD contains a movie shot from multiple angles, the desired angle can be selected from the unit.

##### Multi story function\*

With this function, a single movie includes various story lines. You can select different story lines to view various versions of the same movie.

Operation differs from disc to disc. Story line selection screens including instructions appear during the movie. Just follow the instructions.

\* The functions audio languages, subtitle languages, angles, etc., differ from disc to disc. For details, refer to the disc's instructions.



## List of Language Codes

(For details, see page 32.)

Abbreviation	Code	Language	Abbreviation	Code	Language	Abbreviation	Code	Language
AA	6565	Afar	IK	7375	Inupiak	SH	8372	Serbo-Croatian
AB	6566	Abkhazian	IN	7378	Indonesian	SI	8373	Singhalese
AF	6570	Afrikaans	IS	7383	Icelandic	SK	8375	Slovak
AM	6577	Amharic	IT	7384	Italian	SL	8376	Slovenian
AR	6582	Arabic	JA	7465	Japanese	SM	8377	Samoan
AS	6583	Assamese	JI	7473	Yiddish	SN	8378	Shona
AY	6589	Aymara	JW	7487	Javanese	SO	8379	Somali
AZ	6590	Azerbaijani	KA	7565	Georgian	SQ	8381	Albanian
BA	6665	Bashkir	KK	7575	Kazakh	SR	8382	Serbian
BE	6669	Byelorussian	KL	7576	Greenlandic	SU	8385	Sundanese
BG	6671	Bulgarian	KM	7577	Cambodian	SV	8386	Swedish
BH	6672	Bihari	KN	7578	Kannada	SW	8387	Swahili
BI	6673	Bislama	KO	7579	Korean	TA	8465	Tamil
BN	6678	Bengali, Bangla	KS	7583	Kashmiri	TE	8469	Telugu
BO	6679	Tibetan	KU	7585	Kurdish	TG	8471	Tajik
BR	6682	Breton	KY	7589	Kirghiz	TH	8472	Thai
CA	6765	Catalan	LA	7665	Latin	TI	8473	Tigrinya
CO	6779	Corsican	LN	7678	Lingala	TK	8475	Turkmen
CS	6783	Czech	LO	7679	Laothian	TL	8476	Tagalog
CY	6789	Welsh	LT	7684	Lithuanian	TO	8479	Tonga
DA	6865	Danish	LV	7686	Latvian, Lettish	TR	8482	Turkish
DE	6869	German	MG	7771	Malagasy	TT	8484	Tatar
DZ	6890	Bhutani	MI	7773	Maori	TW	8487	Twi
EL	6976	Greek	MK	7775	Macedonian	UK	8575	Ukrainian
EN	6978	English	ML	7776	Malayalam	UR	8582	Urdu
EO	6979	Esperanto	MN	7778	Mongolian	UZ	8590	Uzbek
ES	6983	Spanish	MO	7779	Moldavian	VI	8673	Vietnamese
ET	6984	Estonian	MR	7782	Marathi	VO	8679	Volapuk
EU	6985	Basque	MS	7783	Malay	WO	8779	Wolof
FA	7065	Persian	MT	7784	Maltese	XH	8872	Xhosa
FI	7073	Finnish	MY	7789	Burmese	YO	8979	Yoruba
FJ	7074	Fiji	NA	7865	Nauru	ZH	9072	Chinese
FO	7079	Faroese	NE	7869	Nepali	ZU	9085	Zulu
FR	7082	French	NL	7876	Dutch			
FY	7089	Frisian	NO	7879	Norwegian			
GA	7165	Irish	OR	7982	Oriya			
GD	7168	Scots Gaelic	PA	8065	Punjabi			
GL	7176	Galician	PL	8076	Polish			
GN	7178	Guarani	PS	8083	Pashto, Pushto			
GU	7185	Gujarati	PT	8084	Portuguese			
HA	7265	Hausa	QU	8185	Quechua			
HI	7273	Hindi	RM	8277	Rhaeto-Romance			
HR	7282	Croatian	RO	8279	Romanian			
HU	7285	Hungarian	RU	8285	Russian			
HY	7289	Armenian	SA	8365	Sanskrit			
IA	7365	Interlingua	SD	8368	Sindhi			

## In Case of Difficulty

If you encounter a problem, please turn the power off, then on again. If the unit is still not functioning normally, please review the items in the following checklist. This guide will help you isolate the problem if the unit is at fault. Otherwise, make sure the rest of your system is properly connected, or then consult your authorized Alpine dealer.

### Basic

#### No function or display.

- Vehicle's ignition is off.
  - If connected according to the instructions, the unit will not operate with the vehicle's ignition off.
- Improper power lead connections.
  - Check power lead connections.
- Blown fuse.
  - Check the fuse on the battery lead of the unit; replace with the proper value if necessary.
- Blackout mode is activated.
  - Cancel Blackout mode.

#### No sound or unnatural sound.

- Incorrect setting of volume/balance/fader controls.
  - Readjust the controls.
- Connections are not properly or securely made.
  - Check the connections and firmly connect.

#### Screen not displayed.

- Brightness control is set at the minimum position.
  - Adjust the Brightness control.
- Temperature in the vehicle is too low.
  - Increase the vehicle's interior temperature to operation temperature range.
- Connections to the DVD, CD player, and navigation system are not securely made.
  - Check the connections and firmly connect.

#### Movement of displayed picture is abnormal.

- Temperature in the vehicle is too high.
  - Allow the vehicle's interior temperature to cool.

#### Unclear or noisy display.

- Fluorescent plate is worn out.
  - Replace the fluorescent plate.

#### Navigation system inoperative.

- Connections to the navigation system are incorrect.
  - Check the connections with the navigation system and connect the cables correctly and firmly.

#### Unclear picture display.

- Fluorescent tube is exhausted.
  - Replace the fluorescent tube\*.

\* The fluorescent tube replacement is not free of charge even within the warranty period, for the tube is an article of consumption.

### Radio

#### Unable to receive stations.

- No antenna, or open connection in the antenna cable.
  - Make sure the antenna is properly connected; replace the antenna or cable if necessary.

#### Unable to tune stations in the seek mode.

- You are in a weak signal area.
  - Make sure the tuner is in DX mode.
- If the area you are in is a primary signal area, the antenna may not be grounded and connected properly.
  - Check your antenna connections; make sure the antenna is properly grounded at its mounting location.
- The antenna may not be the proper length.
  - Make sure the antenna is fully extended; if broken, replace the antenna with a new one.

#### Broadcast is noisy.

- The antenna is not the proper length.
  - Extend the antenna fully; replace it if it is broken.
- The antenna is poorly grounded.
  - Make sure the antenna is grounded properly at its mounting location.
- The station signal is weak and noisy.
  - If above solution does not work, tune in another station.

### CD/MP3/WMA/AAC/DVD

#### Disc playback sound is wavering.

- Moisture condensation in the disc Module.
  - Allow enough time for the condensation to evaporate (about 1 hour).

#### Disc insertion not possible.

- A disc is already in the DVD player.
  - Eject the disc and remove it.
- The disc is being improperly inserted.
  - Make sure the disc is being inserted following the instructions in the CD/MP3/WMA/AAC, DVD Player Operation section.

#### Unable to fast forward or reverse the disc.

- The disc has been damaged.
  - Eject the disc and discard it; using a damaged disc in your unit can cause damage to the mechanism.

#### Disc playback sound skips due to vibration.

- Improper mounting of the unit.
  - Securely re-mount the unit.
- Disc is very dirty.
  - Clean the disc.
- Disc has scratches.
  - Change the disc.
- The pick-up lens is dirty.
  - Do not use a commercial available lens cleaner disc. Consult your nearest ALPINE dealer.

#### Disc playback sound skips without vibration.

- Dirty or scratched disc.
  - Clean the disc; damaged disc should be replaced.

#### CD-R/CD-RW playback not possible.

- Close session (finalisation) has not been performed.
  - Perform finalisation and attempt playback again.

#### Error displays

- Mechanical error
  - Press . After the error indication disappears, insert the disc again. If the above-mentioned solution does not solve the problem, consult your nearest ALPINE dealer.

### MP3/WMA/AAC is not played back.

- Writing error occurred. The CD format is not compatible.
  - Make sure the CD has been written in a supported format. Refer to “About MP3/WMA/AAC” (pages 19 and 20), then rewrite in the format supported by this device.

### Unit does not operate.

- Monitor’s power is not turned on.
  - Turn on the monitor’s power.
- Condensation.
  - Wait a while (about 1 hour) for the condensation to dry.

### No picture is produced.

- Monitor’s mode is not switched to the mode you want to see.
  - Switch to the mode you want to see.
- Monitor’s parking brake lead is not connected.
  - Connect the monitor’s parking brake wire and set the parking brake.  
(For details, refer to the monitor’s instructions.)

### Playback does not start.

- Disc is loaded upside-down.
  - Check the disc and load it with the labelled side facing upward.
- Disc is dirty.
  - Clean the disc.
- A disc not able to play back with this unit is loaded.
  - Check if the disc is able to be played back.
- Parental lock is set.
  - Cancel the parental lock or change the rating level.

### Picture is unclear or noisy.

- Disc is being fast-forwarded or fast-reversed.
  - The picture may be slightly disturbed, but this is normal.
- Vehicle’s battery power is weak.
  - Check the battery power and wiring.  
(The unit may malfunction if the battery power is under 11 volts with a load applied.)
- Monitor’s fluorescent tube is worn.
  - Replace the monitor’s fluorescent tube.

### Image stops sometimes.

- Disc is scratched.
  - Replaced with a non-scratched disc.

### Playing back a DRM protected DivX® File

Some operations cannot be performed while displaying the following message.

#### “Authorization Error This player is not authorized to play this video.”

- If an unauthorized DRM protected DivX® file is played back, the following message is displayed for 2 seconds: “Authorization Error This player is not authorized to play this video”. This means the file’s registration code does not match the player’s and cannot be played back. After the message has been displayed, the beginning of the next file will automatically begin playing.

#### “Rental expired”

- A DivX® rental is set for a fixed number of viewings. If viewing time has counted down to 0, “Rental expired” is displayed for 2 seconds. This indicates that the file can no longer be played. After the message has been displayed, the beginning of the next file will automatically begin playing.

### “Rental Countdown OK?”

- While playing back a rental file, if B.SKIP or ENTER is selected in the file selection menu, “Rental Countdown OK?” is displayed. The rental file playback is interrupted (viewing time is reduced by 1). To confirm stopping playback, touch [Yes], or touch [No] to continue playing the file.

### “View DivX® VOD Rental

**This rental has (remaining times) views left.**

**Do you want to use one of your (remaining times) views now?”**

- If audio/visual times still remain, the remaining number of playback times is displayed. To play back, touch [Yes]. If the next file is to be played back, touch [No].

### Indication for CD/MP3/WMA/AAC

#### No Disc

- No disc is inserted.
  - Insert a disc.
- Although a disc is inserted, “No Disc” is displayed and the unit does not start to play or eject the disc.
  - Remove the disc by following these steps:  
Press ▲ for at least 3 seconds.

#### Mech Error

#### Loading Error

#### Eject Error

- Mechanism error.
  - 1) Press ▲ and eject the disc.  
If not ejecting, consult your Alpine dealer.
  - 2) When the error indication remains after ejecting, press ▲ again.  
If the error indication still does not turn off after pressing ▲ for a few times, consult your Alpine dealer.

#### Disc Error

- Scratched disc, contaminated disc/poor recording/disc incompatible with this unit.
  - Press ▲.
  - Change the disc.

#### Protect

- A copy-protected WMA file was played back.
  - You can only play back non-copy-protected files.

## Indication for DVD

### No Disc

- No disc is inserted.
    - Insert a disc.
  - Although a disc is inserted, “No Disc” is displayed and the unit does not start to play or eject the disc.
    - Remove the disc by following these steps:
      - Press ▲ for at least 3 seconds.
- 



- Button operation on the unit or remote control (optional) is not possible.
    - For some discs or playing modes, certain operations are not possible. This is not a malfunction.
- 

### Mech Error

### Loading Error

### Eject Error

- Mechanism error.
    - 1) Press ▲ and eject the disc.
      - If not ejecting, consult your Alpine dealer.
    - 2) When the error indication remains after ejecting, press ▲ again.
      - If the error indication still does not turn off after pressing ▲ for a few times, consult your Alpine dealer.
- 

### Disc Error

- Scratched disc, contaminated disc/poor recording/disc incompatible with this unit.
    - Press ▲.
    - Change the disc.
- 

### Regional Code Violation

- Disc does not match regional code number.
    - Load a disc that matches the regional code number.
- 

## Indication for USB Memory

### Error 01

- Database error or decoder error.
    - You can solve the problem by switching the source.
- 

### Error 02

- Communication error or boot error, etc.
    - You can solve the problem by reconnecting the USB memory or changing source.
- 

### Current Error

- Abnormal current is run to the USB connector device.
    - You can solve the problem by switching the source.
- 

### Device Error

- A USB device that is not supported by the unit is connected.
    - Connect a USB device that is supported by the unit.
- 

### No USB Device

- A USB Memory is not connected.
    - Make sure the USB Memory device is correctly connected and the cable is not excessively bent.
- 

### No Song

- No song (file) is stored in the USB Memory.
    - Connect the USB Memory device after storing songs (files).
- 

### Unsupported

- A sampling rate/bit rate not supported by the unit is used.
    - Use a sampling rate/bit rate that is supported by the unit.
- 

### Protect

- A copy-protected WMA file was played back.
    - You can only play back non-copy-protected files.
-

## **Indication for iPod Mode**

### **No USB Device**

- The iPod/iPhone is not connected.
    - Make sure the iPod/iPhone is correctly connected (refer to “Connections”).
    - Make sure the cable is not bent excessively.
- 

### **No Song**

- There are no songs in the iPod/iPhone.
    - Download songs to the iPod/iPhone and connect to the IVE-W530BT.
- 

### **Error 01**

- Database error or decoder error.
    - You can solve the problem by switching the source.
- 

### **Error 02**

- Communication error or boot error, etc.
    - You can solve the problem by reconnecting the iPod/iPhone or changing source.
- 

### **Error 03**

- The iPod/iPhone is not verified.
    - You can solve the problem by reconnecting the iPod/iPhone.
- 

### **Current Error**

- Abnormal current is run to the USB connector device.
    - You can solve the problem by switching the source.
-

# Specifications

## MONITOR SECTION

Screen Size	6.1"
LCD Type	Transparent type TN LCD
Operation System	TFT active matrix
Number of Picture Elements	1,152,000 pcs. (800 × 3 × 480)
Effective Number of Picture Elements	99.99% or more
Illumination System	LED

## FM TUNER SECTION

Tuning Range	87.5 – 108.0 MHz
Mono Usable Sensitivity	8.1 dBf (0.7 $\mu$ V/75 ohms)
50 dB Quieting Sensitivity	12 dBf (1.1 $\mu$ V/75 ohms)
Alternate Channel Selectivity	80 dB
Signal-to-Noise Ratio	65 dB
Stereo Separation	35 dB
Capture Ratio	2.0 dB

## MW TUNER SECTION

Tuning Range	531 – 1,602 kHz
Sensitivity (IEC Standard)	25.1 $\mu$ V/28 dBf

## LW TUNER SECTION

Tuning Range	153 – 281 kHz
Sensitivity (IEC Standard)	31.6 $\mu$ V/30 dBf

## USB SECTION

USB requirements	USB 1.1/2.0
Max. Power Consumption	1A
USB Class	USB (Mass Storage Class)
File System	FAT12/16/32
MP3 Decoding	MPEG-1/2 AUDIO Layer-3
WMA Decoding	Windows Media™ Audio
AAC Decoding	AAC-LC format “.m4a” file
Number of Channels	2-Channel (Stereo)
Frequency Response*	20 – 20,000 Hz ( $\pm$ 1 dB)
Total Harmonic Distortion	0.008% (at 1 kHz)
Dynamic Range	95 dB (at 1 kHz)
Signal-to-Noise Ratio	105 dB
Channel Separation	85 dB (at 1 kHz)

\* Frequency response may differ depending on the encoder software/bit rate.

## CD/DVD SECTION

Frequency Response	20 – 20,000 Hz
Wow & Flutter (% WRMS)	Below measurable limits
Total Harmonic Distortion	0.008% (at 1 kHz)
Dynamic Range	95 dB (at 1 kHz)
Channel Separation	85 dB (at 1 kHz)
Signal system	NTSC/PAL
Horizontal resolution	500 lines or greater
Video output level	1Vp-p (75 ohms)
Video S/N ratio	DVD: 60 dB
Audio S/N ratio	105 dB

## PICKUP

Wave length	DVD: 666 nm CD: 785 nm
Laser power	CLASS II

## BLUETOOTH SECTION

BLUETOOTH Specification	BLUETOOTH V 3.0
Output Power	+4 dBm Max. (Power class 2)
Profile	HFP (Hands-Free Profile) HSP (Head Set Profile) A2DP (Advanced Audio Distribution Profile) AVRCP (Audio/Video Remote Control Profile)

## GENERAL

Power Requirement	14.4 V DC (11–16 V allowable)
Operating temperature	+32°F to +113°F (0°C to +45°C)
Maximum Power Output	50 W × 4
Output Voltage	2,000 mV/10k ohms
Weight	2.1 kg (4 lbs. 10 oz)
Audio output level	Preout (Front, Rear): 2V/10k ohms (max.) Preout (Subwoofer): 2V/10k ohms (max.) AUX OUT: 1.2V/10k ohms

## CHASSIS SIZE

Width	178 mm (7")
Height	100 mm (3-15/16")
Depth	150 mm (5-7/8")

- Due to continuous product improvement, specifications and design are subject to change without notice.
- The LCD panel is manufactured using an extremely high precision manufacturing technology. Its effective pixel ratio is over 99.99%. This means that there is a possibility that 0.01% of the pixels could be either always ON or OFF.

## CAUTION

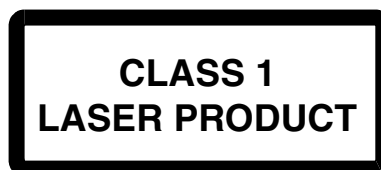

(Bottom side of player)

CAUTION-Laser radiation when open, DO NOT STARE INTO BEAM

(Bottom side of player)

# Installation and Connections

Before installing or connecting the unit, please read the following and pages 6 to 10 of this manual thoroughly for proper use.

## Warning

### **MAKE THE CORRECT CONNECTIONS.**

Failure to make the proper connections may result in fire or product damage.

### **USE ONLY IN CARS WITH A 12 VOLT NEGATIVE GROUND.**

(Check with your dealer if you are not sure.) Failure to do so may result in fire, etc.

### **BEFORE WIRING, DISCONNECT THE CABLE FROM THE NEGATIVE BATTERY TERMINAL.**

Failure to do so may result in electric shock or injury due to electrical shorts.

### **DO NOT ALLOW CABLES TO BECOME ENTANGLED IN SURROUNDING OBJECTS.**

Arrange wiring and cables in compliance with the manual to prevent obstructions when driving. Cables or wiring that obstruct or hang up on places such as the steering wheel, shift lever, brake pedals, etc. can be extremely hazardous.

### **DO NOT SPLICE INTO ELECTRICAL CABLES.**

Never cut away cable insulation to supply power to other equipment. Doing so will exceed the current carrying capacity of the wire and result in fire or electric shock.

### **DO NOT DAMAGE PIPE OR WIRING WHEN DRILLING HOLES.**

When drilling holes in the chassis for installation, take precautions so as not to contact, damage or obstruct pipes, fuel lines, tanks or electrical wiring. Failure to take such precautions may result in fire.

### **DO NOT USE BOLTS OR NUTS IN THE BRAKE OR STEERING SYSTEMS TO MAKE GROUND CONNECTIONS.**

Bolts or nuts used for the brake or steering systems (or any other safety-related system), or tanks should NEVER be used for installations or ground connections. Using such parts could disable control of the vehicle and cause fire etc.

### **KEEP SMALL OBJECTS SUCH AS BOLTS OR SCREWS OUT OF THE REACH OF CHILDREN.**

Swallowing them may result in serious injury. If swallowed, consult a physician immediately.

### **DO NOT INSTALL IN LOCATIONS WHICH MIGHT HINDER VEHICLE OPERATION, SUCH AS THE STEERING WHEEL OR SHIFT LEVER.**

Doing so may obstruct forward vision or hamper movement etc. and results in serious accident.

#### **IMPORTANT**

Please record the serial number of your unit in the space provided below and keep it as a permanent record. The serial number plate is located on the bottom of the unit.

## Caution

### **HAVE THE WIRING AND INSTALLATION DONE BY EXPERTS.**

The wiring and installation of this unit requires special technical skill and experience. To ensure safety, always contact the dealer where you purchased this product to have the work done.

### **USE SPECIFIED ACCESSORY PARTS AND INSTALL THEM SECURELY.**

Be sure to use only the specified accessory parts. Use of other than designated parts may damage this unit internally or may not securely install the unit in place. This may cause parts to become loose resulting in hazards or product failure.

### **ARRANGE THE WIRING SO IT IS NOT CRIMPED OR PINCHED BY A SHARP METAL EDGE.**

Route the cables and wiring away from moving parts (like the seat rails) or sharp or pointed edges. This will prevent crimping and damage to the wiring. If wiring passes through a hole in metal, use a rubber grommet to prevent the wire's insulation from being cut by the metal edge of the hole.

### **DO NOT INSTALL IN LOCATIONS WITH HIGH MOISTURE OR DUST.**

Avoid installing the unit in locations with high incidence of moisture or dust. Moisture or dust that penetrates into this unit may result in product failure.

## Precautions

- Be sure to disconnect the cable from the (–) battery post before installing your IVE-W530BT. This will reduce any chance of damage to the unit in case of a short-circuit.
- Be sure to connect the colour coded leads according to the diagram. Incorrect connections may cause the unit to malfunction or damage to the vehicle's electrical system.
- When making connections to the vehicle's electrical system, be aware of the factory installed components (e.g. on-board computer). Do not tap into these leads to provide power for this unit. When connecting the IVE-W530BT to the fuse box, make sure the fuse for the intended circuit of the IVE-W530BT has the appropriate amperage. Failure to do so may result in damage to the unit and/or the vehicle. When in doubt, consult your ALPINE dealer.
- The IVE-W530BT uses female RCA-type jacks for connection to other units (e.g. amplifier) having RCA connectors. You may need an adapter to connect other units. If so, please contact your authorized ALPINE dealer for assistance.
- Be sure to connect the speaker (–) leads to the speaker (–) terminal. Never connect left and right channel speaker cables to each other or to the vehicle body.
- The Display must be completely retracted in the casing when installing. If it is not, problems may occur.
- When installing in automobiles, make sure the Display can open/close without coming in contact with the shift lever.

SERIAL NUMBER: \_\_\_\_\_  
INSTALLATION DATE: \_\_\_\_\_  
INSTALLATION TECHNICIAN: \_\_\_\_\_  
PLACE OF PURCHASE: \_\_\_\_\_

# Installation

## Caution

Do not block the unit's fan or heat sink, thus preventing air circulation. If blocked, heat will accumulate inside the unit and may cause a fire.

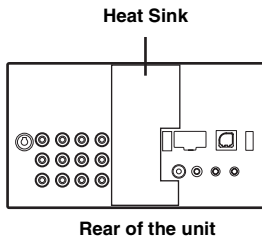

The main unit must be mounted within 30 degrees of the horizontal plane, back to front.

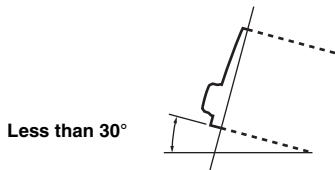

- 1 Remove the mounting sleeve from the main unit (Refer to "Removal" on page 64). Slide the mounting sleeve into the dashboard and fix it with the metal shackles.

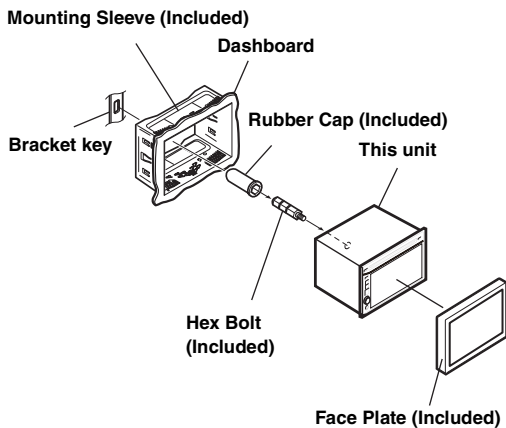

- 2 When your vehicle has the Bracket, mount the long hex bolt onto the rear panel of the IVE-W530BT and put the Rubber Cap on the hex bolt. If your vehicle does not have the Mounting Support, reinforce the head unit with the metal mounting strap (not supplied). Secure the ground lead of the unit to a clean metal spot using a screw (\*1) already attached to the vehicle's chassis. Connect all the leads of the IVE-W530BT according to details described in the CONNECTIONS section.

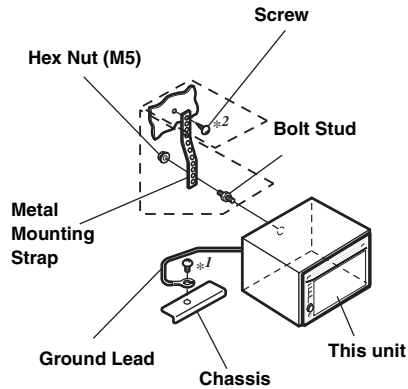

- For the screw marked "\*2", use an appropriate screw for the chosen mounting location.

- 3 Slide the IVE-W530BT into the dashboard until it clicks. This ensures that the unit is properly locked and will not accidentally come out from the dashboard.

## Removal

1. Insert the bracket keys into the unit, along the guides on either side. The unit can now be removed from the mounting sleeve.

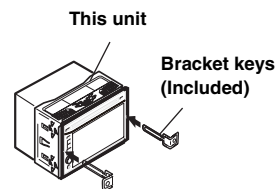

2. Pull the unit out, keeping it unlocked as you do so.



### <JAPANESE CAR>

Take the face plate off, and secure the ground lead of the unit to a clean metal spot using a screw (\*) already attached to the car's chassis.

Attach the Original Mounting Bracket to each side of the IVE-W530BT, using the screws supplied with IVE-W530BT.

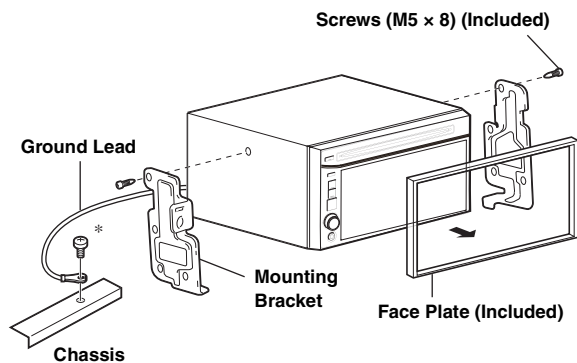

---

## Mounting the Microphone

---

For the sake of safety, mount the microphone in the following location.

- In a stable and secure location.
- In a location that does not inhibit safely driving the vehicle.
- Mount the microphone in a location where the driver's voice can easily be picked up.

Requiring the driver to move towards the microphone for audibility causes a distraction that could be dangerous.

### Connection Diagram of SPST Switch (Sold Separately)

(If the ACC power supply is not available)

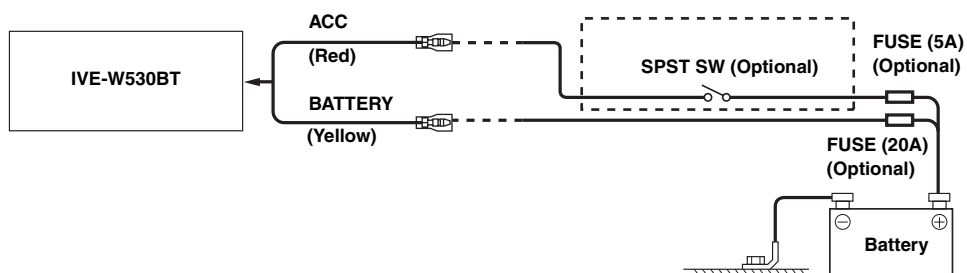

- If your vehicle has no ACC power supply, add an SPST (Single-Pole, Single-Throw) switch (sold separately) and fuse (sold separately).
- The diagram and the fuse amperage shown above are in the case when IVE-W530BT is used individually.
- If the switched power (ignition) lead of the IVE-W530BT is connected directly to the positive (+) post of the vehicle's battery, the IVE-W530BT draws some current (several hundred milliamperes) even when its switch is placed in the OFF position and the battery may be discharged.

#### **To prevent external noise from entering the audio system.**

- Locate the unit and route the leads at least 10 cm away from the car harness.
- Keep the battery power leads as far away from other leads as possible.
- Connect the ground lead securely to a bare metal spot (remove any paint, dirt or grease if necessary) of the car chassis.
- If you add an optional noise suppressor, connect it as far away from the unit as possible. Your Alpine dealer carries various noise suppressors, contact them for further information.
- Your Alpine dealer knows best about noise prevention measures so consult your dealer for further information.

# Connections

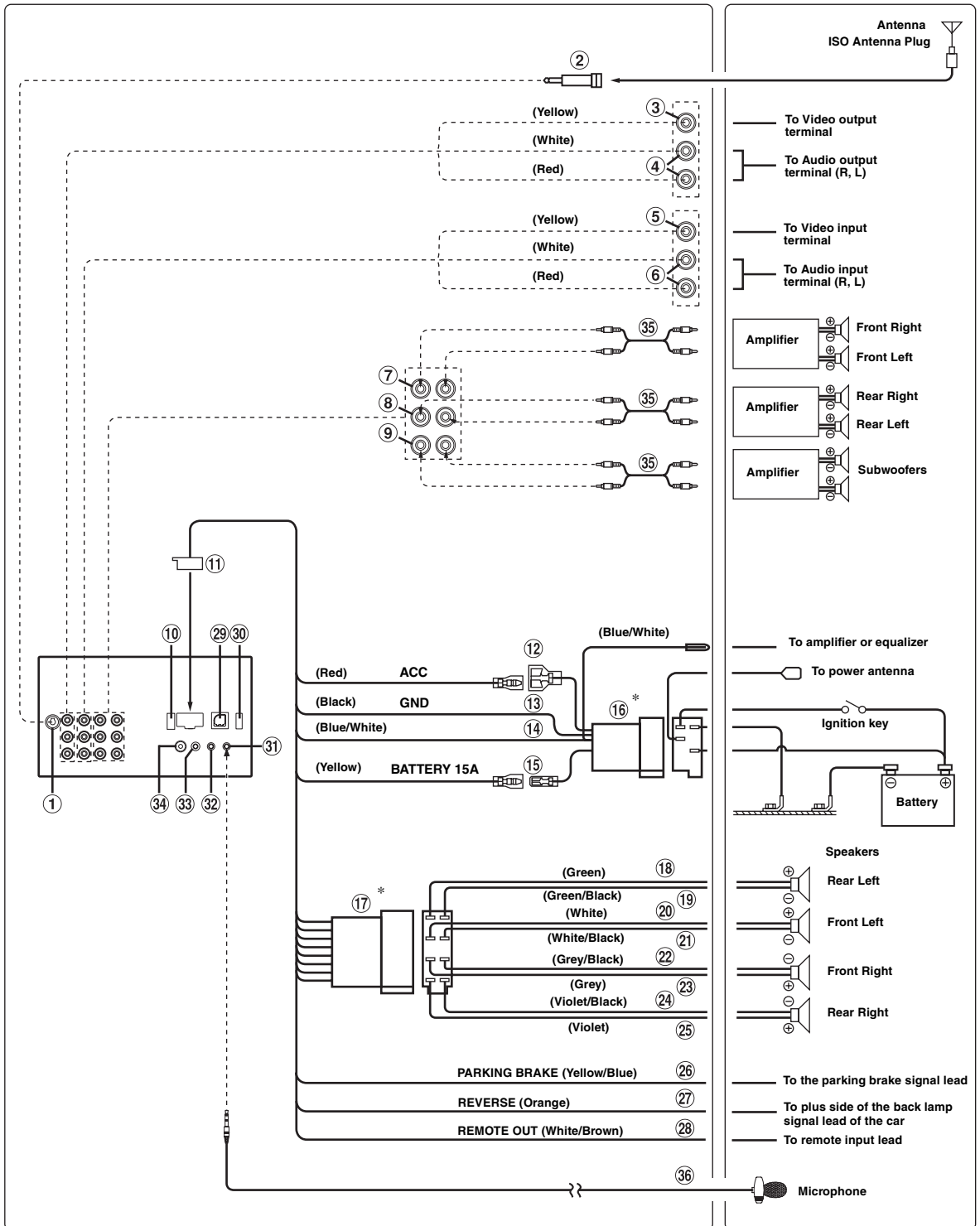

\* ①⑥ ISO Power Supply Connector and ①⑦ ISO Connector (Speaker Output) are integrated.

- ① **Antenna Receptacle**
- ② **ISO/JASO Antenna Adapter (sold separately)**  
ISO/JASO Antenna Adaptor may be required, depending on the vehicle.
- ③ **Video Input Connector (AUX IN) (Yellow)**  
Input the AUX video.
  - *To use this function, turn on "AUX1 IN" in the "SETUP" menu (see "Setting the AUX Mode" on page 40).*
- ④ **Audio Input Connector (AUX IN)**  
RED is down and WHITE is up input the audio.
- ⑤ **Video Output Connector (AUX OUT) (Yellow)**  
Output the video.
- ⑥ **Audio Output Connectors (AUX OUT)**  
RED is down and WHITE is up output the audio.
- ⑦ **Front Output RCA Connectors**  
RED is left and WHITE is right.
- ⑧ **Rear Output RCA Connectors**  
RED is left and WHITE is right.
- ⑨ **Subwoofer Output RCA Connectors**  
RED is left and WHITE is right.
- ⑩ **Fuse Holder (15A)**
- ⑪ **Power Supply Connector**
- ⑫ **Switched Power Lead (Ignition) (Red)**  
Connect this lead to an open terminal on the vehicle's fuse box or another unused power source which provides (+) 12V only when the ignition is turned on or in the accessory position.
- ⑬ **Ground Lead (Black)**  
Connect this lead to a good chassis ground on the vehicle. Make sure the connection is made to bare metal and is securely fastened using the sheet metal screw provided.
- ⑭ **Power Antenna Lead/Remote Turn On Lead (Blue/White)**  
Connect this lead to the +B terminal of your power antenna, if applicable.  
Also connect this lead to the remote turn-on lead of your amplifier or signal processor.
- ⑮ **Battery Lead (Yellow)**  
Connect this lead to the positive (+) post of the vehicle's battery.
- ⑯ **ISO Power Supply Connector**
- ⑰ **ISO Connector (Speaker Output)**
- ⑱ **Left Rear (+) Speaker Output Lead (Green)**
- ⑲ **Left Rear (-) Speaker Output Lead (Green/Black)**
- ⑳ **Left Front (+) Speaker Output Lead (White)**
- ㉑ **Left Front (-) Speaker Output Lead (White/Black)**
- ㉒ **Right Front (-) Speaker Output Lead (Grey/Black)**
- ㉓ **Right Front (+) Speaker Output Lead (Grey)**
- ㉔ **Right Rear (-) Speaker Output Lead (Violet/Black)**
- ㉕ **Right Rear (+) Speaker Output Lead (Violet)**
- ㉖ **Parking Brake Lead (Yellow/Blue)**  
Connect this lead to the power supply side of the parking brake switch to transmit the parking brake status signals to the IVE-W530BT.
- ㉗ **Reverse Lead (Orange)**  
Use only when a back-up camera is connected. Connect to the plus side of the car's reverse lamp. This lamp illuminates when the transmission is shifted into reverse (R).  
With this lead properly wired, the video picture automatically switches to the back-up camera whenever the car is put into reverse (R).
- ㉘ **Remote Control Output Lead (White/Brown)**  
Connect this lead to the remote control input lead. This lead outputs the controlling signals from the remote control.
- ㉙ **RGB Input Connector**  
Connect this to the RGB output terminal of the Navigation System.
- ㉚ **USB Connector**  
Connect this to a USB Memory device or to an iPod/iPhone. To use an iPod/iPhone, an iPod interface cable is required.
  - *Use the supplied USB cable. If a USB cable other than the supplied is used, correct performance cannot be guaranteed.*
  - *Route the USB cable away from other cables.*
- ㉛ **MIC Input Connector**  
To Microphone
- ㉜ **Steering Remote Control Interface Connector**  
To steering remote control interface box.  
For details about connections, consult your nearest Alpine dealer.
- ㉝ **iPod (V)/AUX Input Connector**  
Input the iPhone/video compatible iPod audio/video signal or AUX video/audio signal.
  - *Set "AUX2 IN" to "iPod Video" in "Setting the AUX Mode" (page 40) when an iPhone or a video compatible iPod is connected.*
  - *Set "AUX2 IN" to "AUX" in "Setting the AUX Mode" (page 40) when normal AUX video/audio is input.*
- ㉞ **CAMERA Input Connector**  
Use when the optional rearview camera with RCA Connector is connected.
  - *Set "ON" in "Setting the Rear Camera Input" (page 39) when connecting a rearview camera with RCA output connector.*
- ㉟ **RCA Extension Cable (sold separately)**
- ㊱ **Microphone (Supplied)**

# System Example

## Connecting iPhone/Video compatible iPod and Back-up Camera

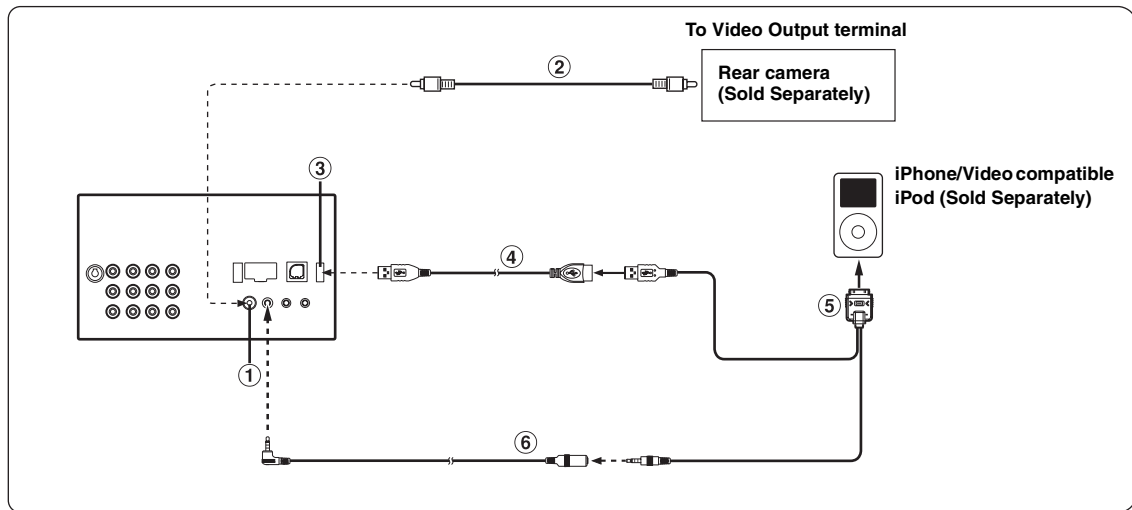

**① CAMERA Input Connector**

Use when the optional rearview camera with RCA connector is connected.

- Set "ON" in "Setting the Rear Camera Input" (page 39) when connecting a rearview camera with RCA Output connector.

**② RCA Extension Cable (Sold Separately)**

**③ USB Connector**

**④ USB extension cable (Included)**

**⑤\* USB 30P cable (Sold Separately)**

**⑥\* AV extension cable (Sold Separately)**

\* The optional accessory KCU-461iV contains ⑤ and ⑥, you cannot individually purchase ⑤ or ⑥.

## When Connecting External Equipment

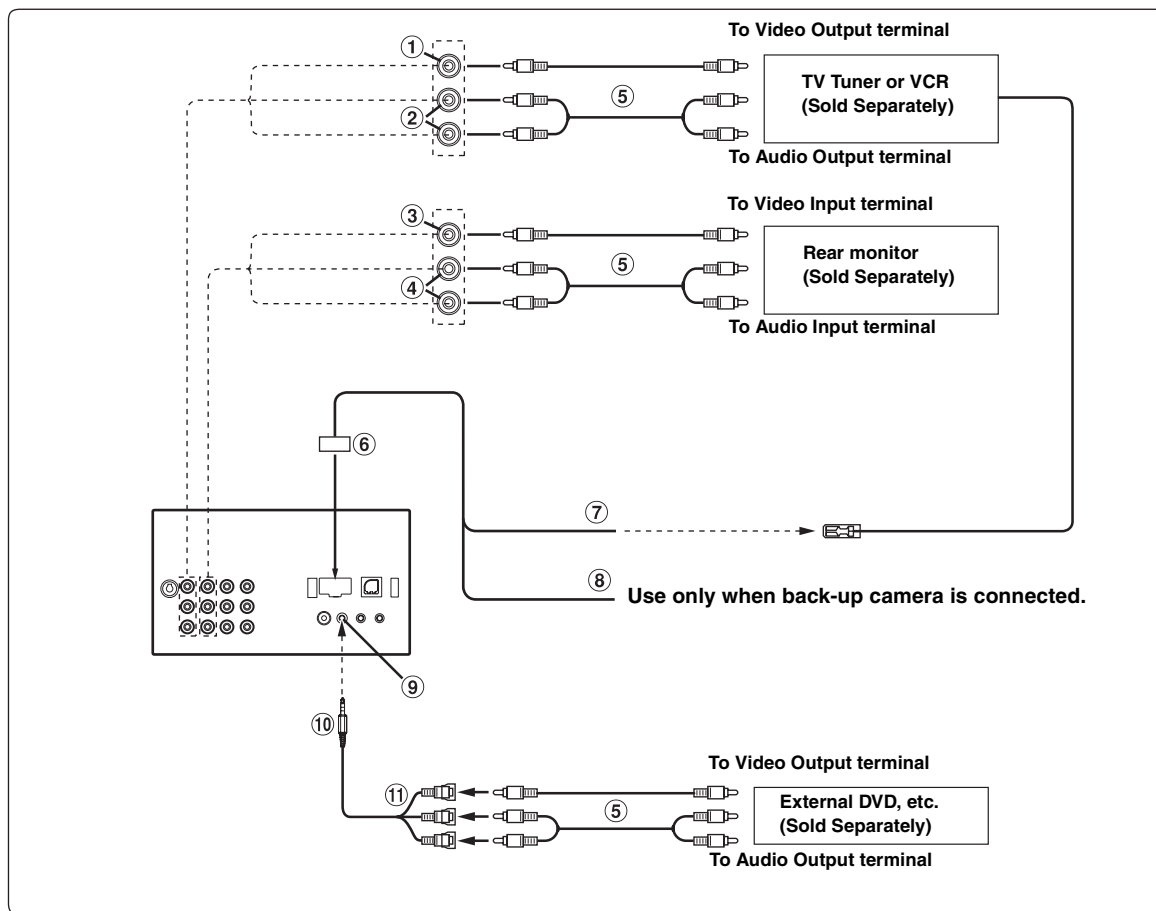

① **Video Input Connector (AUX IN) (Yellow)**

Input AUX video.

- To use this function, turn on "AUX1 IN" in the "SETUP" menu (see "Setting the AUX Mode" on page 40).

② **Audio Input Connectors (AUX IN)**

RED is right and WHITE is left input the audio.

③ **Video Output Connector (AUX OUT) (Yellow)**

Output the video.

④ **Audio Output Connectors (AUX OUT)**

RED is right and WHITE is left output the audio.

⑤ **RCA Extension Cable (Sold separately)**

⑥ **Power Supply Connector**

⑦ **Remote Control Output Lead (White/Brown)**

⑧ **Reverse Lead (Orange)**

Use only when a back-up camera is connected. Connect to the plus side of the car's reverse lamp. This lamp illuminates when the transmission is shifted into reverse (R). With this lead properly wired, the video picture automatically switches to the back-up camera whenever the car is put into reverse (R).

⑨ **iPod (V)/AUX Input Connector**

Input the iPhone/video compatible iPod audio/video signal or AUX video/audio signal.

- Set "AUX2 IN" to "AUX" in "Setting the AUX Mode" (page 40) when normal AUX video/audio is input.
- When you use this connector as normal video/audio input connector (AUX 2 Input), an optional AV/RCA interface cable should be used. For details, refer to ⑪.

⑩ **AV/RCA interface cable (4-pole mini AV plug to 3-RCA) (Sold Separately)**

■ **Usable 4-pole mini AV plug**

Wiring convention of this system is as follows:

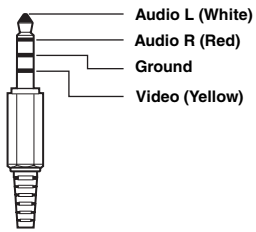

- *This configuration is not standardized for commercially available AV plugs. Please confirm compatibility before purchasing.*

⑪ **Video/Audio Input Connectors**

YELLOW is for input video, RED is right and WHITE is left input the audio.

**About the Rules of Bluetooth Electromagnetic Radiation Regulation**



**Declaration of Conformity**

# Declaration of Conformity

We, the undersigned,

**Authorized representative in Europe : Alpine Electronics (Europe) GmbH**

**Address, City : Wilhelm-Wagenfeld-Strasse 1-3, D-80807, Munich**

**Country : Germany**

certify and declare under our sole responsibility that the following apparatus :

**Description : Mobile Media Station**

**Manufacturer : Alpine Electronics, Inc.**

**Brand : ALPINE**

**Identification : IVE-W530BT**

**Installed BlueTooth module : FC6000 (FC6000S)**

**Test Report No. :**

**Radio :MDE\_PARRO\_1101\_RADa (7 layers AG)**

**EMC :MDE\_PARRO\_1101\_EMCa (7 layers AG)**

**LVD : R051-26-11-101552/A Ed.0 (EMITECH ATLANTIQUE Lab.)**

conforms with the essential requirements of the Radio and Telecommunications Terminal Equipment Directive 1999/5/EC, based on the following specifications applied:

**Radio : EN300328 V1.7.1(2006-10)**

**EMC : EN301489-1 V1.8.1 (04/2008)**

**LVD : EN60950-1: 2006/A11: 2009 )**

and therefore complies with the essential requirements and provisions of the R&TTE Directive.

*The Technical documentation is kept at the following address:*

**Company : Alpine Electronics (Europe) GmbH**

**Address, City : Wilhelm-Wagenfeld-Strasse 1-3, D-80807, Munich**

**Country : Germany**

**Phone number : 49(0)89-324264-240**

**Fax number/e-mail : 49(0)89-324264-241**

**Name and position of person binding the manufacturer or his authorized representative : Shinichi Asuke  
Global Engineering Strategy Office  
Alpine Electronics, Inc.**

**Signature of the authorized person : **

**Date of issue : February 17, 2012**