

AMANO®

ELECTRONIC TIME RECORDER

BX1500

OPERATION MANUAL

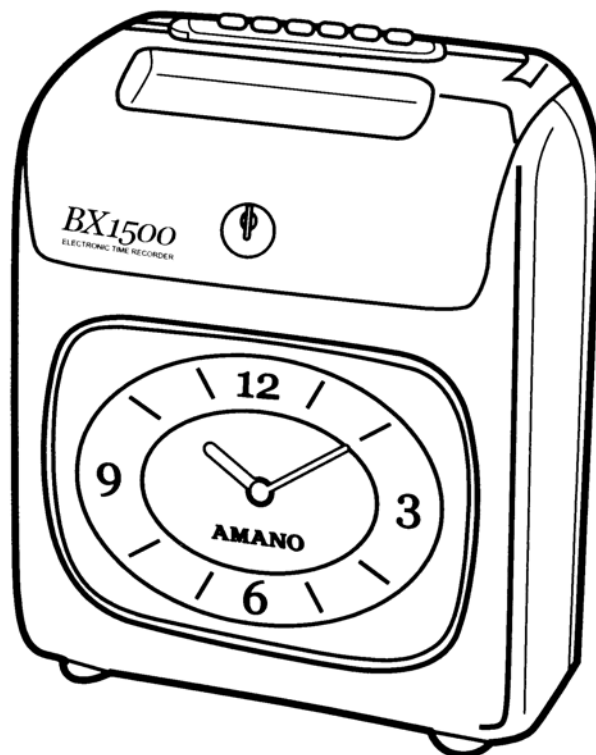

■ Important safety information

Precautions given in this manual are being categorized depending on the degree and content of hazardousness as follows. Do not fail to read these precautions carefully before starting use of this product.

⚠ Warning: Warns possibilities of occurrences of fatal or serious physical injuries unless its content is duly observed.

⚠ Caution: Cautions possibilities of occurrences of physical injuries or of material damages and losses unless its content is duly observed.

- Serious physical injuries includes losing the eyesight, suffering a physical injury, suffering a burn (high temperature or low temperature), receiving an electric shock, suffering a fracture and poisoning, which are to leave after-effects or which require hospitalization or extensive attendance to the hospital to cure.
- Physical injuries include suffering a burn and receiving an electric shock although hospitalization or extensive attendance to the hospital may not be necessary to cure.
- Material damages and losses include damages and losses on houses, household belongings, livestock and pets.

• Examples of illustrative indications



Triangular framing stands for a warning or a caution. Specific content is being illustratively represented inside the triangular frame.



⊘ framing stands for a prohibition. Specific content is being illustratively represented inside the circular frame.



The reversed circle framing stands for an indispensability. Specific content is being illustratively represented inside the circular frame in reversed print.

TABLE OF CONTENTS

INTRODUCTION	1-1
Components	1-1
Note	1-1
FOR THE OPERATIONAL SAFETY	1-2
NAMES OF PARTS	1-4
Names of Exterior Parts	1-4
Programming Section	1-5
CAUTIONS WHEN INSTALLING	1-7
Installation	1-7
Wall Mounting	1-8
Power Source	1-9
OPERATION	1-10
Selecting the Print Column	1-10
Inserting Time Cards	1-10
SETTING	1-11
Opening / Closing the Lid	1-11
Setting Imprint	1-12
Changing Pay Period Ending Date	1-15
Day Time Change	1-17
Setting the Clock	1-18
Setting Daylight Savings Time	1-21
TROUBLESHOOTING	1-23
Troubleshooting	1-23
List of Error Codes	1-24
IF PRINTS BECOME DIM (Replacing Ribbon Cassette)	1-25
APPENDIX	1-26
Daily Maintenance	1-26
Specifications	1-26
Initial Values	1-27

INTRODUCTION

Read this manual carefully for safe and proper use of the product. Also, after reading this manual, preserve it at a handy location for quick reference at needs.

- ◆ The specifications, appearance, and descriptions are subject to change due to improvement.
- ◆ This manual has been carefully prepared, but if you find any errors or any descriptions which you cannot understand clearly, contact the dealer from whom you have bought your time recorder.

Components

BX1500 components are as follows. Be sure to check before operation that all components are supplied.

- BX1500 time recorder



- A bracket for wall installation



- An operation manual (this manual)



- A spare fuse
110-120VAC.....250V, 700mA
220-240VAC.....250V, T500mA
(Attached to the front case)



- One pair of keys (two keys)

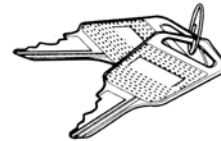

- Seals for different languages

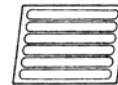

Note









BX1500 time recorders will not operate normally unless installed in a proper environment. Do not install them outdoors or where they are exposed to rain.

FOR THE OPERATIONAL SAFETY

ENGLISH

Carefully read to fully appreciate the following warnings and cautions before starting use of the equipment.

⚠ Warning

- 
 - **Do not use with any power voltage other than that indicated on the product.**
This could cause fire or electric shock.
- 
 - **Do not overload power outlet.**
This could cause fire or electric shock.
- 
 - **Do not connect or disconnect power plug with wet hand.**
This could cause electric shock.
- 
 - **Do not damage or break power cord.**
If a heavy object is put on it, or the cord is pulled or bent forcibly, the cord may be damaged and this could cause fire or electric shock.
- 
 - **Do not remove any parts other than the lid.**
There is high voltage part inside, and touching it could cause an electric shock.
- 
 - **Do not remodel the time recorder.**
This may cause fire or electric shock.
- 
 - **If any abnormality occurs such as smoke, smell or heat, disconnect the power plug from the power outlet and contact your dealer.**
Continued use of the time recorder in the above cases could cause fire or electric shock.
- 
 - **If foreign matter (metal piece, water or other liquid) get inside the time recorder, immediately disconnect the power plug from the power outlet and contact your dealer.**
Continued use of the time recorder in this case cause fire or electric shock.
- 
 - **To avoid fire hazard, use only a fuse of the correct type, voltage rating, current rating as specified by the manufacturer:**

Power source	Fuse
110-120VAC	250V, 700mA
220-240VAC	250V, T500mA (Time Lag) with a low breaking capacity.

 - Use of any other materials for fuse will cause fire.
Make sure that the fuse has the proper specified capacity prior to use.
- 
 - **When replacing the fuses, do not use fuses that exceed the specified capacity or use wire and silver paper.**
Use of any other materials for fuse will cause fire.
Make sure that the fuse has the proper specified capacity prior to use.

 **Caution**



- **Do not install the time recorder in unstable or inclined place.**
The time recorder could drop or fall, causing an injury.



- **Do not put a water container or metal object on the time recorder.**
If water or metal object gets inside the time recorder, it may cause fire or electric shock.



- **Do not install this time recorder in any place where there is oily smoke or moisture near the cooking table or humidifier. Also do not install it in a dusty place.**
Either of the above could cause fire or electric shock.



- **For mounting the time recorder on the wall, use a fixture suitable to wall material so that the weight of the unit can be securely held.**
If not, the time recorder may fall, causing an injury.



- **Be sure to hold the plug when the power plug is being disconnected from the power outlet.**
If you pull the power cord, it may be damaged, causing fire or electric shock.



- **Before replacing the ribbon cassette, remove the lid and disconnect the power plug from the power outlet.**
Replacing the ribbon cassette while the power plug is connected may cause injury or electric shock.

The Operator should be grounded first before starting maintenance.

If maintenance is started before he is properly grounded, the equipment may be damaged by static electricity.

NAMES OF PARTS

Names of Exterior Parts

ENGLISH

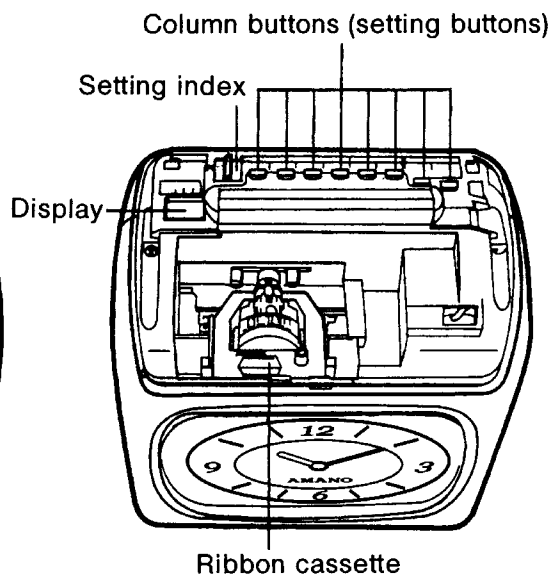
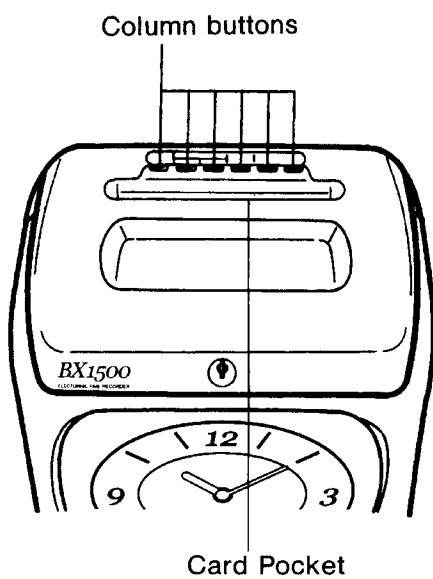
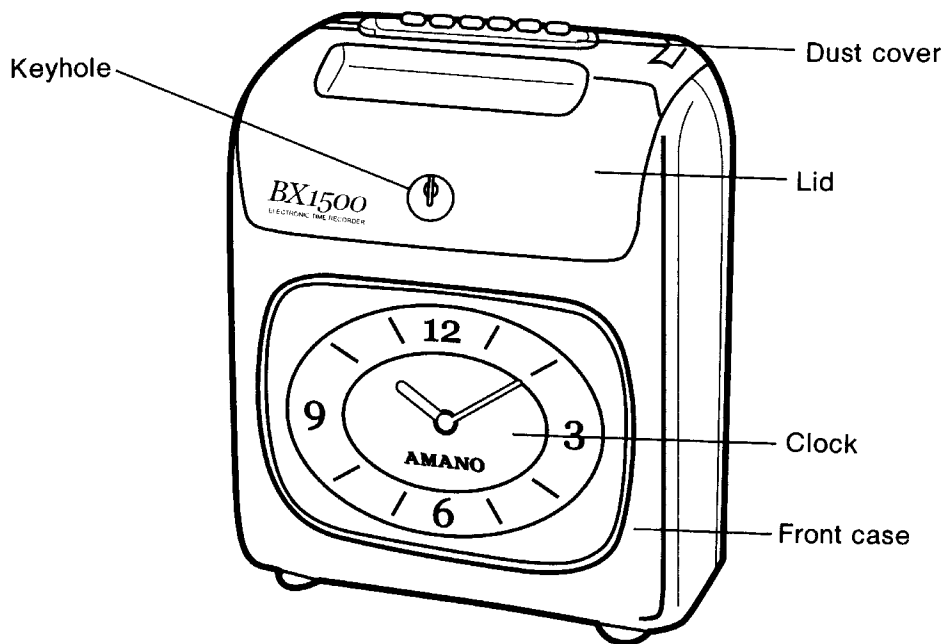

Programming Section

Open the lid to set each item. (See page 1-11.) Turn the dial at the left side to rotate the setting index. Setting index ① and setting index ② can be selected. Press the button at the front of the setting index to operate. For setting details see pages 1-12~1-22.

Setting Index ①

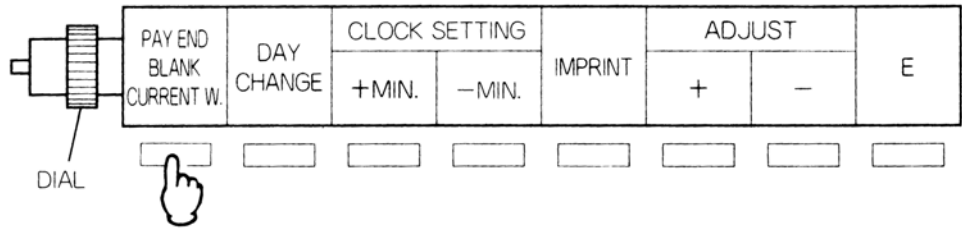

PAY END BLANK CURRENT W.	This button is used to select a pay period ending date or week, a blank row position on time card (monthly pay only) or a current week (in case of bi-weekly pay only). Press the “+” or “-” button to change the value.
DAY CHANGE	This button is used to change the time at which the date changes over. Press the “+” or “-” button to change the value.
CLOCK SETTING + MIN.	Each time this button is pressed, the clock advances one minute. Keep it pressed to advance the minute quickly. When this button is pressed, the clock will start running with the second set to “00” automatically.
CLOCK SETTING - MIN.	
IMPRINT	Use this button to change print formats such as card type, 24hours/12hours indication printing change, minute imprint, day of the week, etc.
ADJUST +	Press this button once to increase a set value by 1. Hold this button down to increase the set value quickly.
ADJUST -	
E	Press this button to register set values.

Setting Index ②

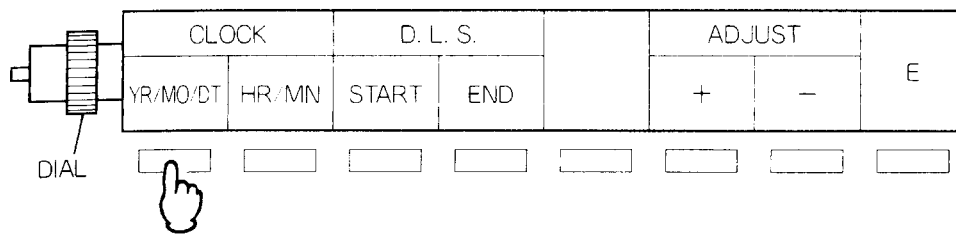



CLOCK	Use this button to change year, month, and day. To change these values, press the “+” or “-” button.
YR/MO/DT	
CLOCK	Use this button to change hour and minute. To change these values, press the “+” or “-” button.
HR/MN	
D.L.S.	Use this button to set the starting date of daylight savings time. The starting date can be set by designating a year, a month and date. The change-over time can be set at any time between one o'clock and nine o'clock in hour units. Change the value by pressing the “+” or “-” button.
START	
D.L.S.	Use this button to set the ending date of daylight savings time. If both the starting and the ending dates are set to the same date, the set daylight savings time is canceled. If only the starting date or the ending date is set, the daylight savings time function will not operate. Change the value by pressing the “+” or “-” button.
END	
ADJUST	Press this button once to increase a set value by 1. Hold this button down to increase a set value quickly.
+	
ADJUST	Press this button once to decrease a set value by 1. Hold the button down to decrease a set value quickly.
-	
E	Press this button to register set values.

CAUTIONS WHEN INSTALLING

Installation

Proper installation and good power conditions will enable you to operate the time recorder for a long time.

⚠ Caution

-  • **Do not install the time recorder in unstable or inclined place.**
The time recorder could drop or fall, causing an injury.
-  • **Do not put a water container or metal object on the time recorder.**
If water or metal object gets inside the time recorder, it may cause fire or electric shock.
-  • **Do not install this time recorder in any place where there is oily smoke or moisture near the cooking table or humidifier. Also do not install it in a dusty place.**
Either of the above could cause fire or electric shock.

Installation location

- Prepare a stand about 75cm high.
- Install the time recorder horizontally.



Improper installation locations

- Places exposed to direct sunlight or close to heat sources



- Places exposed to rain



- Dusty or unstable places



- Places exposed to strong vibrations or shocks



Wall Mounting

⚠ Caution



- For mounting the time recorder on the wall, use a fixture suitable to wall material so that weight of this unit can be securely held.

If not, the time recorder may fall, causing an injury.

- 1 Insert a screw into the wall.

Place one screw about 94cm (37") to 124cm (48.8") above the floor. At this height the time recorder is easy to use.

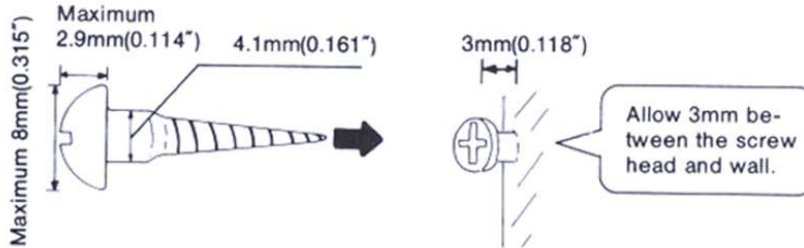

- 2 Insert a second screw into the wall.

Place this screw 13cm to 13.5cm immediately below the first screw.

- 3 Peel off the protective paper.

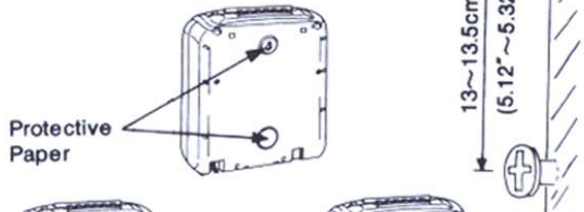

- 4 Install the bracket into the bell-bottom hole (a hole, located lower than the other hole on the rear surface of the case).

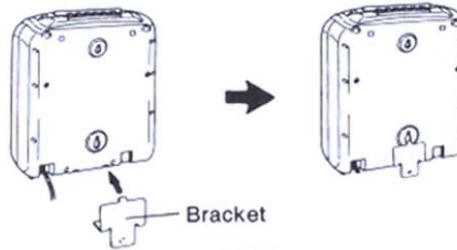

- 5 Hook the unit on the screws through the holes on the back of the case.

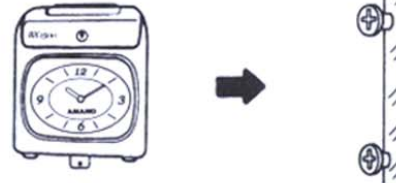

- 6 Secure the bracket to the wall with the lower screw.



Wall Mounting

⚠ Caution



- For mounting the time recorder on the wall, use a fixture suitable to wall material so that weight of this unit can be securely held.
If not, the time recorder may fall, causing an injury.

- 1 Insert a screw into the wall.
Place one screw about 94cm (37") to 124cm (48.8") above the floor. At this height the time recorder is easy to use.

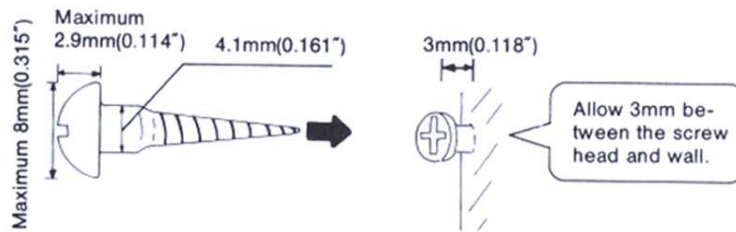

- 2 Insert a second screw into the wall.
Place this screw 13cm to 13.5cm immediately below the first screw.

- 3 Peel off the protective paper.

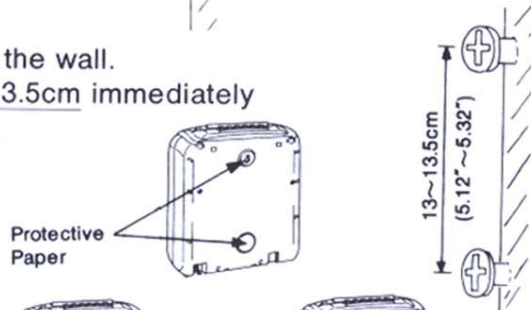

- 4 Install the bracket into the bell-bottom hole (a hole, located lower than the other hole on the rear surface of the case).

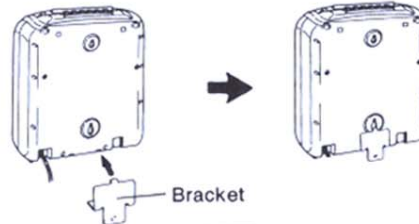

- 5 Hook the unit on the screws through the holes on the back of the case.

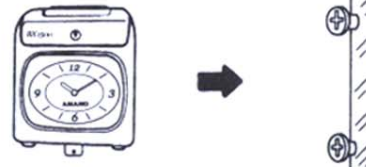

- 6 Secure the bracket to the wall with the lower screw.



Power Source

⚠ Warning



- Do not use with any power voltage other than that indicated on the product.
This could cause fire or electric shock.



- Do not remodel the time recorder.
This may cause fire or electric shock.



- Do not overload power outlet.
This could cause fire or electric shock.



- If any abnormality occurs such as smoke, smell or heat, disconnect the power plug from the power outlet and contact your dealer.
Continued use of the time recorder in the above cases could cause fire or electric shock.



- Do not connect or disconnect power plug with wet hand.
This could cause electric shock.



- If foreign matter (metal piece, water or other liquid) get inside the time recorder, immediately disconnect the power plug from the power outlet and contact your dealer.
Continued use of the time recorder in this case cause fire or electric shock.



- Do not damage or break power cord.
If a heavy object is put on it, or the cord is pulled or bent forcibly, the cord may be damaged and this could cause fire or electric shock.



- Do not remove any parts other than the lid.
There is high voltage part inside, and touching it could cause an electric shock.

⚠ Caution



- Be sure to hold the plug when the power plug is being disconnected from the power outlet.
If you pull the power cord, it may be damaged, causing fire or electric shock.

Insert the power plug into the power outlet.

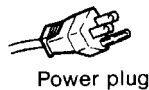
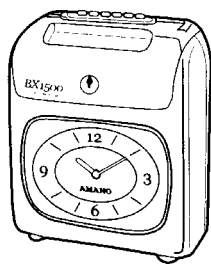

Power plug

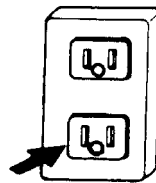

Power outlet

110-120V AC or 220-240V AC
50/60Hz

- Use a power source with a stable voltage.
- Use a power source that supplies continuous voltage and is independent of other equipment.
- The time recorder has a built-in lithium battery, on which the inner clock runs and which stores the programming data. (The battery is effective for three years of cumulative power failure hours.)

OPERATION

Selecting the Print Column

Press an appropriate IN or OUT button to select the print position for time cards.

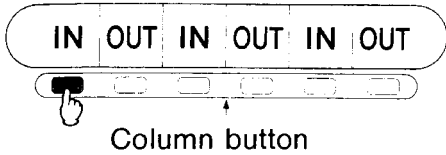

- ◆ Time cards are printed in the column where the column button light is on. To change the print position, press the button corresponding to the desired print position.
- ◆ The print position on time cards remains unchanged until another column button is pressed.

ENGLISH

Inserting Time Cards

Insert a time card lightly in the card pocket. The card is automatically pulled in and printed.

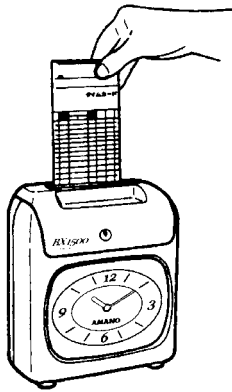

Surface Detection Function (see page 1-12.)

If a time card is inserted backwards by mistake, a long “beep” sound will occur, and the card will be rejected. (The surface detection function can be set only when the Monthly pay card is used.)

- ◆ Time cards are automatically pulled in. Do not push them in the card pocket by force, and do not try to pull them out during printing.
- ◆ If a time card is inserted upside down by mistake, it will be printed. Be careful to correctly insert time cards in the card pocket.
- ◆ Do not insert any objects other than time cards.

Initial Print after Time Change

If the clock time has been adjusted to a time change of 5 minutes or more from the currently displayed time, the first printing after the change was made will print the “Hour” in small print. If the change in time is less than 5 minutes, the printing will remain as normal.

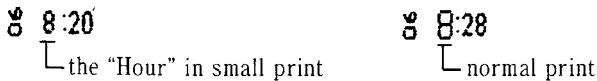

- The “Hour” is in small print for the first printing when the BX1500 is first operated or after the time has been changed ± 5 minutes or more.
- If the parameters of daylight savings time is set on the day when the automatic time change is to take place, the first printing after the automatic time change will have the “Hour” in small print.
- If a time change of ± 5 minutes or more is made and the clock time is then switched back to within ± 5 minutes of the “actual time” (including the time that has elapsed), the printing will be normal.

Note : Since this is an easily recognized feature on time cards, it can also be used as a method of indicating any unauthorized time changes.

SETTING

Opening/Closing the Lid

Open the lid when you adjust time, change pay period ending date, change year, month or day, replace ribbon cassette, etc.

Note : Open/close the lid with power turned on.

How to open

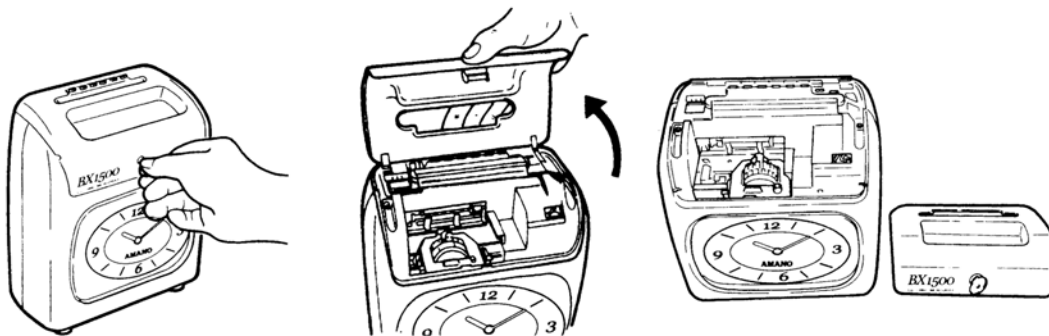

1. Insert the key into the keyhole and turn clockwise.
2. Open the lid upward.
3. Remove the lid.

How to close



1. Engage the hooks of the lid with the hooks of the unit.
2. Close the lid.
3. When the lid is closed, the hands of the clock indicate the current time. Return the key to the original position.

Setting Imprint

Print formats are changed as follows :

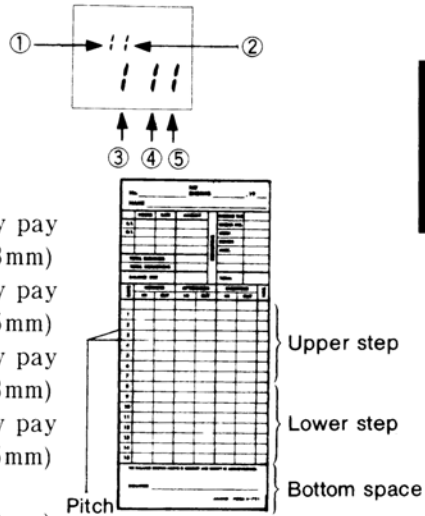

①Card Type (with 6mm pitch)
 Select from 1~7 the mode which applies to the card you use.
 ※With 7mm pitch (special order), choose either "2" or "4".

- 1 : Monthly pay
- 2 : Upper step weekly pay (Bottom space : 23mm)
- 3 : Upper step weekly pay (Bottom space : 35mm)
- 4 : Lower step weekly pay (Bottom space : 23mm)
- 5 : Lower step weekly pay (Bottom space : 35mm)
- 6 : Bi-weekly pay (Bottom space : 23mm)
- 7 : Bi-weekly pay (Bottom space : 35mm)

②Surface Detection Function

*The surface detection function operates only when you use Amano time cards (monthly pay cards) or an equivalent with a surface detection cut-out.

When using a monthly pay time card, select 1 or 2. When using a weekly or bi-weekly pay time card, 2 is automatically set.

	Surface detection function
1	operational
2	not operational

The selection of setting is possible only when [1: monthly pay] cards are used. When [2~4: weekly or Bi-weekly pay] cards are used, the setting is fixed at [2: not operational].

③Print Format

- 1 : 24 hours (0~23 hours) (0 is not printed at the tens digit of hour. Example : 9 : 00)
- 2 : 12 hours (AM/PM hours) (Minute is underlined for PM. Example : 9 : 00)
- 3 : 24 hours (0~23 hours) (0 is printed at the tens digit of hour. Example : 09 : 00)

④Minute Indication

- 1 : Minutes 2 : 1/100 hour A
- 3 : 1/100 hour B 4 : 1/10 hour

1/100 hour A, 1/100 hour B, and 1/10 hour:

Minute	0	1	2	3	4	5	6	7	8	9	~	29	30	31	32	33	34	35	~	54	55	56	57	58	59
1/100 hour A	00	02	03	05	07	08	10	12	13	15	~	48	50	52	53	55	57	58	~	90	92	93	95	97	98
1/100 hour B	00	00	00	05	05	05	10	10	10	15	~	45	50	50	50	55	55	55	~	90	90	90	95	95	95
1/10 hour	0	0	0	0	0	0	1	1	1	1	~	4	5	5	5	5	5	5	~	9	9	9	9	9	9

⑤Day of the week indication

- 0 : Date 1 : English 2 : Spanish 3 : French
- 4 : German 5 : Italian 6 : Japanese
- 7 : DAY NO. (1~ 7) 8 : No indication

Example : Set “Lower step weekly pay (Bottom space : 23mm)”, “Surface detection function not operational”, “12-hour system printing”, “1/100 hour B” and “Date printing”.

1 Open the lid and turn the setting index.

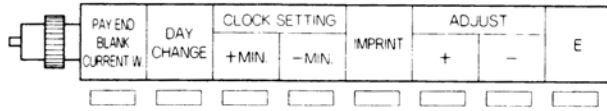

2 Press the “IMPRINT” button. The initial value will appear.

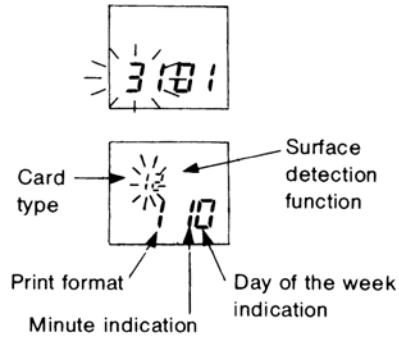

3 To change the card type, press the “+” or “-” button and set “4”. Press the “E” button to register it.



4 To change the surface detection function, perform the following:
When [2~7: weekly / Bi-weekly pay] cards are used, the automatic surface detection function is automatically set to [2: not operational]. When [1: monthly pay] cards are used, select the setting using the “+” or “-” button and set by pressing the “E” button.



5 To change the print format, press the “+” or “-” button and set “2”. Press the “E” button to register it.



6 To change the minute indication, press the “+” or “-” button and set “3”. Press the “E” button to register it.



- 7 To change the day of the week indication, press the “+” or “-” button and set “0”. Press the “E” button to register it.



ENGLISH

The setting is completed. Close the lid.
If required, other settings can also be performed before closing the lid.

Changing Pay Period Ending Date

Pay period ending date can be set three ways : weekly pay, bi-weekly pay and monthly pay. Select the desired one. Make the selection when setting imprint. (See pages 1-12~1-14.)

〈Weekly pay〉

Example : Set the pay period ending day to Monday.

- 1 Open the lid and turn the setting index.

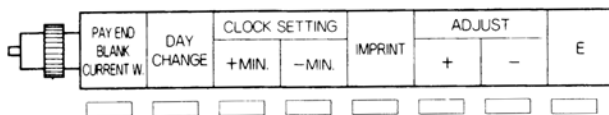

- 2 Press the PAY END button, and the initial value will appear. (The 5 mark blinks at "FR".)

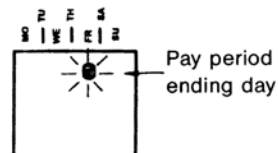

- 3 Press the "+" or "-" button and bring the 1 mark to "MO". Press the "E" button, and the blinking 1 mark stops blinking. The setting has been registered.

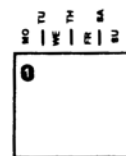

〈Bi-weekly pay〉

Example : Set the pay period ending day to Sunday and the current week to the second week.

- 1 Open the lid and turn the setting index.

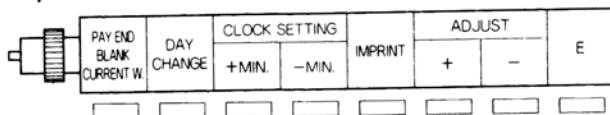

- 2 Press the PAY END button, and the initial value will appear. (The 5 mark blinks at "FR", and the current week is the first week.)

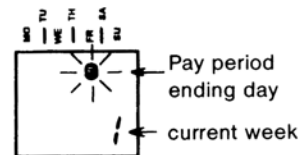

- 3 Press the "+" or "-" button and bring the 7 mark to "SU". Press the "E" button, and the blinking 7 mark stops blinking. The setting has been registered.

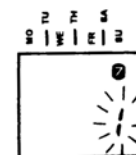

- 4 Press the "+" or "-" button to change the number to "2". Press the "E" button, and the blinking number stops blinking. The setting has been registered.



<Monthly pay>

For the “Monthly Pay”, assign “pay period ending date” and “blank row”. A blank row means a row is left blank out of the 32 rows on the front and back of a time card. The top row of the front is numbered 01 and the last row on the back is numbered 32. The desired row can be set by designating the number.

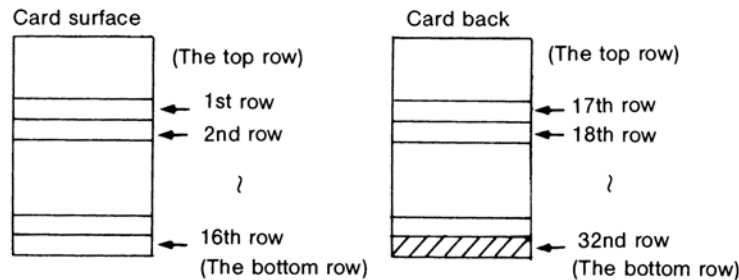

Example : Set the pay period ending date to the 25th and the blank row to the 17th.

- 1 Open the lid and turn the setting index.

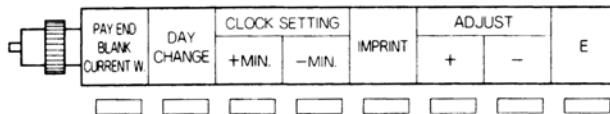

- 2 Press the “PAY END” button, and the initial value will appear. (The pay period ending date is the 31st, and the blank row is the 1st.)

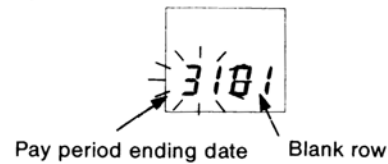

- 3 Press the “+” or “-” button to change the pay period ending date and set 25 in place of 31. Press the “E” button to register it.



- 4 Press the “+” or “-” button to change the blank row and set 17 in place of 01. Press the “E” button to register it.

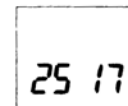

The setting is completed. Close the lid.

If required, other settings can also be performed before closing the lid.

the lid.

Day Time Change

A day time change is the time when a print row is changed on a time card. When a day time change is made, only hours are changed, and the minutes portion is fixed at 00. The initial day time change has been set at 3 o'clock a.m.

Example : Set the day time change at 5 : 00.

- 1 Open the lid and turn the setting index.

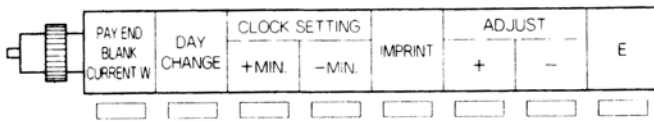

- 2 Press the "DAY CHANGE" button. The initial value will appear. (3 : 00)



- 3 Press the "+" or "-" button, then set "05 : 00". Press the "E" button, and the blinking display will stop blinking. The setting has been registered.



The setting is completed. Close the lid.

If required, other settings can also be performed before closing the lid.

Setting the Clock

There are two procedures : setting the minutes, and setting the date and hour.

Setting Minutes

- 1 Open the lid and turn the setting index.

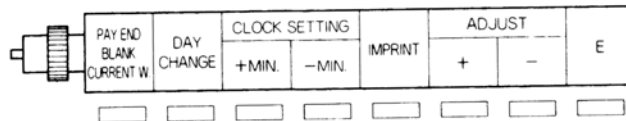

- 2 Correct the time by using the “+ MIN.” and “- MIN.” buttons.

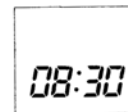
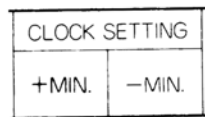

Each time this button is pressed, the clock advances one minute. Keep it pressed to advance the minute quickly. When this button is pressed, the clock will start running with the second set to “00” automatically.

Each time this button is pressed, the clock will decrement one minute. Keep it pressed to decrement the minute quickly. When this button is pressed, the clock will start running with the second set to “00” automatically.

When [+MIN.] or [-MIN.] button is pressed, the display will change to the clock.
 * If the clock is advanced or delayed only a few minutes, adjust the time by pressing [+MIN.] or [-MIN.] button.
 If the clock is advanced more than ten minutes, adjust the time by pressing [HR/MN] button described in Setting the Date.
 (See page 1-20.)

Setting the Date

Year, month, date, hour, and minute are set as follows :

Press the “+” or “-” button to change values. Be sure to press the “E” button before setting a new item or when registering values.

〈Setting of Year, Month, and Date〉

Example : Change December 18, 2001 to April 21, 2002.

- 1 Open the lid and turn the setting index.

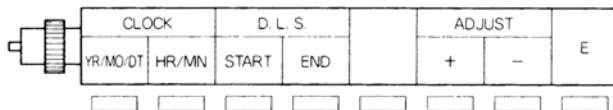

- 2 Press the “YR/MO/DT” button.
- 3 Press the “+” or “-” button to change the year and press the “E” button. If it is not necessary to change the year, press the “E” button.
- 4 Press the “+” or “-” button to change the month and press the “E” button. If it is not necessary to change the month, press the “E” button.
- 5 Press the “+” or “-” button to change the date. Press the “E” button to register the setting. If it is not necessary to change the date, press the “E” button.

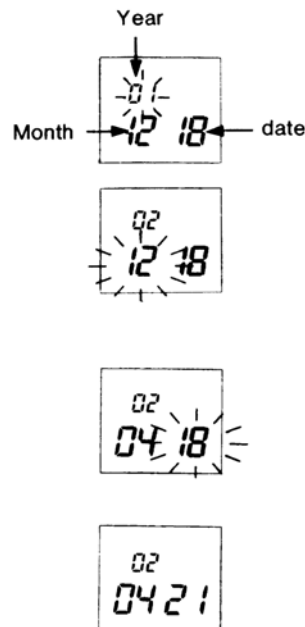

The setting is completed. Close the lid.

If required, other settings can also be performed before closing the lid.

For year setting, 00 to 95 are 2000s and 96 to 99 are 1900s.

〈Setting of Hour and Minute〉

Example : Change 18 : 00 to 8 : 30.

- 1 Open the lid and turn the setting index.

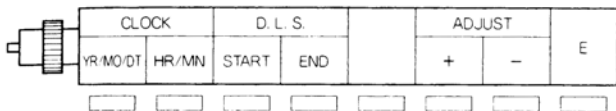

- 2 Press the "HR/MN" button.



- 3 Press the "+" or "-" button to change the hour. Press the "E" button to register the setting.



- 4 Press the "+" or "-" button to change the minute. When the "E" button is pressed, the clock hands will move to match the set time and the clock will start at 00 second.



Setting Daylight Savings Time

Starting/ending dates and times of the daylight saving time are set as shown below.

- When the time reaches the registered starting time of the day beginning daylight saving time, the clock will advance 1 hour automatically.
- When the time reaches the registered ending time of the last day of daylight saving time, the clock will return 1 hour automatically.

[Automatic updating the setting of daylight Saving Time]

For example, when starting date is set to April 1st (Sunday) of 2001, and ending date is set to October 28th (Sunday) of 2001, the time recorder understands that the starting date is the 1st Sunday of April and ending date is the last Sunday of October. So, after the Daylight Saving Time period has ended, the setting of the Daylight Saving Time for following year will automatically be re-set as Starting date: April 7th (Sunday) of 2002, Ending date: October 27th (Sunday) of 2002.

After setting the Daylight Saving Time once, it is not necessary to set again.

Note : This function works only when both the starting and ending dates of daylight savings time are set.

Example : Set the starting date and time to 5:00, April 1st of 2001.

- 1 Open the lid and turn the index.

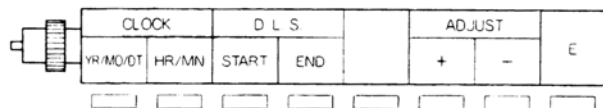

- 2 Press the "START" button.

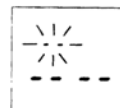

- 3 When the "+" or "-" button is pressed, initial values of the starting year/month/date and this day of the week will be displayed.



①MO②TU③WE④TH⑤FR⑥SA⑦SU

4 Confirm the year. If the value is correct, press the “E” button.



5 Press the “+” or “-” button to set the starting month. Press the “E” button to register the setting.



6 Press the “+” or “-” button to set the starting date. Press the “E” button to register the setting.

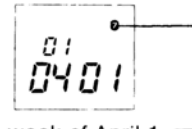

Day of the week of April 1

7 By pressing the E button again, starting time will be displayed.



8 Press the “+” or “-” button to set the starting time. Press the “E” button to register the setting.



Note : Only Hour can be set for starting time. Minute will be fixed at 00.

9 Press the END button next to the START button. Setting of the ending year/month/date will start. Perform the setting of the ending date in the same way as setting of starting date.

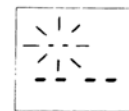

The setting of daylight saving time is completed. Close the lid. If required, other settings can also be performed before closing the lid.

- **To confirm the setting contents**

After the setting has been completed, each time the START or END button is pressed, display will change between set date and time. The set value can be confirmed.

- **To cancel the setting**

Set the starting and ending dates to the same date. The daylight saving time function will be invalidated.

TROUBLESHOOTING

Troubleshooting

Trouble	Causes and Corrective Measures	
The time recorder does not accept time card.	Power failure	⇒ Wait until power supply is restored.
	The power cord is disconnected.	⇒ Insert the power plug firmly into the power outlet.
	Cards were inserted or pulled out by force.	⇒ Pull the power plug out of the power outlet, then insert it again.
A long "beep!" sound is heard without printing.	The card was inserted in the card pocket backwards.	⇒ Insert it in the pocket the other way round.
	The card was not correctly inserted in the card pocket.	⇒ Insert it in the pocket with slight pressure.
The clock does not run.	Power failure	⇒ Wait until the power supply is recovered.
	The power cord is disconnected.	⇒ Insert the power plug firmly in the power outlet.
	The movement malfunctions.	⇒ Pull the power plug out of the power outlet, then insert it again.
The clock is slow. (or fast)	Mistakes in setting the clock	⇒ Set it correctly referring to "Setting Minutes" (Page 1-18).
	Power failure.	⇒ Reset it referring to "Setting the Date" (Page 1-19).
	The movement malfunctions	⇒ Pull the power plug out of the power outlet, then insert it again.
The date is set incorrectly.	Mistake in setting date.	⇒ Reset the date referring to "Setting the Date" (Page 1-19).
Light printing (Imperfect printing).	The ribbon is worn out.	⇒ Replace the ribbon cassette.
	The ribbon cassette is not set correctly.	⇒ Set it correctly.
The print position is wrong.	Incorrect setting of pay period ending date, etc.	⇒ Set them correctly referring to "Changing Pay Period Ending Date" (Page 1-15) for an example.
	Improper use of the time recorder.	⇒ Explain how to insert cards in the card pocket and how to remove them.
Unclear printing	Improper use of the time recorder	⇒ Explain how to remove a card from the card pocket.

After all the above items have been checked, if the time recorder does not operate correctly, contact your dealer. Do not disassemble or lubricate, etc.

List of Error Codes

When the IN/OUT button lamp has gone out with an error signal, a problem may have occurred inside the time recorder. Disconnect the power cord, and after a while connect it to the power outlet. If the time recorder does not return to normal, check the error indication and contact the dealer from whom you bought the time recorder.



- Error code is displayed for 4 seconds after the lid is opened. After 4 seconds, the recorder enters the setting mode.

Error No.	Meaning of Error	Measures
Err 1	Error of clock home position sensor	Contact the dealer from whom you bought the time recorder.
Err 2	Error of column home position sensor	
Err 3	Error of printing timing pulse sensor	



*In case of Err 1 time cards can still be printed on.

IF PRINTS BECOME DIM (replacing the Ribbon Cassette)

⚠ Warning

-  **Do not connect or disconnect power plug with wet hand.**
This could cause electric shock.
-  **Do not damage or break power cord.**
If a heavy object is put on it, or the cord is pulled or bent forcibly, the cord may be damaged and this could cause fire or electric shock.
-  **Do not remove any parts other than parts the removal procedure of which are described in this item.**
There is high voltage part inside, and touching it could cause an electric shock.

⚠ Caution

-  **Before replacing the ribbon cassette, remove the lid and disconnect the power plug from the power outlet.**
Replacing the ribbon cassette while the power plug is connected may cause injury or electric shock.
-  **Be sure to hold the plug when the power plug is being disconnected from the power outlet.**
If you pull the power cord, it may be damaged, causing fire or electric shock.

1 Open the lid.

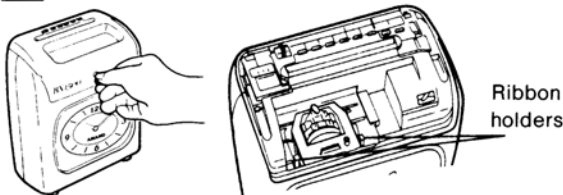

Insert the key into the keyhole, turn it clockwise and open the lid upward. With the dot printer moved to the center, disconnect the power plug from the power outlet.

2 Remove the cassette.

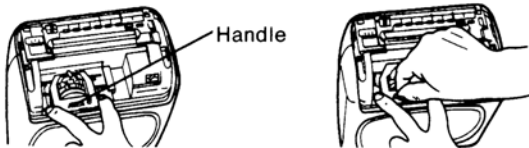

While pulling the ribbon holders toward the front, pull out the handle of the cassette to remove it.

3 Insert a new cassette.

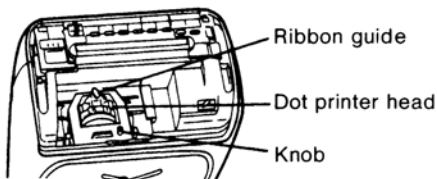

Correctly insert a new cassette between the ribbon guide and the dot printer head. Push the cassette head until it clicks into place. Turn the knob clockwise to remove any slackness in the ribbon.

4 Close the lid.

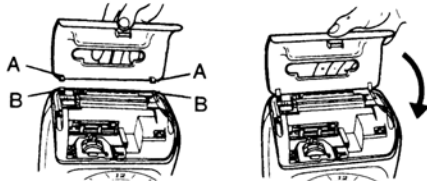

Connect the hooks in the lid (A in the figure) with the hooks in the case (B). Bring the lid down toward you until it is inserted into place.

APPENDIX

Daily Maintenance

Clean the case when it becomes soiled.

- Wet a soft cloth with water or a neutral detergent and wipe the case lightly.
- Do not use benzene, volatile thinner or other chemicals for cleaning, because they may damage or discolor the case.
- Note that spraying insecticide over the case may also damage or discolor the case.



ENGLISH



Wipe the window glass with a dry soft cloth. Be careful when wiping it because the glass surface has been specially processed.

Specifications

- **Power source** : 110-120VAC $\pm 10\%$ or 220-240VAC $\pm 10\%$,
50/60Hz
- **Power consumption** : 120VAC ... Stand-by 70mA Rated 120mA
220-240VAC ... Stand-by 60mA Rated 80mA
- **Operating conditions** : Temperature -10°C to 40°C
Humidity 10% to 90%RH (without condensation)
- **Weight** : 2.3kg (5.1 lb.)
- **Dimensions** : 190(W) \times 224(H) \times 104(D) mm
(7.1/2") \times (8.6/8") \times (4")
- **Clock system** : Quartz oscillation system, Accuracy ± 3 seconds per week
($25^{\circ}\text{C} \pm 5^{\circ}\text{C}$) ($77^{\circ}\text{F} \pm 10^{\circ}\text{F}$)
- **Memory holding function** : 3 years of total power failure time (all functions other than internal clock stop) with lithium battery. Printing cannot be done during power failure.

Initial Values

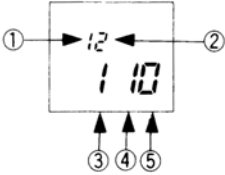
Content	Set Value Range	Initial Value
Pay period ending date, Pay period ending day, Current week	01~31、1~7、1~2	31 (ending on 31st)
Blank	01~32	01 (1st row)
Day time change	Time 00~23	03 (3 : 00 (midnight))
Print format 	<p>①Card Type</p> <ul style="list-style-type: none"> 1 : Monthly pay 2 : Upper step weekly pay (Bottom space : 23mm) 3 : Upper step weekly pay (Bottom space : 35mm) 4 : Lower step weekly pay (Bottom space : 23mm) 5 : Lower step weekly pay (Bottom space : 35mm) 6 : Bi-weekly pay (Bottom space : 23mm) 7 : Bi-weekly pay (Bottom space : 35mm) <p>②1 : operational 2 : not operational</p> <p>③Print Format</p> <ul style="list-style-type: none"> 1 : 24 hours (0~23 hours) (0 is not printed at the tens digit of hour. Example : 9 : 00) 2 : 12 hours (AM/PM hours) (Minute is underlined for PM. Example : 9 : <u>00</u>) 3 : 24 hours (0~23 hours) (0 is printed at the tens digit of hour. Example : 09 : 00) <p>④Minute Indication</p> <ul style="list-style-type: none"> 1 : Minutes 2 : 1/100 hour A 3 : 1/100 hour B 4 : 1/10 hour <p>⑤Day of the week indication</p> <ul style="list-style-type: none"> 0 : Date 1 : English 2 : Spanish 3 : French 4 : German 5 : Italian 6 : Japanese 7 : DAY NO. (1~ 7) 8 : No indication 	<p>1 : Monthly pay</p> <p>2 : not operational</p> <p>1 : 24hours (0~23hours)</p> <p>1 : Minutes</p> <p>0 : Date</p>
Daylight savings time	Daylight savings time starting date Execution time : 0 : 00~9 : 00 Daylight savings time Ending date Execution time : 0 : 00~9 : 00	1996. 1. 1. 2 : 00 1996. 1. 1. 3 : 00

AMANO®

*Corporate Headquarters
140 Harrison Avenue, Roseland, NJ 07068-1239
(800) 526-2559*

www.amano.com