



AMC 7KM-410 10KM-410 12KM-410



PORTABLE AIR CONDITIONER

GB Portable air conditioner

[www.amcorgroup.com](http://www.amcorgroup.com)

## PARTS

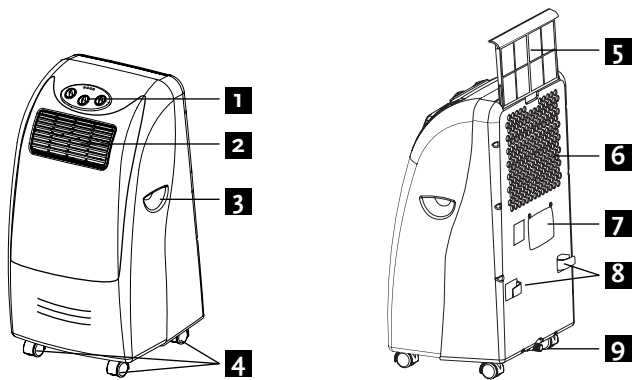

1. Control panel
2. Air outlet
3. Handle
4. Casters

5. Air filter
6. Air inlet
7. Exhaust air outlet
8. Cord hanger
9. Water stopper (plug inside)

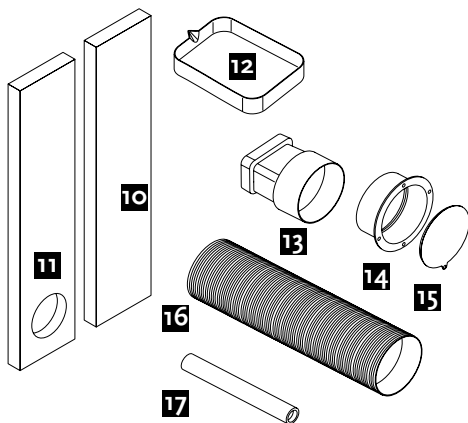

- |                    |                         |
|--------------------|-------------------------|
| 10. Foam extension | 14. Window/wall adapter |
| 11. Foam with hole | 15. Cap                 |
| 12. Water tray     | 16. Exhaust hose        |
| 13. Hose adapter   | 17. Water tube          |

## THANK YOU

Thank you for choosing this innovative Amcor air conditioner. We suggest that you keep this manual in a safe place for future reference. It describes the many benefits and advanced features this unique product has to offer. Before you use your air conditioner you should carefully read these instructions to maximise this product's performance.

For over 50 years Amcor has specialised in complete indoor environmental control, manufacturing and marketing; dehumidifiers, portable air conditioners, coolers, air purifiers, ionisers and aroma therapy scent diffusers. These world class products incorporate the latest technological developments.

## SAFETY INSTRUCTIONS

### IMPORTANT!

- The unit is designed for indoor operation.
- Rating: This unit must be connected to a 220-240 V / 50 Hz earthed outlet.
- The installation must be in accordance with regulations of the country where the unit is used.

**If you are in any doubt about the electrical installation, have it checked and if necessary modified by a qualified electrician.**

- The air conditioner is safe. However, as with other electrical appliances, use it with care.
- Keep out of the reach of children.
- Do not clean the unit by spraying it or immersing it in water.
- Do not insert any object into the openings of the unit.
- Disconnect it from the mains before cleaning the unit or any of its components.
- Never connect the unit to an electrical outlet using an extension cord. If an outlet is not available, one should be installed by a licensed electrician.

## WARNING

- Never operate this appliance if it has a damaged cord or plug. Do not lead the cord over sharp edges.
- A damaged supply cord should be replaced by the manufacturer, its service agent or a qualified person in order to avoid a hazard.
- Any service other than regular cleaning or wick replacement should be performed by an authorized service representative. Failure to do so could result in a loss of warranty.

## Do not use your cooler under the following conditions:



If the power cable wires are frayed or cut



When small children may be left unattended

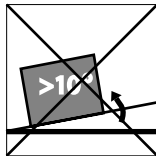

On a slope or uneven surface



Close to a heat source



This products is not made for DIY repair



If there is a risk of liquid falling on the unit

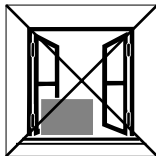

Inside unit exposed to the weather outdoors



In a humid environment

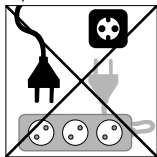

If an extension lead may become overloaded

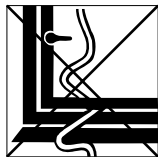

Where the power cable may be damaged



Where it may be damaged by chemicals

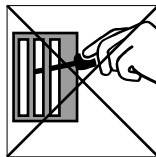

Where there is a risk of interference by foreign objects

## ELECTRIC CONNECTION (see page 8 on how to wire a plug)

For your safety please read the following information.

**Warning:** This appliance must be earthed.

This appliance operates from a 3 pin 13 amp plug. The voltage rating is 230 volts and should be protected by a 13 amp fuse either in the plug or distribution board.

The appliance is supplied with a moulded 13 amp 3 pin mains plug fitted with a 13 amp fuse. Should the fuse require replacement, it must be replaced with a fuse rated at 13 amp and approved to BS1362.

The plug contains a removable fuse cover that must be refitted when the fuse is replaced. In the event of the fuse cover being lost or damaged, the plug must not be used until a replacement cover has been obtained.

If the moulded mains plug is unsuitable for the socket outlet in your home or is removed for any other reason, then the fuse should be removed and the cut off plug disposed of safely to prevent the hazard of electric shock.

There is a danger of electric shock if the cut off plug is inserted into any 13 amp socket outlet.

## POSITIONING

This unit is portable and can easily be moved from one room to another. In doing so keep this in mind:

- The air conditioner must stand upright on an even surface.
- Position not (near) bath, douche or other wet or damp area.
- Keep for free air circulation at least 50 cm free from any obstacle or curtains.

### Installation

- Put the exhaust hose into the round side of the exhaust hose adapter (13) (fig. 1).
- Put the wall/window adapter (14) onto the exhaust hose (fig. 2).
- Connect the hose with the rectangular end to the air conditioner (fig. 4).

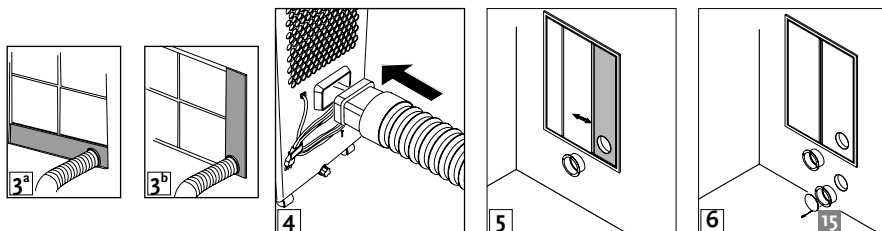
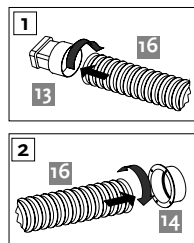

### Using the foam.

Place the foam with the hole (11), if needed together with the foam extension (10), in the window and close this as far as possible to refrain the warm air from re-entering the room (fig. 5). Depending on how the window opens, horizontally (fig. 3a) or vertically (fig. 3b).

Pass the hose through the opening in the foam (11).

### Permanent hole in glass or wall.

Place the wall/window connector (14) in the hole with diameter 130 millimetre (fig. 6). Connect the hose with the rectangular end to the air conditioner (fig. 4). Use the cap (15) to close the opening when the air conditioner is not used.

### Important

The flexible exhaust hose can be extended from 300 to 1500 mm for mounting. This length has been designed especially according to the specifications of the air conditioner. Do not use an extension or exchange for a different hose as that may lead to malfunctioning.

The exhaust air must flow freely, any blockage can lead to overheating of the air conditioner. Take care to prevent any bow or bend in the exhaust hose.

## OPERATION

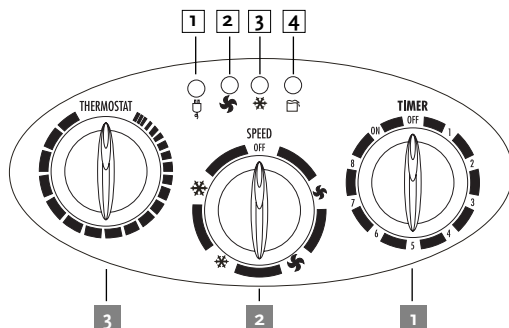

### ON/OFF and timer function

Turn the control [1] to switch the unit on or off. When the unit is on, LED-1 is on.

### Timer function

Use control [1] to set a working time between 1 and 8 hours. The unit switches off when the set time has run down.

### Mode selection and speed setting

Select with control [2] the required operating mode cooling or fan mode. The corresponding LED (2 or 3) will lit.

Select the larger symbol position for high or low fan speed, or low or strong cooling.

### Thermostat setting

Turn control [3] to maintain the temperature level in combination with cooling.

### Notices:

- The compressor has been set so that it starts functioning three minutes after the (re)start of the air conditioner.
- The cooling will switch off when the room temperature is lower than the set one. Ventilation will however continue to work on the set level. When the room temperature rises above the selected value, the cooling will work again.

### Air flow

Turn the roller to control the air flow direction of the vertical louvres.

Move the air vent directly to adjust the air flow direction of the horizontal louvres.

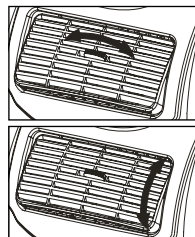

## EMPTYING THE INTERNAL WATER CONTAINER

When the water container is full, the compressor and the ventilator stop functioning, LED [4] will lit.

**Switch off the unit and remove the plug from the mains.**

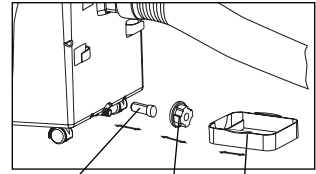

Rubber plug      Water tray  
Drain control

- Place the water tray flat on the floor under the drain.
- Remove the drain knob.
- Remove the rubber plug and fill the water tray then replace the plug to stop the water flow. Empty the tray and repeat this process until all water has been removed.
- Replace the rubber plug and the drain knob, plug the unit in and switch on. The LED [4] should now be out.

## PERMANENT DRAINAGE

**Switch off the unit and remove the plug from the mains.**

- Remove the drain knob and the rubber plug.
- Connect the correct water tube onto the water outlet.
- Place the other end in a normal drain.
- Make sure that the tube is free from twists and bends.  
The tube must incline over its entire length.

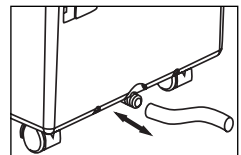
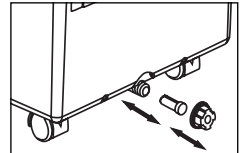

### Dehumidification

If the unit will be used mainly as dehumidifier, do not connect the exhaust hose and let the warm air return in the room. Continuous drainage is then convenient and more efficient.

## CLEANING

**First of all switch off the unit and pull the plug.**

Clean the housing with a soft, damp cloth. Never use aggressive chemicals, petrol, detergents or other cleansing solutions.

### Filter

The single layer screen filter cleans the circulated air. The filter needs to be cleaned regularly with a vacuum cleaner to avoid blocking the air flow.

- Push the two clips on the filter housing downward and pull the filter housing forward and out of the unit.
- Remove the rear retainer from the housing by gently prising it from the retaining clips.
- Insert the screen filter aligning the two cut outs with the clips on the top of the filter housing.
- Reverse the procedure to re-fit the housing in the air conditioner.

**Notice! Never use the air conditioner without filter.**

## STORAGE

See the instructions "Emptying the water container" on page 7.

- Drain the condensed water completely.
- Clean (or replace) the filter.
- Put the unit on a sunny day in fan mode for a couple of hours to ensure that the inside becomes completely dry.
- Store the power cable as shown, protect the unit against dust and store in a dry place not accessible for children.

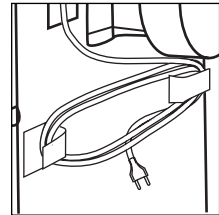

Cable storage

## ELECTRIC CONNECTION

### Important: how to wire a 13 amp plug

The wires in the mains lead on this appliance are coloured in accordance with the following code:

GREEN AND YELLOW – EARTH    BLUE – NEUTRAL    BROWN – LIVE

As the colours may not correspond with the markings identifying the terminals in your plug proceed as follows:

The GREEN AND YELLOW wire must be connected to the terminal in the plug which is marked with the letter E or with the earth symbol  $\perp$  or coloured green and yellow.

The BLUE wire must be connected to the terminal marked N or coloured black.

The BROWN wire must be connected to the terminal marked L or coloured red.

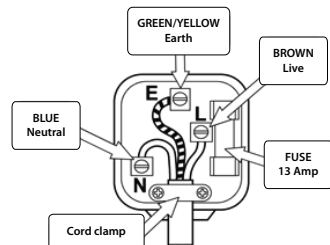



## TROUBLE SHOOTING

Never try to repair or dismantle the air conditioner yourself. Incompetent repairs result in loss of warranty and can endanger the user.

Problem	Cause	Solution
The unit does not function	Check the plug fuse. Check the mains outlet by connecting another appliance	Connect to a functioning outlet and switch on
	Water container indicator is on	Empty water container
	Room temperature outside operating temperature range	
The unit does not seem to perform	In direct sunlight	Close curtains
	Windows or doors open, many people or heat source in room	
	Dirty filter	Clean or replace filter
	Air inlet or air outlet blocked	Remove blockage
	Room temperature lower than selected value	Change temperature selection
The unit is noisy	Unit stands uneven	Place on even surface (less vibrations)
The compressor does not work	Overheat protection probably activated	Wait until room temperature lowers

## TECHNICAL DATA

Model		AMC 7KM-410	AMC 10KM-410	AMC 12KM-410
Cooling capacity measured conform EN 14511	BTU/h	6500	8300	9600
	kW	1.9	2.4	2.8
Mains		220–240 V / 50 Hz / 1 phase		
Power consumption	W	690	830	1030
Current	A	3.0	3.7	4.5
Dehumidification	L/24h	24	28.8	36
Air delivery	m <sup>3</sup> /h	300	350	350
Recommended room size	m <sup>2</sup>	12	18	24
Refrigerant	type	R410A		
Compressor		rotary		
Fan speeds		2		
Thermostat	°C	18 – 32		
Timer	h	1 – 8		
Dimensions (W x H x D)	mm	377 x 750 x 400		
Weight	kg	29	30	32
Subject to modifications without prior notice. Please refer to the rating label for greater precision.				

## AMCOR GUARANTEE PROCEDURE

Amcor products have a lower than industry norm failure rate, as we have strict quality control in our factory. However we are not 100% perfect and occasionally units can fail. When they do we have a simple returns procedure.

All Amcor products are guaranteed for one-year from date of purchase, on a back to base principle. A copy of our guarantee page is attached.

Consumers need to keep the till receipt as proof of purchase.

The Amcor Help line number for the UK 020 8 560 4141 appears on the back of each unit and in the instruction manual.

If a consumer believes the unit to be faulty the first course of action is to phone the Help line 0208 560 4141. A trained engineer will speak to them. Often we find that this eliminates 95% of no fault found, as the customer may not be using the product in the correct manner.

If the engineer believes the unit may be faulty, Amcor will arrange collection by a carrier from the consumer. The product must be boxed and amply protected to avoid cosmetic damage in transit. If the consumer is unable to be present to allow for collection, the boxed unit can be collected from store. Of course Amcor pay the carriage charge.

On reaching Amcor the unit is checked, repaired or replaced, re-boxed and returned again by carrier to an agreed return address. This process usually takes 5 – 7 working days.

If the customer returns to store and claims the unit to be faulty we would ask that you carry out the same procedure as above, particularly with air conditioners, rather than simply exchange or refund. Again this eliminates the risk that the consumer is not using the product correctly. However goods returned faulty inside 28 days can be exchanged – usually faulty goods “dead on arrival” will be returned to store by the consumer within a few days.

To exchange or refund DOA goods within 28 days stores must call Amcor on 020 8 560 4141 (Monday – Friday 09.00 – 17.30 hrs.) for an authorisation number. If goods need to be exchanged over a week-end (or late evening) stores must contact Amcor on the next working day. Amcor will require store details, product details and date of purchase/return.

Goods returned under 28 day agreement that are found to have significant wear & tear will not be credited; consequently stores must check purchase and return dates.

Goods returned outside 28 days of purchase will not be authorised for return to Amcor. Instead we will collect / repair / return the unit under our normal guarantee procedure.

Outside of the guarantee period Amcor are able to service or repair units for a reasonable cost. Consumers can get details of the cost from the Help line number.

Consumables such as activated carbon filters can be bought directly from Amcor; payment can be by cheque or credit card.

This guarantee is in addition to the customers' statutory rights.

## YOUR GUARANTEE

### DOMESTIC AIR CONDITIONERS

If this product is found to be defective as a result of faulty materials or workmanship within one year from date of purchase, it will be repaired or replaced free of charge.

This guarantee is subject to the following terms:

*Amcor Limited., must be notified of the fault*

*Proof of purchase must be presented to Amcor's nominated representative*

*The warranty will be void if the product is modified, misused or repaired by an unauthorised person*

*The guarantee does not cover accidental damage, misuse, or consumable items such as filters*

*The guarantee after repair or replacement will not be extended beyond the original one-year period*

*All replacement parts or units will be new or reconditioned*

*Parts or units, which are replaced, become the property of Amcor Limited*

*Amcor Limited disclaims any liability for incidental or consequential damages*

*The warranty applies for the use of the product in UK.*

**This GUARANTEE is in addition to your Statutory Rights.**

Creating Quality Environments

AMCOR LIMITED • 9 Ryan Drive • West Cross Centre • Great West Road • Brentford  
Middlesex • TW8 9ER • UK

**For Customer Support Call: 020 8 560 4141**



**Reminder:**

Waste electrical products must not be disposed of with household waste. This product should be taken to our local recycling centre for safe treatment.

**Hong Kong**

Amcor Ltd  
Suite 2007, Tower 6, The Gateway,  
Harbour City, 9 Canton Road,  
Tsim Sha Tsui, Kowloon,  
Hong Kong  
Tel: +852 2997 6865  
Fax: +852 2997 6091  
Email: amcorhk@amcorgroup.com

**United Kingdom**

Amcor Ltd  
9 Ryan Drive, West Cross Centre,  
Great West Road, Brentford,  
Middlesex, TW8 9ER,  
United Kingdom  
Tel: +44 20 8560 4141  
Fax: +44 20 8232 8814  
Email: amcoruk@amcorgroup.com

**USA**

Amcor Inc.  
685A Gotham Parkway, Carlstadt,  
New Jersey 07072,  
United States of America  
Tel: +1 201 460 8100  
Fax: +1 201 460 9481  
Email: amcorusa@amcorgroup.com

**The Netherlands**

Amcor B.V.  
Anton Philipsweg 9-11,  
1422 AL Uithoorn,  
The Netherlands  
Tel: +31 297 560 079  
Fax: +31 297 523 062  
Email: amcorex@amcorgroup.com

**Israel**

Amcor International Ltd  
1 Sapir St.,  
P.O. Box 12001  
Hertzeliya Pituach,  
Israel  
Tel: +972 9951 5351  
Fax: +972 9958 5650  
Email: amcoril@amcorgroup.com

**Singapore**

Amcor Investments (Singapore) Pte Ltd  
545 Orchard Road,  
#13-02, Far East Shopping Centre,  
Singapore 238882  
Tel: +65 6297 9881  
Fax: +65 6297 8891  
Email: amcorsg@amcorgroup.com

**China**

Shan Xia Industrial Development Zone,  
Heng Li Town, Dongguan City,  
Guangdong Province, China

**Plant One - Amcor (China) Ltd**

Tel: +86 769 8372 1090  
Fax: +86 769 8372 1790  
Email: amcorcn@amcorgroup.com

**Plant Two - Amcor Appliances Ltd**

Tel: +86 769 8372 1970  
Fax: +86 769 8372 1790  
Email: amcorappl@amcorgroup.com

