

Amity

TECHNOLOGY

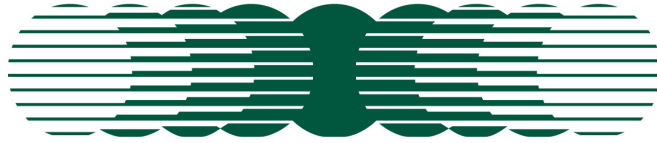

2012 Cart Control System

Operators Manual



P/N 330288

Amity Technology, LLC
2800 7th Avenue North
Fargo, ND 58102
(701) 232-4199
www.amitytech.com

This Page Left
Intentionally Blank

Table of Contents

Table of Contents	3
Introductory Information	5
Read this Manual!.....	5
Safety is YOUR Responsibility!.....	6
Recognize Safety Information	6
Understand Safety Symbols.....	6
Follow safety Instructions.....	7
Operate Safely.....	7
Warnings!	8
Section 1: General Information	9
About your Cart Control System	9
ISOBUS Virtual Terminals and Features	9
Using Virtual Terminals with Your Cart Control System.....	10
Alarm and Indicator Icons	11
Confirmation Screen.....	13
Main (Home) Screen.....	14
Fan RPM	15
Product On/Off	15
Desired Rate.....	15
Actual (Live) Rate	15
Product/Bin Alarms	15
Bin Count.....	16
Ground Speed	16
Area Counters	16
Seeder Up/Down.....	16
Seeding State.....	16
Work Switch Softkey.....	16
Blockage/Rate Sensor Loop Status.....	17
Sensitivity	17
Installed Sensors	18
Blocked Sensors.....	18
Blocked Sensor %	18
Communication Error	18
Sensors to be Cleaned	18
Particle Rate.....	18
Section 2: System Setup	19
System Settings Screen.....	19
Cart Model	20
Drive Type	20
Fan Enable	20
NH3 Enable.....	20
Implement Width	21
Ground Speed Type	21
Test Speed.....	21
Fan Targets and High/Low Alarms	21
Work Switch Operation	22

Setting Up Work Switch Operation.....	22
Manual Work Switch Operation.....	22
Automatic Work Switch Operation.....	22
Section 3: Dry Product/Bin Settings	23
Dry Products Settings.....	24
Bin Size (Volume).....	24
Bin Count %	24
Product Weight/Volume (Density or Test Weight).....	24
Product Weight.....	24
Meter Calibration – Ground Drive	25
Ground Drive Bin Count Monitoring:.....	25
Meter Calibration – Hydraulic Drive	26
Preparing to Calibrate the Meter	26
Priming the Meter.....	27
Taking a Sample for Calibration	27
Entering Accumulated Weight into the Monitor	28
Section 4: Liquid Product (NH3) Settings.....	29
NH3 Settings Screen.....	29
Tank Fill %	30
Tank Size.....	30
Product Weight/Volume	30
Product Weight.....	30
Liquid Cal Number.....	30
Product Area.....	30
Product Accumulation	30
NH3 Settings	31
System Type (Number of Valves).....	31
Drive Direction (Polarity).....	32
Control Valve Gain.....	32
Target RPM (Flow)	32
Actual RPM (Flow)	32
Calculating Liquid Calibration Number.....	33
Checking and Fine-Tuning NH3 Calibration	34
Purging the NH3 System.....	34
Blockage System Troubleshooting.....	36
Section 6: System Troubleshooting.....	38
Section 7: Appendix.....	41

Introductory Information

Read this Manual!

READ AND UNDERSTAND THIS MANUAL BEFORE YOU OPERATE THIS MACHINE.

Learn how to operate and service your machine correctly. Failure to do so could result in personal injury or equipment damage. Amity Technology will not accept any responsibility for any damage or malfunctions resulting from failure to comply with the operator's manual.

If you do not understand the information in this manual, or if you have any questions, contact Amity Technology Customer Service.

This manual should be considered a permanent part of your machine and should remain with the machine when you sell it.

Amity Technology reserves the right to alter illustrations and technical data contained in this manual.

The contents of this manual are the intellectual property Amity Technology. All use and/or reproduction not specifically authorized by Amity Technology is prohibited.

All information, illustrations and specifications in this manual are based on the latest information available at the time of publication. Amity Technology reserves the right to make changes at any time without notice.

Safety is YOUR Responsibility!

Recognize Safety Information



This is a safety-alert symbol. When you see this symbol on your machine or in this manual, be alert to the potential for personal injury.

Follow recommended precautions and safe operating practices.

Understand Safety Symbols



A reminder of safety practices or attention to unsafe practices which could result in injury or death if proper precautions are not taken.



A hazard exists which could result in injury or death if proper precautions are not taken.



An extreme inherent hazard exists which could result in injury or death if proper precautions are not taken.

Follow safety Instructions

Carefully read all safety messages in this manual and on your machine safety decals. Keep safety decals in good condition. Replace missing or damaged safety decals. Be sure new equipment components and repair parts include the current safety decals.

Learn how to operate the machine and how to use controls properly. Do not let anyone operate without instruction.

Keep your machine in proper working condition.

Unauthorized modifications to the machine may impair the function and/or safety and affect machine life and thus void the warranty.

Operate Safely

Do not make adjustments while the machine is in motion.

Do not enter the tank unless another person is present and hydraulic hoses are disconnected from the tractor.

Operate the machine from the tractor seat only.

Keep hands and fingers away from hinge area when positioning auger. Lock auger in storage position before operating in the field.

Clear the area around the machine before raising or lowering the machine or wings.

Stop the tractor on level ground when raising or lowering wings. Do not operate with wings raised. To improve stability, travel through the field with the wings unfolded. Fold wings to transport position just before leaving the field and entering a roadway.

Do not operate close to the edge of a ditch, creek, gully or steep embankment.

Avoid holes, ditches and obstructions which may cause tractor, cart or seeding tool to roll over, especially on hillsides.

Avoid sharp turns on hillsides.

Slow down when turning or traveling over rough ground, and when turning on inclines.

Shut off the tractor and shift to Park or set brakes when leaving the tractor. Remove the key when leaving the tractor unattended.

Warnings!

ATTENTION! Read this manual carefully and fully before operations.



WARNING! Take care if welding on the frame of cart of planting system. Ensure that no power is applied to the ECU. Unplug the main harness from the tractor and properly ground the welder. Connect the welder ground cable as close as possible to the weld area.

ATTENTION! Low battery or alternator voltage can cause system errors.



WARNING! Be careful when testing NH₃ systems. Be sure to clear the area of people and pets. While testing, wear proper protective clothing and eyewear. Always position yourself up-wind while testing.

NOTICE! Depending on the processing speed of your virtual terminal, there may be a delay in function changes when a soft key is pressed. If you quickly press a soft key several times, you may initiate multiple functions on several pages. Allow time between pressing soft keys to ensure the virtual terminal has time to respond.

NOTICE! When operating product meters in test mode (Test Speed), be sure to open the access door under the meter, or run the fan, to prevent material from building up and stopping the meter.

ATTENTION! Ensure that your virtual terminal is updated with the latest version of its software from its manufacturer.

Section 1: General Information

About your Cart Control System

Your Amity Cart Control System is based on the ISO 11783 standard, often referred to as ISOBUS. Essentially, ISOBUS is a communications standard that enables a variety of agricultural electronics systems to talk to each other. Its purpose is to integrate all current and future farm functions by standardizing communication between tractor and implement. Tractor and implement are operated as a single unit, which reduces operator stress and increases efficiency. ISOBUS permits the use of the same tractor terminal on a number of different machines and hence control of a wide range of implements without the need to reprogram a system.

All of this means that your Amity Cart Control System can be operated from any tractor that is equipped with an ISOBUS-compatible terminal, regardless of the manufacturer.

ISOBUS Virtual Terminals and Features

A Virtual Terminal (VT) is a standard graphics display that operates on the common ISO 11783 platform. Several companies manufacture ISOBUS-compatible virtual terminals. Although the locations and types of controls may vary from manufacturer to manufacturer, all terminals use the same icons to represent the main functions. When an ISOBUS-compatible terminal is connected to an ISOBUS-compatible implement system, the “personality” (program, control screens, unique icons, etc) for that system is loaded into the terminal. The control screens, or pages, for that implement (which are displayed in the central area of the screen) are identical for any ISOBUS-compatible terminal.

Using Virtual Terminals with Your Cart Control System

Any ISOBUS-compatible virtual terminal (VT) should be able to communicate with and control your Cart Control System. When the VT in your tractor is connected to the ECU on the cart it downloads the information from the ECU and displays it on the VT's screen. The central part of the screen displays information pages identically, regardless of the VT you are using. Typically, icons representing other pages are located around, or to the side of the central part of the screen. Selecting these soft keys enables you to navigate to the pages they represent. The location of page icons may vary depending on the manufacturer of the VT. Also, some VTs have touch screens, whereas others use pushbuttons located around the outside of the screen, adjacent to on-screen icons.

ISOBUS compatible VTs can be used to set up, operate and monitor your Cart Control System but the exact details of how to access and change values and settings may vary from manufacturer to manufacturer. For example, when entering numerical values during system setup, some VTs may open a keypad-style page. Others may assign numbers to switches around the outside of the screen. For this reason, procedures in this manual simply state “Enter the numerical value for...”. You will have to consult the manufacturer’s operating manual for your specific VT to determine the details.

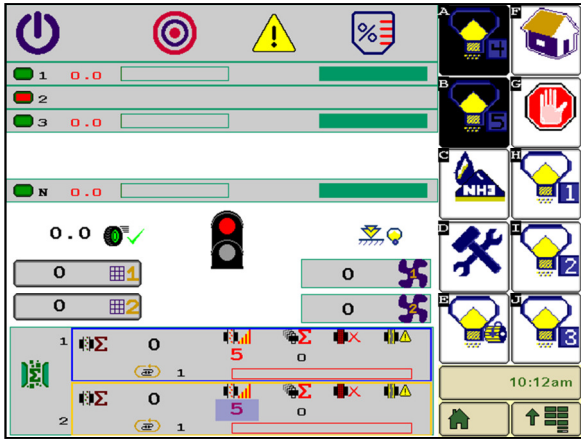

An example of an ISO Monitor page

Tip!







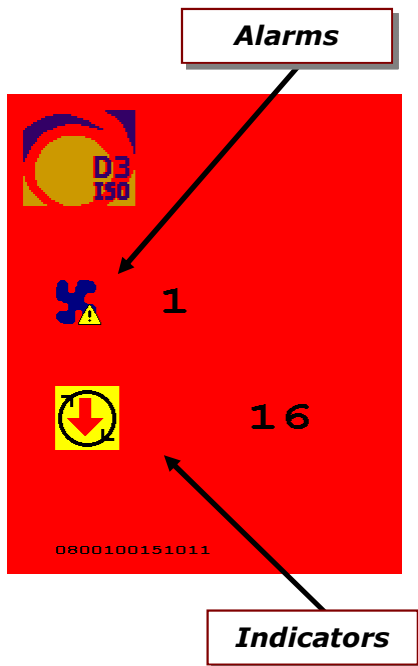

For detailed information on how to operate your virtual terminal, refer to its operation manual.

Alarm and Indicator Icons

The following is a list of alarms and Indicator that could occur during system operation. Alarms show up as separate screens and are acknowledged based on your Virtual Terminal type.



Icon	Alarm
	Product Rate Alarms
	Bin Alarms
	Fan Alarms
	Meter Box Alarms
	NH3 Alarms
	Blockage Alarms
	Low Ground Speed Alarm
	Battery Voltage Alarm
	Internal Alarm
Icon	Indicator
	High RPM Indicator
	Low RPM Indicator
	Empty Indicator

Icon	Indicator
	High Voltage Indicator
	Low Voltage Indicator
	Current Overload Indicator
	No Tachometer Indicator
	SPI Communication Failure Indicator
	Low Seed Rate Indicator
	Blocked Seed Run Indicator
	Loop Communications Failure Indicator

Note:

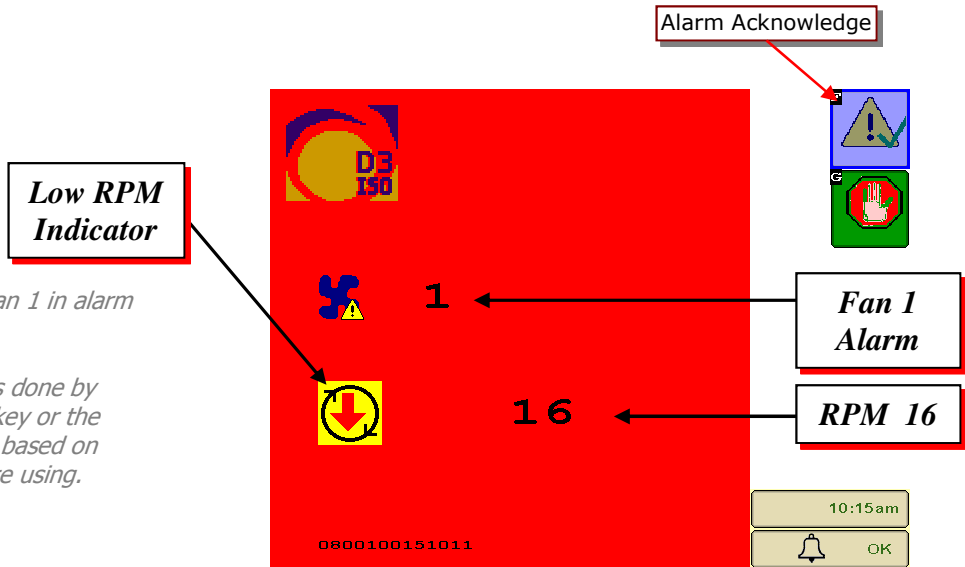

- This alarm screen shows Fan 1 in alarm with a RPM of 16.

- Acknowledging the alarm is done by either touching the "OK" softkey or the "ESC" button. This will vary based on which virtual terminal you are using.



Confirmation Screen

Changing of certain settings or values on your Amity Cart Control System may require confirmation, clearing an acre counter for example. When confirmation is needed, a confirmation screen will appear.

- To Confirm your selection and return to the previous screen, select the  softkey.
- To Cancel your selection and return to the previous screen, select the  softkey.

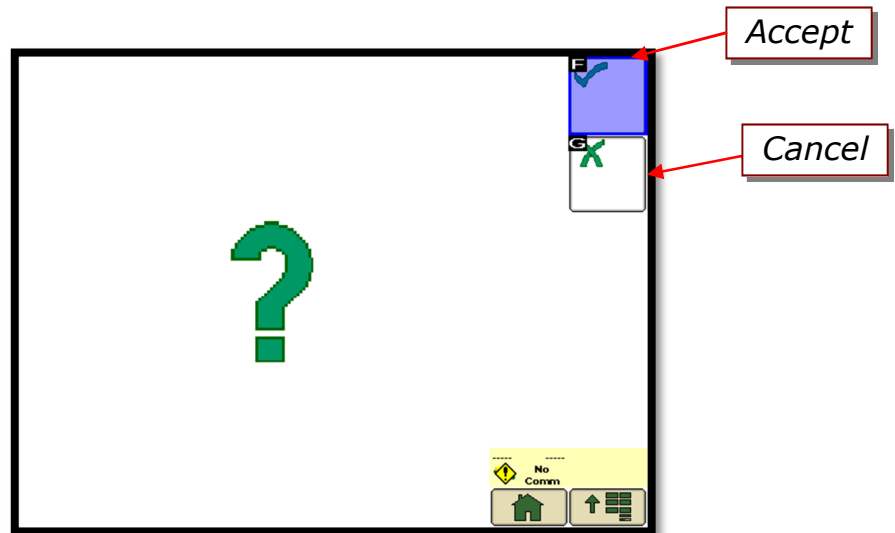

Main (Home) Screen

On the Main page of the Cart Control System you can view many critical machine functions. The following screen shot shows the key information provided on this page. Each function will be explained in greater detail following this diagram.

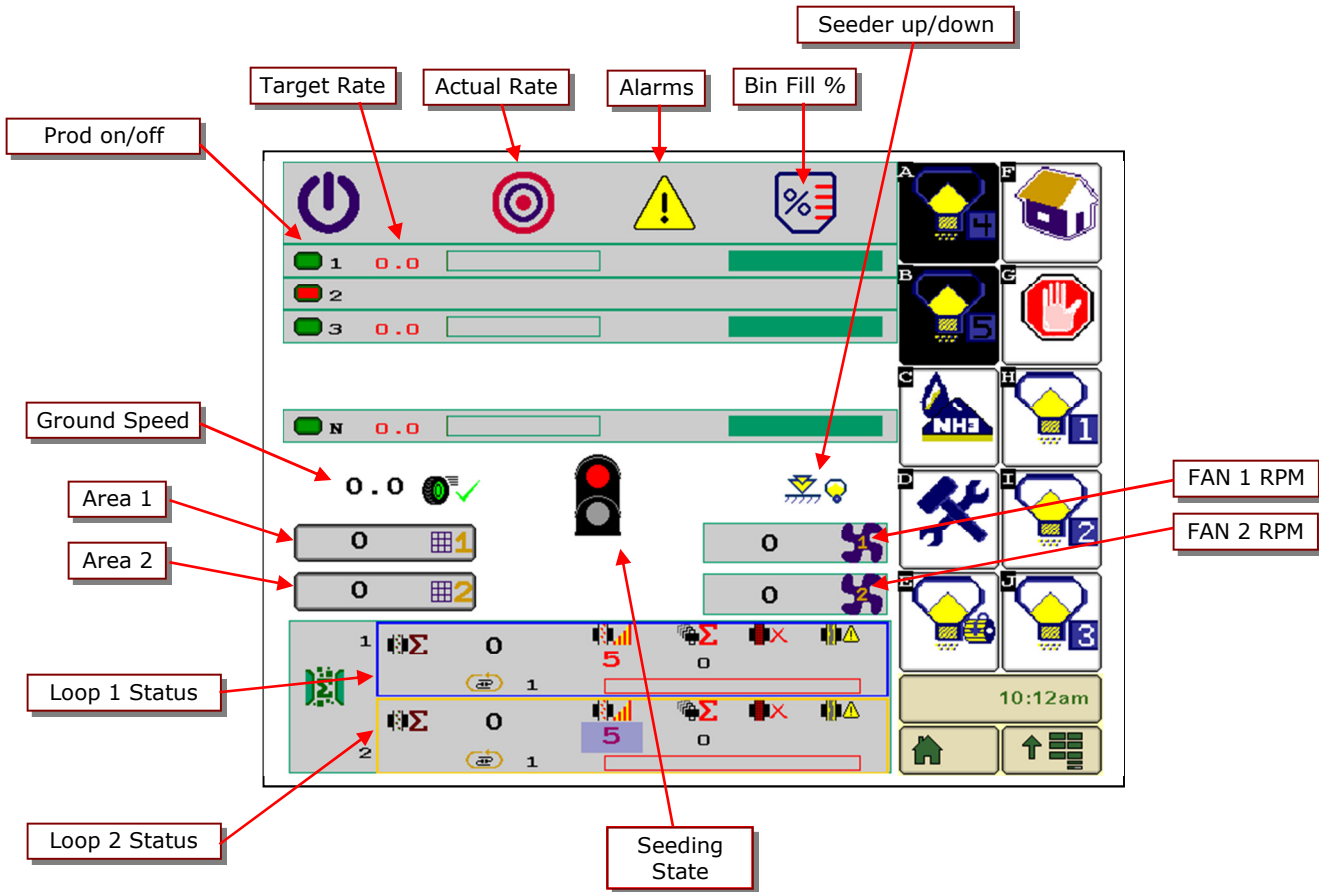

Home Screen Softkeys

Icon	Page	Icon	Page
	Main (Home)		On/Off (Manual Work Switch)
	System Settings		Product Bins Settings (1-5)
	NH3 Settings		Meter Fill

Note: If the softkey is **blacked** out, it means either the feature is turned off or the feature is setup to be used with an External ECU (Blockage or NH3 for example).

Fan RPM



Displays Fan speed in RPM. Min and Max alarms can be set in the *System Settings* screen. See System Setup for more information.

Product On/Off

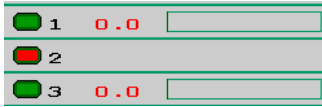

Pressing the *Product On/Off* buttons will turn any particular product on or off. A **Green** indicator represents *Product On* and a **Red** indicator represents *Product Off*.

The single clutch on Ground Drive units is tied to Product 1, individual bin control is not available.

Desired Rate

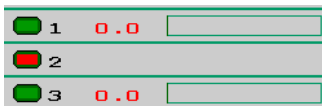

The Desired rate for each product is entered by modifying the **Red** value next to Product On/Off. Desired Rate displays lb/acre (kg/ha).

Note: Desired Rate is for reference only on ground drive units.

Actual (Live) Rate

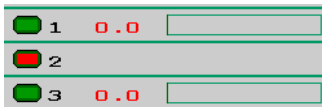

Graphically displays the Actual Rate for Motors 1-5 and N (liquid NH3) as a percentage (0-200% of desired rate). When the indicator bar is in the center of the graph, the Actual Rate matches the Desired Rate. The Desired rate for each product is also numerically shown in red.

Product/Bin Alarms



The following symbols can be displayed in the alarm box for each product/bin.

Symbol	Alarm
	Bin Low Alarm
	Meter Box Low Alarm
	Drive Manual Mode
	Rate High Alarm
	Rate Low Alarm
	Motor Overload Alarm
	No Tachometer Alarm
	No Slave ECU
	Calibration Active

Bin Count



Displays the status of the bin levels as a percentage. The Bin Count feature can be calibrated in the **Product Calibration** screen. These indicators are an approximation based on the calculated meter accumulation and must be properly calibrated in order to properly function.

Ground Speed



Displays ground speed of the cart in mph (kph). The speed source can be changed in the **System Settings** screen.

Area Counters



Displays total area in **Acres** or **Hectares**. Pressing the **Area** button will clear the area accumulation.

Seeder Up/Down



Displays the current up or down state of the seeder. If there is a work switch on the seeder, the Seeder Up/Down indicator will change as the seeder is lifted up or set down. If there is no work switch present on the seeder, the Seeder Up/Down indicator will always reflect the down position.

Seeding State

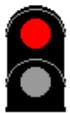

Displays whether the seeder is seeding or not. A green indicator will show when the drill is in the seeding state. Seeding can only occur if the Seeder Up/Down indicator is in the down position, the work switch softkey is green, and speed is present.

Work Switch Softkey



Pressing the Work Switch Softkey will turn the seeder on if there is no automatic work switch installed on the seeder. If there is an automatic work switch installed on the seeder, pressing the Work Switch Softkey will enable operation of the automatic work switch.

Blockage/Rate Sensor Loop Status

Displays information on the status of each blockage loop.

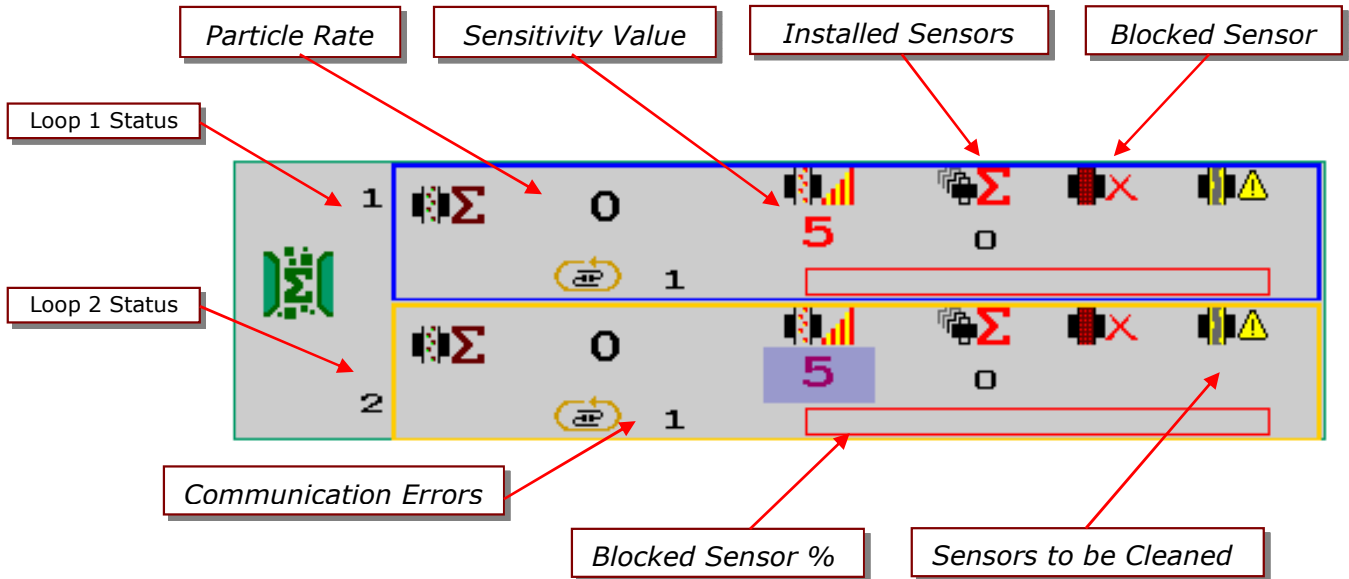

Sensitivity

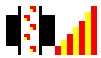

Tip!

A Blockage Sensitivity value of 0 will disable the power and alarms to the seed sensor loop. The default value is 4.

Sensitivity values less than 4 require the scanning loop to run slower giving the sensors longer than 1 sec periods to count seed. This allows for sensitivity ranges down to 1 seed/30sec.

Note:

Sensitivity value represents the minimum particle rate per row/run.

The goal is to have the SENSITIVITY value as high as possible without giving constant alarms. If a seed sensor measures fewer particles per second than the Blockage Sensitivity value indicates, a blockage alarm occurs.

Sensitivity	Minimum Seeds/second
0	Loop is off
1	1 seed 30 seconds
2	1 seed 20 seconds
3	1 seed 10 seconds
4	1
5	34
6	80
7	204
8	539
9	1451
10	7000

Installed Sensors



The system will display the number of *Installed Sensors*.

1. Ensure the module is detecting all installed sensors.
2. If the number is incorrect, see System Troubleshooting.

Blocked Sensors

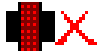

The system will display the sensors that are blocked. The number associated with a blocked sensor, is the location of the sensor in the loop.

Blocked Sensor %



The system will display a graph showing the percent of blocked sensors in the system.

Communication Error



The system will display any sensors with communication errors.

1. See System Troubleshooting for possible solutions.

Sensors to be Cleaned



The system will display unclean sensors that are not properly working. The number associated with an unclean sensor, is the location of the sensor in the loop.

Particle Rate



The system will count particles the sensor reads and display it as particles per acre (hectare).

Particle rate only displays rate based on number of rows with sensors.

Section 2: System Setup

Important!

This system setup procedure **MUST** be completed or your system will not operate correctly. Complete all steps.

Before operation of your new Amity Cart Control System, there are a few simple setup and calibration procedures that must be performed to ensure proper seeding performance. If these operations are not completed, seeding performance and accuracy will be affected.

System Settings Screen

Use the following procedures to set up system parameters before using your system:

The screenshot shows the System Settings screen with the following callouts:

- Cart Model:** 280, 335, 380, 525
- Drive Type:** (Icons for different drive configurations)
- Fan Enable:** (Icons for fan configurations)
- NH3 Enable:** (NH3 icon)
- Implement Width:** 480, 394
- Ground Speed Type:** v03.0z
- Software Version:** (Icon for software version)
- Fan Settings:** (Icons for fan speed and pressure)
- Units Indicator:** U - U.S., M - Metric, I - Imperial, ? - Mixed

System Setup Screen Softkeys

Icon	Page	Icon	Page
	Main (Home)		On/Off (Manual Work Switch)
	Advanced Settings		Sensor Channels
	Advanced Settings Lock		

Units

The Amity Cart Control System utilizes either SAE (US) or Metric units. Units are configured in the Virtual Terminal System Settings. Verify which system of units your VT is using before entering these values and operating your system. Refer to your VT Operators Manual for more information on checking the units. The **Units Indicator** on the **System Setup Screen** displays the units setting of the Virtual Terminal for your reference.

Cart Model



The Cart Model is a preset factory selection. It sets all necessary advanced settings for the defined cart.

Drive Type



The Drive Type is a preset factory selection. It sets all necessary advanced settings for the defined drive type. The first selection is for ground drive, the second is for hydraulic drive.

Fan Enable



Fan Enable selection is defined by the user. Selection is either **Green On** or **Gray Off**. Fan Enable allows for the display of fan rpm and fan alarms.

NH3 Enable



NH3 Enable selection is defined by the user. Selection is either **Green On** or **Gray Off**. NH3 Enable allows for NH3 application.

Implement Width



Tip!

If your machine is 60 feet wide, multiply 60 X 12 inches per foot = 720 inches. Enter "720".





Step 1. On the System Setup page, select **Width** by pressing the number next to the width icon. 

Step 2. Enter the width value in **inches** or **millimeters**.

Ground Speed Type



Pressing the **Speed Button** will toggle between the different ground speed input types. The ISO speeds are only available if the tractor is broadcasting these over the ISO-BUS.

Symbol	Speed Type
	Cart Speed (Default for Normal Operation)
	Test Speed (set in the Calibration Menu)
	ISO Ground Speed (Tractor GPS)
	ISO Wheel Speed (Tractor Wheel or Radar)

Test Speed



Note:

Speed Type must be set to Test Speed to take effect



Step 1. Select the number next to the **Test Speed icon** 

Step 2. Enter the desired test speed in **mph** or **kph**.

A test speed will affect both dry products and NH3 operation.

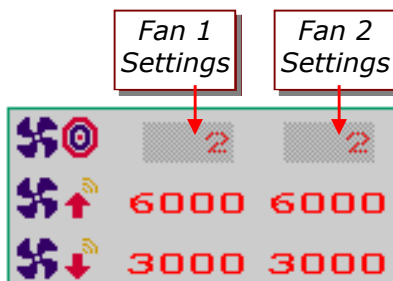
Fan Targets and High/Low Alarms



Fan target settings  as well as fan high and low alarm  /  settings are shown here. The fan high and low alarm values are editable and can be changed based on user preference.

Work Switch Operation



The Cart Control System is equipped with manual and automatic work switches. The manual work switch is a soft key, located on most screens. The automatic work switch is a sensor, located on toolbar. When the system is configured for automatic work switch operation, lifting the machine automatically turns off the meters and NH3 system. Lowering the machine automatically turns on the meters and NH3 system. In this mode you can also use the manual work switch soft key on the main (Home) screen to turn the meters and NH3 system off. If you prefer to operate the meters and NH3 system in manual only, you can configure the system to disable the automatic work switch.

Setting Up Work Switch Operation

Selection of manual or automatic work switch is located on the

Toolbar ECU Main (Home) page.  Select the work switch button to switch between work switch modes.

Green indicates Automatic Work Switch mode



Gray indicates Manual Work Switch mode (Automatic mode off)



Manual Work Switch Operation

The On/Off (Work switch) soft key  turns products on or off.

Automatic Work Switch Operation

Note:

The following conditions must be met for the clutch to engage or for the hydraulic motors to turn:

- Ground Speed must be above the minimum speed setting.
- The Work Switch Softkey must be green
- The Seeder Up/Down must show "Seeder Down"

Tip!

You can still use the On/Off (Work switch) soft key on the main (Home) page to turn the machine off in automatic mode.

Use the following procedure to set up **Automatic** Work Switch operation:

Step 1. Raise the seeding system.

Step 2. On the Main (Home) page, press the On/Off (Work switch) soft key. 

Step 3. Start moving forward in the field with the tractor and planting system.

Step 4. Lower the seeding system. The **Seeder Up/Down** display should indicate **Down**.



The Seeding State display should turn green. 

Section 3: Dry Product/Bin Settings

Each product has its own screen to set up and monitor application rates.

- Numbers in **RED** are input numbers that can be modified.
- Numbers in **BLACK** are displayed output numbers that cannot be modified.

The screenshot shows a control interface for a dry product bin. At the top, it displays '1'. Below this are two main calculation areas. The first area shows a calculation: 100% (red) multiplied by 175 (black) multiplied by 60.01 (red) equals 10501 (black). The second area shows a calculation: 0.00 (red) divided by 0.0 (black) equals 1.04 (red), with 0.0 (black) and 62.1 (black) shown below. The interface includes several control buttons: a power button (labeled 'Button clears area'), a green button with a bag icon (labeled 'Product On/Off Must be "ON" for Calibration'), a green button with a house icon (labeled 'Task Controller Seed/Fertilizer'), and a green button with a power button icon (labeled 'Task Controller On/Off'). A status bar at the bottom right shows the time '10:13am' and navigation icons. On the right side, there are three vertical buttons labeled 'F', 'G', and 'H' with icons for a bin, a stop sign, and a power button with a checkmark.

Dry Product Screen Softkeys

Icon	Page	Icon	Page
	Main (Home)		On/Off (Manual Work Switch)
	Product On/OFF		

Dry Products Settings

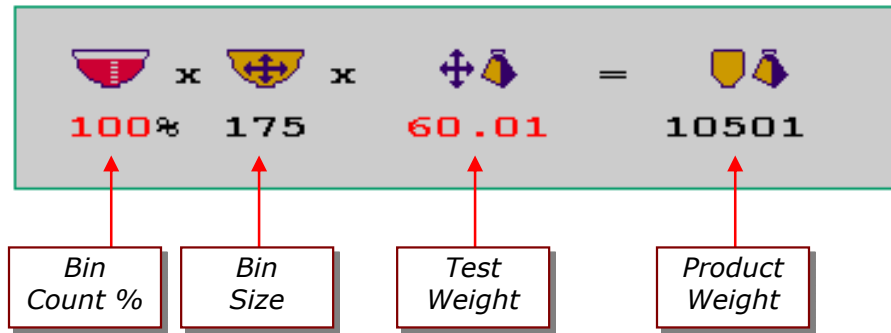

Bin Size (Volume)

Bin Size displays the size of the tank in *bushels (liters)*. This value is pre-set at the factory and is used for the Bin Count and Product Weight features.

Bin Count %

Enter the percentage of estimated product in the bin each time the tank is filled. When calibrated properly, the Bin Count feature provides an estimated approximation of the product left in that bin. This percentage is displayed on the status bar on the Home Screen.

Product Weight/Volume (Density or Test Weight)

Enter the test weight of your product in *Pounds/bushel (Kg/liter)*. This value is needed for proper operation of the “Bin Count” feature.

Product Weight

Displays estimated remaining product weight in the bin in *Pounds (Kg)*.

Meter Calibration – Ground Drive

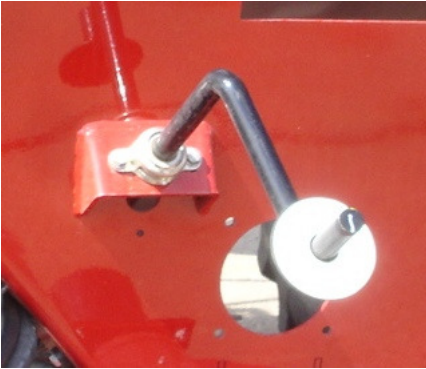

Meter Calibration and application rate settings for Ground Drive units are performed and set mechanically on the tank. For instructions on calibration with a Ground Drive type unit, please reference your ***“Air System Operating and Parts Manual”***. The only control aspect that the Amity Cart Control System has on Ground Drive units is the operation of the meter drive clutch.

The Amity Cart Control System also provides monitoring of critical cart functions on Ground Drive units. Monitoring includes fan speed, shaft speed, ground speed, empty meter box, and low bin level.

Ground Drive Bin Count Monitoring:

Ground Drive Bin Count Monitoring allows the operator to utilize the “Bin Count” feature and the product accumulation counter. To set up the system, calculate the “Meter Cal” value for each bin when you calibrate by dividing your sample weight (lb) by the number of times the crank was turned. Set this value for each bin. You also need to set the “Target Rate” based on the target rate value used for calibration.

For example, if you want to apply 60 lbs/acre from Bin 1 and you were able to adjust your meter to get 6 lb from 9.5 turns, set the Meter Cal Value for Bin 1 to 0.63 lb/rev and set the Target Rate to 60 lbs/acre.

$$\text{Meter Cal Value (lb/rev)} = \frac{\text{WeightInBag(lb)}}{\text{TurnsOfTheCrank(rev)}}$$

Meter Calibration – Hydraulic Drive

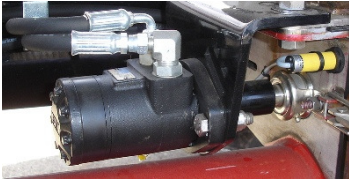

Calibration is performed in four parts. First, you must prepare the system for calibration. Second, you prime the meter. Third, you take a sample and weight it. Finally, you enter the sample, or Accumulated Weight into the Monitor. This process must be completed for each meter that needs to be calibrated.

Preparing to Calibrate the Meter

Note!

The meter must be calibrated if:

- The gate setting has changed
- A different product is being used
- A different meter roll is being used

Each meter must be calibrated individually, even if all the gates are set the same

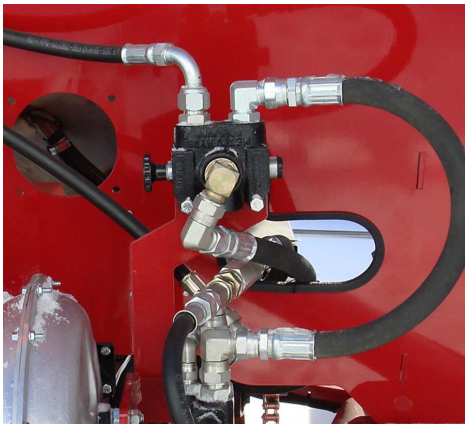

Auger Selector Valve



Adjusting the Meter Gate

Hydraulic Power is needed for calibration. The following procedure sets up the air system for the calibration procedure.

- Step 1. Ensure that the air system's hydraulic lines are connected to a tractor..
- Step 2. Verify that the tractor hydraulic remote for the blower is in neutral until hydraulic power is needed.
- Step 3. Ensure that the monitor wire harness is properly connected to the tractor.
- Step 4. Power up the monitor in the tractor.
- Step 5. Verify that the VT in the cab is communicating with the Air System ECU.
- Step 6. Ensure that the meter door is properly attached to the meter.
- Step 7. Ensure that the bin is at least 25% full of the product that will be applied.
- Step 8. Set the meter gate to the appropriate position for the rate being applied.
- Step 9. Ensure the auger selector valve is directing oil to the fan/meter circuit.
- Step 10. Close the blower ball valve.
- Step 11. Actuate the tractor remote controlling the blower circuit.
- Step 12. Make sure the blower is not spinning for the following steps. If the blower is spinning, check the ball valve to make sure that it is fully closed and blocking flow to the blower.
- Step 13. Open the cleanout door below the meter you wish to calibrate
- Step 14. Open the meter gate. Use the following chart as a guide when using the high capacity meter roll in normal conditions.

Meter Gate Setting Guide – Hydraulic Drive				
Rate lbs/ac (Kg/Ha)	30 ft (9m)	40 ft (12m)	50 ft (15m)	60 ft (18m)
50 (56)	3" (76 mm)	4" (102 mm)	5" (127 mm)	6" (152 mm)
100 (112)	4" (102 mm)	6" (152 mm)	8" (203 mm)	10" (254 mm)
150 (168)	6" (152 mm)	8" (203 mm)	10" (254 mm)	Max
200 (224)	8" (203 mm)	10" (254 mm)	Max	Max

Priming the Meter



Note!

To calibrate a product meter that product must be enabled (active).

To ensure accurate calibration, the meter must be primed with product.

- Step 1. On the ECU keypad, locate the button with the number corresponding to the meter you are calibrating. This is called the ECU Calibration button.
- Step 2. Press the ECU Calibration button once.
The meter roll begins spinning
- Step 3. Allow the meter to spin 2 to 3 revolutions to ensure that the meter is full of product.
- Step 4. Press the same button again to stop the meter.
The meter is now primed

Taking a Sample for Calibration



- Step 1. Using the weigh scale included with your system, hang the calibration bag (also included) on the scale and zero the reading on the scale.
- Step 2. Place the calibration bag below the cleanout opening. Be careful to ensure all product will flow into the bag.
- Step 3. Press the ECU Calibrate button to activate the meter.
- Step 4. Allow the meter to spin until the bag is at least half full.
- Step 5. Press the ECU calibrate button again to stop the meter.
- Step 6. Weight the bag with the supplied scale.
- Step 7. Record the value in pounds (kilograms).

This value is the Accumulated Weight you will enter into the Virtual Terminal.

Note: *Do not press the ECU Calibrate button again until the Accumulated weight is entered into the VT. Pressing the ECU Calibrate button before the weight is entered will clear the rotation counter and void the sample.*

- Step 8. Repeat the previous steps to obtain sample weights for the rest of the meters.
- Step 9. When all the weights have been found, go back to the tractor and enter the calibration weights into the Product page on the Virtual Terminal

Note!

Each time the ECU calibrate button is pressed to activate the meter the ECU counts the revolutions of the meter roll. This count is reset each time the ECU button is pressed. Once you stop the meter roll, the bag must be weighed. If you did not collect enough product in the bag to obtain a measureable weight, you must dump the bag and start over with an empty bag.

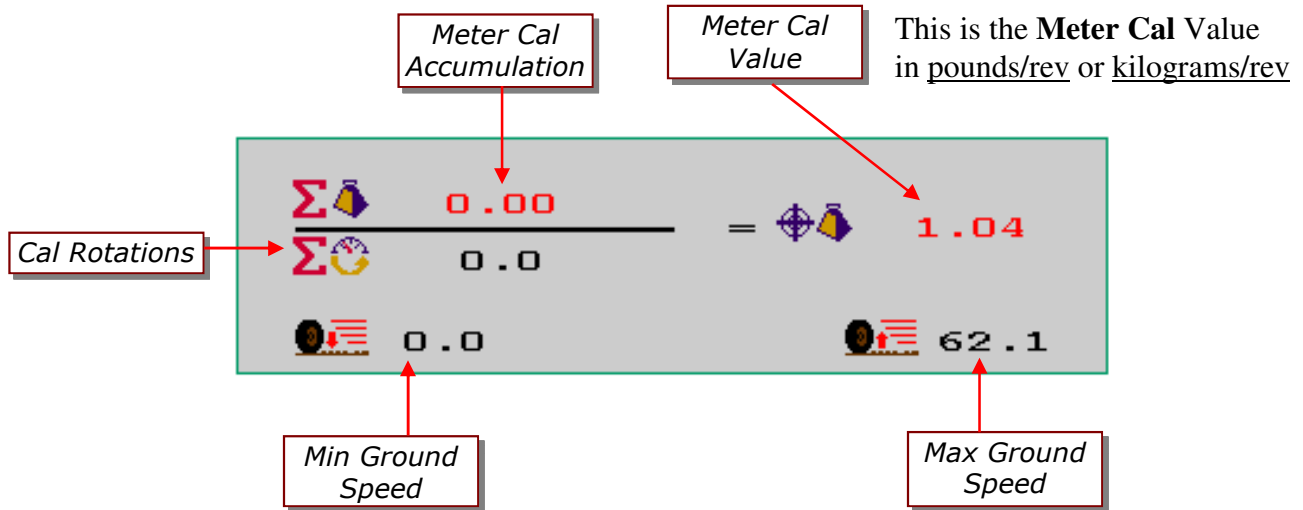

Entering Accumulated Weight into the Monitor



About Meter Cal

Once you enter the **Accum** (lb) value (in Step 3) the ECU automatically calculates the **Meter Cal** value. The **Meter Cal** value is the number of pounds (lb) of product applied per revolution of the meter roller.

E.g. If the Meter Cal value is 1.50, the meter will deliver 1.50 lb of material during each revolution of the meter roll.

- Step 1. With an accumulated weight value, return to the virtual terminal monitor.
 - Step 2. On the Main (Home) page , press the soft key for the desired product.
The Product page for the selected product appears.
 - Step 3. On the Product page, select the number next to **Meter Cal Accumulation**. 
 - Step 4. Enter the accumulated weight value obtained in previous meter calibration procedure in pounds (kilograms).
 - Step 5. Press Home soft key to return to the Main (Home) page.
- Repeat Steps for each additional bin.**

Tip! (Variable Rate Application)

To verify your meter roller will apply prescription map high and low rates accurately:

If you are doing variable rate application, you may have rate changes of 25 lbs/acre to 100 lbs/acre for a single product on a single field. To ensure you have the proper meter roller installed, perform the following test after calibrating the system and entering the Accum (lb) value:

1. Change the application rate to a low value. (e.g. 25)
2. Note the Min and Max Speed values
3. Change the application rate to a high value. (e.g. 100)
4. Note the Min Speed and Max Speed values.
5. If your desired speed does not fall within the range of speed values, you must change meter rollers.



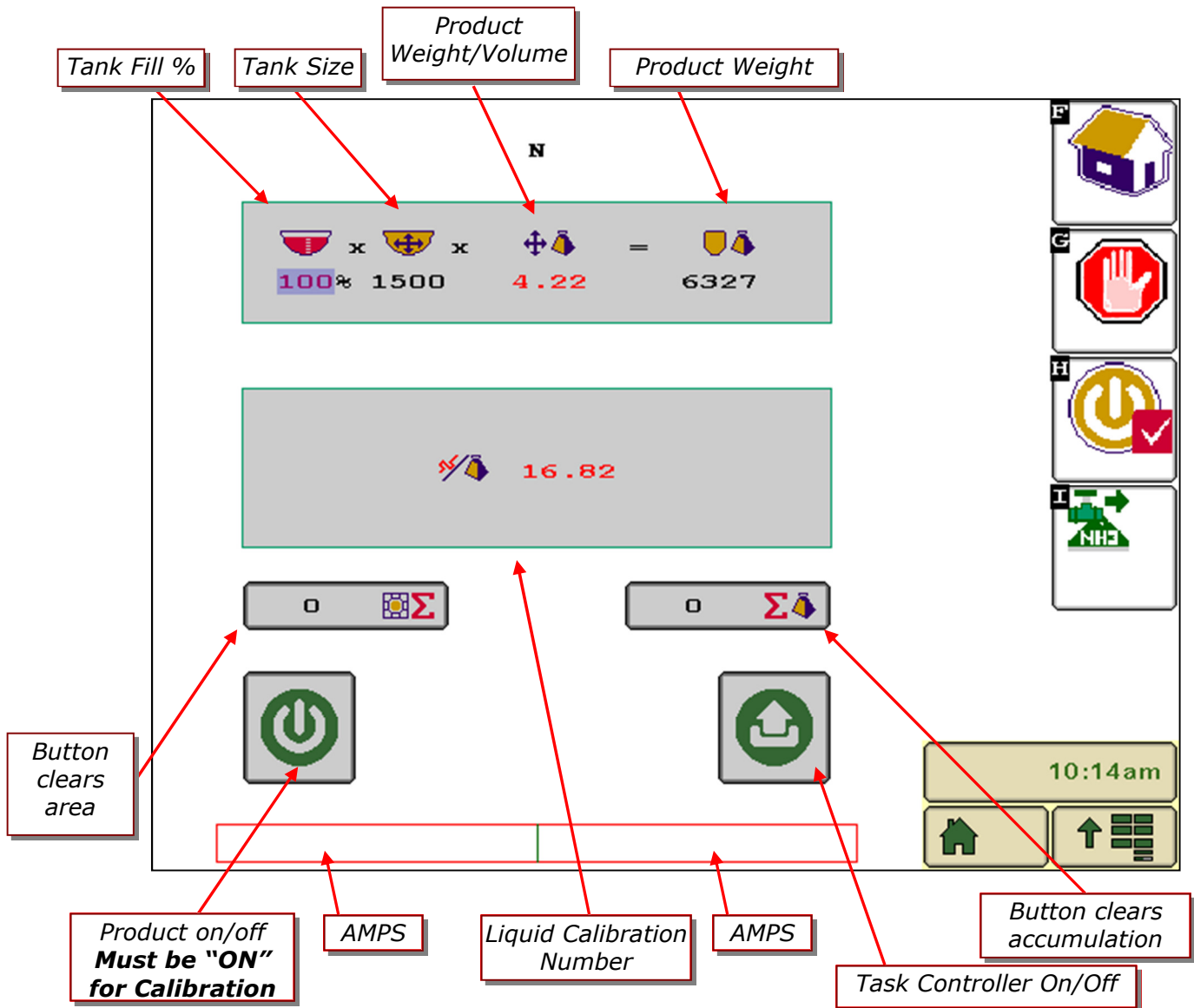

Section 4: Liquid Product (NH3) Settings

NH3 Settings Screen

Before operating your **NH3 ECU**, there are a few setup and calibration procedures to perform to ensure proper fertilizer application.



Main NH3 ECU Screen Softkeys

Icon	Page	Icon	Page
	Main NH3 ECU Screen		On/Off (Manual Work Switch)
	Product On/OFF		NH3 Purge

Tank Fill %



- Step 1. On the Liquid/NH3 page, select **Tank Fill %** by pressing the number next to the bin % icon.
- Step 2. Enter the percentage of product remaining in tank.

Tank Size



- Step 1. On the Liquid/NH3 page, select **Tank Size** by pressing the number next to the bin icon.
- Step 2. Enter the size of your tank in **gallons (liters)**.

Product Weight/Volume



- Step 1. On the Liquid/NH3 page, select **Product Weight/Volume** by pressing the number next to the product weight/volume icon.
- Step 2. Enter the weight/volume of the product in tank.

Product Weight



Displays remaining weight in **Kg** or **Lbs**.

Liquid Cal Number



- Step 1. On the Liquid/NH3 page, select **Liquid Cal Number** by pressing the number next to the liquid cal icon. See the next section on the procedure to obtain the liquid cal number.
- Step 2. Enter flow meter pulses in **Kg** or **Lb**.

Product Area



Displays area covered while metering in **Ha** or **Ac**.

Product Accumulation



Displays weight dispensed while metering in **Kg** or **Lbs**.

NH3 Settings

The screenshot shows the NH3 Settings screen with a table of parameters for five valves (1, 2, 3, 4, 5) and a summary column (N). Callouts point to specific rows in the table:

- Product Width:** Points to the row with values 175, 225, 125, and 1500.
- Target RPM:** Points to the row with values 0.0, 0.0, 0.0, and 0.0.
- Actual RPM:** Points to the row with values 480, 480, 480, and 480.
- Control Valve Gain:** Points to the row with values 15.0, 15.0, 15.0, and 10.0.
- Drive Direction:** Points to the row with values 10, 10, 10, and 20.
- System Type (Number of Valves):** Points to the row with values 100, 7.5, and 50.

	1	2	3	4	5	N
Product Width	175	225	125			1500
Target RPM	0.0	0.0	0.0			0.0
Actual RPM	480	480	480			480
Control Valve Gain	15.0	15.0	15.0			10.0
Drive Direction	10	10	10			20
System Type (Number of Valves)	100	7.5	50			

Additional callouts on the right side of the screen include:

- Product Width:** Points to the top row of the table.
- Target RPM:** Points to the second row of the table.
- Actual RPM:** Points to the third row of the table.
- Control Valve Gain:** Points to the fourth row of the table.
- Drive Direction:** Points to the fifth row of the table.
- System Type (Number of Valves):** Points to the sixth row of the table.

The screen also displays a time of 10:14 am and a home button.

System Type (Number of Valves)

Step 1. On the Liquid/NH3 settings, select **System Type** by pressing the number next to the number of valves icon.

Step 2. Enter number of valves used in the NH3 system.

The default setting for number of valves is 2.

Note: When the **System Type** is set to 1, the control valve is commanded to close when the Master Work Switch is off. When the **System Type** is set to 2, the control valve does not change position when the Master Work Switch is off, but command the Shutoff Valve to close.

Drive Direction (Polarity)



Step 1. On the Liquid/NH3 settings, select **Drive Direction (Polarity)** by pressing the number next to the drive polarity icon.

Step 2. Enter the drive direction of your valve, either forward or reverse.

Note: The default polarity is  which will send a positive signal down the red wire to open the valve, and a positive signal down the green wire to close the valve..

Control Valve Gain



Step 1. On the Liquid/NH3 settings, select **Gain** by pressing the number next to the gain icon.

Step 2. Enter valve reaction speed.

- Usually, you should start the gain value at approximately 50. Adjust this value higher for faster response, or lower for slower response.
- There is a maximum gain value at which the motors and actuators on your system valves cannot open or close any faster.

Target RPM (Flow)



This value is the target flow of the liquid flowmeter based on current speed, calibration values, width, and target rate.

Actual RPM (Flow)



This value is the actual flow of the liquid flowmeter.

Calculating Liquid Calibration Number

Remember

Anhydrous ammonia (NH₃) contains 4.22 lbs. of actual N per gallon.

Your flow meter should have a tag that indicates the number of pulses per unit volume or weight of the liquid flowing through it.

Example

For this example a typical Raven flow meter will be used:

The Raven flow meter tag indicates it generates **710 pulses per 10 gallons** of liquid.

If there are **4.22 lbs of actual N per gallon**:

$$\frac{710 \text{ pulses}}{10 \text{ gallons}} \times \frac{1 \text{ gallon}}{4.22 \text{ lbs (N)}} = 16.82 \frac{\text{pulses}}{\text{lb(N)}}$$

To calculate Liquid Calibration Number:

Your liquid calibration number is very important for accurate application of anhydrous ammonia (NH₃). When entering your NH₃ rate, remember that you are applying NH₃ in **actual pounds of N (nitrogen) per acre**. Your Liquid Cal number has to be calculated as **pulses per pound of actual N**.

- Step 1. Locate the **Calibration Number Tag** on your flow meter.
- Step 2. Note the units of your flow meter's Cal Number. Depending on the brand of flow meter, the units may be given in:
 - a. Pulses per pound of product.
 - b. Pulses per 10 gallons of liquid.
 - c. Pulses per gallon of liquid.
 - d. Other.
- Step 3. Using the units used on your flow meter, create a formula to convert the value of Cal Number Tag to **pulses per pound of actual N**. (See Example)

The result is the **Liquid Calibration Number**.

Checking and Fine-Tuning NH3 Calibration

Tip!

When calculating the amount of product used per acre, be sure to remember that one pound of NH3 is 82% nitrogen. So, if you weigh your tank after use and a total of 1000 lbs has been applied, you applied 820lbs of actual N. If your rate per acre was 100 lbs of actual N, and you do 10 acres, and you know that 1220 lbs of NH3 were applied from tank, don't panic. 1220 lbs of NH3 is a total of 1000 lbs of actual N. At a desired rate of 100 lbs of N per acre, and a total of 10 acres, you are right on target.



Tip!

When fine tuning the actual applied rate you will have to use trial and error, making slight changes to the Liquid Cal number after applying each of several tanks of NH3. Typically adjust the Liquid Cal number by only 0.1 or 0.2 each time.

If you are under applying, increase the LIQUID CAL value by 0.1 or 0.2 until actual applied rate is acceptable.

If you are over applying, decrease the LIQUID CAL value by 0.1 or 0.2 until actual applied rate is acceptable.

To check the calibration of the NH3 controller:

- Step 1. Once the liquid cal value has been entered, and other functions on the NH3 screen are set, apply one tank of NH3 in the field.
- Step 2. Calculate the actual application rate per acres using the tare weight of the tank (NH3 used) and the total acres covered.
- Step 3. Compare the actual application rate with your desired application rate.
- Step 4. On the Main VR page, press the NH3  soft key. The NH3 page appears.
- Step 5. Select Liquid Cal Number. 

Adjust your Liquid Cal number as follows:

- Step 1. If your actual application rate is **less than** your desired application rate, **increase** the Liquid Cal number.
- Step 2. If your actual application rate is **greater than** your desired application rate, **decrease** the Liquid Cal number.

If further refinement of the calibration is needed, repeat the procedure.

Purging the NH3 System



The NH3 system can be purged using the Purge soft key.

- Step 1. On the Main VR page, press the **NH3** soft key. The NH3 page appears.

- Step 2. On the NH3 page, press the **Purge**  soft key three (3) times. NH3 product must be on.

The NH3 valves open for six (6) seconds, allowing NH3 to flow.

- Step 3. After six (6) seconds verify that the Purge indication on the NH3 page shows OFF and that flow has stopped.



Caution!

Ensure no one is around the implement and that the tractor is upwind before using this function.

This Page Left
Intentionally Blank

Blockage System Troubleshooting

<p>No loop information</p>	<p>The loop indicated is turned off.</p>	<p>To turn loop on, increase sensitivity >1</p>
<p>Communication error</p> 	<p>The monitor is not detecting any sensors.</p>	<p>Check all the cables and connections.</p> <p>Bypass Sensor 1 by connecting Sensor 2 to the sensor loop cable from the main wiring harness.</p>
	<p>If the message is no longer displayed...</p>	<p>...replace Sensor 1.</p>
	<p>If the problem persists...</p>	<p>...connect a Seed Sensor directly to the main wiring harness' male Sensor Loop Cable.</p>
<p>Monitor is showing less sensors than installed</p>	<p>The monitor is reading an incorrect number of sensors.</p>	<p>Check all the cables and connections.</p> <p>Bypass the last sensor by connecting the second last sensor to the sensor loop cable to the main wiring harness.</p>
	<p>If the message is no longer displayed...</p>	<p>...replace the last sensor in the loop.</p>
	<p>If the problem persists...</p>	<p>...connect a Seed Sensor directly to the main wiring harness.</p>
<p>Blocked Sensor</p>	<p>The sensor indicated is blocked.</p>	<p>Clean blockage from indicated run.</p>
	<p>If the indicated run is not blocked...</p>	<p>...verify the Sensitivity is not set too high.</p> <p>Check inside the distribution towers for any foreign material. This may cause blockages to move from sensor to sensor.</p>
	<p>If it is always the same sensor giving the blocked message...</p>	<p>...trade that sensor with one in another position.</p>
	<p>If the blocked message moves with the sensor...</p>	<p>...replace that sensor.</p>
	<p>If it is always the same sensor giving the blocked message...</p>	<p>...trade that sensor with one in another position.</p>
<p>Blocked runs are indicated but when checked and found to be clear.</p>	<p>The monitor is receiving incorrect blockage information.</p>	<p>Verify that the Sensitivity is not set too high.</p> <p>Check inside the distribution towers for any foreign material. This may cause blockages to move from sensor to sensor.</p>
	<p>If it is always the same sensor giving the blocked message...</p>	<p>...trade that sensor with one in another position.</p>

	If the blocked message moves with the sensor...	...replace that sensor.
Amp Overload	This message indicates that there is too large a power draw on the indicated sensor loop. There is most likely a short in the Sensor Loop.	Check all the cables and connections.
Monitor displays ERROR alarms when one loop is disabled, but no alarms when both loops enabled.	Typically this means that loops are all connected but cables are crossed either going to sensor 1 or coming back from the last sensor.	Trace sensor cables from the main wiring harness to the first and last sensor of one loop. Re-connect the cables correctly.

Section 6: System Troubleshooting

Symptom	What it Means	Recommended Action
Amity ECU doesn't show up on Virtual Terminal in Cab	Hitch connector not connected	Check the 9-pin connector at the front of the cart and the front of the drill.
	VT Pool memory has been corrupted	Delete the Pool Memory from the VT and restart the system.
	Incorrect Power from Tractor	Ensure there is proper power being supplied by the 9-pin connector on the Tractor.
Clutch Won't Engage	Terminating Resistor not Installed	Ensure there is a terminating resistor installed at the both ends of the ISO-Bus.
	Work Switch Not Engaged	Ensure you are: <ul style="list-style-type: none"> - Moving faster than the minimum ground speed - Work switch is in the "Seeder Ready" state - Automatic Work Switch is in the "Down" position
	Product 1 not enabled	Product 1 needs to be enabled for the clutch to engage.
	Product Type not configured as "Clutch"	Ensure the product is configured as a "Clutch" on the System Settings menu.
Hydraulic Motors won't Turn	Clutch Out of Adjustment	Ensure the clutch is assembled properly to the Driveshaft.
	Work Switch Not Engaged	Ensure you are: <ul style="list-style-type: none"> - Moving faster than the minimum ground speed - Work switch is in the "Seeder Ready" state - Automatic Work Switch is in the "Down" position
	Product not Enabled	Ensure the product you are trying to apply is enabled.
	Blower Hydraulics not On	The blower hydraulics need to be On for the hydraulic drive system to function.
	Foreign Object in the Meter	Check the meter compartment and remove any foreign objects that may be jamming the meter roll.
Calibrate Buttons on the ECU don't work (Hyd Drive)	ECU not receiving Power	Ensure there is power to the ECU. The lights on the ECU should be blinking when the ECU has power.
	Product not Enabled	Ensure the product you are trying to apply is enabled.
	Blower Hydraulics not On	The blower hydraulics need to be On for the hydraulic drive system to function.
	Foreign Object in the Meter	Check the meter compartment and remove any foreign objects that may be jamming the meter roll.
Erratic Hydraulic Motor Operation	VT Pool memory has been corrupted	Delete the Pool Memory from the VT and restart the system.
	Product Configured as Clutch	Ensure the "clutch" box in the System Settings menu is unchecked.
	Improper Tachometer Value	Ensure the "Targets per Rev" value in the Product Screen for each Bin is set to 60.
I finished my field and my meters put too much or too little product out.	Improper Meter Door Setting for Desired Application Rate	Check the Min and Max speed range for each product. Your desired seeding speed should be in the middle of that range.
	Improper Width Setting	Ensure the Width Setting is correct in the System Setup menu as well as in each Product Screen for each bin that's being used.
	Erroneous Calibration Value	Re-calibrate your meter to ensure the calibration value being used is correct.
	Ground Speed Source not Accurate	Perform the Distance Check procedure to ensure the Ground Speed source is accurate.
	Meter Door Setting changed without re-calibrating meter.	Calibration must be performed whenever the meter door setting is changed.
	Changed to a different product type without re-calibrating meter	Calibration must be performed when you switch to a different product type.
Bin Pressurization Problem	Ensure the Bin Door is fully closed and properly sealed and that the bin pressurization hose is properly installed.	

Symptom	What it Means	Recommended Action
Ground/meter speed sensor not picking up speed or the speed reading is erratic	Improper Sensor Range Adjustment	The recommended gap setting is 1/16" (.063") from the face of the sensor to the tip of the sprocket teeth. If the gap is out of range, adjust to bring back within specifications.
	Missing or Damaged Target	Replace the target sprocket if it is missing or if the teeth have been damaged. Ensure the sprocket is in proper alignment with the sensor.
	Sensor Physically Damaged by Target	If the sensor was adjusted too close to the target, it will be hit and damaged. Replace the damaged sensor and check for proper range adjustment.
	Damaged Sensor Mount	The sensor mounting bracket holds the sensor in place so that the sensor is at the proper location and spacing from the sprocket teeth. Replace or Repair the sensor mount if it is damaged and/or if the sensor barrel does not line up with the targets.
	Defective Sensor	When the sensor is powered, the red light on the sensor will be on. The light will remain solid-on during operation. If the light is not on or if the light is on and the ground speed reading remains at "0" when the cart is moving, check the wiring. If the wiring is good, replace the sensor.
	Defective Wiring	Use a jumper wire to intermittently jump across the Signal and Ground wires (Pins 2 & 3, Orange & Blue) in the main harness to simulate the sensor in operation. If "0" speed is still shown on the display while simulating, the sensor's signal is not getting back to the ECU and there is a bad/loose connection or a problem with the wiring. Perform steps to diagnose the harness.
Fan speed sensor not picking up speed or the speed reading is erratic	Improper Sensor Range Adjustment	The face of the sensor should be between 2mm and 4mm away from the target. If out of range, adjust to bring back within specifications.
	Sensor Physically Damaged by Target	If the sensor was adjusted too close to the target, it will get hit and damaged. Replace the damaged sensor.
	Defective Sensor	When the sensor is powered, the red light on the sensor will be on. When the sensor senses the target, the red light will go off until the target leaves the range of the sensor. Replace sensor if defective.
	Defective Wiring	Use a jumper wire to intermittently jump across the Signal and Ground wires (Pins 2 & 3, Pink & Blue) in the main harness to simulate the sensor working. If "0" speed is still shown on the display while simulating, the display head is not reading the sensor and there is a problem with the wiring. Perform steps to diagnose the wire harness.
	Missing or Defective Target	Two 3/8" x 1/2" UNC bolts are fastened to the fan rotor and are used as targets for the speed pickup. Lock washers are used under the bolt head. Replace any missing or damaged bolts/washers.
	Damaged Sensor Mount	The sensor mounting bracket holds the sensor in place so that the sensor is at the proper location and spacing from the two bolts (targets) on the fan rotor. Replace or Repair the sensor mount if it is damaged and/or if the sensor barrel does not line up with the targets.

Error! Reference source not found.

Symptom	What it Means	Recommended Action	
Meter-Box Proximity Sensor Not Operating Correctly	Meter Empty	If the meter-empty alarm is active, check the meter to ensure the meter is empty before performing further troubleshooting.	
	Sensor Face Dirty	If the face of the sensor has foreign material or product stuck to it, the sensor will give a false reading. Remove foreign material from the face of the sensor.	
	Sensor Sensitivity out of Adjustment	The light on the end of this sensor should be OFF when the meter box is empty and ON when the meter box is full of product. To properly adjust the sensitivity, empty the meter box (need to close the gate & pull the doors off), and ensure the face of the sensor is clean. Put the door back on and open the seed gate to allow product back into the meter box. With the meter box full of product, perform the following sensor adjustment: <ul style="list-style-type: none"> o Find the calibration screw on the rear of the sensor (next to the yellow light). Turn the screw counter-clockwise until the light turns off. If the light is already off, go to the next step. o Turn the screw clockwise until the light just turns back on. Then turn the screw 2 more full turns in the clockwise direction. 	
	Defective Sensor	Test the sensor by placing an object in-front of the sensor face. The LED light on the sensor should light up when the object is present. The LED light should be off when there is nothing in front of the sensor. The sensor needs to be connected to the harness and the monitor needs to be turned on to perform this test. Replace sensor if defective.	
	Defective Wiring	Use a jumper wire to jump across the Signal and Ground wires (Pins 2 & 3, Violet & Blue) in the main harness to simulate a full meter. The Low-Meter alarm should activate when the sensor is unhooked and the alarm should be off when the jump-wire is used. If these alarm conditions are not observed, begin troubleshooting the wire harness.	
	Low-Bin Level Sensor Not Operating Correctly	Bin Empty	If the low-bin alarm is active, check the bin to ensure the seed level is below the sensor before performing further troubleshooting.
		Defective Sensor	Test the sensor by blocking the path between the two sensor eyes. When the path is open, the low-bin alarm should be active. When the path is blocked, the low-bin alarm should be off. Replace sensor if defective.
Improper Sensor Mounting		Ensure the sensor is mounted in a position where product cannot collect on the sensor.	
	Defective Wiring	Use a jumper wire to jump across the Signal and Ground wires (Pins 2 & 3, Tan & Blue) in the main harness to simulate a low-bin level condition. If the bin alarm does not activate, begin troubleshooting the wire harness.	

Section 7: Appendix

Appendix A: Connector Pinouts**ECU Signal Connectors**

Left Connector (Black Body)		Center Connector (Grey Body)		Right Connector (Blue Body)	
Pin #	Function	Pin #		Pin #	Function
1	Motor 1 Power	1		1	Bin 3 Signal
2	Motor 4 Power	2		2	Meter 3 Signal
3	CAN Comm. High	3		3	
4	Bin 1 Signal	4		4	
5	Meter Box 1 Signal	5		5	
6		6		6	
7	Meter Box 2 Signal	7		7	
8	Motor 1 Ground	8		8	
9	Bin 2 Signal	9		9	
10	Motor 3 Ground	10	Sensor Power (12V)	10	
11	Speed Signal	11		11	
12	Motor 3 Power	12		12	
13	Fan 1 Signal	13		13	
14	Fan 2 Signal	14		14	
15	CAN Comm. Low	15		15	
16		16		16	
17	Tach 1 Ground	17		17	
18	Tach 2 Ground	18		18	
19	Tach 3 Ground	19		19	
20	Tach 2 Signal	20		20	
21	Tach 4 Ground	21	Sensor Ground	21	
22	ECU Ground	22		22	
23	ECU Power	23		23	
24	Tach 1 Signal	24		24	
25	Motor 2 Ground	25		25	
26	Motor 2 Power	26		26	
27	Tach 4 Signal	27		27	
28	Tach 1 Power	28		28	
29	Tach 2 Power	29		29	
30	Tach 3 Power	30		30	Bin 4 Signal
31	Tach 4 Power	31		31	
32	Work Signal	32		32	Meter 4 Signal
33	Motor 4 Ground	33		33	
34	Tach 3 Signal	34		34	
35		35		35	

Notes:

- All connections terminated in Ampseal 35 pin plug, AMP 776164
- Each Ampseal connector has a different polarization (colour) to prevent incorrect connection

ISO-BUS Extension Connector

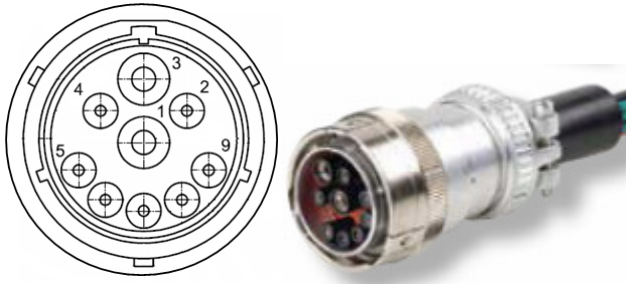

<i>Pin #</i>	<i>Function</i>
1	Battery Negative
2	ECU Ground
3	Battery Positive
4	ECU Power
5	TBC_DIS
6	TBC_PWR
7	TBC_RTN
8	CAN H
9	CAN L

Notes:

- Battery Positive and Negative on double 8AWG wiring to reduce voltage drop between battery and ECU power terminals in high current systems.
- Dust cap provided to protect connector when not in use

CAN Terminator Connector



<i>Pin #</i>	<i>Function</i>
A	
B	TBC PWR
C	
D	TBC RTN
E	CAN H
F	CAN L

Notes:

- Connector mates with Powell TBC. TBC (CANBUS terminating bias circuit) should only be installed at the physical end of the CANBUS system.
- Terminated in Metripack 12052848 connector (150 Series)

ECU Power Contacts



<i>Pin #</i>	<i>Function</i>
N/A	Battery Positive (red)
N/A	Battery Negative (black)

Notes:

- #10 (M5) ring terminal connects to ECU power terminals.
- Battery Positive and Negative on double 8AWG wiring to reduce voltage drop between battery and ECU power terminals in high current systems.
- Caution! – reverse polarity power connection will damage ECU

Motor Control Connectors

Pin #	Function
1	Motor Power
2	Motor Ground

Notes:

- Electric motor or electric over hydraulic control is possible
- Terminated in Deutsch DT06-2S connector, contacts rated to 13 amps, 16AWG wiring
- Mating connector is Deutsch DT04-2P

Motor Speed (Tach) Connectors

Pin #	Function
1	Tach Power
2	Tach Signal
3	Tach Ground

Notes:

- Independent feedback for up to 4 variable rate meters/motors
- Terminated in Deutsch DTM06-3S connector, contacts rated to 7 amps, 20AWG wiring
- Mating connector is Deutsch DTM04-3P

Low-Bin Level Sensor Connectors

Pin #	Function
1	Bin Power
2	Bin Signal
3	Bin Ground

Notes:

- Independent feedback for up to 4 bin level sensors (infrared, capacitive proximity)
- Mates directly to Agtron bin level sensors, 3rd party sensors may require additional wiring
- Terminated in Deutsch DTM06-3S connector, contacts rated to 7 amps, 20AWG wiring
- Mating connector is Deutsch DTM04-3P

Meter Box Sensor Connectors

Pin #	Function
1	Meter Power
2	Meter Signal
3	Meter Ground

Notes:

- Independent feedback for up to 4 additional bin level sensors (infrared, capacitive proximity)
- Mates directly to Agtron bin level sensors, 3rd party sensors may require additional wiring
- Terminated in Deutsch DTM06-3S connector, contacts rated to 7 amps, 20AWG wiring
- Mating connector is Deutsch DTM04-3P

Ground Speed Sensor Connector



<i>Pin #</i>	<i>Function</i>
1	Speed Power
2	Speed Signal
3	Speed Ground

Notes:

- Ground speed sensor feedback (hall effect, reed switch, inductive)
- Mates directly to Agtron inductive and reed switch sensors, 3rd party sensors may require additional wiring
- Wiring is common between the radar and speed sensor connections; only one speed source can be used.
- Terminated in Deutsch DTM06-3S connector, contacts rated to 7 amps, 20AWG wiring
- Mating connector is Deutsch DTM04-3P

Fan Sensor Connectors



<i>Pin #</i>	<i>Function</i>
1	Fan Power
2	Fan Signal
3	Fan Ground

Notes:

- Independent feedback for up to 2 fan RPM sensors (hall effect, reed switch, inductive)
- Mates directly to Agtron inductive and reed switch sensors, 3rd party sensors may require additional wiring
- Terminated in Deutsch DTM06-3S connector, contacts rated to 7 amps, 20AWG wiring
- Mating connector is Deutsch DTM04-3P

Anhydrous Ammonia/Liquid Control Connector

Pin #	Function
A	Flowmeter Signal
B	Battery Positive
C	Flowmeter Ground
D	N/A
E	Flowmeter Power
F	Shutoff Valve Ground
G	Rate Control Valve Negative
H	Rate Control Valve Positive
J	Shutoff Valve Power
K	Battery Negative

Notes:

- Terminated in Metripack 150 series 10 pin receptacle
- Mates directly to Micro-Trak harness part number 13273.
- Adaptors for the Raven Accu-Flow system available.

Appendix B: Metric Conversion Factors

To convert from English to Metric measurements, multiply by the following factors.

To Convert	To	Multiply By
Inches	Millimeters	25.4
Feet	Meters	0.3048
Yards	Meters	0.9144
Miles	Kilometers	1.609
Square Foot	Square Meters	0.0929
Acres	Hectares	0.4047
Pound	Kilogram	0.4536
Cubic foot	Cubic Meter	0.02832
Bushel	Cubic Meter	0.03524
Cubic foot	Bushel	0.8
Pounds/Square Inch	Kilopascals	6.8948
Pounds/Square Inch	Bar	0.06895
Pounds-Force-Foot	Newton-Meters	1.3568
Miles-Per-Hour	Kilometers-Per-Hour	1.609
Pounds-Per-Acre	Kilograms-Per-Hectare	1.1209
Acre-Per-Hour	Hectare-Per-Hour	0.405
Feet-Per-Minute	Meters-Per-Second	0.005
Feet-Per-Second	Meters-Per-Second	0.305
Horsepower	Kilowatt	0.746
Pounds/Square Inch	Inches H ₂ O	27

Appendix C: Common Values and Equations

Approximate Tank Fill Percentages					
Ladder Rung (from top)	Model 2800	Model 3350	Model 5250		
	Front & Rear	Front & Rear	Front	Middle	Rear
1 st	90%	85%	99%	99%	99%
2 nd	75%	60%	85%	90%	85%
3 rd	45%	35%	65%	65%	65%
4 th	15%	15%	45%	40%	45%
5 th	5%	5%	20%	15%	20%
6 th	NA	NA	5%	5%	5%

Common Commodity Densities	
Commodity	Density (lbs/bu)
Wheat/Durum	60
Soybeans	60
Barley	48
Oats	32
Canola	52
Corn	56
Dry Fertilizer	60-70

$$Rate(lbs / min) = \frac{Width(ft) * Speed(mph) * FieldRate(lbs / acre)}{495}$$

$$Performance(acres / hr) = \frac{Width(ft) * Speed(mph)}{8.25}$$

Appendix D: Advanced Screens

	Bin 1	Bin 2	Bin 3	Bin 4	Bin 5	NH3
	1	2	3	4	5	N
Product Enable						
GND/HYD Drive						
Tank Size		175	225	125		1500
Target Rate		0.0	0.0	0.0		0.0
Actual Rate		0.0	0.0	0.0		0.0
Implement Width		480	480	480		480
Minimum RPM		10	10	10		
Maximum RPM		100	100	100		
Calibration RPM		25	25	25		
Target RPM		0	0	0		0
Actual RPM		0	0	0		0
Drive A Current Overload		15.0	15.0	15.0		10.0
Drive B Current Overload						7.5
Drive Gain		50	50	50		50
Tach Targets/Rev		60	60	60		
Allowable Error %		10	10	10		20
Fixed PWM% Output Override		0	0	0		
Drive Direction						
Drive Frequency						100
NH3 Valve Type						2

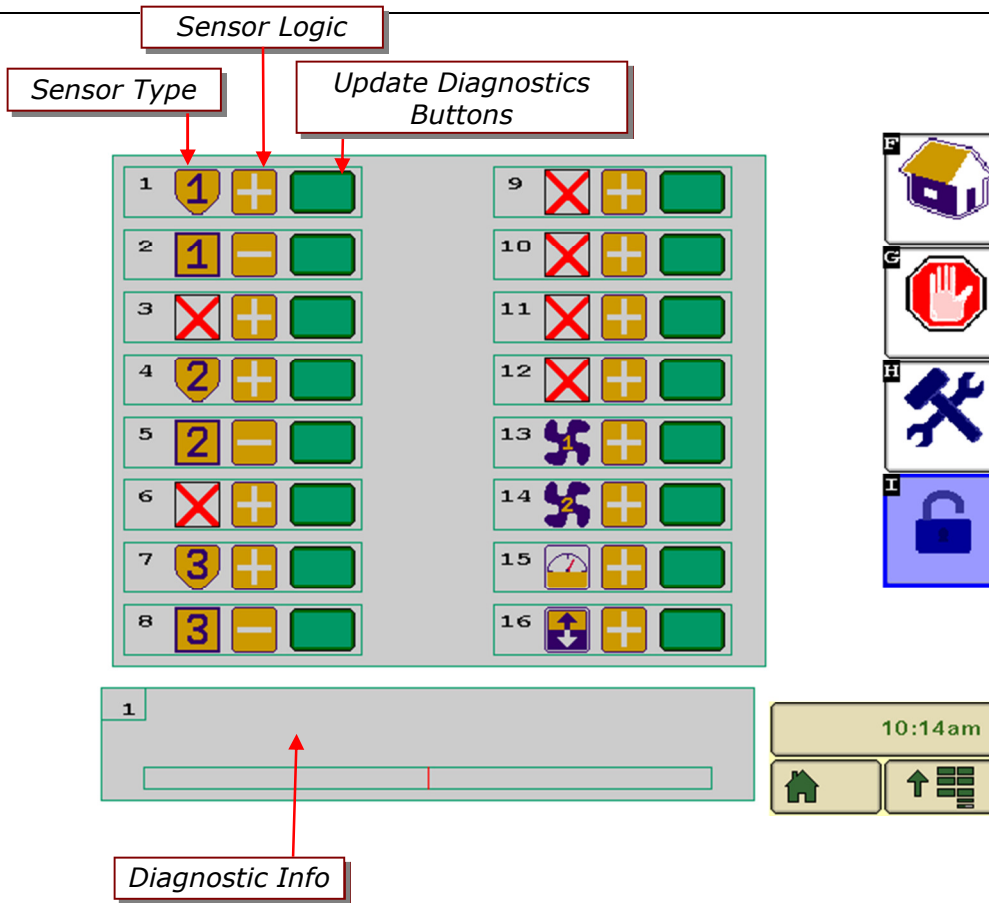







Cart ECU Sensor Channel Info

- | | |
|-----------------|-------------------------------------|
| 1 – Bin 1 | 9 – N/A |
| 2 – Meter Box 1 | 10 – Bin 4 |
| 3 – N/A | 11 – Meter Box 4 |
| 4 – Bin 2 | 12 – N/A |
| 5 – Meter Box 2 | 13 – Fan 1 |
| 6 – N/A | 14 – Fan 2 (Opt.) |
| 7 – Bin 3 | 15 – Ground Speed (ECU Input) |
| 8 – Meter Box 3 | 16 – External Automatic Work Switch |

Sensor Types

The following symbols represent the sensor types that are available:

Symbol	Sensor Type
	Bin 1-4
	Meter Box 1-4
	Fan 1-2
	Ground Speed
	Internal Work Switch
	External Work Switch
	None

Notes:

Notes: