

Easy and Affordable Solutions  
for Better Health™



# INSTRUCTION MANUAL

Model KD-923

# PLEASE READ BEFORE USE

# Blood Pressure MANAGEMENT SYSTEM

# ANDON BP-Manager™

\*NOTE: The system is intended for information purposes only, for expert advice make sure to consult a healthcare professional. Any instructions for change in treatment and health related information or advice should only be made directly with a healthcare professional. The ANDON BP-MANAGER™ is a non-invasive blood pressure monitor intended for the measurement of systolic (SBP) and diastolic (DBP) blood pressure and heart rate (HR or pulse rate) using the oscillometric technique. The ANDON BP-MANAGER™ is used as an aid to monitoring blood pressure in adults (individuals aged 18 and older) in a non-clinical environment such as in the home. Results are displayed on the ANDON BP-MANAGER™ screen. The ANDON BP-MANAGER™ should not be used on infants or children. Contraindications for Use: The end user of this device should not have common arrhythmias, such as atrial or ventricular premature beats or atrial fibrillation.



# Table of Contents

<b>TABLE OF CONTENTS</b>	<b>2</b>	<b>FUNCTIONS</b>	<b>16</b>
<b>INTRODUCTION</b>	<b>3</b>	Main Screen	16
<b>CONTENTS</b>	<b>4</b>	Taking Your Blood Pressure Measurement	17
<b>REQUIREMENTS</b>	<b>5</b>	Error Display	18
<b>!WARNINGS!</b>	<b>6</b>	Looking at Previously Taken Readings	19
<b>ANDON Pod™</b>		Looking at Messages	20
<b>LOCATION/INTERFERENCE</b>	<b>7</b>	Looking at Graphics	21
<b>BEFORE YOU START</b>	<b>8</b>	Users	22
Your ANDON BP-Manager™	8	Select User	22
Your ANDON Pod™	9	Add/Remove User	23
<b>INSTALLATION</b>	<b>10</b>	<b>CARE AND MAINTENANCE</b>	<b>25</b>
Connecting Your ANDON Pod™	10	<b>SPECIFICATIONS</b>	<b>26</b>
Using an RJ11 Jack	10	ANDON BP-Manager™	26
Back-up Batteries	11	ANDON Pod™	26
Powering Up Your ANDON BP-Manager™	11	<b>FCC STATEMENT</b>	<b>27</b>
First Time Power Up and Registration	12	<b>CUSTOMER INFORMATION</b>	<b>28</b>
<b>SUGGESTIONS BEFORE TAKING A MEASUREMENT</b>	<b>13</b>	<b>SERVICE REQUIREMENTS</b>	<b>29</b>
<b>HOW TO APPLY THE ARM CUFF</b>	<b>13</b>		
Applying the Pressure Cuff	14		
<b>HOW TO TAKE A PROPER MEASUREMENT</b>	<b>15</b>		

---

# Introduction

Thank you for purchasing the ANDON BP-MANAGER™, or KD-923 and ANDON POD™, or ILP 0001. This completely automatic system measures your blood pressure and pulse rate, captures subjective information and manages everything automatically so that you can better manage your blood pressure with your care provider. Your measurement reading is clearly displayed on a large screen on the ANDON BP-Manager™ after each measurement, and later stored for a more detailed analysis in the form of tables for easy viewing and graphs for easy interpretation. Your new ANDON BP-Manager™ uses the oscillometric method of blood pressure measurement, detecting your blood's movement through your brachial artery and converting the movements into a digital reading. An oscillometric monitor does not need a stethoscope so the monitor is simple to use.

The ANDON KD-923 BP-Manager™ is a non-invasive blood pressure monitor intended for the measurement of systolic (SBP) and diastolic (DBP) blood pressure and heart rate (HR or pulse rate) using the oscillometric technique. The ANDON BP-Manager™ is used as an aid to monitoring blood pressure in adults (individuals aged 18 and older) in a non-clinical environment such as in the home. Results are displayed on the ANDON BP-Manager™ screen. The ANDON BP-Manager™ should not be used on infants or children. Contraindications for Use: The end user of this device should not have common arrhythmias, such as atrial or ventricular premature beats or atrial fibrillation.

***Please read this instruction manual thoroughly. For proper interpretation of pressure measurements, make sure to consult a physician.***

***The ANDON BP-Manager™ can be used alone to automatically measure your blood pressure.***

***If you would like to transmit blood pressure information for display on a personal computer, the optional ANDON Pod™ can be purchased.***

***Instructions for Use for the ANDON BP-Manager™ and for the ANDON Pod™ are included in this Instruction manual.***

***\*\*Warning: This system is not recommended for use on infants and is not intended for and should not be used to try to measure the blood pressure of infants and children (anyone under the age of 18) as it may not be accurate and/or relied upon.***

# Contents

For Respective Products, make sure your package includes the following items:

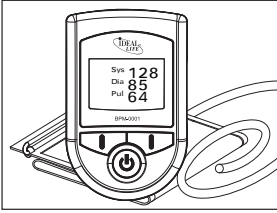

**KD-923  
ANDON  
BP-MANAGER™**

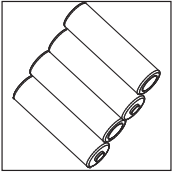

**4X "AA" ALKALINE BATTERIES FOR YOUR  
ANDON BP-MANAGER™**

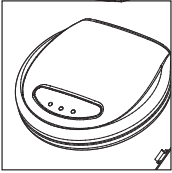

**ILP 0001 ANDON POD™**  
(\* An optional accessory, sold separately)

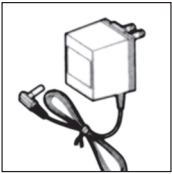

**AC ADAPTER**  
(\* An optional accessory, sold separately)

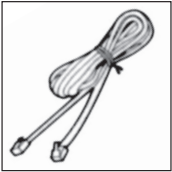

**TELEPHONE LINE CORD**  
(\* An optional accessory, sold separately)

# Requirements



## ***MODULAR JACK REQUIREMENTS***

When using your ANDON BP-Manager™ with an ANDON Pod™, you will need an RJ11 type modular jack, which is the most common type of phone jack and might look like the one pictured here. If you don't have a modular jack, call your local phone company to find out how to get one installed.

## ***ADDITIONAL BATTERIES***

You may wish to use rechargeable batteries in your ANDON Manager™. The ANDON Pod™ is equipped to recharge batteries.

## **!Warnings!**

---

# **!Warnings!**

To assure the correct use of the product basic safety measures should always be followed including the precautions listed below:

- Read all the information in the instruction manual and any other literature included in the box before using the unit.
- Follow the instructions of your healthcare provider.
- Contact your physician for specific information about your blood pressure.
- Operate the unit only as intended. Do not use for any other purpose.
- The ANDON KD-923 BP-Manager™ is a non-invasive blood pressure monitor intended for the measurement of systolic (SBP) and diastolic (DBP) blood pressure and heart rate (HR or pulse rate) using the oscillometric technique. The ANDON BP-Manager™ is used as an aid to monitoring blood pressure in adults (individuals aged 18 and older) in a non-clinical environment such as in the home. Results are displayed on the ANDON BP-Manager™ screen. The ANDON BP-Manager™ should not be used on infants or children. Contraindications for Use: The end user of this device should not have common arrhythmias, such as atrial or ventricular premature beats or atrial fibrillation.
- This system is not recommended for use on infants and is not intended for and should not be used to try to measure the blood pressure of infants and children (anyone under the age of 18) as it may not be accurate and/or relied upon.
- Changes or modifications not approved by ANDON INC. may affect the proper functioning of this product. No recalibration or verification is needed, as the accuracy of the cuff-pressure transducers/indicators is valid for the life of the product. The system might not meet its performance specifications if stored or used outside the specified temperature and humidity ranges detailed below. Do not disassemble or attempt to repair the unit or components. In the event of malfunction, call ANDON™ directly as instructed below.
- Blood pressure measurements determined with this device are equivalent to those obtained by a trained observer using the cuff/stethoscope auscultation method within the limits prescribed by the American National Standard, Electronic or automated sphygmomanometers. A report of clinical performance study findings that used the fourth Korotkoff sign to determine overall efficacy are available upon written request with proof of purchase.

# ANDON Pod™

When using an ANDON Pod™ to communicate information from your ANDON BP-Manager™, wireless radio waves are used. For maximum distance and interference-free operation, the recommended ANDON Pod™ location is:

- Away from electrical appliances such as a TV, personal computer or a cordless phone

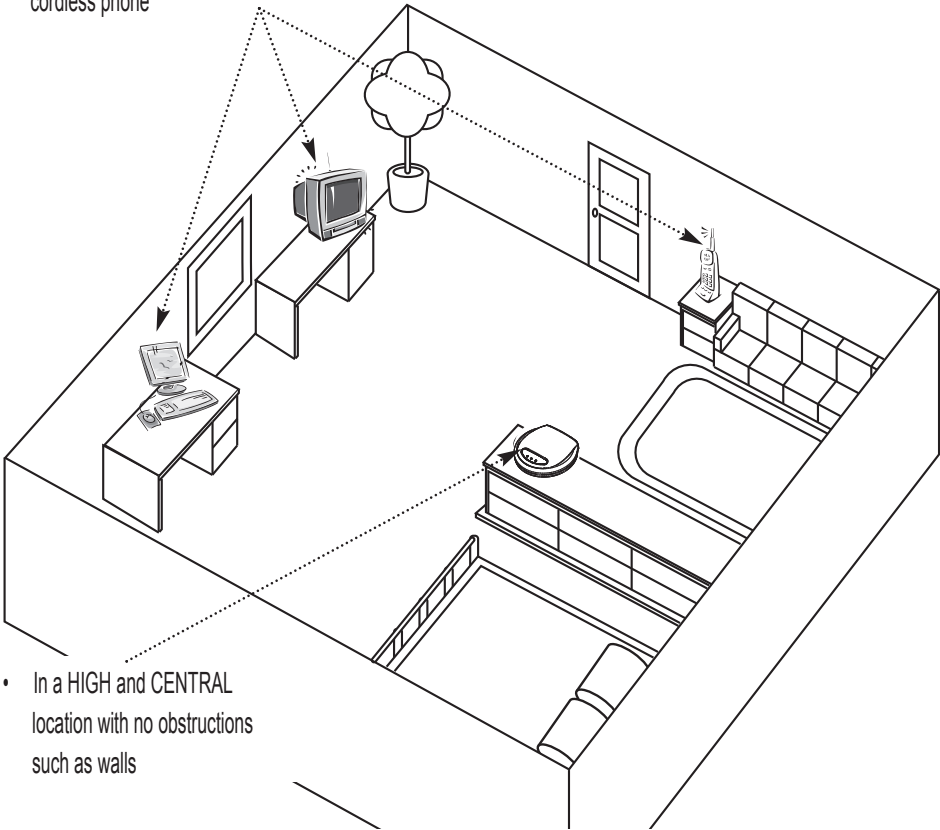

- In a HIGH and CENTRAL location with no obstructions such as walls

**Note:**

While using an ANDON Pod™, the telephone line will be in use. If the telephone line is in use before using your ANDON Pod™ and you wish to use your ANDON Pod™ while the telephone line is being used, the unit will not be able to make a connection and will store the information in your ANDON BP-Manager™ for later transmission.

# Before You Start

To assure the correct use of the product basic safety measures should always be followed including the precautions listed below:

- Read all information in the instruction manual and any other literature included in the box before using the unit.
- Follow the instructions of your healthcare provider.
- Contact your physician for specific information about your blood pressure.
- Operate the unit only as intended. Do not use for any other purpose.
- This product is intended for information purposes only. It is not intended for diagnostic purposes and is not intended and should not be used on infants or children (anyone under the age of 18).
- This is not a clinical device, but a tool for information purposes only.
- Changes or modifications not approved by ANDON INC. may affect the proper functioning of this product. Do not disassemble or attempt to repair the unit or components.

## Your ANDON BP-Manager™

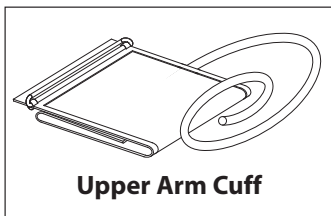
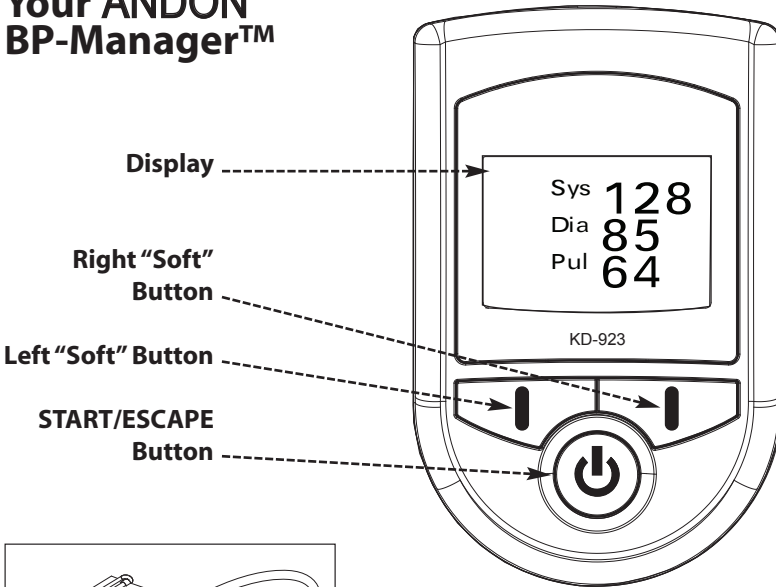

**REMEMBER:** You can stop the inflation or deflation process anytime by pressing any button.



# Your ANDON Pod™

(\*An optional accessory, sold separately)

**Power button**

**LED Display**

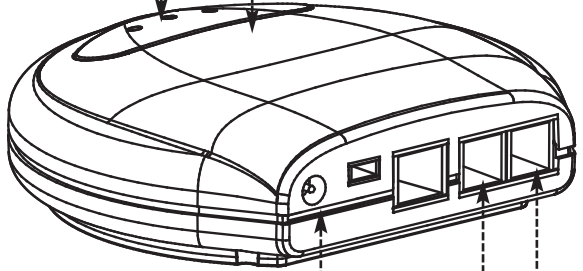

**AC Adapter Jack**

**Telephone line cord RJ11  
Jack For Telephone  
Connection**

**Telephone line cord RJ11  
Jack For Line Connection**

**Battery Cover**

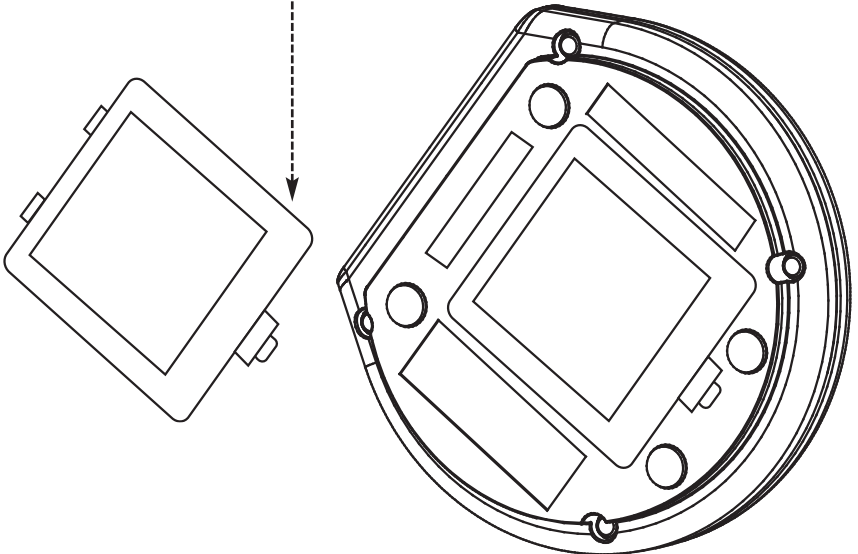

# Installation

**! FOR YOUR ANDON Pod™ !**

## Connecting your ANDON Pod™

**USING AN RJ11 JACK**

### **CAUTION!**

- Unplug phone cord from wall before installing, plugging in an external power source, or changing batteries.
- Never install telephone wiring during a lightning storm.
- Never touch uninsulated telephone wire or terminals, unless the telephone line has been disconnected at the network interface.
- Use caution when installing or modifying telephone lines.

Plug one end of the telephone line cord (provided) into the jack on the back of your ANDON Pod™ marked LINE.

**Note: The ANDON Pod™ is designed not to draw power from the batteries when the AC adapter is in use.**



Plug the other end of the telephone line cord (provided) into a modular wall jack.

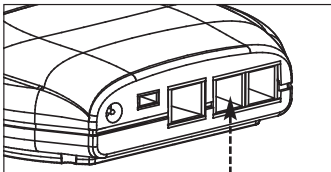

If you wish to use the same modular wall jack for your ANDON Pod™ and your telephone, connect the telephone line cord from your telephone into the jack on the back of your ANDON Pod™ marked PHONE.

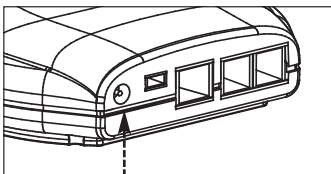

Connect the small end of the power supply into the power AC jack on the back of the ANDON Pod™ marked POWER. Plug the other end into an AC power outlet.

Your ANDON Pod™ will automatically power up once it is plugged in to an AC power outlet.



## **USING AN RJ45 JACK**

Plug one end of the Ethernet cord (not provided) into a modular RJ45 wall jack.

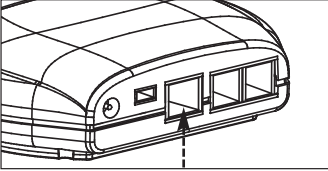

Plug the other end of the Ethernet cord (not provided) into the RJ45 jack on the back of your ANDON Pod™.

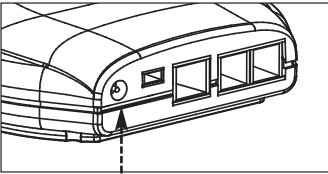

Connect the small end of the power supply into the power AC jack on the back of the ANDON Pod™ marked POWER. Plug the other end into an AC power outlet.

Your ANDON Pod™ will automatically power up once it is plugged in to an AC power outlet.

## **RECHARGING BATTERIES WITH YOUR ANDON POD™:**

- Remove the battery compartment door on the bottom of your ANDON Pod™ by pushing gently in the direction shown on the battery cover.
- Place the rechargeable batteries as marked.
- Replace the battery compartment door and push the compartment door shut in the opposite direction shown on the battery cover.
- When using rechargeable batteries with your ANDON BP-Manager™, simply place them in your ANDON Pod™ for 10 hours to recharge when battery status is low as indicated on your ANDON BP-Manager™

## **Powering Up Your ANDON BP-Manager™** **INSTALLING THE BATTERIES (INCLUDED)**

- Remove the battery compartment door on your ANDON BP-Manager™ by lifting the battery door using the notch
- Place the batteries as instructed on the device
- Replace the battery compartment door and click into place

### **Note:**

Replacing the battery does not affect previous test results stored in memory of the meter. However,

# Installation

---

the time and date settings may need to be updated if batteries are not in the device for an extended period of time. Use only new batteries of the required size and the recommended type. For best performance and the longest life, alkaline batteries are recommended. Do not mix different type, date or brand name batteries together. Be sure to follow the instructions when installing the batteries. Since batteries can leak Chemicals that damages electronic parts, leaving the battery in the housing for a long period without using the device may damage the main unit. Please remove the batteries if you are not going to use the device for an extended period of time (i.e., 3 months or more). The batteries should be kept away from small children as they pose a choking hazard. If swallowed, promptly see a doctor for help.

## **FIRST TIME POWER UP AND ACTIVATION WHEN USING AN ANDON POD™ (\*an optional accessory, sold separately)**

To use the ANDON BP-Manager™ with your ANDON Pod™ you must call an ANDON customer representative to activate. Make sure to call ANDON before you begin. Then make sure that the ANDON Pod™ is connected to a telephone line cord and RJ11 jack, (or an Ethernet cord and RJ45

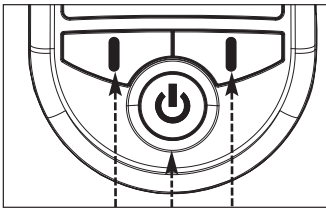

jack) and “Powered ON”! Hold down any button on your ANDON BP-Manager™ for 3 seconds to Power up. **READ THROUGH THE ANDON INC. TERMS AND CONDITIONS FIRST, THEN PROCEED AND FOLLOW THE PROMPTS ON THE SCREEN AS SHOWN HERE:**



First select the appropriate language using the buttons labeled ↓ and OK.

Then Answer the question on the following screen regarding terms and conditions using the YES and NO labeled buttons.

To gain full advantage of all the features your ANDON BP-Manager™ has to offer, using an IANDON Pod™ is recommended. To ensure that your ANDON BP-Manager™ and v Pod™ are setup properly you will need to call ANDON directly to activate your system. You should ensure that the steps are followed correctly, you should first setup your ANDON Pod™, power it up, and then begin the steps of powering up your ANDON BP-Manager™. During your activation call with ANDON, an ANDON customer representative will verify your ANDON BP-Manager™ and ANDON Pod™ ID numbers. and you will be ready to take full advantage of all your ANDON BP-Manager™ has to offer. For a detailed description of all the features and functions continue to the FUNCTIONS section of this manual.

# Suggestions Before Taking A Measurement

- Avoid eating, smoking, and exercising for 30 minutes before taking a measurement. Rest at least 15 minutes before taking a measurement.
- Stress raises blood pressure. Avoid taking measurements during stressful times.
- Remove tight-fitting clothing from your left arm.
- Measurements should be taken in a quiet place.
- Sit in a chair with your feet flat on the floor. Rest your left arm on a table so that the cuff is at the same level as your heart.
- Remain still and do not speak during the measurement.
- It is recommended that a record of your blood pressure and pulse readings be brought to your physician on a regular basis, as a single measurement does not provide an accurate indication of your true blood pressure.
- It is recommended that you take and record several readings over a period of time, measuring your blood pressure at the same time each day for consistency.
- If you are taking multiple readings consecutively, you should wait 2-3 minutes between measurements. The wait time allows the arteries to return to the condition prior to taking the blood pressure measurement. You may need to increase the wait time depending on your individual physical characteristics.

***CAUTION: Blood pressure recording can be affected by the position of the subject, his/her physiologic condition, and other factors.***

# How To Apply The Arm Cuff

Your ANDON BP-Manager™ applies the Oscillometric method to measure human systolic/diastolic blood pressure and heart rate. All values are shown on the LCD monitor.

## Applying the Pressure Cuff

### STEP 1

Connect the Air Plug to the Air Jack at the side of the monitor.

### STEP 2

Assemble the cuff as shown in the figure. The smooth cloth is on the inside of the cuff loop.

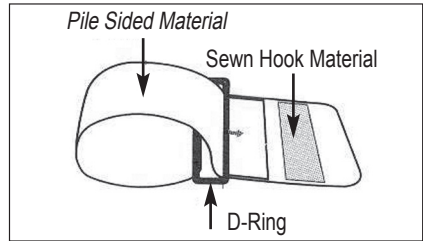

### STEP 3

Hold your left arm in front of you with your palm facing up. Pull your arm through the cuff loop.

### STEP 4

The edge of the cuff should be approximately 0.3 to 1.2 inches (2cm to 3cm) above your elbow. Align the tubing over the main arteries on the inside of your arm.

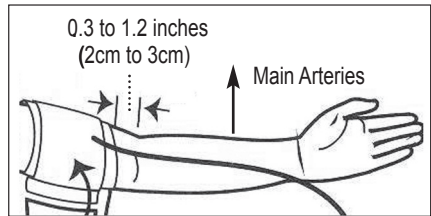

### STEP 5

When the cuff is positioned correctly, pull the end of the cuff to tighten the cuff snugly around your upper arm. You should be able to fit your index finger between the cuff and your arm.

### STEP 6

Press the hook material firmly against the pile material. The top and bottom edges of the cuff should be tightened evenly around your arm.

# How To Take A Proper Measurement

Please sit or lie down for at least 5-10 minutes before measuring. Perform measurement while sitting.

## **STEP 1**

Place your elbow on a table or other object. Relax your hand with the palm facing up.

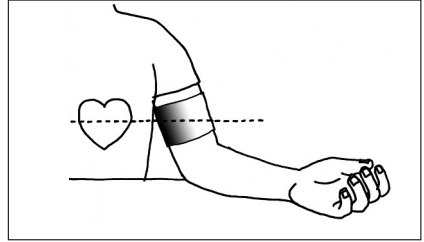

## **STEP 2**

Make sure the pressure cuff is at the same level as your heart. This is extremely important for the accuracy of the results. Higher or lower positions will give deviations from the true value.

# Functions

(when using the ANDON POD™,  
an optional accessory sold separately)

## Main Screen

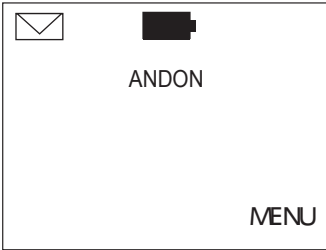

The Main Screen is your default screen. This is where you will be directed to after completing functions and where you will find status indicators for the functioning of your ANDON BP-Manager™.

In the upper middle portion of the display you will find a battery icon, displaying power status of your ANDON BP-Manager™



Indicates full power



Indicates power is getting low, you should change your batteries



Indicates that your blood pressure measuring function has been turned off.  
Replace your batteries immediately.



If you have unread messages, you will see an envelope icon on the upper left corner of the display.



# Taking Your Blood Pressure Measurement

Please sit or lie down for at least 5-10 minutes before measuring. Perform measurement while sitting.

## STEP 1

Place your elbow on a table or other object. Relax your hand with the palm facing up.

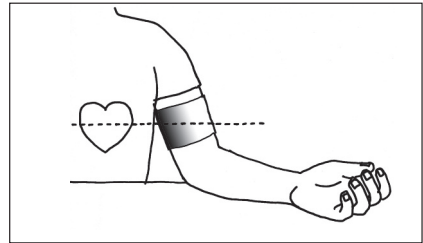

## STEP 2

Make sure the pressure cuff is at the same level as your heart. This is extremely important for the accuracy of the results. Higher or lower positions will give deviations from the true value.

From the default screen, press the "⏻" button located in the center of the key pad to continue.

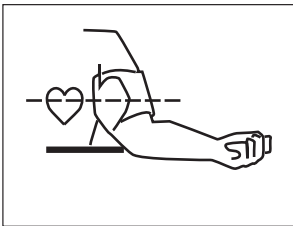

A graphic will appear to show the correct placement of the cuff on the arm.

Your ANDON BP-Manager™ will begin to inflate automatically.

Do not talk or move during the measurement.

The cuff will quickly inflate to the appropriate level and will get tighter around your arm. If the cuff becomes too tight, press

any button to stop the unit from inflating and then re-wrap the cuff, leaving a little more room between the cuff and your arm.

***! You can stop the inflation/deflation at any time by pressing any button on your ANDON BP-Manager™ !***

When the measurement is complete, the cuff will automatically deflate releasing the cuff's air pressure. Your ANDON BP-Manager™ will then display your reading automatically, and begin to communicate when you are using your ANDON Pod™. Your ANDON BP-Manager™ will notify you on the bottom of the display as to the status of your connection. Connection times may vary depending on many factors. Your reading will always be stored in your meter memory for local lookup. After displaying your reading and automatically communicating the information, your meter will automatically return to the default screen before going to sleep mode. Each time your ANDON BP-Manager™ communicates successfully to ANDON through your ANDON Pod™ the time and date are set to ensure reliable date and time stamping of all readings.

## Functions

---

### ***ERROR DISPLAY***

An error will be displayed for the following:

- Noise, movement or talking during a measurement.
- Inadequate pressure for cuff inflation due to movement or talking during measurement.
- Cuff improperly applied (too tight, too loose, improper position).
- Other factors may also cause an error to display.

***NOTE: If you receive an error, wait 2-3 minutes and retake your measurement. If you still receive an error, wait for the unit to go into sleep mode, then try again and retake your measurement. If you continually receive the same error after repeated usage, call an ANDON customer representative at: 1-888-IDEAL-41 ( 86-22-60526081 ) .***

**LOOKING AT PREVIOUSLY TAKEN READINGS**

Your ANDON BP-Manager™ will store up to 575 of your latest readings.

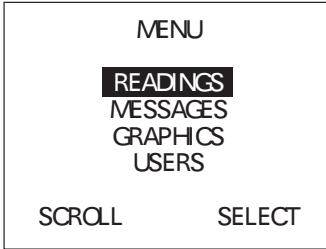

Press Menu to view the feature list.

SCROLL to highlight READINGS (it should already be highlighted as it is the first line item in the list).

Press SELECT to enter your selection.

DATE	SYS	DIA	PUL
0210	120	82	71
0209	122	84	70
0208	118	84	70
0208	120	82	71
0207	118	82	73

NEXT

You can now scroll through your readings, screen by screen using the NEXT (and BACK) buttons.

DATE	SYS	DIA	PUL
0206	120	85	70
0205	122	84	70
0204	121	83	72
0203	123	85	75
0202	120	82	71

BACK                          NEXT

If you have less than one page full of readings or have reached your final screen you can press the button labeled EXIT to return to the MENU section (Remember you can always press the START/ESCAPE button to return to the default screen).

### Looking at Messages

Your ANDAN BP-Manager™ is equipped for 2-way, interactive communication when using an ANDAN Pod™. Messages can be sent remotely to your ANDAN BP-Manager™ and responded to directly. When messages are transmitted to your ANDAN BP-Manager™, they are stored for automatic display before your next blood glucose measurement. If you have unread messages in memory, there will be an ENVELOPE icon located on the upper left corner of the default screen. You can also read any unread messages in the MESSAGES section for later response.

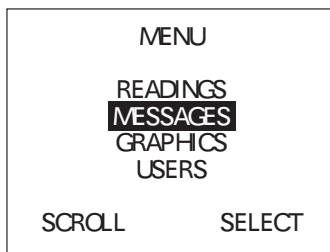

- Press Menu to view the feature list.
- SCROLL to highlight MESSAGES.
- Press SELECT to enter your selection.

Messages will be displayed in order of time received (oldest first). Responding to messages automatically stores them for later transmission and automatically scrolls to the next message if there is more than one unread message in

your ANDAN BP-Manager™.

There are 2 types of messages. The type of question will dictate the button labels. Simply press the desired button shown on the screen.

#### For Example

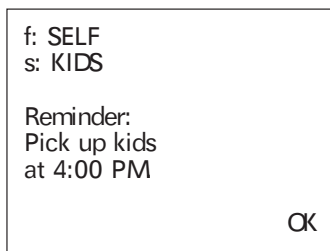

Free text messages allow for 2 possible responses, and are displayed on one screen and may look like this:

Multiple Choice messages allowing for up to 6 possible responses are displayed on 2 screens, and may look like this:

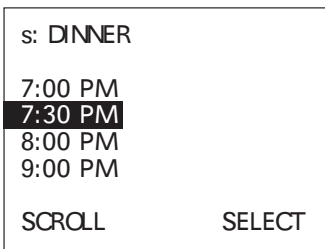
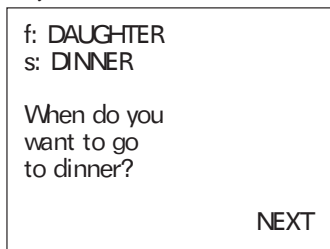

## Looking at Graphics

When using an ANDON Pod™, your ANDON BP-Manager™ will store different types of graphics downloaded from the ANDON website. (All the graphics can be altered through the ANDON website, refer to [www.ideallifeonline.com](http://www.ideallifeonline.com) for details).

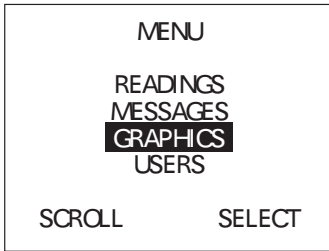

Press Menu to view the feature list.

- SCROLL to highlight GRAPHICS.

- Press SELECT to enter your selection.

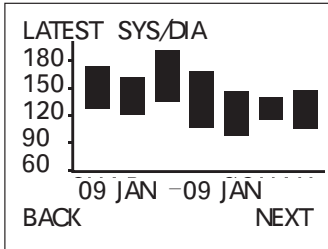

- You can now scroll through your graphics screen by screen using the button labeled NEXT. While scrolling through screens, you can always go to the previous screen by pressing the button labeled BACK.

If you have only one graphic in memory, or have reached your final screen you can press the button labeled EXIT to return to the MENU section (Remember you can always press the START/ESCAPE button to return to the default screen).

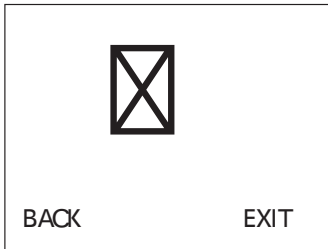

## Users

The USERS section allows you to set-up your ANDON BP-Manager™ with an option to allow 2 users to use the same device.v

### SELECT USER

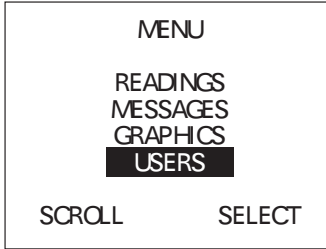

- Press Menu to view the feature list.
- SCROLL to highlight USERS
- Press SELECT to enter your selection.

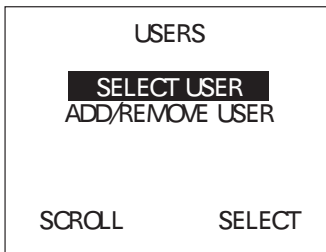

Using the Scroll and SELECT buttons, select the SELECT USER option. When more than one user is setup in the device, the SELECT USER function allows an individual to switch the current user selected in the device. When selecting SELECT USER, if only one user is selected in the device it will display the current user in the device. If there are multiple users in setup in the device, using the SCROLL and SELECT buttons a user can switch between USER 1 and USER 2

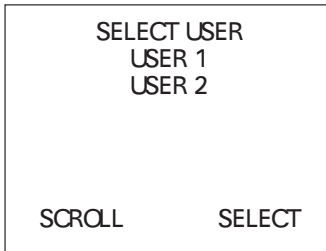

Selecting USER 1 will set the device to USER 1. Selecting USER 2 will set the device to USER 2.

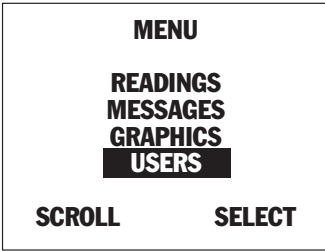
**ADD/REMOVE USER**

- Press Menu to view the feature list.
- SCROLL to highlight USERS
- Press SELECT to enter your selection.

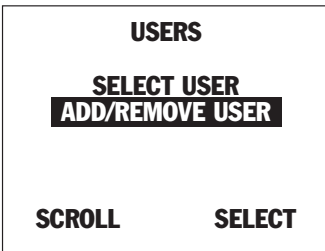

- Press SCROLL to highlight ADD/REMOVE USER.
- Press SELECT to enter your selection.

When there is only one user setup in the device, the ADD USER function will be initiated.

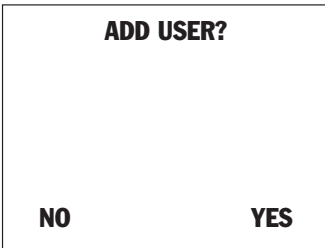

Press the YES button to add an additional user in the device. The next screen will walk the new user through the user setup process. Press the NO button to exit the ADD USER function and return the user to the main USERS options screen.

When there are two users setup in the device, the REMOVE USER function will be initiated.

## Functions

---

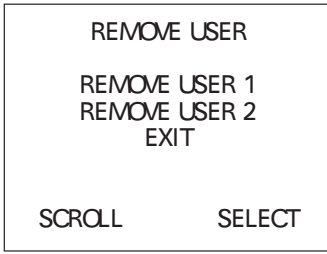

Using the SCROLL and SELECT buttons, a user can be removed from the device. Selecting EXIT will take the user to the USER options screen. When selecting a particular USER, as for example REMOVE USER 2 (as shown in the example below), that particular use will be displayed requiring a confirmation to remove from the device.

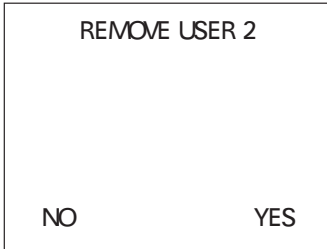

Pressing NO will return the user to the USER options screen. SELECTING YES will display an hour glass while the device removes the selected USER from the device. When complete, the device will return to the default screen.<sup>1</sup>



# Care and Maintenance

To maintain your ANDON BP-Manager™ in the best condition, and protect the unit from damage, you should follow the directions listed below.

- Clean the monitor with a soft dry cloth. You may also use an alcohol swab to wipe the cuff and meter clean. Do not use any abrasive or volatile cleaners. Never immerse the unit or any components in water.
- Store the ANDON BP-Manager™ in a safe and dry location. Do not fold the cuff and tubing tightly. Do not subject the monitor to extreme hot or cold temperatures, humidity and direct sunlight.
- Avoid subjecting the ANDON BP-Manager™ to strong shocks, such as dropping the unit on the floor.
- Remove the batteries if the unit will not be used for three months or longer. Always replace the batteries with new ones at the same time.
- Use the ANDON BP-Manager™ consistent with instructions provided in this manual. Use only authorized parts and accessories.

# Specifications

## ANDON BP-Manager™

Model:	BPM 0001 ANDON BP-Manager™
Display:	LCD Digital Display
Measurement Range:	Pressure: 30-280 mmHg, Pulse: 40-180 Pulses per minute
Accuracy / Calibration:	Pressure: +/- 3 mmHg, Pulse: +/- 5%
Inflation:	Automatic by electronic pump
Deflation:	Linear Valve
Rapid Air Release:	Linear Valve
Pressure Detections:	Pressure transducer
Measurement Method:	Oscillometric method
Pulse Wave Detections:	By peaks of waveform
Power Source:	4 "AA" alkaline batteries
Battery Life:	battery life is approx. 3 months depending on usage
Operating Temperature/Humidity:	50°F to 104°F (5°C to 40°C)/Below 90% relative humidity
Meter Storage Temperature/Humidity	-4°F to 140°F (-20°C to 55°C)/Below 95% relative humidity
Console Weight:	Approx. 290g without batteries
Outer Dimensions:	Approx. 110 mm Width x 130 mm Depth x 78 mm Height
Cuff Dimensions:	Cuff circumference: 22-30cm

Note: these specifications, to improve performance, are subject to change without notice.

(\*An optional accessory, sold separately)

Model:	ILP 0001 ANDON Pod™
Display:	3 LED's
Power Source:	AC adapter
Operating Temperature/Humidity:	50°F to 104°F (10°C to 40°C)/Below 85% relative humidity
Storage Temperature/Humidity	23°F to 122°F (-5°C to 50°C)/Below 90% relative humidity
Console Weight:	Approx. 142 g without batteries
Outer Dimensions:	Approx. 120 mm Width x 105 mm Depth x 30 mm Height

Note: These specifications are subject to change without notice.

# **FCC Statement**

## **Federal Communications Commission (FCC) Statement**

This device complies with Part 15 of the FCC Rules. Operation is subject to the following two conditions:

- 1) this device may not cause harmful interference, and
- 2) this device must accept any interference received, including interference that may cause undesired operation of the device.

You are cautioned that changes or modifications not expressly approved by the part responsible for compliance could void the user's authority to operate the equipment.

This equipment has been tested and found to comply with the limits for a Class B digital device, pursuant to part 15 of the FCC rules. These limits are designed to provide reasonable protection against harmful interference in a residential installation. This equipment generates, uses and can radiate radio frequency energy and, if not installed and used in accordance with the instructions, may cause harmful interference to radio communications. However, there is no guarantee that interference will not occur in a particular installation. If this equipment does cause harmful interference to radio or television reception, which can be determined by turning the equipment off and on, the user is encouraged to try to correct the interference by one or more of the following measures:

- Reorient or relocate the receiving antenna.
- Increase the separation between the equipment and receiver.
- Connect the equipment into an outlet on a circuit different from that to which the receiver is connected.
- Consult the dealer or an experienced radio/TV technician for help.

## **FCC RF Radiation Exposure Statement:**

This equipment complies with FCC radiation exposure limits set forth for an uncontrolled environment. End users must follow the specific operating instructions for satisfying RF exposure compliance. This transmitter must not be co-located or operating in conjunction with any other antenna or transmitter.

# **Service Requirements**

In the event of equipment malfunction, all repairs should be performed by our Company or an authorized agent. It is the responsibility of users requiring service to report the need for service to our Company or to one of our authorized agents. Please refer to the location you purchased or received your equipment for details of where service can be facilitated through.