

COMMSCOPE®

ION® -E Series



User's Manual
M0201A0B

POWERED BY

ANDREW.

DISCLAIMER:

This document has been developed by CommScope, and is intended for the use of its customers and customer support personnel. The information in this document is subject to change without notice. While every effort has been made to eliminate errors, CommScope disclaims liability for any difficulties arising from the interpretation of the information contained herein. The information contained herein does not claim to cover all details or variations in equipment, nor to provide for every possible incident to be met in connection with installation, operation, or maintenance. This document describes the performance of the product under the defined operational conditions and does not cover the performance under adverse or disturbed conditions. Should further information be desired, or should particular problems arise which are not covered sufficiently for the purchaser's purposes, contact CommScope. CommScope reserves the right to change all hardware and software characteristics without notice.

COPYRIGHT:

© Copyright 2015 CommScope Inc. All Rights Reserved.

This document is protected by copyright. No part of this document may be reproduced, stored in a retrieval system, or transmitted, in any form or by any means, electronic, mechanical photocopying, recording, or otherwise without the prior written permission of CommScope.

For patents see www.cs-pat.com.

TRADEMARKS

All trademarks identified by ® or ™ are registered trademarks or trademarks, respectively, of CommScope. Names of products mentioned herein are used for identification purposes only and may be trademarks and / or registered trademarks of their respective companies.

Andrew Wireless Systems GmbH, 19-June-2015

WARNING. This is **NOT** a **CONSUMER** device. It is designed for installation by **FCC LICENSEES** and **QUALIFIED INSTALLERS**. You **MUST** have an **FCC LICENSE** or express consent of an FCC Licensee to operate this device. Unauthorized use may result in significant forfeiture penalties, including penalties in excess of \$100,000 for each continuing violation.

WARNING. This is **NOT** a **CONSUMER** device. It is designed for installation by **FCC LICENSEES** and **QUALIFIED INSTALLERS**. You **MUST** have an **FCC LICENSE** or express consent of an FCC Licensee to operate this device. You **MUST** register Class B signal boosters (as defined in 47 CFR 90.219) online at www.fcc.gov/signal-boosters/registration. Unauthorized use may result in significant forfeiture penalties, including penalties in excess of \$100,000 for each continuing violation.

1. General

1.1. DCCS Technical Support

For technical assistance and support, please contact the DCCS technical support team.

Email: wisupport@commscope.com



+1 888-297-6433 in North and South America and +49 9099-69-333 in Europe, Middle East and Asia

1.2. Equipment Symbols Used / Compliance

Please observe the meanings of the following symbols used in this equipment:

Symbol	Compliance	Meaning
	CE	Alert sign to R&TTE To be sold exclusively to mobile operators or authorized installers – no harmonised frequency bands, operation requires license Intended use: EU and EFTA countries
CE 0700		Indicates conformity with the R&TTE directive 1999/5/EC certified by the notified body no. 0700.

1.3. Health and Safety

-  1. **Warning:** A High leakage current ground (earth) connection to the power supply subrack is essential before connecting the supply.
-  2. **Caution:** Laser radiation. Risk of eye injury in operation. Do not stare into the beam; do not view it directly or with optical instruments.
-  3. **Caution:** High frequency radiation in operation. Risk of health hazards associated with radiation from the antenna(s) connected to the unit. Implement prevention measures to avoid the possibility of close proximity to the antenna(s) while in operation.

1.4. Property Damage Warnings

- 1. **Attention:** Due to power dissipation, the power supply units may reach a very high temperature if not properly ventilated. Do not operate this equipment on or close to flammable materials.
- 2. **Notice:** ESD precautions must be observed. Before commencing maintenance work, use the available grounding (earthing) system to connect ESD protection measures.
- 3. **Notice:** Keep operating instructions within easy reach and make them available to all users.
- 4. **Notice:** Only license holders for the respective frequency range are allowed to operate this unit.
- 5. **Notice:** Read and obey all the warning labels attached to the unit. Make sure that all warning labels are kept in a legible condition. Replace any missing or damaged labels.
- 6. **Notice:** Make sure the unit's settings are correct for the intended use (refer to the manufacturer product information) and regulatory requirements are met. Do not carry out any modifications or fit any spare parts, which are not sold or recommended by the manufacturer.

1.5. Compliance

-  1. **Warning!** This is class A equipment. This equipment can cause radio interference in domestic areas. In this case the operator can be asked to start preventive action.
- 2. **Notice:** For installations, which have to comply with FCC RF exposure requirements, the antenna selection and installation must be completed in a way to ensure compliance with those FCC requirements. Depending on the RF frequency, rated output power, antenna gain, and the loss between the repeater and antenna, the minimum distance D to be maintained between the antenna location and human beings is calculated according to this formula:

$$D_{[cm]} = \sqrt{\frac{P_{[mW]}}{4 * \pi * PD_{[mW/cm^2]}}}$$

where

- P (mW) is the radiated power at the antenna, i.e. the max. rated repeater output power in addition to the antenna gain minus the loss between the repeater and the antenna.
- a. PD (mW/cm²) is the allowed Power Density limit acc. to 47 CFR 1.1310 (B) for general population / uncontrolled exposures which is
 - o F (MHz) / 1500 for frequencies from 300MHz to 1500MHz
 - o 1 for frequencies from 1500MHz to 100,000MHz

RF exposure compliance may need to be addressed at the time of licensing, as required by the responsible FCC Bureau(s), including antenna co-location requirements of 1.1307(b)(3).

- 3. **Notice:** For installations which have to comply with European EN50385 exposure compliance requirements, the following Power Density limits/guidelines (W/M²) according to ICNIRP are valid:
 - a. 2 for frequencies from 10 MHz to 400 MHz
 - b. F (MHz) / 2000 for frequencies from 400 MHz to 2 GHz
 - c. 10 for frequencies from 2 GHz to 300 GHz
- 4. **Notice:** Notice: For installations which have to comply with FCC/Industry Canada requirements:

English

This device complies with FCC Part 15. Operation is subject to the following two conditions: (1) this device may not cause interference, and (2) this device must accept any interference, including interference that may cause undesired operation of the device.

This device complies with Health Canada's Safety Code. The installer of this device should ensure that RF radiation is not emitted in excess of the Health Canada's requirement. Information can be obtained at http:

[/www.hc-sc.gc.ca/ewh-semt/pubs/radiation/radio_guide-lignes_direct-eng.php](http://www.hc-sc.gc.ca/ewh-semt/pubs/radiation/radio_guide-lignes_direct-eng.php).

Changes or modifications not expressly approved by the party responsible for compliance could void the user's authority to operate the equipment.

The antenna(s) used for this transmitter must be installed to provide a separation distance of at least 20 cm from all persons and must not be co-located or operating in conjunction with any other antenna or transmitter.

French

Cet appareil est conforme à FCC Partie15. Son utilisation est soumise à Les deux conditions suivantes: (1) cet appareil ne peut pas provoquer d'interférences et (2) cet appareil doit accepter Toute interférence, y compris les interférences qui peuvent causer un mauvais fonctionnement du dispositif.

Cet appareil est conforme avec Santé Canada Code de sécurité 6. Le programme d'installation de cet appareil doit s'assurer que les rayonnements RF n'est pas émis au-delà de l'exigence de Santé Canada. Les informations peuvent être obtenues:

http://www.hc-sc.gc.ca/ewh-semt/pubs/radiation/radio_guide-lignes_direct-fra.php

Les changements ou modifications non expressément approuvés par la partie responsable de la conformité pourraient annuler l'autorité de l'utilisateur à utiliser cet équipement.

La ou les antennes utilisées avec cet émetteur doivent être installées avec une séparation d'au minimum 20cm avec toute personne et ne doivent pas être co-localisées ou utilisées avec toute autre antenne ou tout autre émetteur.

- 5. **Notice:** Corresponding local particularities and regulations must be observed. For national deviations, please refer to the respective documents included in the manual CD that is delivered with the unit.

6. **Note:** For a Class A digital device or peripheral:
 This equipment has been tested and found to comply with the limits for a Class A digital device, pursuant to EN55022 and part 15 of the FCC Rules. These limits are designed to provide reasonable protection against harmful interference when the equipment is operated in a commercial environment.

This equipment generates, uses, and can radiate radio frequency energy and, if not installed and used in accordance with the instruction manual, may cause harmful interference to radio communications. Operation of this equipment in a residential area is likely to cause harmful interference in which case the user will be required to correct the interference at his own expense.

7. **Note:** This unit complies with European standard EN60950.





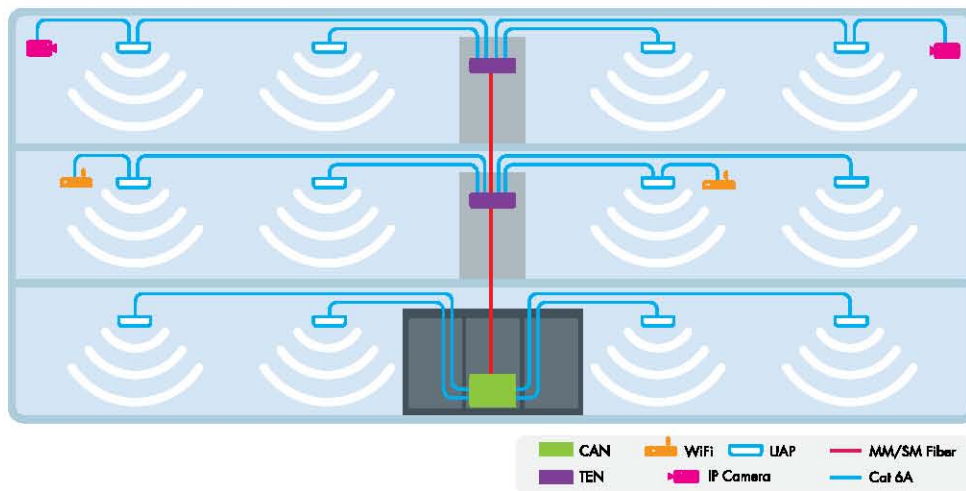

2. ION-E System Overview











The ION-E is a unified wireless infrastructure platform defined around IT based architecture. It brings together licensed wireless and power, plus Gigabit Ethernet for Wi-Fi into one wireless network that can scale to building size and is technology and spectrum agnostic and adaptive.

- **Central Area Node (CAN):** Server-level control and primary signal distribution. 2U and 4U subrack options are available.
- **Transport Expansion Node (TEN):** The secondary distribution point connected to a CAN using multimode or single mode fiber.
- **Universal Access Point (UAP):** data and power through Category 6A twisted pair cabling. Supports gigabit Ethernet for WiFi, IP cameras, or other devices in addition to wireless over a common cable.



2.1. ION-E Components Overview

<p>WCS-4</p>	<p>The WCS-4 is a 4U subrack. It is typically used as a CAN but can also serve as a TEN.</p>	
<p>WCS-2</p>	<p>The WCS-2 is a 2U subrack. It is typically used as a TEN, but can also serve as a CAN.</p>	
<p>SUI</p>	<p>The System User Interface card provides local and LAN Ethernet connections and a USB port.</p>	
<p>RFD</p>	<p>The RF Donor card is the interface for RF signals between the CAN and the BTS or eNode-B. Each of its four ports (QMA F) simultaneously transmits and receives signals.</p>	
<p>OPT</p>	<p>The Optical Transport card provides a 10 Gb fiber connection between a CAN and a TEN. Each card supports up to four SFP+ modules.</p>	
<p>CAT</p>	<p>The Copper Transport card provides 10 Gb Cat6A connections between the CAN or TEN and the UAP. The cards also supply the PoE to the UAPs.</p>	

<p>AUT</p>	<p>The Auxiliary Unit Transport card provides a 1 Gb pass-through connection between the CAN or TEN and the UAP for Wi-Fi, IP cameras, or other 1 Gb Ethernet devices.</p>	
<p>BIT</p>	<p>The Baseband Interface Transceiver card provides the fiber interface to BBU ports. Up to six BBU port connections per card are supported.</p>	
<p>Power Supply Subrack</p>	<p>The Power Supply subrack houses two 12 Vdc and two 57 Vdc modules to supply power to the WCS subracks, UAPs, and connected devices.</p>	
<p>12 VDC</p>	<p>The 12 Vdc modules plug into the power supply subrack to provide 12 Vdc power to the WCS and e-POI subracks.</p>	
<p>57 VDC</p>	<p>The 57 Vdc modules plug into the power supply subrack to provide 57 Vdc power for the UAP and other PoE devices connected to a WCS subrack.</p>	
<p>UAP</p>	<p>The Universal Access Point, which is connected to the system via Cat6A cabling, supports 380 to 2700 MHz. It also supports 1G pass-through or an additional UAP through a second RJ45 jack.</p>	
<p>FAN</p>	<p>The Fan tray and Filter modules cool the WCS and all of its cards. One fan tray is used for a WCS-2. Two trays are used for a WCS-4.</p>	
<p>e-POI Subrack</p>	<p>The e-POI subrack supports up to 8 e-POI modules and an IFC module.</p>	
<p>e-POI</p>	<p>The e-POI (Point of Interface) card is a low PIM attenuator. It reduces high power RF signals from their source by 30 dB to interface to the RFD cards.</p>	
<p>IFC</p>	<p>The IFC (Interface Card) is used to set the subrack number of the e-POI subrack. It also provides a status LED for each of the e-POI modules in the subrack.</p>	

2.2. UAP Ceiling Mounting

The UAP is equipped with a grounding screw located in the center of the unit, however, grounding is not required as UAPs are classified as low-voltage devices and do not have internal power supplies. CommScope recommends checking your local and national electrical codes to determine if grounding is a requirement.

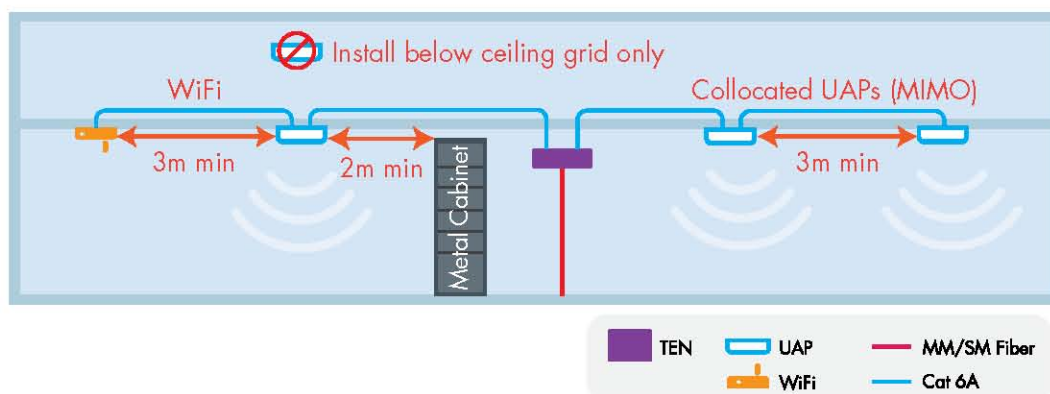

3. ION-E Hardware

3.1. WCS-2 and WCS-4 Subracks

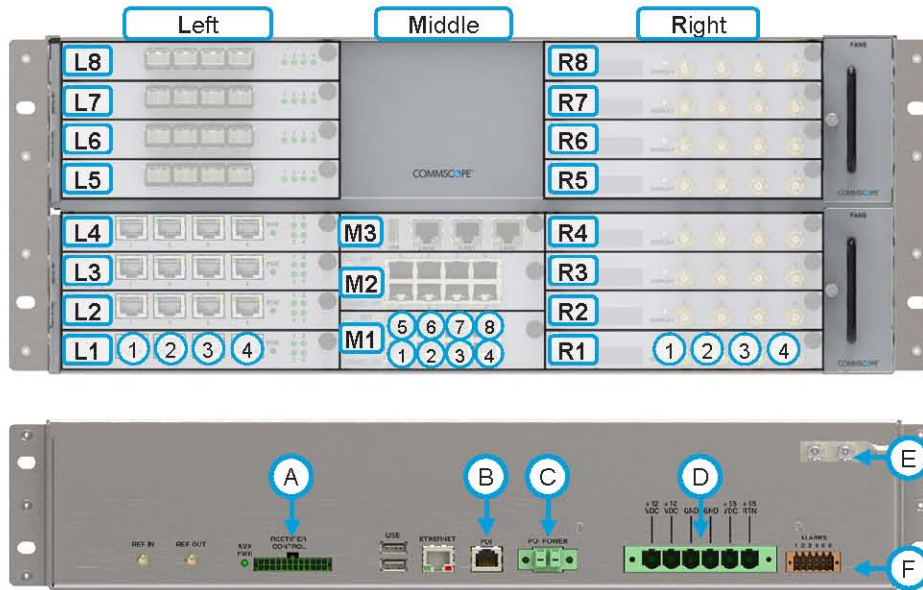

WCS subrack rear connectors			
A	RECTIFIER CONTROL: PSU communication	D	POWER 12 Vdc and 57 Vdc Inputs
B	POI: POI Communication	E	Grounding Bolts
C	POI POWER 12 Vdc to e-POI subrack	F	ALARMS: Dry contact input and output

Alarms Connector

- Four opto-isolated (chassis ground referenced) dry contact inputs to monitor external devices
- One summary alarm relay that energizes when specific alarms are triggered

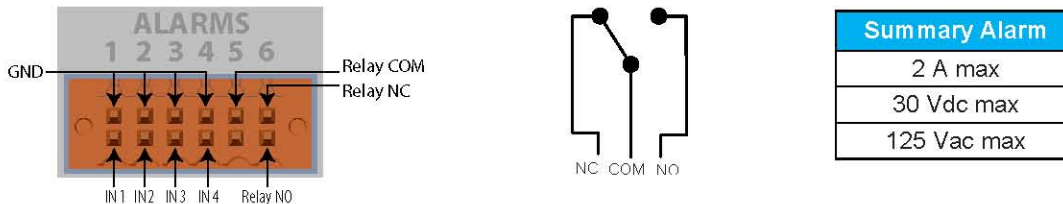

WCS Fan Modules and Filters

- Fan modules may be replaced without system interruption.
- The fan modules must be installed for WCS operation!
- Blank panels are required for all empty card slots to maximize airflow.



3.2. System User Interface Card (SUI) – for external communications



Ports	Port LEDs	
Local: Local laptop - fixed IP address	Off	No link
LAN1: To collocated WCS subracks	Green	Link established - Activity (flashing) (Left LED)
LAN2: LAN or modem - DHCP or specified fixed IP address	Off	10 Mb connection established (Right LED)
USB: USB 2.0 for transferring files	Yellow	100 Mb connection established (Right LED)

3.3. RF Donor Card (RFD) – RF Signals to/from eNodeB / BTS



Ports 1-4	LCD Display
<p>Connector type: QMA female</p> <p>RF Paths: Simultaneous transmit and receive</p> <p>Protection: Relays with adjustable trip threshold</p> <p>Frequency: 380 – 2700 MHz</p>	<ul style="list-style-type: none"> • Push the <i>Display</i> button to turn on the display's backlight. • Push the button repeatedly to cycle through the four ports. • The first line of the display shows the port number and band. • The second line of the display shows the service provider or "multiple" if multiple providers are connected to the port.

3.4. Optical Transport Card (OPT) – Fiber Connection between CAN and TEN



Ports 1-4	Port LEDs	
Slots: Accept SFP+ plug-in modules	Off	No power or card is plugged into wrong slot in a TEN.
Type: 10 Gbps single mode or multimode	Green	Optical link is established.
Purpose: High speed fiber connections between CAN and TEN. OPT may be installed in slots L1-L8 in a CAN but the OPT must be installed in slot R1 in a TEN.	Yellow	Card is powered and initialized but link is not established. When installed in a TEN, only port 1 LED is functional.

3.5. Copper Transport Card (CAT) – Signals and PoE to UAPs



Ports 1 - 4: RJ45 CAT6A		Port LEDs 1 - 4		PoE LED	
Off	No Link	Off	Card is unplugged	Off	No PoE supplied to UAPs
Green	10G link	Red	Fault	Green	PoE supplied to one or more UAPs
Yellow	1G link				

3.6. Auxiliary Unit Transport Card (AUT) – 1G pass through

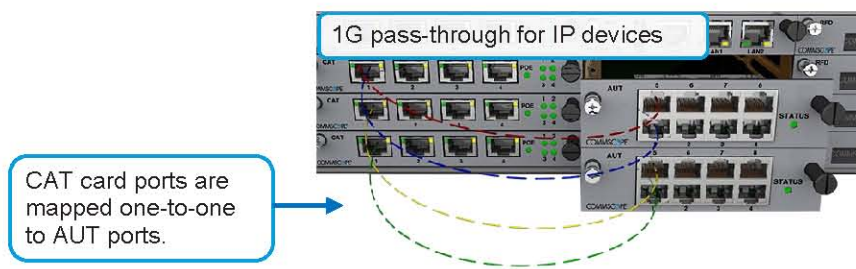

3.7. Baseband Interface Transceiver Card (BIT) – Fiber to the BBU



Ports 1-6	Port LEDs	
Slots: Accept SFP+ plug-in modules	Off	No power
Type: Single mode or multimode	Green	Optical link is established
Purpose: Fiber connections to BBU using CPRI protocols	Yellow	Card is powered but link is not established

3.8. Power Supply Subrack



Power supply subrack rear connectors and terminals			
A	(+) 57 Vdc Output – Positive (Red Wire)	D	Rectifier control connector (24 pin) to WCS
B	(-) 57 Vdc Output – RTN Negative (Black Wire)	E	(+) 12 Vdc Output – Positive (Red Wire)
C	AC Input (IEC 60320 C19)	F	(-)12 Vdc Output – RTN Negative (Black Wire)

3.9. Universal Access Point (UAP)

The UAP is intended for indoor use only.

MAIN Port (RJ45)

Provides data and PoE to UAP over CAT6A

AUX Port (RJ45)

Provides data and PoE to 2nd UAP or 1G devices

Power Switch

Prior to disconnecting the Cat6A cables, the red button must be pressed to shut down the unit.

It may also be shut down via software.

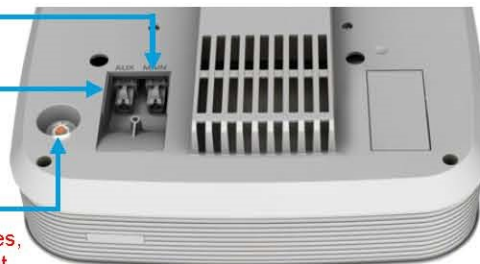

LED Color	Status
Blue	Transmitting – no alarms
Blue	Unit Identifier (flashing)
Yellow	Alarm

Specifications				
Nominal passband gain: Le gain nominal en bande passante	20 dB	MHz	MHz	Nominal bandwidth (MHz) La largeur de bande nominale
Rated mean output power La puissance moyenne de sortie	+18 dBm	450	470	20
Input / Output Impedance Les impédances d'entrée et de sortie, et	50 Ohms	728	746	18
		746	756	10
		768	776	8
		851	869	18
		869	894	25
		1930	1995	65
		2110	2155	45
		2620	2690	70

The Manufacturer's rated output power of this equipment is for single carrier operation. For situations when multiple carrier signals are present, the rating would have to be reduced by 3.5 dB, especially where the output signal is re-radiated and can cause interference to adjacent band users. This power reduction is to be by means of input power or gain reduction and not by an attenuator at the output of the device.

La puissance de sortie nominale indiquée par le fabricant pour cet appareil concerne son fonctionnement avec porteuse unique. Pour des appareils avec porteuses multiples, on doit réduire la valeur nominale de 3,5 dB, surtout si le signal de sortie est retransmis et qu'il peut causer du brouillage aux utilisateurs de bandes adjacentes. Une telle réduction doit porter sur la puissance d'entrée ou sur le gain, et ne doit pas se faire au moyen d'un atténuateur raccordé à la sortie du dispositif.

4. Installation

4.1. Mechanical Installation of WCS and e-POI

Rack Mounting of ION-E Subracks

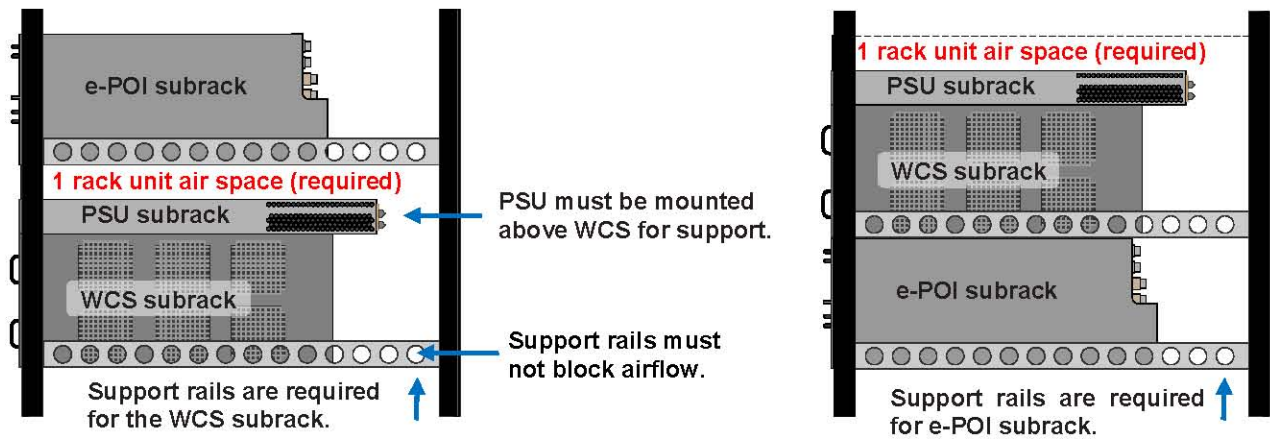

Warning: Disconnect all input power to the Power Supply subrack before removing it from the rack.

TEN Card Placement

- OPT in bottom right side slot (R1)
 - Use port R1.1 for the connection (to CAN)
- CAT in left side bottom four slots (L1-L4)
- RFD in all other right side slots (R2-R4) if required
- SUI in slot M3
- AUT in slots M1 and M2

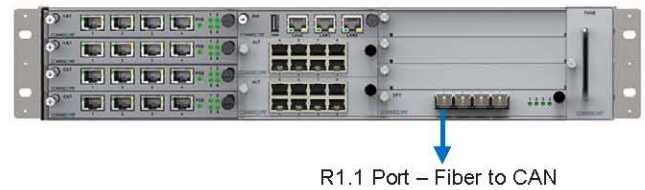

Install SFP+ Modules in OPT and BIT Cards



4.2. Back of Rack – Power and Communication Cabling

Connect rear panel power, communications, and control cables as shown below:

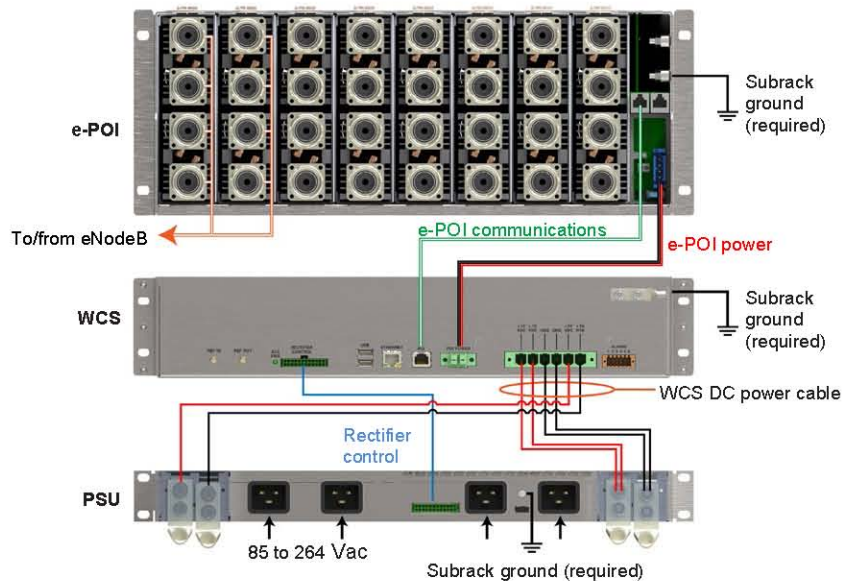

5. ION-E Software

5.1. Login Page

1. Default username "ion-e"
2. Default password: "EZ4Users" The password is case-sensitive.
3. Default Local IP Address: <http://172.16.0.1>



5.2. Software Update

The software update will automatically update the firmware of every component in the system that requires an update. It will not update components with current firmware.

1. Under the *System Configuration* tab | *System Settings* tab, click the *Software Update* link located in the System Settings column.

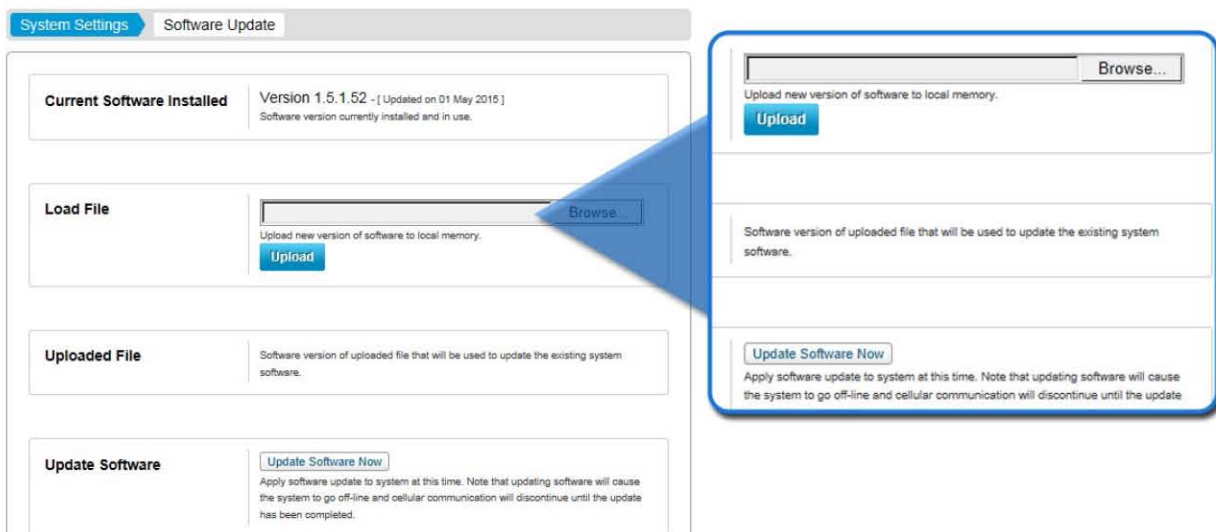

2. Use the *Browse* and *Upload* buttons to upload a software update file.
3. Click the *Update Software Now* button to start the update immediately. This will take the system offline and discontinue cellular communication while the update is in progress. Click the *Revert Software Now* button to revert back to the previous version.
4. Click the *Create Update Schedule* to set a time for the update when there is less cellular traffic.

5.3. Important Setup Tasks

Set region of operation

The ION-E measurement receiver will operate more efficiently once the region of operation is specified because this limits the initial frequency scans to those bands supported in the particular region.

1. Under the *System Configuration* tab | *System Settings* tab, click the *Global Region* link located on the left side of the page to open the *Global Settings* tab.
2. Select the *Region* and *Country* from the associated drop-down lists.

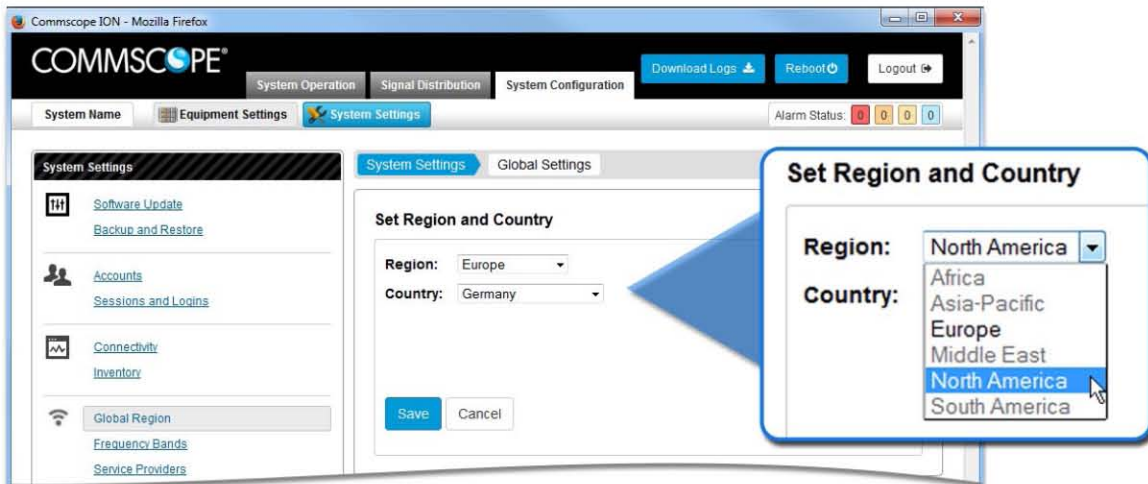

3. Click the Save button.

Set Time and Date

The time and date should be entered to ensure that alarms and log files have accurate time stamps based on the local time.

1. Under the *System Configuration* tab | *System Settings* tab, click the *Time and Date* link located in the System Settings box.

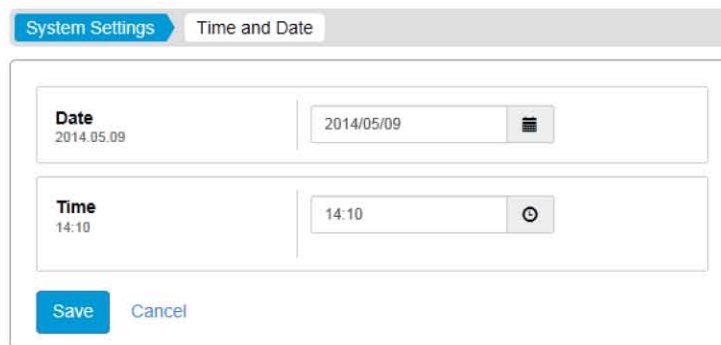

2. Enter the Time and Date in the appropriate fields or by clicking on the time and date buttons.
3. Click the Save button.

Enter or Change System, CAN, TEN, and UAP names

Entering meaningful names helps you identify and locate systems and components. To enter or change the name (location) for the System or a CAN, TEN, or UAP:

1. Click in the *System Name* field at the top left of any page, type the name, and click the Save button.



2. Click in the *Name (location)* field adjacent to a CAN, TEN, or UAP, type the name, and click the Save button.

5.4. Channel Detection

Detect Channels – Manual Scan

ION-E requires detection of all signals that will be distributed. This ensures that the user will always know what signals are being distributed by the system. The measurement receiver automatically scans and detects available channels. However, to optimize system efficiency, running user-defined manual scans for each connected RF port is strongly recommended. Specifying the band for a port will reduce the required scan time. To run a manual channel scan:

1. Under the System Configuration tab | Equipment Settings tab, click a CAN link located in the Device Configuration box.
2. Click on the *Subrack, Cards and PSU* link to view the WCS subrack of the CAN.
3. Click on an RFD card to select it, which opens its *General Properties* page.

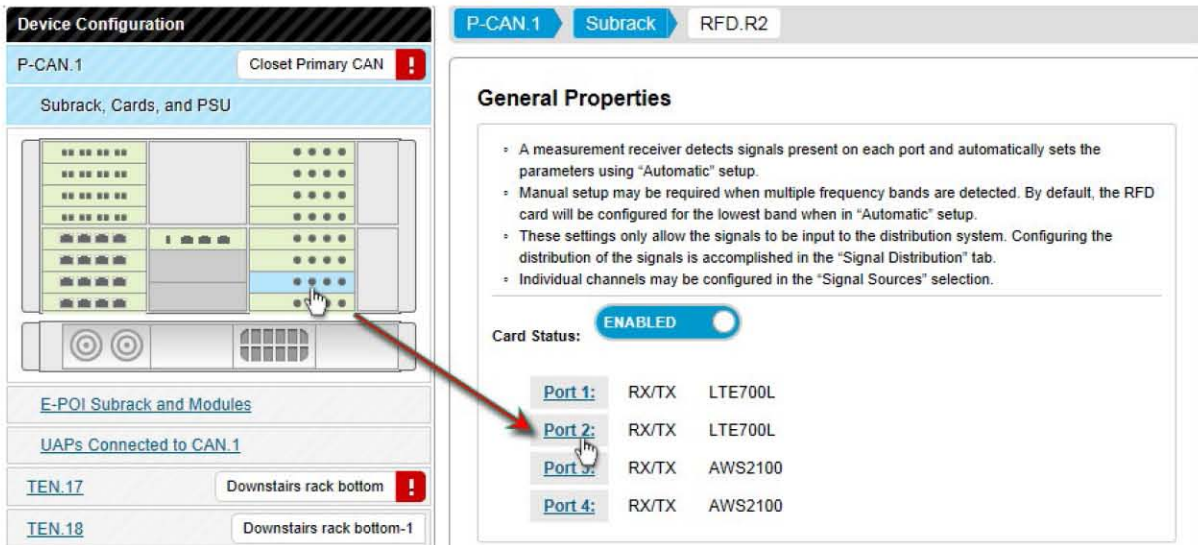

4. Click on an available *Port* link to open its *Edit General Properties* page.
5. Click to select the *Manual Port* Detection radio button.

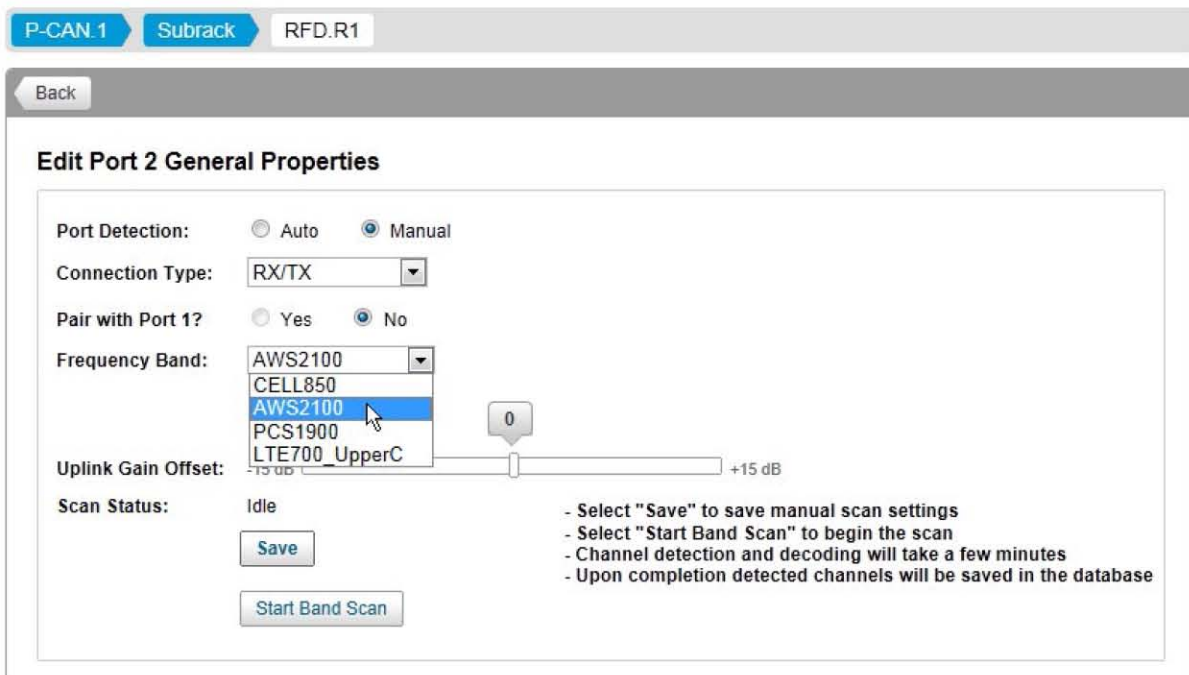

6. Select a band from the *Frequency Band* drop-down list.
7. Click the *Save* button to save the scan settings.
8. Click the *Start Band Scan* button to start the scan. If a scan is already in progress, a popup window will appear. Click the *Add to Queue* button in that window to place the scan task into the queue.

Measurement Receiver

The scan tasks results are available on the measurement receiver pages, which provide the detailed information about the detected channels.

To view ION-E measurement receiver status, scan results, and scan history:

1. Under the *System Operation* tab click the *Scan Status* link located in the *System Operation and Performance* box to view the Current Status of the measurement receiver. The *Scan History* is also accessible from this page.

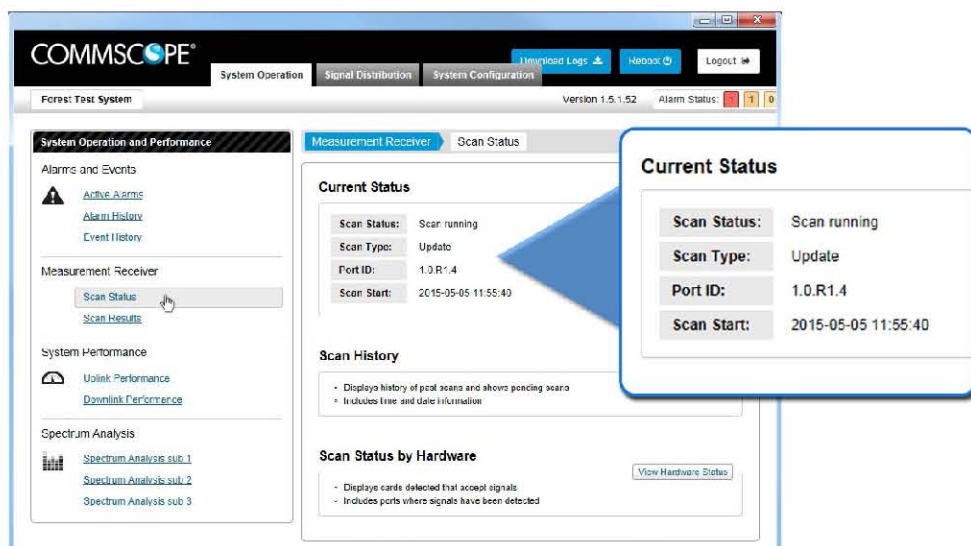

- Under the System Operations tab, click the *Scan Results* link located in the *System Operation and Performance* box to view the Current Status of the measurement receiver.

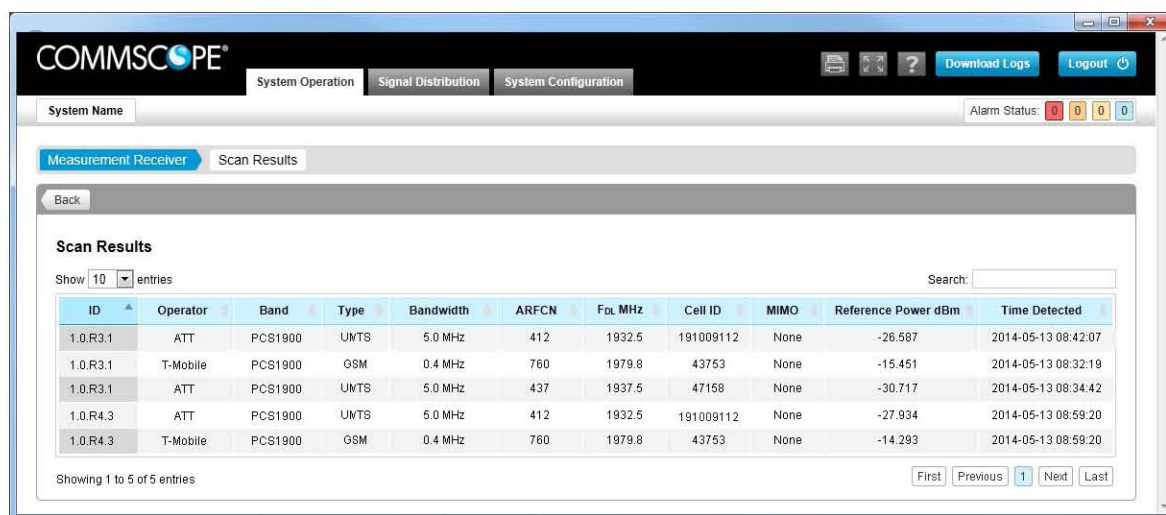

5.5. Signal Distribution

The ION-E uses signal sets to group the detected signals to simplify signal routing to the radiating elements throughout the system. First the user must create and define the signal sets by assigning channels to the sets. The signal sets are then assigned as needed using drag and drop functionality to route the signals to the TENs and UAPs.

Create and Edit Signal Sets

- Click on the *Signal Distribution* tab to open the page.
- Select a set from the *Signal Sets* list and click the *Edit* button to edit an existing set.
- Click on the *Add a New Signal Set* link to open the *Add Signal Set* page to create a new set.

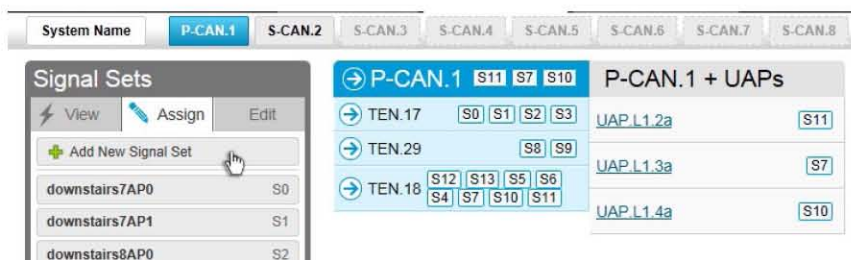

- Enter a Name for the signal set in the *Signal Set Name* field.
- Click to select a channel from the *Available Channels* list or shift click to select multiple channels and drag them onto the *Assigned Channels* list.

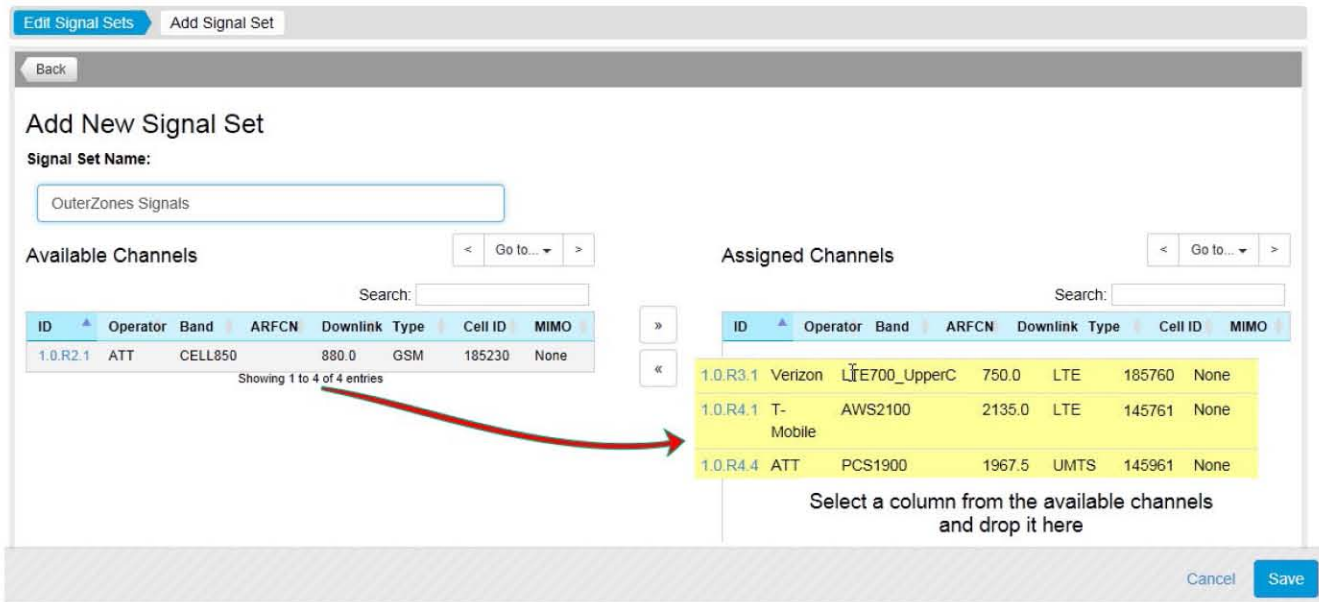

6. Click the Save button to save the Signal Set.

Assign Signal Sets (Direct signal traffic to TENs and UAPs)

Signal Sets, which are a user-defined set of channels, can be quickly assigned to CANs and all UAPs assigned to them, TENs and all UAPs assigned to them, or to individual UAPs on the *Signal Distribution* page.

1. Click on the *Signal Distribution* tab to open the page.
2. Assign a signal set by:
 - o Clicking on a signal set and dragging it onto a TEN or UAP (icons adjacent to the device name indicate the sets assigned to a TEN or UAP)
 - o Clicking on a signal set to select it (green highlight) and then clicking on each TEN or UAP to which you wish to assign the signal set.

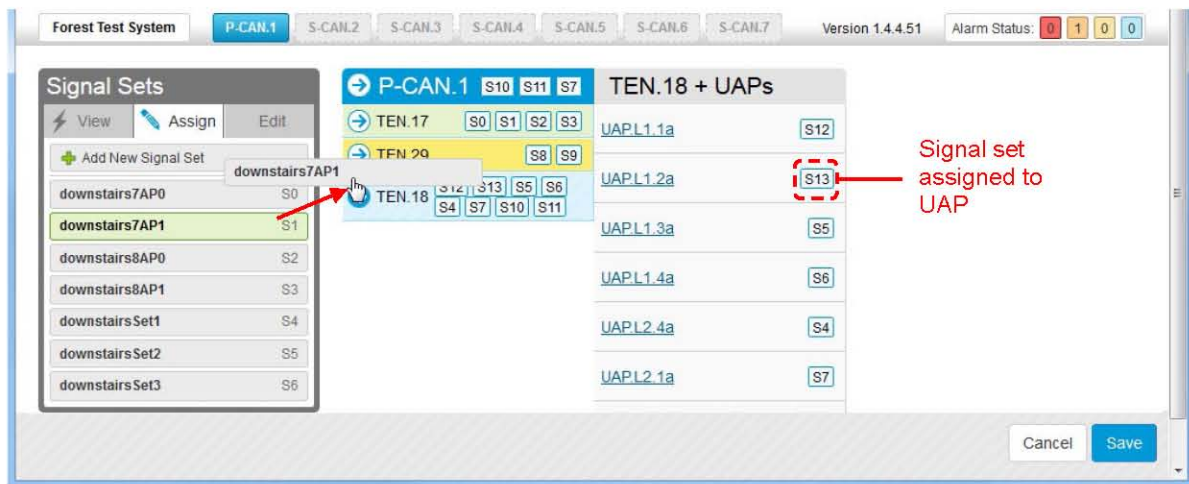

3. Click the Save button after you've assigned each signal set

5.6. Disable Modules and Ports

ION-E modules and/or ports can be quickly enabled or disabled. **You should always disable a CAT card or its ports before disconnecting a CAT6A cable supplying power to a UAP to prevent damage to the connector.** You may also wish to disable a card in the system that is not being used to reduce power consumption and heat dissipation. To disable a module or one of its ports:

1. Under the *System Configuration* tab | *Equipment Settings* tab, click a CAN link or TEN link located in the Device Configuration box.
2. Click on the *Subrack, Cards and PSU* link to view the WCS subrack of the CAN or TEN.
3. Click on a card to select it and open its *General Properties* page.

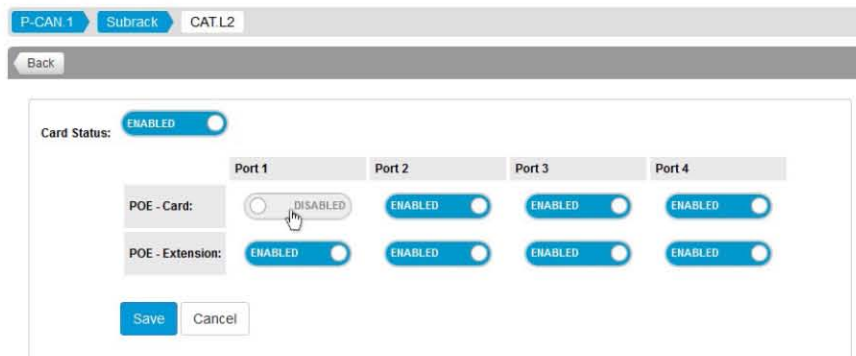

4. Click on the *Enabled /Disabled* button to toggle state of the module or its ports.

5.7. Flash UAP LED

To place the UAP LED into blue flashing mode to verify the identity and location of a UAP:

1. Under the *System Configuration* tab | *Equipment Settings* tab, click a *CAN* link under Device Configuration.
2. Click on the *UAPs Connected to CAN* link or click on a *TEN* link and then click on the *UAPs Connected to TEN* link.
3. Click on a *UAP* link to open its properties page.
4. Select an *Auto stop* time from the drop-down list and click the *Flash LED* button.

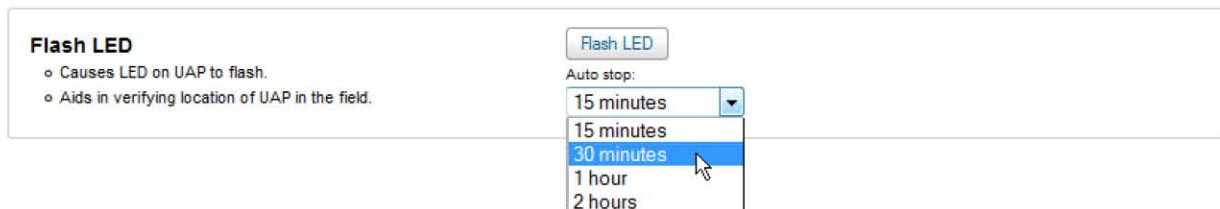

5.8. Change WCS Subrack Function

WCS 4U and WCS 2U subracks are both capable of functioning as CANs or TENS. By default the WCS 4U is designated as a CAN and the WCS 2U is designated as a TEN. To change the function of a WCS subrack:

1. Under the *System Configuration* tab | *Equipment Settings* tab, click a *CAN* link located in the Device Configuration box.
2. Click on the *Subrack, Cards and PSU* link to view the WCS subrack of the CAN. Or click on a *TEN* link and then click on the *Subrack, Cards and PSU* link for that TEN to view the WCS subrack of the TEN.

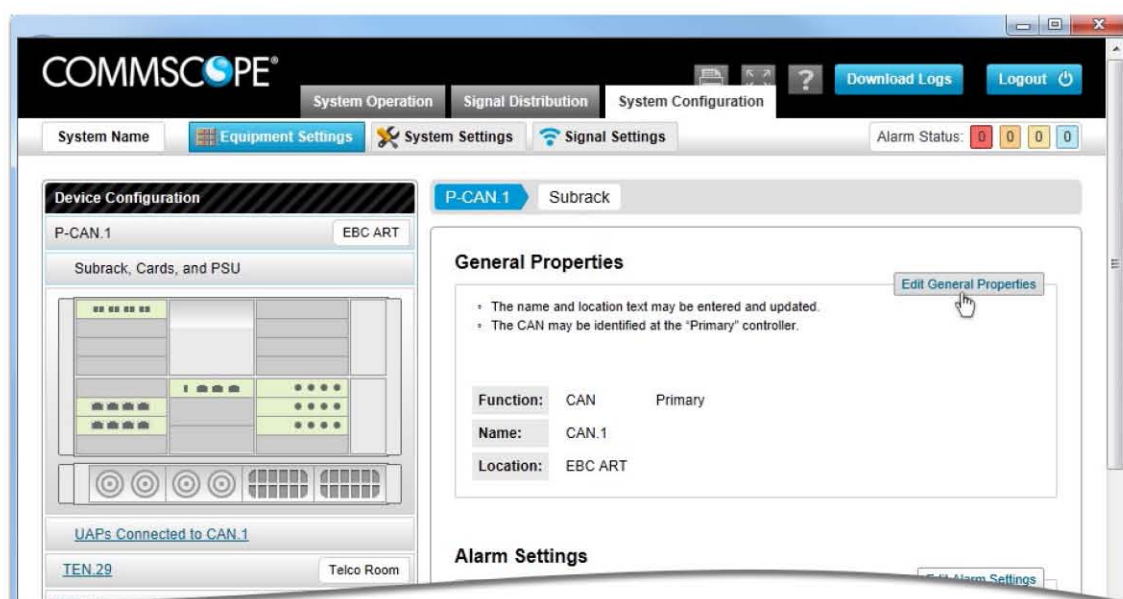

3. Click the *Edit General Properties* button to open the *General Properties* page.

P-CAN.1 Subrack Edit General Properties

Back

Edit General Properties

Function: CAN TEN

Name: CAN.1

Location: Closet Primary CAN 25 characters max

Control: Primary CAN Controller
 Secondary CAN Controller

Control Information

The primary controller will be the only interface point for external communication and control. One, and only one, CAN must be named as the primary controller and remote connections must be made to the User Interface module installed within the defined primary controller.

Save Cancel

4. Click in the *CAN* or *TEN* checkbox to assign the function of the subrack. If *CAN* is checked, click in the *Primary* or *Secondary* checkbox and select a *CAN Name* from the drop-down list.
5. Enter a location name for the subrack in the *Location* field.
6. Click the *Save* button to save the subrack function assignment. A popup window will appear to notify the user that the system will reboot.