

---

# ION® -E Series Low Power Carrier Access Point

Installation Guide • M0201AAC • February 2018

---



## **DISCLAIMER**

This document has been developed by CommScope, and is intended for the use of its customers and customer support personnel. The information in this document is subject to change without notice. While every effort has been made to eliminate errors, CommScope disclaims liability for any difficulties arising from the interpretation of the information contained herein. The information contained herein does not claim to cover all details or variations in equipment, nor to provide for every possible incident to be met in connection with installation, operation, or maintenance. This document describes the performance of the product under the defined operational conditions and does not cover the performance under adverse or disturbed conditions. Should further information be desired, or should particular problems arise which are not covered sufficiently for the purchaser's purposes, contact CommScope.

CommScope reserves the right to change all hardware and software characteristics without notice.

## **COPYRIGHT**

© 2018 CommScope, Inc. All Rights Reserved.

This document is protected by copyright. No part of this document may be reproduced, stored in a retrieval system, or transmitted, in any form or by any means, electronic, mechanical photocopying, recording, or otherwise without the prior written permission of CommScope.

For patents see [www.cs-pat.com](http://www.cs-pat.com).

## **TRADEMARKS**

All trademarks identified by ® or ™ are registered trademarks or trademarks, respectively, of CommScope, Inc. Names of other products mentioned herein are used for identification purposes only and may be trademarks and/or registered trademarks of their respective companies.

Andrew Wireless Systems GmbH, **19-December-2017**

# TABLE OF CONTENTS

<b>Document Overview</b> .....	<b>1</b>
Document Revision History .....	1
Document Cautions and Notes .....	2
Abbreviations Used in this Guide .....	2
CommScope Part Numbers .....	2
<b>ION-E Series System Overview</b> .....	<b>3</b>
<b>CAP L Overview</b> .....	<b>4</b>
CAP L Connectors, Ports, and LEDs .....	5
CAP L with an Optical Fiber Interface .....	6
CAP L with a Copper Interface and External DC Power .....	7
CAP L with a Copper Interface and Power Cat6A Cable .....	8
Fan Interface Port .....	9
CAP L Accessory Options .....	9
Fan Kit .....	10
Flat Mounting Bracket Kit .....	10
CAP L Mounting Bracket Kit .....	10
CAP L Hybrid Fiber Splice Box Kit .....	11
AC/DC Power Supply Kit .....	11
OCTIS Kits .....	11
<b>Safely Working with ION-E Hardware</b> .....	<b>12</b>
Health and Safety Precautions .....	12
Property Damage Warnings .....	12
General Installation Safety Requirements .....	12
Guard Against Damage from Electro-Static Discharge .....	13
Compliance .....	13
Equipment Symbols Used / Compliance .....	15
<b>Installing CAP Ls</b> .....	<b>16</b>
Prepare for Installation .....	16
Required Distances Between CAP Ls and Antennas .....	16
CAP L Installation Rules .....	16
Cascade Rules .....	17
Recommended Tools and Material .....	18
Determine the Power Consumption of the CAP L .....	18
Determine the CAP L Mounting Site .....	19
General Mounting Cautions .....	21
Unpack and Inspect the CAP L and Optional Accessories .....	22
Mount the CAP L .....	22
Flat-Surface Mount a CAP L .....	23
Wall Mount a CAP L .....	24
Mounting Orientation for Wall Mounts .....	24
Wall Mount a CAP L Using a Flat Mounting Bracket Kit .....	26
Wall Mount a CAP L Using a CAP L Hybrid Fiber Splice Box Kit .....	28
Wall Mount a CAP L Using a AC/DC Power Supply Kit .....	32
Ceiling Mount a CAP L .....	35
Ceiling Mount a CAP L without a Fan Kit .....	35
Ceiling Mount a CAP L with a Fan Kit .....	35
(Optional) Ground the CAP L .....	36
Connect the CAP L Cables .....	37
Cable a CAP L with an Optical Fiber Interface .....	37
Cable a CAP L with a Copper Interface .....	40
Cat6A Cable Requirements for CAP Ls with a Copper Interface .....	40
Cable a CAP L with a Copper Interface and External DC Power .....	43
Cable a CAP L with a Copper Interface and Power over Cat6A Cable .....	45
Powering a CAP L .....	48
Power LED Behavior .....	48
Using the Power-Down Button .....	48
<b>CAP L Maintenance</b> .....	<b>49</b>
Remove a CAP L from a Wall or Ceiling Mount .....	49
Preventative CAP L Maintenance for CAP Ls with the Fan Kit Option .....	49
<b>Cat6A Specifications and Testing Requirements</b> .....	<b>50</b>

<b>Contacting CommScope .....</b>	<b>51</b>
DCCS Global Technical Support .....	51
Telephone Helplines.....	51
Online Support .....	51
Waste Electrical and Electronic Equipment Recycling.....	51
Hardware to Software Mapping Information.....	52
DCCS Technical Training .....	52
Accessing ION-E Series User Documentation .....	53

# DOCUMENT OVERVIEW

This installation guide provides a product overview and installation instructions for the ION-E Series Low Power Carrier Access Point (CAP L), which allows transmission between ION-E equipment, antennas, and Ethernet devices (such as WiFi and IP cameras).

Table 1 lists the CAP L models that this installation guide supports.

**Table 1.** Supported CAP L Models

Part Number <sup>1</sup>	Model Name
7770203-000x	CAP L 17E/17E/23/23
7770209-000x	CAP L 18/21/26/26
7770356-000x	CAP L 17E/17E/19/19
7776596-000x	CAP L 7/80-85/17E/19
7776597-000x	CAP L 17E/19/23/25TDD
1 The "-000x" suffix provides information as to whether the CAP L has a Fiber or Copper interface, and the power and Fan Kit options. Contact your local sales representative for further information.	



For further information on ION-E system components, refer to the *ION-E Series WCS-2, WCS-4, and e-POI Subracks and Power Supply Unit Installation Guide* and the *ION-E Series Universal Access Point Installation Guide* (see "[Accessing ION-E Series User Documentation](#)" on page 53.)



For information on how to find the minimum software requirements for ION-E hardware, refer to "[Hardware to Software Mapping Information](#)" on page 52.

## Document Revision History

This is the third release of the *ION<sup>®</sup>-E Series Low Power Carrier Access Point Installation Guide*, CommScope Document Number M0201AAC, dated January 2018, which

- adds
  - support for the CAP L 17E/19/23/25TDD
  - "[Required Distances Between CAP Ls and Antennas](#)" on page 16
- updates
  - the required clearance between a CAP L and an antenna in "[General Installation Safety Requirements](#)" on page 12
  - "[Antenna Stmt for ISED:](#)" and "[Antenne Stmt pour ISDE:](#)" on page 14.

## Document Cautions and Notes

This document contains notes, cautions, and warnings. In general, cautions, warnings, and notes indicate the following:



The icon to the left is used to indicate a caution or warning. Cautions and warnings indicate operations or steps that could cause personal injury, induce a safety problem in a managed device, destroy or corrupt information, or interrupt or stop services.



The icon to the left indicates a caution or warning that pertains to laser equipment.



The icon to the left is indicates a caution or warning that pertains to Radio Frequency (RF).



The icon to the left indicates that the hardware is susceptible to Electro-Static Discharge (ESD) damage.



The icon to the left is indicates a Note. Notes provide information about special circumstances.

## Abbreviations Used in this Guide

AUX	Auxiliary	ISDE	Innovation, Sciences et Développement économique Canada
C	Celsius	ISED	Innovation, Science and Economic Development Canada
CAN	Central Area Node	kg	Kilogram
CAP L	Carrier Access Point, Low Power	LED	Light Emitting Diode
Cat	Category	MHz	Megahertz
CAT	Copper Transport	mm	Millimeter
dB	Decibel	MMF	Multi-Mode Fiber
dBm	Decibel-milliwatts	OPT	Optical Transport
DC	Direct Current	PN	Part Number
DCCS	Distributed Coverage and Capacity Solutions	RAN	Regional-Area Network
EFTA	European Free Trade Association	RF	Radio Frequency
EMC	Electromagnetic Compatibility	RU	Rack Unit
EME	Europe, Middle East, Africa	SFP	Small Form-Factor Pluggable
A			
EU	European Union	SMF	Single-Mode Fiber
F	Fahrenheit	TEN	Transport Expansion Node
FCC	Federal Communications Commission	UAP	Universal Access Point
Gb	Gigabyte	Vdc	Volts, direct current
GHz	Gigahertz	W	Watts

## CommScope Part Numbers

The CommScope ION-E part numbers in this installation guide are in the format of *nnnnnnn-xx*, where the “-xx” suffix indicates the latest release. Contact your local CommScope sales representative for the current release part number.

# ION-E SERIES SYSTEM OVERVIEW

This section describes the ION-E system, which is a unified wireless infrastructure platform defined around IT based architecture. It brings together licensed wireless and power, plus Gigabit Ethernet for WiFi into one wireless system that can scale to building size and is technology and spectrum agnostic and adaptive. A basic ION-E system comprises the components listed below; see also [Figure 1](#).

- **Central Area Node (CAN)**—provides server-level control and primary signal distribution. WCS-2 (2U) and WCS-4 (4U) Subrack options are available.
- **Transport Expansion Node (TEN)**—connects to a CAN using Multi-Mode or Single-Mode fiber as a secondary distribution point. WCS-2 (2U) and WCS-4 (4U) Subrack options are available.



A WCS-2 and a WCS-4 can be configured for use as a CAN or a TEN. When the information in this guide applies to both configurations, the term “CAN/TEN” is used. When the information pertains to only one of the configurations, that configuration will be identified singularly as “CAN” or “TEN.”

- **Access Point**—connects a CAN or a TEN to antennas or other wireless devices. On the downlink, an Access Point (AP) converts data arriving at the AP to analog signals and sends them to an antenna. On the uplink, received signals are digitized and serialized into data streams which are sent back to the CAN/TEN. Each AP contains up to four transceiver paths for RF coverage. APs supports Gigabit Ethernet for WiFi, IP cameras, or other devices in addition to wireless over a common cable. An AP can be any of the following:
  - **Universal Access Point (UAP)**—connects the CAN/TEN to an internal antenna; receives data and power through Cat6A twisted pair cabling.
  - **UAP-X**—similar in function as the standard UAP, in addition to Commercial frequencies, the UAP-X also supports Public Safety frequencies, including 700, 800 and 400 MHz. The UAP-X connects the CAN/TEN to **external** antennas and supports an extensive frequency range.
  - **UAP-N25** and **UAP-XN25**—similar in function as the UAP and UAP-X, the UAP-N25 and UAP-XN25 feature a 25 MHz filter on one path (instead of the 80 MHz filter on a UAP or UAP-X). This allows coexistence of specific bands, such as Australia 850 MHz and 900 MHz.
  - **Low Power Carrier Access Point (CAP L)**—interfaces with the CAN/TEN via a Cat6A cable or an optical link. This allows the CAP L to provide data over Copper, Single-Mode Fiber (SMF), or Multi-Mode Fiber (MMF). Power for CAP Ls with a Copper Interface can be provided over Cat6A or External AC/DC. Power for CAP Ls with a Fiber Interface is provided over External AC/DC or remotely through hybrid fiber.

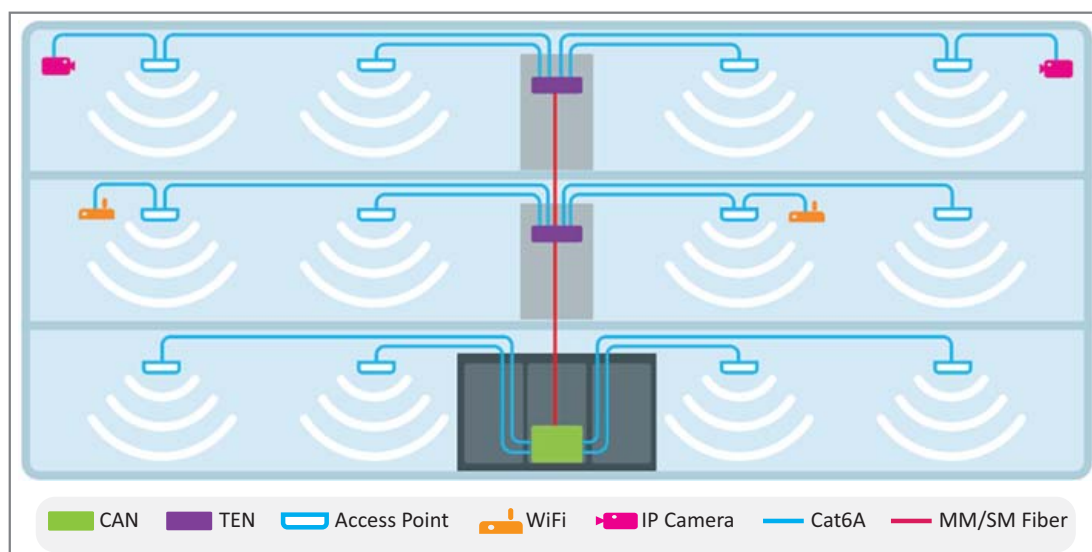
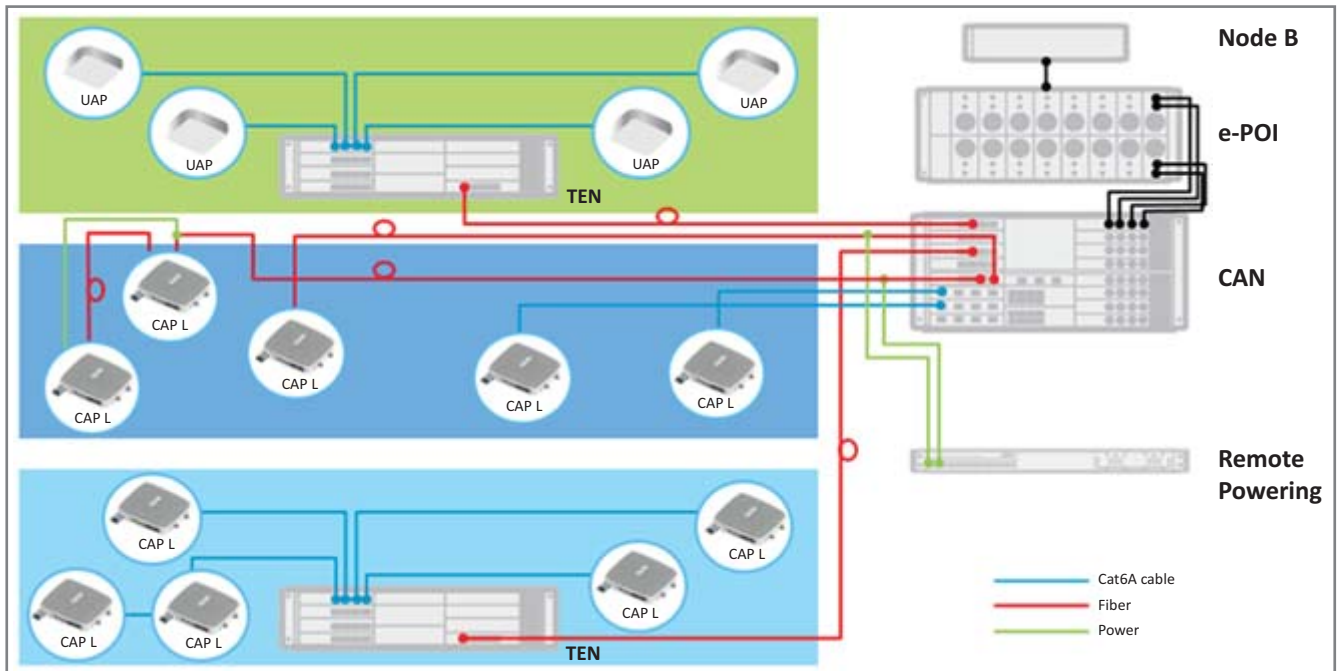

Figure 1. Basic ION-E System

# CAP L OVERVIEW

The Low Power Carrier Access Point (CAP L) interfaces with the CAN/TEN via a Cat6A cable or an optical link. This allows the CAP L to provide data over Copper, Single-Mode Fiber (SMF), or Multi-Mode Fiber (MMF). Power for CAP Ls with a Copper Interface can be provided over Cat6A or external DC. Power for CAP Ls with a Fiber Interface is provided over External AC/DC or remotely through hybrid fiber.

On the downlink, the CAP L converts data arriving at the CAP L to analog signals and sends them to the Antenna ports. On the uplink, received signals are digitized and serialized into data streams, which are sent back to the CAN/TEN. Each CAP L can provide RF coverage for up to four specific frequency bands. [Figure 2](#) shows how a CAP L can be deployed in an ION-E system.



**Figure 2.** CAP L in an ION-E System

## The CAP L

- operates within the following temperature ranges
  - CAP L without a Fan Kit (passively cooled)
    - Optical units: -33°C to +40°C (-27.4°F to 104°F)
    - Cat6A units: 0°C to +40°C (32°F to 104°F)
  - CAP L with a Fan Kit, the maximum operating temperature increases to 55°C (131°F); see also "[Fan Kit](#)" on page 10
- is outdoor rated (IP67), however, the Cat6A units are not designed for outdoor use; see "[Determine the CAP L Mounting Site](#)" on page 19
- has a typical power consumption of 98W; see also
  - "[Fan Kit](#)" on page 10
  - "[Determine the Power Consumption of the CAP L](#)" on page 18.



## CAP L Connectors, Ports, and LEDs

The following sections identify the connectors, ports, and LEDs available on the different CAP L models.

- ["CAP L with an Optical Fiber Interface" on page 6](#)
- ["CAP L with a Copper Interface and External DC Power" on page 7](#)
- ["CAP L with a Copper Interface and Power Cat6A Cable" on page 8](#)
- ["Powering a CAP L" on page 48](#)
- ["Fan Interface Port" on page 9.](#)

## CAP L with an Optical Fiber Interface

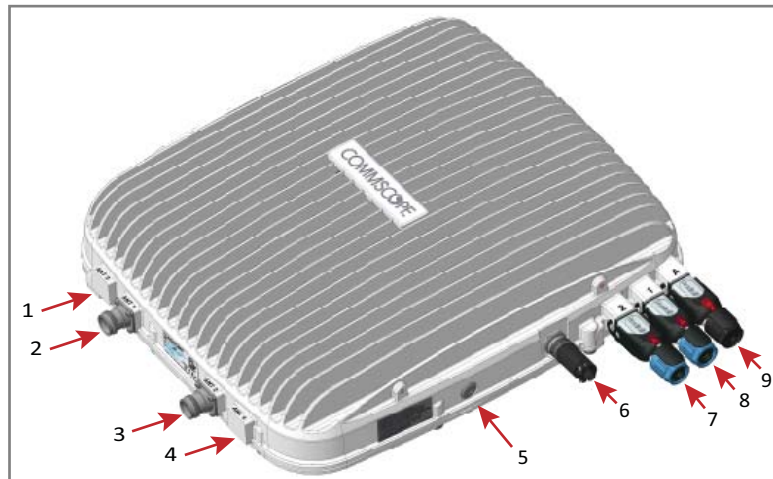

REF #	Label	Description	Function
1, 4	ANT 3, ANT 4	Not available; connector is plugged.	
2	ANT 1	4.3-10 RF connector	Connect to two separate external antennas or to two ports on a cross-polarized dual antenna via 50Ω coaxial cable. Each connector supports two RF bands. The end of the 50Ω coaxial cable that connects to an ANT connector can be either a push-pull or a threaded connector. ANT 1/2 ship with dust caps that can be discarded upon unit installation.
3	ANT 2		
5	Power LED (Unlabeled)	Power LED	See " <a href="#">Power LED Behavior</a> " on page 48.
6	Unlabeled	Proprietary 4-pin 36 to 60 Vdc Power connector	Connects to a local or remote DC power supply, or to a Hybrid Fiber Junction Box.
7	2	Optical Port 2	Connects to an optional cascaded CAP L via an Optical OCTIS Kit (PN 7770612). Port 2 provides the main signal interface. Optical transport occurs over Single Mode Fiber (SMF) or Multi Mode Fiber (MMF). Port 2 ships with factory-installed EMI/weatherproof plug, and must remain plugged if not in use. Graphic shows the OCTIS connector in blue.
8	1	Optical Port 1	Connects to an ION-E CAN/TEN (possibly through a local Hybrid Fiber Junction Box) and provides the main signal interface. Optical transport occurs over Single Mode Fiber (SMF) or Multi Mode Fiber (MMF). Uses the Optical OCTIS Kit (PN 7770612). Port 1 ships with a dust cap that can be discarded upon unit installation. Graphic shows the OCTIS connector in blue.
9	A	RJ45 Auxiliary port	Connects to external Ethernet devices such as WiFi and IP cameras. Cabling is via the appropriate CAT cable for the protocol; this model supports a 1000 BASE-T and 802.3at Class 4 Power over Cat6A Ethernet connection. Maximum attached cable length is 3 meters (9.8 feet). For information on the Auxiliary port in cascades, see " <a href="#">Cascade Rules</a> " on page 17. Port A ships with factory-installed EMI/weatherproof plug, and must remain plugged if not in use.

## CAP L with a Copper Interface and External DC Power



REF #	Label	Description	Function
1, 4	ANT 3, ANT 4	Not available; connector is plugged.	
2	ANT 1	4.3-10 RF connector	Connect to two separate external antennas or to two ports on a cross-polarized dual antenna via 50Ω coaxial cable. Each connector supports two RF bands. The end of the 50Ω coaxial cable that connects to an ANT connector can be either a push-pull or a threaded connector. ANT 1/2 ship with dust caps that can be discarded upon unit installation.
3	ANT 2		
5	Power LED (Unlabeled)	Power LED	See " <a href="#">Power LED Behavior</a> " on page 48.
6	Power button (Unlabeled)	Pushbutton switch	Places the CAP L into a low-power sleep state, which allows you to safely unplug the CAP L without a power arc. <b>Prior to disconnecting the Power cable from the CAP L, press the Power button to power off the CAP L.</b>
7	Unlabeled	Proprietary 4-pin 36 to 60 Vdc Power connector	Connects to a local or remote DC power supply, or to a Hybrid Fiber Junction Box.
8	2	Port 2	Not applicable to this model configuration—do not remove the factory-installed EMI/weatherproof plug.
9	1	Port 1	Port 1 connects to an available port on a CAT Card in the CAN/TEN via Cat6A cable and provides the main signal interface. Uses the Ethernet OCTIS Kit (PN 7760652). Port 1 ships with a dust cap that can be discarded upon unit installation.
10	A	RJ45 Auxiliary port	The Auxiliary port provides a cascade connection to an optional locally powered cascaded CAP L, or provides a connection to external Ethernet devices such as WiFi and IP cameras. Cabling is via the appropriate CAT cable for the protocol; this model supports a 1000 BASE-T and 802.3at Class 4 Power over Cat6A Ethernet connection. Maximum attached cable length is 100 meters (328 feet). Port A ships with factory-installed EMI/weatherproof plug, and must remain plugged if not in use. For information on how to use the Auxiliary port in cascades, see " <a href="#">Cascade Rules</a> " on page 17.

## CAP L with a Copper Interface and Power Cat6A Cable

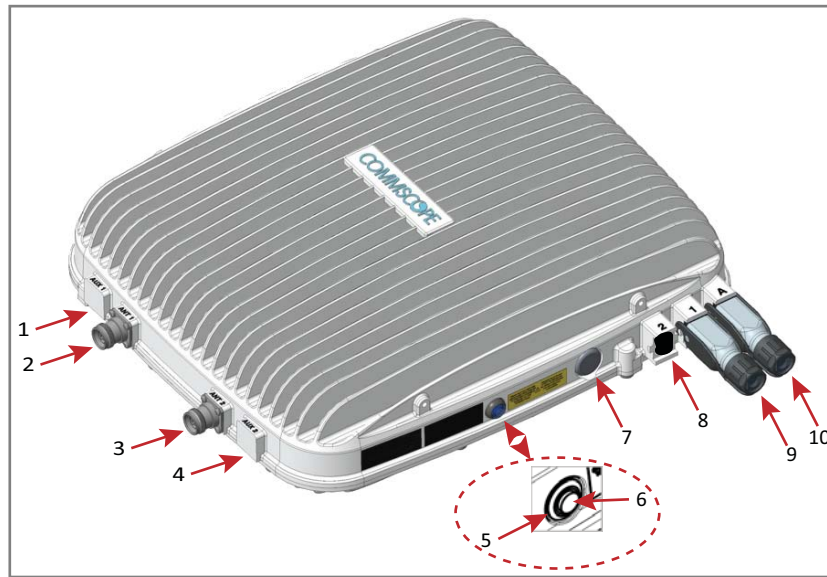

REF #	Label	Description	Function
1, 4	ANT 3, ANT 4	Not available; connector is plugged.	
2	ANT 1	4.3-10 RF connector	Connect to two separate external antennas or to two ports on a cross-polarized dual antenna via 50Ω coaxial cable. Each connector supports two RF bands. The end of the 50Ω coaxial cable that connects to an ANT connector can be either a push-pull or a threaded connector. ANT 1/2 ship with dust caps that can be discarded upon unit installation.
3	ANT 2		
5	Power LED (Unlabeled)	Power LED	See <a href="#">"Power LED Behavior"</a> on page 48.
6	Power button (Unlabeled)	Pushbutton switch	Places the CAP L into a low-power sleep state, which allows you to safely unplug the CAP L without a power arc. Power to a Cat6A CAP L may also be shutdown via the ION-E Series Software. <b>Prior to disconnecting the Power cable from the CAP L, press the Power button to power off the CAP L.</b>
7	Unlabeled	Proprietary 4-pin 36 to 60 Vdc Power connector	Plugged, not applicable to this model configuration.
8	2	Port 2	Not applicable to this model configuration—do not remove the factory-installed EMI/weatherproof plug.
9	1	Port 1	Port 1 connects to an available port on a CAT Card in the CAN/TEN via Cat6A cable and provides the main signal interface and power over Cat6A. Uses the Ethernet OCTIS Kit (PN 7760652). Port 1 ships with a dust cap that can be discarded upon unit installation.
10	A	RJ45 Auxiliary port	The Auxiliary port provides a cascade connection to an optional locally powered Secondary CAP L, or provides a connection to external Ethernet devices such as WiFi and IP cameras. Cabling is via the appropriate CAT cable for the protocol; this model supports a 1000 BASE-T and 802.3at Class 4 Power over Cat6A Ethernet connection. Maximum attached cable length is 100 meters (328 feet). Port A ships with factory-installed EMI/weatherproof plug, and must remain plugged if not in use.

## Fan Interface Port



The preceding graphic shows the proprietary 8-pin Fan Interface port, which is only available on CAP L units that ship with the factory-installed Fan Kit. If the CAP L being installed includes the Fan Kit option, the Fan Interface port will be cabled to the Fan Kit at the factory. If the CAP L being installed does not include the Fan Kit option, the Fan Interface port will be plugged.

## CAP L Accessory Options

The following sections describe hardware options for the CAP L:

- ["Fan Kit" on page 10](#)
- ["Flat Mounting Bracket Kit" on page 10](#)
- ["CAP L Mounting Bracket Kit" on page 10](#)
- ["CAP L Hybrid Fiber Splice Box Kit" on page 11](#)
- ["AC/DC Power Supply Kit" on page 11](#)
- ["OCTIS Kits" on page 11.](#)

## Fan Kit

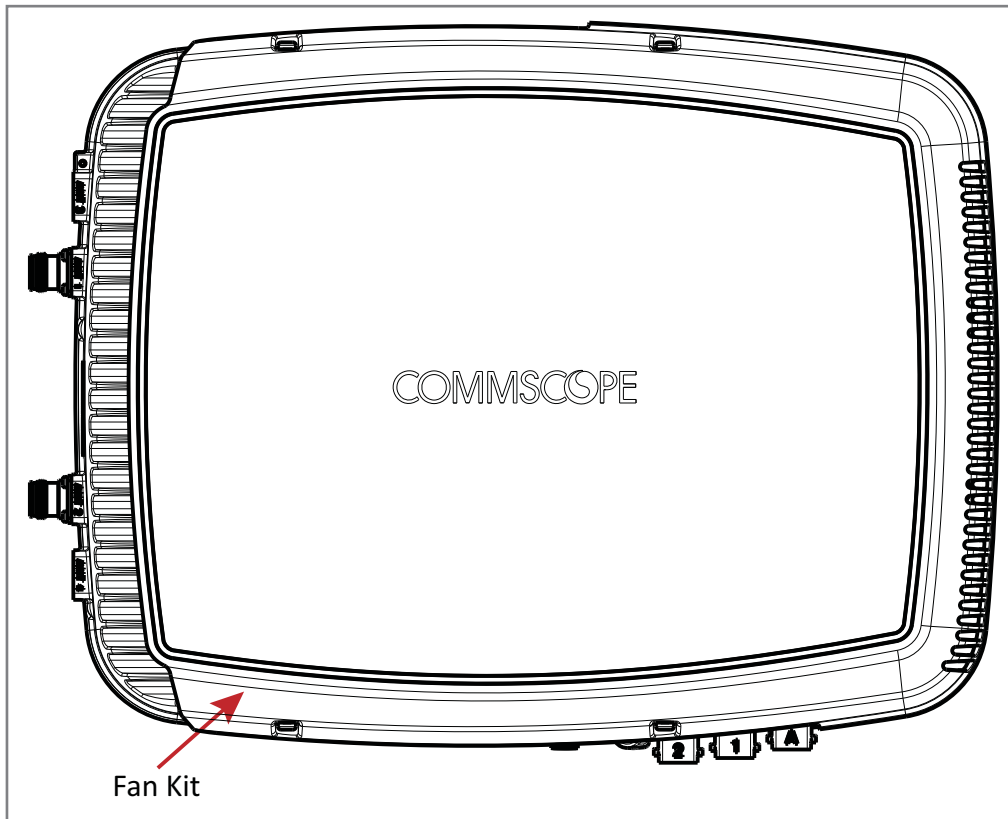

The optional Fan Kit is an integrated shroud that fits over the CAP L enclosure to extend the upper ambient temperature range. The Fan Kit

- is IP55 rated
- increases the maximum operating temperature to 55°C (131°F)
- adds 3W power consumption to the CAP L; see ["Determine the Power Consumption of the CAP L" on page 18.](#)
- is factory installed, but can be replaced in the field.

## Flat Mounting Bracket Kit

The Flat Mounting Bracket Kit (CommScope PN 7774353-xx) provides the mounting brackets required to mount an CAP L to a wall or other flat surface. See ["Wall Mount a CAP L Using a Flat Mounting Bracket Kit" on page 26.](#)

## CAP L Mounting Bracket Kit

The CAP L Mounting Bracket Kit (CommScope PN 7774354-xx) provides the mounting brackets required to mount an CAP L to a wall or other flat surface when using the ["CAP L Hybrid Fiber Splice Box Kit"](#) or the ["AC/DC Power Supply Kit."](#)

## CAP L Hybrid Fiber Splice Box Kit

The CAP L Hybrid Fiber Splice Box Kit (CommScope PN 7781091-xx) separates the power from the fiber signals on a hybrid fiber feed from the CAN/TEN. It feeds power to the CAP L through a composite cable that includes both fiber and copper power wires. Fiber and copper terminate at the Splice Box, which allows you to separate the DC wires and fiber at the remote end. For CAP Ls with a Fiber Interface, you will typically use composite cable to transport signal and power, and then use the CAP L Hybrid Fiber Splice Box Kit to terminate the fiber at the CAP L. See ["Wall Mount a CAP L Using a CAP L Hybrid Fiber Splice Box Kit"](#) on page 28.

## AC/DC Power Supply Kit

The AC/DC Power Supply Kit (CommScope PN 7775087-xx) provides a 48V External Power Supply that converts local AC power to DC power for the CAP L. Wherever copper is already available for a CAP L installation, a CAP L with Copper Interface should be installed. However, in a cascade, PoE is only available for the Primary CAP L—the Secondary CAP L will require local power and the use of the AC/DC Power Supply Kit. Moreover, the AC/DC Power Supply Kit can be used for a Fiber or Copper Interface when remote powering is not feasible. See ["Wall Mount a CAP L Using a AC/DC Power Supply Kit"](#) on page 32.

## OCTIS Kits

All CAP Ls include one OCTIS<sup>1</sup> Kit for the primary interface to the CAN/TEN. Regardless of which OCTIS Kit ships with the CAP L, it will plug into the CAP L Port 1. It is the configuration of the OCTIS Kit that then makes the AUX port compatible for a Copper Interface or a Fiber Interface.

You can order an additional OCTIS Kit, which would allow you to cascade two CAP Ls, or to attach an auxiliary Ethernet device; which OCTIS Kit you should order is identified in [Table 2](#).

**Table 2.** CAP L OCTIS Kits

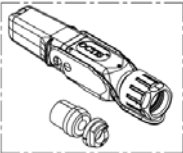
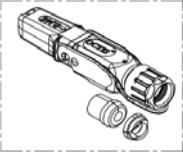
Kit Name	CommScope PN	Description
	7770612	Use only with CAP Ls with a Fiber Interface to cascade a Secondary fiber unit.
	7760652	Use with CAP Ls that have a Fiber or Copper Interface to cascade a Secondary copper unit, or to attach an auxiliary Ethernet device.

<sup>1</sup> OCTIS is a trademark of RADIALL.



# SAFELY WORKING WITH ION-E HARDWARE

The following sections provide important information that you should read and know before working with any ION-E hardware. Observe all cautions and warnings listed in this section.

## Health and Safety Precautions



A high leakage current ground (earth) connection to the Power Supply Unit (PSU) is essential before making any other connections to the PSU.



Laser radiation. Risk of eye injury in operation. Do not stare into the laser beam; do not view the laser beam directly or with optical instruments.



High frequency radiation in operation. Risk of health hazards associated with radiation from the antenna(s) connected to the unit. Implement prevention measures to avoid the possibility of close proximity to the antenna(s) while in operation.

## Property Damage Warnings



Keep operating instructions within easy reach and make them available to all users.



Only license holders for the respective frequency range are allowed to operate this unit.



Read and obey all the warning labels attached to the unit. Make sure that all warning labels are kept in a legible condition. Replace any missing or damaged labels.



Make sure the unit's settings are correct for the intended use (refer to the manufacturer product information) and regulatory requirements are met. Do not carry out any modifications or fit any spare parts, which are not sold or recommended by the manufacturer.

## General Installation Safety Requirements



Wet conditions increase the potential for receiving an electrical shock when installing or using electrically powered equipment. To prevent electrical shock, never install or use electrical equipment in a wet location or during a lightning storm.



This system is a RF Transmitter and continuously emits RF energy. Maintain a minimum 12-inch (30 cm) clearance from the antenna while the system is operating. Whenever possible, shut down the RAN before servicing the antenna.



Do not remove caps from any of the connectors until instructed to do so.



The CAP L is to be used only with CommScope (NEC Class 2) or Limited Power Source ION-E Subrack, or equivalent.



## Guard Against Damage from Electro-Static Discharge



Electro-Static Discharge (ESD) can damage electronic components. To prevent ESD damage, always wear an ESD wrist strap when working with ION-E hardware components. Not all ION-E hardware requires grounding. For those ION-E hardware components for which grounding is required, connect the ground wire on the ESD wrist strap to an earth ground source before touching the ION-E component. Wear the wrist strap the entire time that you work with the ION-E hardware.

## Compliance

- Notice:** For installations, which have to comply with FCC RF exposure requirements, the antenna selection and installation must be completed in a way to ensure compliance with those FCC requirements. Depending on the RF frequency, rated output power, antenna gain, and the loss between the repeater and antenna, the minimum distance D to be maintained between the antenna location and human beings is calculated according to this formula:

$$D_{[cm]} = \sqrt{\frac{P_{[mW]}}{4 * \pi * PD_{[mW/cm^2]}}}$$

where

- P (mW) is the radiated power at the antenna, i.e. the max. rated repeater output power in addition to the antenna gain minus the loss between the repeater and the antenna.
- PD (mW/cm<sup>2</sup>) is the allowed Power Density limit acc. to 47 CFR 1.1310 (B) for general population / uncontrolled exposures which is
  - f (MHz) / 1500 for frequencies from 300MHz to 1500MHz
  - 1 for frequencies from 1500MHz to 100,000MHz

RF exposure compliance may need to be addressed at the time of licensing, as required by the responsible FCC Bureau(s), including antenna co-location requirements of 1.1307(b)(3).

- Notice:** For installations which have to comply with European EN50385 exposure compliance requirements, the following Power Density limits/guidelines (mW/cm<sup>2</sup>) according to ICNIRP are valid:
  - 0.2 for frequencies from 10 MHz to 400 MHz
  - F (MHz) / 2000 for frequencies from 400 MHz to 2 GHz
  - 1 for frequencies from 2 GHz to 300 GHz
- Notice:** Installation of this equipment is in full responsibility of the installer, who has also the responsibility, that cables and couplers are calculated into the maximum gain of the antennas, so that this value, which is filed in the FCC Grant and can be requested from the FCC data base, is not exceeded. The industrial boosters are shipped only as a naked booster without any installation devices or antennas as it needs for professional installation.
- Notice:** For installations which have to comply with FCC/ISED requirements:

### **English:**

This device complies with FCC Part 15. Operation is subject to the following two conditions: (1) this device may not cause interference, and (2) this device must accept any interference, including interference that may cause undesired operation of the device.

This device complies with Health Canada's Safety Code. The installer of this device should ensure that RF radiation is not emitted in excess of the Health Canada's requirement. Information can be obtained at [http://www.hc-sc.gc.ca/ewh-semt/pubs/radiation/radio\\_guide-lignes\\_direct-eng.php](http://www.hc-sc.gc.ca/ewh-semt/pubs/radiation/radio_guide-lignes_direct-eng.php).

Changes or modifications not expressly approved by the party responsible for compliance could void the user's authority to operate the equipment.

#### **Antenna Stmt for ISED:**

This device has been designated to operate with the antennas having a maximum gain of 9 dBi. Antennas having a gain greater than 9 dBi are prohibited for use with this device without consent by ISED regulators. The required antenna impedance is 50 ohms.

The antenna(s) used for this transmitter must be installed to provide a separation distance of at least 30 cm from all persons and must not be co-located or operating in conjunction with any other antenna or transmitter. Users and installers must be provided with antenna installation instructions and transmitter operating conditions for satisfying RF exposure compliance.

#### **French:**

Cet appareil est conforme à FCC Partie15. Son utilisation est soumise à Les deux conditions suivantes: (1) cet appareil ne peut pas provoquer d'interférences et (2) cet appareil doit accepter Toute interférence, y compris les interférences qui peuvent causer un mauvais fonctionnement du dispositif.

Cet appareil est conforme avec Santé Canada Code de sécurité 6. Le programme d'installation de cet appareil doit s'assurer que les rayonnements RF n'est pas émis au-delà de l'exigence de Santé Canada. Les informations peuvent être obtenues:

[http://www.hc-sc.gc.ca/ewh-semt/pubs/radiation/radio\\_guide-lignes\\_direct-eng.php](http://www.hc-sc.gc.ca/ewh-semt/pubs/radiation/radio_guide-lignes_direct-eng.php)

Les changements ou modifications non expressément approuvés par la partie responsable de la conformité pourraient annuler l'autorité de l'utilisateur à utiliser cet équipement.

#### **Antenne Stmt pour ISDE:**

Ce dispositif a été désigné pour fonctionner avec les antennes ayant un gain maximal de 9 dBi. Antennes ayant un gain plus grand que 9 dBi sont interdites pour une utilisation avec cet appareil sans le consentement des organismes de réglementation d'ISDE. L'impédance d'antenne requise est 50 ohms.

L'antenne (s) utilisé pour cet émetteur doit être installé pour fournir une distance de séparation d'au moins 30 cm de toutes les personnes et ne doit pas être co-localisées ou opérant en conjonction avec une autre antenne ou émetteur. Les utilisateurs et les installateurs doivent être fournis avec des instructions d'installation de l'antenne et des conditions de fonctionnement de l'émetteur pour satisfaire la conformité aux expositions RF.

- 5 Notice:** The unit complies with Overvoltage Category II. It also complies with the surge requirement according to EN 61000-4-5 (fine protection); however, installation of an additional medium (via local supply connection) and/or coarse protection (external surge protection) is recommended depending on the individual application in order to avoid damage caused by overcurrent.

For Canada and US, components used to reduce the Overvoltage Category shall comply with the requirements of IEC 61643-series. As an alternative, components used to reduce the Overvoltage Category may comply with ANSI/IEEE C62.11, CSA Certification Notice No. 516, CSA C22.2 No. 1, or UL 1449. Suitability of the component for the application shall be determined for the intended installation.

- 6 Notice:** Corresponding local particularities and regulations must be observed. For national deviations, please refer to the respective documents included in the manual CD that is delivered with the unit.
- 7 Note:** For a Class B digital device or peripheral:

This equipment has been tested and found to comply with the limits for a Class B digital device, pursuant to part 15 of the FCC Rules. These limits are designed to provide reasonable protection against harmful interference in a residential installation. This equipment generates, uses and can radiate radio frequency energy and, if not installed and used in accordance with the instructions, may cause harmful interference to radio communications. However, there is no guarantee that interference will not occur in a particular installation. If this equipment does cause harmful interference to radio or television reception, which can

be determined by turning the equipment off and on, the user is encouraged to try to correct the interference.

**8 Notice:** For a Class A digital device or peripheral.

This equipment has been tested and found to comply with the limits for a Class A digital device, pursuant to Part 15 of the FCC Rules. These limits are designed to provide reasonable protection against harmful interference when the equipment is operated in a commercial environment. This equipment generates, uses, and can radiate radio frequency energy and, if not installed and used in accordance with the instruction manual, may cause harmful interference to radio communications. Operation of this equipment in a residential area is likely to cause harmful interference in which case the user will be required to correct the interference at his own expense.

**9 Note:** This unit complies with European standard EN60950-1 / EN62368-1.

## Equipment Symbols Used / Compliance

Please observe the meanings of the following symbols used in our equipment and the compliance warnings listed in [Table 3](#).

**Table 3.** Compliance Labels

Symbol	Compliance	Meaning
—	FCC	For industrial (Part 20) signal booster: WARNING: This is NOT a CONSUMER device. It is designed for installation by FCC LICENSEES and QUALIFIED INSTALLERS. You MUST have an FCC LICENSE or express consent of an FCC Licensee to operate this device. Unauthorized use may result in significant forfeiture penalties, including penalties in excess of \$100,000 for each continuing violation.
—	ISED	WARNING: This is NOT a CONSUMER device. It is designed for installation by an installer approved by an ISED licensee. You MUST have an ISED LICENCE or the express consent of an ISED licensee to operate this device. AVERTISSEMENT: Ce produit N'EST PAS un appareil de CONSOMMATION. Il est conçu pour être installé par un installateur approuvé par un titulaire de licence d'ISDE. Pour utiliser cet appareil, vous DEVEZ détenir une LICENCE d'ISDE ou avoir obtenu le consentement exprès d'un titulaire de licence autorisé par ISDE.
CE	CE	To be sold exclusively to mobile operators or authorized installers - no harmonized frequency bands, operation requires license. Intended use: EU and EFTA countries.
		Indicates conformity with the RED directive 2014/53/EU and/or RoHS directive 2011/65/EU.
CE 0700	CE	Indicates conformity with the RED directive 2014/53/EU and RoHS directive 2011/65/EU certified by the notified body no. 0700.

# INSTALLING CAP Ls

The following sections guide you through the installation of a CAP L. pay attention to all cautions, and follow the steps in the order presented.

## Prepare for Installation

Do the following before beginning installation.

- Review and know the cautions in "[Safely Working with ION-E Hardware](#)" on page 12.
- Review the system design plan.
- Identify the equipment installation site.
- Review the power requirements to make sure the site can support this installation.
- Map out all cable runs.
- Identify and obtain all tools and materials required to complete the installation.

## Required Distances Between CAP Ls and Antennas

Table 4 lists the distance that must be maintained between specific CAP L models and antennas. See also the requirements listed in "[Antenna Stmt for ISED:](#)" and "[Antenne Stmt pour ISDE:](#)" on page 14.

**Table 4.** Required Antenna Distance

CAP L Model	Antenna gain without cable loss [dBi]	Maximum Distance			
		FCC		ISED	
		Meters	Inches	Meters	Inches
CAP L 7/80-85/17E/19	9	.176	6.9	.256	10.1
CAP L 17E/17E/19/19	9	.218	8.58	.259	10.2
CAP L 17E/17E/23/23	9	.169	6.65	.237	9.33
CAP L 17E/19/23/25TDD	9	.178 <sup>1</sup>	7.02 <sup>1</sup>	.183 <sup>1</sup>	7.22 <sup>1</sup>
1 These values were determined by calculation rather than by measurement.					

## CAP L Installation Rules

When installing a CAP L, you must observe the following rules.

- **CAP L with Copper Interface**
  - Connects via its RJ-45 port to a CAT Card in the CAN/TEN
  - Each CAT Port can support two Copper CAP Ls, but you cannot exceed six CAP Ls per CAT Card, for maximum totals of 24 CAP Ls in a straight cascade configuration, and 32 CAP Ls per WCS Subrack in a daisy-chain configuration, but you must adhere to the Copper CAP L powering rules.
  - There can be a total of 12 CAP Ls connected to a CAT Card in a cascade configuration. The CAP L connected to the CAT Card is the Primary CAP L, to which you can connect one self-powered Secondary CAP L. See "[Cascade Rules](#)" on page 17.

- **CAP L with Fiber Interface**
  - Connects via its Optical Port 1 to an OPT Card in the CAN/TEN
  - You can connect up to 4 CAP Ls per OPT Card for a total of 16.
  - You can connect up to three CAP L units (or cascaded pairs) to OPT Card Ports 1 - 4. See "[Cascade Rules](#)" on page 17.

## Cascade Rules

When cascading a Secondary CAP L or an external Ethernet device such as WiFi or an IP camera, you must observe the following rules, which are also documented in the installation procedures included in this installation guide.

- In a cascade, the CAP L connected directly to the CAN/TEN is the Primary CAP L, and the CAP L that connects to the Primary CAP L is the Secondary CAP L.
- The cascaded unit must use the same transport type (Copper or Optical).
  - To cascade two Optical CAP Ls, use a fiber-optic cable.
  - To cascade two Copper CAP Ls, use Cat6A cable. Use 23 AWG Cat6A cable; for cable limitations, see "[Cat6A Cable Requirements for CAP Ls with a Copper Interface](#)" on page 40.
- The Secondary CAP L must get its power through the DC connector. For CAP Ls with a Copper Interface, power over the Cat6A cable to the cascaded unit is not supported.
- You connect CAP Ls with a Copper Interface to a CAT Card in the WCS Subrack. Each CAT Card has four RJ-45 ports (labeled 1 - 4).
  - You can connect up to three CAP Ls with a Copper Interface (or cascaded pairs) to CAT Card Ports 1 - 3.
  - If installed in CAT Card Port 4, the CAP L with Copper Interface must be locally powered.
- You connect CAP Ls with a Fiber Interface to an OPT Card in the WCS Subrack. Each OPT Card has four 10 Gbps ports (labeled 1 - 4) for fiber connections.
  - You can connect up to 4 CAP Ls per OPT Card for a total of 16.
  - In a cascade, the CAP L connected to the OPT Card is the Primary CAP L, to which you can connect one Secondary CAP L.
- Use of the Auxiliary ports in a cascaded system is limited as described below.
  - For CAP Ls with a Fiber Interface, only use the Auxiliary port on the Primary CAP L.
  - For CAP Ls with a Copper Interface, use the Auxiliary port on the Primary CAP L to connect one of the following:
    - a locally powered Secondary CAP L
    - an external Ethernet device such as WiFi or an IP camera.
- The total 320 MHz RF bandwidth is shared between the two cascaded units, but can be shared unevenly; that is, with more bandwidth going to either the Primary or Secondary CAP L—either CAP L can transmit all the 320 MHz RF bandwidth or any subset of it.
- After the Primary CAP L powers up, the Secondary CAP L will be discovered and power up on its own; for information on how a CAP L powers up, see "[Powering a CAP L](#)" on page 48.

## Recommended Tools and Material

- Electrostatic Discharge (ESD) wrist strap
- Drill and bits to mount CAP L to a wall or ceiling
- Fiber cleaning equipment
- if required per local practice, insulated stranded copper wire for chassis ground; see "[\(Optional\) Ground the CAP L](#)" on page 36.

## Determine the Power Consumption of the CAP L

Use the power consumption matrix in [Table 5](#) to calculate power consumption for a CAP L, where

- the consumption numbers are at the CAP L power inputs and do not account for feed losses
- the maximum consumption numbers in [Table 5](#) do not include the power consumed by any attached auxiliary devices. Both CAP L power consumption and auxiliary device power must be included when calculating feed losses.

**Table 5. CAP L Power Consumption**

Configuration	Voltage Range (V)	Typical Power (W)	Maximum Power (W)
Optical Fiber Interface without Fan Kit <sup>1,2</sup>	36 - 60	92	102
Optical Fiber Interface with Fan Kit <sup>1,2</sup>	36 - 60	95	107
Copper Interface and External DC Power without Fan Kit <sup>1</sup>	36 - 60	100	110
Copper Interface and External DC Power with Fan Kit <sup>1</sup>	36 - 60	103	115
Copper Interface and Power Cat 6A Cable without Fan Kit	<60V maximum	100	110
Copper Interface and Power Cat 6A Cable with Fan Kit	<60V maximum	103	115

1 Does not include consumption of optional local DC supply.

2 Optical unit does not include SFP+ Module consumption. Can support up to 3W (more with engineering consultation) maximum total SFP+ Module consumption. Typical installation (sufficient for SM up to 10km or MM) would be 0.8W typical, 1.0W max for each SFP+ Module.

## Determine the CAP L Mounting Site

When deciding on a suitable mounting site, observe the following rules; refer also to "[Mounting Orientation for Wall Mounts](#)" on page 24.

- The CAP L is suitable for installation indoors for any unit.
- CommScope recommends that a CAP L with an Optical Fiber Interface be installed outdoors only if it has a Fan Kit.



**A CAP L with a Copper Interface is not designed for outdoor installations—it is not lightning protected. However, the antenna to which the Copper Interface units attach can be outdoors if suitable lightning-protection devices are used at the antenna site.**

- Use the weights listed in [Table 6](#) to determine a site that can bear the weight of the CAP L that is being installed, where:
  - The “Maximum Lift Weight” is the highest weight that must be lifted during installation. (An installer only needs to lift CAP L components at one time, not the wholly configured CAP L.)
  - The “Total Hanging Weight” is the weight of the CAP L, including the weight of the Mounting Bracket and Power Supply, minus the weight of the external cables and connectors, that the mounting site must be able to support.

**Table 6. Maximum CAP L Installation Weights\***

CAP L configured with this kit ...	Maximum Lift Weight				Total Hanging Weight			
	No Fan Kit		With Fan Kit		No Fan Kit		With Fan Kit	
	kg	lbs.	kg	lbs.	kg	lbs.	kg	lbs.
Flat Mounting Bracket	10.8	23.8	11.3	25	10.8	23.8	11.3	25
AC/DC Power Supply Kit	10.7	23.6	11.2	24.7	13.2	29	13.7	30.2
CAP L Hybrid Fiber Splice Box Kit	10.7	23.6	11.2	24.7	12.2	26.9	12.7	28

- Use the dimensions shown in [Figure 3 on page 20](#) through [Figure 5 on page 21](#).



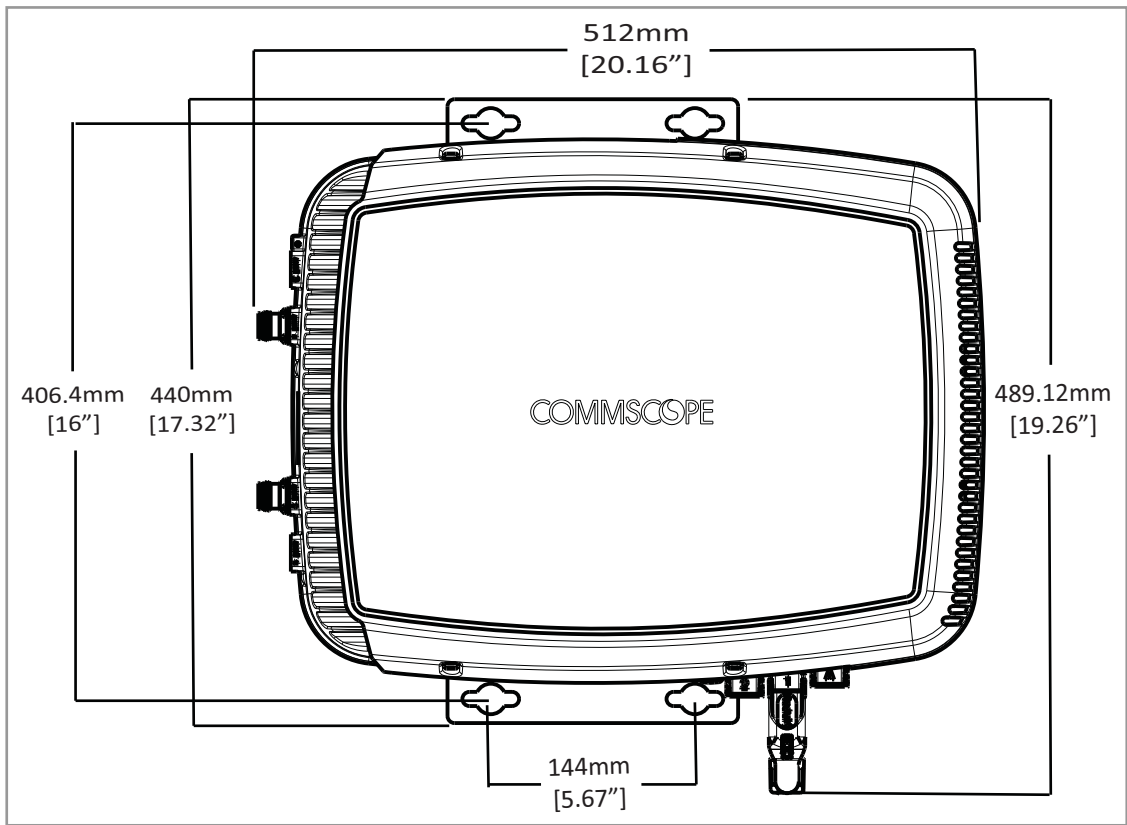

Figure 3. Mounting Dimensions for a CAP L with the Flat Mounting Bracket Kit

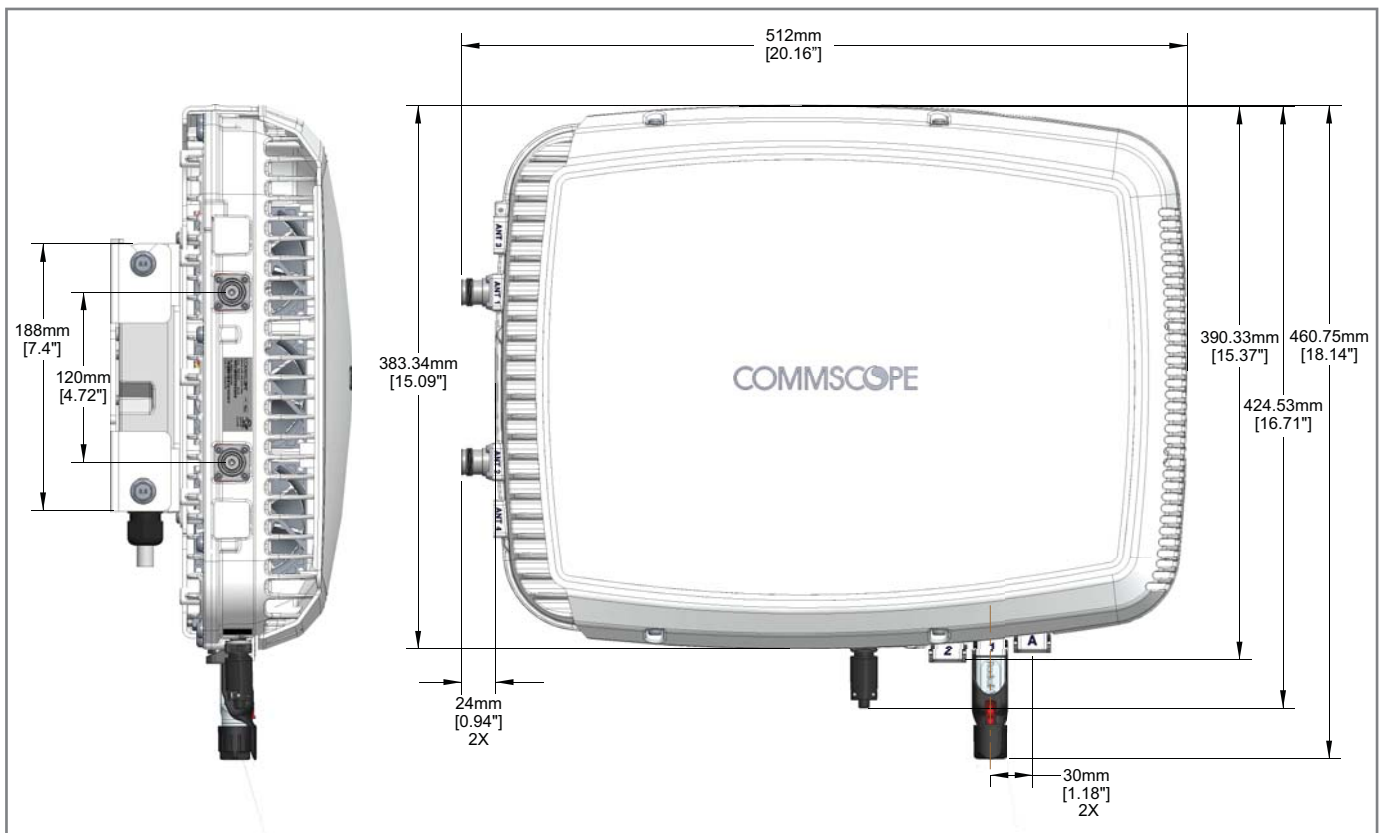
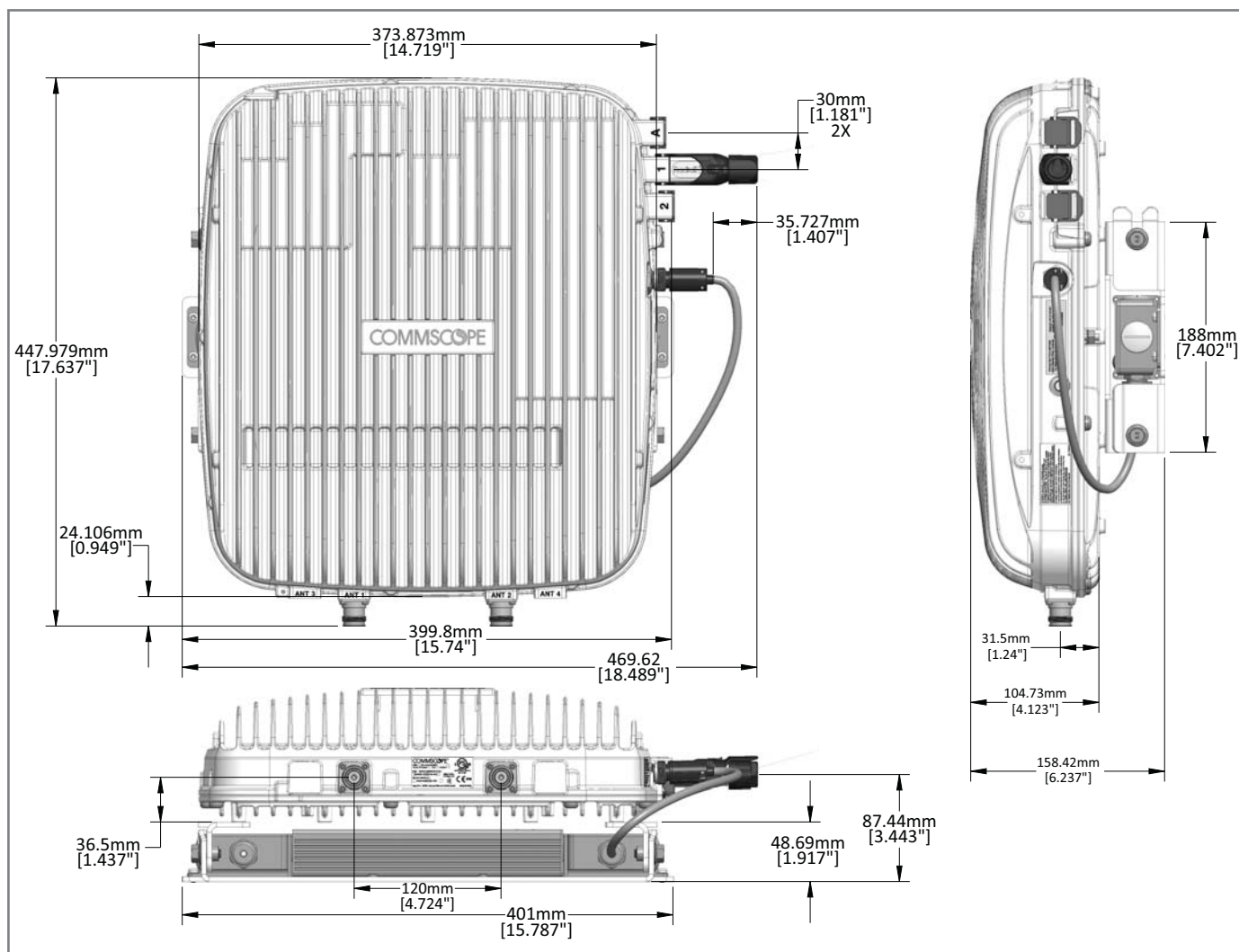

Figure 4. Mounting Dimensions for a CAP L Mounted with the CAP L Hybrid Fiber Splice Box Kit





**Figure 5.** Mounting Dimensions for a CAP L Mounted with the AC/DC Power Supply Kit

## General Mounting Cautions

The following cautions apply to all CAP L installations; there may be other mounting cautions applicable to a specific mounting option, which will be defined in the applicable mounting procedure.



**Attach all CAP Ls securely to a stationary object as described in this installation guide.**



**To maintain proper ventilation, keep at least 76 mm (3-inch) clearance around the CAP L.**



**The installation site must be able to bear the weight of the CAP L; see [Table 6 on page 19](#).**

## Unpack and Inspect the CAP L and Optional Accessories

- 1 Inspect the exterior of the shipping container(s) for evidence of rough handling that may have damaged the components in the container.
- 2 Unpack each container while carefully checking the contents for damage and verify with the packing slip.
- 3 If damage is found or parts are missing, file a claim with the commercial carrier and notify CommScope Technical Support (see ["DCCS Global Technical Support" on page 51](#)). Save the damaged cartons for inspection by the carrier.
- 4 Save all shipping containers for use if the equipment requires shipment at a future date.

## Mount the CAP L

The CAP L is suitable for indoor and outdoor installations as follows:

- Indoors—All versions of the CAP L can be installed indoors.
- Outdoors—
  - Only Optical Fiber CAP Ls with the optional Fan Kit can be installed outdoors.
  - Do not install Copper CAP Ls (that is, have Cat6A cabling) outdoors as they are not designed for outdoor temperatures, nor do they have required lightning protection.







Mounting instructions are divided into the sections listed below.

- The following sections apply to all installations.
  - ["General Mounting Cautions" on page 21](#)
  - ["Mounting Orientation for Wall Mounts" on page 24](#).
- Follow the mounting instructions that are appropriate for this installation:
  - ["Flat-Surface Mount a CAP L" on page 23](#)
  - ["Wall Mount a CAP L Using a Flat Mounting Bracket Kit" on page 26](#)
  - ["Ceiling Mount a CAP L with a Fan Kit" on page 35](#)
  - ["Wall Mount a CAP L Using a AC/DC Power Supply Kit" on page 32](#).

## Flat-Surface Mount a CAP L

You can place a CAP L on a flat surface, such as a shelf, desk, cabinet, above a ceiling, or any other horizontal surface that allows stable placement.

If you mount the CAP L on a flat surface, in addition to the rules listed in "[General Mounting Cautions](#)" on [page 21](#), you must also observe the following rules that are specific to a flat-surface mount.

-  To maintain proper ventilation, keep at least 76 mm (3-inch) clearance around the CAP L.
-  Do not stack CAP Ls on top of each other.
-  Always secure the CAP L to the mounting surface.
-  If a CAP L without a Fan Kit is flat-surface mounted, the minimum clearance above the CAP L is 203.2 millimeters (8 inches).
-  Always mount the CAP L with its mounting option facing down against the mounting surface, and the enclosure fins facing up; see [Figure 6](#).
-  If you are mounting the CAP L above a ceiling, its antennas must protrude below the ceiling. That is, the CAP L will be above the ceiling, but any connected WiFi units or IP cameras will be mounted below the ceiling; see [Figure 6](#).

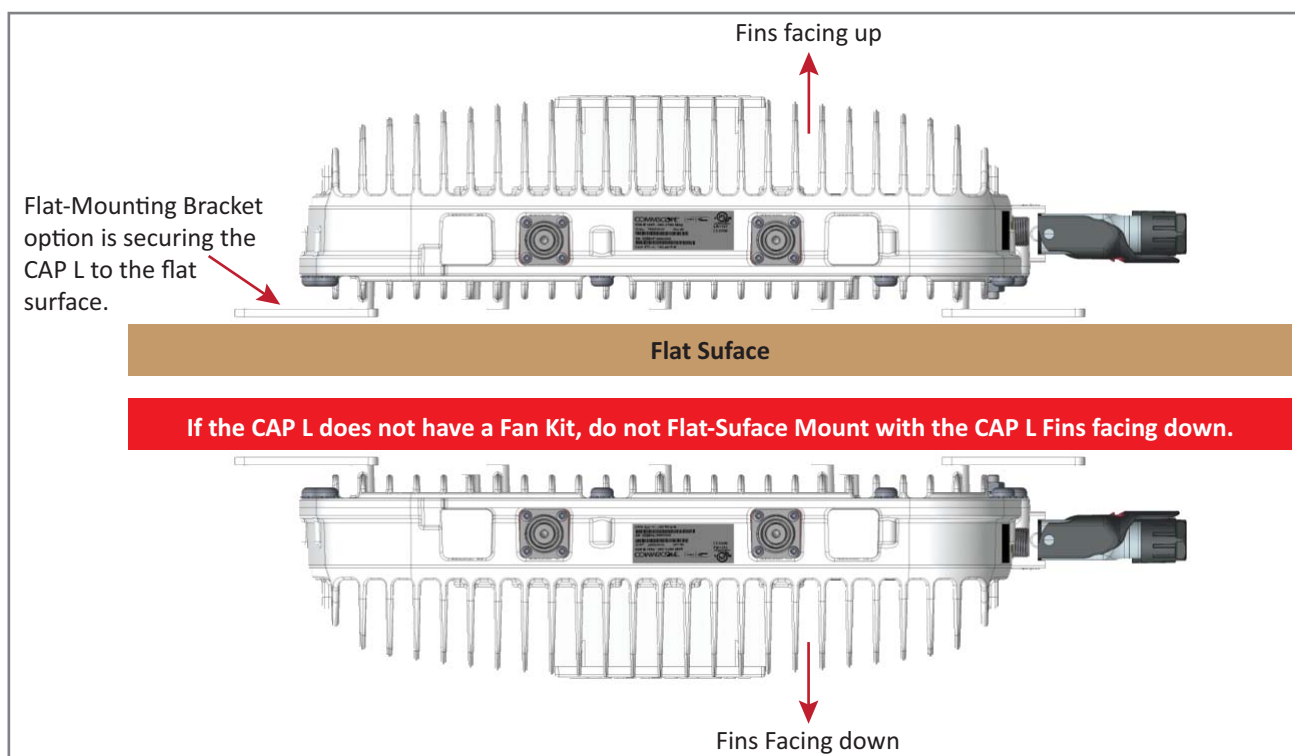

**Figure 6.** CAP L Orientation in Flat-Surface Mounting

After you mount the CAP L on a flat surface, follow the steps in "[Connect the CAP L Cables](#)" on [page 37](#).

## Wall Mount a CAP L

The following sections provide the installation methodology and steps required to mount a CAP L to a wall.

### Mounting Orientation for Wall Mounts

When wall mounting a CAP L, the recommendations should be observed.

- **Wall Mount Orientation for a CAP L without a Fan Kit**



A CAP L that does not have a Fan Kit is passively cooled. You should therefore mount a CAP L that does not have a Fan Kit with the ANT ports pointing down (see [Figure 7](#)). Otherwise, the CAP L will have a reduced maximum operating temperature of 33°C (91°F).

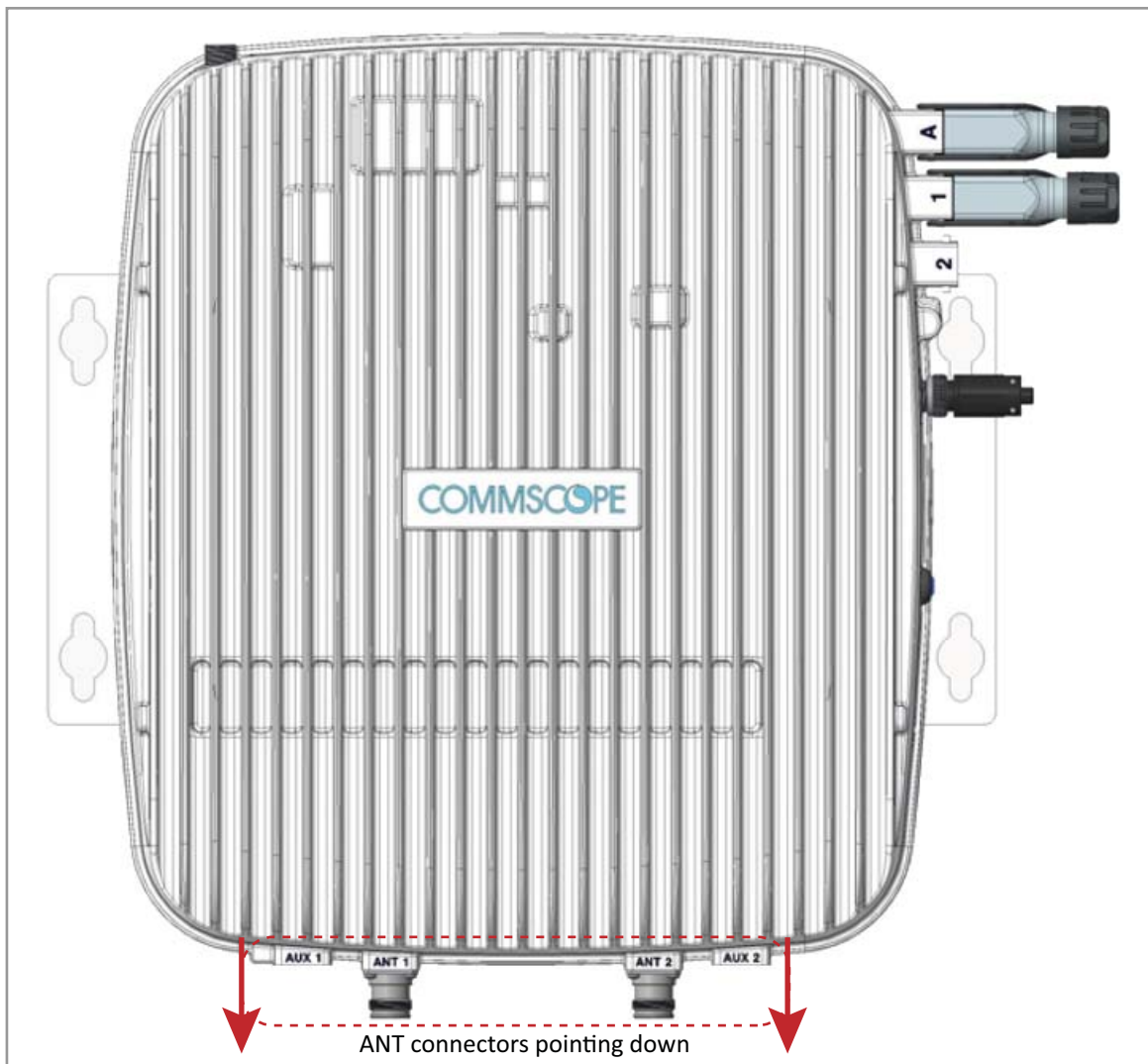

**Figure 7.** Mounting Orientation for a CAP L without the Optional Fan Kit (Flat Mounting Bracket Shown)

- **Wall Mount Orientation for a CAP L with a Fan Kit**—To allow for optimal access to the CAP L cables, it is recommended that a CAP L with the Fan Kit option be mounted with the ANT ports are pointing to the left; see [Figure 8](#).

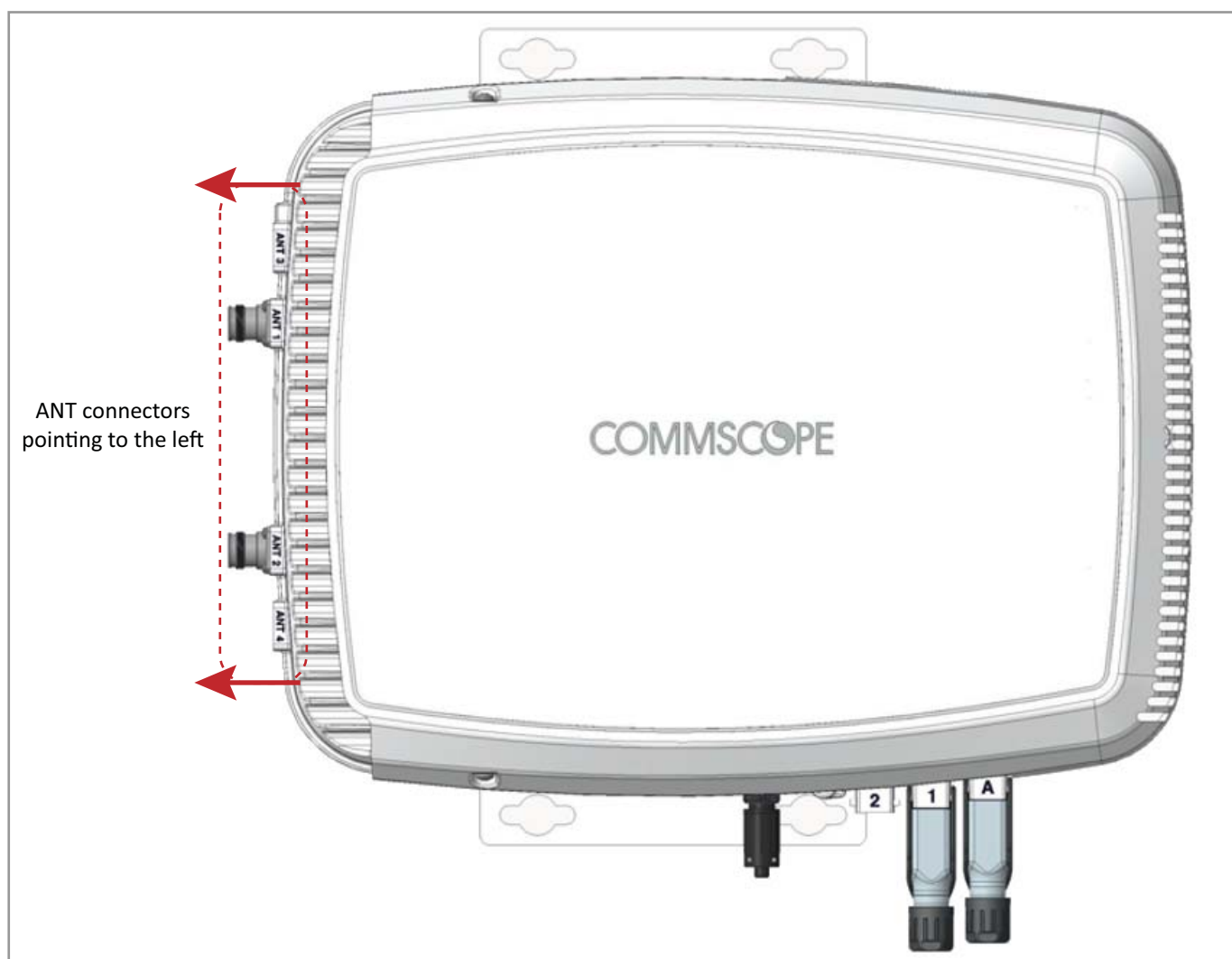

**Figure 8.** Mounting Orientation for a CAP L with the Optional Fan Kit (Flat Mounting Bracket Shown)



Mounting requirements for flat surfaces are described in ["Flat-Surface Mount a CAP L"](#) on page 23. Ceiling-mount requirements are described in ["Ceiling Mount a CAP L with a Fan Kit"](#) on page 35.

## Wall Mount a CAP L Using a Flat Mounting Bracket Kit

- 1 Follow the steps in "Unpack and Inspect the CAP L and Optional Accessories" on page 22.
- 2 Refer to and observe all cautions listed in "General Mounting Cautions" on page 21.
- 3 Refer to "Determine the CAP L Mounting Site" on page 19 to determine the mounting location, which must be able to support the weight and dimensions of the CAP L.
- 4 Refer to "Mounting Orientation for Wall Mounts" on page 24 to determine the mounting orientation of the CAP L.
- 5 Attach the two mounting brackets to the back of the CAP L enclosure as described below and as shown in [Figure 9](#) (CAP L with a Fan Kit) and [Figure 10](#) on page 27 (CAP L without Fan Kit).
  - a Use three of the M6-1.0 x14mm screws that came with the Flat Mounting Bracket Kit to attach the left or top mounting bracket to the three corresponding horizontal or vertical M6-1.0 mounting taps on the back of the CAP L chassis.
  - b Use three of the M6-1.0 x14mm screws that came with the Flat Mounting Bracket Kit to attach the right or bottom mounting bracket to the three corresponding horizontal or vertical M6-1.0 mounting taps on the back of the CAP L chassis.

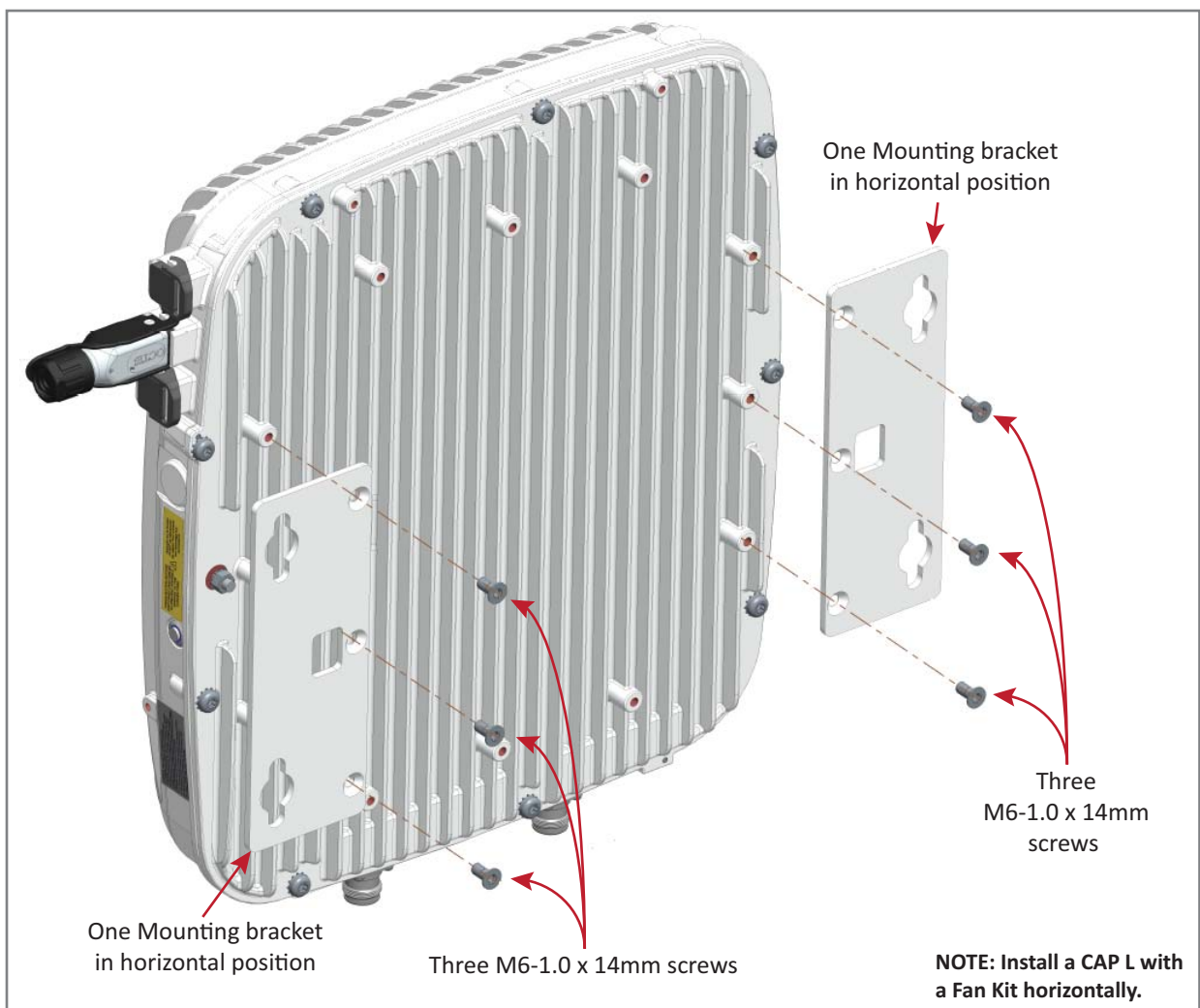

**Figure 9.** CAP L (No Fan Kit) with Flat Mounting Bracket Kit (PN 7774353-xx)



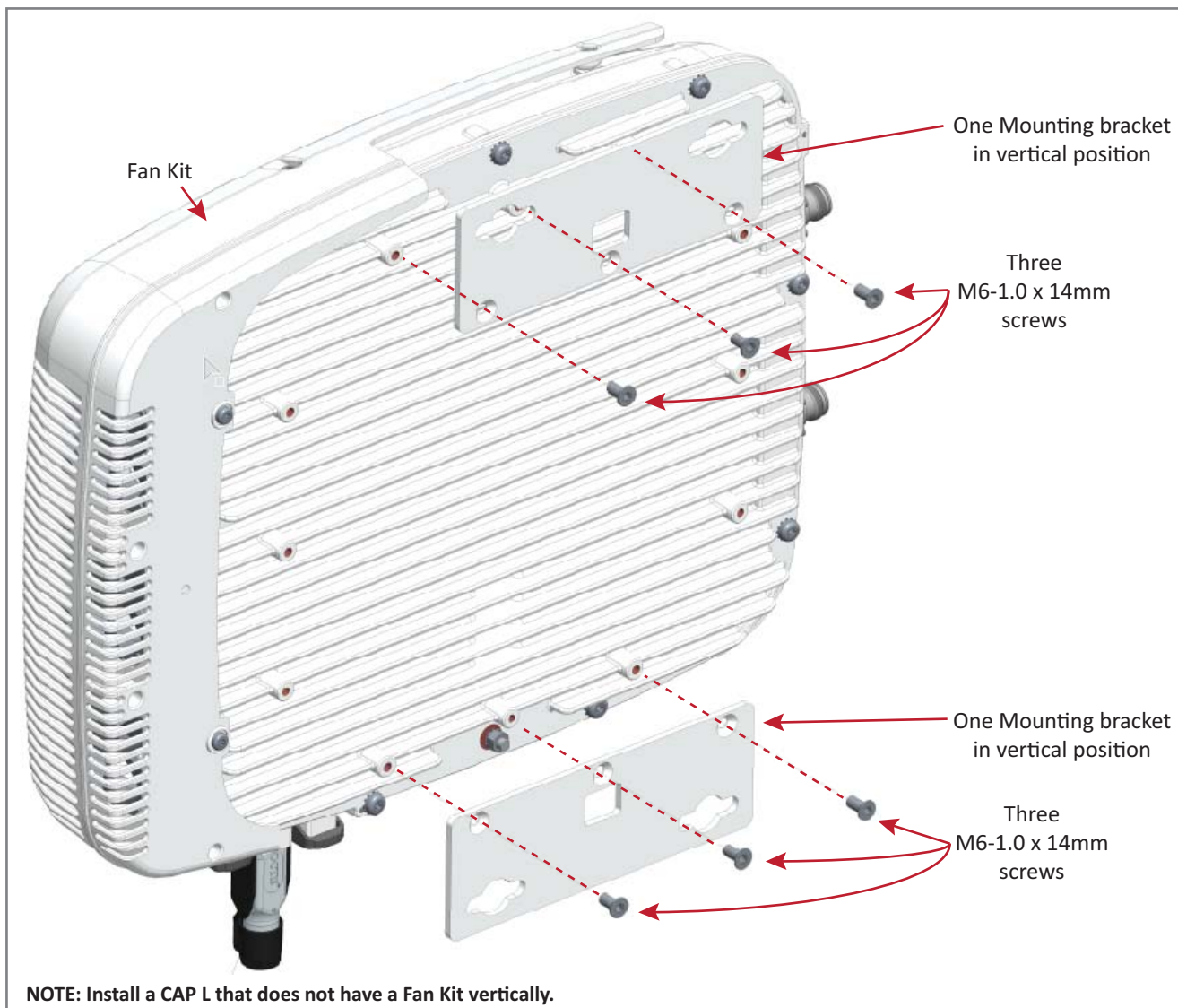

**Figure 10.** CAP L with a Fan Kit and Flat Mounting Bracket Kit (PN 7774353-xx)

- 6 Use four 5/16-inch or M8 lag screws (or whatever screw type is appropriate for the material to which the CAP L is to be mounted on) to mount the CAP L to the wall.
- 7 Follow the steps in "[\(Optional\) Ground the CAP L](#)" on page 36 if grounding is required or preferred.
- 8 Follow the steps in "[Connect the CAP L Cables](#)" on page 37.

## Wall Mount a CAP L Using a CAP L Hybrid Fiber Splice Box Kit

- 1 Follow the steps in "Unpack and Inspect the CAP L and Optional Accessories" on page 22.
- 2 Refer to "Determine the CAP L Mounting Site" on page 19 to determine the mounting location, which must be able to support the weight and dimensions of the CAP L.
- 3 Refer to "Mounting Orientation for Wall Mounts" on page 24 to determine the mounting orientation of the CAP L.
- 4 Assemble the cables in the Hybrid Fiber Splice Box.

- a Open the Hybrid Fiber Splice Box and remove the installation kit that is inside.



- b Using the parts from the Hybrid Fiber Splice Box, insert the Splice Holder and fasten it using a PTK 30x6 screw and one M4 washer.

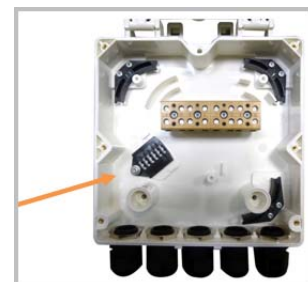

- c From the CAP L Hybrid Fiber Splice Box Kit, insert Fiber Patch Cord in one of the cable glands indicated in the graphic to the right.

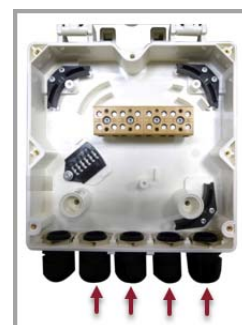

- d Strip the insulation of the composite cable for 100 cm and the fibers for 90 cm, and then shorten the copper cables to 25 cm.

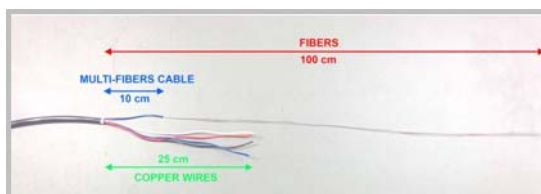



- e Insert the composite cable in the first cable gland and separate the multi-fibers cable from the copper wires. It is necessary to remove the nut to perform this action. The cable must be fed through the nut and it must be retightened once finished.



- f Bend the spliced fibers using the corner guides and fix the splices to the splice holder.

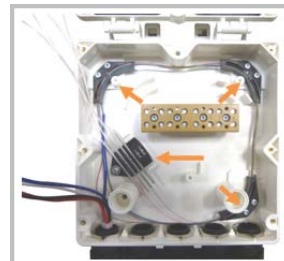

- g Bend the optical cables as show in the picture to the right.

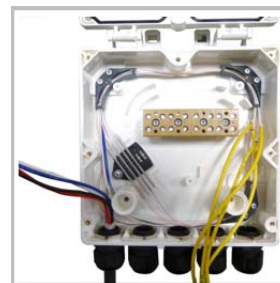

- h If a second splice holder is needed, it can be assembled using the M4 insulating washer and two M4 plain washers, as shown to the right. The required screw is a PTK30 x 12.



- i Mount the internal support Splice Box ION-U RU using three PTK30 x 6 screws.

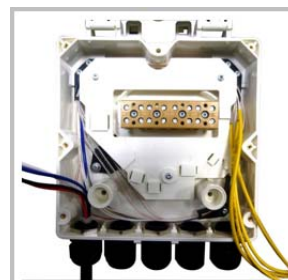

- j Remove the sealing nut and rubber of the cable gland and insert the optical cables.



**k** Place each cable into one of the grooves of the seal insert.



**l** Press the seal insert into the clamp ring opening.



**m** Fix the optical cables inside the box using one cable tie and tighten the sealing nut.

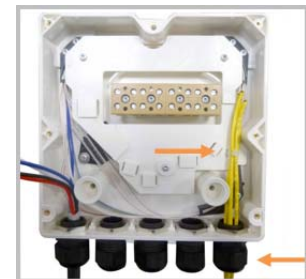

**n** It is possible to separate the optical cables and use two different cable glands. Remove the sealing nut and rubber on each cable gland.

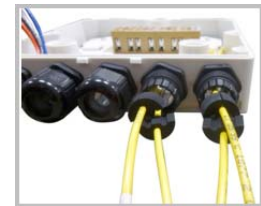

**o** Close all unused grooves with the plastic cylinders, no matter if one or two cable glands are used.



**p** Insert the copper wires in the first multiple terminal connectors. See markings on the internal support. Then fasten the copper cables inside the box using one cable tie.



**q** Remove the sealing nut and insert the Remote Unit supply cable and tighten the sealing nut.



- r Connect the supply cable to the terminal strip and fix it inside the box using one cable tie. It is possible to connect a second supply cable.

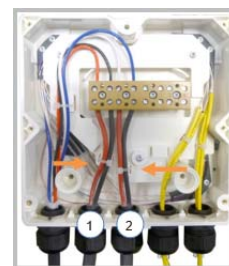

- s In case of using remote unit Vdc/100 connect the supply cable as shown besides. Refer to markings on the internal support.



- 5 Assemble and mount the CAP L Hybrid Fiber Splice Box Kit and the CAP L, as described below and as shown in [Figure 11 on page 32](#), which shows a CAP L with Fan Kit (installation for a CAP L without a Fan Kit is the same).
  - a Attach the Hybrid Fiber Splice Box to the Wall Bracket with the three captive screws already installed in the Splice Box.
  - b Attach the assembled Hybrid Splice Box and Wall Mounting Bracket to the selected mounting location.
  - c Use the six M6-1.0 x14mm screws to attach the two Angled Mounting Brackets to the Wall Mounting Bracket.
    - i Put the top two flange-head screws halfway into the mounting brackets, and then use them to “hang” the CAP L in the Wall Mounting Bracket.
    - ii Attach the bottom two flange-head screws.
    - iii Tighten all four screws.
  - d From the CAP L Hybrid Fiber Splice Box Kit:
    - i Attach the Local Power Jumper to the CAP L power connector.
    - ii Attach the Fiber Patch Cord to the CAP L Port 1; the other end was attached in Step 4c ([page 28](#)) to one of the cable glands.

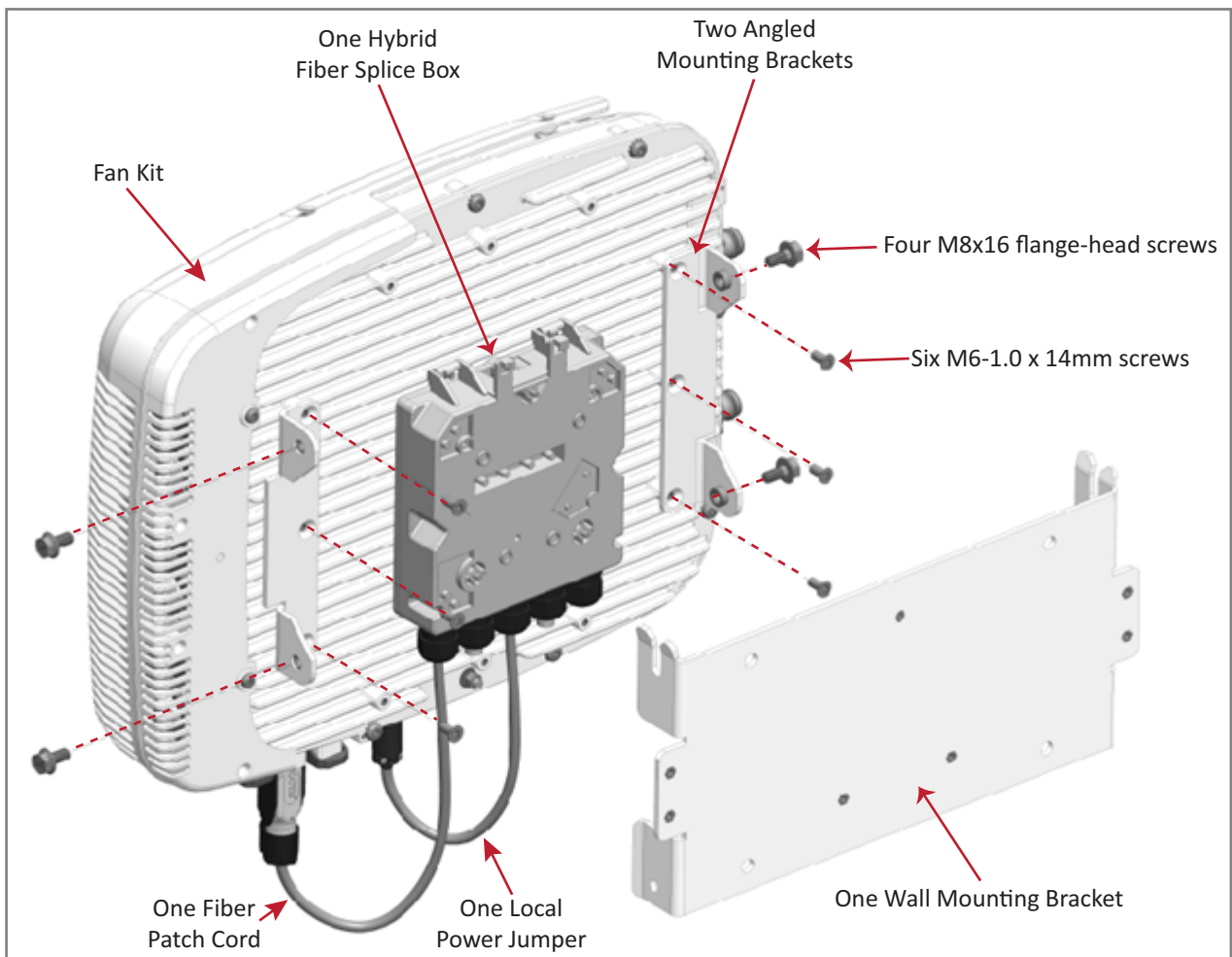

**Figure 11.** CAP L with Fan Kit, CAP L Mounting Bracket Kit, and CAP L Hybrid Fiber Splice Box Kit

- 6 Follow the steps in "[\(Optional\) Ground the CAP L](#)" on page 36 if grounding is required or preferred.
- 7 Follow the steps in "[Connect the CAP L Cables](#)" on page 37.

### Wall Mount a CAP L Using a AC/DC Power Supply Kit

- 1 Refer to and observe all cautions listed in "[General Mounting Cautions](#)" on page 21.
- 2 Refer to "[Determine the CAP L Mounting Site](#)" on page 19 to determine the mounting location, which must be able to support the weight and dimensions of the CAP L.
- 3 Refer to "[Mounting Orientation for Wall Mounts](#)" on page 24 to determine the mounting orientation of the CAP L.
- 4 Follow the steps in "[Unpack and Inspect the CAP L and Optional Accessories](#)" on page 22.

- 5 Assemble and mount the AC/DC Power Supply Kit and the CAP L, as described below and as shown in [Figure 12](#) (CAP L without Fan Kit) and [Figure 13 on page 34](#) (CAP L with Fan Kit). The Local Power Jumper Cable Assembly will be connected to the AC/DC Power Supply Junction Box at the factory.
  - a Use the four screws to attach the AC/DC Power Supply assembly to the Wall Mounting Bracket.
  - b Attach the assembled AC/DC Power Supply Kit and Wall Mounting Bracket to the selected mounting location.
  - c Use the six M6-1.0 x14mm screws to attach the two Angled Mounting Brackets to the Wall Mounting Bracket.
    - i Put the top two flange-head screws halfway into the mounting brackets, and then use them to “hang” the CAP L in the Wall Mounting Bracket.
    - ii Attach the bottom two flange-head screws.
    - iii Tighten all four screws.

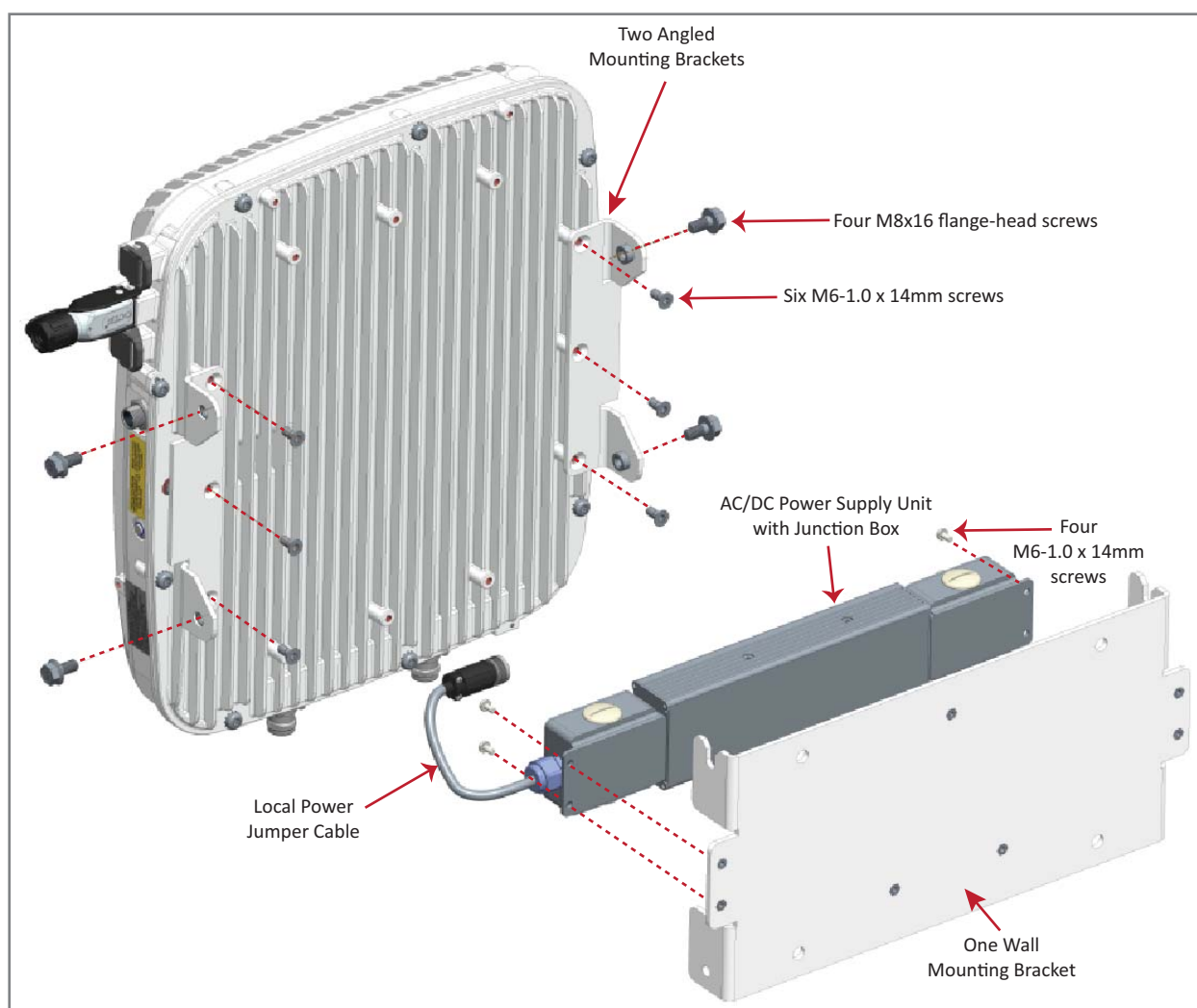

**Figure 12.** CAP L (No Fan Kit) with AC/DC Power Supply Kit (PN 7775087-xx) and CAP L Mounting Bracket Kit (7774354-xx)

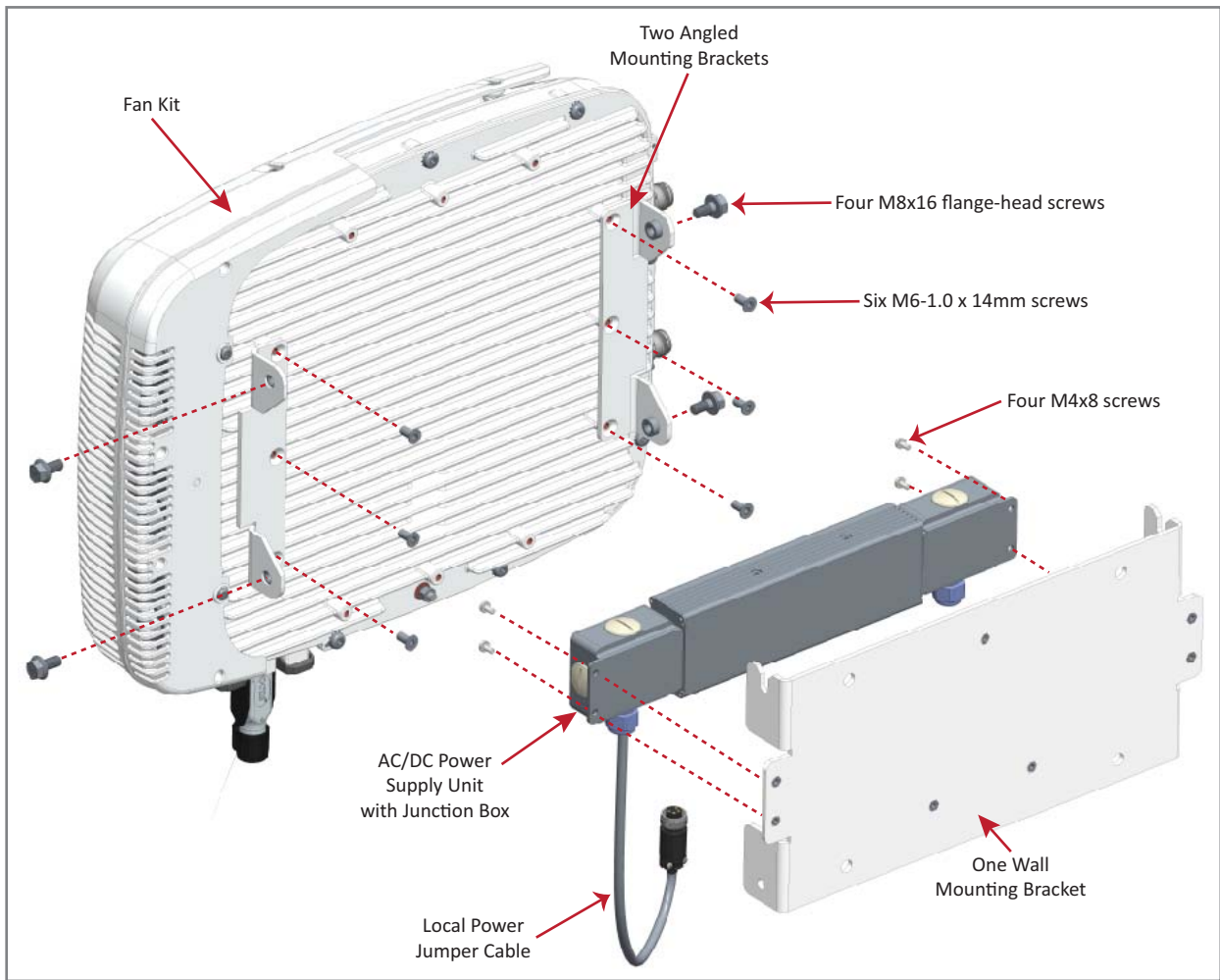

**Figure 13.** CAP L with Fan Kit and with AC/DC Power Supply Kit (PN 7775087-xx) and CAP L Mounting Bracket Kit (PN 7774354-xx)



- 6 Connect the Local Power Jumper Cable (shown below) to the CAP L 36 to 60 Vdc Power connector (see ["CAP L with a Copper Interface and Power Cat6A Cable"](#) on page 8).

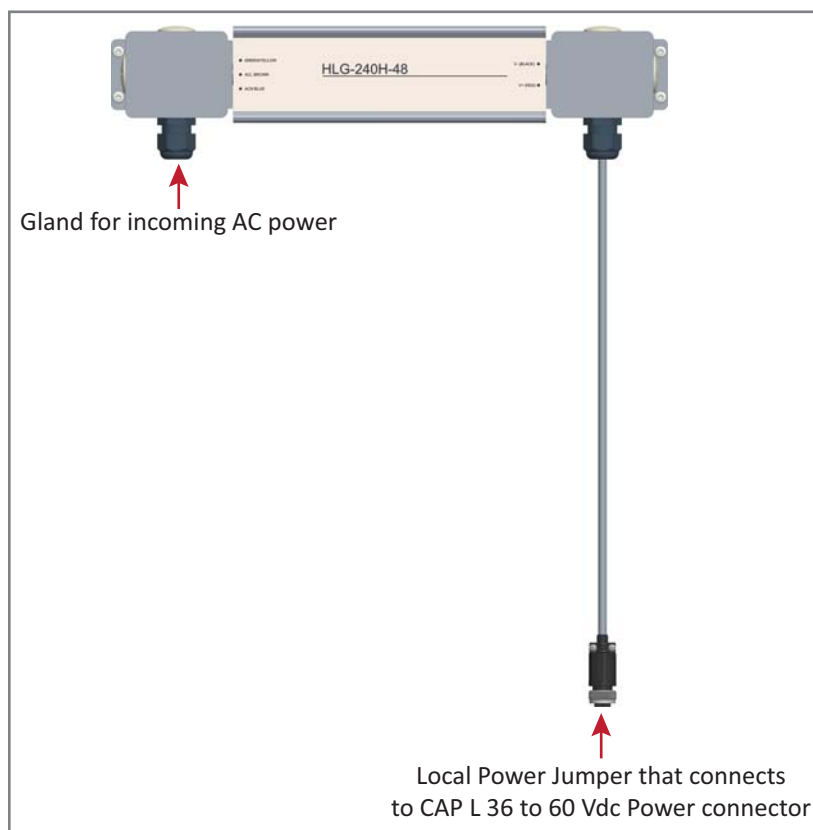

- 7 Follow the steps in ["\(Optional\) Ground the CAP L"](#) on page 36 if grounding is required or preferred.
- 8 Follow the steps in ["Connect the CAP L Cables"](#) on page 37.

## Ceiling Mount a CAP L

You can mount a CAP L above or below a ceiling. When installing a CAP L below a ceiling, the use of the optional Fan Kit determines how the CAP L can be ceiling mounted, as described in the following sections.

- ["Ceiling Mount a CAP L without a Fan Kit"](#) on page 35
- ["Ceiling Mount a CAP L with a Fan Kit"](#) on page 35.

If you mount the CAP L above the ceiling, its antennas must protrude below the ceiling.

### Ceiling Mount a CAP L without a Fan Kit

A CAP L that does not have a Fan Kit should only be installed above a suspended ceiling on a flat surface, using the steps in ["Flat-Surface Mount a CAP L"](#) on page 23.

### Ceiling Mount a CAP L with a Fan Kit

- 1 Follow the steps in ["Unpack and Inspect the CAP L and Optional Accessories"](#) on page 22.
- 2 Refer to and observe all cautions listed in ["General Mounting Cautions"](#) on page 21.
- 3 Refer to ["Determine the CAP L Mounting Site"](#) on page 19 to determine the mounting location, which must be able to support the weight and dimensions of the CAP L.

- 4 Follow the steps in one of the following sections that apply to securing the desired mounting bracket to the CAP L:
  - "Wall Mount a CAP L Using a Flat Mounting Bracket Kit" on page 26
  - "Wall Mount a CAP L Using a CAP L Hybrid Fiber Splice Box Kit" on page 28
  - "Wall Mount a CAP L Using a AC/DC Power Supply Kit" on page 32
- 5 Use four 5/16-inch or M8 lag screws (or whatever screw type is appropriate for the material to which the CAP L is to be mounted on) to mount the CAP L to the ceiling.
- 6 Follow the steps in "(Optional) Ground the CAP L" on page 36 if grounding is required or preferred.
- 7 Follow the steps in "Connect the CAP L Cables" on page 37.

## (Optional) Ground the CAP L

Follow the steps below to ground the OPA only if grounding is required in your locality or if the installation plans require the CAP L be grounded. The different CAP L installation procedures will tell you when to ground the CAP L.

**NOTE:** The CAP L is equipped with an M6 grounding stud located on the back of the unit; however, grounding is not necessary. CAP Ls are classified as low-voltage devices and do not have internal power supplies. CommScope recommends checking your local and national electrical codes to determine if grounding is a requirement.

- 1 Obtain a length of #18 AWG (1.00 mm) insulated stranded copper wire for use as a chassis-grounding wire.
- 2 Terminate one end of the wire with a ring terminal.
- 3 Locate the chassis-ground stud at the rear of the CAP L enclosure.
- 4 Remove the Keps nut from the chassis-ground stud.
- 5 Attach the ring end of the wire to the chassis ground stud, as shown in the graphic to the right.
- 6 Use the Keps nut removed in [Step 4](#) to secure the ground wire to the chassis-ground stud.
- 7 Route the free end of the chassis grounding wire to an approved (per local code or practice) earth ground source.





## Connect the CAP L Cables

The type of cables used and how the CAP L connects into the system is dependent on the CAP L type. Follow the cabling instructions that apply to the unit type that you are installing.

- "Cable a CAP L with an Optical Fiber Interface" on page 37
- "Cable a CAP L with a Copper Interface" on page 40.

### Cable a CAP L with an Optical Fiber Interface

Figure 14 identifies the connectors on a CAP L with an Optical Fiber Interface; corresponding cables and connectors are shown. For details on the ports, see "CAP L with an Optical Fiber Interface" on page 6.



Do not remove caps from any of the connectors until instructed to do so.

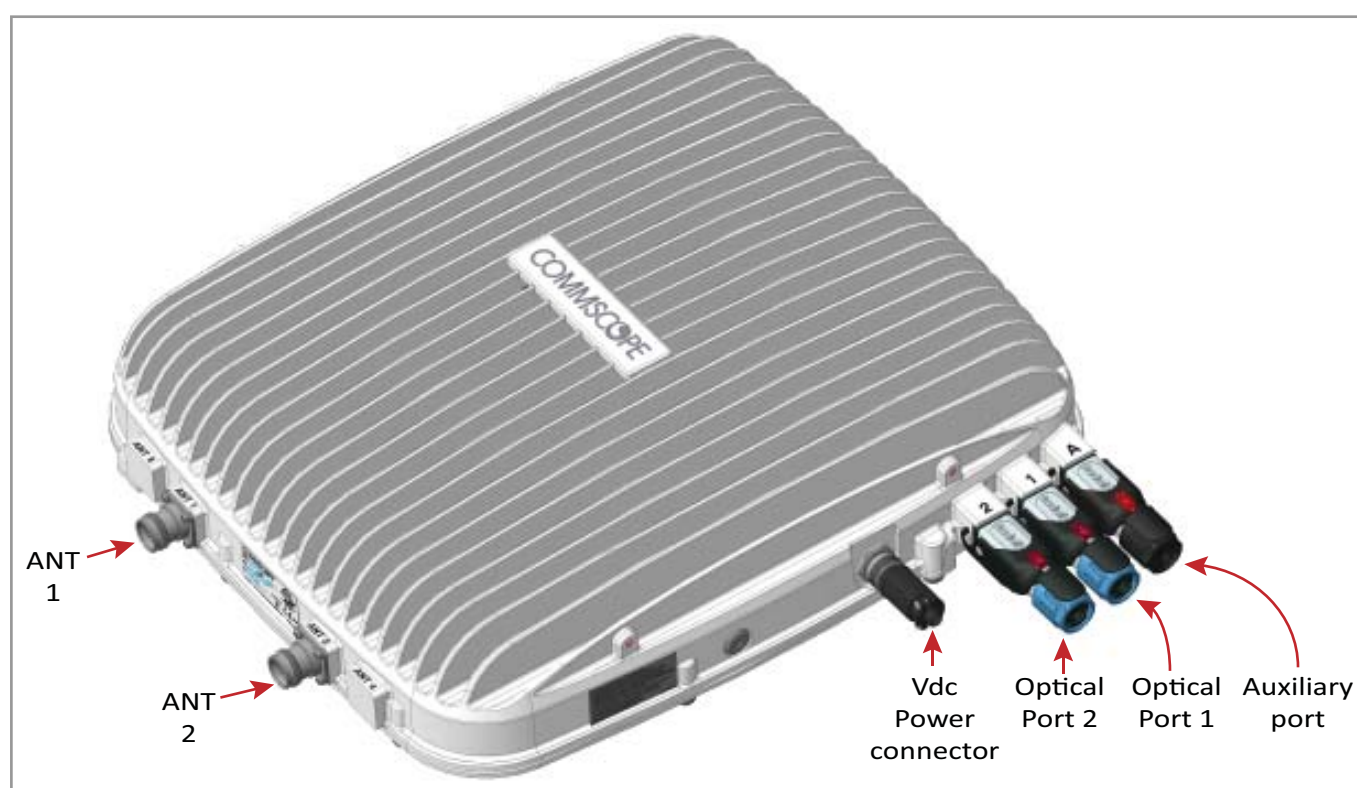

Figure 14. Connectors on a CAP L with an Optical Fiber Interface

- 1 Contact your local CommScope sales representative to obtain the following components, as required, for this installation.
  - Per the installation plan, obtain either Single Mode Fiber (SMF) or Multi Mode Fiber (MMF) that is of sufficient length to reach from the CAP L to the ION-E CAN/TEN
  - Obtain at least one Optical OCTIS Kit (PN 7770612). All installations require one Optical OCTIS Kit. If cascading a Secondary CAP L, a second Optical OCTIS Kit is required.
  - Obtain an SFP+ Module that is appropriate for this installation. [Table 7](#) identifies the available SFP+ Modules and the maximum range for each.

**Table 7.** Supported SFP+ Modules

CommScope PN	Description	Maximum Range		Notes
7660511	ION-E SFP+, 10GBase-SRR, Multi Mode	<b>OM3</b> 300m	<b>OM4</b> 400m	One placed in the TEN and paired with another in the CAN
7680813	ION-E SFP+, 10GBase-LR, Single Mode	10km		One placed in the TEN and paired with another in the CAN

- If connecting an external Ethernet device such as WiFi or IP camera, an Ethernet OCTIS Kit (PN 7760652 RJ-45) and appropriate CAT cable for the protocol to which the CAP L will connect. (This model supports a 1000 BASE-T and 802.3at Class 4 Power over Cat6A Ethernet connection. Follow the rules in "[Cat6A Cable Requirements for CAP Ls with a Copper Interface](#)" on [page 40](#), all Cat6A cable requirements and cable-length rules between a Primary and Secondary CAP L also apply to connecting an external Ethernet device.)
    - A single CAP L can support one auxiliary Ethernet device.
    - A cascaded CAP L pair can support one auxiliary device.
- 2 Connect the CAP L ANT 1 and/or ANT 2 connector to a passive RF antenna.
    - a Obtain 50Ω coaxial cables that are of sufficient length to reach from the CAP L to the passive antenna. The end of the 50Ω coaxial cable that will connect to the ANT connector can be either a push-pull connector or a threaded connector.
    - b Install the passive antennas per the manufacturer's installation instructions. If connecting both ANT connectors, you will connect the CAP L to either two separate external passive antennas or to two ports on a cross-polarized dual antenna. Each connector supports two RF bands (see [Table 8](#)).

**Table 8.** Mapping Frequency Bands to Antennas

Frequency Band	Band Combination	Antenna Port
AWS1700 / LTE2300	17E and 23	1
AWS1700 / LTE2300	17E and 23	2
GSM1800 / UMTS2100 / LTE2600	18 and 26	1
GSM1800 / UMTS2100 / LTE2600	21 and 26	2
AWS1700 / PCS1900	17E and 19	1
AWS1700 / PCS1900	17E and 19	2

- c Remove the IP67/EMI blank plug from the ANT 1/2 connector.
- d Connect the passive multi-band antenna to the ANT 1 or ANT 2 connector using coaxial cable with the least amount of loss possible.
  - If the 50Ω coaxial cable has a push-pull connector, make sure the cable is seated firmly in the ANT 1 or ANT 2 connector.
  - If the 50Ω coaxial cable has a threaded connector, torque the connector 5 N-m (3.69 ft-lb). Do not over-tighten the connector.
- e Connect the other end of the 50Ω coaxial cable to the passive antenna installed in [Step b on page 38](#).

- 3 If necessary, repeat [Step 2 on page 38](#) to connect a 50Ω coaxial cable to the other ANT connector.
- 4 Connect the CAP L Optical Port 1 as appropriate for this installation. Note the maximum range listed in [Table 6 on page 19](#).
  - a Remove the dust cap from the CAP L Optical Port 1 connector and the connectors on the SMF or MMF.
  - b Follow the local cleaning technique to clean Optical Port 1.
  - c Clean the connectors on the SMF or MMF following the fiber supplier's recommendations.
  - d Install the SFP+ connector and Optical OCTIS Kit on the end of the SMF or MMF that will connect to the CAP L, and then connect that end of the fiber to the CAP L Optical Port 1 connector. (Refer to the technical data sheet that ships with the OCTIS Kit for further information.)
  - e Connect the other end of the SMF or MMF to an open port on the OPT Card.



**If installing a CAP L with the CAP L Hybrid Fiber Splice Box Kit (PN 7774354-xx), the optical fiber will be hanging from the Hybrid Fiber Splice Box.**

- 5 If appropriate for this installation, connect the Optical Port 2 connector. Note the maximum range listed in [Table 6 on page 19](#).
  - a Raise the lever on the EMI/IP67 cap on Optical Port 2 connector and remove the cap.
  - b Remove the caps from the connectors on the SMF or MMF.
  - c Follow the local cleaning technique to clean Optical Port 2.
  - d Clean the connectors on the SMF or MMF following the fiber supplier's recommendations.
  - e Install the SFP+ and Optical OCTIS Kit on the end of the fiber that will connect to the CAP L, and connect that end of the SMF or MMF to the CAP L Optical Port 2 connector. (Refer to the technical data sheet that ships with the OCTIS Kit for further information.)
  - f Connect other end of the SMF or MMF to Optical Port 1 on the cascaded CAP L.
- 6 (Optional) Port A (Auxiliary port) provides a connection for external Ethernet devices such as WiFi and IP cameras. Cable Port A as appropriate for this installation.



**Port A must be plugged if not in use.**

- a Raise the lever on the EMI/IP67 cap on Port A and remove the cap.
- b Install the Ethernet OCTIS Kit on the end of the cable that will connect to the CAP L, and then connect that end of the cable to CAP L Port A. (Refer to the technical data sheet that ships with the OCTIS Kit for further information.)



**This cable cannot exceed 3 meters (9.8 feet).**

- c Connect the other end of the CAT cable to the Ethernet port of the auxiliary device.

- 7 Connect the Vdc Power connector as appropriate for this installation.
  - For a CAP L with no local power supply and no hybrid fiber cable, connect a power cable (not supplied by CommScope) to the proprietary 4-pin, 36 to 60 Vdc Power connector on the CAP L.
  - For a CAP L powered by the CAP L Hybrid Fiber Splice Box Kit (PN 7774354-xx) connect the:
    - power cable the proprietary 4-pin, 36 to 60 Vdc Power connector on the CAP L, and terminate the other end to the CAP L Hybrid Fiber Splice Box
    - LC Fiber Jumper to the supplied OCTIS connector, and splice the other end of the fiber jumpers inside the locally-mounted CAP L Hybrid Fiber Splice Box.
  - For a CAP L with the optional AC/DC Power Supply Kit (PN 7775087-xx), connect its Local Power Jumper Cable Assembly to the proprietary 4-pin, 36 to 60 Vdc Power connector on the CAP L.

The CAP L is powered on as soon as you connect the CAP L to a power source; see ["Powering a CAP L" on page 48](#).

## Cable a CAP L with a Copper Interface

All installations of a CAP L with a Copper Interface must follow the rules in ["Cat6A Cable Requirements for CAP Ls with a Copper Interface" on page 40](#). Follow the cabling instructions that apply to the unit type that you are installing.

- ["Cable a CAP L with a Copper Interface and External DC Power" on page 43](#)
- ["Cable a CAP L with a Copper Interface and Power over Cat6A Cable" on page 45](#).

## Cat6A Cable Requirements for CAP Ls with a Copper Interface

The following cabling rules must be observed for all installations of a CAP L with a Copper Interface.



**For information on how to test your Cat6A cables and connections, see ["Cat6A Specifications and Testing Requirements" on page 50](#).**

- Plenum rated cable must be used wherever it is required by local electrical codes.
- Shielded twisted pair is not required unless operating in a high RFI/EMI environment.
- An ION-E system requires a minimum Signal-to-Noise Ratio (SNR) of 25 dB, and Alien Crosstalk (AXT) must not degrade SNR on any cable by more than 0.5dB.
- Cat6A cable wire size requirements are as follows:
  - 23 AWG Cat6A cable (minimum EIA/TIA standards) must be used between RJ-45 connector points
  - 24 AWG is the minimum wire size allowed for a Cat6A Patch Cord.
- CommScope strongly recommends using factory terminated and tested Cat6A Patch Cord.

- There can never be more than two RJ-45 connections in a Cat6A cable run, as described below and as shown in [Figure 15](#). Minimizing these connections improves the link margin.
  - In a non-cascade, between the CAT Card and the AP, there can be
    - one Cat6A Patch Cord at the start of a Cat6A cable run
    - a second Cat6A Patch Cord at the end of a Cat6A cable run.
  - In a cascade, between the Primary AP and the Secondary AP, there can be
    - one Cat6A Patch Cord at the start of a Cat6A cable run
    - a second Cat6A Patch Cord at the end of a Cat6A cable run.

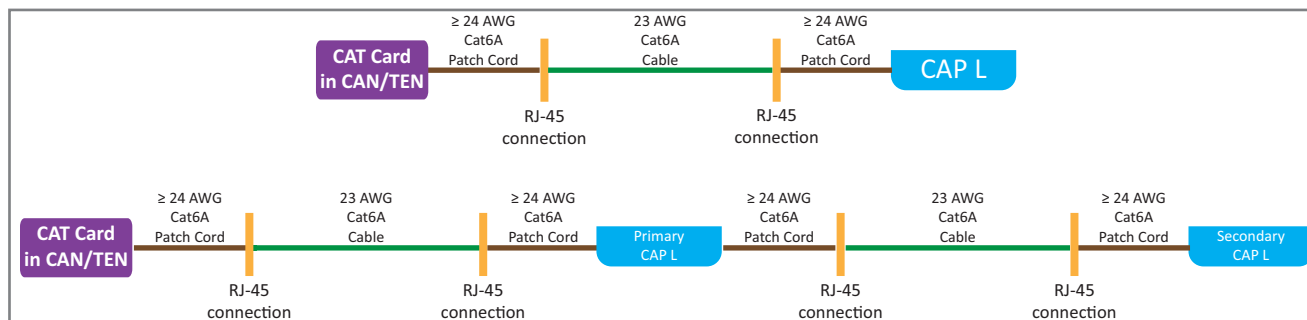
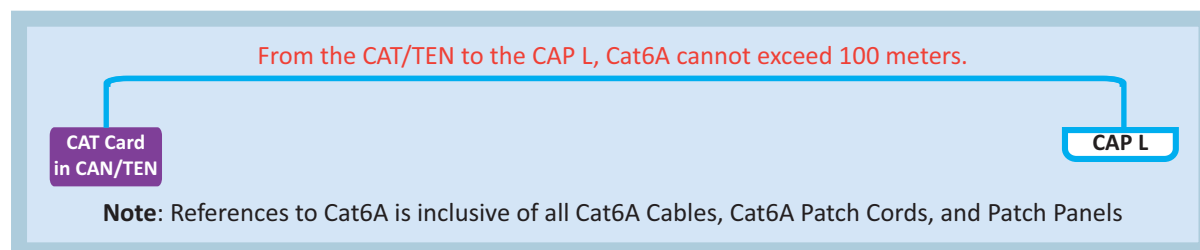

**Figure 15.** Maximum Number of RJ-45 Connections in Cable Runs

- Unshielded Cat6A (Category 6A U/UTP) twisted pair cable that meets ANSI/TIA-568-C.2, CENELEC EN 50173 series, and ISO/IEC 11801:2002 including its amendments 1 and 2, is suitable for use in an ION-E system. The CommScope GigaSPEED X10D® 2091B ETL Verified Category 6A U/UTP Cable (760107201, 2091B BL 4/23 W1000) meets these requirements and is recommended.

There are many parameters that impact the SNR of the 10GBase-T signal received by the CAT Card from the AP, or received by the AP from the CAT Card. For example, excessive insertion loss degrades the signal level, which results in a degraded SNR. An increase in the noise level will also result in degraded SNR. The most common sources of noise are NEXT (near end crosstalk, interference from pairs within a cable that couple from the TX to RX), and AXT (alien crosstalk, interference from adjacent cables). Additionally, there can be interference from outside sources such as lighting, switching power supplies, radio transmitters in the UHF and VHF bands, and similar sources of RFI/EMI. To guarantee acceptable SNR level, all cable key parameters must be measured as discussed in the next section.

- The maximum Cat6A cable length between a CAP L with a Copper Interface and a CAN/TEN is 100 meters including all Cat6A cables, Cat6A Patch Cords, and Patch Panels (see [Figure 16](#)). No more than 5m of Cat6A Patch Cords should be used to connect the CAT Card and a CAP L with a Copper Interface.



**Figure 16.** Maximum Cat6A Cable Lengths from CAT Card to CAP L

- For cascaded CAP Ls, the maximum Cat6A cable length between the AUX port on the Primary CAP L and the MAIN port on the Secondary (cascaded) CAP L, including the length of the Cat6A Patch Cord, must be less than 100 meters (see [Figure 17](#)).



The Secondary CAP L must get its power through the DC connector (either from a local supply or hybrid fiber); power over the Cat6A cable to the cascaded unit is not supported. See "[Cascade Rules](#)" on page 17.

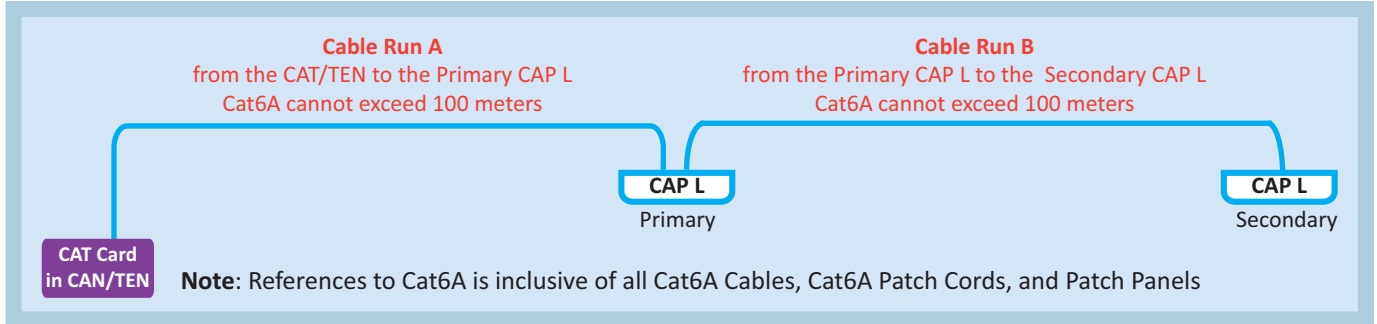

Figure 17. Maximum Cat6A Cable Lengths between Cascaded CAP Ls

- The maximum Cat6A cable length between the AUX port on the CAP L and an auxiliary Ethernet device is 10 meters, including all Cat6A cables, Cat6A Patch Cords, and Patch Panels, as shown in [Figure 18](#). 24 AWG Cat6A cabling is sufficient for the entire cable run, from the CAN/TEN to the auxiliary Ethernet device connection.

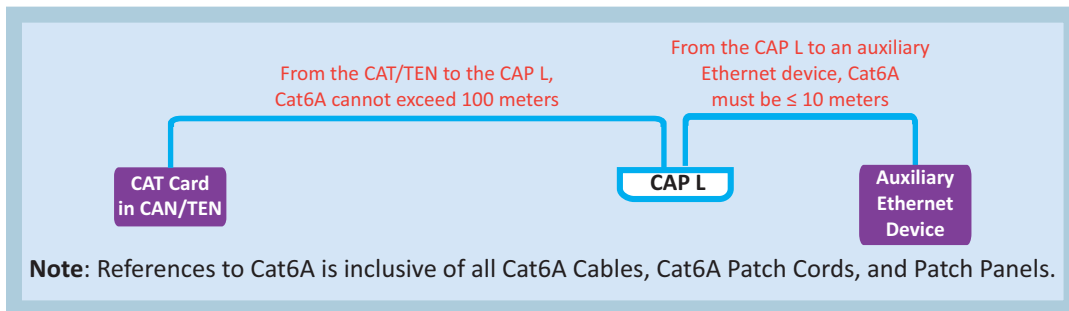
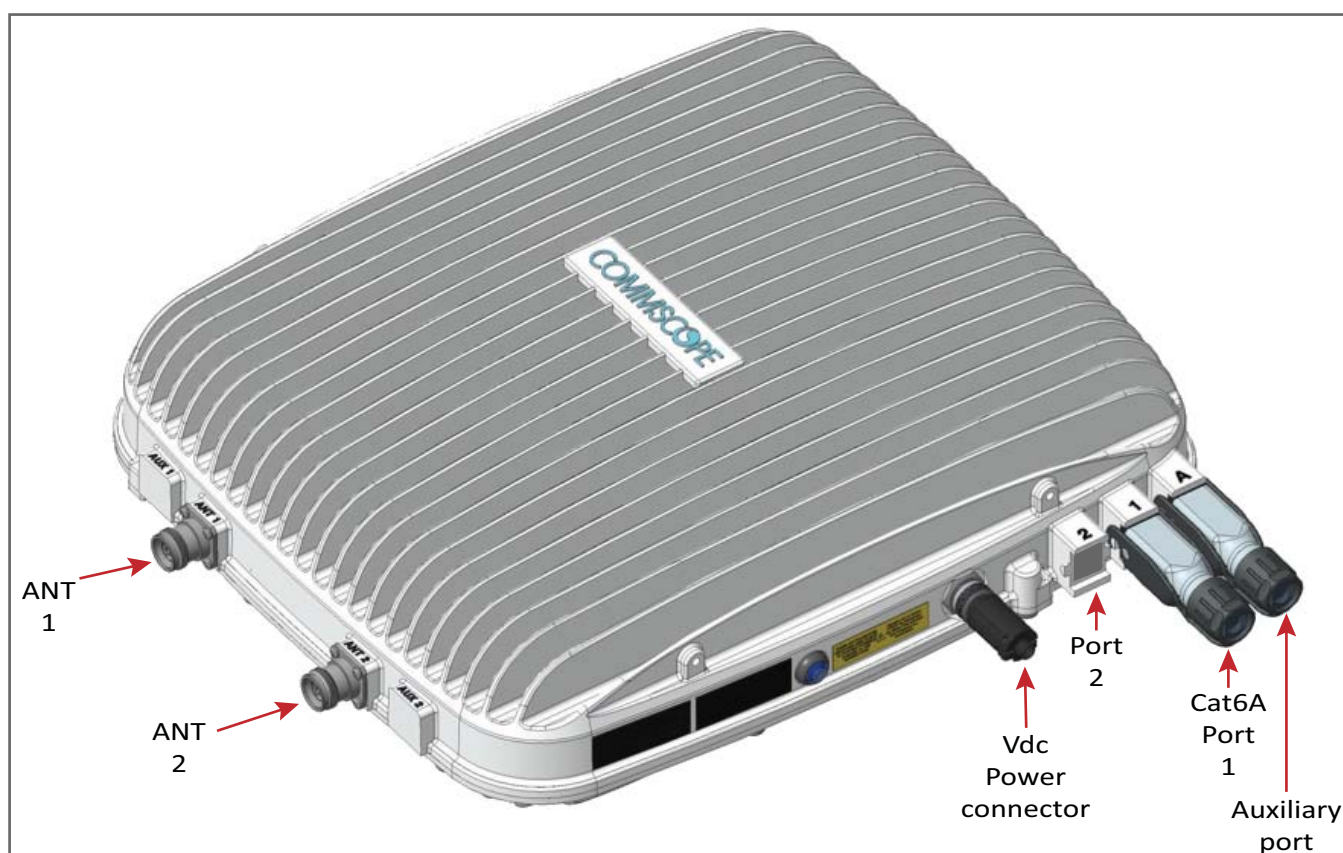

Figure 18. Maximum Cat6A Cable Length between a CAP L and an Ethernet Device



## Cable a CAP L with a Copper Interface and External DC Power

Figure 19 identifies the connectors on a CAP L with a Copper Interface that is powered by an external power source; corresponding cables and connectors are shown. For details on the ports, see "CAP L with a Copper Interface and External DC Power" on page 7.



**Figure 19.** Connectors on a CAP L with a Copper Interface with External DC Power

Do the following to install a CAP L with a Copper Interface that is powered by an external power source.

**1** Obtain the following components, as required for this installation.

- 50 $\Omega$  coaxial cable that is of sufficient length to reach from the CAP L to the passive antenna. The end of the 50 $\Omega$  coaxial cable that will connect to the ANT connector can be either a push-pull connector or a threaded connector.
- Following the rules in "Cat6A Cable Requirements for CAP Ls with a Copper Interface" on page 40, obtain Cat6A cable that is of sufficient length to reach from the CAP L to the ION-E CAN/TEN.
- All installations require one Ethernet OCTIS Kit (PN 7760652 RJ-45). Additional Ethernet OCTIS Kits are required (one each) for cascading a Secondary CAP L and/or connecting an external Ethernet device such as WiFi or an IP camera.
- If connecting to an external Ethernet device such as WiFi or an IP camera, obtain the appropriate CAT cable for the protocol to which the CAP L will connect. This model supports a 1000 BASE-T and 802.3at Class 4 Power over Cat6A Ethernet connection.
  - A single CAP L can support one auxiliary Ethernet device.
  - A cascaded CAP L pair can support one auxiliary device.
  - Follow the rules in "Cat6A Cable Requirements for CAP Ls with a Copper Interface" on page 40, all Cat6A cable requirements and cable-length rules between a Primary and Secondary CAP L also apply to connecting an external Ethernet device.



- 2 Connect the CAP L ANT 1 and/or ANT 2 connector to a passive RF antenna.
  - a Install the passive antennas per the manufacturer's installation instructions. If connecting both ANT connectors, you will connect the CAP L to either two separate external passive antennas or to two ports on a cross-polarized dual antenna. Each connector supports two RF bands (see [Table 1 on page 1](#)).
  - b Remove the plastic-protective cap from the 4.3-10 connectors.
  - c Remove the IP67/EMI blank plug from ANT 1/2 connector.
  - d Connect the passive multi-band antenna to the ANT 1 or ANT 2 connector using coaxial cable with the least amount of loss possible.
    - If the 50 $\Omega$  coaxial cable has a push-pull connector, make sure the cable is seated firmly in the ANT 1 or ANT 2 connector.
    - If the 50 $\Omega$  coaxial cable has a threaded connector, torque the connector 5 N-m (3.69 ft-lb). Do not over-tighten the connector.
  - e Connect the other end of the 50 $\Omega$  coaxial cable to the passive antenna installed in [Step a](#).
- 3 If necessary, repeat [Step 2](#) to connect a 50 $\Omega$  coaxial cable to the other ANT connector.
- 4 Connect the CAP L Port 1 connector as appropriate for this installation.
  - a Remove the dust cap from the Port 1 connector.
  - b Install the Ethernet OCTIS Kit on the end of the cable that will connect to the CAP L. (Refer to the technical data sheet that ships with the OCTIS Kit for further information.)
  - c Connect one end of the Cat6A cable to the Port 1 connector and the other end to an available port on a CAT Card in the CAN/TEN.



**Port 2 is plugged as it is not used in this configuration.**

- 5 (Optional) Port A (Auxiliary port) provides a cascade connection to an optional locally powered cascaded CAP L, or provides a connection to external Ethernet devices such as WiFi and IP cameras. Cable Port A as appropriate for this installation.



**Port A must be plugged if not in use.**

- a Raise the lever on the EMI/IP67 cap on Port A and remove the cap.
- b Install the Ethernet OCTIS Kit on the end of the cable that will connect to the CAP L, and then connect that end of the cable to CAP L Port A. (Refer to the technical data sheet that ships with the OCTIS Kit for further information.)
- c Connect the other end of the CAT cable to the Ethernet port of the auxiliary device.

- 6 Connect the Vdc Power connector as appropriate for this installation.
- For a CAP L with no local power supply and no hybrid fiber cable, connect a power cable (not supplied by CommScope) to the proprietary 4-pin, 36 to 60 Vdc Power connector on the CAP L.
  - For a CAP L powered by the CAP L Hybrid Fiber Splice Box Kit (PN 7774354-xx), connect the:
    - power cable to the proprietary 4-pin, 36 to 60 Vdc Power connector on the CAP L, and terminate the other end in the Hybrid Fiber Splice Box
    - LC Fiber Jumper to the supplied OCTIS connector, and splice the other end of the fiber jumpers inside the locally-mounted CAP L Hybrid Fiber Splice Box.
  - For a CAP L with the optional AC/DC Power Supply Kit (PN 7775087-xx), connect its Local Power Jumper Cable Assembly to the proprietary 4-pin, 36 to 60 Vdc Power connector on the CAP L.

The CAP L is powered on as soon as you connect the Local Power Jumper Cable Assembly to a power source; see ["Powering a CAP L" on page 48](#).

### Cable a CAP L with a Copper Interface and Power over Cat6A Cable

[Figure 20](#) identifies the connectors on a CAP L with Copper Interface; corresponding cables and connectors are shown. For details on the ports, see ["CAP L with a Copper Interface and Power Cat6A Cable" on page 8](#).

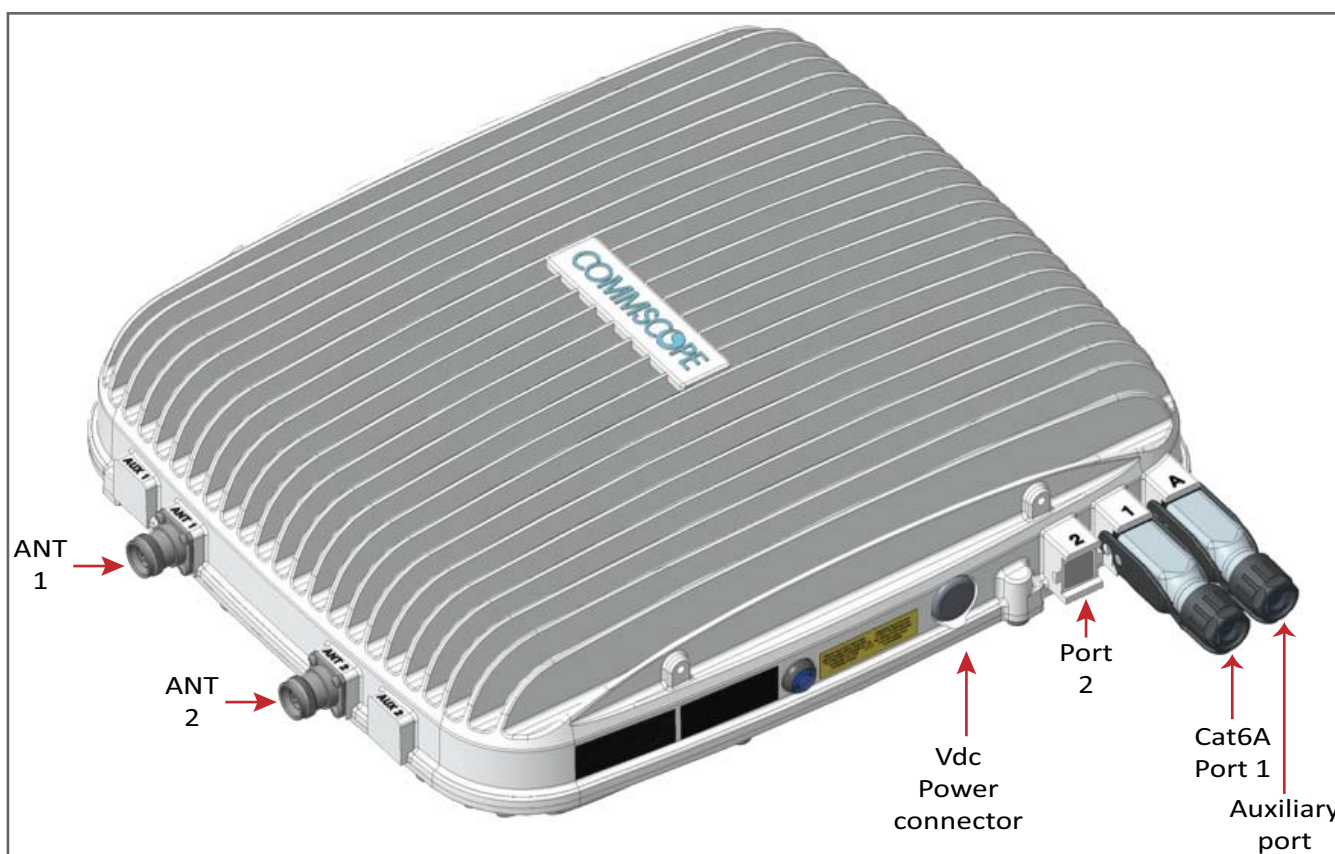

**Figure 20.** Connectors on a CAP L with a Copper Interface

Do the following to install a CAP L with a Copper Interface that is powered over a Cat6A cable.

- 1 Obtain the following components, as required for this installation.
  - 50 $\Omega$  coaxial cable that is of sufficient length to reach from the CAP L to the passive antenna. The end of the 50 $\Omega$  coaxial cable that will connect to the ANT connector can be either a push-pull connector or a threaded connector.
  - Following the rules in "[Cat6A Cable Requirements for CAP Ls with a Copper Interface](#)" on page 40, obtain Cat6A cable that is of sufficient length to reach from the CAP L to the ION-E CAN/TEN.
  - All installations require one Ethernet OCTIS Kit (PN 7760652 RJ-45). Additional Ethernet OCTIS Kits are required (one each) for cascading a Secondary CAP L and/or connecting an external Ethernet device such as WiFi or an IP camera.
  - If connecting to an external Ethernet device such as WiFi or an IP camera, obtain the appropriate CAT cable for the protocol to which the CAP L will connect. This model supports a 1000 BASE-T and 802.3at Class 4 Power over Cat6A Ethernet connection.
    - A single CAP L can support one auxiliary Ethernet device.
    - A cascaded CAP L pair can support one auxiliary device.
    - Follow the rules in "[Cat6A Cable Requirements for CAP Ls with a Copper Interface](#)" on page 40, all Cat6A cable requirements and cable-length rules between a Primary and Secondary CAP L also apply to connecting an external Ethernet device.
- 2 Connect the CAP L ANT 1 and/or ANT 2 connector to a passive RF antenna.
  - a Install the passive antennas per the manufacturer's installation instructions. If connecting both ANT connectors, you will connect the CAP L to either two separate external passive antennas or to two ports on a cross-polarized dual antenna. Each connector supports two RF bands (see [Table 1 on page 1](#)).
  - b Remove the plastic-protective cap from the 4.3-10 connectors.
  - c Remove the IP67/EMI blank plug from ANT 1/2.
  - d Connect the passive multi-band antenna to the ANT 1 or ANT 2 connector using coaxial cable with the least amount of loss possible.
    - If the 50 $\Omega$  coaxial cable has a push-pull connector, make sure the cable is seated firmly in the ANT 1 or ANT 2 connector.
    - If the 50 $\Omega$  coaxial cable has a threaded connector, torque the connector 5 N-m (3.69 ft-lb). Do not over-tighten the connector.
  - e Connect the other end of the 50 $\Omega$  coaxial cable to the passive antenna installed in [Step a on page 46](#).
- 3 If necessary, repeat [Step 2 on page 46](#) to connect a 50 $\Omega$  coaxial cable to the other ANT connector.



**The Power connector and the Port 2 connector are plugged as they are not used in this configuration.**

- 4 Connect the CAP L Port 1 connector as appropriate for this installation.
  - a Following the rules in ["Cat6A Cable Requirements for CAP Ls with a Copper Interface"](#) on page 40, obtain Cat6A cable that is of sufficient length to reach from the CAP L to the ION-E CAN/TEN.
  - b Remove the dust cap from the Port 1 connector.
  - c Follow the local cleaning technique to clean Port 1.
  - d Install an Ethernet OCTIS Kit to an end of the Cat6A cable, and then connect that end of the cable to CAP L Port 1 connector. (Refer to the technical data sheet that ships with the OCTIS Kit for further information.)
  - e Connect the other end the Cat6A cable to an available port on a CAT Card in the CAN/TEN.



**Port 2 is plugged as it is not used in this configuration.**

- 5 (Optional) Port A (Auxiliary port) provides a cascade connection to an optional locally powered Secondary CAP L, or provides a connection to external Ethernet devices such as WiFi and IP cameras. Cable Port A as appropriate for this installation.



**Port A must be plugged if not in use.**

- a Raise the lever on the EMI/IP67 cap on Port A and remove the cap.
  - b Install an Ethernet OCTIS Kit on the end of the cable that will connect to the CAP L, and then connect that end of the cable to CAP L Port A. (Refer to the technical data sheet that ships with the OCTIS Kit for further information.)
  - c Connect the other end of the cable to the Ethernet port of the auxiliary device.
- 6 Connect the Vdc Power connector as appropriate for this installation.
    - For a CAP L with no local power supply and no hybrid fiber cable, connect a power cable (not supplied by CommScope) to the proprietary 4-pin, 36 to 60 Vdc Power connector on the CAP L.
    - For a CAP L powered by the CAP L Hybrid Fiber Splice Box (PN 7774354-xx), connect the power cable the proprietary 4-pin, 36 to 60 Vdc Power connector on the CAP L, and terminate the other end in the Hybrid Fiber Splice Box. Connect the LC Fiber Jumper to supplied OCTIS connector, and splice the other end of the fiber jumpers inside the locally-mounted Hybrid Fiber Splice Box.
    - For a CAP L with the optional AC/DC Power Supply Kit (PN 7775087-xx), connect its Local Power Jumper Cable Assembly to the proprietary 4-pin, 36 to 60 Vdc Power connector on the CAP L.

The CAP L is powered on as soon as you connect the Local Power Jumper Cable Assembly to a power source; see ["Powering a CAP L"](#) on page 48.

## Powering a CAP L

The CAP L is powered on as soon as power is connected to it. Under normal operating conditions, the Power LED turns on briefly when the unit is first detected. It will then go out briefly, followed by an initialization period during which the Power LED flashes slowly while the CAP L is configured. The Power LED remains a steady blue (not flashing) once the unit reaches a fully operational state, which typically occurs within 45 seconds.

### Power LED Behavior

- Power LED behavior for a CAP L with a Fiber Interface
  - Off—CAP L is not powered on.
  - Steady blue—CAP L is powered on and operational.
  - Slow flashing blue—CAP L is powered on and initializing.
  - Rapid flashing blue—CAP L Unit Identifier active via the **Flash LED** function in the ION-E GUI.
- Power LED behavior for a CAP L with a Copper Interface
  - Off—CAP L is not powered on.
  - Steady blue—CAP L is powered on and operational.
  - Slow flashing blue—CAP L is powered on and initializing.
  - Rapid flashing blue—CAP L Unit Identifier active via the **Flash LED** function in the ION-E GUI.
  - Slow pulse blue (ION-E Software V2.3 or later only)—if the Power LED cycles through a slow increase in brightness for 1 second followed by a slow decrease in brightness for 1 second, the CAP L is powered on but is currently unable to establish a 10 Gbps data link to the WCS Subrack. There are two possible causes:
    - There is an installation problem, such as a defective cable or connector, a cable that is too long, or a cable crosstalk problem. Any of these problems can lead to inadequate SNR at the remote unit and an inability to link. (This is the most likely cause if this is a newly-installed unit.)
    - This condition can also be triggered when a crystal oscillator has aged over the course of several years. In this case, the failure to link at startup will initiate a self-calibration process which can take several minutes. Once this self-calibration is complete, the unit will resume normal operation. (This is the most likely cause for units that have worked correctly in the past.)

### Using the Power-Down Button

- If you press the CAP L Power-Down button, the CAP L will go into sleep mode. This allows you to safely disconnect any cables connected to the CAP L.
- If you press the Power-Down button, the only way to bring the CAP L back to a fully operational state, is to do one of the following:
  - Disconnect the data cable from Port 1, and then reconnect it.
  - For an externally-powered CAP L, remove the power cable for 10 seconds, and then reconnect it.

## CAP L MAINTENANCE

The following sections tell you how to remove a CAP L from mounting brackets, and provides preventative maintenance instructions.

### Remove a CAP L from a Wall or Ceiling Mount

Should you need to remove the CAP L from a wall or ceiling mount, do the following.

- 1 For CAP Ls with a Copper Interface only; if removing a CAP L with a Fiber Interface, skip to [Step 2](#).
  - a Press the CAP L Power pushbutton to place the CAP L into a low-power sleep state, which allows you to safely unplug the CAP L without a power arc.



**If you are removing a CAP L with a Copper Interface, you must always press the Power button to power off the CAP L prior to disconnecting its Power cable.**

- b Make sure the blue Power LED is off.
- 2 Unplug the CAP L cables.
- 3 If a ground wire is installed, loosen the grounding screw and remove the ground wire.
- 4 Reverse the installation steps that correspond to how this CAP L is mounted.

### Preventative CAP L Maintenance for CAP Ls with the Fan Kit Option

The CAP L does not require extensive preventative maintenance measures. However, checking the cleanliness of a CAP L that has the Fan Kit option at regularly-scheduled intervals is recommended, particularly the enclosure vents, which helps maintain the longevity of the fans and heat sinks. [Figure 21](#) shows two different CAP L configurations to help you find the enclosure vents.

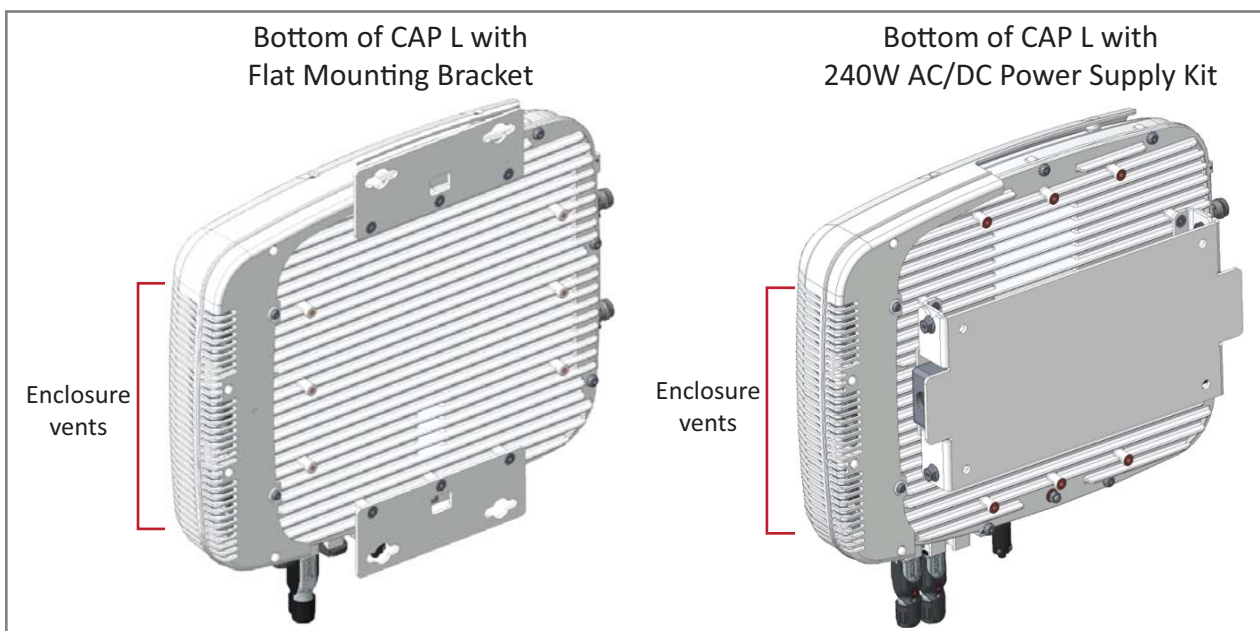
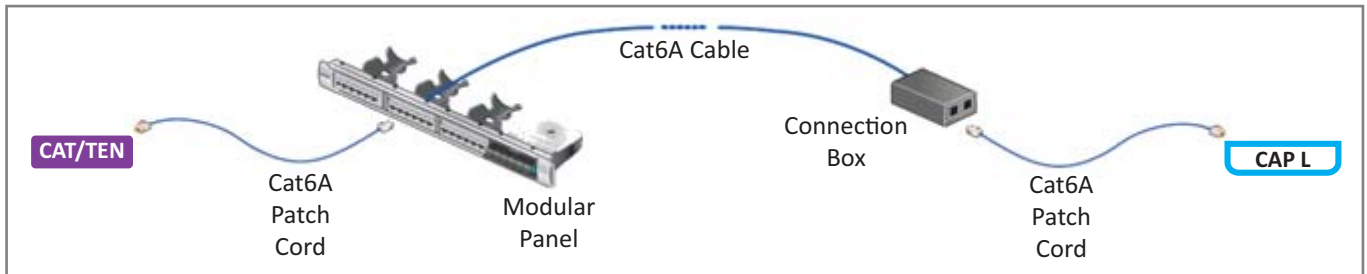

**Figure 21.** Examples of CAP L Fan Vent Locations



# CAT6A SPECIFICATIONS AND TESTING REQUIREMENTS

Cat6A connections must be tested with a device that can measure the cable parameters against the thresholds defined in ANSI/TIA standards (such as the Fluke DTX-1800 and DSX-5000). [Figure 22](#) shows the end-to-end channel from the CAN/TEN to the CAP L, which is inclusive of the Cat6A cable, the Cat6A Patch Cord, and the Panel and connection box. The end-to-end channel must meet the Cat6A U/UTP performance defined by the TIA/EIA 568 C.2 standard; see [Table 9 on page 50](#).



**Figure 22.** ION-E End-to-End Channel



Some cables list their performance in “typical” performance values. However, sweep-testing is necessary to confirm actual performance. CommScope strongly recommends using Cat6A cable that has been tested to the listed frequency with test confirmation available for inspection.

**Table 9.** Cat6A U/UTP Performance Standards (TIA/EIA 568 C.2)

MHz	Insertion Loss (dB) Channel/Link	NEXT (dB) Channel/Link	PSum NEXT (dB) Channel/Link	ACRF (dB) Channel/Link	PSum ACRF (dB) Channel/Link	Return Loss (dB) Channel/Link
1	2.3/1.9	65.0/65.0	62.0/62.0	63.3/64.2	60.3/61.2	19.0/19.1
4	4.2/3.5	63.0/64.1	60.5/61.8	51.2/52.1	48.2/49.1	19.0/21.0
8	5.8/5.0	58.2/59.4	55.6/57.0	45.2/46.1	42.2/43.1	19.0/21.0
10	6.5/5.5	56.6/57.8	54.0/55.5	43.3/44.2	40.3/41.2	19.0/21.0
16	8.2/7.0	53.2/54.6	50.6/52.2	39.2/40.1	36.2/37.1	18.0/20.0
20	9.2/7.8	51.6/53.1	49.0/50.7	37.2/38.2	34.2/35.2	17.5/19.5
25	10.2/8.8	50.0/51.5	47.3/49.1	35.3/36.2	32.3/33.2	17.0/19.0
31.25	11.5/9.8	48.4/50.0	45.7/47.5	33.4/34.3	30.4/31.3	16.5/18.5
62.5	16.4/14.1	43.4/45.1	40.6/42.7	27.3/28.3	24.3/25.3	14.0/16.0
100	20.9/18.0	39.9/41.8	37.1/39.3	23.3/24.2	20.3/21.2	12.0/14.0
200	30.1/26.1	34.8/36.9	31.9/34.3	17.2/18.2	14.2/15.2	9.0/11.0
250	33.9/29.5	33.1/35.3	30.2/32.7	15.3/16.2	12.3/13.2	8.0/10.0
300	37.4/32.7	31.7/34.0	28.8/31.4	13.7/14.6	10.7/11.6	7.2/9.2
400	43.7/38.5	28.7/29.9	25.8/27.1	11.2/12.1	8.2/9.1	6.0/8.0
500	49.3/43.8	26.1/26.7	23.2/23.8	9.3/10.2	6.3/7.2	6.0/8.0



Propagation Delay is 555 nanoseconds for channel/498 nanoseconds for link tested at 10 MHz.



Delay Skew is 50 nanoseconds for channel/44 nanoseconds for link tested at 10 MHz.



For additional information, see also *CommScope Product Specifications for the GigaSPEED X10D® 2091B ETL Verified Category 6A U/UTP Cable (760107201 | 2091B BL 4/23 W1000)*. (Click [here](#) access the document online.)



## CONTACTING COMMSCOPE

The following sections tell you how to contact CommScope for additional information or for assistance.

### DCCS Global Technical Support

The following sections tell you how to contact the CommScope Distributed Coverage and Capacity Solutions (DCCS) Technical Support team. Support is available 7 days a week, 24 hours a day.

#### Telephone Helplines

Use the following Helpline telephone numbers to get live support, 24 hours a day:

- 24x7** +1 888-297-6433 (Toll free for U.S. and Canada)
- EMEA 8:00-17:00 (UTC +1)** + 800 73732837 (Toll free for parts of EMEA and Australia)  
+ 49 909969333 (Toll charge incurred)

Calls to an EMEA Helpline outside of the 8:00 to 17:00 time frame will be forwarded to the 24x7 Helpline.

#### Online Support

To go to the CommScope DCCS Support Request web site from which you can initiate a Technical Support ticket, do one of the following:

- Scan the QR Code to the right.
- If viewing this document online as a PDF, click on the following URL link:  
<http://www.commscope.com/wisupport>
- Enter the preceding URL into your web browser, and then press **ENTER** on your keyboard.



### Waste Electrical and Electronic Equipment Recycling

Country specific information about collection and recycling arrangements per the Waste Electrical and Electronic Equipment (WEEE) Directive and implementing regulations is available on CommScope's website.

To access information on the CommScope recycling program, do any of the following:

- Scan the QR Code to the right.
- If viewing this document online as a PDF, click on the following URL link:  
<http://www.commscope.com/About-Us/Corporate-Responsibility-and-Sustainability/Environment/Recycling/>
- Enter the preceding URL into your web browser, and then press **ENTER** on your keyboard.



## Hardware to Software Mapping Information

- 1 Scan the QR Code to the right to view or download the minimum software requirements for each of the DCCS hardware modules. Alternatively, you can go to the following web address to access the portal:



[http://www.commscope.com/collateral/DCCS\\_HW\\_SW\\_Mapping/](http://www.commscope.com/collateral/DCCS_HW_SW_Mapping/)

- 2 Click on a document link to open it, or right click on the link and select the **Save target as...** option from the contextual menu.

## DCCS Technical Training

- 1 To access training on the online CommScope DAS and Small Cell Institute, do one of the following:
  - Scan the QR Code to the right.
  - If viewing this document online as a PDF, click on the following URL link.  
<http://www.commscopetraining.com/courses/dassc/>
  - Enter the preceding URL into your web browser, and then press **ENTER** on your keyboard.
- 2 Review the courses listed in separate course panels; for further information on a course, click its **Full details** button. Instructor-led courses are conducted in North America and Europe. Before choosing a course, please verify the region.
- 3 To view the course schedule and register, click **Course Registration** at the top of the course page; this opens the **Partner Learning Center Login** page.
  - If you have an account, enter your **Username** and **Password**, and then click **Login**. (Click on the **Reset Password** link if you do not have your login information.)
  - If you don't have an account, click on the **Create New User Account** link under the **Login** button, and follow the prompts.



Once you have logged in, you will see a list of available class dates.

- 4 Click the date you prefer and select the **Enroll** or **Register Now** button to enroll. Follow the prompts through the payment process.
- 5 Click either the **Available Training** or **Calendar** tab to view other training courses.

For training related questions, please contact the CommScope DAS and Small Cell Institute at one of the following emails, as appropriate for your location:

**Americas:** DASTrainingUS@CommScope.com

**EMEA:** DASTrainingEMEA@CommScope.com

## Accessing ION-E Series User Documentation



- 1 Scan the QR Code to the right to go directly to the CommScope DCCS Customer Portal, where you can access the DCCS user documentation.

Alternatively, you can go to the following web address to access the portal:

<https://www.mycommscope.com>

- 2 Access to the Customer Portal requires a user account and password. On the Sign In page, do one of the following:
  - If you have an account, enter your Email address and Password, and then click Sign In.
  - If you don't have an account, click New user registration, and follow the prompts.
- 3 Click DCCS to open the site.
- 4 Select your site, and then click on a product link to open the product page.
- 5 Click on the title of any document to open it.

