

Optical Remote Unit

ION™-M17P/17P/17P (M-Cabinet)



User's Manual
MF0143AWA

© Copyright 2011 CommScope, Inc.

All rights reserved.

Andrew Solutions is a trademark of CommScope, Inc.

All information contained in this manual has been revised thoroughly. Yet Andrew Solutions accepts no liability for any omissions or faults.

Andrew Solutions reserves the right to change all hard- and software characteristics without notice.

Names of products mentioned herein are used for identification purposes only and may be trademarks and / or registered trademarks of their respective companies.

No parts of this publication may be reproduced, stored in a retrieval system, transmitted in any form or by any means, electronical, mechanical photocopying, recording or otherwise, without prior written permission of the publisher.

Andrew Wireless Systems GmbH, 20-October-2011

TABLE OF CONTENTS

1. GENERAL	5
1.1. USED ABBREVIATIONS	5
1.2. HEALTH AND SAFETY WARNINGS	6
1.3. ABOUT ANDREW SOLUTIONS	8
1.4. INTERNATIONAL CONTACT ADDRESSES FOR CUSTOMER SUPPORT	9
2. FUNCTIONAL DESCRIPTION	11
2.1. PURPOSE	11
2.2. ION-M17P/17P/17P	11
2.3. COMPONENTS OF THE ION-M17P/17P/17P REMOTE UNIT	12
2.3.1. Fan-Protection Kit	12
2.3.2. Accessories	12
3. COMMISSIONING	14
3.1. MECHANICAL INSTALLATION	14
3.1.1. General	14
3.1.2. Wall-Mounting Procedure	16
3.1.3. Pole-Mounting Procedure	17
3.1.4. Mounting of Fan Protection	19
3.2. ELECTRICAL INSTALLATION	20
3.2.1. General	20
3.2.2. Connections	21
3.2.3. Grounding	22
3.2.4. Connection of the Antenna Cables	23
3.2.5. Power Connection	24
3.3. OPTICAL-FIBRE-CABLE CONNECTION - RULES	25
3.3.1. Protective Plug	26
3.3.2. Protective-Tube Kit	28
3.4. COMMISSIONING	30
4. ALARMS	34
4.1. BITE AND ALARMS	34
4.2. HANDLING OF ALARMS	34
4.3. ALARM STATUS	34
4.4. STATUS LED ALARMS	35
4.5. EXTERNAL ALARM INPUTS AND OUTPUTS	36
4.6. TROUBLESHOOTING	37
5. MAINTENANCE	38
5.1. GENERAL	38
5.2. REPLACING THE FAN UNIT	39

5.3.	CLEANING THE HEAT SINK	41
6.	APPENDIX	42
6.1.	ILLUSTRATIONS	42
6.2.	SPECIFICATIONS	43
6.2.1.	Electrical Specifications	43
6.2.2.	Environmental and Safety Specifications	43
6.2.3.	Mechanical Specifications	43
6.3.	SPARE PARTS	44
7.	INDEX	45

FIGURES AND TABLES

figure 3-1	Wall mounting, (metric dimensions).....	16
figure 3-2	Pole-mounting kit.....	17
figure 3-3	Pole mounting (metric dimensions)	18
figure 3-4	Mounting procedure for fan protection, (metric dimensions).....	19
figure 3-5	Connector flange of ION-M17P/17P/17P	21
figure 3-6	RS232 connector.....	22
figure 3-7	Grounding bolt with loosened hex nut	22
figure 3-8	Grounding bolt, schematic view.....	22
figure 3-9	AC mains plug	24
figure 3-10	Protective-plug assembly	26
figure 3-11	Tube-kit installation.....	29
figure 4-1	Flange connector, 5 poles	36
figure 4-2	Flange connector, 7 poles	36
figure 4-3	Alarm inputs and outputs, standard	37
figure 6-1	Installation drawing.....	42
table 1-1	List of international contact addresses.....	10
table 3-1	Specified torques.....	15
table 3-2	RS232 connector, pin assignment.....	22
table 4-1	Status LED alarms.....	35

1. GENERAL

1.1. USED ABBREVIATIONS

3GPP	3 rd Generation Partnership Project
AC	Alternating current / Direct Current
AIMOS	Andrew Integrated Management and Operating System
ALC	Automatic Level Control
BITE	Built-In Test Equipment
BTS	Base Transceiver Station
CE	"Conformité Européenne" ("European Conformity")
CD	Compact Disk
CPD	Channel Power Detection
DL	Downlink
DoC	Declaration of Conformity
EDGE	Enhanced Data Rates for GSM Evolution
EN	European Norm
EP	Extension Port
ESD	Electrostatic Discharge
ETS	European Telecommunication Standard
EU	Extension Unit
FRU	Field Replaceable Unit
GSM	Global System for Mobile Communication
GND	Ground
GUI	Graphical User Interface
ICP3	Intercept Point 3 rd order
ID No	Identification Number
ION	Intelligent Optical Network
IP	Ingress Protection
ISO	International Organization for Standardization
LED	Light Emitting Diode
LMT	Local Maintenance Terminal
LTE	Long Term Evolution
MIMO	Multiple Input Multiple Output
MS	Mobile Station
MU	Main Unit
NF	Noise Figure
OTRx	Optical Transceiver = SRMU (Subrack Master Unit)
PG	Packing Gland
PIM	Passive Intermodulation
R&TTE	Radio & Telecommunications Terminal Equipment
Rev	Revision
RF	Radio Frequency
RU	Remote Unit
RX	Receiver
SNMP	Simple Network Management Protocol
TS	Technical Specification
TX	Transmitter
UL	Uplink
UMTS	Universal Mobile Telecommunication System
UPS	Uninterruptible Power Supply
VSWR	Voltage Standing Wave Ratio
W CDMA	Wideband Code Division Multiple Access
WDM	Wavelength Division Multiplex

1.2. HEALTH AND SAFETY WARNINGS



1. Only suitably qualified personnel is allowed to work on this unit and only after becoming familiar with all safety notices, installation, operation and maintenance procedures contained in this manual.
2. Read and obey all the warning labels attached to the unit. Make sure that the warning labels are kept in a legible condition and replace any missing or damaged labels.
3. Obey all general and regional installation and safety regulations relating to work on high voltage installations, as well as regulations covering correct use of tools and personal protective equipment.
4. Keep operating instructions within easy reach and make them available to all users.
5. It is the responsibility of the network provider to implement prevention measures to avoid health hazards which may be associated to radiation from the antenna(s) connected to the unit.
6. **Note for a Class A digital device or peripheral:**

This equipment has been tested and found to comply with the limits for a Class A digital device, pursuant to part 15 of the FCC Rules. These limits are designed to provide reasonable protection against harmful interference when the equipment is operated in a commercial environment. This equipment generates, uses, and can radiate radio frequency energy and, if not installed and used in accordance with the instruction manual, may cause harmful interference to radio communications. Operation of this equipment in a residential area is likely to cause harmful interference in which case the user will be required to correct the interference at his own expense.
7. Make sure, access is restricted to qualified personnel.
8. Only licence holders for the respective frequency range are allowed to operate this unit.
9. Corresponding local particularities and regulations must be observed. For national deviations please refer to the respective documents included in the manual CD delivered.
10. Use this equipment only for the purpose specified by the manufacturer. Do not carry out any modifications or fit any spare parts which are not sold or recommended by the manufacturer. This could cause fires, electric shock or other injuries.
11. Due to power dissipation, the repeater may reach a very high temperature. Do not operate this equipment on or close to flammable materials.

12. Before opening the unit, disconnect mains.



13. ESD precautions must be observed! Before commencing maintenance work, use the available grounding system to connect ESD protection measures.

14. This unit complies with European standard EN60950.

15. Make sure the repeater settings are according to the intended use (see also product information of manufacturer) and regulatory requirements are met.

16. Although the repeater is internally protected against overvoltage, it is strongly recommended to earth the antenna cables close to the repeater's antenna connectors for protection against atmospheric discharge.



17. Laser radiation! Do not stare into the beam; do not view it directly or with optical instruments.

1.3. ABOUT ANDREW SOLUTIONS

Andrew Wireless Systems GmbH based in Buchdorf/ Germany, is a leading manufacturer of coverage equipment for mobile radio networks, specializing in high performance, RF and optical repeaters. Our optical distributed networks and RF repeater systems provide coverage for every application: outdoor use, indoor installations, tunnels, subways and many more.

Andrew Wireless Systems GmbH has unparalleled experience in providing RF coverage and capacity solution for wireless networks in both indoor and outdoor environment and belongs to *Andrew Solutions, a CommScope Company*.

Andrew Solutions is the foremost supplier of one-stop, end-to-end radio frequency (RF) solutions. Our products are complete solutions for wireless infrastructure from top-of-the-tower base station antennas to cable systems and cabinets, RF site solutions, signal distribution, and network optimization.

Andrew Solutions has global engineering and manufacturing facilities. In addition, it maintains field engineering offices throughout the world.

We operate a quality management system in compliance with the requirements of ISO 9001. All equipment is manufactured using highly reliable material. In order to ensure constant first-rate quality of the products, comprehensive quality monitoring is conducted at all fabrication stages. Finished products leave the factory only after a thorough final acceptance test, accompanied by a test certificate guaranteeing optimal operation.

Note: **Exceptions of and national deviations from this intended use may be possible. To observe corresponding local particularities and regulations, please refer to the respective documents (also in national language) which are included in the manual CD delivered.**

To make the most of this product, we recommend you carefully read the instructions in this manual and commission the system only according to these instructions.

For technical assistance and support, please also contact the local office or *Andrew Solutions* directly at one of the addresses listed in the following chapter.

1.4. INTERNATIONAL CONTACT ADDRESSES FOR CUSTOMER SUPPORT**Americas:**

Canada	
Andrew Solutions Canada	
Mail	620 North Greenfield Parkway Garner, NC 27529 U.S.A.
Phone	+1-905-878-3457 (Office) +1-416-721-5058 (Mobile)
Fax	+1-905-878-3297
E-mail	Peter.Masih@commscope.com, Wlsupport.us@commscope.com

United States	
Andrew Solutions, Andrew LLC, A CommScope Company	
Mail	620 North Greenfield Parkway Garner, NC 27529 U.S.A.
Phone	+1-888-297-6433
Fax	+1-919-329-8950
E-mail	Wlsupport.us@commscope.com

Brazil & South America	
CommScope Cabos do Brasil Ltda.	
Mail	Av. Com. Camilo Julio 1256 Zonal Industrial CP 597 Sorocaba SP 18086-000 Brazil
Phone	+ 55-15-9104-7722
Fax	+ 55-15-2102-4001
E-mail	Wlsupport@commscope.com

Mexico, Central America & Caribbean region	
Andrew Corporation Mexico, SA DE CV	
Mail	Av. Insurgentes Sur 688, Piso 6 Col. Del Valle, CP: 03100 Mexico City Mexico
Phone	+52-55-1346-1900 (Office) +52-1-55-5419-5260 (Mobile)
Fax	+52-55-1346-1901
E-mail	Wlsupport@commscope.com

APAC Countries:

China, India and Rest of Asia	
Andrew International Corporation	
Mail	Room 915, 9/F Chevalier Commercial Centre 8 Wang Hoi Rd Kowloon Bay Hong Kong
Phone	+852-3106-6100
Fax	+852-2751-7800
E-mail	Wlsupport.China@commscope.com

Australia & New Zealand	
Andrew Corporation (Australia) Pty Ltd.	
Mail	Unit 1 153 Barry Road Campbellfield VIC 3061 Australia
Phone	+613-9300-7969
Fax	+613-9357-9110
E-mail	Wlsupport.Australia@commscope.com

Europe:

United Kingdom		France	
	<p>Andrew Solutions UK Ltd Unit 15, Ilex Building Mulberry Business Park Fishponds Road Wokingham Berkshire RG41 2GY England</p>		<p>CommScope France Immeuble Le Lavoisier 4, Place des Vosges 92052 Courbevoie France</p>
Mail		Mail	
Phone	+44-1189-366-792	Phone	+33-1 82 97 04 00
Fax	+44-1189-366-773	Fax	+33-1 47 89 45 25
E-mail	Wlsupport.uk@commscope.com	E-mail	Wlsupport@commscope.com
Germany		Czech Republic	
	<p>Andrew Wireless Systems GmbH Industriering 10 86675 Buchdorf Germany</p>		<p>Andrew Solutions Czech Republic C-Com, spol. s r.o U Moruší 888 53006 Pardubice Czech Republic</p>
Mail		Mail	
Phone	+49-9099-69-0	Phone	+420-464-6280-80
Fax	+49-9099-69-930	Fax	+420-464-6280-94
E-mail	Wlsupport@commscope.com	E-mail	Wlsupport@commscope.com
Austria		Switzerland	
	<p>Andrew Wireless Systems (Austria) GmbH Weglgasse 10 2320 Wien-Schwechat Austria</p>		<p>Andrew Wireless Systems AG Tiergartenweg 1 CH-4710 Balsthal Switzerland</p>
Mail		Mail	
Phone	+43-1706-39-99-10	Phone	+41-62-386-1260
Fax	+43-1706-39-99-9	Fax	+41-62-386-1261
E-mail	Wlsupport.austria@commscope.com	E-mail	Wlsupport.ch@commscope.com
Italy		Spain and Portugal	
	<p>Commscope Italy S.r.l., Faenza, Italy Via Mengolina, 20 48018 Faenza (RA) Italy</p>		<p>Andrew Solutions España S.A. A Commscope Company Avda. de Europa, 4 - 2ª pta. Parque Empresarial La Moraleja 28108 Alcobendas (Madrid) Spain</p>
Mail		Mail	
Phone	+39-0546-697111	Phone	+34-91-745-20 40
Fax	+39-0546-682768	Fax	+34-91-661-87 02
E-mail	Wlsupport.italia@commscope.com	E-mail	Wlsupport.iberia@commscope.com

table 1-1 List of international contact addresses

2. FUNCTIONAL DESCRIPTION

2.1. PURPOSE

Cellular telephone systems transmit signals in two directions between base transceiver station (BTS) and mobile stations (MS) within the signal coverage area.

If weak signal transmissions occur within the coverage area because of indoor applications, topological conditions or distance from the transmitter, extension of the transmission range can be achieved by means of an optical distribution system.

Such a system contains an optical Master Unit and several Remote Units. The number of the Remote Units depends on the hardware and software configuration. The Remote Units are connected to the Master Unit with optical links. The optical loss must be less than 10 dB inclusive optical couplers or splitters.

The Master Unit is the connection to the base transceiver stations. The configuration of a Master Unit depends on the number of the Remote Units and the frequency range.

WDM (Wave Division Multiplex) filters are integrated in the optical modules. For the UL, a wavelength within 1540 nm – 1562 nm is used. For the DL, a wavelength of 1310 ±20 nm is used. The maximum output power for the UL and DL is 5.7 mW.

2.2. ION-M17P/17P/17P

Andrew Solutions ION-M17P/17P/17P is a 3 sector single-box remote unit. It is used in conjunction with a master unit in the ION optical distribution system. This system transports 3 sectors (3 x 1700/2100 MHz) simultaneously, providing a cost-effective solution for distributing capacity from one or more base stations.

The ION-M17P/17P/17P transports signals on the RF layer in a very inexpensive manner. This means that multiple operators and multiple technologies are moved simultaneously from a cluster of base stations to a remote location over the same fibre.

The ION optical distribution system is a cost-effective coverage solution for dense urban areas, airports, high-rise buildings and other locations where physical structures increase path loss or provide limited space for installation. It has been specifically designed to reduce zoning problems and to provide homogeneous coverage. The compact, mechanical design is specifically architected to mount inside of or on poles and along side structures in such a way that it has a minimal visual impact.

The ION-M platform has been specifically tested and optimized for CDMA2000. Furthermore, it is provisioned for future improvements to the modulation and frequency bands.

The ION is easily set-up and supervised via a graphical user interface (GUI). Remote units can be commissioned through the use of built-in test equipment. An auto-levelling function compensates for the optical link loss making installation easy and quick.

The entire system may be monitored remotely via an Andrew OMC. This is a comprehensive management platform with SNMP protocol and X.733 standard implemented. Should a sophisticated interface not be required, the master unit can be directly connected to the alarm interface of a base station via relay alarming.

- 3 sector multi-operator support
- Reduced visual impact form factor
- Efficient, high power amplifier
- Single fibre for multiple sectors
- Comprehensive operations and management system for configuration and alarming
- OMC with SNMP according to X.733 standard
- Easy installation and commissioning

2.3. COMPONENTS OF THE ION-M17P/17P/17P REMOTE UNIT

2.3.1. Fan-Protection Kit

In order to protect the fan unit (e.g. against rain), a protective cover to be mounted over the air inlet is delivered with the unit. For indoor applications, mounting of the fan-protection kit is not mandatory.

For more details see chapter *3.1.4 Mounting of Fan Protection*.

2.3.2. Accessories

For the accessories available for the remote unit, e.g. overcoat housing, connecting box or iso-trafo kit, a separate manual is available.

For your notes:

3. COMMISSIONING

3.1. MECHANICAL INSTALLATION

3.1.1. General

Read the health and safety warnings in chapter 1.2.

1. Do not install the unit in a way or at a place where the specifications outlined in the Environmental and Safety Specifications leaflet of the supplier are not met.
2. It is recommended only to use the mounting hardware delivered by the supplier. If different mounting hardware is used, the specifications for stationary use of the Remote Unit must not be exceeded.

 **Note:** Exceeding the specified load limits may cause the loss of warranty!



3. The unit is considerably heavy. Make sure that a suitable mounting surface is used. Ensure there is adequate manpower to handle the weight of the system.
4. Due to power dissipation, the Remote Unit may reach a very high temperature. Ensure sufficient airflow for ventilation as specified in the individual mounting procedures.
5. When connecting and mounting the cables (RF, optical, mains, ...) ensure no water can penetrate into the unit through these cables.
6. Also observe all additional rules or restrictions regarding mounting that depend on the type of Remote Unit. For details refer to chapter 7.2.2 *Mechanical Specification*. Install the unit vertically with the fan unit at the top. A maximum tilt angle of 25° from a vertical position must be kept, as in the following illustrations:

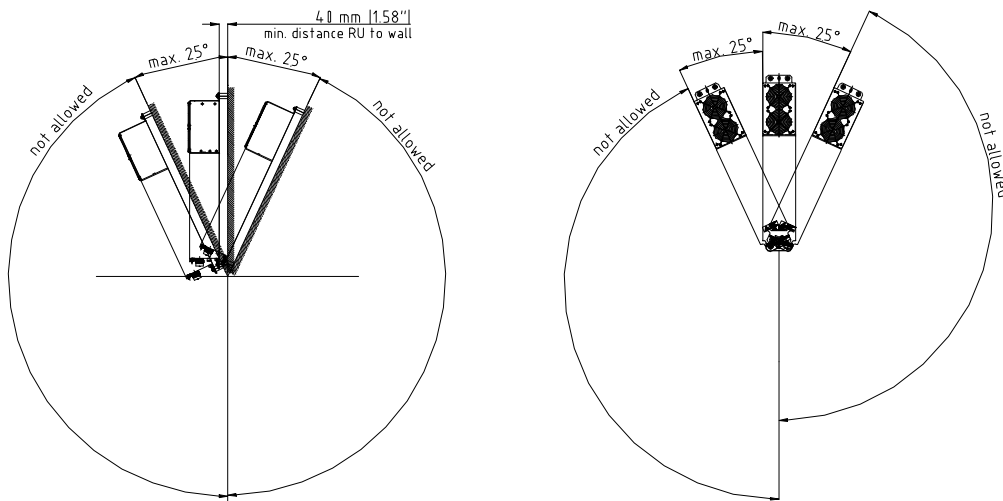

G1038M4

7. A spacing of 40 mm (1.58 inch) around the unit is required.
8. To ensure sufficient airflow when mounting the unit in enclosed spaces, two lid openings (one for the air inlet and the other for the air outlet) have to be provided. Do not block these air inlets and outlets when mounting the Remote Unit. The size of each opening must equal at least 17 x 17 cm (290 cm²). Make sure, too, there is no thermal short circuit between the air inlet and air outlet.

If any different or additional mounting material is used, ensure that the mounting remains as safe as the mounting designed by the manufacturer. Ensure that the static and dynamic strengths are adequate for the environmental conditions of the site. The mounting itself must not vibrate, swing or move in any way that might cause damage to the Remote Unit.

Specified torques have to be observed for certain mounting procedures according to the following table:

Type	Lens head screws	Hex nuts	Spacing bolts		PG (plastic)	PG (aluminium)
<i>Thread</i>	M 4	M 8	M 4	M 8	PG 13.5	PG 29
<i>Specified torques</i>	3.3 Nm	27 Nm	2.3 Nm	27 Nm	3.75 Nm	10 Nm

table 3-1 Specified torques

 **Note:** To avoid damage when mounting the unit, always make sure that the M8 washers (DIN9021 or DIN125 depending on the mounting kit) are placed behind and in front of the mounting drillings of the unit.

The mounting procedures for a stand-alone Remote Unit without optional accessories are described and illustrated in the following sections. For further information regarding special mounting procedures including mounting of accessory equipment, please see separate manual.

3.1.2. Wall-Mounting Procedure

- Check the suitability of the wall-mounting kit and the wall.
- Mark the position of the drilling holes (for measurements refer to *figure 3-1 Wall mounting*). Drill four holes at the marked positions and insert dowels *.
- Use a cap nut or lock nut to screw the four dowel screws into the dowels and put the distance tubes over the screws.
- Hang the mounting brackets of the Remote Unit into the screws, and fasten them immediately using the washers and nuts.
- Ensure that there is free access to the electrical connections as well as to the cabinet. The approved bending radius of the connected cables must not be exceeded.

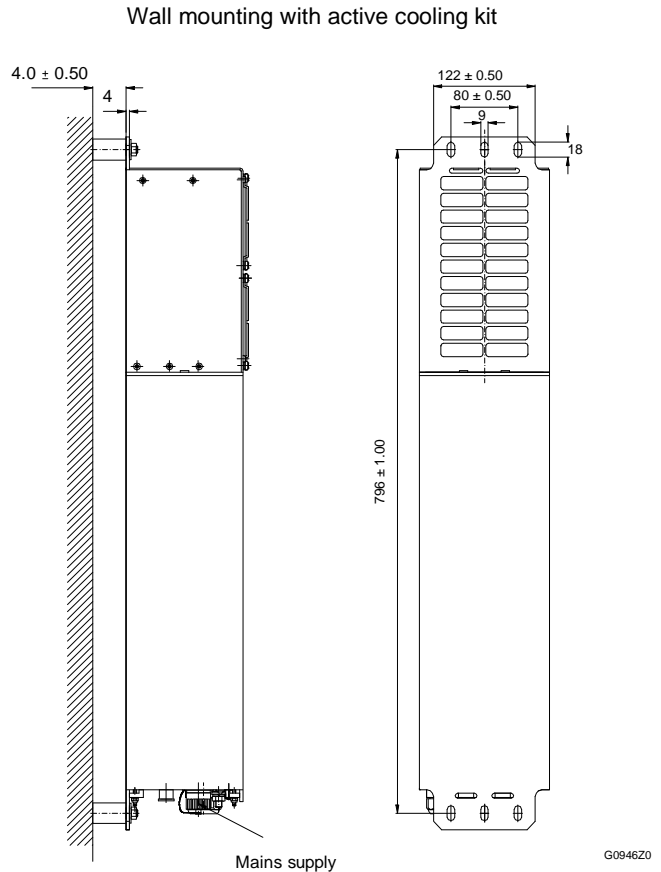
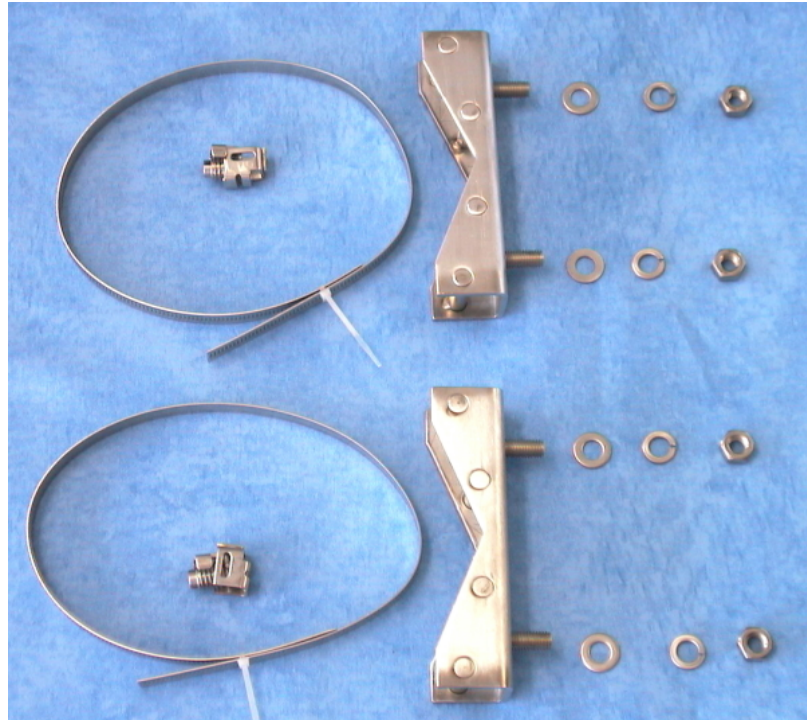

figure 3-1 Wall mounting, (metric dimensions)

* The dowels are not part of the delivery since the suitable type depends on the on-site conditions (material of wall). Therefore, use dowels that are appropriate for the mounting surface.

3.1.3. Pole-Mounting Procedure

Standard mounting hardware cannot be used to mount the Remote Unit to a pole, a column or other similar structures. Additional hardware must be used for this type of installation. Such a pole-mounting kit could include two threaded rods M8, two U-beams and mounting material like bolts and nuts.



B0113AUA

figure 3-2 Pole-mounting kit

- Use the screw bands to fasten the two U-beams to the pole as illustrated in *figure 3-3 Pole mounting*.

Note: When fastening the U-beams make sure that they are installed congruently and not at an angle to each other. To determine the distance between the beams refer to *3.1.2 Wall-Mounting Procedure* for measurements.

- Hang the mounting brackets of the Remote Unit into the threaded bolts of the U-beam, and fasten them immediately using the washers and nuts.

Ensure that there is free access to the electrical connections as well as to the cabinet. The approved bending radius of the connected cables must not be exceeded.

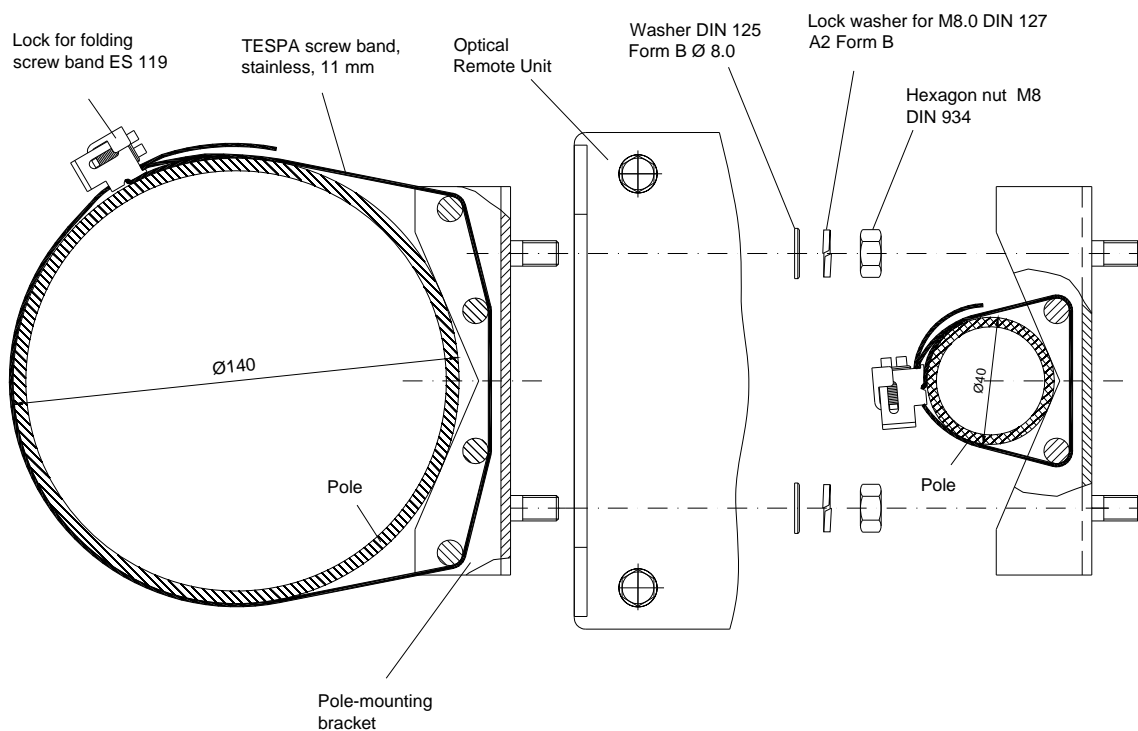

G0764M6

figure 3-3 Pole mounting (metric dimensions)

3.1.4. Mounting of Fan Protection

Since the fan protection is required for the outdoor usage of a stand-alone Remote Unit, the mounting of this optional equipment is also described in this manual.

- To install the protective cover of the fan protection kit, first unscrew the four screws with the respective lock washers from the cover of the air inlet of the Remote Unit, and instead, screw in the four spacing bolts M4.0x30 with the four lock washers M4.0 DIN125 that are part of the fan protection kit.
- Place the protective cover into the right position by fitting its four bore holes over the spacing bolts and fasten it using the original lock washers and screws of the Remote Unit. (These lock washers and screws are also part of the fan protection kit and can be used as spare parts in case of loss.)

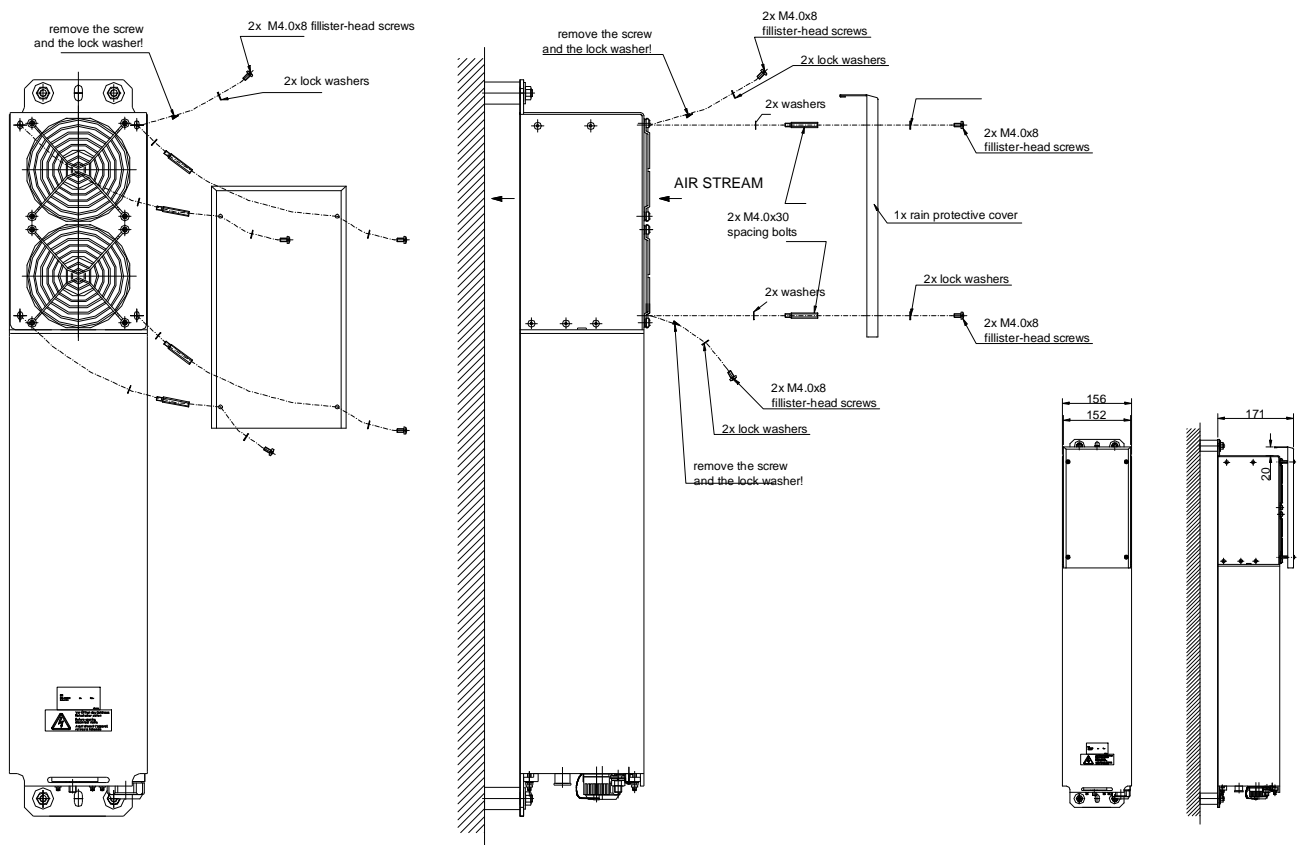

G0496MF

figure 3-4 Mounting procedure for fan protection, (metric dimensions)

3.2. ELECTRICAL INSTALLATION

3.2.1. General

Read the health and safety warnings in chapter 1.2.



1. This unit contains dangerous voltages. Loss of life, severe personal injury or property damage can be the result if the instructions contained in this manual are not followed.
2. It is compulsory to ground the unit before connecting power supply. A grounding bolt is provided on the cabinet to connect the ground-bonding cable.
3. Although the Remote Unit is internally protected against overvoltage, it is strongly recommended to earth the antenna cables close to the antenna connectors of the Remote Unit for protection against atmospheric discharge. In areas with strong lightning it is strongly recommended to insert additional lightning protection.
4. If the mains connector of the Remote Unit is not easily accessible, a disconnect device in the mains circuit must be provided within easy reach.
5. Before connecting or disconnecting the mains connector at the Remote Unit, ensure that mains supply is disconnected.
6. Make sure that an appropriate circuit breaker and an overcurrent limiting device are connected between mains and Remote Unit.
7. A connection of mains supply to a power socket requires the power socket to be nearby the Remote Unit.
8. Incorrectly wired connections can destroy electrical and electronic components.
9. To avoid corrosion at the connectors caused by electrochemical processes, the material of the cable connectors must not cause a higher potential difference than 0.6 V (see electrochemical contact series).
10. Use an appropriate torque wrench for the coupling torque of N-type connectors (2 N-m / 20 in lb), with 13/16 in opening to tighten the N-type antenna connectors. For example, use torque wrench of item no. 244379 available from the *Andrew e-catalog*. Do NOT use your hands or any other tool (e.g. a pair of pliers)! This might cause damage to the connector and lead to a malfunction of the Remote Unit.
11. For unstabilized electric networks which frequently generate spikes, it is advised to use a voltage limiting device.
12. The unit complies with the surge requirement according to EN 61000-4-5 (fine protection); however, it is recommended to install an additional medium (via local supply connection) and/or coarse protection (external surge protection) depending on the individual application in order to avoid damage caused by overcurrent.
13. Observe the labels on the front panels before connecting or disconnecting any cables.

3.2.2. Connections

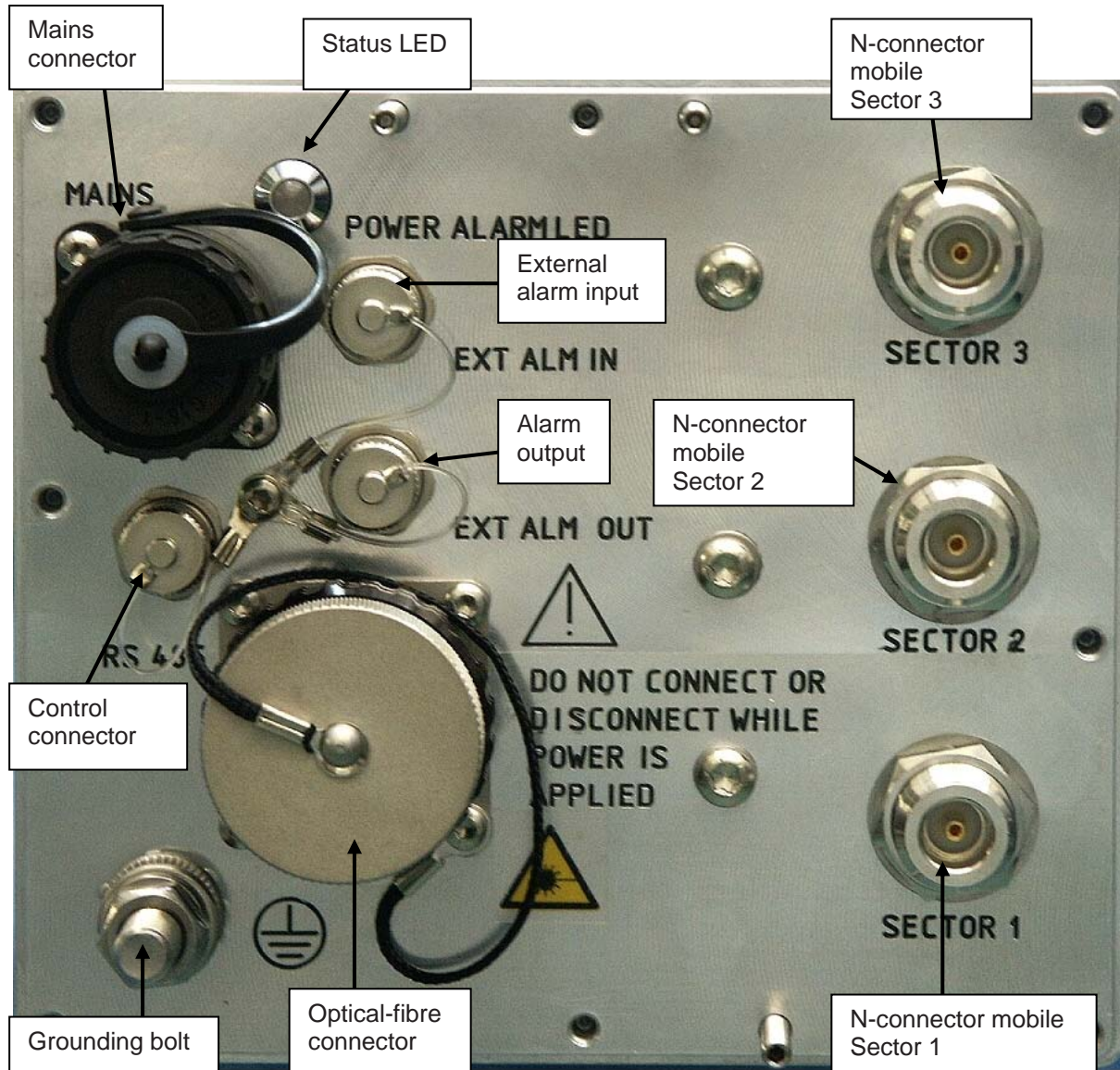

figure 3-5 Connector flange of ION-M17P/17P/17P

Control Connector RS232 - Local Interface

This 8-pin male connector (type: Binder Series 712) is primarily to support local control of the remote unit via RS232 ASCII interface.

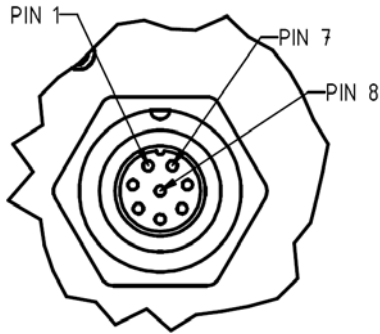

figure 3-6 RS232 connector

PIN	Assignment
1	Not connected (n.c.)
2	RS232 Rx
3	RS232 Tx
4	n.c.
5	GND* (RS232)
6	n.c.
7	n.c.
8	n.c.

table 3-2 RS232 connector, pin assignment

* GND is the abbreviation of Ground

3.2.3. Grounding

Grounding must be carried out. Connect an earth-bonding cable to the grounding connection provided at the outside of the remote unit (see chapter 3.2.2 *Connections*). Do not use the grounding connection to connect external devices.



figure 3-7 Grounding bolt with loosened hex nut

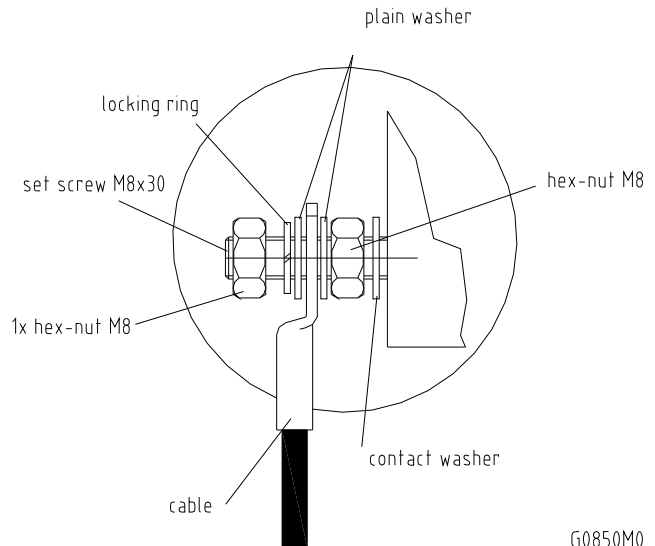

figure 3-8 Grounding bolt, schematic view

After loosening the hex nut, connect the earth-bonding cable between the two washers as illustrated in the figures above. Then, fasten all parts again with the hex nut.

3.2.4. Connection of the Antenna Cables

The Remote Unit has N-type antenna connectors. For its location please refer to chapter 3.2.2 *Connections*. For mounting the cable connectors, it is recommended to refer to the corresponding documentation of the connector manufacturer. The bending radius of the antenna cables must remain within the given specifications.

For the selection of cable and antenna it should be considered that, on the one hand, a cable with higher loss is less expensive but, on the other hand, it impairs performance.



Use an appropriate torque wrench for the coupling torque of N-type connectors (2 N-m / 20 in lb), with 13/16 in opening to tighten the N-type antenna connectors. For example, use torque wrench of item no. 244379 available from the *Andrew e-catalog*. Do NOT use your hands or any other tool (e.g. a pair of pliers)! This might cause damage to the connector and lead to a malfunction of the Remote Unit.



To minimize passive inter-modulation (PIM) distortion, attention has to be paid to the physical condition of the connector junctions. Do not use connectors that show signs of corrosion on the metal surface. Prevent the ingress of water into the connector. Attach and torque the connectors properly.

3.2.5. Power Connection

Before connecting electrical power to the units, the system must be grounded as described in the previous chapter.

Mains power must be connected at the mains connector of the unit (see chapter 3.2.2 *Connections*).

The power supply plug is part of the delivery. The correct wiring of the power supply plug is as follows:

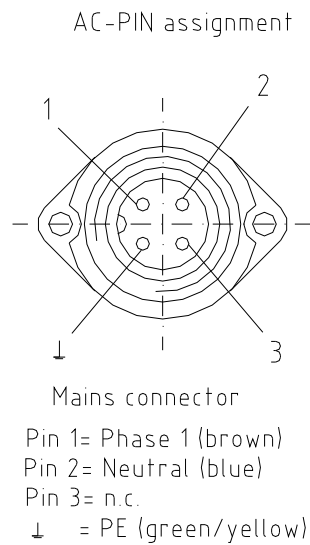

G1038Z0

figure 3-9 AC mains plug



For the AC power supply connection, a minimum cross section of 1.5 mm² is required. Each wire must observe the applicable national regulations regarding loop impedance, voltage drop, and methods of installation. Make sure to connect the correct voltage to the unit.

Note: Do not connect or disconnect the power cord at the mains connector while power is on. Turn off mains * power before connecting the power cord at the remote unit, then, engage mains again.

* Mains power must be interruptible with an external mains breaker. For the mains breaker, observe the following recommendation:

120 Volt / 20 Amp max. or 240 Volt / 16 Amp, single-phase, 50 / 60 Hz AC service is needed, i.e. the external AC breaker should be 20 Amps max. for 120-Volt service or 16 Amps for 240-Volt service.

3.3. OPTICAL-FIBRE-CABLE CONNECTION - RULES

Optical signals are transmitted by use of optical fibres. When connecting these fibres observe the following instructions.

 **Note:** Care should be taken when connecting and disconnecting fibre-optic cables. Scratches and dust significantly affect system performance and may permanently damage the connector. Always use protective caps on fibre-optic connectors not in use.

In general, optical fibres do not need special protective measures. However, protection against environmental influences e.g. rodents and humidity must be considered.

The optical fibre is a single mode fibre. Type is E9/125 µm with the following minimum requirements:

Attenuation:	<0.36 dB / km @ 1310 nm	/	<0.26 dB / km @ 1550 nm
Dispersion:	<3.5 ps / nm km @ 1310 nm	/	<18.0 ps / nm km @ 1550 nm

The specified bending radius of the optical fibres must not be exceeded. The pigtails for the connection between master unit and remote unit must have a sufficient length. A protection for the feeding into units must be given. The system attenuation of the optical fibres, including the connectors, must not exceed 10 dB.

System attenuation and attenuation of optical components must be determined. This can be achieved by measuring attenuation and reflection with an appropriate measuring instrument. For pigtails, a total value of < 0.4 dB (measured to a reference plug) can be assumed due to the dead zone of the reflectometer. These measurements must be made with a sufficient length of optical fibre, at the input and output of the device which has to be measured.

Fibre-cable connectors have to be of the same type (E2000APC8°) as the connectors used for the unit. The fibre-optic cables are connected to the optical transceiver.



Angled connectors are not compatible with straight optical connectors; non-compatibility of connectors will result in permanent damage to both connectors.

Before connecting the fibre cables, follow the procedure below to ensure optimized performance. It is important for these procedures to be carried out with care:

- Remove fibre-optic protective caps.
- Do not bend the fibre-optic cable in a tight radius (< 4 cm) as this may cause cable damage and interrupt transmission.
- Using high-grade alcohol and lint-free cotton cleaning swabs, clean the end of the fibre-optic cable that will be inserted in the optical connectors on the donor interface box.
- Blow out the laser receptacle with clean and dry compressed air to remove any particulate matter.
- Connect the fibre-optic cables by inserting the cable end into the laser receptacle and aligning the key (on the cable end) with the keyed slot.
- Do not use any index-matching gels or fluids of any kind in these connectors. Gels are intended for laboratory use and attract dirt in the field.

3.3.1. Protective Plug

Connection:

A protective plug is provided for the connection of the fibre-optic cables.

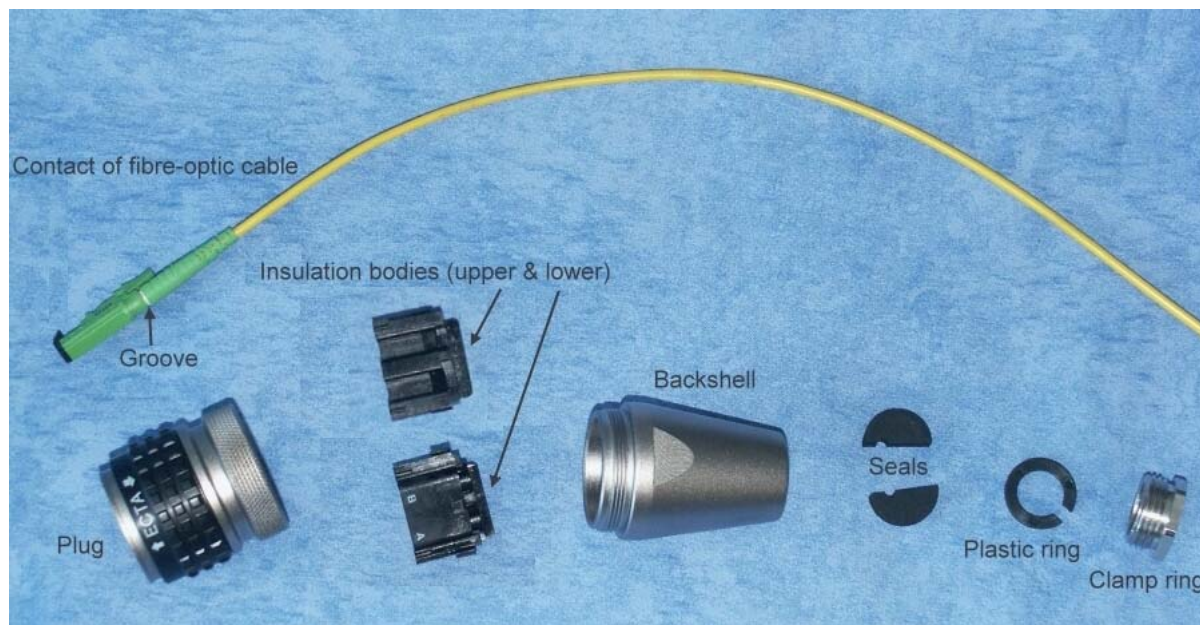

B0122AMA

figure 3-10 Protective-plug assembly

👉 **Note:** Only high-quality connectors must be used for this type of plug. Qualified brands are Diamond or Huber & Suhner.

For plug assembly, observe the following instruction:

1. Pass one or two contacts through the backshell and the clamp ring.



B0122A1A

2. Place the contact(s) on the lower insulation body by pushing the groove of the contact into the cavity. If there is only one contact, cavity A **must** be used. *
3. Then, mount the upper insulation body on the lower insulation body. **



Cavity B

B0122AKA

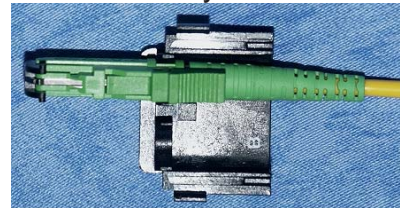

B0122ALA

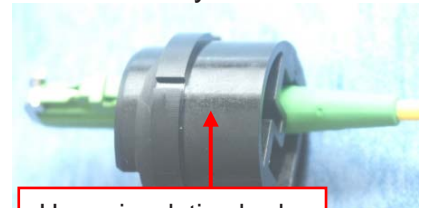

Upper insulation body

B0122A4A

4. Bring the insulator into the plug. The narrow groove of the insulator must be fitted into the stamp of the plug.

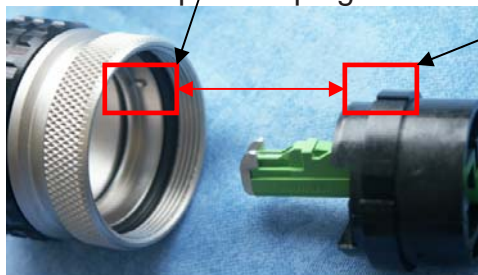

B0122AEA

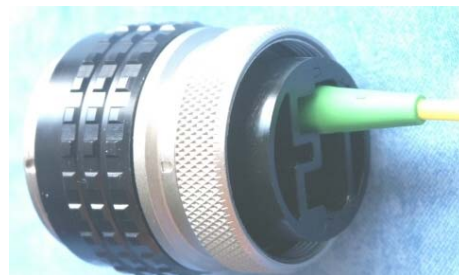

B0122A6A

- * To release the contact for disassembling, push the inner snap to the side and pull the contact out.
- ** To release upper and lower insulation bodies for disassembling, use a small screwdriver and carefully open the snap-connections at the left and the right side of the insulator without damaging them.

5. Fasten the insulator by screwing the backshell tight onto it. Use a spanner with opening 32 to screw the backshell tight (no gap).



B0122A7A

6. Place the appropriate seal parts (with one groove for one contact or two grooves for two contacts) over the cable(s) and push them into the backshell.

Seals with one groove

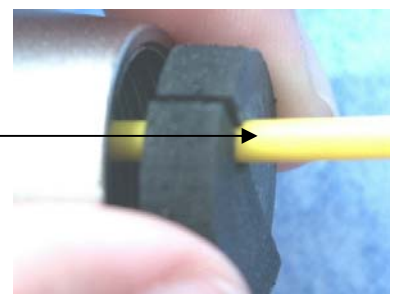

B0122A8A

7. Bring the plastic ring over the cable(s), push it into the backshell and compress the seals and plastic ring by screwing the clamp ring tight (no gap) using a spanner with opening 20. ***



B0122A9A

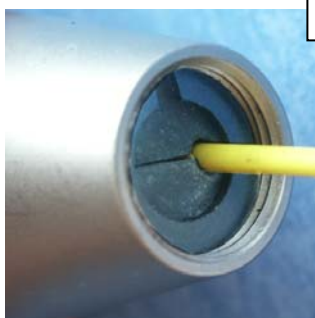

B0122AAA

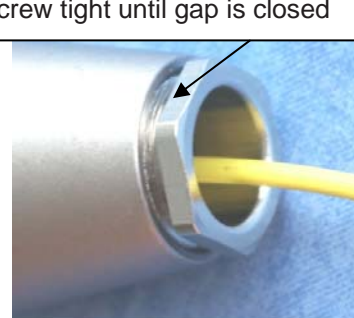

B0122ABA

8. Connect the plug to the optical-fibre connector of the remote unit, again by fitting a stamp on the plug into the groove of the connector.

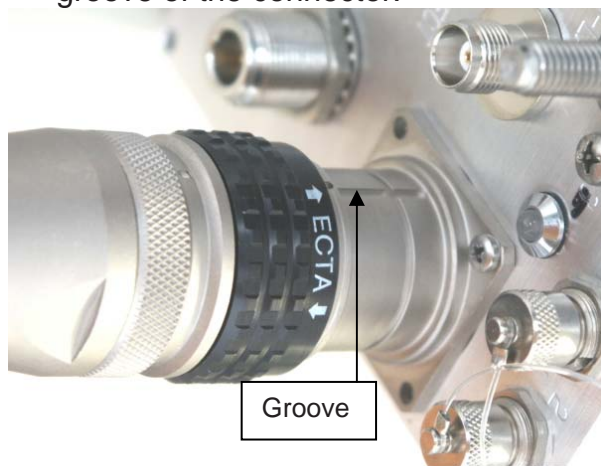

B0122ACA

9. To lock the connector, push the black locking ring forward. ****



B0122ADA

*** For disassembling, release the clamping ring and remove the seals and the plastic ring first.

**** Locking mechanism: The system of locking the plug is based on a “push-pull” mechanism. The locking ring has to be pushed forward to lock the connector and pulled back to free the connection.

3.3.2. Protective-Tube Kit

As additional protection for the optical fibers, this connector type can be supplemented by a special tube kit. To fasten the tube correctly, first unscrew the clamp ring (if already installed) of the original plug kit.

Then, proceed according to the following instruction:

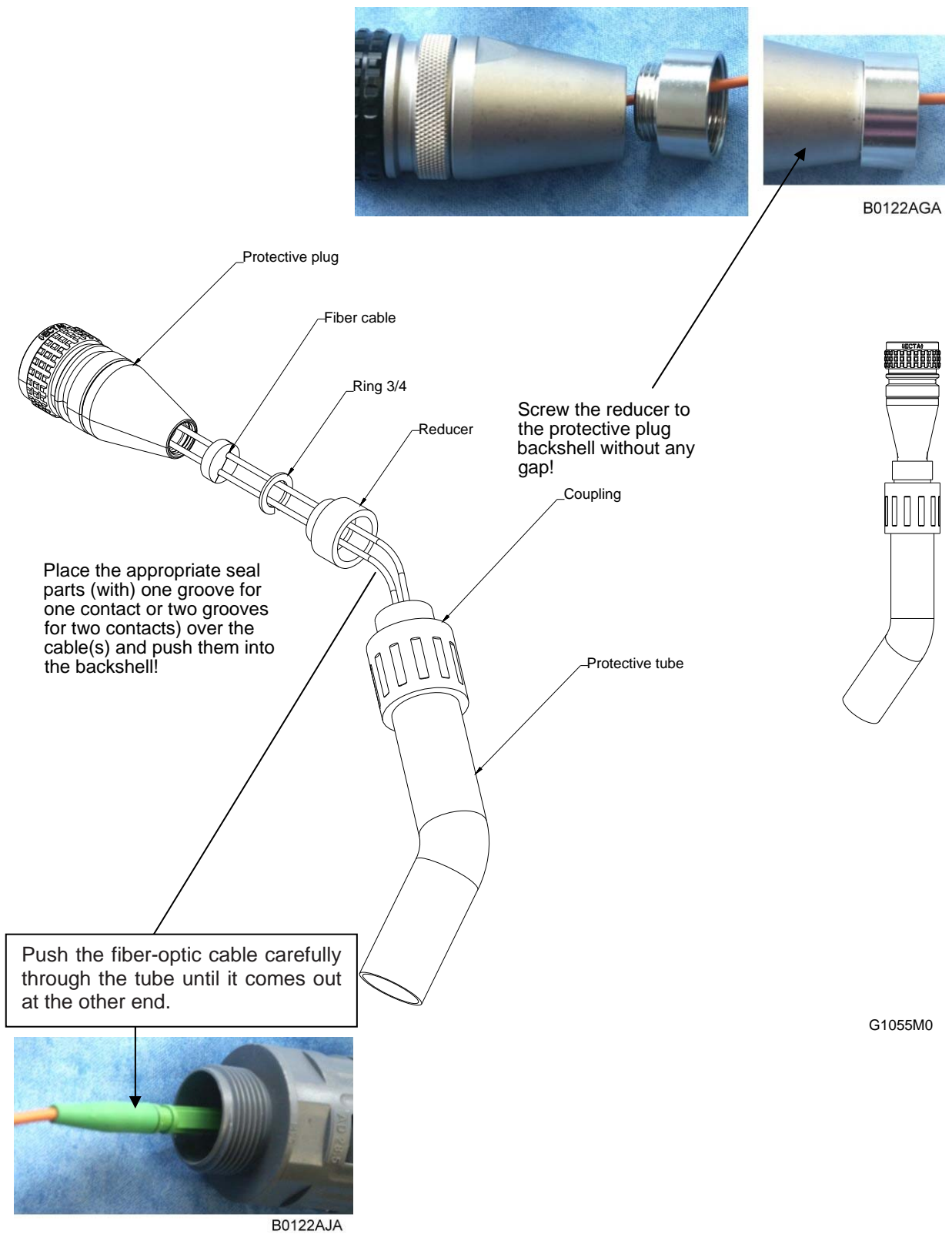

figure 3-11 Tube-kit installation

3.4. COMMISSIONING

Read the health and safety warnings in chapter 1.2 as well as the description carefully to avoid mistakes and proceed step by step as described!

- Do not operate the remote unit without terminating the antenna connectors. The antenna connectors may be terminated by connecting them to their respective antennas or to a dummy load.
- Only qualified personnel should carry out the electrical, mechanical, commissioning and maintenance activities that require the unit to be powered on when open.
- When opening the remote unit do not damage the warranty labels on the internal devices. The warranty is void if the seals are broken.
- Ensure that all connections have been performed according to chapter 3.2.2 *Connections*.

Commissioning an ION-M Remote Unit

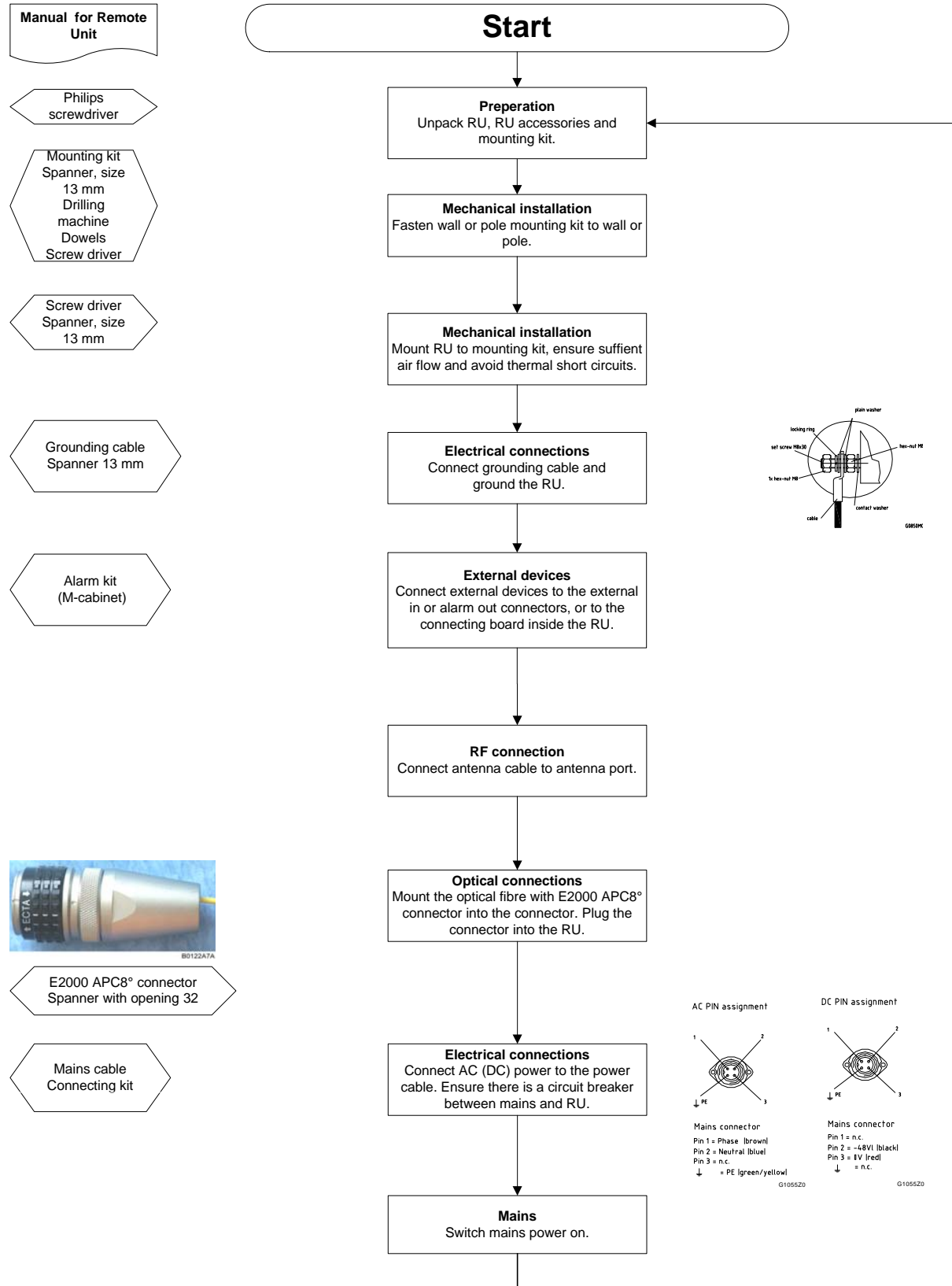

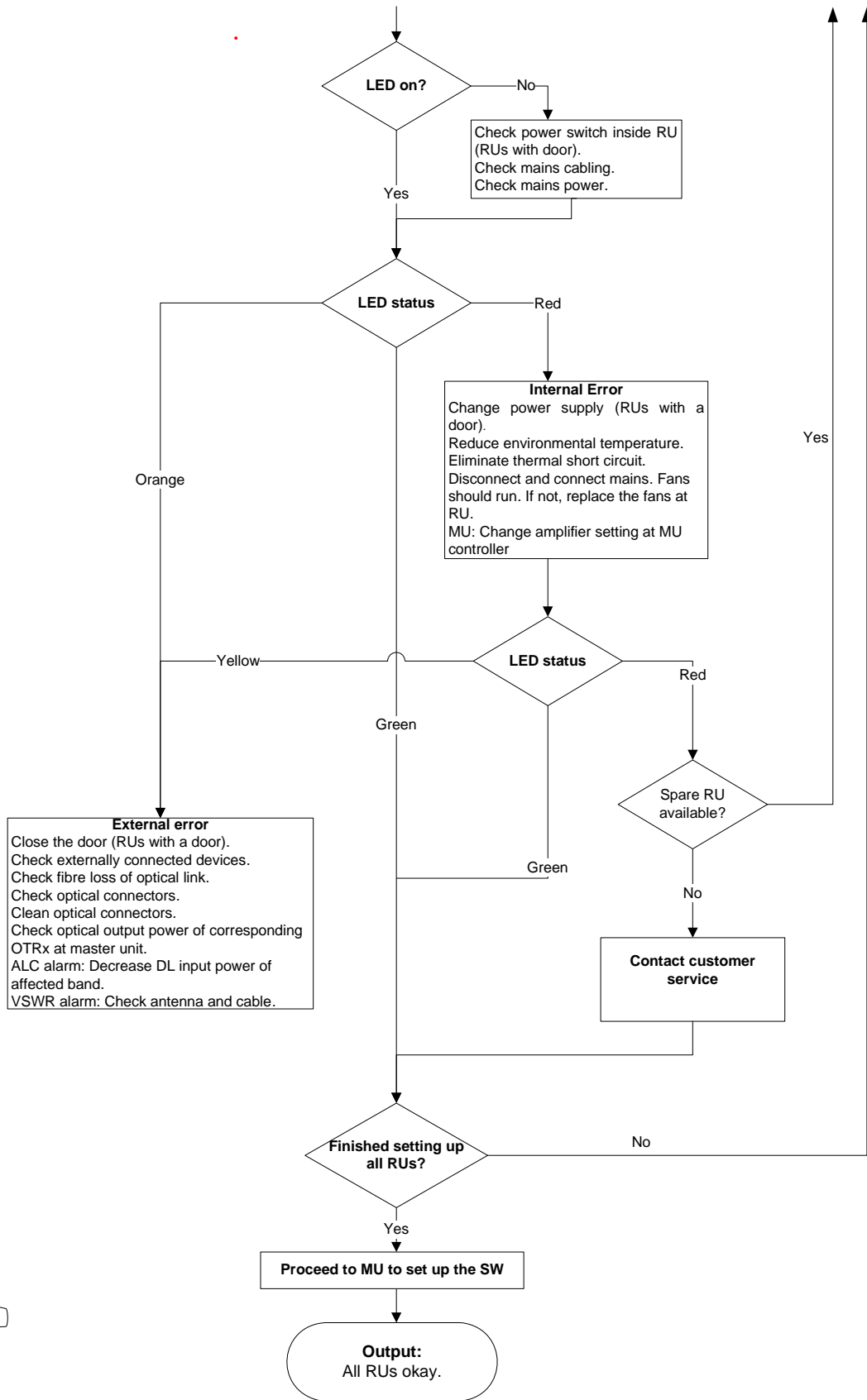

For your notes:

4. ALARMS

4.1. BITE AND ALARMS

The Built-In Test concept comprises the monitoring of the power supplies, the power amplifiers and the optical interface.

All occurring alarms can be checked via software at the master unit.

4.2. HANDLING OF ALARMS

As soon as the software acknowledges a valid alarm, a message is transmitted to the master unit.

If the reason for the alarm has been cleared or if the alarm should continue, a new alarm message will not be repeated. If there was an interruption of at least five seconds after acknowledgement, a new alarm message will be generated.

4.3. ALARM STATUS

For details refer to the corresponding software documentation of the master unit.

4.4. STATUS LED ALARMS

For local supervision, a status LED on the connector flange of the remote unit gives an indication of possible reasons for alarms. This table shows possible on-site measures that could be checked before referring to the master unit alarm list.

Status LED Indication	Alarms	Possible on-site measures
Green	No alarm → Status ok	
Orange	Door alarm	Close the door (RUs with door).
	<i>Alarms not directly related to RU:</i>	
	External alarms	Check externally connected devices.
	Optical alarm Rx	Check fibre loss of optical link. Check optical connectors. Clean optical connectors. <i>(MU: Check optical output power of corresponding OTRx at master unit).</i>
	ALC alarm	<i>(MU: Decrease DL input power of affected band).</i>
Red	<i>Alarms directly related to RU:</i>	
	Power 28 V	Change power supply (RUs with door). Replace the affected remote unit.
	Temperature	Reduce environmental temperature. Eliminate thermal short circuit.
	Fan	Disconnect and connect mains. Fans should run. If not, replace the fans at RU.
	I ² C	Disconnect and connect mains.
	Optical alarm Tx	-
	Amplifier "Power Down"	<i>(MU: Change amplifier setting at MU controller).</i>
Status LED off	Mains	Check power switch inside of RU (RUs with door). Check mains cabling. Check mains power.

table 4-1 Status LED alarms

For the position of the status LED see chapter 3.2.2 *Connections*.

Explicit troubleshooting is available in the MU software (software manual or WEB Interface).

4.5. EXTERNAL ALARM INPUTS AND OUTPUTS

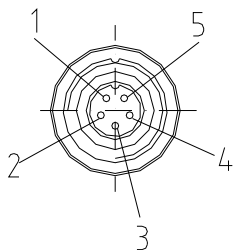

Flange connector
5 poles

- Pin 1= Alarm IN1
- Pin 2= Alarm IN2
- Pin 3= Alarm IN3
- Pin 4= Alarm IN4
- Pin 5= Alarm GND

G1038Z0

figure 4-1 Flange connector, 5 poles

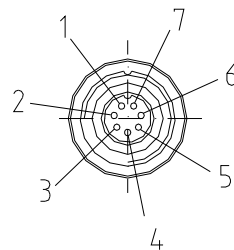

Flange connector
7 poles

- Pin 1= OUT1
- Pin 2= OUT2
- Pin 3= OUT3
- Pin 4= OUT4
- Pin 5= Alarm GND
- Pin 6= GND
- Pin 7= +28 V

G1038Z0

figure 4-2 Flange connector, 7 poles

The alarm outputs (open collector output 5 V / 1 mA) are normally low. In case of an alarm they are high active (5 V). They can be used to monitor alarms with an external alarm indicator.

The +28 V pin (for its location see *figure 4-2 Flange connector, 7 poles*) is protected by a 500mA thermoswitch. In case of exceeding this current between pin 7 and GND and/or in case of a failure of the VSWR module, the thermoswitch turns into a high-resistive status. In this case no fuse needs to be replaced. Just wait a few minutes until the thermoswitch reaches the normal operating temperature again.

Note: The manufacturer / supplier of this system accepts no liability for damage caused by equipment connected to external outputs or by effects from such equipment.

As accessory equipment the alarm kit (see chapter 6.3 *Spare Parts*) is available to connect external devices to the external alarm inputs and outputs..

With the external alarm inputs it is possible to monitor the status of connected devices, e.g. a UPS, via software. All alarm inputs are normally high (5 V) without connection. The polarity (high/ low) can be set via the software at the Master Unit (for details please see according software manual).

The device to be monitored must be connected so that the alarm contacts will be closed in case of an alarm ($I_{max} = 8 \text{ mA}$). The alarm inputs are potential-free with common ground.

Subminiature circular connectors series 712 with five and seven contacts, which are contained in the alarm kit, can be ordered directly from the Binder Connector Group, the manufacturer, or indirectly from Andrew Solutions (see chapter 6.3 *Spare Parts*).

ION-M alarm outputs

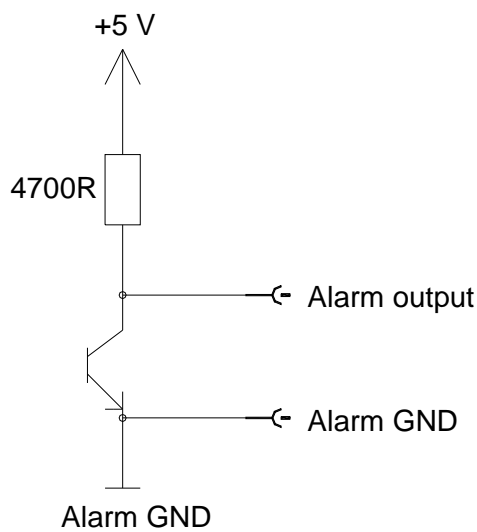

ION-M alarm inputs

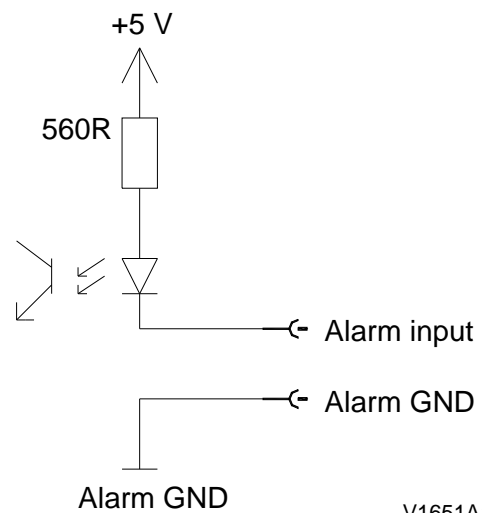

V1651A1

figure 4-3 Alarm inputs and outputs, standard

4.6. TROUBLESHOOTING

The status of the remote unit can be checked via the master unit (for details please refer to the software manual of the Master Controller). Locally, the status can be checked at the LED, see chapter 4.4 *Status LED Alarms*.

5. MAINTENANCE

5.1. GENERAL

Read the health and safety warnings in chapter 1.2.

 **Note:** The remote unit does not require preventative maintenance measures.

 **Note:** To prevent malfunctions of the cooling system due to dirt or pollution, it is recommended to clean the heat sink at regular intervals. These cleaning intervals depend mainly on the location of the remote unit and the corresponding degree of pollution.

Maintenance of the ION-M17P/17P/17P should be performed by replacing only components that are contained in this chapter. In order to maintain warranty, take care not to damage unintentionally the seals on the modules.

The spare parts list, consequently, contains only units which can be replaced without tuning or soldering work.

 **Note:** When sending back the unit, use an appropriate packaging, see chapter 6.2.2 *Environmental and Safety Specifications*. We strongly recommend using the original packaging!

 **Note:** Defect parts should only be replaced by original parts from the supplier. All interventions inside the housing are at one's own risk.

 **Note:** During maintenance ensure the remote unit has been disconnected from mains.

 **Note:** Before disconnecting any cables, label any unlabelled cables to ensure correct connection.

For most maintenance procedures appropriate tools are required to ensure correct handling. All these tools can be ordered from the supplier. For screwing procedures observe that all our screws have a right-hand thread, i.e. for fastening the screws turn the tool clockwise and for unscrewing them turn it counter-clockwise.

Due to the design of the remote unit the only component recommended to be replaced is the fan unit. For replacing any other component, please contact the supplier.

5.2. REPLACING THE FAN UNIT

Replacement of the fan unit is not required as a preventative measure. Only when an alarm indicates a malfunctioning of a fan, must the unit be exchanged.

Note: Please observe that the fan unit can only be replaced as a whole. Do not remove the fans separately.

Read the health and safety warnings in chapter 1.2 as well as the instructions in chapter 5.1 *General* before starting with the replacement.

1. **Switch off the remote unit. Make sure mains is disconnected for the following replacement procedure.** Then, proceed as follows:

2. Loosen the four tallow-drop screws M4x8 by which the fan plate is screwed to the cabinet. Remove the four screws and the corresponding washers.



B0092ALA

3. Remove the fan unit – by putting slight pressure on the fan plate cover – to a position that allows access to the fan connector and the earth-bonding cable.

4. Unscrew the fan connector and then disconnect the earth-bonding cable.

Fan-unit connector

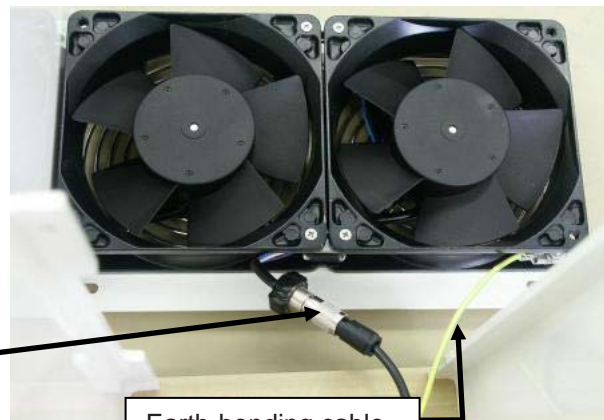

Earth-bonding cable

B0092A5A

Note: To observe the specified torque of 650 Ncm for an M5 thread, use an appropriate tool for the following screwing procedures.

5. To mount the new fan unit, re-connect the earth-bonding cable and the fan connector (see *step 4*). Then, place the fan unit back into its original position and fix it tight as shown below:



B0092AJA



B0097AKA

6. Screw the whole fan unit to the cabinet with the four tallow-drop screws M4x8 (see *step 2*). In order not to exceed the specified torque of 330 Ncm, use an appropriate tool.

5.3. CLEANING THE HEAT SINK

Note: Read the health and safety warnings in chapter 1.2 as well as the instructions in chapter 5.1 *General* before starting with the replacement procedure. Then, proceed as follows:

1. Switch off the remote unit. Make sure that mains is disconnected for the following procedure.
2. Remove the fan plate with the fan unit from the remote unit as described in chapter 5.2 *Replacing the Fan Unit*, steps 1 and 2:
3. Use compressed air (max. 5 bar) to blow out the heat sink from back to front:

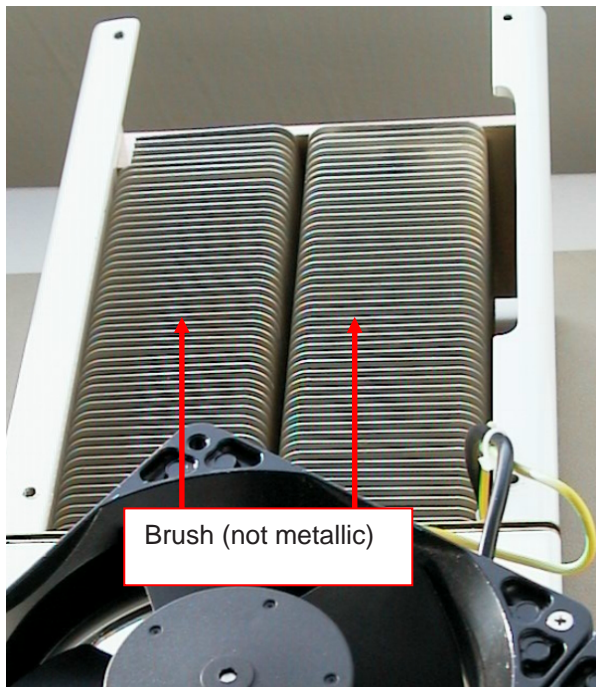

B0112A5A

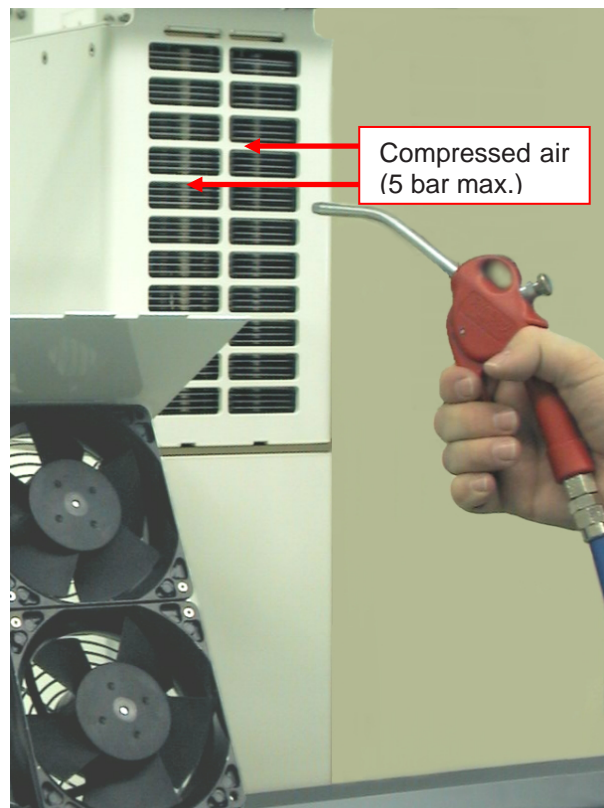

B0112A6A

4. In case the dirt cannot be blown out completely and parts of it stick to the ribs of the heat sink, clean the parts concerned carefully from the front using e.g. a brush. Take care that the material is not scratched or damaged.
5. After cleaning the heat sink, mount the fan unit again according to chapter 5.2 *Replacing the Fan Unit*, step 6. Then, switch the remote unit back on.

6. APPENDIX

6.1. ILLUSTRATIONS

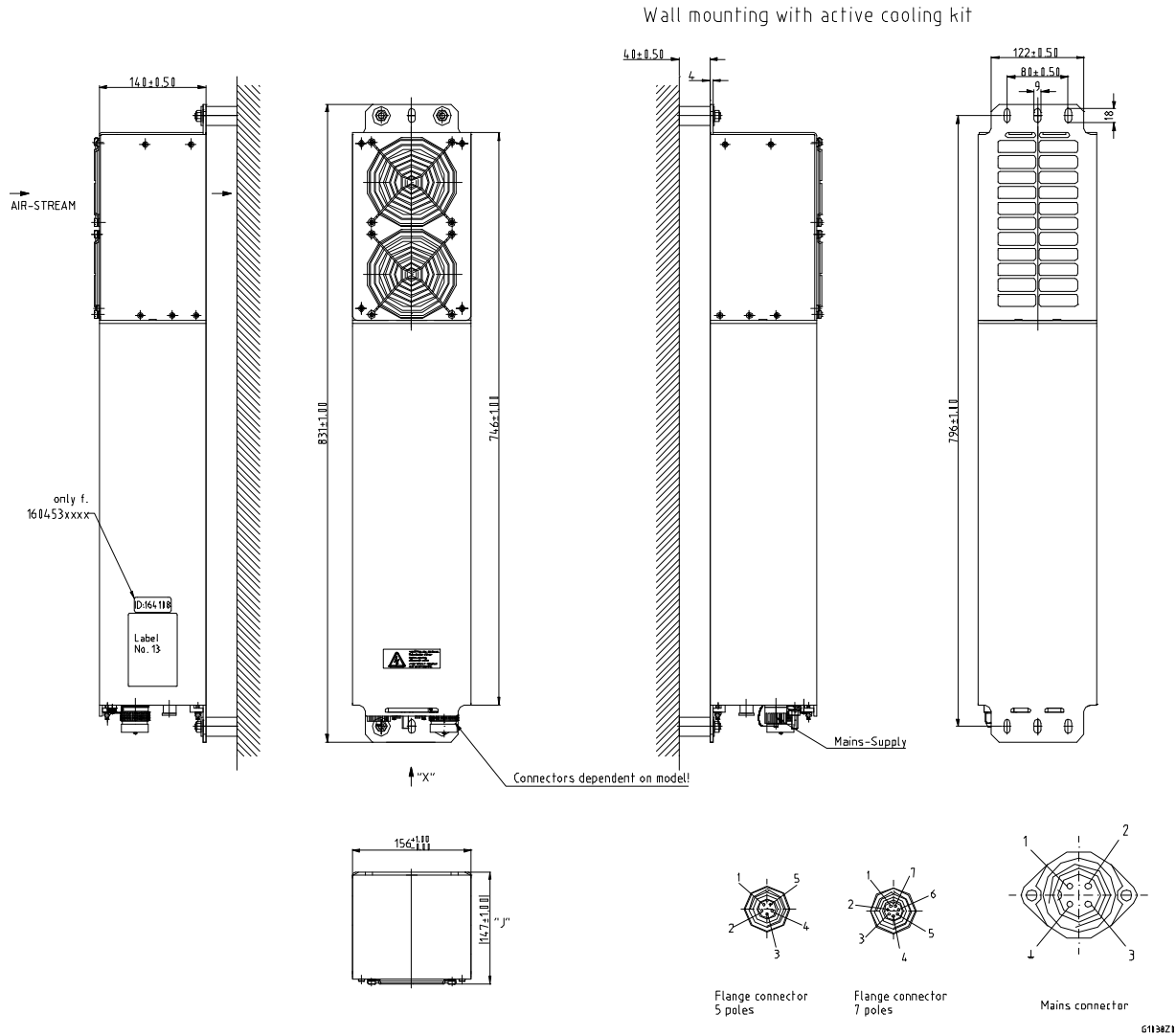

figure 6-1 Installation drawing

6.2. SPECIFICATIONS

6.2.1. Electrical Specifications

ION-M17P/17P/17P			
Electrical			
Power supply	Mains power	85 to 264 Vac	
	Power consumption	Idle	approx. 330 watts
Full load		800 watts	
Optical			
Connectors		E2000/APC 8°	
Optical return loss		45 dB minimum	
Fiber type		Single mode E9/125 μm	
Optical link budget		0 to 10 dB	
Composite input power 2100 MHz @ Conversion module master side		+3 dBm nominal	
		+10 dBm max ¹⁾	-19 dBm min ²⁾

¹⁾ can be compensated by additional attenuation (0 - 7 dB)

²⁾ can be compensated by additional gain (0 - 22 dB)

All data is subject to change without notice.

6.2.2. Environmental and Safety Specifications

 **Note:** For detailed information, please refer to the Environmental and Safety Specifications leaflet of the supplier, related to ETS 300 019 (European Telecommunication Standard).

Operating temperature range	-33° C to +50° C	
Ingress protection	RF part	IP67
	Fan part	IP55

All figures are typical values unless otherwise stated.

All data is subject to change without notice.

6.2.3. Mechanical Specifications

Height, width, depth **	831 x 156 x 147 mm (32.7 x 6.1 x 5.8 in)
Weight	18 kg (39.7 lb)

** Spacing required 40 mm (1.58 in) around unit

All data is subject to change without notice.

6.3. SPARE PARTS

The following list contains all parts available for the Remote Unit. The configuration of the delivered unit meets the requirements of the customer and can differ depending on the state of the delivery.

Maintenance of the ION-M17P/17P/17P should be performed on an FRU (Field Replaceable Unit) basis only. Do not damage the warranty labels on the components, as this voids the warranty.

If any FRU not contained in the following list needs to be replaced, please contact customer service for additional instructions.

Spare Parts List of the Remote Unit ION-M17P/17P/17P

Designation:	ID No:
<i>ION-M17P/17P/17P</i>	7634986
Protective Plug E 2000	7160013
Protective Cap E 2000	7158914
Fan Protection Kit	7159097
Fan Unit	7158254
Protective Tube Kit	7162182
Manuals for Optical Remote Unit ION-M17P/17P/17P	7619958-00

Accessories	
Alarm Kit	7157396
<i>Wall Mounting</i>	
Wall-Mounting Kit	7158078
ISO Trafo Kit 115 V Wall Mounting	7159340
ISO Trafo Kit 230 V Wall Mounting	7158322
Connecting Box Kit Wall Mounting	7159613
Overcoat Housing Kit Wall Mounting	7159625
<i>Pole Mounting</i>	
Pole-Mounting Kit	7157782
ISO Trafo Kit 115 V Pole Mounting	7159623
ISO Trafo Kit 230 V Pole Mounting	7159621
Connecting Box Kit Pole Mounting	7159612
Overcoat Housing Kit Pole Mounting	7159624

The manufacturer reserves the right to replace the spare parts listed above by equivalent substitutes.

Note: Only the spare parts listed above are FRUs (= Field Replaceable Units) and can be replaced by the user. For replacement of any other parts, please send the entire Remote Unit back to the manufacturer.

7. INDEX

A		H	
Address of Andrew Wireless Systems GmbH.....	10	Health and Safety Warnings.....	6
Alarms		I	
Alarm Status	35	Illustrations	43
Bite and Alarms	35	Installation	
External Inputs.....	37, 38	Electrical	20
Handling of Alarms	35	Mechanical	14
List	38	M	
Outputs	37, 38	Maintenance	39
RU	38	Mounting	
Status LED.....	35	Fan Protection	19
Andrew Solutions.....	8	Pole (Outside).....	17
C		Wall.....	16
Cleaning the Heat Sink	42	O	
Commissioning		Optical-Fibre Connection	
General	31	Protective Plug	27
Components		Protective-Tube Kit	29
Accessories	12	Outputs	
Fan-Protection Kit.....	12	Location	22
Connection Rules		P	
Optical-Fibre Cables	26	Pin Assignment	
Connections		External Alarms	37
Antenna	24	R	
Connector Flange	22	Replacement of Fan Unit.....	40
Optical-Fibre Cable.....	26	S	
Power	25	Spare Parts	45
Contact Addresses	9	Specifications	
Customer Support Addresses.....	9	Electrical	44
E		Environmental and Safety.....	44
External Inputs		Mechanical	44
Location	22	T	
F		Troubleshooting.....	38
Flange Connector			
5 poles	37		
7 poles	37		
G			
Grounding.....	23		