

# Optical Remote Unit

## ION™-M17HP/19HP (ML-Cabinet)



**Manual**  
**MF0143AXA**

© Copyright 2011 CommScope, Inc.

All rights reserved.

Andrew Solutions is a trademark of CommScope, Inc.

All information contained in this manual has been revised thoroughly. Yet Andrew Solutions accepts no liability for any omissions or faults.

Andrew Solutions reserves the right to change all hard- and software characteristics without notice.

Names of products mentioned herein are used for identification purposes only and may be trademarks and / or registered trademarks of their respective companies.

No parts of this publication may be reproduced, stored in a retrieval system, transmitted in any form or by any means, electronical, mechanical photocopying, recording or otherwise, without prior written permission of the publisher.

Andrew Wireless Systems GmbH, 20-October-2011

---

## TABLE OF CONTENTS

<b>1. GENERAL</b>	<b>6</b>
1.1. USED ABBREVIATIONS	6
1.2. HEALTH AND SAFETY WARNINGS	7
1.3. ABOUT ANDREW SOLUTIONS	9
1.4. INTERNATIONAL CONTACT ADDRESSES FOR CUSTOMER SUPPORT	10
<b>2. FUNCTIONAL DESCRIPTION</b>	<b>12</b>
2.1. PURPOSE	12
2.2. THE ION-M17HP/19HP (INTELLIGENT OPTICAL NETWORK; MMR)	12
<b>3. COMMISSIONING</b>	<b>15</b>
<b>3.1. MECHANICAL INSTALLATION</b>	<b>15</b>
3.1.1. General	15
3.1.2. Wall Mounting of RU	17
3.1.3. Pole Mounting of RU	18
<b>3.2. ELECTRICAL INSTALLATION</b>	<b>20</b>
3.2.1. General	20
3.2.2. Connections	21
3.2.3. Grounding	22
<b>3.3. CONNECTION OF THE ANTENNA CABLES</b>	<b>23</b>
<b>3.4. POWER CONNECTION</b>	<b>23</b>
<b>3.5. OPTICAL-FIBRE-CABLE CONNECTION - RULES</b>	<b>24</b>
3.5.1. Protective Plug	27
3.5.2. Protective-Tube Kit	29
<b>3.6. COMMISSIONING</b>	<b>31</b>
<b>4. ALARMS</b>	<b>35</b>
4.1. BITE AND ALARMS	35
4.2. HANDLING OF ALARMS	35
4.3. ALARM STATUS	35
4.4. STATUS LED ALARMS	36
4.5. EXTERNAL ALARM INPUTS AND OUTPUTS	37

---

<b>4.6.</b>	<b>TROUBLESHOOTING</b>	<b>38</b>
<b>5.</b>	<b>MAINTENANCE</b>	<b>39</b>
<b>5.1.</b>	<b>GENERAL</b>	<b>39</b>
<b>5.2.</b>	<b>REPLACING THE FAN UNIT</b>	<b>40</b>
<b>5.3.</b>	<b>CLEANING THE HEAT SINK</b>	<b>41</b>
<b>6.</b>	<b>APPENDIX</b>	<b>42</b>
<b>6.1.</b>	<b>ILLUSTRATIONS</b>	<b>42</b>
<b>6.2.</b>	<b>SPECIFICATIONS</b>	<b>43</b>
6.2.1.	Electrical Specifications	43
6.2.2.	Mechanical Specifications	43
6.2.3.	Environmental and Safety Specifications	43
<b>6.3.</b>	<b>SPARE PARTS</b>	<b>44</b>
<b>7.</b>	<b>INDEX</b>	<b>45</b>

**FIGURES AND TABLES**

figure 3-1 Mounting bracket installation ..... 17

figure 3-2 RU wall mounting ..... 17

figure 3-3 Pole-mounting kit, view from different sides ..... 18

figure 3-4 Pole-mounting, ML-cabinet, assembly drawing ..... 19

figure 3-5 Pole mounting of RU, finished ..... 19

figure 3-6 Connector flange of ION-M17HP/19HP ..... 21

figure 3-7 RS485 connector ..... 22

figure 3-8 Grounding bolt ..... 22

figure 3-9 Grounding bolt, schematic view ..... 22

figure 3-10 AC power supply plug ..... 23

figure 3-11 Protective-plug assembly ..... 27

figure 3-12 Tube-kit installation ..... 30

figure 4-1 Flange connector, 5 poles ..... 37

figure 4-2 Flange connector, 7 poles ..... 37

figure 4-3 Alarm inputs and outputs, standard ..... 38

figure 5-1 Fan unit and heat sink ..... 40

figure 6-1 Cabinet drawing ..... 42

table 1-1 List of international contact addresses ..... 11

table 3-1 Specified torques ..... 16

table 3-2 RS485 connector, pin assignment ..... 22

table 4-1 Status LED alarms ..... 36

## 1. GENERAL

### 1.1. USED ABBREVIATIONS

3GPP	3 <sup>rd</sup> Generation Partnership Project
4G	4 <sup>th</sup> Generation
ALC	Automatic Level Control
AMPS	American Mobile Phone System or Advanced Mobile Phone System
AWS	Advanced Wireless Services
BBU	Battery Backup Unit
BCCH	Broadcast Control Channel
BITE	Built-In Test Equipment
BTS	Base Transceiver Station
CDMA	Code Division Multiple Access
CEPT	Conférence Européenne des Postes et Télécommunications
CF	Center Frequency
CFO	Center Frequency Offset
CPD	Channel Power Detection
DL	Downlink
DoC	Declaration of Conformity
EDGE	Enhanced Data Rates for GSM Evolution
ESD	Electrostatic Discharge
ETS	European Telecommunication Standard
ETSI	European Telecommunication Standards Institute
FCC	Federal Communications Commission
FSK	Frequency Shift Keying
GSM	Global System for Mobile Communication
GUI	Graphical User Interface
I <sup>2</sup> C-Bus	Inter Integrated Circuit Bus (Philips)
ID No	Identification Number
IF	Intermediate Frequency
LMT	Local Maintenance Terminal
LNA	Low-Noise Amplifier
LO	Local Oscillator
LTE	Long Term Evolution
MIMO	Multiple Input Multiple Output
MS	Mobile Station
OMC	Operation and Maintenance Center
OTRx	Optical Transceiver = SRMU (Subrack Master Unit)
PCMCIA	Personal Computer Modem Communication International Association
PCS	Personal Communication System
PSTN	Public Switched Telephone Network
R&TTE	Radio & Telecommunications Terminal Equipment
Rev	Revision
RF	Radio Frequency
RLP	Radio Link Protocol
RSSI	Receive Signal Strength Indication
RTC	Real-Time Clock
RX	Receiver

SCL	Serial Clock
SDA	Serial Data
SISO	Single Input Single Output
SPD	Switching Point Detector
SRMU	Subrack Master Unit = OTRx (Optical Transceiver)
TCH	Traffic Channel
TDD	Time-Division Duplex
TDMA	Time Division Multiple Access
TX	Transmitter
UL	Uplink
UMR	Universal Measurement Receiver
UMTS	Universal Mobile Telecommunication System
UPS	Uninterruptible Power Supply
VSWR	Voltage Standing Wave Ratio
WDM	Wavelength Division Multiplex
WiMAX	Worldwide Interoperability for Microwave Access

## 1.2. HEALTH AND SAFETY WARNINGS



1. Only suitably qualified personnel is allowed to work on this unit and only after becoming familiar with all safety notices, installation, operation and maintenance procedures contained in this manual.
2. Read and obey all the warning labels attached to the unit. Make sure that the warning labels are kept in a legible condition and replace any missing or damaged labels.
3. Obey all general and regional installation and safety regulations relating to work on high voltage installations, as well as regulations covering correct use of tools and personal protective equipment.
4. Keep operating instructions within easy reach and make them available to all users.
5. It is the responsibility of the network provider to implement prevention measures to avoid health hazards which may be associated to radiation from the antenna(s) connected to the unit.
6. For US and Canadian installations: To comply with FCC RF exposure compliance requirements, the following antenna installation and device operating configurations must be satisfied: A separation distance of at least 4 m must be maintained between the antenna of this device and all persons. RF exposure compliance may need to be addressed at the time of licensing, as required by the responsible FCC Bureau(s), including antenna co-location requirements of 1.1307(b)(3). Maximum permissible antenna gain is 17 dBi.

**7. Note for a Class A digital device or peripheral:**

**This equipment has been tested and found to comply with the limits for a Class A digital device, pursuant to part 15 of the FCC Rules. These limits are designed to provide reasonable protection against harmful interference when the equipment is operated in a commercial environment. This equipment generates, uses, and can radiate radio frequency energy and, if not installed and used in accordance with the instruction manual, may cause harmful interference to radio communications. Operation of this equipment in a residential area is likely to cause harmful interference in which case the user will be required to correct the interference at his own expense.**

8. Make sure, access is restricted to qualified personnel.
9. Only license holders for the respective frequency range are allowed to operate this unit.
10. Corresponding local particularities and regulations must be observed. For national deviations please refer to the respective documents included in the manual CD delivered.
11. Use this equipment only for the purpose specified by the manufacturer. Do not carry out any modifications or fit any spare parts which are not sold or recommended by the manufacturer. This could cause fires, electric shock or other injuries.
12. Due to power dissipation, the repeater may reach a very high temperature. Do not operate this equipment on or close to flammable materials.
13. Before opening the unit, disconnect power supply.
14. ESD precautions must be observed! Before commencing maintenance work, use the available grounding system to connect ESD protection measures.
15. This unit complies with European standard EN60950.
16. Make sure the repeater settings are according to the intended use (see also product information of manufacturer) and regulatory requirements are met.
17. Although the repeater is internally protected against overvoltage, it is strongly recommended to earth the antenna cables close to the repeater's antenna connectors for protection against atmospheric discharge.
18. Laser radiation! Do not stare into the beam; do not view it directly or with optical instruments.





### 1.3. ABOUT ANDREW SOLUTIONS

*Andrew Wireless Systems GmbH* based in Buchdorf/ Germany, is a leading manufacturer of coverage equipment for mobile radio networks, specializing in high performance, RF and optical repeaters. Our optical distributed networks and RF repeater systems provide coverage for every application: outdoor use, indoor installations, tunnels, subways and many more.

*Andrew Wireless Systems GmbH* has unparalleled experience in providing RF coverage and capacity solution for wireless networks in both indoor and outdoor environment and belongs to *Andrew Solutions, a CommScope Company*.

*Andrew Solutions* is the foremost supplier of one-stop, end-to-end radio frequency (RF) solutions. Our products are complete solutions for wireless infrastructure from top-of-the-tower base station antennas to cable systems and cabinets, RF site solutions, signal distribution, and network optimization.

*Andrew Solutions* has global engineering and manufacturing facilities. In addition, it maintains field engineering offices throughout the world.

We operate a quality management system in compliance with the requirements of ISO 9001. All equipment is manufactured using highly reliable material. In order to ensure constant first-rate quality of the products, comprehensive quality monitoring is conducted at all fabrication stages. Finished products leave the factory only after a thorough final acceptance test, accompanied by a test certificate guaranteeing optimal operation.

☞ **Note:** **Exceptions of and national deviations from this intended use may be possible. To observe corresponding local particularities and regulations, please refer to the respective documents (also in national language) which are included in the manual CD delivered.**

To make the most of this product, we recommend you carefully read the instructions in this manual and commission the system only according to these instructions.

For technical assistance and support, please also contact the local office or *Andrew Solutions* directly at one of the addresses listed in the following section.

## 1.4. INTERNATIONAL CONTACT ADDRESSES FOR CUSTOMER SUPPORT

### Americas:

<b>Canada</b>	
<b>Andrew Solutions Canada</b>	
Mail	620 North Greenfield Parkway Garner, NC 27529 U.S.A.
Phone	+1-905-878-3457 (Office) +1 416-721-5058 (Mobile)
Fax	+1-905-878-3297
E-mail	Peter.Masih@andrew.com WIsupport.us@andrew.com

<b>United States</b>	
<b>Andrew Solutions, Andrew LLC, A CommScope Company</b>	
Mail	620 North Greenfield Parkway Garner, NC 27529 U.S.A.
Phone	+1-888-297-6433
Fax	+1-919-329-8950
E-mail	WIsupport.us@andrew.com

<b>Brazil &amp; South America</b>	
<b>Andrew Solutions, A CommScope Company</b>	
Mail	Av. Com. Camilo Julio 1256 Predio B Zonal Industrial CP 597 Sorocaba SP 18086-000 Brazil
Phone	+ 55-15-9104-7722
Fax	+ 55-15-2102-4001
E-mail	WIsupport@andrew.com

<b>Mexico, Central America &amp; Caribbean region</b>	
<b>Andrew Solutions Mexico</b>	
Mail	Monte Elbruz 124-402A Col. Palmas Polanco 11560 Mexico, D.F. Mexico
Phone	+ 52-55-1346-1900 (Office) +52-1-55-5419-5260 (Mobile)
Fax	+52-55-1346-1901
E-mail	WIsupport@andrew.com

### APAC Countries:

<b>China</b>	
<b>Andrew Solutions Hong Kong</b>	
Mail	Room 915 Chevalier Commercial Centre 8 Wang Hoi Rd Kowloon Bay SAR Hong Kong
Phone	+852-310-661-00
Fax	+852-2751-7800
E-mail	WISupport.china@andrew.com

<b>Australia</b>	
<b>Andrew Corporation (Australia) LLC Pty Ltd.</b>	
Mail	Unit 1 153 Barry Road Campbellfield VIC 3061 Australia
Phone	+613-9300-7969
Fax	+613-9357-9110
E-mail	WIsupport.australia@andrew.com

## Europe:

<b>United Kingdom</b>		<b>France</b>	
	<b>Andrew Solutions UK Ltd</b> Unit 15, Ilex House Mulberry Business Park Fishponds Road Wokingham Berkshire RG41 2GY England		<b>Andrew Solutions France</b> 28, Rue Fresnel Z.A Pariwest BP 182 78313 Coignières Cedex France
Mail		Mail	
Phone	+44-1189-366-792	Phone	+33 1 30 05 45 50
Fax	+44-1189-366-773	Fax	+33 1 34 61 13 74
E-mail	Wlsupport.uk@andrew.com	E-mail	Wlsupport@andrew.com
<b>Germany</b>		<b>Czech Republic</b>	
	<b>Andrew Wireless Systems GmbH</b> Industriering 10 86675 Buchdorf Germany		<b>Andrew Solutions Czech Republic C-Com, spol. s r.o</b> U Moruší 888 53006 Pardubice Czech Republic
Mail		Mail	
Phone	+49-9099-69-0	Phone	+420-464-6280-80
Fax	+49-9099-69-930	Fax	+420-464-6280-94
E-mail	Wlsupport@andrew.com	E-mail	Wlsupport@andrew.com
<b>Austria</b>		<b>Switzerland</b>	
	<b>Andrew Wireless Systems (Austria) GmbH</b> Weglgasse 10 Wien-Schwechat 2320 Austria		<b>Andrew Wireless Systems AG</b> Tiergartenweg 1 CH-4710 Balsthal Switzerland
Mail		Mail	
Phone	+43-1706-39-99-10	Phone	+41-62-386-1260
Fax	+43-1706-39-99-9	Fax	+41-62-386-1261
E-mail	Wlsupport.austria@andrew.com	E-mail	support.ch@andrew.com
<b>Italy</b>		<b>Spain and Portugal</b>	
	<b>Andrew Wireless Systems S.r.l., Faenza, Italy</b> Via de Crescenzi 40 Faenza 48018 Italy		<b>Andrew Solutions España S.A. A Commscope Company</b> Avda. de Europa, 4 - 2ª pta. Parque Empresarial La Moraleja 28108 Alcobendas (Madrid) Spain
Mail		Mail	
Phone	+39-0546-697111	Phone	+34-91-745-20 40
Fax	+39-0546-682768	Fax	+34-91-661-87 02
E-mail	Wlsupport.italia@andrew.com	E-mail	Wlsupport.iberia@andrew.com

table 1-1 List of international contact addresses

## **2. FUNCTIONAL DESCRIPTION**

### **2.1. PURPOSE**

Cellular telephone systems transmit signals in two directions between base transceiver station (BTS) and mobile stations (MS) within the signal coverage area.

If weak signal transmissions occur within the coverage area because of indoor applications, topological conditions or distance from the transmitter, extension of the transmission range can be achieved by means of an optical distribution system.

Such a system contains an optical Master Unit and several Remote Units. The number of the Remote Units depends on the hardware and software configuration. The Remote Units are connected to the Master Unit with optical links. The optical loss must be less than 10 dB inclusive optical couplers or splitters.

The Master Unit is the connection to the base transceiver stations. The configuration of a Master Unit depends on the number of the Remote Units and the frequency range.

WDM (Wave Division Multiplex) filters are integrated in the optical modules. For the UL, a wavelength within 1540 nm – 1562 nm is used. For the DL, a wavelength of 1310 ±20 nm is used. The maximum output power for the UL and DL is 5.7 mW.

### **2.2. THE ION-M17HP/19HP (INTELLIGENT OPTICAL NETWORK; MMR)**

The ION-M17HP/19HP is a multi-band multi-operator Remote Unit with various extension options. It is used in conjunction with a master unit in the ION optical distribution system. This system transports multiple frequency bands simultaneously (1900 MHz and 1700/2100 MHz), providing a cost-effective solution for distributing capacity from one or more base stations.

The ION-M17HP/19HP transports signals on the RF layer in a very inexpensive manner. This means that multiple operators and multiple technologies are moved simultaneously from a cluster of base stations to a remote location over the same fiber.

The ION optical distribution system is a cost-effective coverage solution for dense urban areas, tunnels, subway, airports, convention centers, high-rise buildings and other locations where physical structures increase path loss. It has been specifically designed to reduce zoning problems and to provide homogeneous coverage. The compact, mechanical design is specifically architected to mount inside of poles or along side structures in such a way that it has a minimal visual impact.

The ION-M17HP/19HP is available in a multi-band configuration supporting 1900 MHz and 1700/2100 MHz in parallel. It has been specifically tested and optimized for GSM, EDGE, HSPA+, OFDM, EV-DO and WCDMA. Furthermore it is provisioned for future improvements to the modulation and frequency bands.

The ION is easily set-up and supervised via a graphical user interface (GUI). Remote Units can be commissioned through the use of built-in test equipment. An auto-leveling function compensates for the optical link loss making installation easy and quick. The entire system may be monitored remotely via an Andrew OMC.

This is a comprehensive management platform with SNMP protocol and X.733 standard implemented. Should a sophisticated interface not be required, the master unit can be directly connected to the alarm interface of a base station via relay alarming.

**Features at a glance:**

- Multi-band, multi-operator support
- Reduced visual impact form factor
- Efficient, high power amplifier
- Single fiber for multiple bands and multiple remotes
- Comprehensive operations and management system for configuration and alarming
- OMC with SNMP according to X.733 standard
- 3GPP TS25.143/TS25.106/ TS36.143/TS36.106 and 3GPP2C.S0051-0 compliant
- Easy installation and commissioning

**For your notes:**

### 3. COMMISSIONING

#### 3.1. MECHANICAL INSTALLATION

##### 3.1.1. General

Read the health and safety warnings in section 1.2 *Health and Safety Warnings*.

1. Do not install the unit in a way or at a place where the specifications outlined in the Environmental and Safety Specifications leaflet of the supplier are not met.
2. Use the mounting hardware delivered by the manufacturer only. If different mounting hardware is used, the specifications for stationary use of the Remote Unit must not be exceeded.

 **Note:** Exceeding the specified load limits may cause the loss of warranty!



3. The unit is considerably heavy. Ensure that a suitable mounting surface is used. Ensure there is adequate manpower to handle the weight of the system.
4. Due to power dissipation the Remote Unit can reach very high temperatures. Sufficient airflow for ventilation must be ensured as specified in the individual mounting procedures.
5. When connecting and mounting the cables (RF, optical, power supply, ...) ensure no water can penetrate into the unit through these cables.
6. Also observe all additional rules or restrictions regarding mounting that depend on the type of Remote Unit. For details refer to section 7.2.2 *Mechanical Specification*. Install the unit vertically with the fan unit at the top. A maximum tilt angle of 25° from a vertical position must be kept, as in the following illustrations:

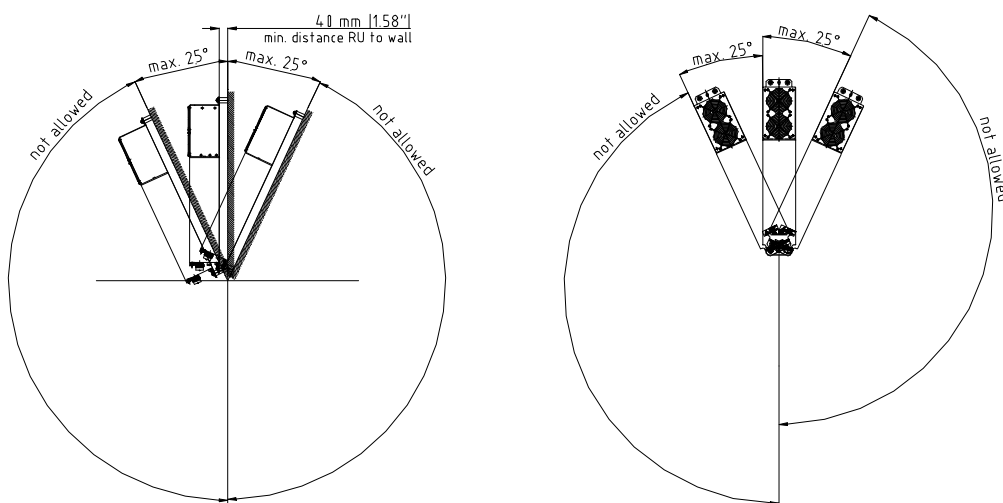

7. A spacing of 40 mm (1.58 inch) around the unit is required.
8. To ensure sufficient airflow when mounting the unit in enclosed spaces, two lid openings (one for the air inlet and the other for the air outlet) have to be provided. Do not block these air inlets and outlets when mounting the Remote Unit. The size of each opening must equal at least 17 x 17 cm (290 cm<sup>2</sup>). Make sure, too, there is no thermal short circuit between the air inlet and air outlet.

If any different or additional mounting material is used, ensure that the mounting remains as safe as the mounting designed by the manufacturer. Ensure that the static and dynamic strengths are adequate for the environmental conditions of the site. **The mounting itself must not vibrate, swing or move in any way that might cause damage to the Remote Unit.**

Specified torques have to be observed for certain mounting procedures according to the following table:

<i>Type</i>	<i>Lens head screws</i>	<i>Hex nuts</i>	<i>Spacing bolts</i>		<i>PG (plastic)</i>	<i>PG (aluminium)</i>
<i>Thread</i>	M 4	M 8	M 4	M 8	PG 13.5	PG 29
<i>Specified torques</i>	3.3 Nm	27 Nm	2.3 Nm	27 Nm	3.75 Nm	10 Nm

*table 3-1 Specified torques*

 **Note:** To avoid damage when mounting the unit, always make sure that the M8 washers (DIN9021 or DIN125 depending on the mounting kit) are placed behind and in front of the mounting drillings of the unit.

The mounting procedures for a stand-alone Remote Unit without optional accessories are described and illustrated in the following sections. For further information regarding special mounting procedures including mounting of accessory equipment, please see separate manual.



### 3.1.2. Wall Mounting of RU

- Check the suitability of the wall-mounting kit and the wall.
- Mark the position of the drilling holes (for measurements and a more detailed description refer to the wall mounting plan that is part of the delivery).
- Drill four holes at the marked positions and insert dowels\*.
- Screw the mounting brackets to the wall / dowels using the four dowel screws as illustrated in *figure 3-1 Mounting bracket installation*.
- For each bracket, first screw in the 2 washers, then the 2 spring washers, then the 2 M8x80 screws (see also *figure 3-1 Mounting bracket installation*).
- Hang the Remote Unit into the upper mounting bracket at a slight angle and let it move smoothly towards the wall so that it engages firmly into the brackets (see *figure 3-2 RU wall mounting*). Then, screw the Remote Unit to the lower mounting bracket using 2 of the M8x25 screws that are part of the delivery (4 are provided).
- Ensure that there is free access to the electrical connections as well as to the cabinet. The approved bending radius of the connected cables must not be exceeded.

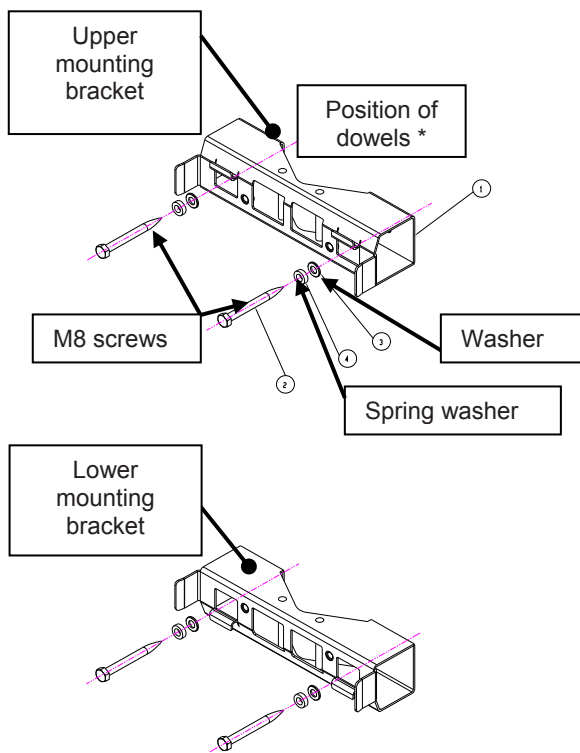

*figure 3-1 Mounting bracket installation*

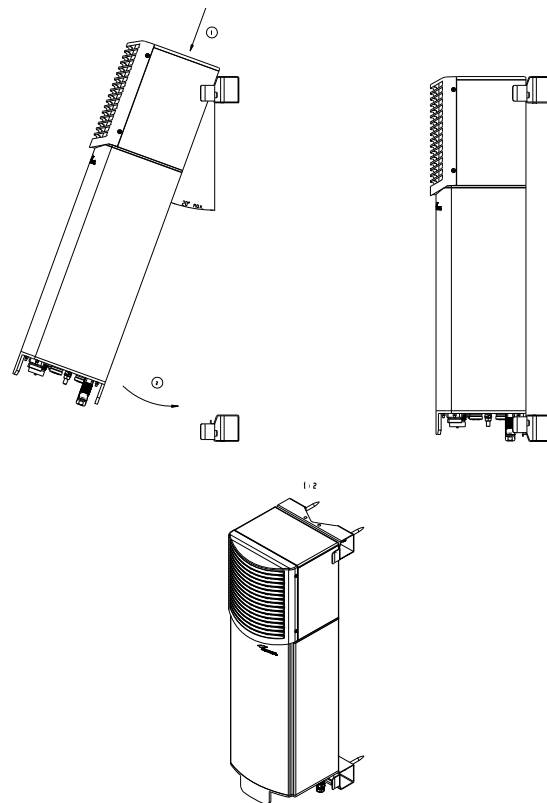

*figure 3-2 RU wall mounting*

\* The dowels are not part of the delivery since the suitable type depends on the on-site conditions (material of wall). Therefore, use dowels that are appropriate for the mounting surface.

### 3.1.3. Pole Mounting of RU

The standard mounting hardware also includes all parts required for pole mounting:

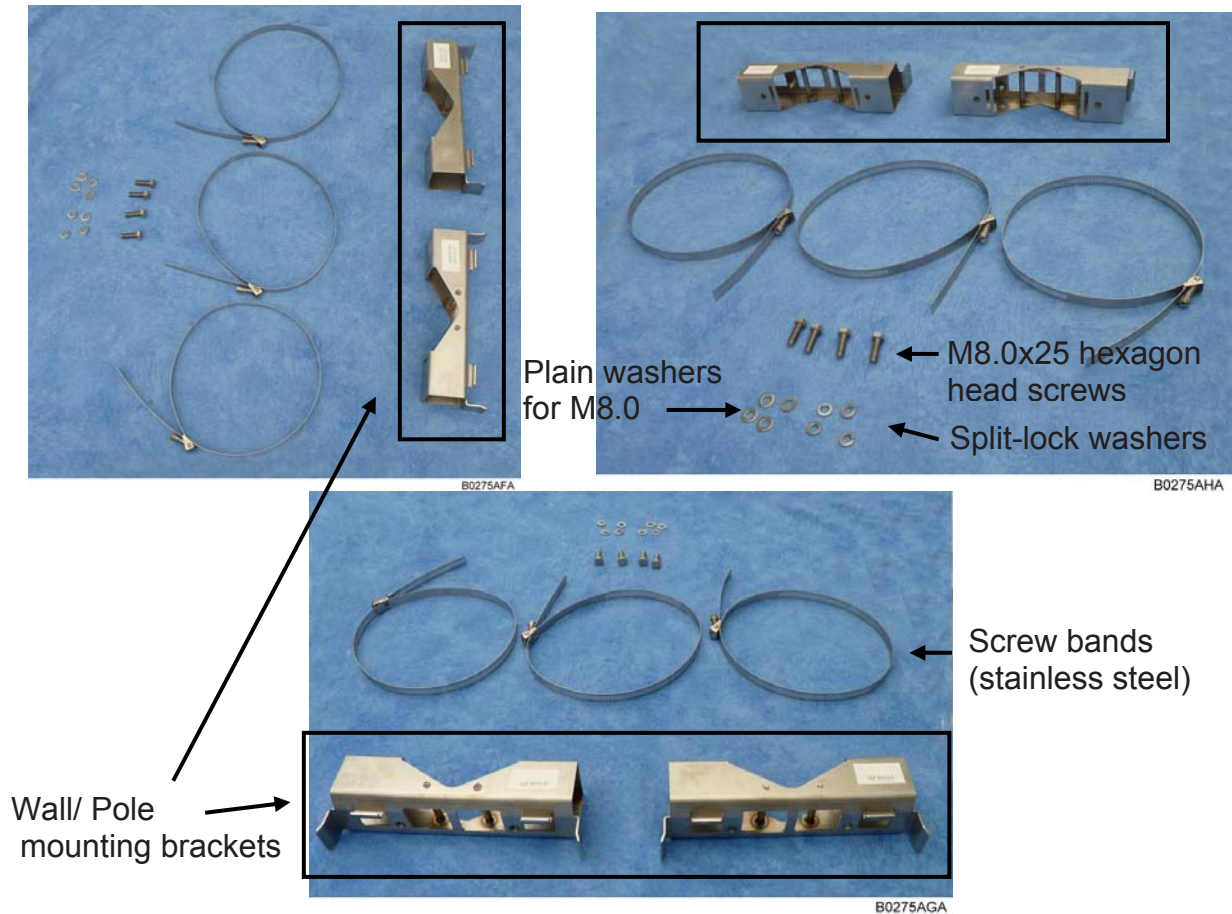

figure 3-3 Pole-mounting kit, view from different sides

**Note:** The screw bands illustrated above are equipped with quick-release snaplock clamps which must be disengaged to be applied. The swivel-action locking of screw to band makes installation and removal fast and easy.

- Use the 3 screw bands with clamps to fasten the two mounting brackets to the pole. Use 2 screw bands fitting next to each other on the upper side and 1 screw band on the lower side.

**Note:** When fastening the mounting brackets make sure that they are installed congruently and not at an angle to each other. To determine the distance between the beams, refer to the wall/ pole mounting plan that is part of the delivery.

- Hang the Remote Unit into the hooks of the upper mounting bracket and screw the Remote Unit to the lower mounting bracket.

Ensure that there is free access to the electrical connections as well as to the cabinet. The approved bending radius of the connected cables must not be exceeded.

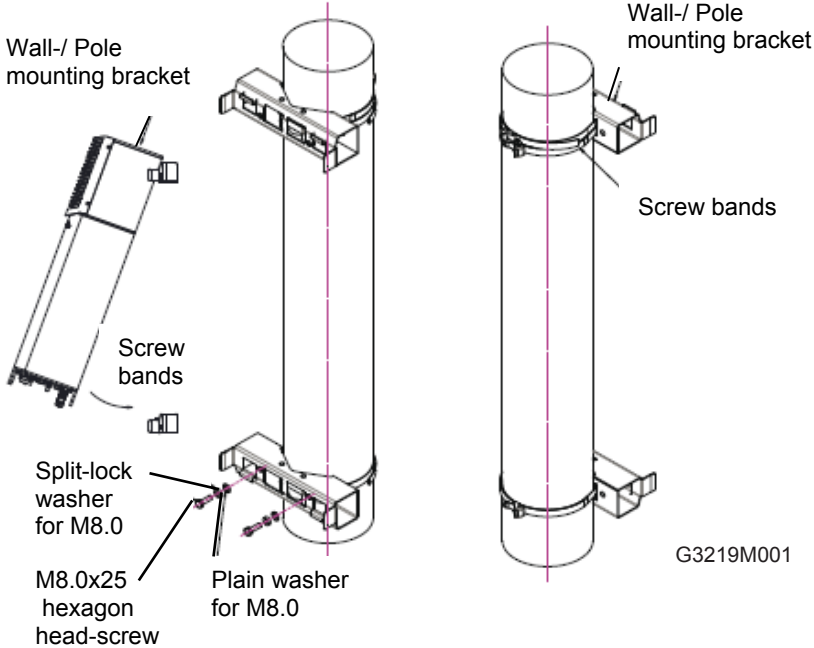

**Note:** All unmarked screw joints illustrated above have nominal tightening torque values according to QA 7.5.1.090/F1011P0.

*figure 3-4 Pole-mounting, ML-cabinet, assembly drawing*

Pole mounting finished  
(RU mounted to pole)

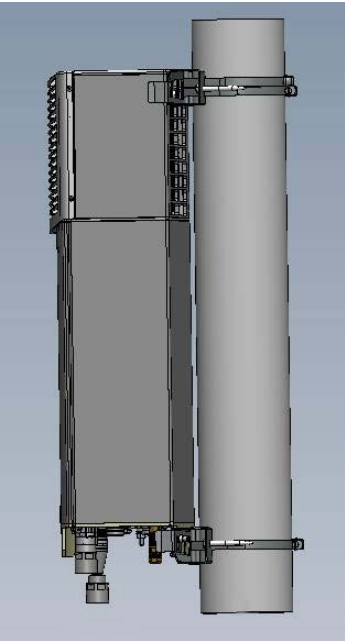

L\_G3219X000

*figure 3-5 Pole mounting of RU, finished*

## 3.2. ELECTRICAL INSTALLATION

### 3.2.1. General

Read the health and safety warnings in section *1.2 Health and Safety Warnings*.



1. This unit contains dangerous voltages. Loss of life, severe personal injury or property damage can be the result if the instructions contained in this manual are not followed.
2. Ground the unit before connecting power supply. A grounding bolt is provided on the cabinet to connect the ground-bonding cable.
3. Although the Remote Unit is internally protected against over-voltage, it is strongly recommended to earth the antenna cables close to the antenna connectors of the Remote Unit for protection against atmospheric discharge. In areas with strong lightning it is highly recommended to insert additional lightning protection.
4. If the mains connector of the Remote Unit is not easily accessible, a disconnect device in the mains circuit must be provided within easy reach.
5. Before connecting or disconnecting the mains connector at the Remote Unit, ensure that mains supply is disconnected.
6. Make sure that an appropriate circuit breaker and an over-current limiting device are connected between mains and Remote Unit.
7. A connection of mains supply to a power socket requires the power socket to be nearby the Remote Unit.
8. Incorrectly wired connections can destroy electrical and electronic components.
9. To avoid corrosion at the connectors caused by electrochemical processes, the material of the cable connectors must not cause a higher potential difference than 0.6 V (see electrochemical contact series).
10. Use an appropriate torque wrench for the coupling torque (25 N-m / 19 ft lb) of 7-16 DIN connectors with 1-1/4 in opening to tighten the 7/16-type antenna connectors. For example, use torque wrench of item no. 244377 available from the *Andrew e-catalog*. Do NOT use your hands or any other tool (e.g. a pair of pliers)! This might cause damage to the connector and lead to a malfunction of the Remote Unit.
11. Use a voltage limiting device for unstabilized electric networks that frequently generate spikes.

12. The unit complies with the surge requirement according to EN 61000-4-5 (fine protection); however, it is recommended to install an additional medium (via local supply connection) and/or coarse protection (external surge protection), depending on the individual application, in order to avoid damage caused by overcurrent.
13. Observe the labels on the front panels before connecting or disconnecting any cables.

### 3.2.2. Connections

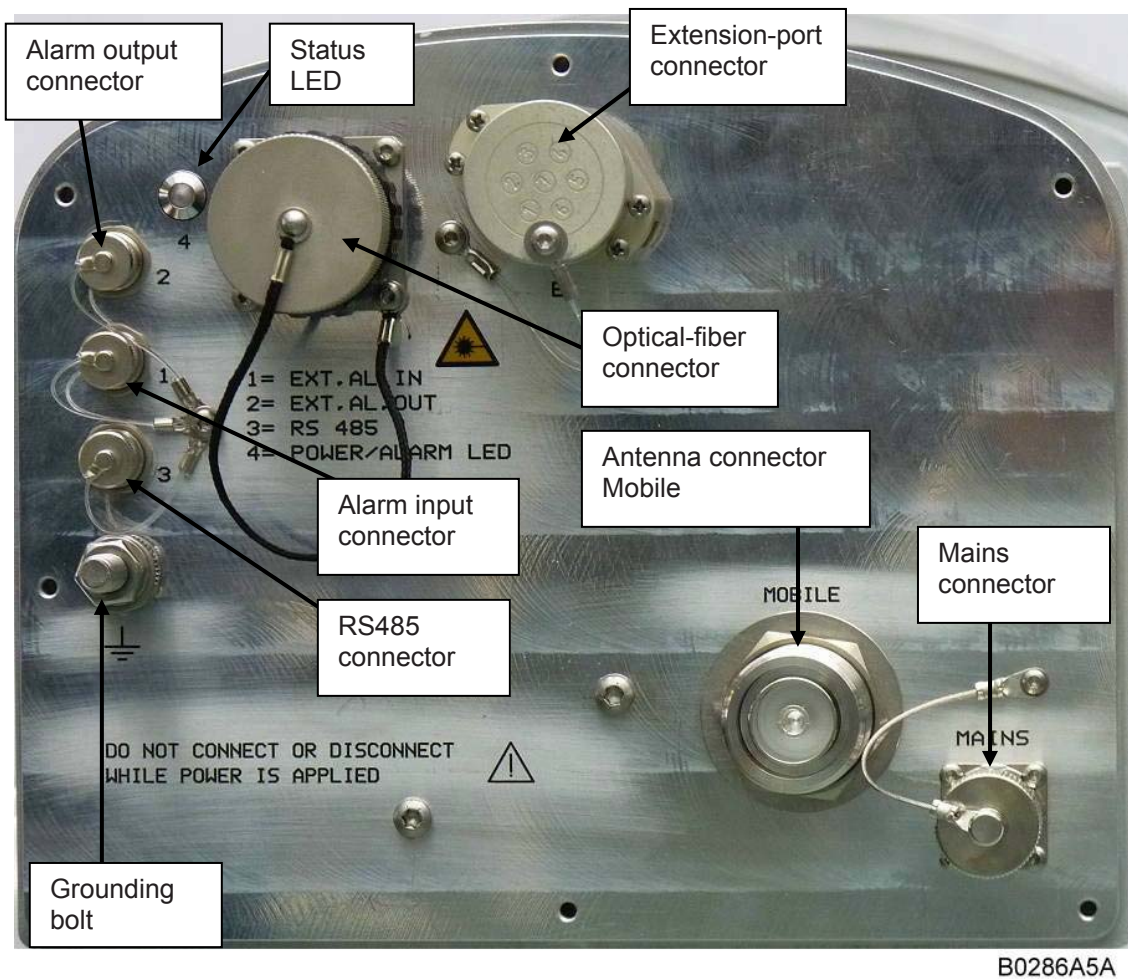
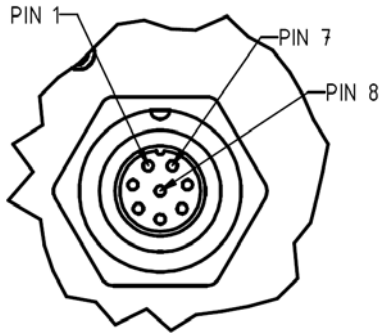

figure 3-6 Connector flange of ION-M17HP/19HP



### **Control Connector (RS485 / RS232)**

This 8-pin male connector (type: Binder Series 712) primarily supports control of the Extension Unit via RS485 bus.



*figure 3-7 RS485 connector*

<b>PIN</b>	<b>Assignment</b>
1	not connected
2	RS232 Rx
3	RS232 Tx
4	not connected
5	GND (RS232)
6	RS485 R+/D+
7	RS485 GND
8	RS485 R-/D-

*table 3-2 RS485 connector, pin assignment*

### **3.2.3. Grounding**

Grounding must be carried out. Connect an earth-bonding cable to the grounding connection provided at the outside of the Remote Unit (see section 3.2.2 *Connections*). Do not use the grounding connection to connect external devices.



*figure 3-8 Grounding bolt*

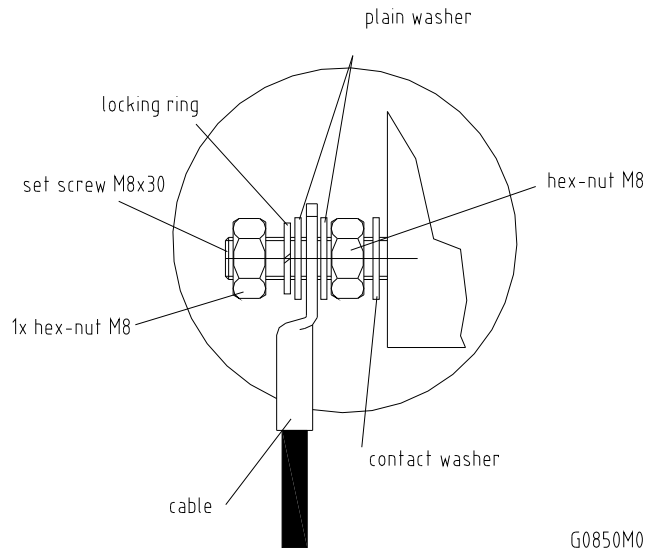

*figure 3-9 Grounding bolt, schematic view*

After loosening the hex nut, connect the earth-bonding cable between the two washers as illustrated in the figures above. Then, fasten all parts again with the hex nut.

### 3.3. CONNECTION OF THE ANTENNA CABLES

The Remote Unit has 7/16-type antenna connectors. For its location please refer to section 3.2.2 *Connections*. For mounting the cable connectors, it is recommended to refer to the corresponding documentation of the connector manufacturer. The bending radius of the antenna cables must remain within the given specifications.

For the selection of cable and antenna it should be considered that, on the one hand, a cable with higher loss is less expensive but, on the other hand, it impairs performance.



**Use an appropriate torque wrench for the coupling torque (25 N-m/ 19 ft lb) of 7-16 DIN connectors with 1-1/4 in opening to tighten the 7/16-type antenna connectors. For example, use torque wrench of item no. 244377 available from the *Andrew e-catalog*. Do NOT use your hands or any other tool (e.g. a pair of pliers)! This might cause damage to the connector and lead to a malfunction of the Remote Unit.**



**To minimize passive inter-modulation (PIM) distortion, attention has to be paid to the physical condition of the connector junctions. Do not use connectors that show signs of corrosion on the metal surface. Prevent the ingress of water into the connector. Attach and torque the connectors properly.**

### 3.4. POWER CONNECTION

Before connecting electrical power to the units, the system must be grounded as described in the previous section.

Mains power must be connected at the power supply connector of the unit (see section 3.2.2 *Connections*).

The power supply plug is part of the delivery. The correct wiring of the power supply plug is as follows:

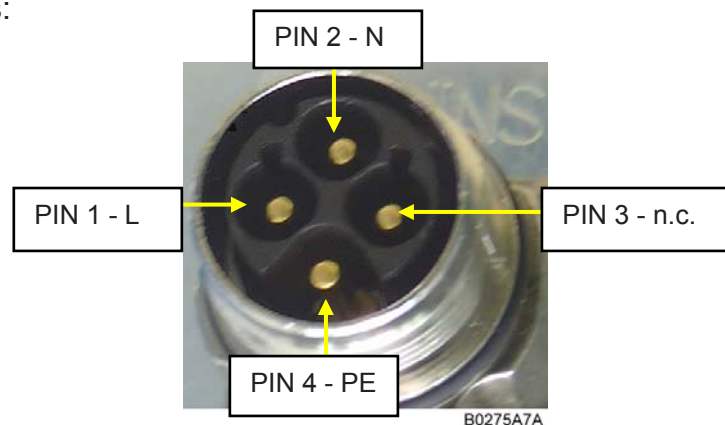

*figure 3-10 AC power supply plug*



For the AC power supply connection, a minimum cross section of 1.5 mm<sup>2</sup> is required. Each wire must observe the applicable national regulations regarding loop impedance, voltage drop, and methods of installation. Make sure to connect the correct voltage to the unit.

**Note:** Do not connect or disconnect the power cord at the power supply connector while power is on. Turn off mains power \* before connecting the power cord at the Remote Unit, then, engage mains power again.

\* Mains power must be interruptible with an external power supply breaker. For the power supply breaker, observe the following recommendation:

120 Volt / 20 Amp max. or 240 Volt / 16 Amp, single-phase, 50 / 60 Hz AC service is needed, i.e. the external AC breaker should be 20 Amps max. for 120-Volt service or 16 Amps for 240-Volt service.

For the DC power supply, observe the local regulations of the DC service provider.

### 3.5. OPTICAL-FIBRE-CABLE CONNECTION - RULES

#### Main optical system parameters:

Fiber:

- Single mode fiber, type is E9/125 µm
- Attenuation: <0.36 dB / km @ 1310 nm / <0.26 dB / km @ 1550 nm
- Dispersion: <3.5 ps / nm km @ 1310 nm / <18.0 ps / nm km @ 1550 nm
- Fibre-cable connectors E2000APC8°

ION-M system:

- The specified bending radius ( < 4 cm) of the optical fibers must not be exceeded.
- The pigtails for the connection between Master Unit and Remote Unit must have a sufficient length. A protection for the feeding into units must be given.
- The system attenuation of the optical fibers, including the connectors, must not exceed 10 dB.

System attenuation and attenuation of optical components must be determined. This can be achieved by measuring attenuation and reflection with an appropriate measuring instrument. For pigtails, a total value of < 0.4 dB (measured to a reference plug) can be assumed due to the dead zone of the reflectometer. These measurements must be made with a sufficient length of optical fiber, at the input and output of the device which has to be measured.



## **Fiber-System Installation:**

Fiber-cable connectors have to be of the same type (E2000APC8°) as the connectors used for the unit. The fiber-optic cables are connected to the optical transceiver.



**Angled connectors are not compatible with straight optical connectors; non-compatibility of connectors will result in permanent damage to both connectors.**

Before connecting the fiber cables, follow the procedure below to ensure optimized performance. It is important for these procedures to be carried out with care:

- Remove fiber-optic protective caps.
- Do not bend the fiber-optic cable in a tight radius (< 4 cm) as this may cause cable damage and interrupt transmission.
- Using high-grade alcohol and lint-free cotton cleaning swabs, clean the end of the fiber-optic cable that will be inserted in the optical connectors on the donor interface box. Use a fiber end-face inspection tool to scan both, the class fiber and its surrounding area.
- Check for dirt on the cladding, chips/pits, dirt on the ferrule, and scratches.
- Connect the fiber-optic cables by inserting the cable end into the laser receptacle and aligning the key (on the cable end) with the keyed slot.
- Do not use any index-matching gels or fluids of any kind in these connectors. Gels are intended for laboratory use and attract dirt in the field.

👉 **Note:** Care should be taken when connecting and disconnecting fiber-optic cables - use the connector housing to plug or unplug a fiber. Scratches and dust significantly affect system performance and may permanently damage the connector. Always use protective caps on fiber-optic connectors not in use.

## Cleaning Procedure for Fiber-Optical Components:

Any contamination in the fiber connection results in additional optical transmission loss which could cause whole system failure. It is thus recommended that every fiber connector be inspected and cleaned prior to mating.

The goal is to eliminate any dust or contamination and to provide a clean environment for the fiber-optic connection.

When you clean fiber components, always complete the following steps carefully:

1. Turn off the ION system (laser sources) before you inspect fiber connectors.



**Never look into a fiber while the system lasers are on!**

2. Check the connectors or adapters with a fiberscope before cleaning.
3. If the connector is dirty, clean it with a lint-free wipe (dry cleaning).
4. Inspect the connector.
5. If the connector is still dirty, repeat the dry cleaning technique.
6. Inspect the connector.
7. If the connector is still dirty, clean it with 99% isopropyl alcohol (wet cleaning) followed immediately with a dry clean in order to ensure no residue is left on the endface.
8. Repeat steps 5 through 7 until endface is clean.

Note: For a more detailed description please refer to:

[http://www.cisco.com/en/US/tech/tk482/tk876/technologies\\_white\\_paper09186a0080254eba.shtml](http://www.cisco.com/en/US/tech/tk482/tk876/technologies_white_paper09186a0080254eba.shtml)

**3.5.1. Protective Plug**

**Connection:**

A protective plug is provided for the connection of the fiber-optic cables.

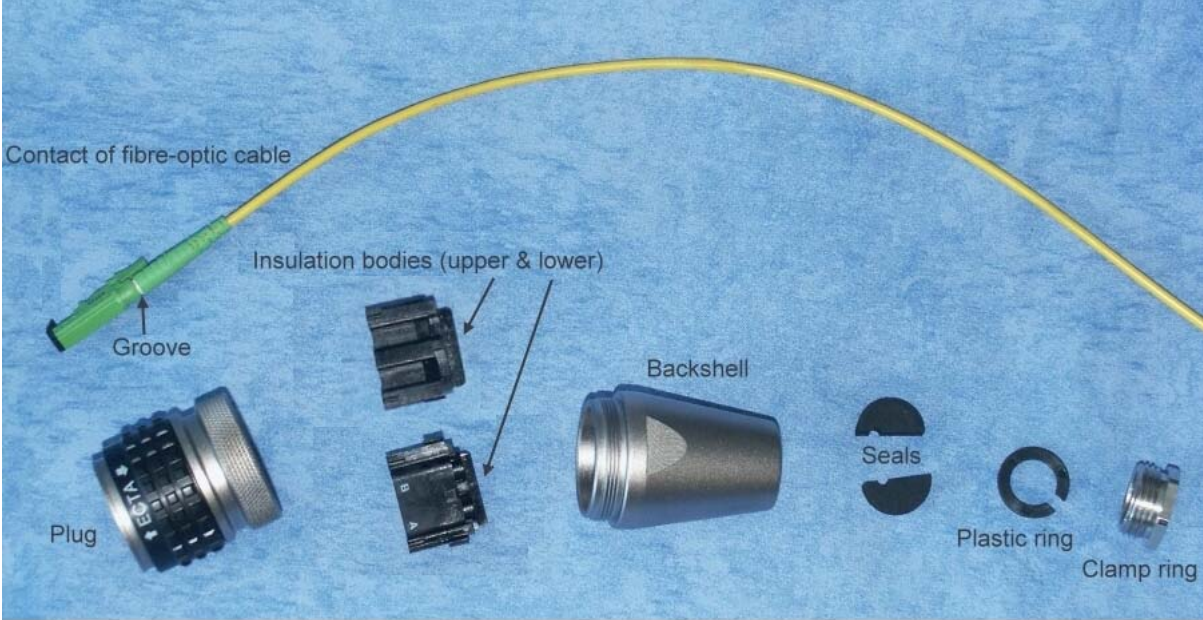

B0122AMA

*figure 3-11 Protective-plug assembly*

**Note:** Only high-quality connectors must be used for this type of plug. Qualified brands are Diamond or Huber & Suhner.

For plug assembly, observe the following instruction:

1. Pass one or two contacts through the backshell and the clamp ring.



B0122A1A

2. Place the contact(s) on the lower insulation body by pushing the groove of the contact into the cavity. If there is only one contact, cavity A **must** be used. \*
3. Then, mount the upper insulation body on the lower insulation body. \*\*

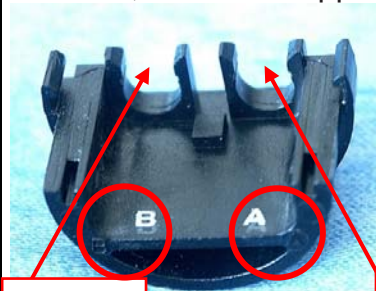

Cavity B

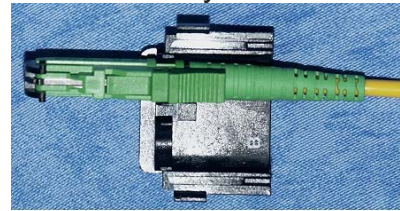

B0122ALA

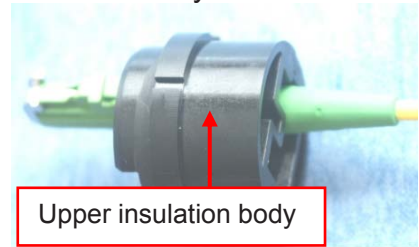

Upper insulation body

B0122A4A

4. Bring the insulator into the plug. The narrow groove of the insulator must be fitted into the stamp of the plug.

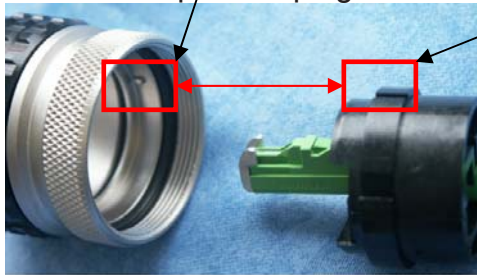

B0122AEA



B0122A6A

- \* To release the contact for disassembling, push the inner snap to the side and pull the contact out.
- \*\* To release upper and lower insulation bodies for disassembling, use a small screwdriver and carefully open the snap-connections at the left and the right side of the insulator without damaging them.

5. Fasten the insulator by screwing the backshell tight onto it. Use a spanner with opening 32 to screw the backshell tight (no gap).

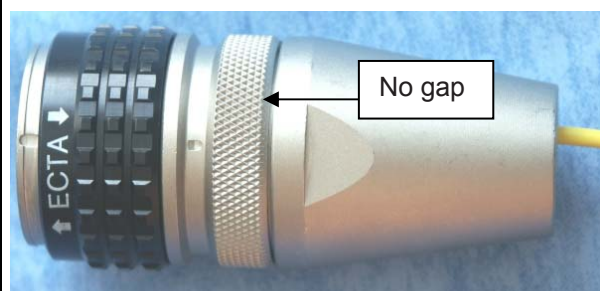

B0122A7A

6. Place the appropriate seal parts (with one groove for one contact or two grooves for two contacts) over the cable(s) and push them into the backshell.

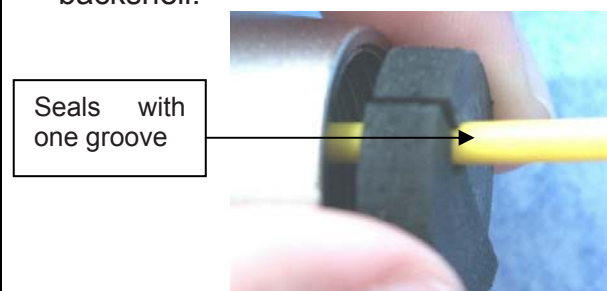

B0122A8A



7. Bring the plastic ring over the cable(s), push it into the backshell and compress the seals and plastic ring by screwing the clamp ring tight (no gap) using a spanner with opening 20. \*\*\*

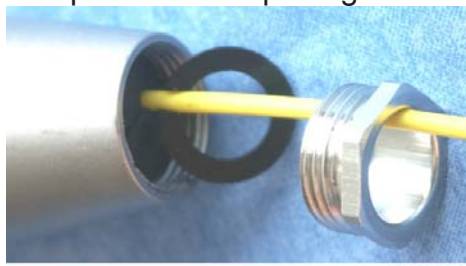

B0122A9A

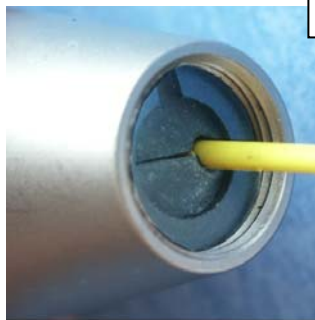

B0122AAA

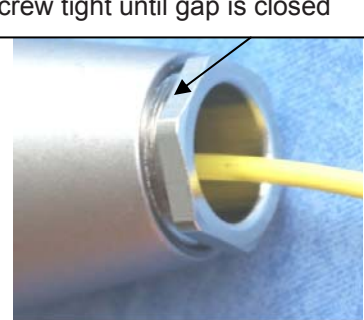

B0122ABA

8. Connect the plug to the optical-fiber connector of the Remote Unit, again by fitting a stamp on the plug into the groove of the connector.
9. To lock the connector, push the black locking ring forward.\*\*\*\*

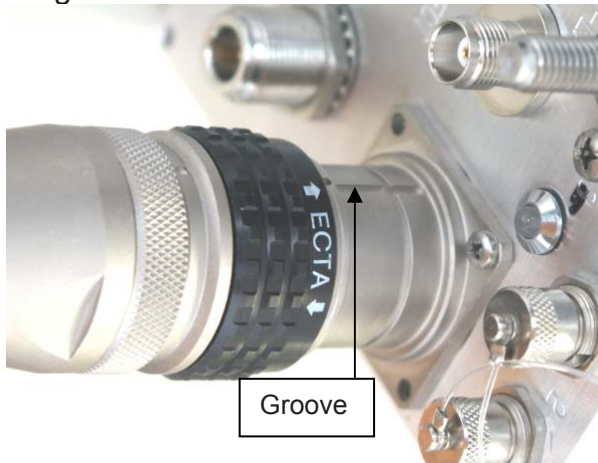

B0122ACA



B0122ADA

Push forward to lock, pull back to free connection

\*\*\* For disassembling, release the clamping ring and remove the seals and the plastic ring first.

\*\*\*\* Locking mechanism: The system of locking the plug is based on a “push-pull” mechanism. The locking ring has to be pushed forward to lock the connector and pulled back to free the connection.

### 3.5.2. Protective-Tube Kit

As additional protection for the optical fibers, this connector type can be supplemented by a special tube kit. To fasten the tube correctly, first unscrew the clamp ring (if already installed) of the original plug kit.

Then, proceed according to the following instruction:

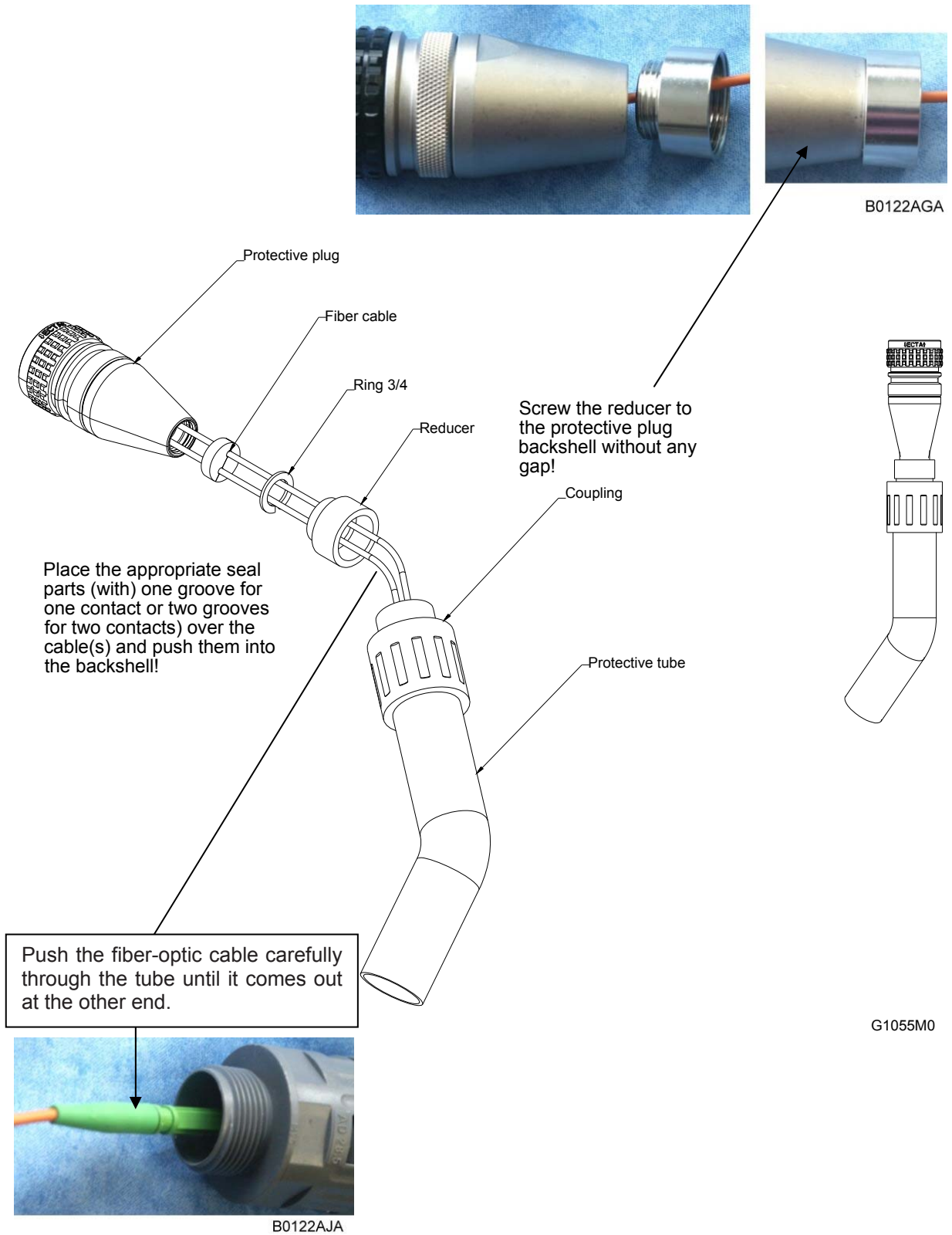

figure 3-12 Tube-kit installation

### **3.6. COMMISSIONING**

Read the health and safety warnings in section *1.2 Health and Safety Warnings*. Keep these guidelines in mind before continuing to the instructions for commissioning:

- Do not operate the Remote Unit without terminating the antenna connectors. The antenna connectors may be terminated by connecting them to their respective antennas or to a dummy load.
- Only qualified personnel should carry out the electrical, mechanical, commissioning, and maintenance activities that require the unit to be powered on when open.
- Do not damage the warranty labels on the devices. The warranty is void if the seals are broken.
- Ensure that all connections have been performed according to section *3.2.1 General*.

# Commissioning an ION-M Remote Unit

Manual for Remote Unit

Philips screwdriver

Mounting kit  
Spanner, size 13 mm  
Drilling machine  
Dowels  
Screw driver

Screw driver  
Spanner, size 13 mm

Grounding cable  
Spanner 13 mm

Alarm kit  
(M-cabinet)



E2000 APC8° connector  
Spanner with opening 32

Mains cable  
Connecting kit

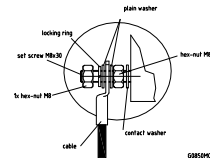
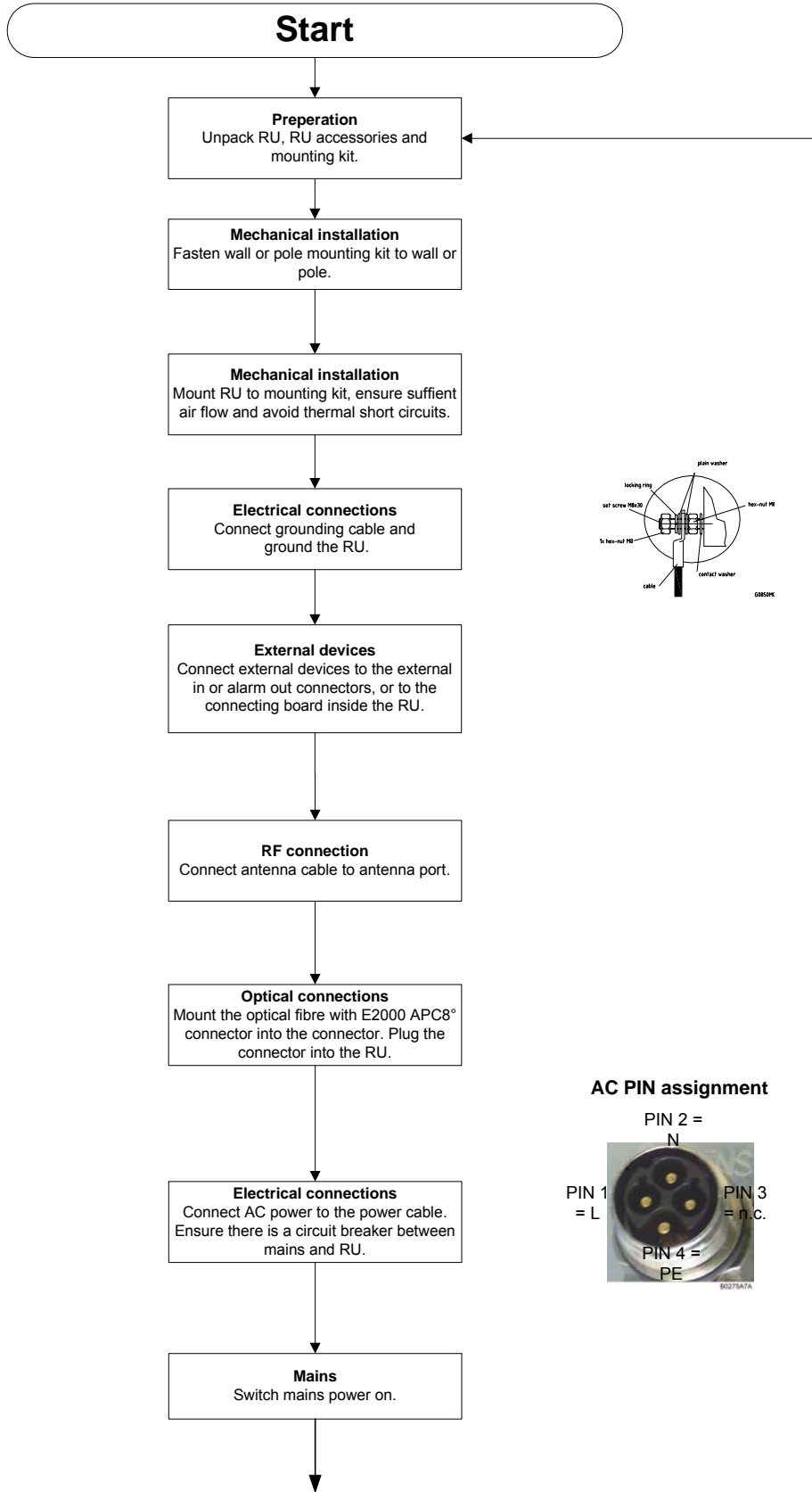

### AC PIN assignment

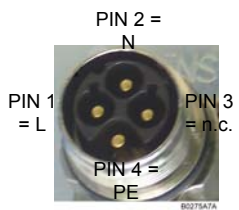



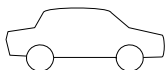
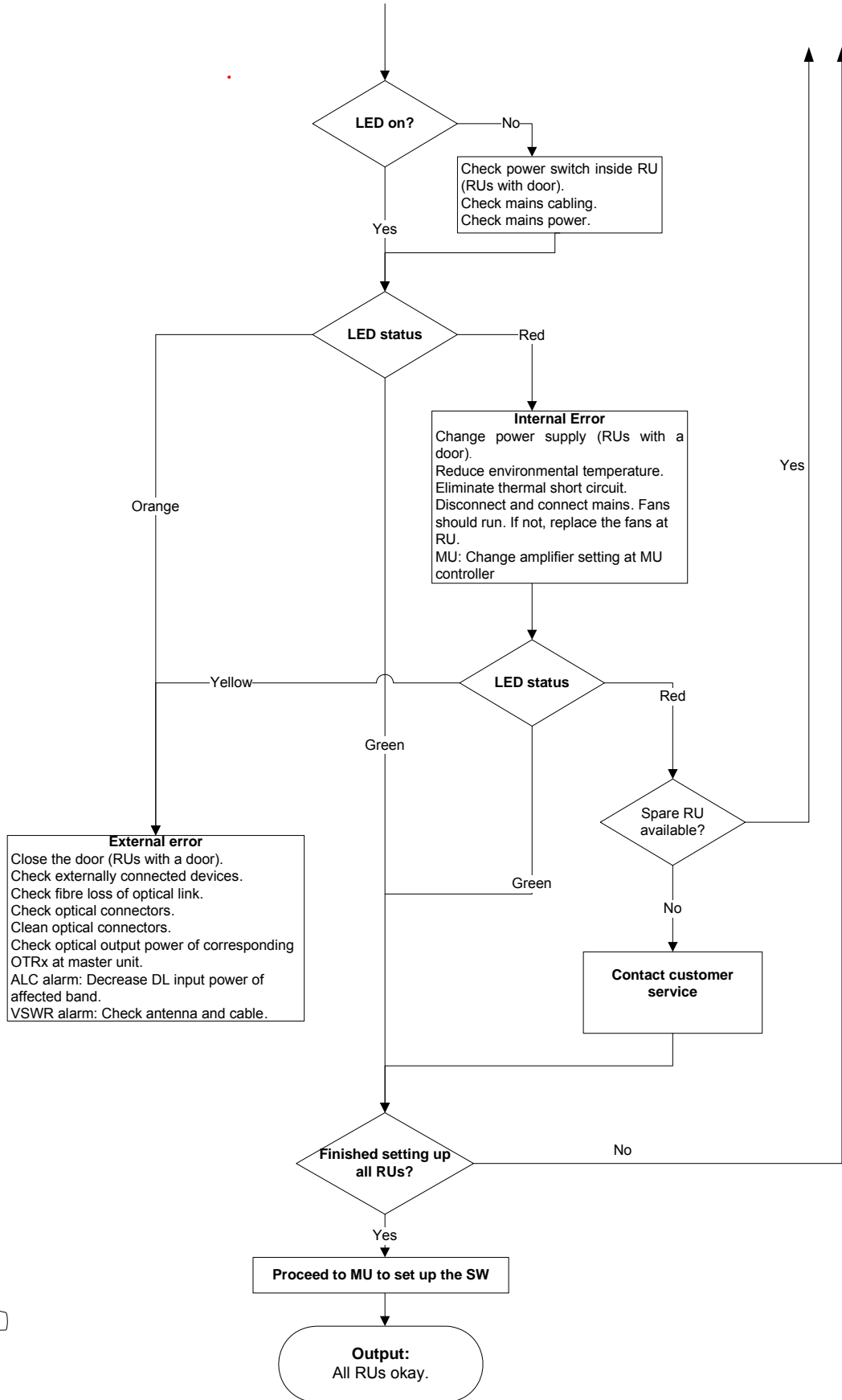

Go to MU

**For your notes:**

## **4. ALARMS**

### **4.1. BITe AND ALARMS**

The Built-In Test (BITe) concept comprises the monitoring of the power supplies, the power amplifiers and the optical interface.

All alarms occurring can be checked via software at the Master Unit.

### **4.2. HANDLING OF ALARMS**

A message is transmitted to the Master Unit when the software acknowledges a valid alarm.

A new alarm message will not be repeated if the reason for the alarm is cleared or if the alarm continues.

A new alarm message will be generated if the alarm is interrupted for at least five seconds after acknowledgement.

### **4.3. ALARM STATUS**

Refer to the corresponding software documentation of the Master Unit for details.

#### 4.4. STATUS LED ALARMS

For local supervision, a status LED on the connector flange of the Remote Unit gives an indication of possible reasons for alarms. This table shows possible on-site measures that could be checked before referring to the Master Unit alarm list.

<b>Status LED Indication</b>	<b>Alarms</b>	<b>Possible on-site measures</b>
Green	No alarm → Status ok	
Orange	Door alarm	Close the door (RUs with door).
	<i>Alarms not directly related to RU:</i>	
	External alarms	Check externally connected devices.
	Optical alarm Rx	Check fiber loss of optical link. Check optical connectors. Clean optical connectors. <i>(MU: Check optical output power of corresponding OTRx at Master Unit).</i>
	ALC alarm	<i>(MU: Decrease DL input power of affected band).</i>
Red	<i>Alarms directly related to RU:</i>	
	Power 28 V	Change power supply (RUs with door). Replace the affected Remote Unit.
	Temperature	Reduce environmental temperature. Eliminate thermal short circuit.
	Fan	Disconnect and connect power supply. Fans should run. If not, replace the fans at RU.
	I <sup>2</sup> C	Disconnect and connect power supply.
	Optical alarm Tx	Exchange RU.
	Amplifier "Power Down"	<i>(MU: Change amplifier setting at MU controller).</i>
Status LED off	Power supply	Check power switch inside of RU (RUs with door). Check power supply cabling. Check power supply.

*table 4-1 Status LED alarms*

For the position of the status LED see section 3.2.2 *Connections*.

Explicit troubleshooting is available in the MU software, (software manual or WEB Interface).

## 4.5. EXTERNAL ALARM INPUTS AND OUTPUTS

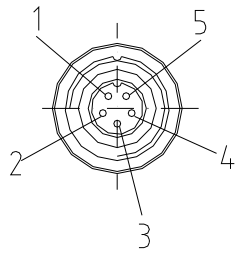

Flange connector  
5 poles

Pin 1= Alarm IN1  
Pin 2= Alarm IN2  
Pin 3= Alarm IN3  
Pin 4= Alarm IN4  
Pin 5= Alarm GND

G1038Z0

figure 4-1 Flange connector, 5 poles

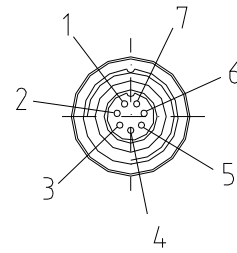

Flange connector  
7 poles

Pin 1= OUT1  
Pin 2= OUT2  
Pin 3= OUT3  
Pin 4= OUT4  
Pin 5= Alarm GND  
Pin 6= GND  
Pin 7= +28 V

G1038Z0

figure 4-2 Flange connector, 7 poles

The alarm outputs (open collector output 5 V / 1 mA) are normally low. In case of an alarm they are high active (5 V). They can be used to monitor alarms with an external alarm indicator.

The +28 V pin (for its location see *figure 4-2 Flange connector, 7 poles*) is protected by a 500 mA thermoswitch. In case of exceeding this current between pin 7 and GND and/or in case of a failure of the VSWR module, the thermoswitch turns into a high-resistive status. In this case no fuse needs to be replaced. Just wait a few minutes until the thermoswitch reaches the normal operating temperature again.

**Note:** The manufacturer / supplier of this system accepts no liability for damage caused by equipment connected to external outputs or by effects from such equipment.

As accessory equipment the alarm kit is available to connect external devices to the external alarm inputs and outputs. For the exact ID No., please refer to section 6.3 *Spare Parts*.

With the external alarm inputs it is possible to monitor the status of connected devices, e.g. a UPS, via software. All alarm inputs are normally high (5 V) without connection. The polarity (high/ low) can be set via the software at the Master Unit (for details please see according software manual).

The device to be monitored must be connected so that the alarm contacts will be closed in case of an alarm ( $I_{max} = 8 \text{ mA}$ ). The alarm inputs are potential-free with common ground.

Subminiature circular connectors series 712 with five and seven contacts, which are contained in the alarm kit, can be ordered directly from the Binder Connector Group, the manufacturer, or indirectly from Andrew Solutions. For the ID No. of the alarm kit see section 6.3 *Spare Parts*.

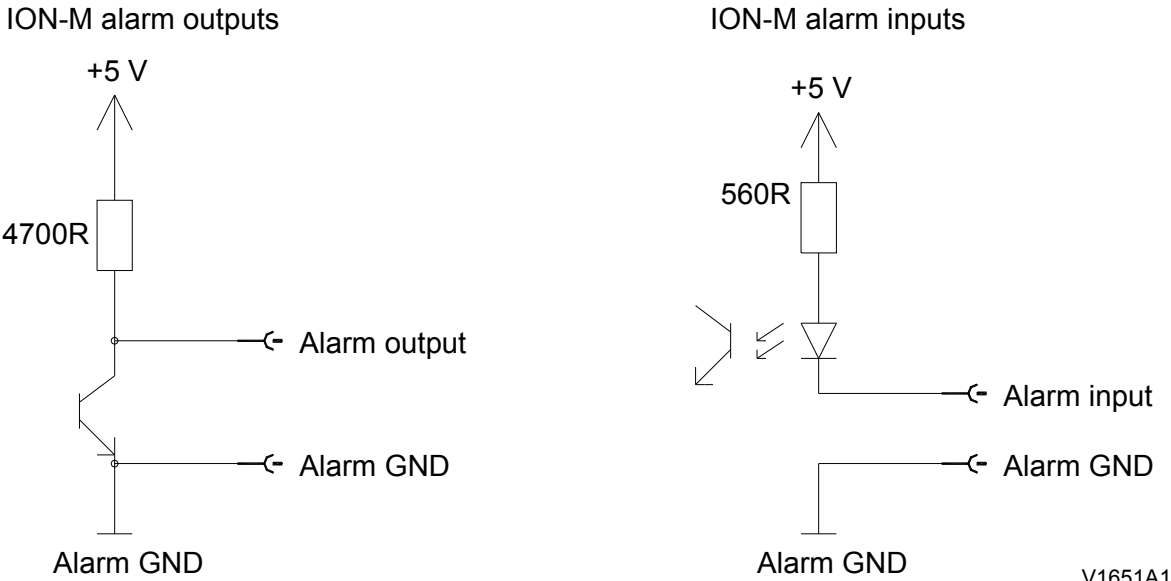

figure 4-3 Alarm inputs and outputs, standard



**4.6. TROUBLESHOOTING**

The status of the Remote Unit can be checked via the Master Unit (for details please refer to the software manual of the Master Controller). Locally, the status can be checked at the LED, see section 4.4 *Status LED Alarms*.

## 5. MAINTENANCE





### 5.1. GENERAL

Read the health and safety warnings in section *1.2 Health and Safety Warnings*.

-  **Note:** The Remote Unit does not require preventative maintenance measures.
-  **Note:** To prevent malfunctions of the cooling system due to dirt or pollution, it is recommended to clean the heat sink at regular intervals. These cleaning intervals depend mainly on the location of the Remote Unit and the corresponding degree of pollution.

Maintenance of the ION-M17HP/19HP should be performed by replacing only components that are contained in this section. Take care not to unintentionally damage the seals on the modules to maintain warranty. Please keep these guidelines in mind during maintenance:

The spare parts list, consequently, contains only units which can be replaced without tuning or soldering work.

-  **Note:** Use an appropriate packaging when sending back the unit (see section *6.2.3 Environmental and Safety Specifications* for details). We strongly recommend using the original packaging.
-  **Note:** Defect parts should only be replaced by original parts from the supplier. All interventions inside the housing are at one's own risk.
-  **Note:** Ensure the Remote Unit has been disconnected from mains during maintenance.
-  **Note:** Label any unlabelled cables before disconnecting them to ensure correct re-connection.

Maintenance procedures require appropriate tools are to ensure correct handling. All these tools can be ordered from the supplier.

-  **Note:** All our screws have a right-hand thread and are fastened by turning the tool clockwise and are unscrewed by turning the tool counter-clockwise.

Due to the design of the Remote Unit the only component recommended to be replaced is the fan unit. For replacing any other component, please contact the supplier.

## 5.2. REPLACING THE FAN UNIT

Replacement of the fan unit is not required as a preventative measure. Only if an alarm indicates a malfunctioning of a fan, must the unit be exchanged.

☞ **Note:** Please observe that the fan unit can only be replaced as a whole. Do NOT remove the fans separately!

☞ **Note:** NEVER blow out the fan unit with compressed air! This would cause permanent damage to the unit.

Read the health and safety warnings in section 1.2 as well as the instructions in section 5.1 *General* before starting with the replacement.

1. Switch off the Remote Unit. Make sure the power supply connector is disconnected for the following replacement procedure. Then, proceed as follows:
2. Remove the fan guard by unscrewing (Torx 20) the four countersunk-head screws (two at each side) by which it is fastened:<sup>1)</sup>



3. Loosen the four fillister-head screws M4x8 by which the fan unit is screwed to the cabinet (circle-marked in the figure to the right).<sup>2)</sup>
4. Disconnect the fan-unit connector and take out the fan unit.
5. To mount the new fan unit, re-connect the fan unit connector and place the fan unit back into its original position.
6. Screw the whole fan unit to the cabinet with the four lens-head screws M4x8.<sup>2)</sup>
7. Finally mount the fan guard and fasten it with the four countersunk screws.<sup>1)</sup>

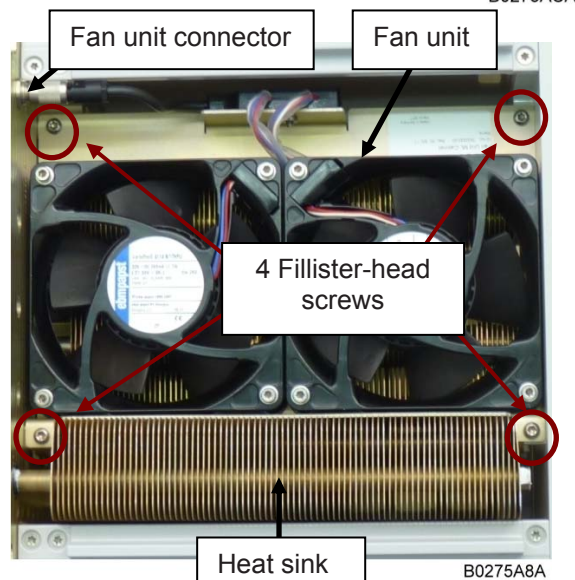

figure 5-1 Fan unit and heat sink

8. Then, mains power can be reconnected and the unit can be powered up.

<sup>1)</sup> In order not to exceed the specified torque of 82 Ncm, use an appropriate tool!

<sup>2)</sup> In order not to exceed the specified torque of 330 Ncm, use an appropriate tool!



### 5.3. CLEANING THE HEAT SINK

To avoid a malfunctioning of the Remote Unit, the heat sink should be cleaned in case of pollution. In order to prevent any damage, proceed as explained in the following.

☞ **Note:** **Read the health and safety warnings in section 1.2 *Health and Safety Warnings* as well as the instructions in section 5.1 *General* before starting with the replacement procedure. Then, proceed as follows:**

1. Switch off the Remote Unit. For the following procedure ensure that power supply connector has been disconnected before and that the fans have stopped rotating!
2. Before any cleaning action, **remove** the fan guard **and the fan unit** from the Remote Unit as described in the previous section 5.2 *Replacing the Fan Unit*.
3. Clean the ribs of the heat sink (see *figure 5-1 Fan unit and heat sink*) very carefully with a **soft** brush (not metallic!). **Take care that the material is not scratched or damaged!**
4. If necessary, **use compressed air** (max. 5 bar) **to blow out the heat sink** from front to rear side.
5. In case the dirt cannot be blown out completely from the heat sink and parts of it, still stick to the ribs, clean the parts concerned carefully from the front with the **soft** brush. **Take care that the material is not scratched or damaged.**
6. After cleaning the heat sink, mount the fan unit and the fan guard again according to section 5.2 *Replacing the Fan Unit*. Then, reconnect mains power and power up the unit.

6. APPENDIX

6.1. ILLUSTRATIONS

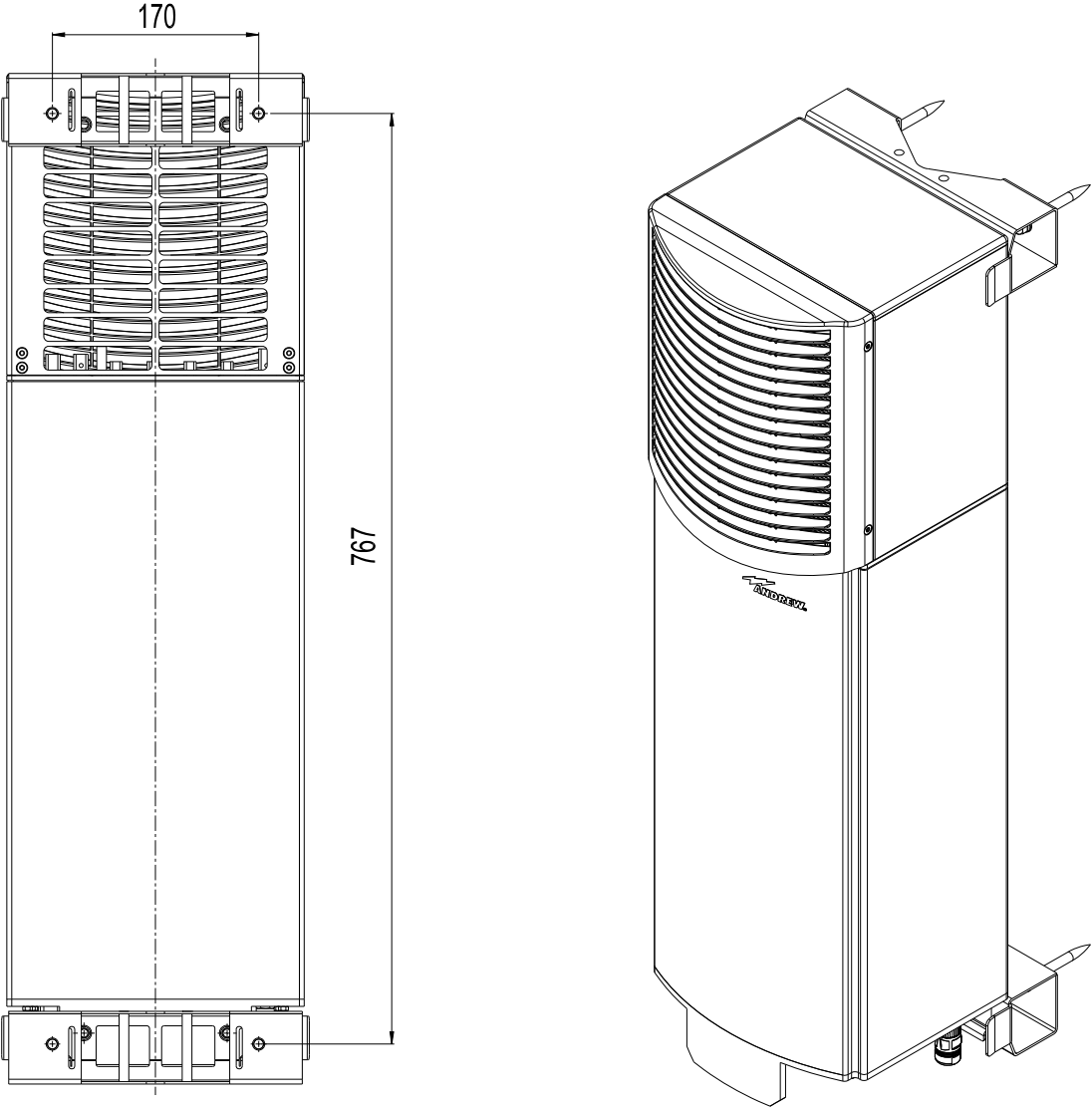

G3219M0

figure 6-1 Cabinet drawing

## 6.2. SPECIFICATIONS

### 6.2.1. Electrical Specifications

ION-M17HP/19HP		
Electrical		
Power supply	Mains power	85 to 264 Vac 115 or 230 Vac
Power consumption	max. temp., fully loaded	1150 watts
	room temp., idle	650 watts
Optical Link		
Connectors	E2000/APC 8°	
Optical return loss	45 dB minimum	
Fiber type	Single mode E9/125 mm	
Optical link budget	0 dB to 10 dB	
Input power @ OTRx master side	1900 MHz	+5 dBm composite
	1700/2100 MHz	+5 dBm composite

**All data is subject to change without notice.**

### 6.2.2. Mechanical Specifications

Height, width, depth *	817 x 245 x 218 mm (32.2 x 9.6 x 8.6 in)
Weight	40 kg (88.2 lb)

\* Spacing required 40 mm (1.58 in) around unit

**All data is subject to change without notice.**

### 6.2.3. Environmental and Safety Specifications

 **Note:** For detailed information, please refer to the Environmental and Safety Specifications leaflet of the supplier, related to ETS 300 019 (European Telecommunication Standard).

Operating temperature range	-33° C to +50° C	
Ingress protection	RF part	IP67
	Fan part	IP55

**All data is subject to change without notice.**

### 6.3. SPARE PARTS

The following lists contain all parts available for the Remote Unit. The configuration of the delivered unit meets the requirements of the customer and can differ depending on the state of the delivery.

Maintenance of the ION-M17HP/19HP should be performed on an FRU (Field Replaceable Unit) basis only. Do not damage the warranty labels on the components, as this voids the warranty.

The following spare parts lists only contain units that can be replaced without tuning or soldering work. To replace an FRU, use the appropriate tools. Replacement tools may be ordered from the supplier. If any FRU not contained in the following list needs to be replaced, please contact customer service for additional instructions.

#### Spare Parts List of the Remote Unit ION-M17HP/19HP

<b>Designation:</b>	<b>ID No:</b>	<b>FRU</b>
<b><i>ION-M17HP/19HP ML-cab</i></b>	<b>7631412</b>	
Protective Plug E2000	7160013	x
Protective Cap E 2000	7158914	x
Fan Unit ML-Cabinet	7632532-00	x
Manuals for ION-M17HP/19HP (ML-cab)	7636176-00	

<b>Accessories</b>	
Wall Mounting Kit	7632566
Pole Mounting Kit	7636344
Alarm Kit	7157396

The manufacturer reserves the right to replace the spare parts listed above by equivalent substitutes.

☞ **Note:** Only the spare parts listed above are FRUs (= Field Replaceable Units) – apart from the Manual - and can be replaced by the user. For replacement of any other parts please send the entire Remote Unit back to the manufacturer.

## 7. INDEX

<b>A</b>		<b>H</b>	
Abbreviations .....	6	Health and Safety Warnings .....	7
Address of Andrew Wireless Systems GmbH.....	11	<b>I</b>	
Alarms		Illustrations .....	42
Alarm Status .....	35	Installation	
Bite and Alarms .....	35	Electrical .....	20
External Inputs.....	37, 38	Mechanical .....	15
Handling of Alarms .....	35	<b>M</b>	
List .....	38	Maintenance .....	39
Outputs .....	37, 38	Mounting	
RU .....	38	Pole .....	18
Status LED.....	36	Wall.....	17
Andrew Solutions.....	9	<b>O</b>	
<b>C</b>		Optical-Fibre Connection	
Cleaning the Heat Sink .....	41	Protective Plug .....	27
Commissioning		Protective-Tube Kit .....	29
General .....	31	Outputs	
Connection Rules		Location .....	21
Optical-Fiber Cables .....	24	<b>P</b>	
Connections		Pin Assignment	
Antenna .....	23	External Alarms .....	37
Connector Flange .....	21	<b>R</b>	
Power .....	23	Replacement of Fan Unit.....	40
Control Connector for EU .....	22	RS485/ RS232 EU Control Connector .....	22
<b>E</b>		<b>S</b>	
Extension Unit		Spare Parts .....	44
RS485/ RS232 Control Connector (8 pins).....	22	Specifications	
External Inputs		Electrical .....	43
Location .....	21	Environmental and Safety.....	43
.....	21	Mechanical .....	43
<b>F</b>		<b>T</b>	
Fiber-Optical Components		Troubleshooting.....	38
Cleaning Procedure .....	26		
System Installation.....	25		
Flange Connector			
5 poles .....	37		
7 poles .....	37		
<b>G</b>			
Grounding.....	22		