

ION-M4/8 19"

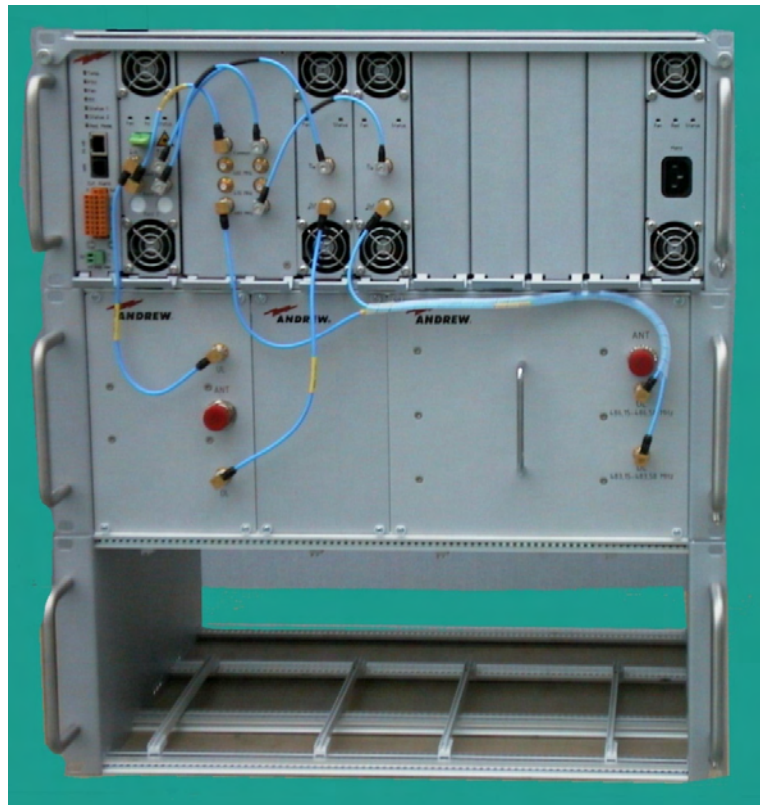

Optical Remote Unit



**User's Manual
M0132AVA**

© Copyright 2009 CommScope, Inc.

All rights reserved.

Andrew Solutions is a trademark of CommScope, Inc.

All information contained in this manual has been revised thoroughly. Yet Andrew Solutions accepts no liability for any omissions or faults.

Andrew Solutions reserves the right to change all hard- and software characteristics without notice.

Names of products mentioned herein are used for identification purposes only and may be trademarks and / or registered trademarks of their respective companies.

No parts of this publication may be reproduced, stored in a retrieval system, transmitted in any form or by any means, electronical, mechanical photocopying, recording or otherwise, without prior written permission of the publisher.

Andrew Wireless Systems GmbH, 02-November-2009

TABLE OF CONTENTS

1. GENERAL	7
1.1. USED ABBREVIATIONS	7
1.2. HEALTH AND SAFETY WARNINGS	9
1.3. ABOUT ANDREW SOLUTIONS	10
1.4. INTERNATIONAL CONTACT ADDRESSES FOR WIG CUSTOMER SUPPORT	11
2. INTRODUCTION	13
2.1. PURPOSE	13
2.2. THE ION-M4/8 19" RU - RF COVERAGE FOR 400 / 800 MHZ NETWORKS	13
3. FUNCTIONAL DESCRIPTION	15
3.1. GENERAL	15
3.2. COMPONENTS OF THE ION-M4/8 19" REMOTE UNIT	16
3.2.1. Main Subrack 19"	17
3.2.2. Alarm Board	18
3.2.3. OTRx Drawer	20
3.2.4. Crossband-Coupler Drawer of ION-M4 19"	21
3.2.5. Amplifier Drawers 470-512 MHz and 851-894 MHz	21
3.2.6. PSU Drawer	23
3.2.7. Duplexer Subrack	24
4. COMMISSIONING	25
4.1. MECHANICAL INSTALLATION – GENERAL	25
4.2. ELECTRICAL INSTALLATION	26
4.2.1. General	26
4.2.2. Cabling and Connections	27
4.2.3. Power Connection and Grounding	28
4.3. CONNECTION OF THE ANTENNA CABLES	29
4.4. OPTICAL-FIBRE-CABLE CONNECTION – RULES	29
4.5. AUTO-LEVELLING	30
4.6. COMMISSIONING	31

5. ALARMS	35
5.1. BITE AND ALARMS	35
5.2. HANDLING OF ALARMS	35
5.3. ALARM STATUS	35
5.4. TROUBLESHOOTING	35
5.5. STATUS LED ALARMS	35
6. MAINTENANCE	37
6.1. GENERAL	37
6.2. REPLACEMENT OF COMPONENTS	38
6.2.1. Replacement of Amplifier and Optical Plug-in Modules	38
6.2.2. Replacement of Power Supply Plug-in Modules	40
7. APPENDIX	43
7.1. LAYOUT	43
7.2. SPECIFICATIONS	45
7.2.1. Electrical Specifications	45
7.2.2. Mechanical Specifications	47
7.2.3. Environmental and Safety Specifications	47
7.3. SPARE PARTS	48
8. INDEX	49

FIGURES AND TABLES

figure 3-1 Configuration of an ION-M4/8 19" RU	15
figure 3-2 ION-M4/8 19", layout of front side	16
figure 3-3 Main Subrack 19" ION-M4 19", front side	17
figure 3-4 Main Subrack 19", seals on rear side	17
figure 3-5 Alarm board for RU.....	19
figure 3-6 Alarm board for EU.....	19
figure 3-7 OTRx drawer	20
figure 3-8 Alarm triggering	21
figure 3-9 I ² C switch located on the amplifier board	22
figure 3-10 PSU drawer	23
figure 3-11 I ² C switch located on the PSU board.....	23
figure 3-12 Duplexer subrack of ION-M4 19"	24
figure 4-1 ION-M4/8 19" cabling on front side.....	27
figure 4-2 ION-M4/8 19" connectors on front side.....	27
figure 4-3 Mains connector and grounding screw	28
figure 5-1 Alarm triggering	36
figure 6-1 OTRx and amplifier modules, locking device.....	38
figure 6-2 Rotary address switch, location on PA	39
figure 6-3 PSU module, locking device	40
figure 6-4 Rotary address switch, location on PSU.....	41
figure 7-1 Layout of the ION-M4 19" remote unit, front side	43
figure 7-2 Layout of the ION-M4 19" remote unit, rear side	43
figure 7-3 Cabinet drawing.....	44
table 1-1 List of international contact addresses.....	12
table 3-1 I ² C bus switch on amplifier module, rear side	22
table 3-2 I ² C bus switch on PSU module, rear side	23
table 5-1 Status LED alarm coding	36

For your notes:

1. GENERAL

1.1. USED ABBREVIATIONS

3GPP	3 rd Generation Partnership Project
ALC	Automatic Level Control
AMPS	American Mobile Phone System or Advanced Mobile Phone System
APAC	Automatic Power Adjustment Circuit
BCCH	Broadcast Control Channel
BITE	Built-In Test Equipment
BTS	Base Transceiver Station
CBC	Crossband Coupler
CDMA	Code Division Multiple Access
CEPT	Conférence Européenne des Postes et Télécommunications
CF	Center Frequency
CFO	Center Frequency Offset
DL	Downlink
EDGE	Enhanced Data Rates for GSM Evolution
ESD	Electrostatic Discharge
ETACS	Enhanced TACS
ETS	European Telecommunication Standard
ETSI	European Telecommunication Standards Institute
FSK	Frequency Shift Keying
GSM	Global System for Mobile Communication
I ² C-Bus	Inter-Integrated Circuit Bus (Philips)
ID No	Identification Number
IF	Intermediate Frequency
LAN	Local Area Network
LED	Light Emitting Diode
LMT	Local Maintenance Terminal
LNA	Low Noise Amplifier
MCC	Mobile Country Code
MNC	Mobile Network Code
MOR	Microwave Optical Repeater
MR	Microwave Repeater
MS	Mobile Station
MTBF	Mean Time Between Failure
OIP-3	Output Intercept Point of the 3 rd order
OMC	Operation and Maintenance Center
OTRx	Optical Transceiver
PA	Power Amplifier
PCMCIA	Personal Computer Modem Communication International Association
PCS	Personal Communication System
PSTN	Public Switched Telephone Network
PSU	Power Supply Unit
Rev	Revision
RF	Radio Frequency
RLP	Radio Link Protocol

RSSI	Receive Signal Strength Indication
RTC	Real-Time Clock
RX	Receiver
SCL	Serial Clock
SDA	Serial Data
SMSC	Short Message Service Center
TACS	Total Access Communication System
TCH	Traffic Channel
TDMA	Time Division Multiple Access
TX	Transmitter
UE	User Equipment
UL	Uplink
UMTS	Universal Mobile Telecommunication System
UPS	Uninterruptable Power Supply
URL	Uniform Resource Locator
VSWR	Voltage Standing Wave Ratio
WCDMA	Wide Code Division Multiple Access
WIG	Wireless Innovations Group

1.2. HEALTH AND SAFETY WARNINGS



1. Only suitably qualified personnel is allowed to work on this unit and only after becoming familiar with all safety notices, installation, operation and maintenance procedures contained in this manual.
2. Read and obey all the warning labels attached to the unit. Make sure that the warning labels are kept in a legible condition and replace any missing or damaged labels.
3. Obey all general and regional installation and safety regulations relating to work on high voltage installations, as well as regulations covering correct use of tools and personal protective equipment.
4. Keep operating instructions within easy reach and make them available to all users.
5. It is the responsibility of the network provider to implement prevention measures to avoid health hazards which may be associated to radiation from the antenna(s) connected to the unit.
6. The antennas of the repeater (integrated and / or external) have to be installed in a way that the regional and national RF exposure compliance requirements are met.
7. Make sure access is restricted to qualified personnel.
8. Only licence holders for the respective frequency range are allowed to operate this unit.
9. Use this equipment only for the purpose specified by the manufacturer. Do not carry out any modifications or fit any spare parts which are not sold or recommended by the manufacturer. This could cause fires, electric shock or other injuries.
10. Before opening the unit, disconnect mains.
-  11. ESD precautions must be observed! Before commencing maintenance work, use the available grounding system to connect ESD protection measures.
12. This unit complies with European standard EN60950.
13. **IMPORTANT NOTE:** To comply with FCC RF exposure compliance requirements, the following antenna installation and device operating configurations must be satisfied: A separation distance of at least 20 cm must be maintained between the antenna of this device and all persons. RF exposure compliance may need to be addressed at the time of licensing, as required by the responsible FCC Bureau(s), including antenna co-location requirements of 1.1307(b)(3). Maximum permissible antenna gain is 12 dBi.
14. Make sure the repeater settings are according to the intended use (see also product information of the manufacturer) and regulatory requirements are met.
15. Although the repeater is internally protected against overvoltage, it is strongly recommended to earth the antenna cables close to the antenna connectors of the repeater for protection against atmospheric discharge.

1.3. ABOUT ANDREW SOLUTIONS

Andrew Wireless Systems GmbH based in Buchdorf/ Germany, is a leading manufacturer of coverage equipment for mobile radio networks, specializing in low cost, high performance, RF and optical repeaters. Our optical distributed networks and RF repeater systems provide coverage for every application: outdoor use, indoor installations, tunnels, subways and many more.

Andrew Wireless Systems GmbH belongs to the *Wireless Innovations Group (WIG)*. Being a part of *Andrew Solutions*, *WIG* has unparalleled experience in providing RF coverage and capacity solution for wireless networks in both indoor and outdoor environment.

Andrew Solutions, a *CommScope Company*, is the foremost supplier of one-stop, end-to-end radio frequency (RF) solutions. Our products are complete solutions for wireless infrastructure from top-of-the-tower base station antennas to cable systems and cabinets, RF site solutions, signal distribution, and network optimization.

Andrew Solutions has global engineering and manufacturing facilities. In addition, it maintains field engineering offices throughout the world.

We operate a quality management system in compliance with the requirements of ISO 9001. All equipment is manufactured using highly reliable material. In order to ensure constant first-rate quality of the products, comprehensive quality monitoring is conducted at all fabrication stages. Finished products leave the factory only after a thorough final acceptance test, accompanied by a test certificate guaranteeing optimal operation.

The declaration of conformity for the product is available upon request from the local sales offices or from *Andrew Solutions* directly.

To make the utmost from this unit, we recommend you carefully read the instructions in this manual and commission the unit only according to these instructions.

For technical assistance and support, contact the local office or *Andrew Solutions* directly at one of the following addresses listed in the next chapter.

1.4. INTERNATIONAL CONTACT ADDRESSES FOR WIG CUSTOMER SUPPORT

Wireless Innovations Group (WIG)

Americas:

<i>Canada</i>	<i>United States</i>
<p style="text-align: center;">Andrew Solutions Canada</p> <p>620 North Greenfield Parkway Garner, NC 27529 U.S.A.</p> <p>Mail</p> <p>Phone +1-905-878-3457 (Office) +1 416-721-5058 (Mobile)</p> <p>Fax +1-905-878-3297</p> <p>E-mail Peter.Masih@andrew.com WIsupport.us@andrew.com</p>	<p style="text-align: center;">Andrew Solutions, Andrew LLC, A CommScope Company</p> <p>620 North Greenfield Parkway Garner, NC 27529 U.S.A.</p> <p>Mail</p> <p>Phone +1-888-297-6433</p> <p>Fax +1-919-329-8950</p> <p>E-mail WIsupport.us@andrew.com</p>
<i>Brazil & South America</i>	<i>Mexico, Central America & Caribbean region</i>
<p style="text-align: center;">Andrew Solutions, A CommScope Company</p> <p>Av. Com. Camilo Julio 1256 Predio B Zonal Industrial CP 597 Sorocaba SP 18086-000 Brazil</p> <p>Mail</p> <p>Phone + 55-15-9104-7722</p> <p>Fax + 55-15-2102-4001</p> <p>E-mail WIsupport@andrew.com</p>	<p style="text-align: center;">Andrew Solutions Mexico</p> <p>Monte Elbruz 124-402A Col. Palmas Polanco 11560 Mexico, D.F. Mexico</p> <p>Mail</p> <p>Phone + 52-55-1346-1900 (Office) +52-1-55-5419-5260 (Mobile).</p> <p>Fax +52-55-1346-1901</p> <p>E-mail WIsupport@andrew.com</p>

APAC Countries:

<i>China</i>	<i>Australia</i>
<p style="text-align: center;">Andrew Solutions Hong Kong</p> <p>Room 915 Chevalier Commercial Centre 8 Wang Hoi Rd Kowloon Bay SAR Hong Kong</p> <p>Mail</p> <p>Phone +852-310-661-00</p> <p>Fax +852-2751-7800</p> <p>E-mail WISupport.china@andrew.com</p>	<p style="text-align: center;">Andrew Corporation (Australia) LLC Pty Ltd.</p> <p>Unit 1 153 Barry Road Campbellfield VIC 3061 Australia</p> <p>Mail</p> <p>Phone +613-9300-7969</p> <p>Fax +613-9357-9110</p> <p>E-mail WIsupport.australia@andrew.com</p>

Europe:

United Kingdom		France	
	<p>Andrew Solutions UK Ltd</p> <p>Unit 15, Ilex House Mulberry Business Park Fishponds Road Wokingham Berkshire RG41 2GY England</p> <p>Mail</p> <p>Phone +44-1189-366-792</p> <p>Fax +44-1189-366-773</p> <p>E-mail Wlsupport.uk@andrew.com</p>		<p>Andrew Solutions France</p> <p>28, Rue Fresnel Z.A Pariwest BP 182 78313 Coignières Cedex France</p> <p>Mail</p> <p>Phone +33 1 30 05 45 50</p> <p>Fax +33 1 34 61 13 74</p> <p>E-mail Wlsupport@andrew.com</p>
Germany		Czech Republic	
	<p>Andrew Wireless Systems GmbH</p> <p>Industriering 10 86675 Buchdorf Germany</p> <p>Mail</p> <p>Phone +49-9099-69-0</p> <p>Fax +49-9099-69-930</p> <p>E-mail Wlsupport@andrew.com</p>		<p>Andrew Solutions Czech Republic C-Com, spol. s r.o</p> <p>U Moruší 888 53006 Pardubice Czech Republic</p> <p>Mail</p> <p>Phone +420-464-6280-80</p> <p>Fax +420-464-6280-94</p> <p>E-mail Wlsupport@andrew.com</p>
Austria		Switzerland	
	<p>Andrew Wireless Systems (Austria) GmbH</p> <p>Weglgasse 10 Wien-Schwechat 2320 Austria</p> <p>Mail</p> <p>Phone +43-1706-39-99-10</p> <p>Fax +43-1706-39-99-9</p> <p>E-mail Wlsupport.austria@andrew.com</p>		<p>Andrew Wireless Systems AG</p> <p>Tiergartenweg 1 CH-4710 Balsthal Switzerland</p> <p>Mail</p> <p>Phone +41-62-386-1260</p> <p>Fax +41-62-386-1261</p> <p>E-mail support.ch@andrew.com</p>
Italy		Spain & Portugal	
	<p>Andrew Wireless Systems S.r.l., Faenza, Italy</p> <p>Via de Crescenzi 40 Faenza 48018 Italy</p> <p>Mail</p> <p>Phone +39-0546-697111</p> <p>Fax +39-0546-682768</p> <p>E-mail Wlsupport.italia@andrew.com</p>		<p>Andrew Solutions España S.A.</p> <p>C/ Salvatierra, 5 - 3^a pt. 28034 Madrid Spain</p> <p>Mail</p> <p>Phone +34-91-745-20 40</p> <p>Fax +34-91-564-29 85</p> <p>E-mail Wlsupport.iberia@andrew.com</p>

table 1-1 List of international contact addresses

2. INTRODUCTION

2.1. PURPOSE

Cellular telephone systems transmit signals in two directions between base transceiver station (BTS) and mobile stations (MS) within the signal coverage area.

If weak signal transmissions occur within the coverage area because of indoor applications, topological conditions or distance from the transmitter, extension of the transmission range can be achieved by means of an optical distribution system.

Such a system contains an optical master unit and several remote units. The number of the remote units depends on the hardware and software configuration. The remote units are connected to the master unit with optical links. The optical loss must be less than 10 dB inclusive optical couplers or splitters.

The master unit is the connection to the base transceiver stations. The configuration of a master unit depends on the number of the remote units and the frequency range.

The optical transmission uses Wavelength Division Multiplex (WDM) systems with a wavelength of 1550 nm in the uplink and 1310 nm in the downlink.

2.2. THE ION-M4/8 19" RU - RF COVERAGE FOR 400 / 800 MHZ NETWORKS

Andrew's ION-M4/8 19" is a robust, intelligent optical RU to meet designer's requirements for high reliability with various redundancy and extension options.

The ION-M4/8 19" is a multi-band, multi-carrier optical RU. It is used in conjunction with a MU in the ION-M optical distribution system.

This system transports a Tetra, Tetrapol, CDMA or any other signal within up to 4 frequency bands in 400 MHz and the entire 800 MHz IDEN band while providing a cost-effective solution to distribute capacity from a cluster of base stations.

The ION-M optical distribution system is a cost-efficient coverage solution for dense urban areas, tunnels, subways, railways, roadways, airports, convention centres, and other locations where physical structures increase path loss.

The ION-M4/8 19" has been specifically designed to reduce zoning problems. The compact mechanical housing is designed to mount alongside structures in such a way that it has minimal visual impact.

The ION-M can be easily set-up and supervised by a graphical user interface (GUI). An auto-levelling function compensates for the optical link loss and making installation easy and quick. The entire system can be monitored remotely by A.I.M.O.S., the Andrew OMC. The Andrew OMC uses SNMP protocol and is compliant to X.733 standard. Should a sophisticated management interface not be required, the MU can be directly connected to the alarm interface of a base station via relay contacts.

Features:

- Efficient, high power amplifier
- WDM for uplink/downlink to multiple RUs on a single fibre
- Star and daisy chain configuration
- Redundancy and extension options available
- Complete operations and management system for configuration and alarming
- OMC with SNMP according to X.733 standard available
- Easy commissioning by means of auto-setup and auto-levelling

3. FUNCTIONAL DESCRIPTION

3.1. GENERAL

The following figure shows the configuration of an ION-M4/8 19" RU:

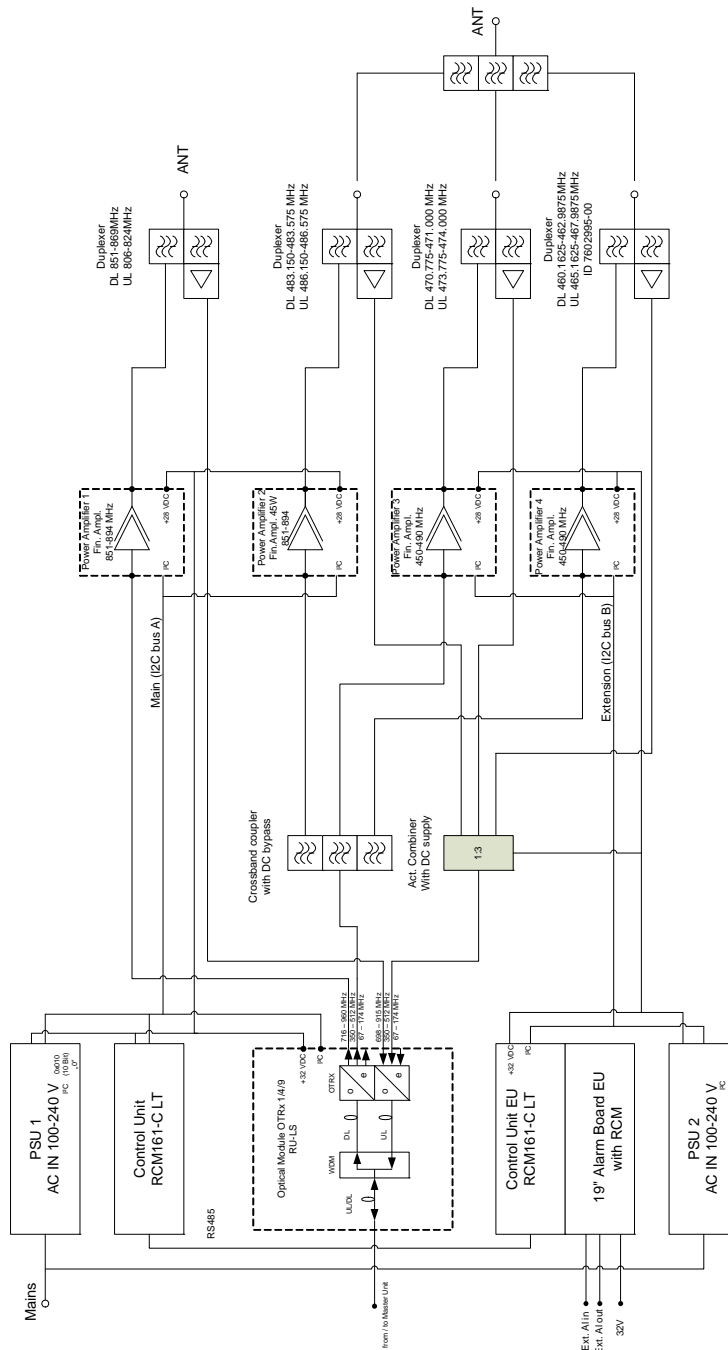

E3189B08

figure 3-1 Configuration of an ION-M4/8 19" RU

3.2. COMPONENTS OF THE ION-M4/8 19" REMOTE UNIT

The actual configuration of the remote unit can be seen at the configuration list which is part of the delivery.

The following figure shows an exemplary view of an ION-M4/8 19" remote unit to illustrate the individual components.

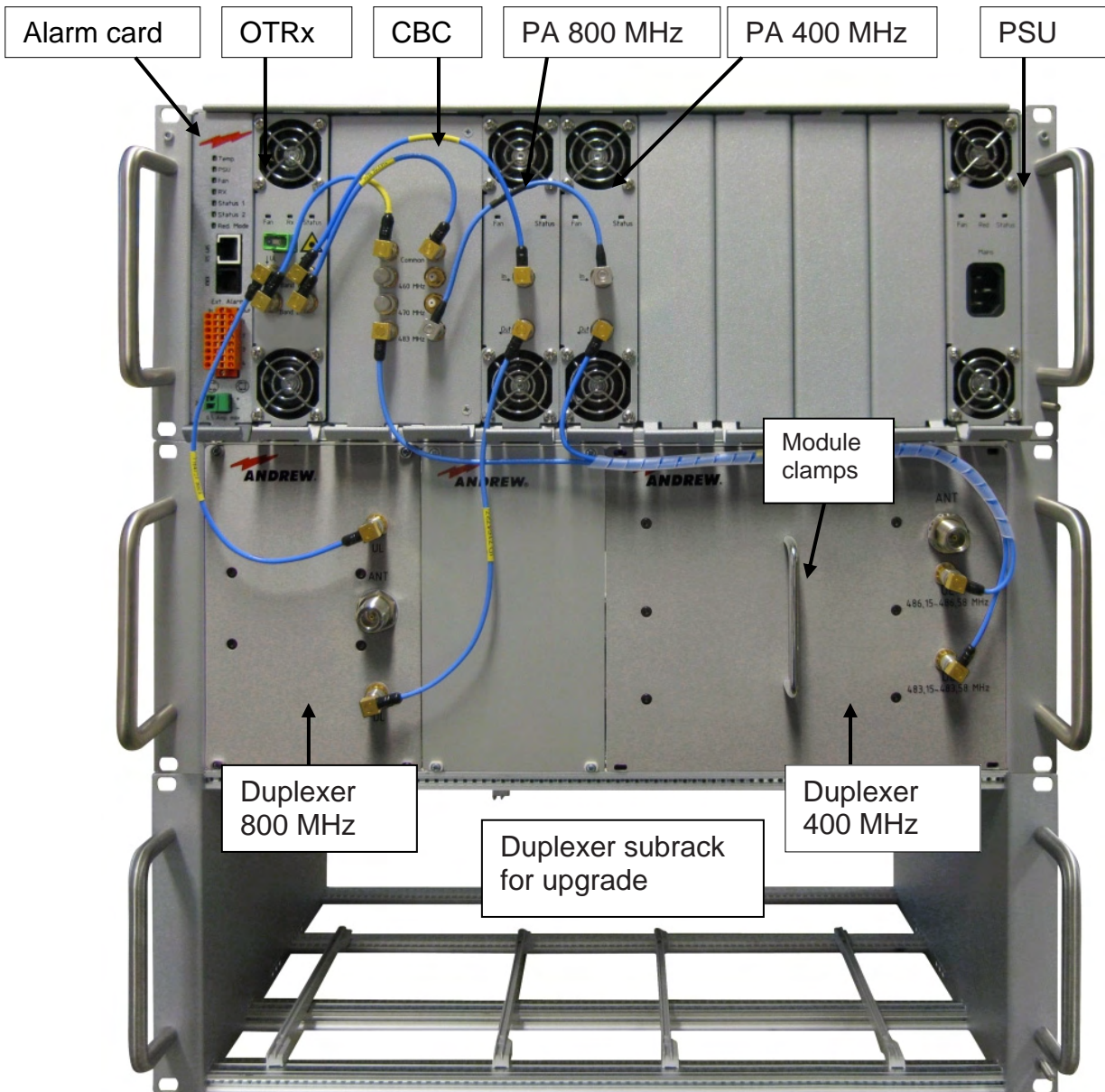

B0242ARA

figure 3-2 ION-M4/8 19", layout of front side

3.2.1. Main Subrack 19"

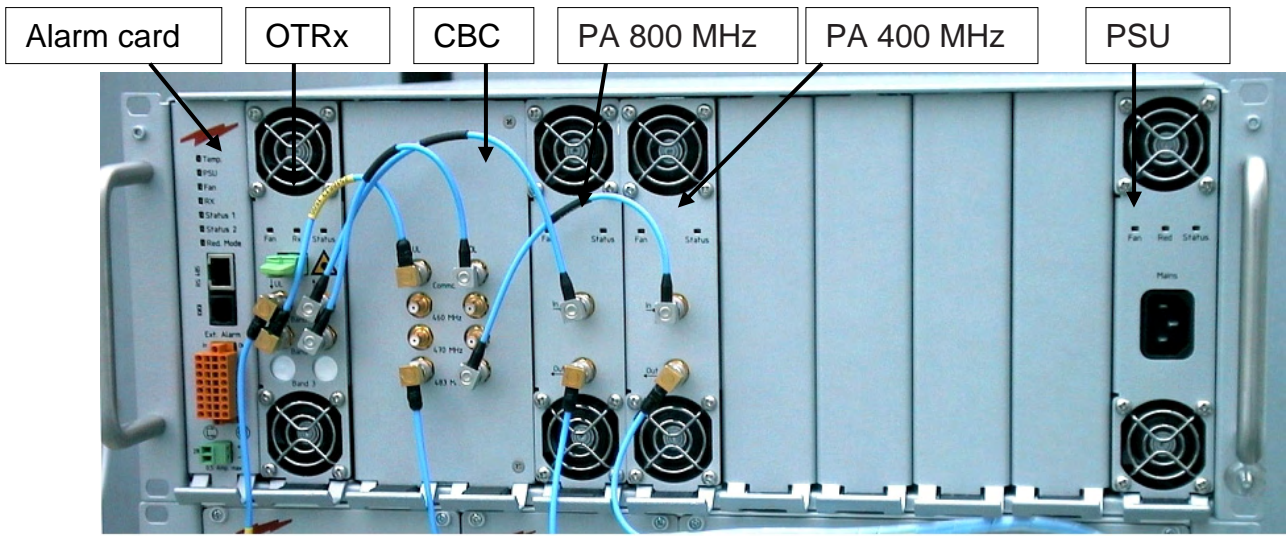

B0247A5A

figure 3-3 Main Subrack 19" ION-M4 19", front side

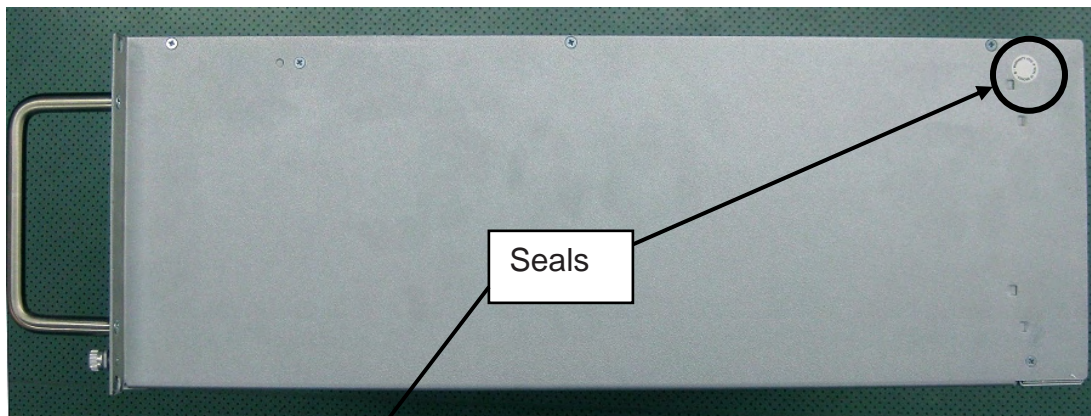

B0247A8A

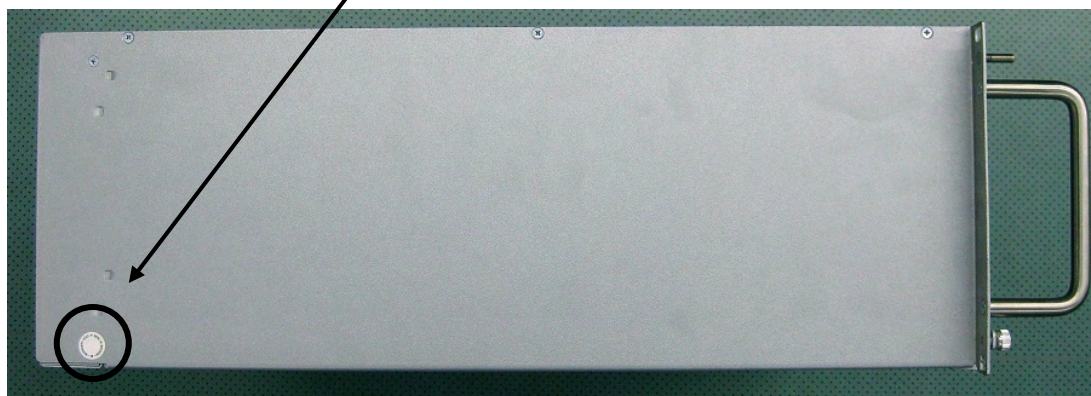

B0247A9A

figure 3-4 Main Subrack 19", seals on rear side

3.2.2. Alarm Board

The remote unit alarm board provides 4 alarm inputs for supervision of external devices, 4 configurable alarm outputs for simple alarm forwarding and 7 alarm LEDs (for the RU) or 4 alarm LEDs (for the EU). The Status alarm LEDs are green in normal operation, red when there is an alarm concerning the RU and yellow when the alarm cause is probably outside the unit, e. g. in case of a fibre-optic RX alarm. The other alarm LEDs are green if the concerned module is in normal operation and red if the module has an alarm.

Status 1 LED = summary alarm LED

- 1.) for 2 RUs in 1 subrack: Status 1 LED shows the status of the first RU
- 2.) for 1 RU & 1 EU in 1 subrack: Status 1 LED shows the status of the RU
- 3.) for 1 RU in 1 subrack: Status 1 LED shows the status of the RU

Status 2 LED = depending on which unit the alarm is raised.

- 1.) for 2 RUs in 1 subrack: Status 2 LED shows the status of the second RU
- 2.) for 1 RU & 1 EU in 1 subrack: Status 2 LED shows the status of the EU
- 3.) for 1 RU in 1 subrack: Status 2 LED shows any LED => no function

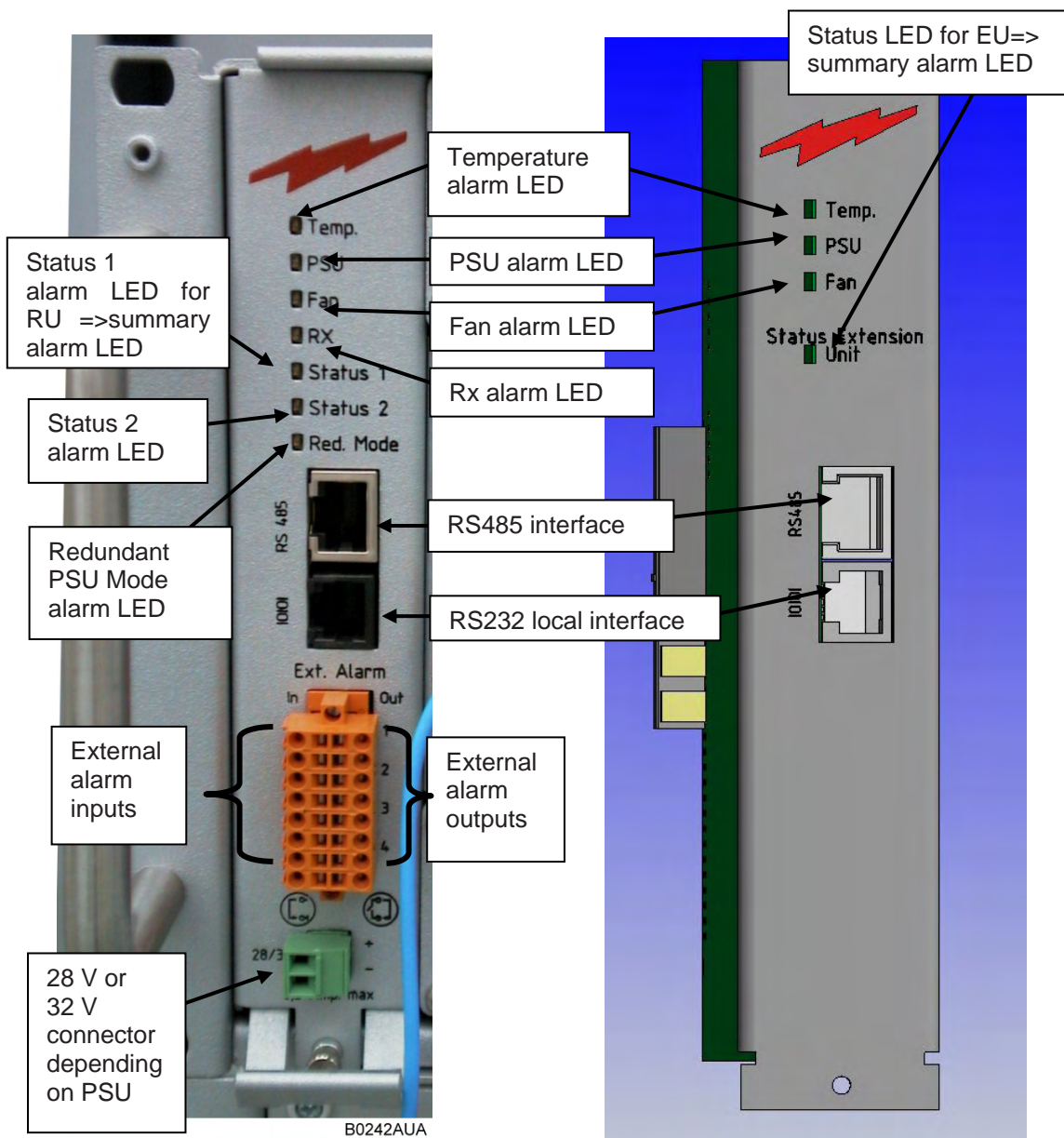

Note: This type of alarm board is only installed in the Extension Unit.

figure 3-5 Alarm board for RU

figure 3-6 Alarm board for EU

For detailed information on the Status LED please refer to chapter 5.5 *Status LED Alarms*.

3.2.3. OTRx Drawer



figure 3-7 OTRx drawer

The optical module is equipped with six QMA RF connectors (three for UL ports and three for DL ports), one optical E2000 APC connector and a control connector for the Extension Unit (EU).

The QMA connectors provide the following ports:

Band 1 UL/DL ports are not connected.

Band 2 is the UL/ DL signal port to the UL/DL Common port of the ION-M4 19" crossband coupler.

Band 3 is the DL signal port to the IN-port of the ION-M8 19" power amplifier.

Band 3 is the UL port from the UL port of the ION-M8 19" duplexer.

3.2.4. Crossband-Coupler Drawer of ION-M4 19"

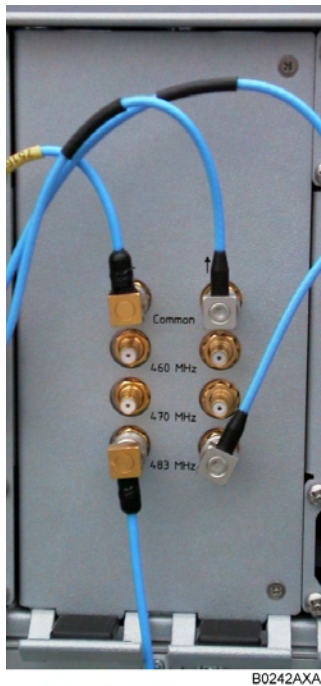

figure 3-8 Alarm triggering

The crossband-coupler (CBC) module is equipped with 8 QMA RF connectors – (three for DL ports and three for UL ports. These are the Common port from/to OTRx, DL Low Band / Middle Band/ High Band to power amplifiers, UL Low Band/ Middle Band/ High Band from the duplexer.

3.2.5. Amplifier Drawers 470-512 MHz and 851-894 MHz

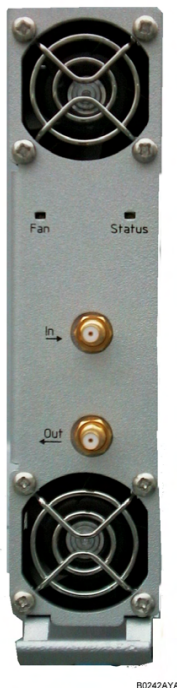

figure 3 7 Amplifier drawer

Each amplifier module provides two QMA RF ports. The upper RF IN port connects to the crossband-coupler port of the ION-M4 19", the lower RF OUT port to the corresponding DL and/ or UL port of the corresponding duplexer. For ION-M8 19", the RF cable comes directly from the OTRx.

Max. of up to 3 PAs in 400 MHz range can be equipped in the ION-M 4/8 19".

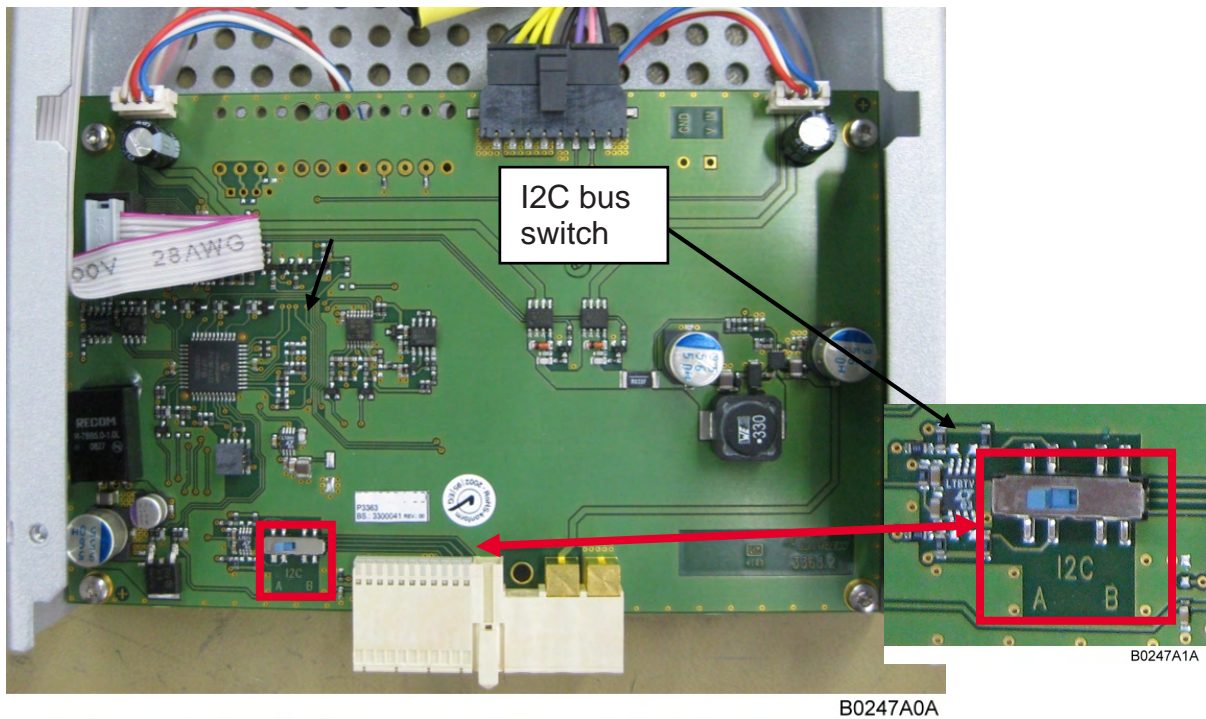

figure 3-9 I²C switch located on the amplifier board

Positions possible of I²C bus switch:

Non-redundant configuration	Redundant configuration			
	2 RUs in 1 subrack		2 RUs in 2 subracks	
1 RU & 1 EU in 1 subrack	or	A = RU 1	or	A = Main RU
A = Main RU		B = RU 2		B = Substitute RU
B = EU				

table 3-1 I²C bus switch on amplifier module, rear side

3.2.6. PSU Drawer

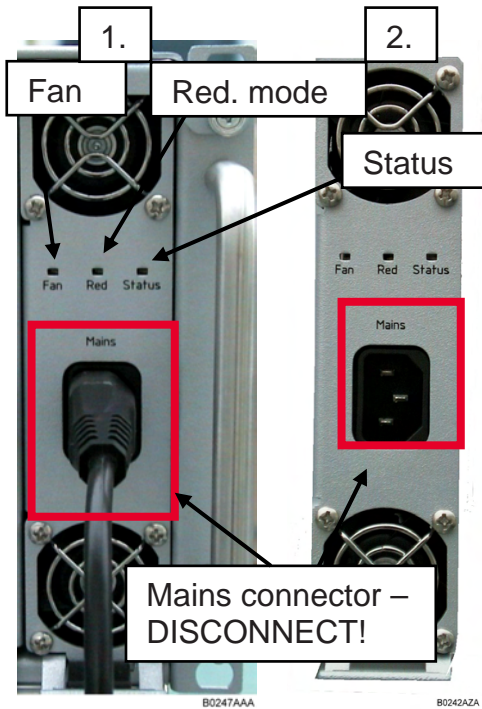

figure 3-10 PSU drawer

The power supply module is equipped with an IEC power connector for mains supply and a Status alarm LED.

Always disconnect the mains connector switch the PSU module off before removing it!

The Status LED shows a green light during normal error-free operation.

The Status LED shows a red light when there is a power-supply failure.

The Fan LED shows a red light when a fan alarm is raised due to a fan failure.

The Red. [Redundancy mode] LED shows green light if redundancy mode is configured. It never shows a red light.

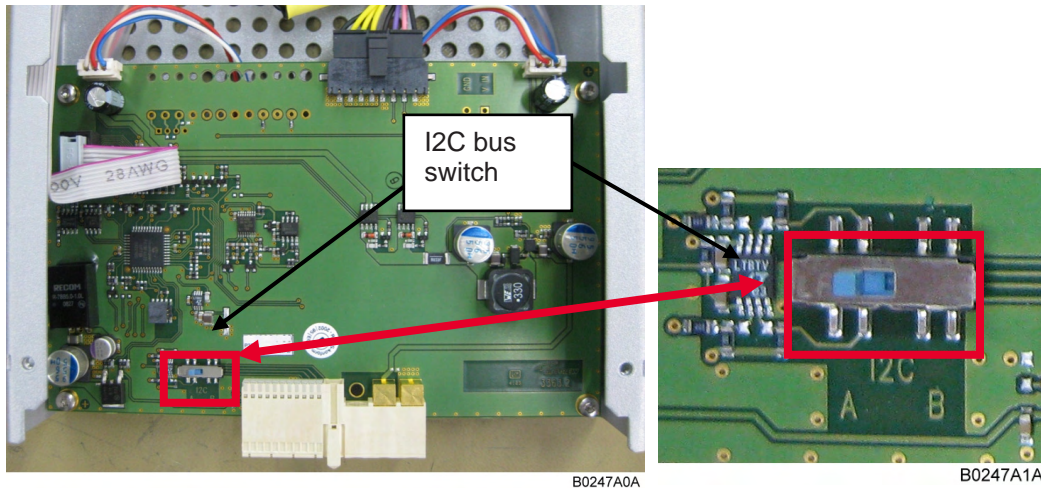

figure 3-11 I²C switch located on the PSU board

Positions possible of I²C bus switch:

Non-redundant configuration	Redundant configuration			
	2 RUs in 1 subrack		2 RUs in 2 subracks	
1 RU & 1 EU in 1 subrack	or	A = RU 1	or	A = Main RU
A = Main RU		B = RU 2		B = Substitute RU
B = EU				

table 3-2 I²C bus switch on PSU module, rear side

3.2.7. Duplexer Subrack

The duplexer subrack of the ION-M4/8 19" is available on 2 x 4 HUs.

The duplexer subrack of the 400 MHz band consists of up to 3 duplexers and the duplexer subrack of the 800 MHz band consists of just 1 duplexer, see following illustration:

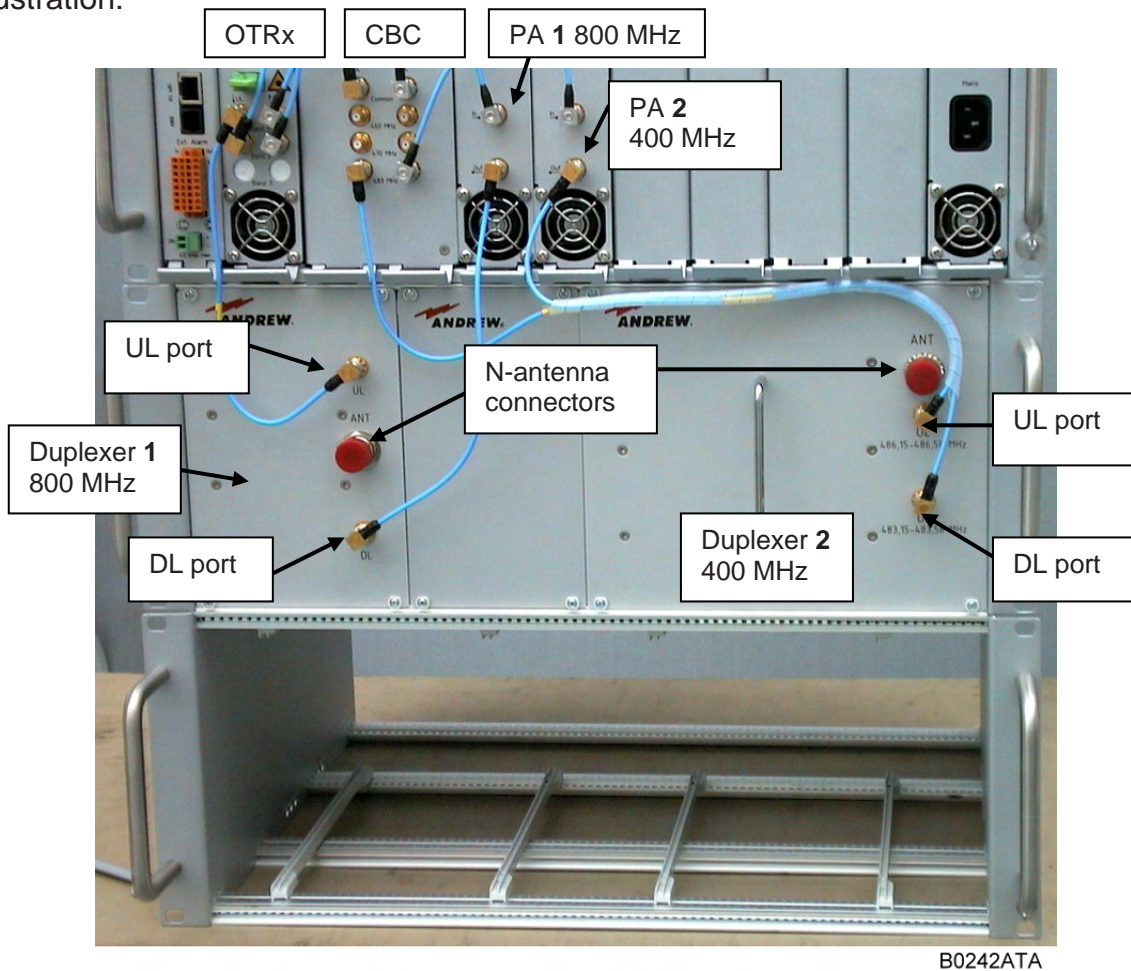

B0242ATA

figure 3-12 Duplexer subrack of ION-M4 19"

Each of the two duplexer modules is equipped with one N-female antenna port and two QMA connectors.

With the duplexer 2 the DL port is connected from the PA 2 OUT-port. The UL port of duplexer 2 is connected to the High-Band port of the crossband coupler. With the duplexer 1 the DL port is connected from the PA 1 OUT-port. The UL port of duplexer 1 to the 800 MHz UL-Band port of the OTRx.

4. COMMISSIONING

4.1. MECHANICAL INSTALLATION – GENERAL

Read the health and safety warnings in chapter *1.2 Health and Safety Warnings*.

1. **Do not install the unit in a way or at a place where the specifications outlined in the Environmental and Safety Specifications leaflet of the manufacturer are not met.**
2. **The unit is designated for 19" rack mounting only.**
3. **It is recommended only to use the mounting hardware delivered by the manufacturer. If different mounting hardware is used, the specifications for stationary use of the remote unit must not be exceeded.**

 **Note:** Exceeding the specified load limits may cause the loss of warranty!

4. **The unit is considerably heavy. Ensure there is adequate manpower to handle the weight of the system (43 kg).**



5. **Due to high power dissipation the ION-M4/8 19" can reach very high temperatures. For that reason sufficient airflow must be ensured so that the outside temperature and the air temperature inside the cabinet on installation site must not exceed 40 °C. The surface temperature must not exceed +70 C in any operating condition. Above and below the unit a minimum distance of 1 HU to other equipment has to be kept. Also observe the instructions in the individual mounting procedures.**
6. **Only operate the unit in the 19" rack with door or use additional fan module.**
7. **For mounting of the unit in a 19" rack, slide rails are required due to the considerable weight of the unit.**

If any different or additional mounting material is used, ensure that the mounting remains as safe as the mounting designed by the manufacturer. Ensure that the static and dynamic strengths are adequate for the environmental conditions of the site. The mounting itself must not vibrate, swing or move in any way that might cause damage to the remote unit.

4.2. ELECTRICAL INSTALLATION

4.2.1. General

Read the health and safety warnings in chapter *1.2 Health and Safety Warnings*.



1. This unit contains dangerous voltages. Loss of life, severe personal injury or property damage can be the result if the instructions contained in this manual are not followed.
2. It is compulsory to ground the unit before connecting power supply.
3. Although the remote unit is internally protected against over-voltage, it is strongly recommended to earth the antenna cables close to the antenna connectors of the remote unit for protection against atmospheric discharge. In areas with strong lightning it is highly recommended to insert additional lightning protection.
4. If the mains connector of the remote unit is not easily accessible, a disconnect device in the mains circuit must be provided within easy reach.
5. Before connecting or disconnecting the mains connector at the remote unit, ensure that mains supply is disconnected.
6. Make sure that an appropriate circuit breaker and an over-current limiting device are connected between mains and remote unit.
7. A connection of mains supply to a power socket requires the power socket to be nearby the remote unit.
8. Incorrectly wired connections can destroy electrical and electronic components.
9. To avoid corrosion at the connectors caused by electrochemical processes, the material of the cable connectors must not cause a higher potential difference than 0.6 V (see electrochemical contact series).
10. It is sufficient to tighten N-antenna connectors hand-screwed. Any use of a tool (e.g. pair of pliers) might cause damage to the connector and thus lead to malfunctioning of the remote unit.
11. For unstabilized electric networks which frequently generate spikes, it is advised to use a voltage limiting device.
12. The unit complies with the surge requirement according to EN 61000-4-5 (fine protection); however, it is recommended to install an additional medium (via local supply connection) and/or coarse protection (external surge protection) depending on the individual application in order to avoid damage caused by over-current.
13. Observe the labels on the front panels before connecting or disconnecting any cables.
14. Observe that the cable-cross section is $3 \times 1.5 \text{ mm}^2$ for the voltage feed and 4 mm^2 for the grounding bolt.

4.2.2. Cabling and Connections

first delivery



first delivery		
from	to	Cable-ID
X1	X23	7164727
X2	X7	7516613
X4	X15	7164726
X5	X11	7164725
X10	X31	7164728
X14	X17	7164725
X16	X25	7164727
X18	X32	7545547-00

G3189M000

figure 4-1 ION-M4/8 19" cabling on front side

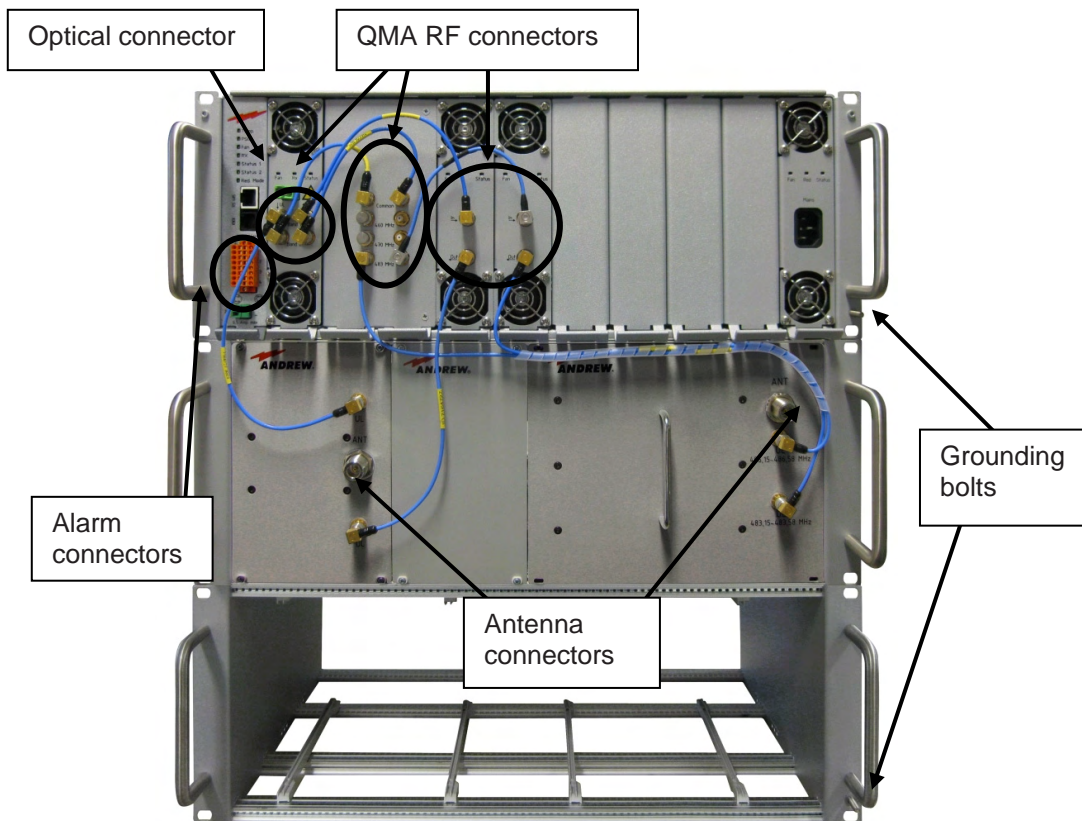

B0242ARA

figure 4-2 ION-M4/8 19" connectors on front side

4.2.3. Power Connection and Grounding

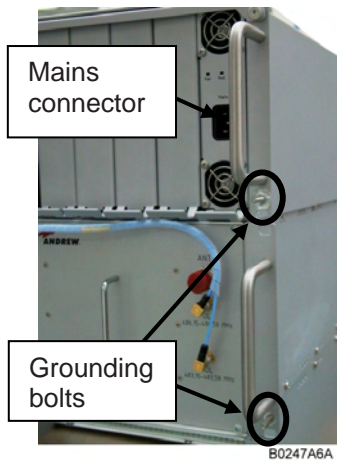

figure 4-3 Mains connector and grounding screw

Before connecting electrical power to the units, the system must be grounded at the grounding screw at the front side. Unscrew the grounding screw located at the front side (see illustrations above) and fasten a 4 mm² grounding cable there.

For power supply of the ION-M4/8 19", connect mains at the mains connector located at the front side of the ION-M4/8 19" cabinet. If the unit is equipped with two power supplies, two terminals are provided, one for each power supply.

4.3. CONNECTION OF THE ANTENNA CABLES

The remote unit has N-type antenna connectors. For its location, please refer to chapter 4.2.2 *Cabling and Connections*. For mounting the cable connectors, it is recommended to refer to the corresponding documentation of the connector manufacturer. The bending radius of the antenna cables must remain within the given specifications.

For the selection of cable and antenna it should be considered that, on the one hand, a cable with higher loss is less expensive but, on the other hand, it impairs performance.



It is sufficient to tighten the N-antenna connectors hand-tight. The use of a tool (like pliers) may cause damage to the connector and, therefore, lead to a malfunctioning of the remote unit.

4.4. OPTICAL-FIBRE-CABLE CONNECTION – RULES

Optical signals are transmitted by use of optical fibres. When connecting these fibres observe the following instructions.

Note: Care should be taken when connecting and disconnecting fibre-optic cables. Scratches and dust significantly affect system performance and may permanently damage the connector. Always use protective caps on fibre-optic connectors not in use.

In general, optical fibres do not need special protective measures. However, protection against environmental influences e.g. rodents and humidity must be considered.

The optical fibre is a single-mode fibre. Type is E9/125 µm with the following minimum requirements.

Attenuation:	<0.36 dB / km @ 1310 nm	/	<0.26 dB / km @ 1550 nm
Dispersion:	<3.5 ps / nm km @ 1310 nm	/	<18.0 ps / nm km @ 1550 nm

The specified bending radius of the optical fibres must not be exceeded. The pigtails for the connection between master and remote unit must have a sufficient length. A protection for the feeding into units must be given.

System attenuation and attenuation of optical components must be determined. This can be achieved by measuring attenuation and reflection with an appropriate measuring instrument. For pigtails, a total value of < 0.4 dB (measured to a reference plug) can be assumed due to the dead zone of the reflectometer. These measurements must be made with a sufficient length of optical fibre, at the input and output of the device which has to be measured.

Fibre-cable connectors have to be of the same type (E2000APC) as the connectors used for the unit. The fibre-optic cables are connected to the optical transceiver.



Angled connectors are not compatible with straight optical connectors; non-compatibility of connectors will result in permanent damage to both connectors.

Before connecting the fibre cables, follow the procedure below to ensure optimized performance. It is important for these procedures to be carried out with care:

- Remove fibre-optic protective caps.
- Do not bend the fibre-optic cable in a tight radius (< 4 cm) as this may cause cable damage and interrupt transmission.
- Using high-grade alcohol and lint-free cotton cleaning swabs, clean the end of the fibre-optic cable that will be inserted in the optical connectors on the donor interface box.
- Blow out the laser receptacle with clean and dry compressed air to remove any particulate matter.
- Connect the fibre-optic cables by inserting the cable end into the laser receptacle and aligning the key (on the cable end) with the keyed slot.
- Do not use any index matching gels or fluids of any kind in these connectors. Gels are intended for laboratory use and attract dirt in the field.

4.5. AUTO-LEVELLING

For a proper operation of the auto-levelling function, a defined level has to be set at the optical interface (DL) of the master unit. The proposed level will be indicated on the Auto-Levelling-Help on WEB-GUI

4.6. COMMISSIONING

Read the health and safety warnings in chapter *1.2 Health and Safety Warnings* as well as the description carefully to avoid mistakes and proceed step by step as described!

- Do not operate the remote unit without terminating the antenna connectors. The antenna connectors may be terminated by connecting them to their respective antennas or to a dummy load.
- Only qualified personnel should carry out the electrical, mechanical, commissioning and maintenance activities that require the unit to be powered on when open.
- When working on the remote unit do not damage the warranty labels on the devices. The warranty is void if the seals are broken.
- Ensure that all connections have been performed according to chapter *4.2.2 Cabling and Connections*.

Commissioning the ION-M4/8 19"

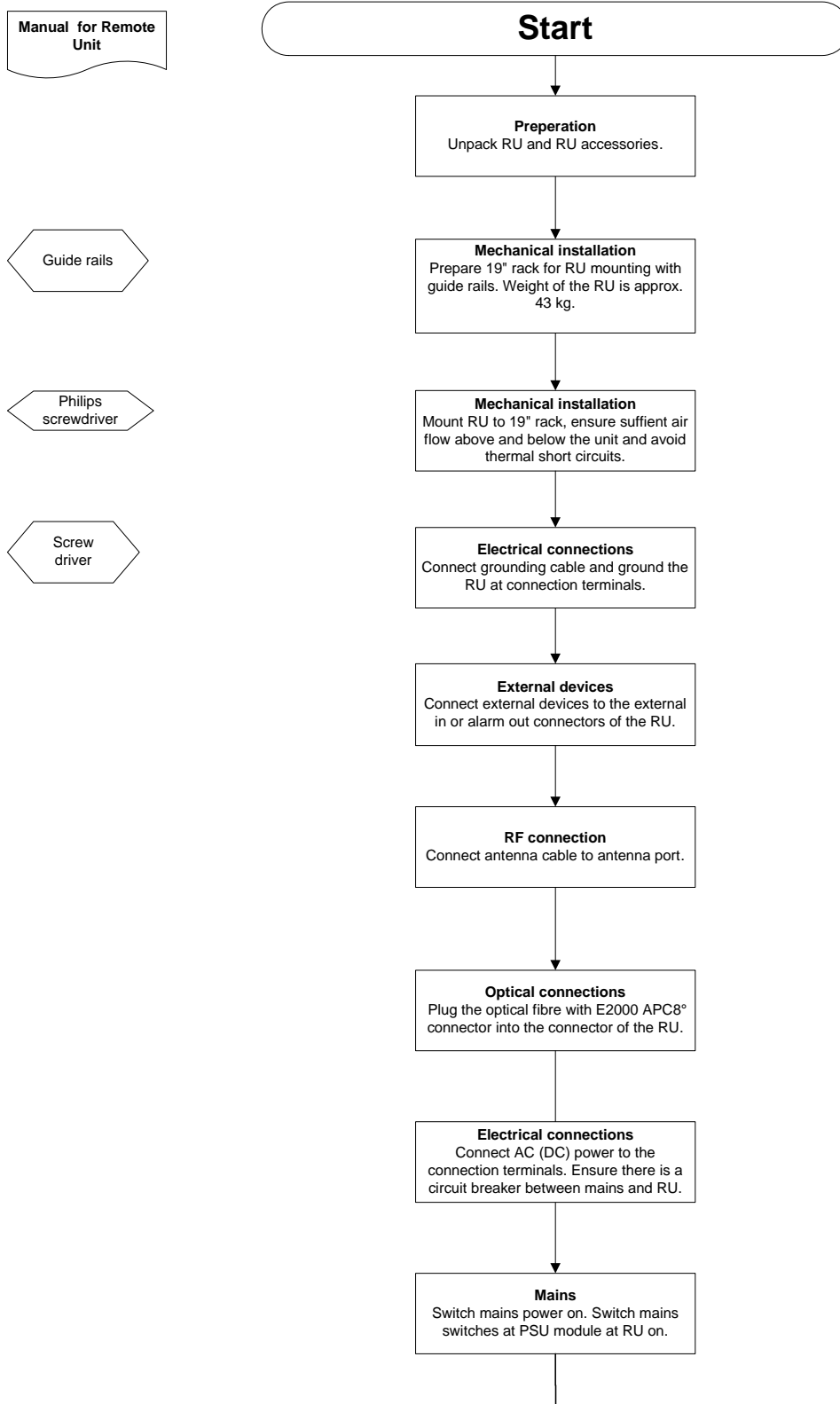

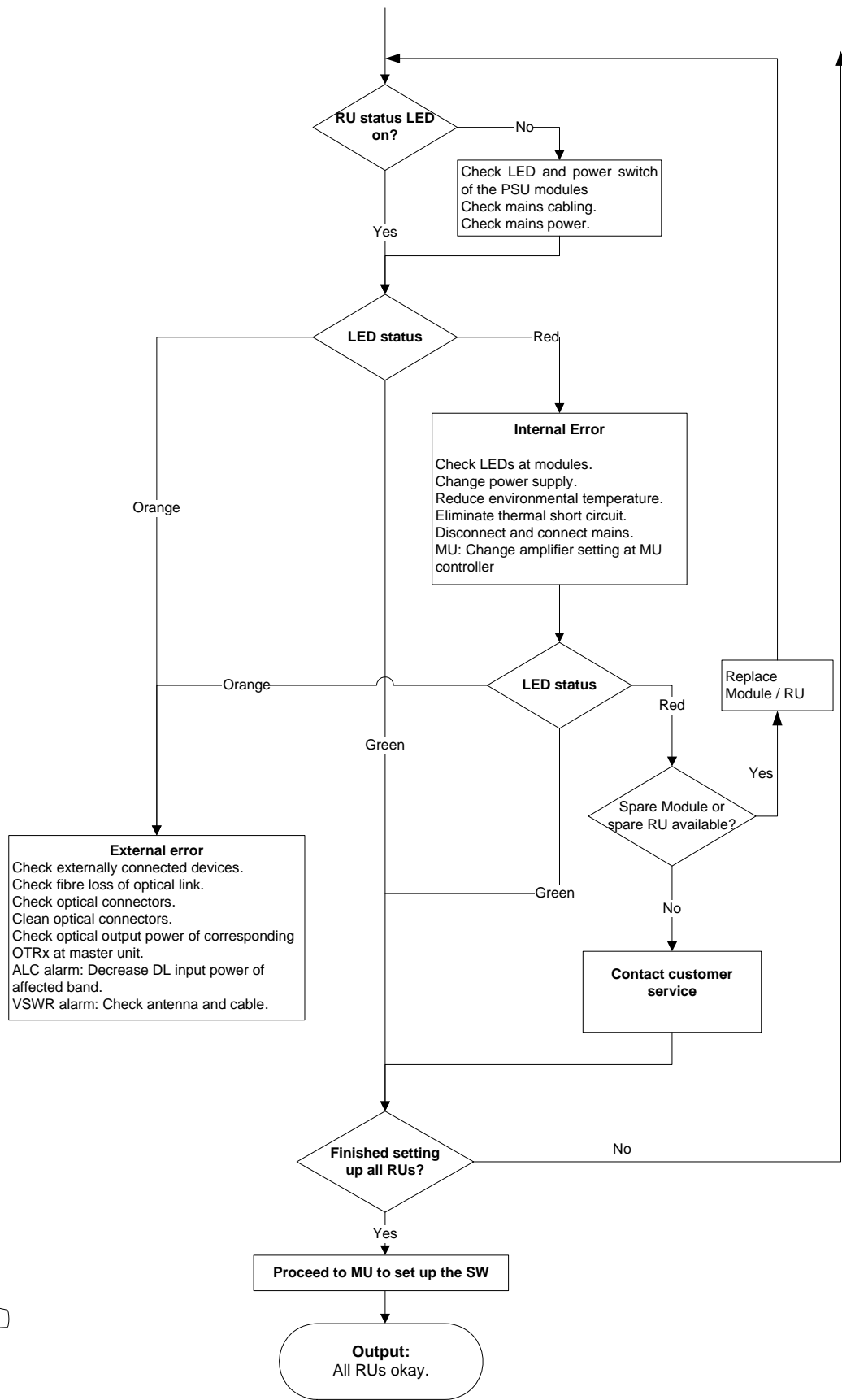

For your notes:

5. ALARMS

5.1. BITE AND ALARMS

The Built-In Test concept comprises the monitoring of the power supplies, the power amplifiers and the optical interface.

All alarms occurring can be checked via software at the master unit.

5.2. HANDLING OF ALARMS

As soon as the software acknowledges a valid alarm, a message is transmitted to the master unit.

If the reason for the alarm has been cleared or if the alarm should continue, a new alarm message will not be repeated. If there was an interruption of at least five seconds after acknowledgement, a new alarm message will be generated.

5.3. ALARM STATUS

For details refer to the corresponding software documentation of the master unit.

5.4. TROUBLESHOOTING

The status of the remote unit can be checked via the ION-M Master Unit (for details please refer to the software manual of the Master Controller). Locally, the status can be checked at the alarm board, see chapter *5.5 Status LED Alarms*.

5.5. STATUS LED ALARMS

For local supervision, an LED alarm board is provided. For layout and detailed description, please refer to chapter *3.2.2 Alarm Board*.

The following table shows the coding for the status LED and possible on-site measures that could be checked before referring to the master unit alarm list:

Status LED indication	Alarms	Possible on-site measures
Green	No alarm → Status ok	
Orange	<i>Alarms not directly related to RU:</i>	
	External alarms	Check externally connected devices.
	Optical alarm Rx	Check fibre loss of optical link. Check optical connectors. Clean optical connectors. <i>(MU: Check optical output power of corresponding OTRx at master unit).</i>
	ALC alarm	<i>(MU: Decrease DL input power of affected band).</i>
Red	<i>Alarms directly related to RU:</i>	
	Power 28 V	Change power supply. Replace the affected remote unit.
	Temperature	Reduce environmental temperature. Eliminate thermal short circuit.
	Fan	Disconnect and connect mains. Fans should run briefly.
	I ² C	Disconnect and connect mains.
	Optical alarm Tx	-
	Amplifier "Power Down"	<i>(MU: Change amplifier setting at MU controller).</i>
Status LED off	Mains	Check power switch. Check mains cabling. Check mains power.

table 5-1 Status LED alarm coding

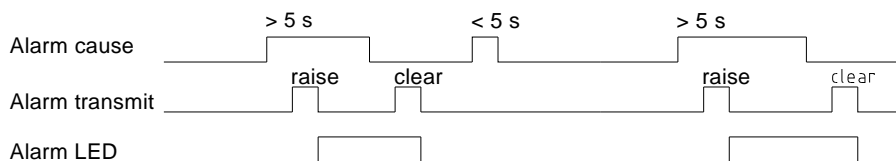

V1651A2

figure 5-1 Alarm triggering

6. MAINTENANCE

6.1. GENERAL

Read the health and safety warnings in chapter *1.2 Health and Safety Warnings*.

Note: The remote unit does not require preventative maintenance measures.

Maintenance of the ION-M4/8 19" should be performed by replacing only components that are contained in this chapter. In order to maintain warranty, take care not to damage unintentionally the seals on the modules.

Note: When sending back the unit, use an appropriate packaging, see chapter *7.2.3 Environmental and Safety Specifications*. We strongly recommend using the original packaging!

Note: Defect parts should only be replaced by original parts from the supplier. All interventions inside the housing are at one's own risk.

Note: During maintenance ensure the remote unit has been disconnected from mains.

Note: Before disconnecting any cables, label any unlabelled cables to ensure correct re-connection.

Note: If any system components were changed (DPX/OTRX/PA) a new "HW discovery" command needs to be carried out and system gain checked.

For most maintenance procedures appropriate tools are required to ensure correct handling. All these tools can be ordered from the supplier. For screwing procedures observe that all our screws have a right-hand thread, i.e. for fastening the screws turn the tool clockwise and for unscrewing them turn it counter-clockwise.

6.2. REPLACEMENT OF COMPONENTS

6.2.1. Replacement of Amplifier and Optical Plug-in Modules

For replacement of all plug-in modules, i.e. the OTRx, DPX and the amplifier modules except for the power supply modules, the following procedure applies:

- ☞ **Note :** Before plugging or unplugging any of the modules, disconnect mains by unplugging the IEC power connector.
- ☞ **Note :** As the modules are heavy, take appropriate measures to avoid injury.
- ☞ **Note:** Before disconnecting any cables, label any unlabelled cables to ensure correct re-connection.



figure 6-1 OTRx and amplifier modules, locking device

- To get access to the power amplifier (PA), the sheet by which the PA is covered must be removed. Therefore, unscrew the four M3x6 Phillips countersunk-head screws.
- Take out the defect plug-in module *carefully* at the locking device from the front side. Use your finger for pressing down the spring inside the locking device.
- When the PA module is exchanged, make sure the address, which can be adjusted by means of the rotary address switch (see following illustrations) has been set correctly according to the illustration on the labels and/ or the following table:

PA addresses of switch positions:					
Main Unit			Extension Unit		
800 MHz Band	PA 1:	0	2 nd 400 MHz Band	PA 3:	0
400 MHz Band	PA 2:	1	3 rd 400 MHz Band	PA 4:	1

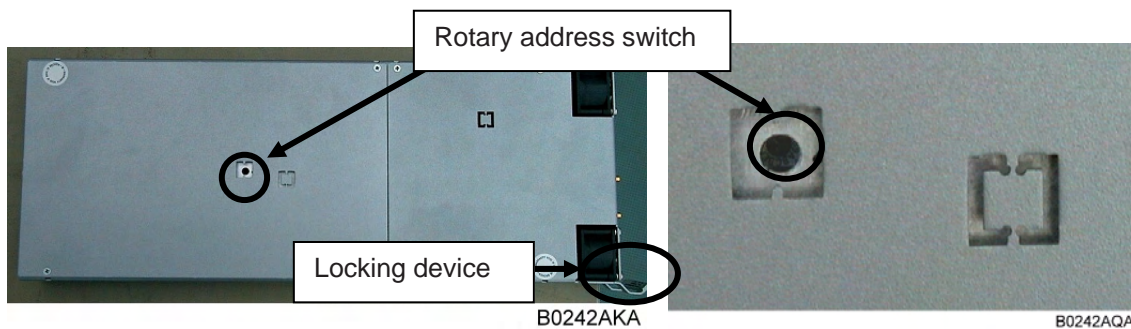

figure 6-2 Rotary address switch, location on PA

- Insert the new plug-in module until the stop by pressing down the spring of the locking device.
- Re-connect mains by re-connecting the IEC power connector.
- Run HW discovery command on the Web interface of the Master Unit.
- Check whether the system has to be levelled again.
- Check the system gain.

6.2.2. Replacement of Power Supply Plug-in Modules

The power supplies can be set up redundantly. Therefore, the system stays in operation during replacement of one PSU. When replacing a broken PSU by a new one, proceed in the following order:

- Disconnect mains from the defect PSU by unplugging the IEC power connector.
- Pull out the defect PSU plug-in module *carefully* at the locking device from the front side. Use your finger for pressing down the spring inside the locking device.



figure 6-3 PSU module, locking device

- Note: To get access to the PSU, the sheet by which the PSU is covered must be removed. Therefore, unscrew the four M3x6 Phillips countersunk-head screws.

- When the power supply module is exchanged, ensure the address, which can be adjusted by means of the rotary address switch (see following illustrations), has been set correctly according to the illustration on the labels and/ or the following table:

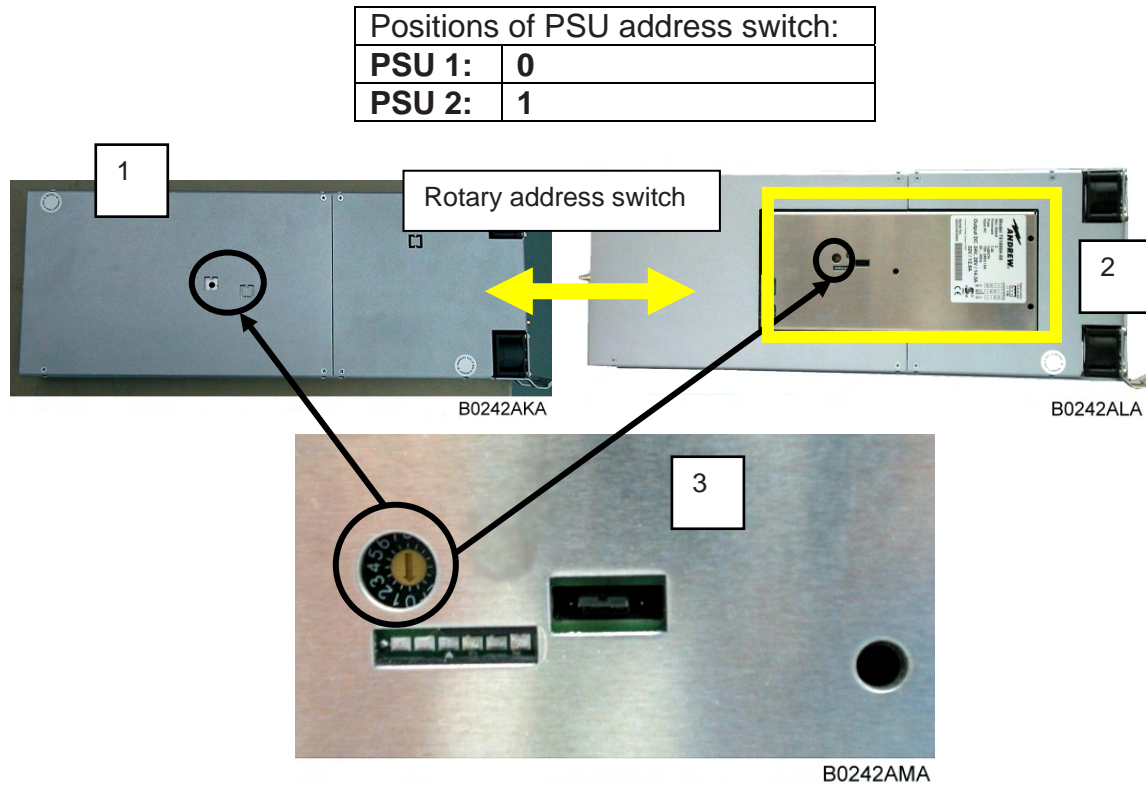

figure 6-4 Rotary address switch, location on PSU

- Insert the new plug-in module until the stop by pressing down the spring of the locking device.
- Reconnect mains by re-connecting the IEC power connector.

For your notes:

7. APPENDIX

7.1. LAYOUT

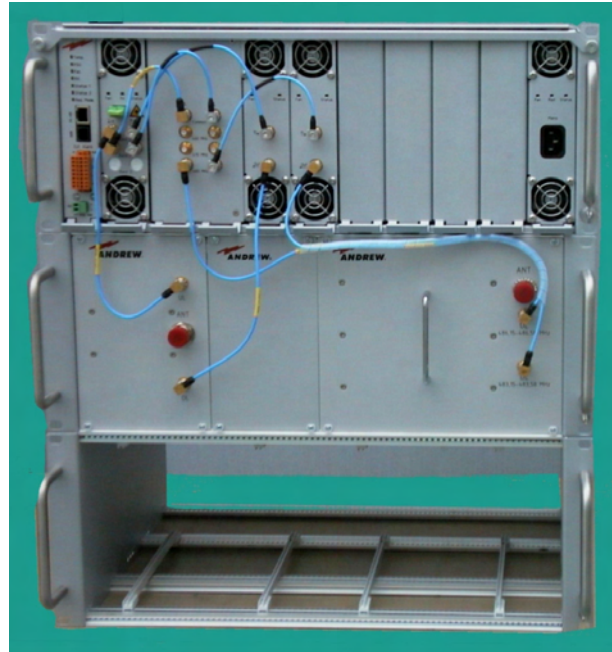

B0242ASA

figure 7-1 Layout of the ION-M4 19" remote unit, front side

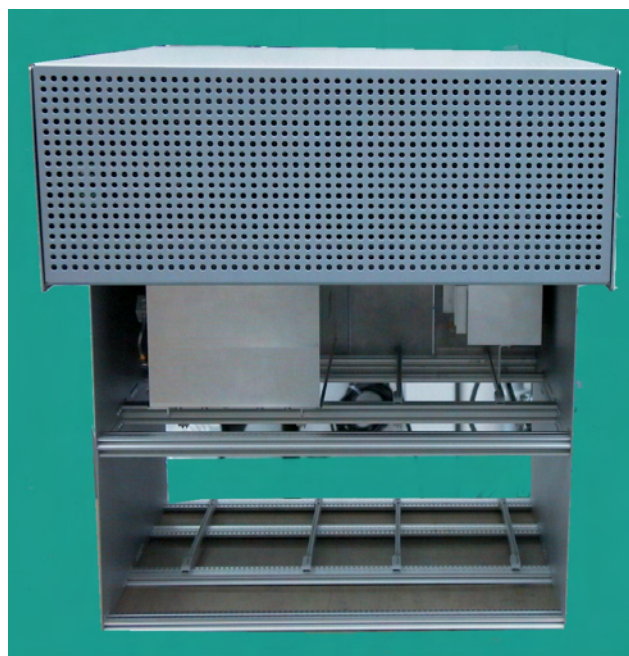

B0247A7A

figure 7-2 Layout of the ION-M4 19" remote unit, rear side

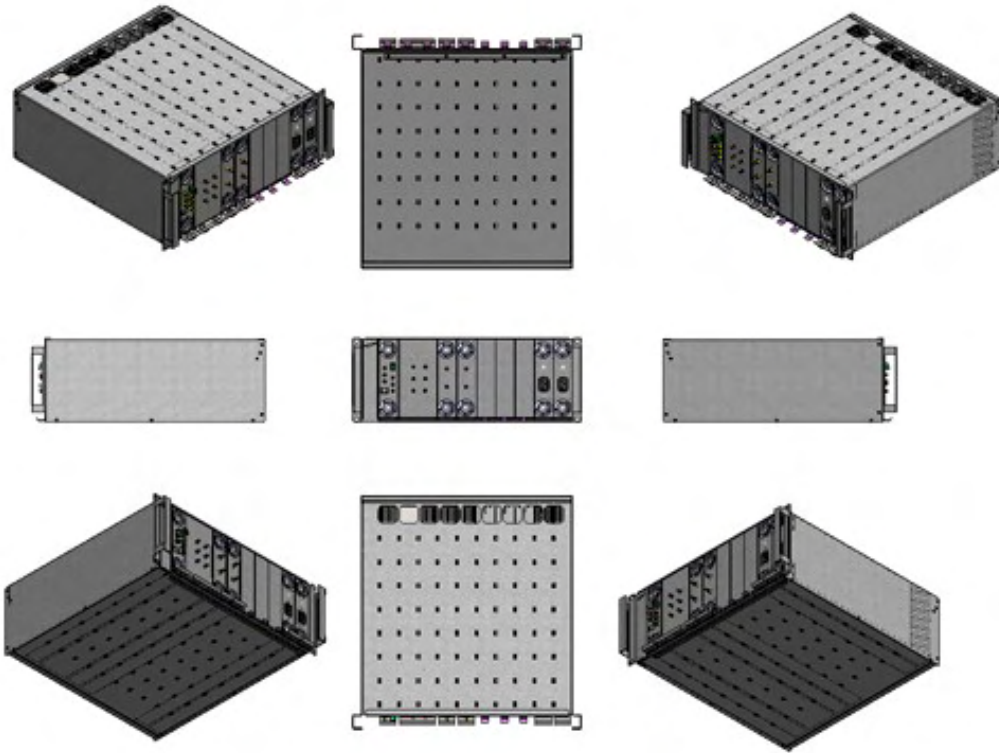

G3182Z000

figure 7-3 Cabinet drawing

7.2. SPECIFICATIONS

7.2.1. Electrical Specifications

Detailed ION-M4/8 19" – Product Specifications available on request.

Interface			
BTS Side	Connectors @ MU		Single duplexed RF port or two non-duplexed ports (QMA)
	BTS types		Micro: 33/43 dBm typical
	Antenna port	Connector	N Female
		Return loss @ RU	15 dB typical

System Supervision and Control	
Commands	RF on/off External control ports
Alarm	Summary, Power supply, Optical UL and DL failure, RF UL and DL failure, Temperature, Door open
Supervision	Composite output power

7.2.2. Mechanical Specifications

- ☞ **Spacing required: 70 mm from the front air inlet and 70 mm from the rear outlet of the subrack is compulsory. Do not block air inlet and outlet. Horizontal mounting is compulsory.**

Mechanical	
Height, width, depth	4 HU x 19" x 487 mm (4 HU x 19" x 19.2 in) 4 HU with optional additional duplexer or/and extension unit subrack
Weight (entire system)	43 kg (94.8 lb)

All figures are typical values.

All data is subject to change without notice.

7.2.3. Environmental and Safety Specifications

- ☞ **Note: For detailed information, please refer to the Environmental and Safety Specifications leaflet of the supplier, related to ETS 300 019 (European Telecommunication Standard).**

Environmental	
Temperature range	+5 °C to +40°C

All figures are typical values.

All data is subject to change without notice.

7.3. SPARE PARTS

The following lists contain all parts available for the Remote Unit. The configuration of the delivered unit meets the requirements of the customer and can differ depending on the state of the delivery.

Maintenance of the ION-M4/8 19" should be performed on an FRU (Field Replaceable Unit) basis only. The following spare parts lists only contain units that can be replaced without tuning or soldering work. To replace an FRU, use the appropriate tools. Replacement tools may be ordered from the supplier. If any FRU not contained in the following list needs to be replaced, please contact customer service for additional instructions.

Spare Parts List of the Remote Unit ION-M4/8 19"

Designation	ID No	FRU
<i>ION-M4/8 19"</i>	<i>7609239-0001</i>	
Alarm Card with Ext. Controller	7611246-00	
OTRX Drawer	7610964-00	
Crossbandcoupler Drawer	7610959-00	
Amplifier Drawer 450-490 MHz	7610960-00	
Amplifier Drawer 800 MHz	7610961-00	
PSU Drawer	7610963-00	
Main Subrack	7610958-00	
Dpx UL- active 486.15-486.575	7611284-00	
Dpx UL-active 806-824 851-869	7611286-00	
DPX Subrack	7611217-00	
Manual for ION-M4/8 19"	7613191-00	

The manufacturer reserves the right to replace the spare parts listed above by equivalent substitutes.

8. INDEX

A		I	
Abbreviations.....	7	Installation	
Address of Andrew Wireless Systems GmbH.....	12	Electrical	28
Alarm Board.....	19	Mechanical	27
Alarm Coding of Status LED.....	38	Introduction.....	13
Alarms		L	
Alarm Status	37	Layout	
Bite and Alarms	37	Cabinet Drawing	46
Handling of Alarms	37	Front	45
List	37	LED	37
RU	37	Levelling	32
Status LED.....	37	M	
Amplifier		Main Subrack 19	17
Address Switch	41	Maintenance	39
Replacement.....	40	Mounting	
Amplifier Drawer	22	General.....	27
Andrew Solutions.....	10	O	
B		OTRx	
Block Diagram	15	Replacement	40
C		OTRx Drawer	21
Cabinet Drawing	46	P	
Cabling	29	Power Supply	
Commissioning		Replacement	42
General.....	33	PSU	
Components	16	Address Switch	43
Connection		PSU Drawer	24
AC.....	30	R	
Connection Rules		Replacement of	
Optical Fibres.....	31	Power Supply	42
Optical-Fibre Cables	31	Replacement of Components	
Connections		Amplifier.....	40
Antenna	31	OTRx	40
Layout.....	29	S	
Power	30	Spare Parts	50
Power and Grounding.....	30	Specifications	
Contact Addresses	11	Electrical	47
Crossband-Coupler Drawer.....	22	Environmental and Safety.....	49
Customer Support Addresses.....	11	Mechanical	49
D		Status LED	
Declaration of Conformity	10	Alarm Coding.....	38
Duplexer Subrack.....	26	T	
F		Troubleshooting.....	37
Functions.....	13		
G			
Grounding.....	30		
H			
Health and Safety Warnings.....	9		

