

# COMMSCOPE®

## ION®-M7P/7P/17P

### Optical Remote Unit



(M-Cabinet)

Manual  
MF0145AUA

POWERED BY



**DISCLAIMER:**

This document has been developed by CommScope, and is intended for the use of its customers and customer support personnel. The information in this document is subject to change without notice. While every effort has been made to eliminate errors, CommScope disclaims liability for any difficulties arising from the interpretation of the information contained herein. The information contained herein does not claim to cover all details or variations in equipment, nor to provide for every possible incident to be met in connection with installation, operation, or maintenance. This document describes the performance of the product under the defined operational conditions and does not cover the performance under adverse or disturbed conditions. Should further information be desired, or should particular problems arise which are not covered sufficiently for the purchaser's purposes, contact CommScope.

CommScope reserves the right to change all hardware and software characteristics without notice.

**COPYRIGHT:**

© Copyright 2014 CommScope Inc. All Rights Reserved.

This document is protected by copyright. No part of this document may be reproduced, stored in a retrieval system, or transmitted, in any form or by any means, electronic, mechanical photocopying, recording, or otherwise without the prior written permission of CommScope.

**TRADEMARKS**

All trademarks identified by ® or ™ are registered trademarks or trademarks, respectively, of CommScope. Names of products mentioned herein are used for identification purposes only and may be trademarks and / or registered trademarks of their respective companies.

Andrew Wireless Systems GmbH, 04-August-2014

**TABLE OF CONTENTS**

<b>1. GENERAL</b>	<b>6</b>
1.1. USED ABBREVIATIONS	6
1.2. HEALTH AND SAFETY	7
1.3. PROPERTY DAMAGE WARNINGS	7
1.4. COMPLIANCE	8
1.5. ABOUT COMMSCOPE	11
1.6. INTERNATIONAL CONTACT ADDRESSES FOR CUSTOMER SUPPORT	12
<b>2. INTRODUCTION</b>	<b>14</b>
2.1. PURPOSE	14
2.2. THE ION-M7P/7P/17P	14
<b>3. FUNCTIONAL DESCRIPTION</b>	<b>16</b>
3.1. ACCESSORY EQUIPMENT	16
3.1.1. Fan-Protection Kit	16
3.1.2. Accessories	16
<b>4. COMMISSIONING</b>	<b>17</b>
4.1. MECHANICAL INSTALLATION	17
4.1.1. Health and Safety for Mechanical Installation	17
4.1.2. Property Damage Warnings for Mechanical Installation	17
4.1.3. Wall-Mounting Procedure	19
4.1.4. Pole Mounting	20
4.1.5. Mounting of Fan Protection	22
4.2. ELECTRICAL INSTALLATION	23
4.2.1. Health and Safety for Electrical Installation	23
4.2.2. Property Damage Warnings for Electrical Installation	23
4.2.3. Connections	24
4.2.4. Grounding (Earthing)	25
4.2.5. Connection of the Antenna Cables	26
4.2.6. Cleaning Procedure for RF Cable Connectors	27
4.2.7. Antenna Cable Connector Assembly	30
4.2.8. Optical-Fiber-Cable Connection - Rules	31
4.2.9. Protective Plug	33
4.2.10. Protective-Tube Kit	35
4.2.11. External-Alarm Inputs and Outputs	37
4.2.12. Power Connection	39
4.2.13. Commissioning Flowchart	40
<b>5. ALARMS AND TROUBLESHOOTING</b>	<b>42</b>

<b>6. MAINTENANCE</b>	<b>44</b>
6.1. GENERAL	44
6.2. REPLACING THE FAN UNIT	45
6.3. CLEANING THE HEAT SINK	46
<b>7. APPENDIX</b>	<b>47</b>
7.1. ILLUSTRATIONS	47
7.2. SPECIFICATIONS	48
7.2.1. Electrical Specifications	48
7.2.2. Environmental and Safety Specifications	48
7.2.3. Mechanical Specifications	48
7.3. SPARE PARTS	49
<b>8. INDEX</b>	<b>50</b>

**FIGURES AND TABLES**

figure 4-1 Wall mounting, (metric dimensions)..... 19

figure 4-2 Pole-mounting kit..... 20

figure 4-3 Pole mounting (metric dimensions)..... 21

figure 4-4 Mounting procedure for fan protection, (metric dimensions) ..... 22

figure 4-5 Connector flange of ION-M7P/7P/17P ..... 24

figure 4-6 Grounding bolt with loosened hex nut (left) and schematic view (right) .... 25

figure 4-7 Torque wrench for tightening ..... 26

figure 4-8 Protective-plug assembly ..... 33

figure 4-9 Tube-kit installation ..... 36

figure 4-10 Flange connector, 5 poles..... 37

figure 4-11 Alarm inputs (optocoupler) ..... 37

figure 4-12 Alarm outputs (optocoupler)..... 38

figure 4-13 Flange connector, 7 poles..... 38

figure 4-14 AC mains plug ..... 39

figure 4-15 DC mains plug..... 39

figure 7-1 Cabinet Drawing..... 47

table 1-1 List of international contact addresses..... 13

table 4-1 Specified torques..... 18

table 5-1 Status LED alarms..... 42

# 1. General

## 1.1. Used Abbreviations

3GPP	3 <sup>rd</sup> Generation Partnership Project
AC/DC	Alternating current / Direct Current
AIMOS	Andrew Integrated Management and Operating System
ALC	Automatic Level Control
BITE	Built-In Test Equipment
BTS	Base Transceiver Station
CE	"Conformité Européenne" ("European Conformity")
CD	Compact Disk
CFR	Code of Federal Regulations
DL	Downlink
DoC	Declaration of Conformity
EDGE	Enhanced Data Rates for GSM Evolution
EN	European Norm
EP	Extension Port
ESD	Electrostatic Discharge
ETS	European Telecommunication Standard
EU	Extension Unit
GSM	Global System for Mobile Communication
GND	Ground
GUI	Graphical User Interface
ICP3	Intercept Point 3rd order
ID No	Identification Number
ION	Intelligent Optical Network
IP	Ingress Protection
ISO	International Organization for Standardization
LED	Light Emitting Diode
LMT	Local Maintenance Terminal
LTE	Long Term Evolution
MIMO	Multiple Input Multiple Output
MS	Mobile Station
MU	Main Unit
NF	Noise Figure
OTRx	Optical Transceiver = SRMU (Subrack Master Unit)
PG	Packing Gland
PIM	Passive Intermodulation
R&TTE	Radio & Telecommunications Terminal Equipment
RF	Radio Frequency
RU	Remote Unit
RX	Receiver
SNMP	Simple Network Management Protocol
TX	Transmitter
UL	Uplink
UMTS	Universal Mobile Telecommunication System
UPS	Uninterruptible Power Supply
VSWR	Voltage Standing Wave Ratio
WCDMA	Wideband Code Division Multiple Access
WDM	Wavelength Division Multiplex

## 1.2. Health and Safety



1. **Danger:** Electrical hazard. Danger of death or fatal injury from electrical current. Obey all general and regional installation and safety regulations relating to work on high voltage installations, as well as regulations covering correct use of tools and personal protective equipment.



2. **Caution:** Laser radiation. Risk of eye injury in operation. Do not stare into the beam; do not view it directly or with optical instruments.



3. **Caution:** High frequency radiation in operation. Risk of health hazards associated with radiation from the unit's inner conductor of the antenna port(s). Disconnect mains before connecting or replacing antenna cables.



4. **Caution:** High frequency radiation in operation. Risk of health hazards associated with radiation from the antenna(s) connected to the unit. Implement prevention measures to avoid the possibility of close proximity to the antenna(s) while in operation.

## 1.3. Property Damage Warnings

1. **Attention:** Due to power dissipation, the Remote Unit may reach a very high temperature. Do not operate this equipment on or close to flammable materials. Use caution when servicing the unit.

2. **Notice:** Although the Remote Unit is internally protected against overvoltage, it is strongly recommended to ground (earth) the antenna cables close to the repeater's antenna connectors for protection against atmospheric discharge.



3. **Notice:** ESD precautions must be observed. Before commencing maintenance work, use the available grounding (earthing) system to connect ESD protection measures.

4. **Notice:** Only suitably qualified personnel are allowed to work on this unit and only after becoming familiar with all safety notices, installation, operation and maintenance procedures contained in this manual.

5. **Notice:** Keep operating instructions within easy reach and make them available to all users.

6. **Attention:** Only authorized and trained personnel are allowed to open the unit and get access to the inside.

7. **Notice:** Read and obey all the warning labels attached to the unit. Make sure that all warning labels are kept in a legible condition. Replace any missing or damaged labels.
8. **Notice:** Only license holders for the respective frequency range are allowed to operate this unit.
9. **Notice:** Make sure the repeater settings are correct for the intended use (refer to the manufacturer product information) and regulatory requirements are met. Do not carry out any modifications or fit any spare parts, which are not sold or recommended by the manufacturer.

## 1.4. Compliance

1. **Notice:** For installations, which have to comply with FCC RF exposure requirements, the antenna selection and installation must be completed in a way to ensure compliance with those FCC requirements. Depending on the RF frequency, rated output power, antenna gain, and the loss between the repeater and antenna, the minimum distance D to be maintained between the antenna location and human beings is calculated according to this formula:

$$D_{[cm]} = \sqrt{\frac{P_{[mW]}}{4 * \pi * PD_{[mW/cm^2]}}}$$

where

- P (mW) is the radiated power at the antenna, i.e. the max. rated repeater output power in addition to the antenna gain minus the loss between the repeater and the antenna.
- PD (mW/cm<sup>2</sup>) is the allowed Power Density limit acc. to 47 CFR 1.1310 (B) for general population / uncontrolled exposures which is
  - F (MHz) / 1500 for frequencies from 300MHz to 1500MHz
  - 1 for frequencies from 1500MHz to 100,000MHz

RF exposure compliance may need to be addressed at the time of licensing, as required by the responsible FCC Bureau(s), including antenna co-location requirements of 1.1307(b)(3).

2. **Notice:** For installations which have to comply with European EN50385 exposure compliance requirements, the following Power Density limits/guidelines (mW/cm<sup>2</sup>) according to ICNIRP are valid:
  - 0.2 for frequencies from 10 MHz to 400 MHz
  - F (MHz) / 2000 for frequencies from 400 MHz to 2 GHz
  - 1 for frequencies from 2 GHz to 300 GHz



**3. Notice:** Installation of this equipment is in full responsibility of the installer, who has also the responsibility, that cables and couplers are calculated into the maximum gain of the antennas, so that this value, which is filed in the FCC Grant and can be requested from the FCC data base, is not exceeded. The industrial boosters are shipped only as a naked booster without any installation devices or antennas as it needs for professional installation.

**4. Notice:** For installations which have to comply with FCC/Industry Canada requirements:

**English:**

This device complies with FCC Part 15 and Industry Canada license exempt RSS standard(s). Operation is subject to the following two conditions: (1) this device may not cause interference, and (2) this device must accept any interference, including interference that may cause undesired operation of the device.

This device complies with Health Canada's Safety Code. The installer of this device should ensure that RF radiation is not emitted in excess of the Health Canada's requirement. Information can be obtained at [http://www.hc-sc.gc.ca/ewh-semt/pubs/radiation/radio\\_guide-lignes\\_direct-eng.php](http://www.hc-sc.gc.ca/ewh-semt/pubs/radiation/radio_guide-lignes_direct-eng.php).

[//www.hc-sc.gc.ca/ewh-semt/pubs/radiation/radio\\_guide-lignes\\_direct-eng.php](http://www.hc-sc.gc.ca/ewh-semt/pubs/radiation/radio_guide-lignes_direct-eng.php).

Changes or modifications not expressly approved by the party responsible for compliance could void the user's authority to operate the equipment.

**French:**

Cet appareil est conforme à FCC Partie 15 d'Industrie Canada RSS standard exempts de licence (s). Son utilisation est soumise à Les deux conditions suivantes: (1) cet appareil ne peut pas provoquer d'interférences et (2) cet appareil doit accepter Toute interférence, y compris les interférences qui peuvent causer un mauvais fonctionnement du dispositif.

Cet appareil est conforme avec Santé Canada Code de sécurité 6. Le programme d'installation de cet appareil doit s'assurer que les rayonnements RF n'est pas émis au-delà de l'exigence de Santé Canada. Les informations peuvent être obtenues:

[http://www.hc-sc.gc.ca/ewh-semt/pubs/radiation/radio\\_guide-lignes\\_direct-fra.php](http://www.hc-sc.gc.ca/ewh-semt/pubs/radiation/radio_guide-lignes_direct-fra.php)

Les changements ou modifications non expressément approuvés par la partie responsable de la conformité pourraient annuler l'autorité de l'utilisateur à utiliser cet équipement.

**5. Notice:** Corresponding local particularities and regulations must be observed. For national deviations, please refer to the respective documents included in the manual CD that is delivered with the unit.

**6. Note:** For a Class A digital device or peripheral:

This equipment has been tested and found to comply with the limits for a Class A digital device, pursuant to part 15 of the FCC Rules. These limits are designed to provide reasonable protection against harmful interference when the equipment is operated in a commercial environment. This equipment generates, uses, and can radiate radio frequency energy and, if not installed and used in accordance with the instruction manual, may cause harmful interference to radio communications. Operation of this equipment in a residential area is likely to cause harmful interference in which case the user will be required to correct the interference at his own expense.

**7. Note:** This unit complies with European standard EN60950.

**Equipment Symbols Used / Compliance**

Please observe the meanings of the following symbols used in our equipment and the compliance warnings:

Symbol	Compliance	Meaning / Warning
---	FCC	WARNING: This is NOT a CONSUMER device. It is designed for installation by FCC LICENSEES and QUALIFIED INSTALLERS. You MUST have an FCC LICENSE or express consent of an FCC Licensee to operate this device. You MUST register Class B signal boosters (as defined in 47 CFR 90.219) online at <a href="http://www.fcc.gov/signal-boosters/registration">www.fcc.gov/signal-boosters/registration</a> . Unauthorized use may result in significant forfeiture penalties, including penalties in excess of \$100,000 for each continuing violation.
	CE	Alert sign to R&TTE To be sold exclusively to mobile operators or authorized installers – no harmonized frequency bands, operation requires license. Intended use: EU and EFTA countries
CE 0700		Indicates conformity with the R&TTE directive 1999/5/EC certified by the notified body no. 0700.

## 1.5. About CommScope

*CommScope* is the foremost supplier of one-stop, end-to-end radio frequency (RF) solutions. Part of the *CommScope* portfolio are complete solutions for wireless infrastructure from top-of-the-tower base station antennas to cable systems and cabinets, RF site solutions, signal distribution, and network optimization. For patents see [www.cs-pat.com](http://www.cs-pat.com).

*CommScope* has global engineering and manufacturing facilities. In addition, it maintains field engineering offices throughout the world.

*Andrew Wireless Systems GmbH* based in Buchdorf/Germany, which is part of *CommScope*, is a leading manufacturer of coverage equipment for mobile radio networks, specializing in high performance, RF and optical repeaters. Our optical distributed networks and RF repeater systems provide coverage and capacity solution for wireless networks in both indoor installations and outdoor environments, e.g. tunnels, subways, in-trains, airport buildings, stadiums, skyscrapers, shopping malls, hotels and conference rooms.

*Andrew Wireless Systems GmbH* operates a quality management system in compliance with the requirements of ISO 9001 and TL 9000. All equipment is manufactured using highly reliable material. To maintain highest quality of the products, comprehensive quality monitoring is conducted at all fabrication stages. Finished products leave the factory only after a thorough final acceptance test, accompanied by a test certificate guaranteeing optimal operation.

This product meets the requirements of the R&TTE directive and the Declaration of Conformity (DoC) itself. A current version of the CE DoC is included in this manual CD delivered \*. Any updated version of the DoC is available upon request from the local sales offices or directly from *CommScope* via the local Customer Support at one of the addresses listed in the following chapter.

**According to the DoC, our "CE"-marked equipment can be used in all member states of the European Union.**

☞ **Note:** **Exceptions of and national deviations from this intended use may be possible. To observe corresponding local particularities and regulations, please refer to the respective documents (also in national language) which are included in the manual CD delivered.**

\* In case the Declaration of Conformity (DoC) for the product was not included in the manual CD delivered, it is available upon request from the local sales offices or directly from *CommScope* at one of the addresses listed in the following chapter.

To make the most of this product, we recommend you carefully read the instructions in this manual and commission the system only according to these instructions.

For technical assistance and support, please also contact the local office or *CommScope* directly at one of the addresses listed in the following chapter.

## 1.6. International Contact Addresses for Customer Support

<b>Canada</b>		<b>United States</b>
<p style="text-align: center;"><b>CommScope Canada</b></p> <p>Mail 505 Consumers Road, Suite 803 Toronto M2J 4V8, Canada</p> <p>Phone +1-905-878-3457 (Office) +1-416-721-5058 (Cell)</p> <p>Fax +1-905-878-3297</p> <p>E-mail wisupport@commscope.com</p>		<p style="text-align: center;"><b>Andrew LLC, A CommScope Company</b></p> <p>Mail 620 North Greenfield Parkway Garner, NC 27529, U.S.A.</p> <p>Phone +1-888-297-6433</p> <p>Fax +1-919-329-8950</p> <p>E-mail wisupport@commscope.com</p>
<b>Caribbean &amp; South American Region</b>	<b>A M E R I C A S</b>	<b>Caribbean &amp; Central American Region</b>
<p style="text-align: center;"><b>CommScope Cabos do Brasil Ltda.</b></p> <p>Mail CALA Tech Support for <i>Distributed Coverage &amp; Capacity Solutions (DCCS) products:</i> Rua Guaporanga, 49 Praça Seca – Rio de Janeiro – RJ ZIP: 21320-180, Brazil</p> <p>Phone +1-815-546-7154 (Cell) +55-15-9104-7722 (Office)</p> <p>Fax + 55-15-2102-4001</p> <p>E-mail wisupport@commscope.com</p>		<p style="text-align: center;"><b>CommScope Mexico S.A. de C.V.</b></p> <p>Mail CALA Tech Support for <i>Distributed Coverage &amp; Capacity Solutions (DCCS) products:</i> Av. Insurgentes Sur 688, Piso 6 Col. Del Valle, CP: 03100 Mexico City, Mexico</p> <p>Phone +52-55-1346-1900 (Office)</p> <p>Fax +52-55-1346-1901</p> <p>E-mail wisupport@commscope.com</p>
<b>China, India and Rest of Asia</b>		<b>Australia &amp; New Zealand</b>
<p style="text-align: center;"><b>Andrew International Corporation</b></p> <p>Mail Room 915, 9/F Chevalier Commercial Centre 8 Wang Hoi Rd Kowloon Bay, Hong Kong</p> <p>Phone +852-3106-6100</p> <p>Fax +852-2751-7800</p> <p>E-mail wisupport.China@commscope.com</p>	<b>A P I A C</b>	<p style="text-align: center;"><b>Andrew Corporation (Australia) Pty Ltd.</b></p> <p>Mail Unit 1 153 Barry Road Campbellfield VIC 3061, Australia</p> <p>Phone +613-9300-7969</p> <p>Fax +613-9357-9110</p> <p>E-mail wisupport.Australia@commscope.com</p>
<b>Middle East &amp; North Africa</b>		<b>South Africa</b>
<p style="text-align: center;"><b>CommScope Solutions International Inc. (Branch)</b></p> <p>Mail PO Box 48 78 22 Unit 3206, Floor 32, Jumeirah Business Center 5, Jumeirah Lakes Towers, Dubai, United Arab Emirates</p> <p>Phone +971 4 390 09 80</p> <p>Fax +971 4 390 86 23</p> <p>E-mail wisupport@commscope.com</p>	<b>A f r i c a &amp; M i d d l e E a s t</b>	<p style="text-align: center;"><b>Andrew Wireless Solutions Africa (PTY) LTD</b></p> <p>Mail 11 Commerce Crescent West Eastgate, Sandton PO Box 786117 Sandton 2146 South Africa</p> <p>Phone + 27 11-719-6000</p> <p>Fax + 27 11-444-5393</p> <p>E-mail wisupport@commscope.com</p>

<b>United Kingdom</b>		<b>Scandinavia</b>
<b>Andrew Wireless Systems UK Ltd</b> Unit 15, Ilex Building Mulberry Business Park Mail Fishponds Road Wokingham Berkshire RG41 2GY, England Phone +44-1189-366-792 Fax +44-1189-366-773 E-mail wisupport.uk@commscope.com		<b>Andrew Norway (AMNW)</b> P.O. Box 3066 Mail Osloveien 10 Hoenefoss 3501 Norway Phone + 47 32-12-3530 Fax + 47 32-12-3531 E-mail wisupport@commscope.com
<b>Germany</b>		<b>France</b>
<b>Andrew Wireless Systems GmbH</b> Industriering 10 Mail 86675 Buchdorf Germany Phone +49-9099-69-0 Fax +49-9099-69-930 E-mail wisupport@commscope.com	<b>E U R O P E</b>	<b>CommScope France</b> Immeuble Le Lavoisier Mail 4, Place des Vosges 92052 Courbevoie, France Phone +33-1 82 97 04 00 Fax +33-1 47 89 45 25 E-mail wisupport@commscope.com
<b>Austria</b>		<b>Switzerland</b>
<b>Andrew Wireless Systems (Austria) GmbH</b> Weglgasse 10 Mail 2320 Wien-Schwechat Austria Phone +43-1706-39-99-10 Fax +43-1706-39-99-9 E-mail wisupport.austria@commscope.com		<b>CommScope Wireless Systems AG</b> Tiergartenweg 1 Mail CH-4710 Balsthal Switzerland Phone +41-62-386-1260 Fax +41-62-386-1261 E-mail wisupport.ch@commscope.com
<b>Italy</b>		<b>Iberia Region - Spain &amp; Portugal</b>
<b>CommScope Italy S.r.l., Faenza, Italy</b> Via Mengolina, 20 Mail 48018 Faenza (RA) Italy Phone +39-0546-697111 Fax +39-0546-682768 E-mail wisupport.italia@commscope.com		<b>Andrew España S.A. A CommScope Company</b> Avda. de Europa, 4 - 2ª pta. Mail Parque Empresarial de la Moraleja Alcobendas, Madrid 28108, Spain Phone +34-91-745-20 40 Fax +34-91-661-87 02 E-mail wisupport.iberia@commscope.com
<b>Czech Republic</b>		
<b>CommScope Solutions Czech Republic C-Com, spol. s r.o</b> U Moruší 888 Mail 53006 Pardubice, Czech Republic Phone +49 871 9659171 (Office) +49 171 4001166 (Mobile) Fax +49 871 9659172 E-mail wisupport@commscope.com		

table 1-1 List of international contact addresses

## 2. Introduction

### 2.1. Purpose

Cellular telephone systems transmit signals in two directions between base transceiver station (BTS) and mobile stations (MS) within the signal coverage area.

If weak signal transmissions occur within the coverage area because of indoor applications, topological conditions or distance from the transmitter, extension of the transmission range can be achieved by means of an optical distribution system.

Such a system contains an optical Master Unit and several Remote Units. The number of the Remote Units depends on the hardware and software configuration. The Remote Units are connected to the Master Unit with optical links. The optical loss must be less than 10 dB inclusive optical couplers or splitters.

The Master Unit is the connection to the base transceiver stations. The configuration of a Master Unit depends on the number of the Remote Units and the frequency range.

WDM (Wave Division Multiplex) filters are integrated in the optical modules. For the UL, a wavelength within 1546 nm – 1550 nm is used. For the DL, a wavelength of  $1310 \pm 10$  nm is used. The maximum output power for the UL and DL is 6.7 mW.

### 2.2. The ION-M7P/7P/17P

The ION optical distribution system is a cost-effective coverage solution for dense urban areas, tunnels, subway, airports, convention centers, high-rise buildings and other locations where physical structures increase path loss. It has been specifically designed to reduce zoning problems and to provide homogeneous coverage. The compact, mechanical design is specifically architected to mount inside of poles or alongside structures in such a way that it has a minimal visual impact.

The ION-M7P/7P/17P is a LTE 700 MHz MIMO, 1700/2100 MHz CDMA, WCDMA, and LTE multi-operator Remote Unit. It is used in conjunction with a Master Unit in the ION optical distribution system. This system transports multiple LTE channels, and 1700/2100 MHz wideband signals simultaneously, providing a cost-effective solution for distributing capacity from one or more base stations.

The ION-M7P/7P/17P transports signals on the RF layer in a very inexpensive manner. This means that multiple operators and multiple technologies are moved simultaneously from a cluster of base stations to a remote location over the same fiber.

The ION-M7P/7P/17P is available in single (SISO) or multi-channel (MIMO) configuration supporting 700 MHz, and 1700/2100 MHz in parallel. It has been specifically tested and optimized for LTE, CDMA, and WCDMA signals.

The ION is easily set-up and supervised via a graphical user interface (GUI). Remote units can be commissioned through the use of built-in test equipment. An auto-leveling function compensates for the optical link loss making installation easy and quick. The entire system may be monitored remotely via an Andrew OMC. This platform uses SNMP protocol and is compliant to X.733 standard.

Should a sophisticated interface not be required, the master unit can be directly connected to the alarm inter-face of a base station via its contact relay.

- Multi-channel, multi-operator support
- Reduced visual impact form factor
- Efficient, high power amplifiers
- Single fiber for MIMO and multiple Remote Units
- Comprehensive operations and management system for configuration and alarming
- A.I.M.O.S. with SNMP according to X.733 standard
- With reference to 3GPP TS25.143/TS25.106/ TS36.143/TS36.106 and 3GPP2C.S0051-0
- Easy installation and commissioning

## 3. Functional Description

### 3.1. Accessory Equipment

#### 3.1.1. Fan-Protection Kit

In order to protect the fan unit (e.g. against rain), a protective cover to be mounted over the air inlet is delivered with the unit. For more details see section 4.1.5 Mounting of Fan Protection.

**Mounting of the fan-protection kit is only mandatory for outdoor applications,** however, not mandatory for indoor applications.

#### 3.1.2. Accessories

For the accessories available for the Remote Unit, e.g. overcoat housing, connecting box or iso-trafo kit, a separate manual is available.



## 4. Commissioning

Read and observe the health, safety, and property damage warnings as well as the description carefully to avoid mistakes and proceed step-by-step as described.

- **Attention:** Do not operate the Remote Unit without terminating the antenna connectors. The antenna connectors may be terminated by connecting them to their respective antennas or to a dummy load.
- **Notice:** Only qualified personnel should carry out the electrical, mechanical, commissioning, and maintenance activities that require the unit to be powered on when open.
- When opening the Remote Unit do not damage the warranty labels on the internal devices. The warranty is void if the seals are broken.

### 4.1. Mechanical Installation

#### 4.1.1. Health and Safety for Mechanical Installation



1. **Caution:** Risk of injury by the considerable weight of the unit falling. Ensure there is adequate manpower to handle the weight of the system.



2. **Caution:** Risk of serious personal injury by equipment falling due to improper installation. The installer must verify that the supporting surface will safely support the combined load of the electronic equipment and all attached hardware and components. The screws and dowels (wall anchors) used should also be appropriate for the structure of the supporting wall.

#### 4.1.2. Property Damage Warnings for Mechanical Installation

1. **Attention:** Do not install the unit in a way or at a place where the specifications outlined in the Environmental and Safety Specifications leaflet of the supplier are not met.
2. **Attention:** Due to power dissipation, the Remote Unit may reach a very high temperature. Ensure sufficient airflow for ventilation.
3. **Notice:** Exceeding the specified load limits may cause the loss of warranty.
4. **Notice:** When connecting and mounting the cables (RF, optical, mains, ...) ensure that no water can penetrate into the unit through these cables.
5. **Notice:** Also observe all additional rules or restrictions regarding mounting that depend on the type of Remote Unit. For details refer to section 7.2.2 *Mechanical Specification*. Install the unit vertically with the fan unit at the top. A maximum tilt angle of 25° from a vertical position must be kept, as in the following illustrations:

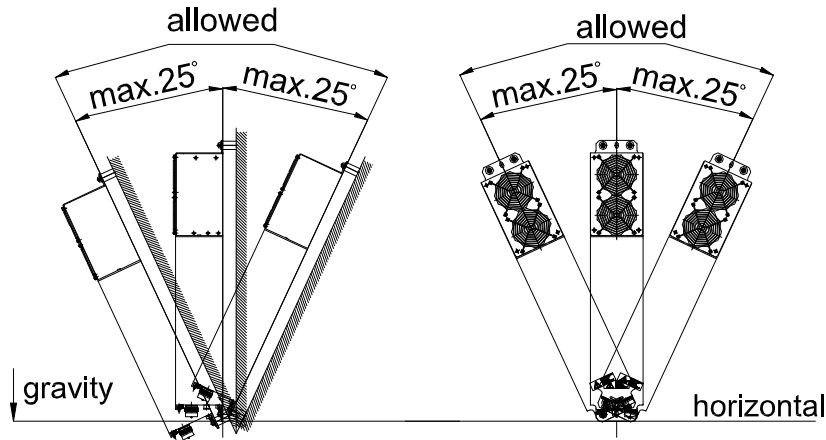

G1038M4

6. **Notice:** A spacing of 40 mm (1.58 inch) around the unit is required.
7. **Notice:** To ensure sufficient airflow when mounting the unit in enclosed spaces, two lid openings (one for the air inlet and the other for the air outlet) must be provided. Do not block these air inlets and outlets when mounting the Remote Unit. The size of each opening must equal at least 16 x 16 cm (>250 cm<sup>2</sup>). Ensure that there is no thermal short circuit between the air inlet and air outlet. Make sure free airflow is not deflected or otherwise obstructed.
8. **Notice:** Depending on the installation type (wall or pole), the corresponding mounting kits must be ordered from the manufacturer. If any different or additional mounting material is used, ensure that the mounting remains as safe as the mounting designed by the manufacturer. The specifications for stationary use of the Remote Unit must not be exceeded. Ensure that the static and dynamic strengths are adequate for the environmental conditions of the site. The mounting itself must not vibrate, swing or move in any way that might cause damage to the Remote Unit.
9. **Notice:** To avoid damage when mounting the unit, always make sure that the M8 washers (DIN9021 or DIN125 depending on the mounting kit) are placed behind and in front of the mounting drillings of the unit.

Specified torques have to be observed for certain mounting procedures according to the following table:

Type	Tallow-drop screws	Hex nuts	Spacing bolts		PG (plastic)	PG (aluminium)
Thread	M 4	M 8	M 4	M 8	PG 13.5	PG 29
Specified torques	3.3 N-m	27 N-m	2.3 N-m	27 N-m	3.75 N-m	10 N-m

table 4-1 Specified torques

The mounting procedures for a stand-alone Remote Unit without optional accessories are described and illustrated in the following sections. For further information regarding special mounting procedures including mounting of accessory equipment, please see separate manual.

### 4.1.3. Wall-Mounting Procedure

- Check the suitability of the wall-mounting kit and the wall.
- Mark the position of the drilling holes (for measurements refer to figure 4-1 Wall mounting). Drill four holes at the marked positions and insert dowels \*.
- Use a cap nut or lock nut to screw the four dowel screws into the dowels and put the distance tubes over the screws.
- Hang the mounting brackets of the Remote Unit into the screws, and fasten them immediately using the washers and nuts.
- Ensure that there is free access to the electrical connections as well as to the cabinet. The approved bending radius of the connected cables must not be exceeded.

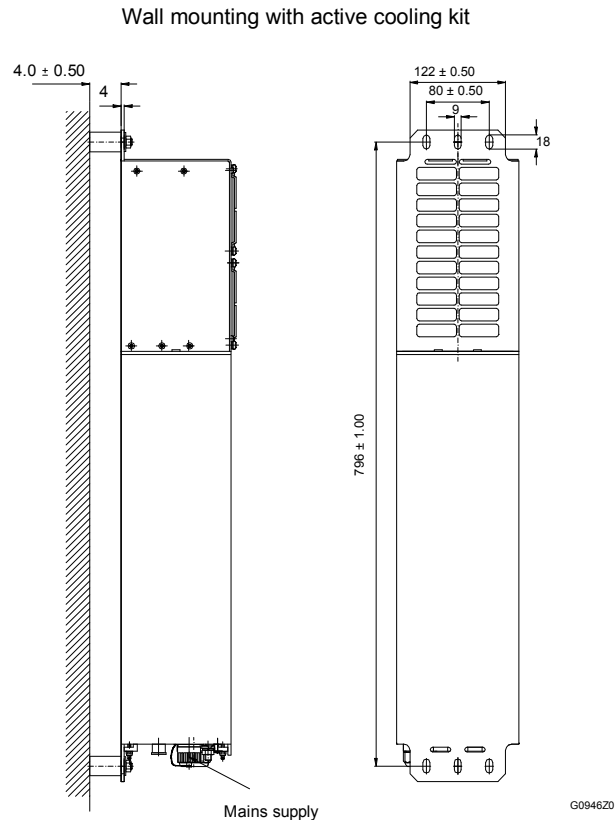

figure 4-1 Wall mounting, (metric dimensions)

\* The dowels are not part of the delivery since the suitable type depends on the on-site conditions (material of wall). Therefore, use dowels that are appropriate for the mounting surface.

#### 4.1.4. Pole Mounting

Standard mounting hardware cannot be used to mount the Remote Unit to a pole, a column or other similar structures. Additional hardware must be used for this type of installation. Such a pole-mounting kit could include two threaded rods M8, two U-beams and mounting material like bolts and nuts.

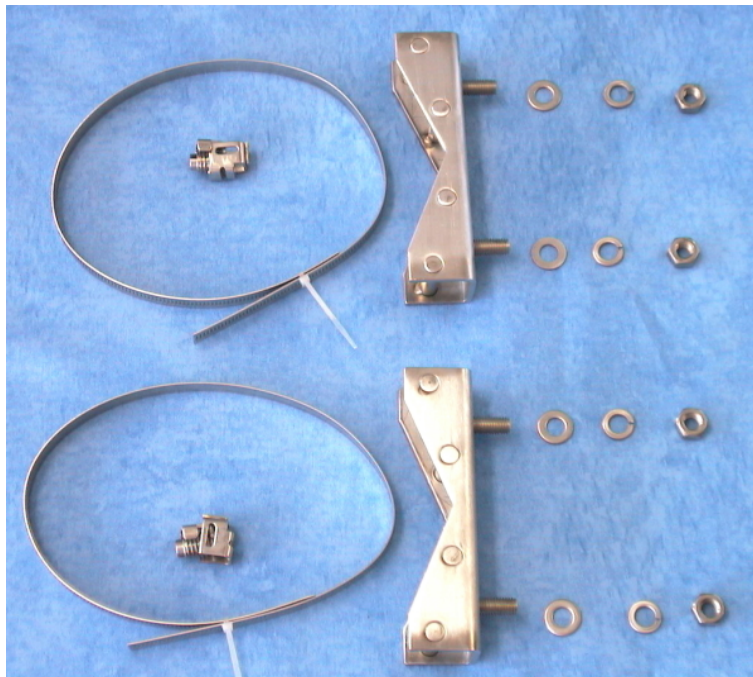

figure 4-2 Pole-mounting kit

- Use the screw bands to fasten the two U-beams to the pole as illustrated in *figure 4-3 Pole mounting*.

👉 **Note:** When fastening the U-beams make sure that they are installed congruently and not at an angle to each other. To determine the distance between the beams refer to chapter 4.1.3 *Wall-Mounting Procedure* for measurements.

- Hang the mounting brackets of the Remote Unit into the threaded bolts of the U-beam, and fasten them immediately using the washers and nuts.

Ensure that there is free access to the electrical connections as well as to the cabinet. The approved bending radius of the connected cables must not be exceeded.

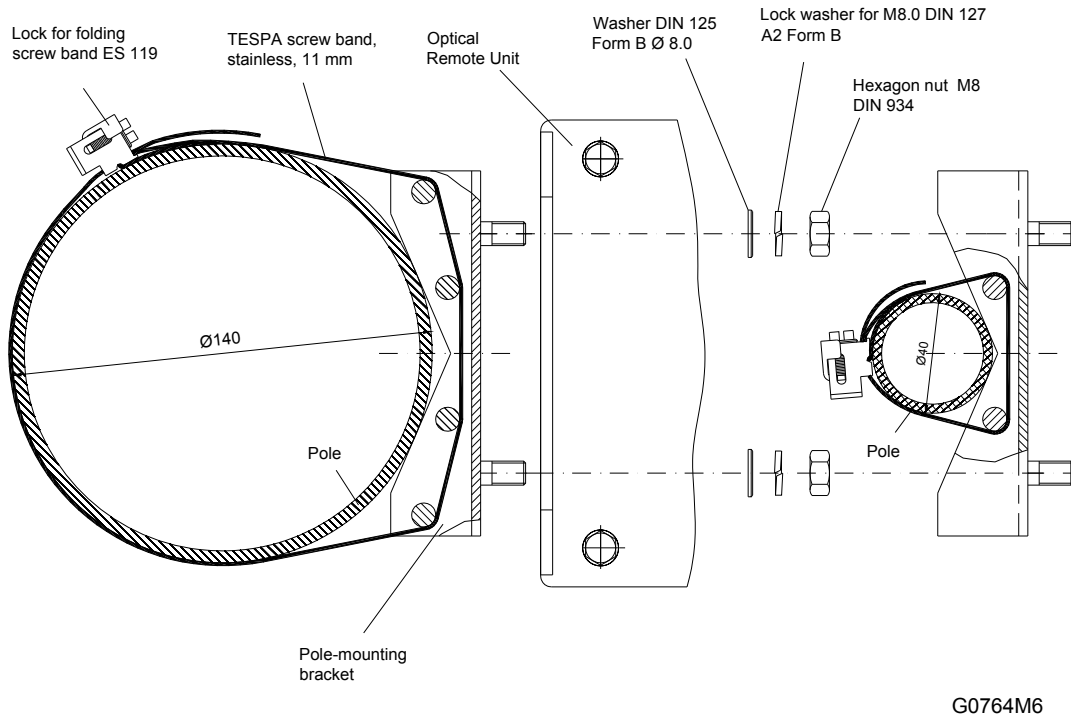
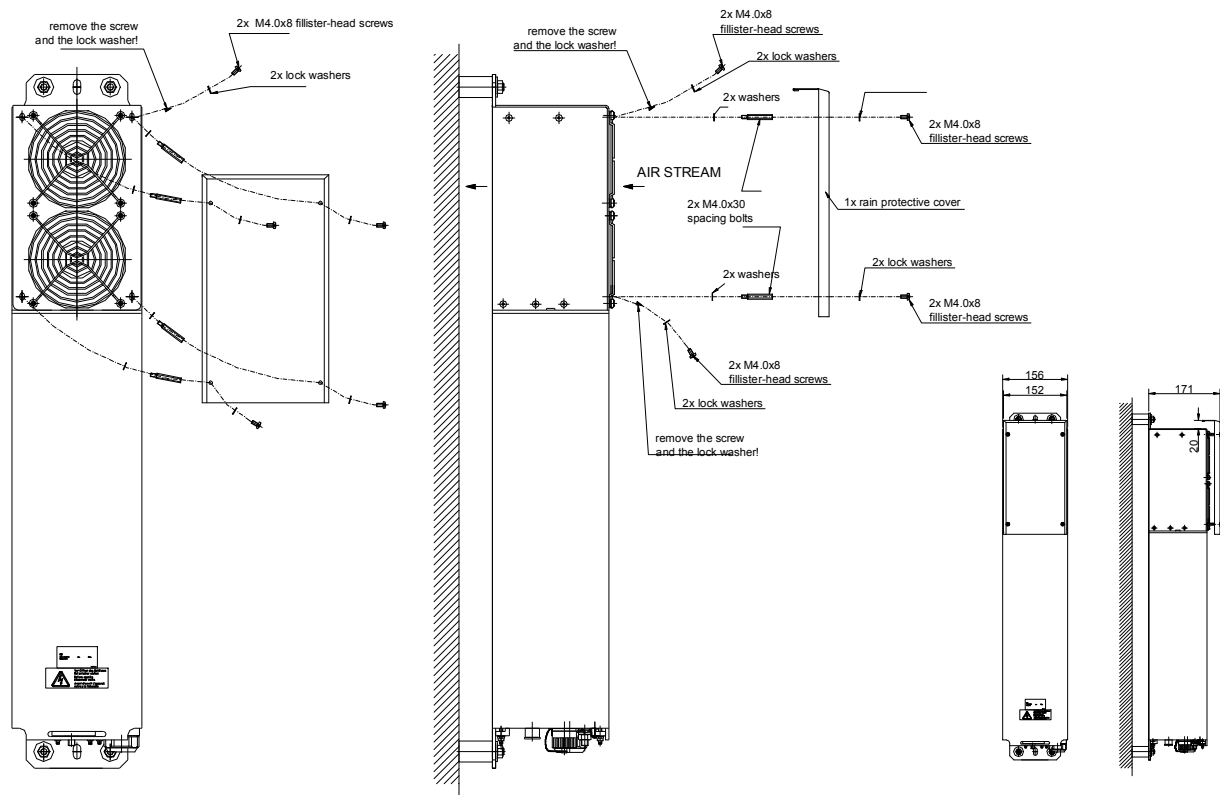

figure 4-3 Pole mounting (metric dimensions)

### 4.1.5. Mounting of Fan Protection

Since the fan protection is required for the outdoor usage of a stand-alone Remote Unit, the mounting of this optional equipment is also described in this manual.

- To install the protective cover of the fan protection kit, first unscrew the four screws with the respective lock washers from the cover of the air inlet of the Remote Unit, and instead, screw in the four spacing bolts M4.0x30 with the four lock washers M4.0 DIN125 that are part of the fan protection kit.
- Place the protective cover into the right position by fitting its four bore holes over the spacing bolts and fasten it using the original lock washers and screws of the Remote Unit. (These lock washers and screws are also part of the fan protection kit and can be used as spare parts in case of loss.)



G0496MF

figure 4-4 Mounting procedure for fan protection, (metric dimensions)

## 4.2. Electrical Installation

### 4.2.1. Health and Safety for Electrical Installation

Read and observe chapter 1.2 *Health and Safety*.



**Danger: Electrical hazard. Danger of death or fatal injury from electrical current. Obey all general and regional installation and safety regulations relating to work on high voltage installations, as well as regulations covering correct use of tools and personal protective equipment.**

### 4.2.2. Property Damage Warnings for Electrical Installation

1. **Attention:** It is compulsory to ground (earth) the unit before connecting the power supply. Grounding bolts are provided on the cabinet to connect the ground-bonding cable.
2. **Attention:** If the mains connector of the Remote Unit is not easily accessible, a disconnect device in the mains power circuit must be provided within easy reach.
3. **Attention:** A connection of the mains supply to a power socket requires the power socket to be nearby the Remote Unit.
4. **Attention:** Before connecting or disconnecting the mains connector at the Remote Unit, ensure that mains power supply is disconnected.
5. **Attention:** Make sure that an appropriate circuit breaker acting as a disconnect device (as required by IEC/EN60950-1) and an overcurrent limiting device are connected between mains power and the Remote Unit.
6. **Attention:** Incorrectly wired connections can destroy electrical and electronic components.
7. **Notice:** Although the Remote Unit is internally protected against overvoltage, it is strongly recommended to ground (earth) the antenna cables close to the antenna connectors of the Remote Unit for protection against atmospheric discharge. In areas with strong lightning, it is strongly recommended to install additional lightning protection.
8. **Notice:** To avoid corrosion at the connectors caused by electrochemical processes, the material of the cable connectors must not cause a higher potential difference than 0.6 V (see electrochemical contact series).
9. **Notice:** Use an appropriate torque wrench for the coupling torques:
  - for N-type connectors (2 N-m / 20 in lb) with 13/16 in opening, e. g. item no. 244379 available from the CommScope e-catalog
  - for 7/16 DIN-type (25 N-m / 19 ft lb) with 1 ¼ in opening, e. g. item no. 244377 available from the CommScope e-catalogDo NOT use your hands or any other tool (e.g. a pair of pliers). This might cause damage to the connector and lead to a malfunction of the Remote Unit.



10. **Notice:** For unstabilized electric networks, which frequently generate spikes, the use of a voltage limiting device is advised.

11. **Notice:** The unit complies with Overvoltage Category II. It also complies with the surge requirement according to EN 61000-4-5 (fine protection); however, installation of an additional medium (via local supply connection) and/or coarse protection (external surge protection) is recommended depending on the individual application in order to avoid damage caused by overcurrent.

For Canada and US, components used to reduce the Overvoltage Category shall comply with the requirements of IEC 61643-series. As an alternative, components used to reduce the Overvoltage Category may comply with ANSI/IEEE C62.11, CSA Certification Notice No. 516, CSA C22.2 No. 1, or UL 1449. Suitability of the component for the application shall be determined for the intended installation.

12. **Notice:** Observe the labels on the front panels before connecting or disconnecting any cables.

### 4.2.3. Connections

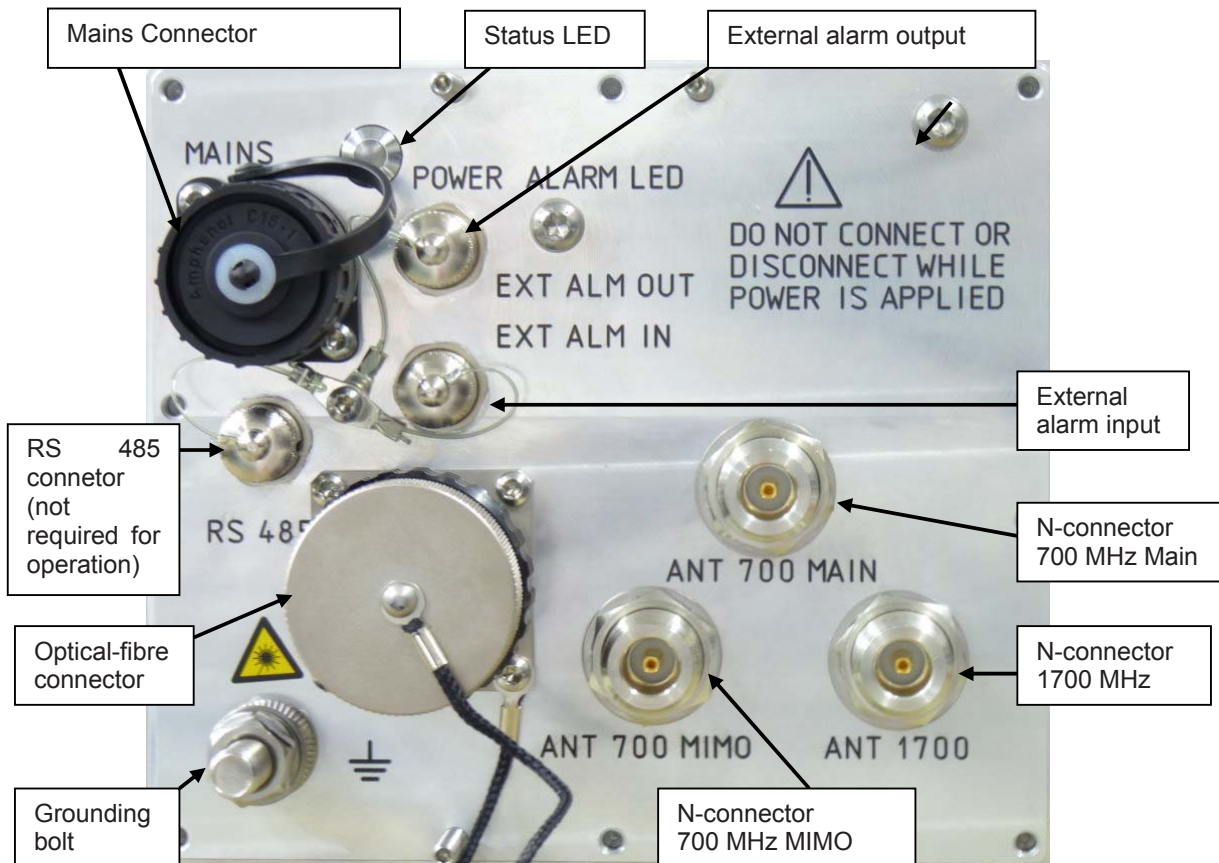

figure 4-5 Connector flange of ION-M7P/7P/17P



#### 4.2.4. Grounding (Earthing)

Grounding must be carried out. Connect an earth-bonding cable to the grounding connection provided at the outside of the Remote Unit (see section 4.2.3 *Connections*). Do not use the grounding connection to connect external devices.

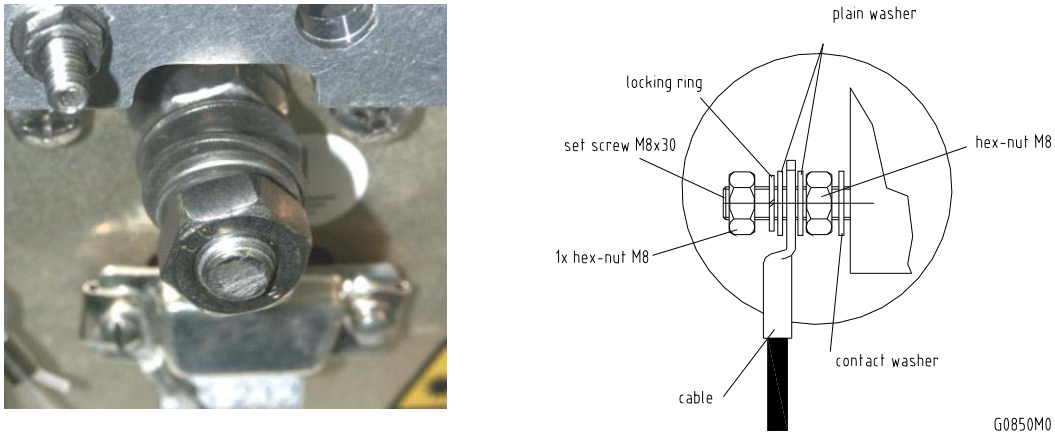

figure 4-6 Grounding bolt with loosened hex nut (left) and schematic view (right)

After loosening the hex nut, connect the earth-bonding cable between the two washers as illustrated in the above. Then, fasten all parts again with the hex nut.

**Note:** Ground of a second unit (for example RU + EU) has to be connected to the same equipotential bonding terminal as the Remote Unit. Use bonding cables of the same length, as short as possible and with a large wire cross section. Follow local electrical code practices.

### 4.2.5. Connection of the Antenna Cables

The Remote Unit has N-type antenna connectors. Please refer to section 4.2.3 *Connections* for its location. Refer to the corresponding documentation of the connector manufacturer for mounting the cable connectors.

The bending radius of the antenna cables must remain within the given specifications.

Choose the type of cable best suited for the antenna. Consider that a cable with higher loss is less expensive but impairs performance.

**Notice:** Use an appropriate torque wrench for the coupling torques:

- for N-type connectors (2 N-m / 20 in lb) with 13/16 in opening, e. g. item no. 244379 available from the *CommScope e-catalog*
- for 7/16 DIN-type (25 N-m / 19 ft lb) with 1 ¼ in opening, e. g. item no. 244377 available from the *CommScope e-catalog*

Do NOT use your hands or any other tool (e.g. a pair of pliers)! This might cause damage to the connector and lead to a malfunction of the RU.



figure 4-7 Torque wrench for tightening

**Attention:** To minimize passive inter-modulation (PIM) distortion, attention has to be paid to the physical condition of the connector junctions:

- Do not use connectors that show signs of corrosion on the metal surface.
- Prevent the ingress of water or dirt into the connector.
- Use protective caps for the connectors when not mounted.
- Before mounting clean the connectors with dry compressed air.
- Before mounting clean the mating surfaces of the connector with a lint-free alcohol-drenched cloth on a wooden or non-metallic item.
- Attach and torque the connectors properly.
- Avoid metallic abrasion when mounting the connectors by only screwing the connecting nut, but not turning the whole connector.
- Use a torque wrench to fasten the connector, see above.
- Clean the protective caps before mounting for antenna cable replacement.

### 4.2.6. Cleaning Procedure for RF Cable Connectors

1. What is needed for the cleaning?
  - a. Isopropyl alcohol
  - b. Compressed air
  - c. Lint-free wipe
  - d. Cotton buds



2. Remove protective cap from the RF connector.

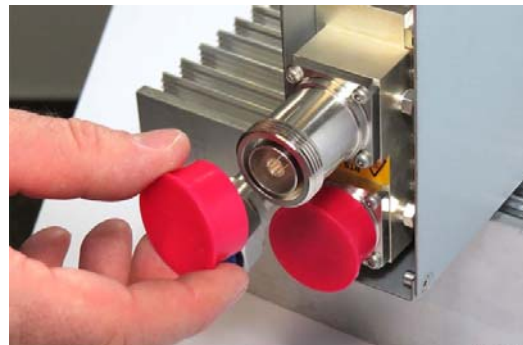

3. Remove metal chips and small particles from the mating and inner surfaces of the connector using compressed air.

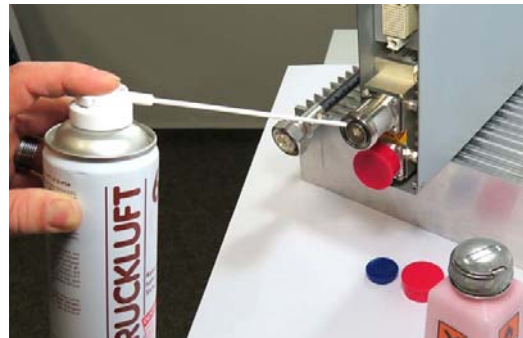

4. Clean the connector winding with lint-free wipe drenched with isopropyl alcohol.



5. Clean the lip of the inner ring with lint-free wipe drenched with isopropyl alcohol.



6. Clean the inside surface of the inner ring with lint-free wipe drenched with isopropyl alcohol.



7. Clean the inside of the center conductor spring tines with a cotton bud drenched with isopropyl alcohol.

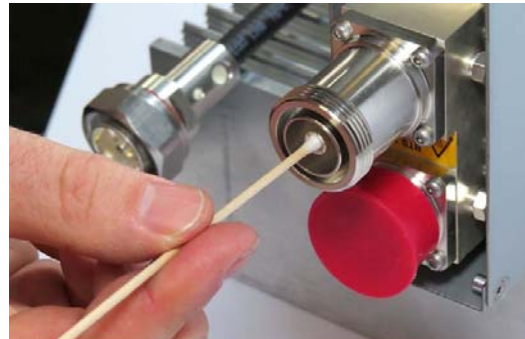

8. Clean in the similar way the connector of the connected cable. Remove protective caps from the unit connector first.

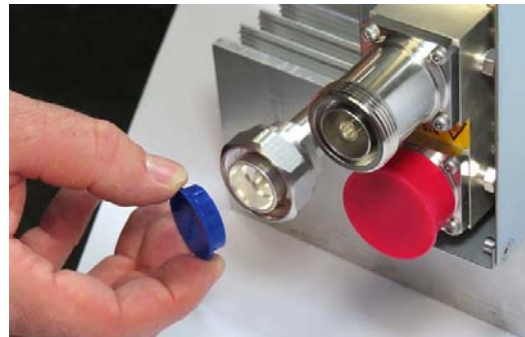

9. Remove metal chips and small particles from the mating and inner surfaces of the connector using compressed air.



10. Continue with the winding area using lint-free wipe drenched with isopropyl alcohol.



11. Continue with the inside mating surface of the inner ring.



12. Clean the outside surface of the center pin.

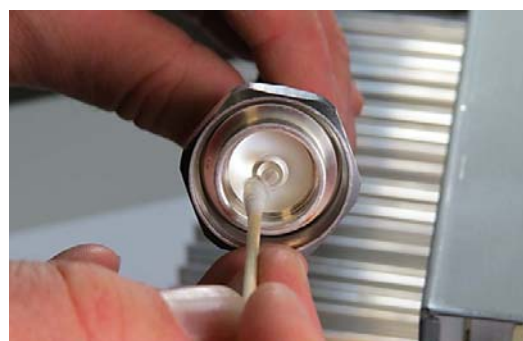



### 4.2.7. Antenna Cable Connector Assembly

The figures in this chapter illustrate the cleaning procedure and do not show the actual RU.

1. What is needed for the connector assembly?
  - a. Torque wrench.
  - b. (Adjustable) counter wrench



2. Join the connectors and turn the coupling nut until the thread grips.



3. Push in the connector until it clicks.



4. Fasten the coupling nut hand-tight. Do not turn the connector but the coupling nut only.



5. Retain the cable connector with the counter wrench and fasten the coupling nut with the torque wrench until the torque is applied (torque wrench clicks).

For angled antenna connectors use your hand to retain the cable connector and fasten the coupling nut with the torque wrench. Make sure only the coupling nut is turned, not the cable connector.

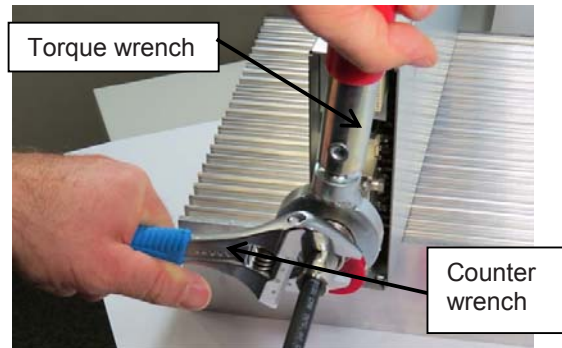

#### 4.2.8. Optical-Fiber-Cable Connection - Rules

##### Main optical system parameters:

Fiber:

- Single mode fiber, type is E9/125  $\mu\text{m}$
- Attenuation:  $<0.36 \text{ dB / km @ } 1310 \text{ nm}$  /  $<0.26 \text{ dB / km @ } 1550 \text{ nm}$
- Dispersion:  $<3.5 \text{ ps / nm km @ } 1310 \text{ nm}$  /  $<18.0 \text{ ps / nm km @ } 1550 \text{ nm}$
- Fibre-cable connectors E2000 APC  $8^\circ$

ION-M system:

- The pigtails for the connection between Master Unit and Remote Unit must have a sufficient length. Protection for the optical fibers must be provided where the fibers feed into the units.
- The system attenuation of the optical fibers, including the connectors, must not exceed 10 dB.

System attenuation and attenuation of optical components must be determined. This can be achieved by measuring attenuation and reflection with an appropriate measuring instrument. For pigtails, a total value of  $<0.4 \text{ dB}$  (measured to a reference plug) can be assumed due to the dead zone of the reflectometer. These measurements must be made with a sufficient length of optical fiber, at the input and output of the device which has to be measured.

**Fiber-System Installation:**

Fiber-cable connectors have to be of the same type (E2000 APC 8°) as the connectors used for the unit. The fiber-optic cables are connected to the optical transceiver.

**Note:** **Angled connectors are not compatible with straight optical connectors; non-compatibility of connectors will result in permanent damage to both connectors.**

Before connecting the fiber cables, follow the procedure below to ensure optimized performance. It is important for these procedures to be carried out with care:

- Remove fiber-optic protective caps.
- Do not bend the fiber-optic cable in a tight radius (<4 cm) as this may cause cable damage and interrupt transmission.
- Using high-grade alcohol and lint-free cotton cleaning swabs, clean the end of the fiber-optic cable that will be inserted in the optical connectors on the donor interface box. Use a fiber end-face inspection tool to scan both, the class fiber and its surrounding area.
- Check for dirt on the cladding, chips/pits, dirt on the ferrule, and scratches.
- Connect the fiber-optic cables by inserting the cable end into the laser receptacle and aligning the key (on the cable end) with the keyed slot.
- Do not use any index-matching gels or fluids of any kind in these connectors. Gels are intended for laboratory use and attract dirt in the field.

**Note:** **Care should be taken when connecting and disconnecting fiber-optic cables - use the connector housing to plug or unplug a fiber. Scratches and dust significantly affect system performance and may permanently damage the connector. Always use protective caps on fiber-optic connectors not in use.**

**Cleaning Procedure for Fiber-Optical Components:**

Any impurity in the fiber connection results in additional optical transmission loss which could cause whole system failure. It is thus recommended that every fiber connector be inspected and cleaned prior to mating.



When you clean fiber components, always complete the following steps carefully:

1. Turn off the ION system (laser sources) before you inspect fiber connectors.



**Caution:** Laser radiation. Risk of eye injury in operation. Do not stare into the beam; do not view it directly or with optical instruments.

1. Check the connectors or adapters with a fiberscope before cleaning.
2. If the connector is dirty, clean it with a lint-free wipe (dry cleaning).
3. Inspect the connector.
4. If the connector is still dirty, repeat the dry cleaning technique.
5. Inspect the connector.
6. If the connector is still dirty, clean it with 99% isopropyl alcohol (wet cleaning) followed immediately with a dry clean in order to ensure no residue is left on the endface.
7. Repeat steps 5 through 7 until endface is clean.

Note: For a more detailed description, please refer to:

[http://www.cisco.com/en/US/tech/tk482/tk876/technologies\\_white\\_paper09186a0080254eba.shtml](http://www.cisco.com/en/US/tech/tk482/tk876/technologies_white_paper09186a0080254eba.shtml)

#### 4.2.9. Protective Plug

##### Connection:

A protective plug is provided for the connection of the fibre-optic cables.

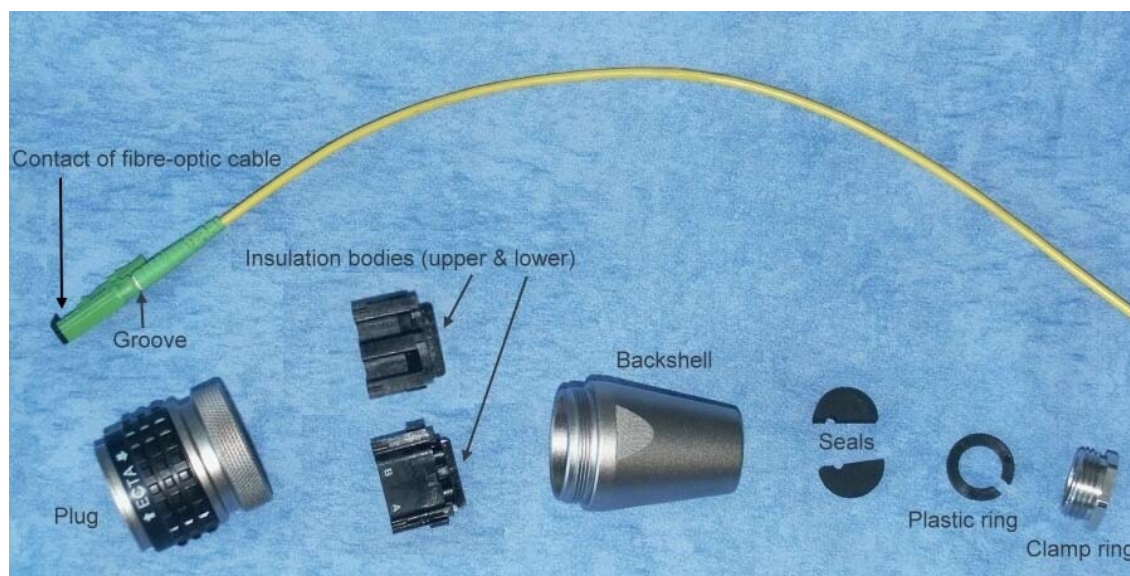



figure 4-8 Protective-plug assembly

**Note:** Only high-quality connectors must be used for this type of plug. Qualified brands are Diamond or Huber & Suhner.

For plug assembly, observe the following instruction:

1. Pass one or two contacts through the backshell and the clamp ring.



2. Place the contact(s) on the lower insulation body by pushing the groove of the contact into the cavity. If there is only one contact, cavity A **must** be used. \*
3. Then, mount the upper insulation body on the lower insulation body. \*\*



Cavity B

Cavity A

Upper insulation body

4. Bring the insulator into the plug. The narrow groove of the insulator must be fitted into the stamp of the plug.

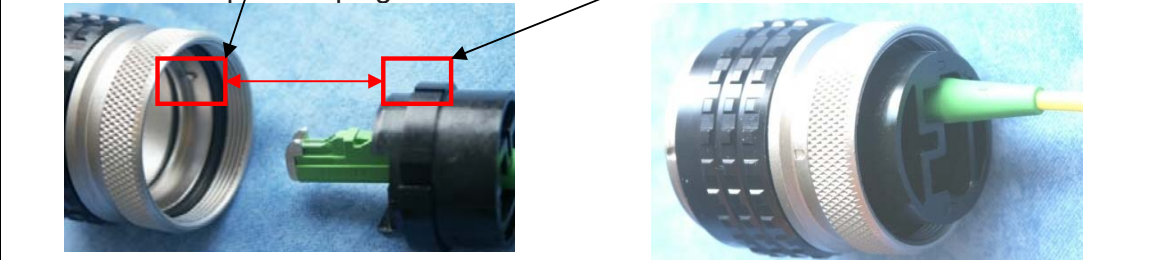

- \* To release the contact for disassembling, push the inner snap to the side and pull the contact out.
- \*\* To release upper and lower insulation bodies for disassembling, use a small screwdriver and carefully open the snap-connections at the left and the right side of the insulator without damaging them.

5. Fasten the insulator by screwing the backshell tight onto it. Use a spanner with opening 32 to screw the backshell tight (no gap).
6. Place the appropriate seal parts (with one groove for one contact or two grooves for two contacts) over the cable(s) and push them into the backshell.

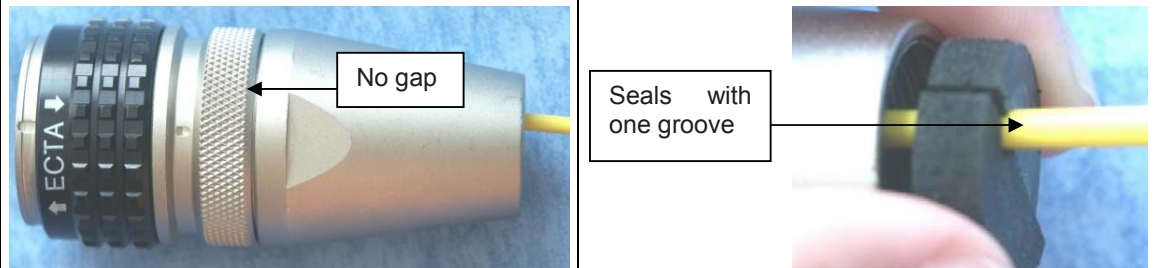

No gap

Seals with one groove

7. Bring the plastic ring over the cable(s), push it into the backshell and compress the seals and plastic ring by screwing the clamp ring tight (no gap) using a spanner with opening 20. \*\*\*

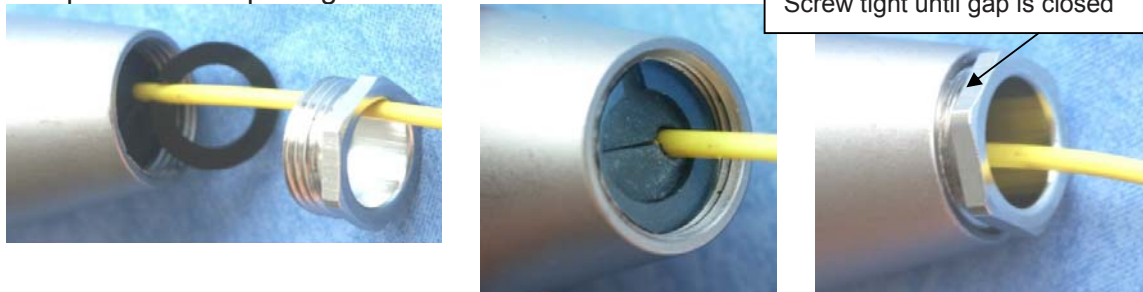

8. Connect the plug to the optical-fibre connector of the Remote Unit, again by fitting a stamp on the plug into the groove of the connector.

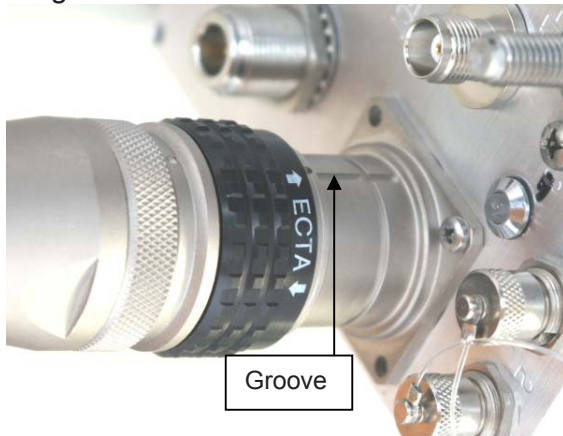

9. To lock the connector, push the black locking ring forward.\*\*\*\*

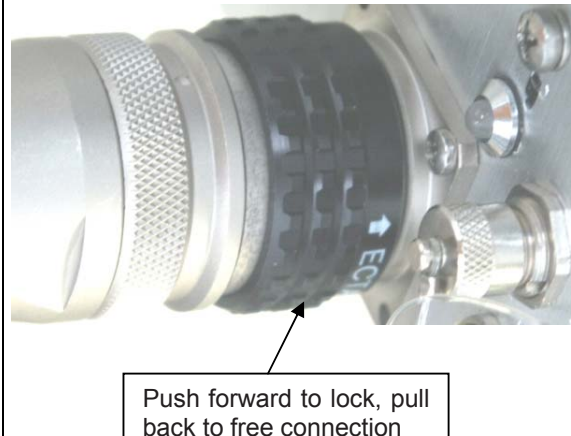

\*\*\* For disassembling, release the clamping ring and remove the seals and the plastic ring first.

\*\*\*\* Locking mechanism: The system of locking the plug is based on a “push-pull” mechanism. The locking ring has to be pushed forward to lock the connector and pulled back to free the connection.

#### 4.2.10. Protective-Tube Kit

As additional protection for the optical fibres, this connector type can be supplemented by a special tube kit. To fasten the tube correctly, first unscrew the clamp ring (if already installed) of the original plug kit.

Then, proceed according to the following instruction:

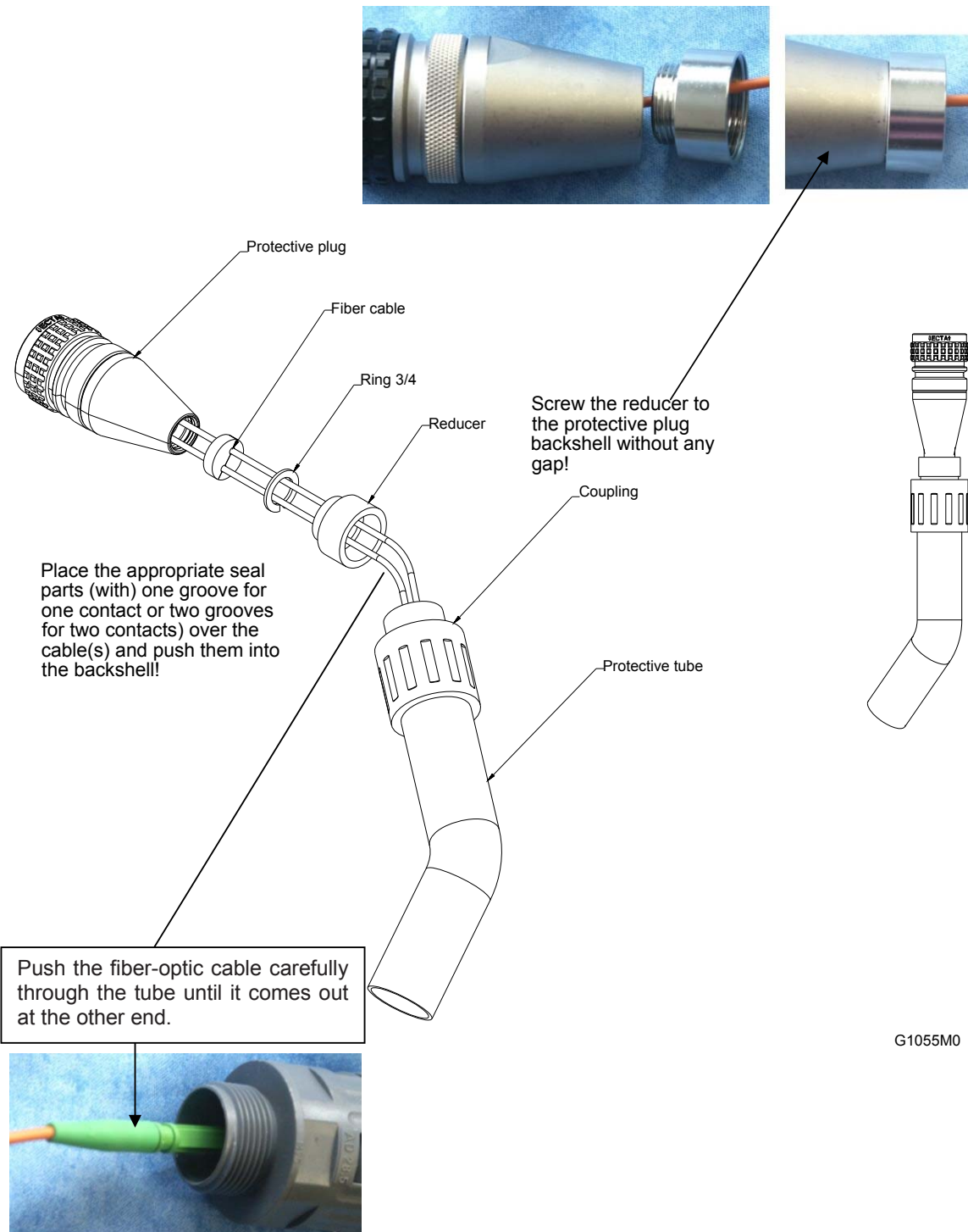

figure 4-9 Tube-kit installation



### 4.2.11. External-Alarm Inputs and Outputs

There are four alarm inputs and four alarm outputs. Each alarm output can be assigned individually to any alarm at the Remote Unit. Settings need to be made via the ION-M Master Controller. For details please refer to the corresponding chapter in the User's Manual of the ION-M Master Controller.

**Note:** The manufacturer / supplier of this system assumes no liability for damage caused by equipment connected to external outputs or by effects from such equipment.

As accessory equipment the alarm kit is available to connect external devices to the external alarm inputs and outputs. For the exact ID No., please refer to section 7.3 Spare Parts. Subminiature circular connectors series 712 with five and seven contacts, which are contained in the alarm kit, can be ordered directly from the Binder Connector Group, the manufacturer, or indirectly from CommScope.

For the location of the external-alarm inputs and outputs see figure "Connector Flange".

#### Optocoupler-Alarm Inputs

With the external alarm inputs it is possible to monitor the status of connected devices, e.g. a UPS, via software. All alarm inputs are normally high (5 V) without connection. The polarity (high/ low) can be set via the software at the Master Unit (for details please see corresponding software manual).

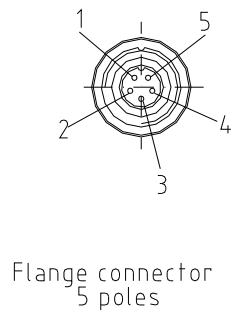

Pin 1= Alarm IN1  
Pin 2= Alarm IN2  
Pin 3= Alarm IN3  
Pin 4= Alarm IN4  
Pin 5= Alarm GND

figure 4-10 Flange connector, 5 poles

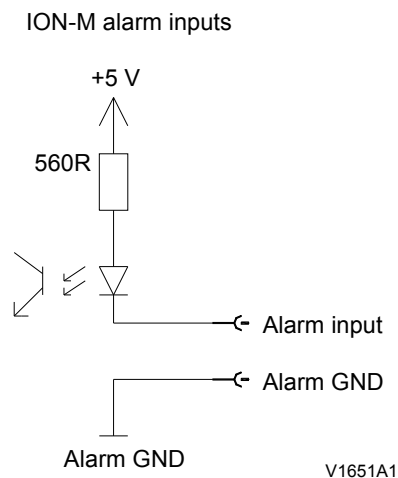

figure 4-11 Alarm inputs (optocoupler)

#### Alarm Inputs:

(decoupled via optocoupler)

Input control/alarm signal/switch contact dimensioning:

$U_{MAX} = 5 \text{ VDC}$   
(from Alarm Card input out)

$I_{MAX} = 5 \text{ mA}$   
(from Alarm Card input out)

$R_{(ON)MAX} = 1 \text{ k}\Omega$   
(of the external switch)

$|\Phi_{GND} - \Phi_{IN \text{ GND}}| \leq 60 \text{ V}$

**Alarm Outputs and +28V Output**

figure 4-12 Alarm outputs (optocoupler)

Flange connector  
7 poles

Pin 1= OUT1  
 Pin 2= OUT2  
 Pin 3= OUT3  
 Pin 4= OUT4  
 Pin 5= Alarm GND  
 Pin 6= GND  
 Pin 7= +28 V

figure 4-13 Flange connector, 7 poles

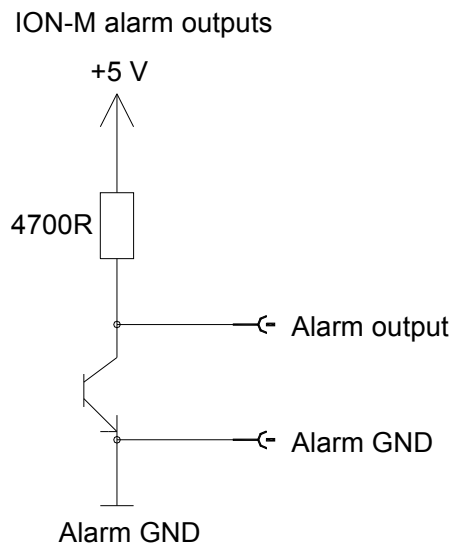
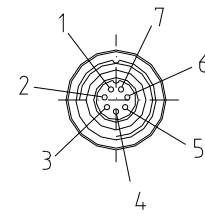
The alarm outputs (pins 1 to 4: open collector output 5 V / 1 mA; see figure 4-13) are normally low. In case of an alarm they are high active (5 V). They can be used to monitor alarms with an external alarm indicator.

The +28 V pin (pin 6&7) is specified to 28 VDC / 0.5 A and is protected by a thermoswitch. In case of exceeding this current between pin 7 and GND, the thermoswitch turns into a high-resistive status. In this case no fuse needs to be replaced. Just wait a few minutes until the thermoswitch reaches the normal operating temperature again.

**Note:** The manufacturer / supplier of this system assumes no liability for damage caused by equipment connected to external outputs or by effects from such equipment.

### 4.2.12. Power Connection

Before connecting electrical power to the RU, the system must be grounded as described in 4.2.4 *Grounding (Earthing)*.

Mains power must be connected at the mains connector of the unit (see section 4.2.3 *Connections*).

The power supply plug is part of the delivery. The correct wiring of the power supply plug is as follows:

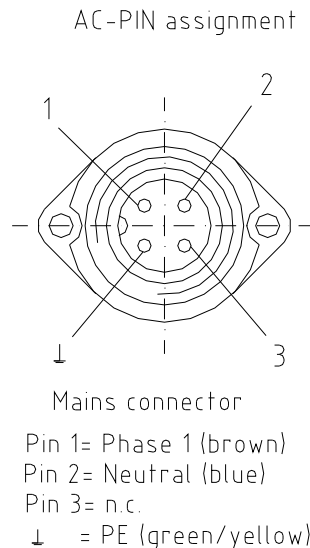

G1038Z0

figure 4-14 AC mains plug

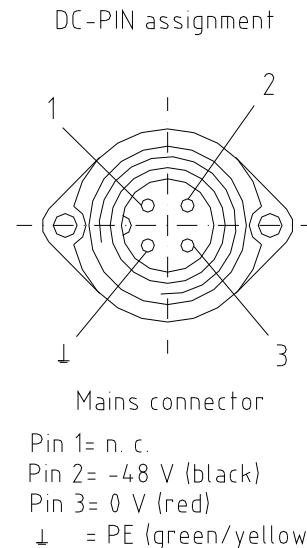

G1038Z0

figure 4-15 DC mains plug

☞ **Note:** For the AC power supply connection, a minimum cross section of 1.5 mm<sup>2</sup> is required, and for the DC power supply connection a minimum cross section of 2.5 mm<sup>2</sup> is required. Each wire must observe the applicable national regulations regarding loop impedance, voltage drop, and methods of installation. Make sure to connect the correct voltage to the unit.

☞ **Note:** Do not connect or disconnect the power cord at the mains connector while power is on. Turn off mains power \* before connecting the power cord at the Remote Unit, then, engage mains again.

\* Mains power must be interruptible with an external delay-actions mains breaker. For the mains breaker, observe the following recommendation:

120 Volt / 20 Amp max. or 240 Volt / 16 Amp, single-phase, 50 / 60 Hz AC service is needed, i.e. the external AC breaker should be 20 Amps max. for 120-Volt service or 13 to 16 Amps for 240-Volt service. Always make sure that your local requirements are kept.

For the DC power supply, observe the local regulations of the DC service provider.

### 4.2.13. Commissioning Flowchart

## Commissioning an ION-M Remote Unit

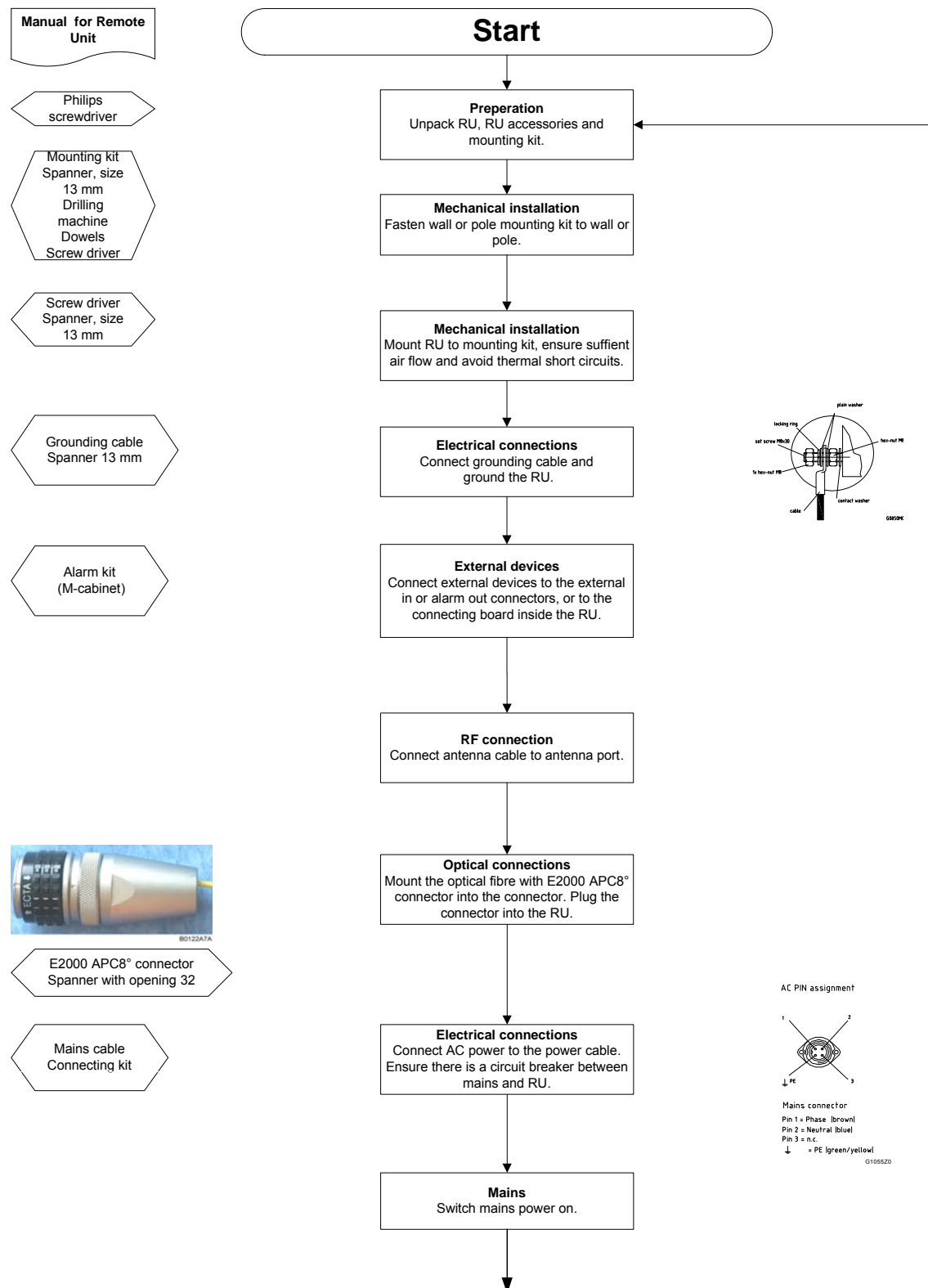



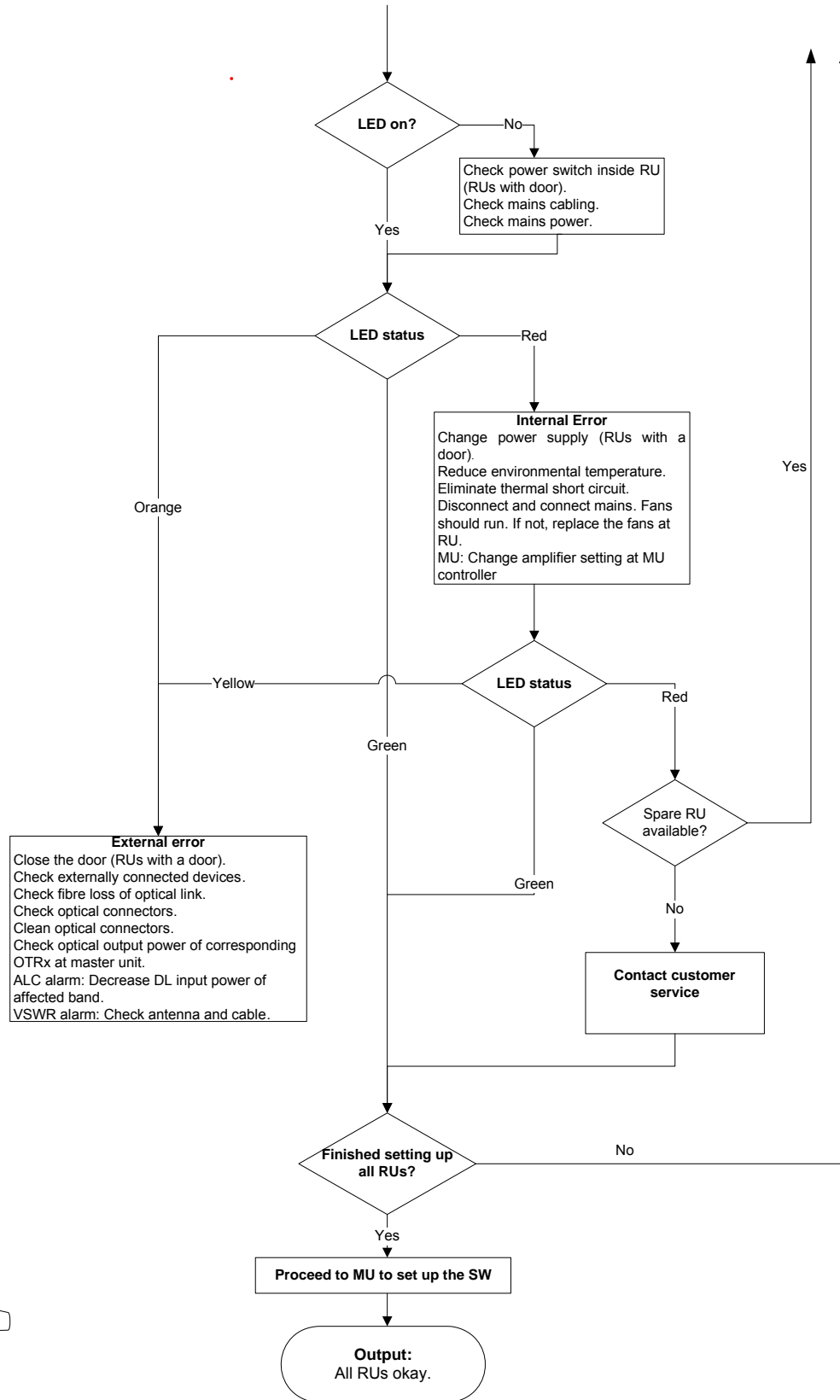

## 5. Alarms and Troubleshooting

All alarms occurring can be checked via software at the Master Unit to where a message is transmitted when the software acknowledges a valid alarm.

A new alarm message will not be repeated if the reason for the alarm is cleared or if the alarm continues.

A new alarm message will be generated if the alarm is interrupted for at least five seconds after acknowledgement.

Refer to the corresponding software documentation of the Master Unit for details.

For local supervision, a status LED on the connector flange of the unit (position see section 4.2.3) gives an indication of possible reasons for alarms. This table shows possible on-site measures that could be checked before referring to the Master Unit alarm list.

<b>Status LED Indication</b>	<b>Alarms</b>	<b>Possible on-site measures</b>
Green	No alarm → Status ok	
Orange	Door alarm (RUs/EUs with door)	Close the door.
	<i>Alarms not directly related to RU/EU:</i>	
	External alarms (RU only)	Check externally connected devices.
	Optical alarm Rx (RU only)	Check fibre loss of optical link. Check optical connectors. Clean optical connectors. <i>(MU: Check optical output power of corresponding OTRx at Master Unit).</i>
	ALC alarm	<i>(MU: Decrease DL input power of affected band).</i>
Red	<i>Alarms directly related to RU/EU:</i>	
	Power 28 V	Change power supply (RUs with door). Replace the affected Remote Unit.
	Temperature	Reduce environmental temperature. Eliminate thermal short circuit.
	Fan (RUs/EUs with fan)	Disconnect and connect mains. Fans should run. If not, replace the fans at RU.
	I <sup>2</sup> C	Disconnect and connect mains.
	Optical alarm Tx	Exchange RU/EU.
	Amplifier “Power Down”	<i>(MU: Change amplifier setting at MU controller).</i>
Status LED off	Mains	Check power switch inside of RU/EU (RUs/EUs with door). Check mains cabling. Check mains power.

table 5-1 Status LED alarms

The status of the RU/EU can be checked via the Master Unit (for details please refer to the software manual of the Master Controller).

Explicit troubleshooting is also available in the MU software (software manual or WEB Interface).

The connection of the external alarms inputs and outputs provided is described in chapter 4.2.11.

## 6. Maintenance

### 6.1. General

Read and observe chapter *1.2 Health and Safety*.

 **Note:** The Remote Unit does not require preventative maintenance measures.

 **Note:** We recommend checking the cleanliness of the unit and in particular of the heat sink / fan(s) at appropriate intervals depending on the degree of dust and dirt at the installation site. If necessary, any dusty or dirty areas / parts should be cleaned at regular intervals, which also depend on the degree of dust and dirt at the installation site.



**Caution:** Rotating fans. Risk of injury in operation. Wear tight-fitting clothes and disconnect mains before connecting or replacing or cleaning the fan unit.





**Caution:** The unit reaches high temperature in operation. Risk of burns by hot surface. Do not touch the unit before it has sufficiently cooled down.

Maintenance of the RU should be performed by replacing only components that are contained in this section. Take care not to unintentionally damage the seals on the modules to maintain warranty. Please keep these guidelines in mind during maintenance:

The spare parts list, consequently, contains only units which can be replaced without tuning or soldering work.

 **Note:** **Ensure the Remote Unit has been disconnected from mains power during maintenance.**

 **Note:** When sending back the unit, use appropriate packaging (see also section *7.2.3 Mechanical Specifications* for details). Use of the original packaging for shipping the unit is strongly recommended.

 **Note:** Defective parts should only be replaced by original parts from the supplier. All service work performed inside the housing is performed at the users own risk.

 **Note:** Label any unlabelled cables before disconnecting them to ensure correct reconnection.

For most maintenance procedures, appropriate tools are required to ensure correct handling. All of these tools can be ordered from the supplier.

 **Note:** All Remote Unit screws have a right-hand thread, and are tightened by turning the screws clockwise and loosened by turning them counter-clockwise with an appropriate tool.

Due to the design of the Remote Unit the only component recommended to be replaced is the fan unit. For replacing any other component, please contact the supplier.

## 6.2. Replacing the Fan Unit

Replacement of the fan unit is not required as a preventative measure. Only if an alarm indicates a malfunctioning of a fan must the unit be exchanged.

**Note:** Please observe that the fan unit can only be replaced as a whole. Do not remove the fans separately.

Read and observe chapter 1.2 *Health and Safety* as well as the instructions in section 6.1 *General* before starting with the replacement.

1. **Switch off the Remote Unit. Make sure mains is disconnected for the following replacement procedure.** Then, proceed as follows:

2. Loosen the four tallow-drop screws M4x8 by which the fan plate is screwed to the cabinet. Remove the four screws and the corresponding washers.



3. Remove the fan unit – by putting slight pressure on the fan plate cover – to a position that allows access to the fan connector and the earth-bonding cable.

4. Unscrew the fan connector and then disconnect the earth-bonding cable.

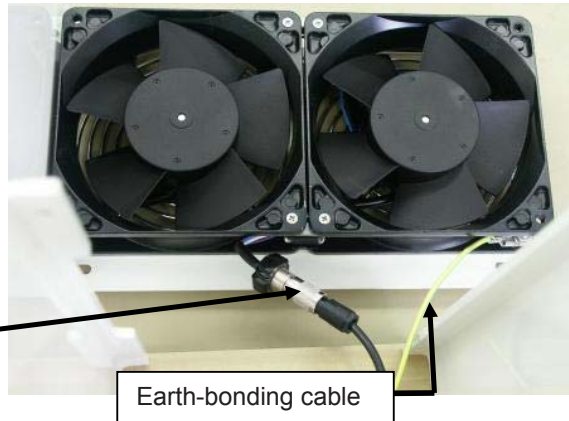

5. To mount the new fan unit, re-connect the earth-bonding cable and the fan connector (see *step 4*). Then, place the fan unit back into its original position and fasten it tight:

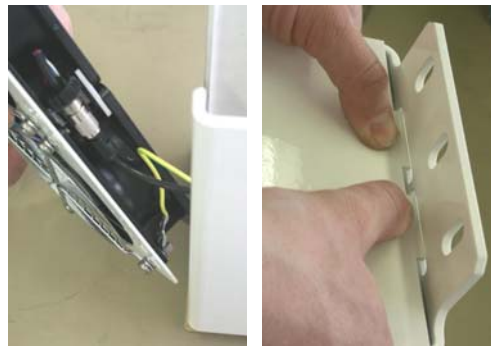

6. Screw the whole fan unit to the cabinet with the four tallow-drop screws M4x8 (see *step 2*). In order not to exceed the specified torque of 3.3 N-m, use an appropriate tool.

### 6.3. Cleaning the Heat Sink

☞ **Note:** Read and observe chapter 1.2 *Health and Safety* as well as the instructions in section 6.1 *General* before starting with the replacement procedure. Then, proceed as follows:

1. Switch off the Remote Unit. For the following procedure ensure that mains has been disconnected before.
2. Remove the fan plate with the fan unit from the Remote Unit as described in section 6.2 *Replacing the Fan Unit*, steps 1 and 2:
3. Use compressed air (max. 5 bar) to blow out the heat sink from back to front:

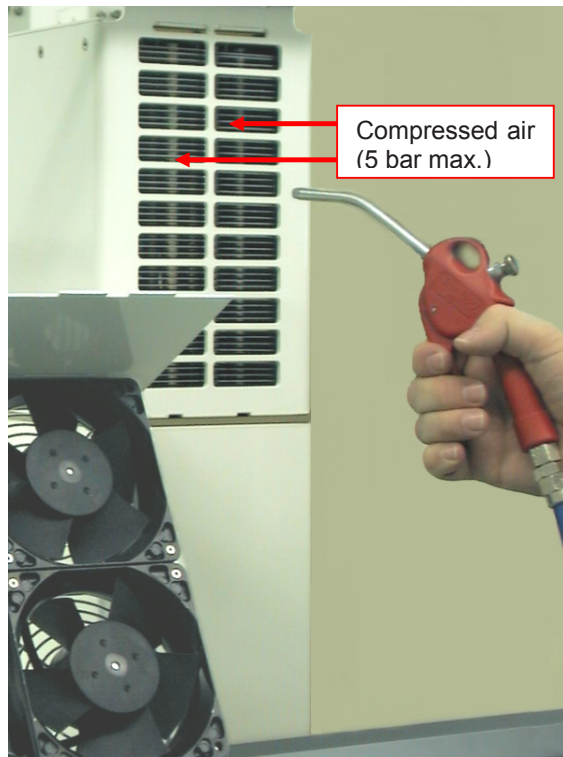
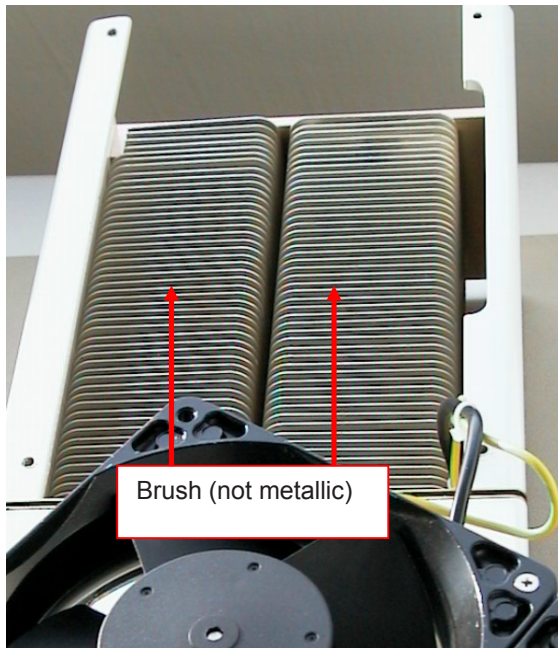

4. In case the dirt cannot be blown out completely and parts of it stick to the ribs of the heat sink, clean the parts concerned carefully from the front using e.g. a brush. Take care that the material is not scratched or damaged.
5. After cleaning the heat sink, mount the fan unit again according to section 6.2 *Replacing the Fan Unit* step 6. Then, switch the Remote Unit back on.

# 7. Appendix

## 7.1. Illustrations

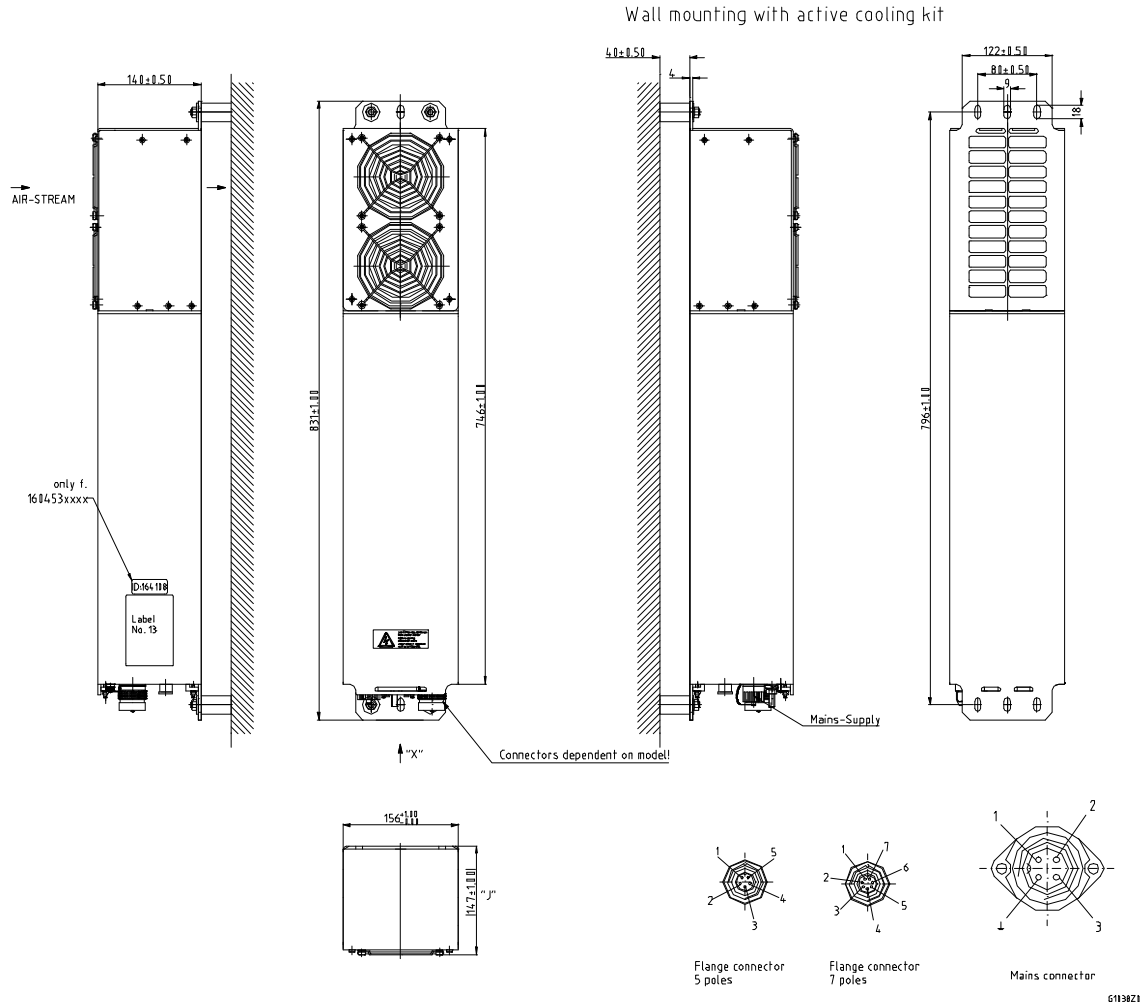

figure 7-1 Cabinet Drawing



## 7.2. Specifications

### 7.2.1. Electrical Specifications

ION-M80/90/19P			
Electrical			
Power supply	Mains power AC	nominal	100 Vac to 240 Vac
		operating	85 Vac to 264 Vac
	Mains power DC	nominal	48 Vdc to 60 Vdc
		operating	36 Vdc to 72 Vdc
Power consumption		720 Watts (max. temperature, fully loaded) 340 Watts (room temperature, idle)	
Optical Link			
Connectors		E2000/APC 8°	
Optical return loss		45 dB minimum	
Fiber type		Single mode E9/125 mm	
Optical link budget		0 dB to 10 dB	

### 7.2.2. Environmental and Safety Specifications

☞ **Note:** For detailed information, please refer to the Environmental and Safety Specifications leaflet of the supplier, related to ETS 300 019 (European Telecommunication Standard).

Environmental		
Operating temperature range		-33° C to +50° C *
Ingress protection	RF part	IP67
	Fan part	IP55

\* No passive cooling possible

**All data is subject to change without notice.**

### 7.2.3. Mechanical Specifications

RU	Height, width, depth *	831 x 156 x 147 mm (32.7 x 6.1 x 5.8 in)
	Weight	20 kg (44 lb)

\* Spacing required: 40 mm (1.58 in) around unit

**All data is subject to change without notice.**



### 7.3. Spare Parts

The following list contains all parts available for the Remote Unit. The configuration of the delivered unit meets the requirements of the customer and can differ depending on the state of the delivery.

Maintenance of the RU should be performed on an FRU (Field Replaceable Unit) basis only. Do not damage the warranty labels on the components, as this voids the warranty.

If any FRU not contained in the following list needs to be replaced, please contact customer service for additional instructions.

#### Spare Parts List of the Remote Unit ION-M7P/7P/17P

Designation:	ID No:
<b>ION-M7P/7P/17P</b>	<b>7694651</b>
Protective Plug E2000	7160013
Protective Cap E 2000	7158914
Fan Protection Kit	7159097
Fan Unit	7158254
Protective Tube Kit	7162182
Installation Guide for MMR Remote Units	7158924
Manuals for Optical Remote Unit ION-M7P/7P/17P	7695621-00

<b>Accessories</b>	
Alarm Kit	7157396
<i>Wall Mounting</i>	
Wall-Mounting Kit	7158078
ISO Trafo Kit 115 V Wall Mounting	7159340
ISO Trafo Kit 230 V Wall Mounting	7158322
Connecting Box Kit Wall Mounting	7159613
Overcoat Housing Kit Wall Mounting	7159625
<i>Pole Mounting</i>	
Pole-Mounting Kit	7157782
ISO Trafo Kit 115 V Pole Mounting	7159623
ISO Trafo Kit 230 V Pole Mounting	7159621
Connecting Box Kit Pole Mounting	7159612
Overcoat Housing Kit Pole Mounting	7159624

The manufacturer reserves the right to replace the spare parts listed above by equivalent substitutes!

☞ **Note:** Only the spare parts listed above are FRUs (= Field Replaceable Units) and can be replaced by the user. For replacement of any other parts, please send the entire Remote Unit back to the manufacturer.

## 8. Index

<b>A</b>		<b>H</b>	
Alarms .....	42	Health and Safety .....	7
External Inputs .....	37		
External Outputs.....	38	<b>I</b>	
Inputs (external) .....	37	Illustrations.....	47
List .....	43	Installation .....	
Outputs .....	37	Electrical .....	23
		Mechanical.....	17
<b>C</b>		<b>M</b>	
CE Declaration of Conformity (DoC).....	11	Maintenance .....	44
Cleaning the Heat Sink .....	46	Mounting .....	
Commissioning .....		Fan Protection.....	22
General.....	17	Pole (Outside).....	20
CommScope.....	11	Wall .....	19
Compliance .....	8		
Connection Rules .....		<b>P</b>	
Optical-Fiber Cables .....	31	Pin Assignment, External Alarms .....	38
Connections .....		Property Damage Warnings .....	7
Antenna .....	26		
Connector Flange.....	24	<b>R</b>	
Power .....	39	Replacement of Fan Unit.....	45
Protective Plug .....	33		
Protective-Tube Kit.....	35	<b>S</b>	
Contact Addresses, Customer Support .....	12	Spare Parts .....	49
		Specifications .....	
<b>D</b>		Electrical .....	48
Declaration of Conformity (DoC).....	11	Environmental and Safety .....	48
		Mechanical.....	48
<b>E</b>		Status LED.....	42
External-Alarm Inputs & Outputs .....	37		
		<b>T</b>	
<b>F</b>		Troubleshooting .....	43
Fiber-Optical Components (Installation, Cleaning).....	32		
Flange Connector (7 poles) .....	38		
<b>G</b>			
Grounding (Earthing).....	25		

COMMSCOPE®

POWERED BY

