

Optical Remote Unit ION™-M7P/7P/19P/19HP (W-cabinet)



User's Manual
MF0143AVA

© Copyright 2011 CommScope, Inc.

All rights reserved.

Andrew Solutions is a trademark of CommScope, Inc.

All information contained in this manual has been revised thoroughly. Yet Andrew Solutions accepts no liability for any omissions or faults.

Andrew Solutions reserves the right to change all hard- and software characteristics without notice.

Names of products mentioned herein are used for identification purposes only and may be trademarks and / or registered trademarks of their respective companies.

No parts of this publication may be reproduced, stored in a retrieval system, transmitted in any form or by any means, electronical, mechanical photocopying, recording or otherwise, without prior written permission of the publisher.

Andrew Wireless Systems GmbH, 03-August-2011

TABLE OF CONTENTS

1. GENERAL	5
1.1. USED ABBREVIATIONS	5
1.2. HEALTH AND SAFETY WARNINGS	7
1.3. ABOUT ANDREW SOLUTIONS	9
1.4. INTERNATIONAL CONTACT ADDRESSES FOR CUSTOMER SUPPORT	10
2. INTRODUCTION	12
2.1. PURPOSE	12
2.2. THE ION-M7P/7P/19P/19HP (INTELLIGENT OPTICAL NETWORK; MMR)	12
2.3. CHANNEL POWER DETECTION (CPD) OPTION	13
3. COMMISSIONING	14
3.1. MECHANICAL INSTALLATION	14
3.1.1. General	14
3.1.2. Wall-Mounting Procedure	16
3.2. ELECTRICAL INSTALLATION	17
3.2.1. General	17
3.2.2. Connections	18
3.2.3. Grounding	19
3.2.4. Connection of the Antenna Cables	19
3.2.5. Connection of AC Mains Power	20
3.2.6. Connection of Optical-Fibre-Cable - Rules	22
3.2.7. Protective Plug	23
3.2.8. Protective-Tube Kit	25
3.2.9. Connection of External-Alarms Cable	27
3.3. COMMISSIONING	28
4. ALARMS	32
4.1. BITE AND ALARMS	32
4.2. HANDLING OF ALARMS	32
4.3. ALARM STATUS	32
4.4. STATUS LED ALARMS	33
4.5. APPLICATION BOARD	34
4.5.1. External-Alarm Inputs and Outputs	34
4.5.2. Layout and Connector Description	36
4.6. TROUBLESHOOTING	38
5. MAINTENANCE	39
5.1. GENERAL	39
5.2. REPLACING THE FAN UNIT	40

5.3.	CLEANING THE HEAT SINK	42
6.	APPENDIX	43
6.1.	ILLUSTRATIONS	43
6.2.	SPECIFICATIONS	44
6.2.1.	Electrical Specifications	44
6.2.2.	Mechanical Specifications	44
6.2.3.	Environmental and Safety Specifications	44
6.3.	SPARE PARTS	45
7.	INDEX	46

FIGURES AND TABLES

figure 3-1	Wall mounting.....	16
figure 3-2	Connector flange of ION-M7P/7P/19P/19HP.....	18
figure 3-3	Caution labels.....	18
figure 3-4	Grounding bolt with loosened hex nut, exemplary.....	19
figure 3-5	Grounding bolt, schematic view.....	19
figure 3-6	Position of AC mains connectors at connector flange.....	20
figure 3-7	AC mains plug, front view.....	21
figure 3-8	Protective-plug assembly.....	23
figure 3-9	Tube-kit installation.....	26
figure 4-1	External-alarm inputs and outputs, location.....	35
figure 4-2	Application board, connectors.....	36
figure 4-3	External-alarm outputs, relay contacts in alarm condition.....	37
figure 4-4	28 V DC connector, location on distribution board.....	38
figure 6-1	Cabinet drawing.....	43
table 1-1	List of international contact addresses.....	11
table 3-1	Specified torques.....	15
table 4-1	Status LED alarms.....	33

1. GENERAL

1.1. USED ABBREVIATIONS

3GPP	3 rd Generation Partnership Project
AC/DC	Alternating current / Direct Current
AIMOS	Andrew Integrated Management and Operating System
ALC	Automatic Level Control
BITE	Built-In Test Equipment
BTS	Base Transceiver Station
CE	"Conformité Européenne" ("European Conformity")
CD	Compact Disk
CPD	Channel Power Detection
DL	Downlink
DoC	Declaration of Conformity
EDGE	Enhanced Data Rates for GSM Evolution
EN	European Norm
EP	Extension Port
ESD	Electrostatic Discharge
ETS	European Telecommunication Standard
EU	Extension Unit
GSM	Global System for Mobile Communication
GND	Ground
GUI	Graphical User Interface
ICP3	Intercept Point 3 rd order
ID No	Identification Number
ION	Intelligent Optical Network
IP	Ingress Protection
ISO	International Organization for Standardization
LED	Light Emitting Diode
LMT	Local Maintenance Terminal
LTE	Long Term Evolution
MIMO	Multiple Input Multiple Output
MS	Mobile Station
MU	Main Unit
NF	Noise Figure
OTRx	Optical Transceiver = SRMU (Subrack Master Unit)
PG	Packing Gland
PIM	Passive Intermodulation
R&TTE	Radio & Telecommunications Terminal Equipment
Rev	Revision
RF	Radio Frequency
RU	Remote Unit
RX	Receiver
SNMP	Simple Network Management Protocol
TS	Technical Specification
TX	Transmitter

UL	Uplink
UMTS	Universal Mobile Telecommunication System
UPS	Uninterruptible Power Supply
VSWR	Voltage Standing Wave Ratio
WCDMA	Wideband Code Division Multiple Access
WDM	Wavelength Division Multiplex

1.2. HEALTH AND SAFETY WARNINGS



1. Only suitably qualified personnel is allowed to work on this unit and only after becoming familiar with all safety notices, installation, operation and maintenance procedures contained in this manual.
2. Read and obey all the warning labels attached to the unit. Make sure that the warning labels are kept in a legible condition and replace any missing or damaged labels.
3. Obey all general and regional installation and safety regulations relating to work on high voltage installations, as well as regulations covering correct use of tools and personal protective equipment.
4. Keep operating instructions within easy reach and make them available to all users.
5. It is the responsibility of the network provider to implement prevention measures to avoid health hazards which may be associated to radiation from the antenna(s) connected to the unit.
6. **Note for a Class A digital device or peripheral:**
This equipment has been tested and found to comply with the limits for a Class A digital device, pursuant to part 15 of the FCC Rules. These limits are designed to provide reasonable protection against harmful interference when the equipment is operated in a commercial environment. This equipment generates, uses, and can radiate radio frequency energy and, if not installed and used in accordance with the instruction manual, may cause harmful interference to radio communications. Operation of this equipment in a residential area is likely to cause harmful interference in which case the user will be required to correct the interference at his own expense.
7. Make sure, access is restricted to qualified personnel.
8. Only licence holders for the respective frequency range are allowed to operate this unit.
9. Corresponding local particularities and regulations must be observed. For national deviations please refer to the respective documents included in the manual CD delivered.
10. Use this equipment only for the purpose specified by the manufacturer. Do not carry out any modifications or fit any spare parts which are not sold or recommended by the manufacturer. This could cause fires, electric shock or other injuries.
11. Due to power dissipation, the repeater may reach a very high temperature. Do not operate this equipment on or close to flammable materials.

12. Before opening the unit, disconnect mains.



13. ESD precautions must be observed! Before commencing maintenance work, use the available grounding system to connect ESD protection measures.

14. This unit complies with European standard EN60950.

15. Make sure the repeater settings are according to the intended use (see also product information of manufacturer) and regulatory requirements are met.

16. Although the repeater is internally protected against overvoltage, it is strongly recommended to earth the antenna cables close to the repeater's antenna connectors for protection against atmospheric discharge.



17. Laser radiation! Do not stare into the beam; do not view it directly or with optical instruments.

1.3. ABOUT ANDREW SOLUTIONS

Andrew Wireless Systems GmbH based in Buchdorf/ Germany, is a leading manufacturer of coverage equipment for mobile radio networks, specializing in high performance, RF and optical repeaters. Our optical distributed networks and RF repeater systems provide coverage for every application: outdoor use, indoor installations, tunnels, subways and many more.

Andrew Wireless Systems GmbH has unparalleled experience in providing RF coverage and capacity solution for wireless networks in both indoor and outdoor environment and belongs to *Andrew Solutions, a CommScope Company*.

Andrew Solutions is the foremost supplier of one-stop, end-to-end radio frequency (RF) solutions. Our products are complete solutions for wireless infrastructure from top-of-the-tower base station antennas to cable systems and cabinets, RF site solutions, signal distribution, and network optimization.

Andrew Solutions has global engineering and manufacturing facilities. In addition, it maintains field engineering offices throughout the world.

We operate a quality management system in compliance with the requirements of ISO 9001. All equipment is manufactured using highly reliable material. In order to ensure constant first-rate quality of the products, comprehensive quality monitoring is conducted at all fabrication stages. Finished products leave the factory only after a thorough final acceptance test, accompanied by a test certificate guaranteeing optimal operation.

☞ **Note:** **Exceptions of and national deviations from this intended use may be possible. To observe corresponding local particularities and regulations, please refer to the respective documents (also in national language) which are included in the manual CD delivered.**

To make the most of this product, we recommend you carefully read the instructions in this manual and commission the system only according to these instructions.

For technical assistance and support, please also contact the local office or *Andrew Solutions* directly at one of the addresses listed in the following chapter.

1.4. INTERNATIONAL CONTACT ADDRESSES FOR CUSTOMER SUPPORT

Americas:

Canada	
Andrew Solutions Canada	
Mail	620 North Greenfield Parkway Garner, NC 27529 U.S.A.
Phone	+1-905-878-3457 (Office) +1-416-721-5058 (Mobile)
Fax	+1-905-878-3297
E-mail	Peter.Masih@commscope.com, Wlsupport.us@commscope.com

United States	
Andrew Solutions, Andrew LLC, A CommScope Company	
Mail	620 North Greenfield Parkway Garner, NC 27529 U.S.A.
Phone	+1-888-297-6433
Fax	+1-919-329-8950
E-mail	Wlsupport.us@commscope.com

Brazil & South America	
CommScope Cabos do Brasil Ltda.	
Mail	Av. Com. Camilo Julio 1256 Zonal Industrial CP 597 Sorocaba SP 18086-000 Brazil
Phone	+ 55-15-9104-7722
Fax	+ 55-15-2102-4001
E-mail	Wlsupport@commscope.com

Mexico, Central America & Caribbean region	
Andrew Corporation Mexico, SA DE CV	
Mail	Av. Insurgentes Sur 688, Piso 6 Col. Del Valle, CP: 03100 Mexico City Mexico
Phone	+52-55-1346-1900 (Office) +52-1-55-5419-5260 (Mobile)
Fax	+52-55-1346-1901
E-mail	Wlsupport@commscope.com

APAC Countries:

China, India and Rest of Asia	
Andrew International Corporation	
Mail	Room 915, 9/F Chevalier Commercial Centre 8 Wang Hoi Rd Kowloon Bay Hong Kong
Phone	+852-3106-6100
Fax	+852-2751-7800
E-mail	Wlsupport.China@commscope.com

Australia & New Zealand	
Andrew Corporation (Australia) Pty Ltd.	
Mail	Unit 1 153 Barry Road Campbellfield VIC 3061 Australia
Phone	+613-9300-7969
Fax	+613-9357-9110
E-mail	Wlsupport.Australia@commscope.com

Europe:

United Kingdom	
	Andrew Solutions UK Ltd
Mail	Unit 15, Ilex Building Mulberry Business Park Fishponds Road Wokingham Berkshire RG41 2GY England
Phone	+44-1189-366-792
Fax	+44-1189-366-773
E-mail	Wlsupport.uk@commscope.com

France	
	CommScope France
Mail	Immeuble Le Lavoisier 4, Place des Vosges 92052 Courbevoie France
Phone	+33-1 82 97 04 00
Fax	+33-1 47 89 45 25
E-mail	Wlsupport@commscope.com

Germany	
	Andrew Wireless Systems GmbH
Mail	Industriering 10 86675 Buchdorf Germany
Phone	+49-9099-69-0
Fax	+49-9099-69-930
E-mail	Wlsupport@commscope.com

Czech Republic	
	Andrew Solutions Czech Republic C-Com, spol. s r.o
Mail	U Moruší 888 53006 Pardubice Czech Republic
Phone	+420-464-6280-80
Fax	+420-464-6280-94
E-mail	Wlsupport@commscope.com

Austria	
	Andrew Wireless Systems (Austria) GmbH
Mail	Weglgasse 10 2320 Wien-Schwechat Austria
Phone	+43-1706-39-99-10
Fax	+43-1706-39-99-9
E-mail	Wlsupport.austria@commscope.com

Switzerland	
	Andrew Wireless Systems AG
Mail	Tiergartenweg 1 CH-4710 Balsthal Switzerland
Phone	+41-62-386-1260
Fax	+41-62-386-1261
E-mail	Wlsupport.ch@commscope.com

Italy	
	Commscope Italy S.r.l., Faenza, Italy
Mail	Via Mengolina, 20 48018 Faenza (RA) Italy
Phone	+39-0546-697111
Fax	+39-0546-682768
E-mail	Wlsupport.italia@commscope.com

Spain and Portugal	
	Andrew Solutions España S.A. A Commscope Company
Mail	Avda. de Europa, 4 - 2ª pta. Parque Empresarial La Moraleja 28108 Alcobendas (Madrid) Spain
Phone	+34-91-745-20 40
Fax	+34-91-661-87 02
E-mail	Wlsupport.iberia@commscope.com

table 1-1 List of international contact addresses

2. INTRODUCTION

2.1. PURPOSE

Cellular telephone systems transmit signals in two directions between a base transceiver station (BTS) and mobile stations (MS) within the signal coverage area.

If weak signal transmissions occur within the coverage area because of indoor applications, topological conditions or distance from the transmitter, extension of the transmission range can be achieved by means of an optical distribution system.

Such a system contains an optical Master Unit and several Remote Units. The number of the Remote Units depends on the hardware and software configuration. The Remote Units are connected to the Master Unit with optical links. The optical loss must be less than 10 dB inclusive optical couplers or splitters.

The Master Unit is the connection to the base transceiver stations. The configuration of a Master Unit depends on the number of the Remote Units and the frequency range.

WDM (Wave Division Multiplex) filters are integrated in the optical modules. For the UL, a wavelength within 1540 nm – 1562 nm is used. For the DL, a wavelength of 1310 ±20 nm is used. The maximum output power for the UL and DL is 5.7 mW.

2.2. THE ION-M7P/7P/19P/19HP (INTELLIGENT OPTICAL NETWORK; MMR)

The ION-M7P/7P/19P/19HP is an LTE MIMO, and 1900 MHz CDMA/WCDMA, and GSM multi-operator Remote Unit with various Extension Units. It is used in conjunction with a Master Unit in the ION optical distribution system. This system transports multiple LTE channels, and two 1900 MHz wideband signals simultaneously, providing a cost-effective solution for distributing capacity from one or more base stations.

The ION-M7P/7P/19P/19HP transports signals on the RF layer in a very inexpensive manner. This means that multiple operators and multiple technologies are moved simultaneously from a cluster of base stations to a remote location over the same fiber.

The ION optical distribution system is a cost-effective coverage solution for dense urban areas, tunnels, subway, airports, convention centers, high-rise buildings and other locations where physical structures increase path loss. It has been specifically designed to reduce zoning problems and to provide homogeneous coverage. The compact, mechanical design is specifically architected to mount inside of poles or along side structures in such a way that it has a minimal visual impact.

The ION-M7P/7P/19P/19HP is available in single (SISO) or multi-channel (MIMO) configuration supporting 700 MHz, LTE, and two 1900 MHz bands in parallel. It has been specifically tested and optimized for LTE, OFDM, CDMA, WCDMA, and GSM signals.

The ION is easily set-up and supervised via a graphical user interface (GUI). Remote units can be commissioned through the use of built-in test equipment. An auto-leveling function compensates for the optical link loss making installation easy and quick. The entire system may be monitored remotely via an Andrew OMC. This platform uses SNMP protocol and is compliant to X.733 standard.

Should a sophisticated interface not be required, the master unit can directly be connected to the alarm interface of a base station via its contact relay.

Features:

- Multi-channel, multi-operator support
- Reduced visual impact form factor
- Efficient, high power amplifiers
- Single fiber for MIMO and multiple remotes
- Comprehensive operations and management system for configuration and alarming
- OMC with SNMP according to X.733 standard
- Easy installation and commissioning

2.3. CHANNEL POWER DETECTION (CPD) OPTION

The Channel Power Detection (CPD) is a remote-controlled data acquisition system for monitoring the RF output power of the 700 MHz LTE / PCS 1900 MHz system at the air interface. On the basis of a channel-selective power detector, it filters and evaluates power levels.

3. COMMISSIONING

3.1. MECHANICAL INSTALLATION

3.1.1. General

Read the health and safety warnings in chapter *1.2 Health and Safety Warnings*.

1. Do not install the unit in a way or at a place where the specifications outlined in the *Environmental and Safety Specifications* leaflet of the supplier are not met.
2. It is recommended only to use the mounting hardware delivered by the supplier. If different mounting hardware is used, the specifications for stationary use of the Remote Unit must not be exceeded.

 **Note:** Exceeding the specified load limits may cause the loss of warranty!

3.  The unit is considerably heavy. Make sure that a suitable mounting surface is used. Ensure there is adequate manpower to handle the weight of the system.
4. Due to power dissipation, the Remote Unit may reach a very high temperature. Ensure sufficient airflow for ventilation as specified in the individual mounting procedures.
5. When connecting and mounting the cables (RF, optical, mains, ...) ensure no water can penetrate into the unit through these cables.
6. Also observe all additional rules or restrictions regarding mounting that depend on the type of Remote Unit. For details refer to chapter *7.2.2 Mechanical Specification*. Install the unit vertically with the fan unit at the top. A maximum tilt angle of 25° from a vertical position must be kept, as in the following illustrations:

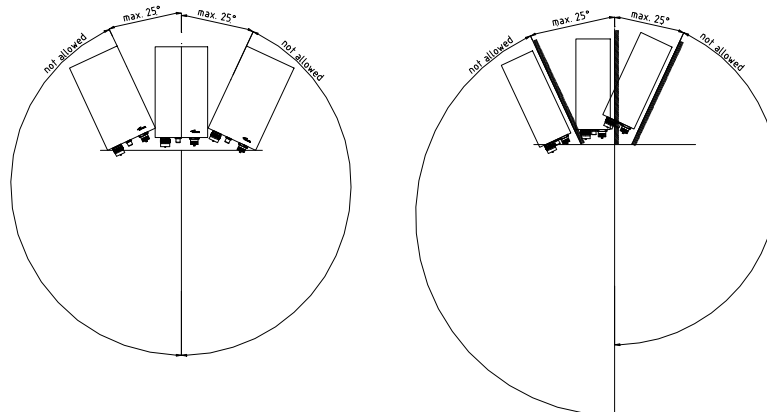

7. A spacing of 40 mm (1.58 inch) around the unit is required.
8. To ensure sufficient airflow when mounting the unit in enclosed spaces, two lid openings (one for the air inlet and the other for the air outlet) have to be provided. Do not block these air inlets and outlets when mounting the Remote Unit. The size of each opening must equal at least 17 x 17 cm (290 cm²). Make sure, too, there is no thermal short circuit between the air inlet and air outlet.

If any different or additional mounting material is used, ensure that the mounting remains as safe as the mounting designed by the manufacturer. Ensure that the static and dynamic strengths are adequate for the environmental conditions of the site. The mounting itself must not vibrate, swing or move in any way that might cause damage to the Remote Unit.

Specified torques have to be observed for certain mounting procedures according to the following table:

Type	Tallow-drop screws	Hex nuts	Spacing bolts		PG (plastic)	PG (aluminium)
<i>Thread</i>	M 4	M 8	M 4	M 8	PG 13.5	PG 29
<i>Specified torques</i>	3.3 Nm	27 Nm	2.3 Nm	27 Nm	3.75 Nm	10 Nm

table 3-1 Specified torques

 **Note:** To avoid damage when mounting the unit, always make sure that the M8 washers (DIN9021 or DIN125 depending on the mounting kit) are placed behind and in front of the mounting drillings of the unit.

The mounting procedures for a stand-alone Remote Unit without optional accessories are described and illustrated in the following sections. For further information regarding special mounting procedures including mounting of accessory equipment, please see separate manual.

3.1.2. Wall-Mounting Procedure

- Check the suitability of the wall-mounting kit and the wall.
- Remove the protective cover from the top of the Remote Unit by pulling it strongly to the front.

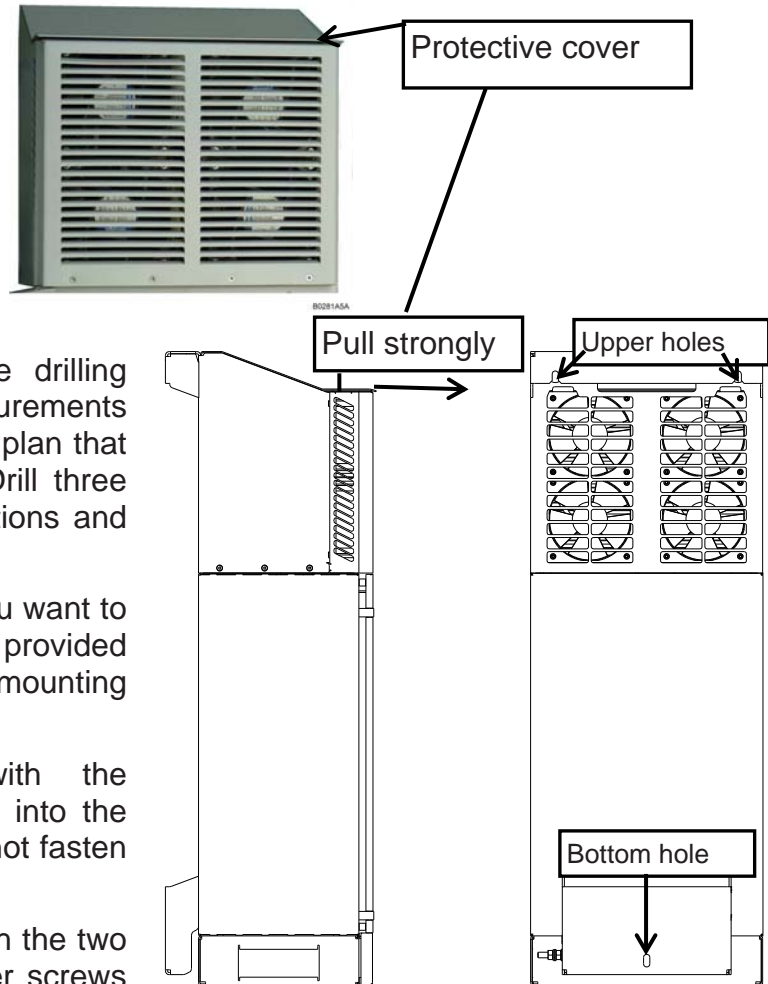

- Mark the position of the drilling holes (for exact measurements refer to the wall mounting plan that is part of the delivery). Drill three holes at the marked positions and insert dowels*.
- Choose the screw type you want to use: two possible sets are provided in the kit; for details see mounting plan.
- Screw two screws with the according washers / nuts into the two upper dowels but do not fasten them.
- Hang the Remote Unit with the two upper holes into the upper screws and, then, fasten them tight using an appropriate tool.

figure 3-1 Wall mounting

* The dowels are not part of the delivery since the suitable type depends on the on-site conditions (material of wall). Therefore, use dowels that are appropriate for the mounting surface.

- Then, put the third screw with the according washers / nuts through the bottom hole of the Remote Unit and screw it into the third dowel using an appropriate tool.
- Put the protective cover back on top of the Remote Unit.
- Ensure that there is free access to the electrical connections as well as to the cabinet. The approved bending radius of the connected cables must not be exceeded.

3.2. ELECTRICAL INSTALLATION

3.2.1. General

Read the health and safety warnings in chapter *1.2 Health and Safety Warnings*.



1. This unit contains dangerous voltages. Loss of life, severe personal injury or property damage can be the result if the instructions contained in this manual are not followed.
2. It is compulsory to ground the unit before connecting power supply. A grounding bolt is provided on the cabinet to connect the ground-bonding cable.
3. Although the Remote Unit is internally protected against overvoltage, it is strongly recommended to earth the antenna cables close to the antenna connectors of the Remote Unit for protection against atmospheric discharge. In areas with strong lightning it is strongly recommended to insert additional lightning protection.
4. If the mains connector of the Remote Unit is not easily accessible, a disconnect device in the mains circuit must be provided within easy reach.
5. Before connecting or disconnecting the mains connector at the Remote Unit, ensure that mains supply is disconnected.
6. Make sure that an appropriate branch circuit breaker and an overcurrent limiting device are connected between mains and Remote Unit.
7. An external circuit breaker is mandatory as disconnect device. This circuit breaker should be readily available for the operator.

For the U.S. and Canada, installation has to be done in accordance with the NEC (National Electronic Code). The external circuit breaker has to be a branch circuit breaker rated 20 A for 110 Vac mains.

8. A field wiring box with conduit must be used for the installation. Use a wire harness rated for AC mains with at least AWG14 size.
9. A connection of mains supply to a power socket requires the power socket to be nearby the Remote Unit.
10. Incorrectly wired connections can destroy electrical and electronic components.
11. To avoid corrosion at the connectors caused by electrochemical processes, the material of the cable connectors must not cause a higher potential difference than 0.6 V (see electrochemical contact series).
12. Use an appropriate torque wrench for the coupling torque (25 N-m / 19 ft lb) of 7-16 DIN connectors with 1-1/4 in opening to tighten the 7/16-type antenna connectors. For example, use torque wrench of item no. 244377 available from the *Andrew e-catalog*. Do NOT use your hands or any other tool (e.g. a pair of pliers)! This might cause damage to the connector and lead to a malfunction of the Remote Unit.

13. For unstabilized electric networks which frequently generate spikes, it is advised to use a voltage limiting device.
14. The unit complies with the surge requirement according to EN 61000-4-5 (fine protection); however, it is recommended to install an additional medium (via local supply connection) and/or coarse protection (external surge protection) depending on the individual application in order to avoid damage caused by overcurrent.
15. Observe the labels on the front panels before connecting or disconnecting any cables!

3.2.2. Connections

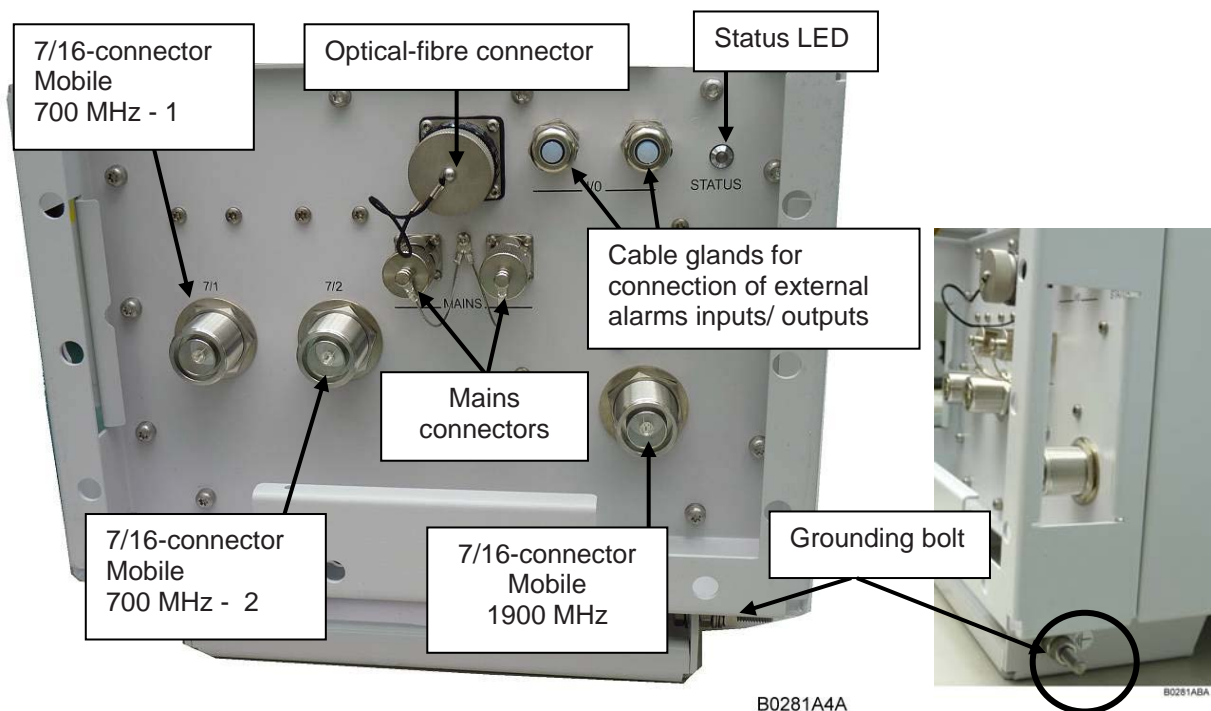

figure 3-2 Connector flange of ION-M7P/7P/19P/19HP

Please observe the following two caution labels attached to the unit cab net:



figure 3-3 Caution labels

3.2.3. Grounding

Grounding must be carried out. Connect an earth-bonding cable to the grounding connection provided at the outside of the Remote Unit (see chapter 3.2.2 *Connections*). Do not use the grounding connection to connect external devices.



B0281ADA

figure 3-4 Grounding bolt with loosened hex nut, exemplary

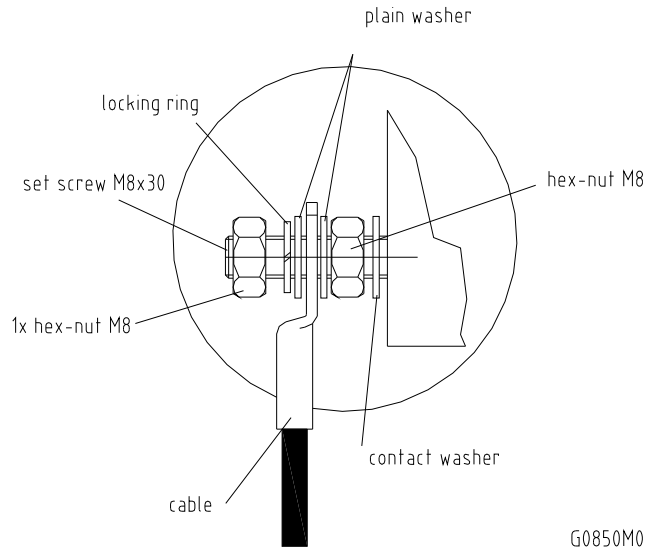

G0850M0

figure 3-5 Grounding bolt, schematic view

After loosening the hex nut, connect the earth-bonding cable between the two washers as illustrated in the figures above. Then, fasten all parts again with the hex nut.

3.2.4. Connection of the Antenna Cables

The Remote Unit has 7/16-type antenna connectors. For its location please refer to chapter 3.2.2 *Connections*. For mounting the cable connectors, it is recommended to refer to the corresponding documentation of the connector manufacturer. The bending radius of the antenna cables must remain within the given specifications.

The bending radius of the antenna cables must remain within the given specifications.

Consider the type of cable best suited for the antenna. Remember that a cable with higher loss is less expensive but impairs performance.



Use an appropriate torque wrench for the coupling torque (25 N-m / 19 ft lb) of 7-16 DIN connectors with 1-1/4 in opening to tighten the 7/16-type antenna connectors. For example, use torque wrench of item no. 244377 available from the *Andrew e-catalog*. Do NOT use your hands or any other tool (e.g. a pair of pliers)! This might cause damage to the connector and lead to a malfunction of the Remote Unit.



To minimize passive inter-modulation (PIM) distortion, attention has to be paid to the physical condition of the connector junctions. Do not use connectors that show signs of corrosion on the metal surface. Prevent the ingress of water into the connector. Attach and torque the connectors properly.

3.2.5. Connection of AC Mains Power

Before connecting electrical power to the units, the system must be grounded as described in the previous chapter.

Mains power must be connected at the mains connectors of the unit (see chapter 3.2.2 *Connections*).

The power supply plug is part of the delivery. The correct wiring of the power supply plug is as follows:

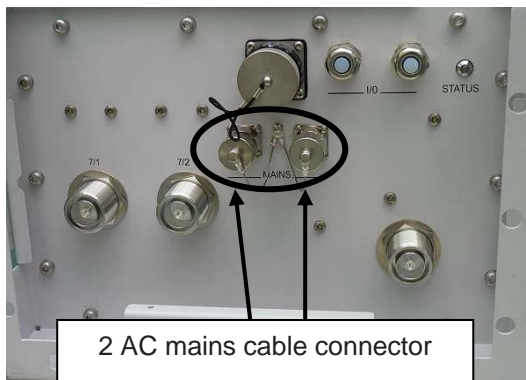

figure 3-6 Position of AC mains connectors at connector flange

Mains Plug - AC PIN Assignment:

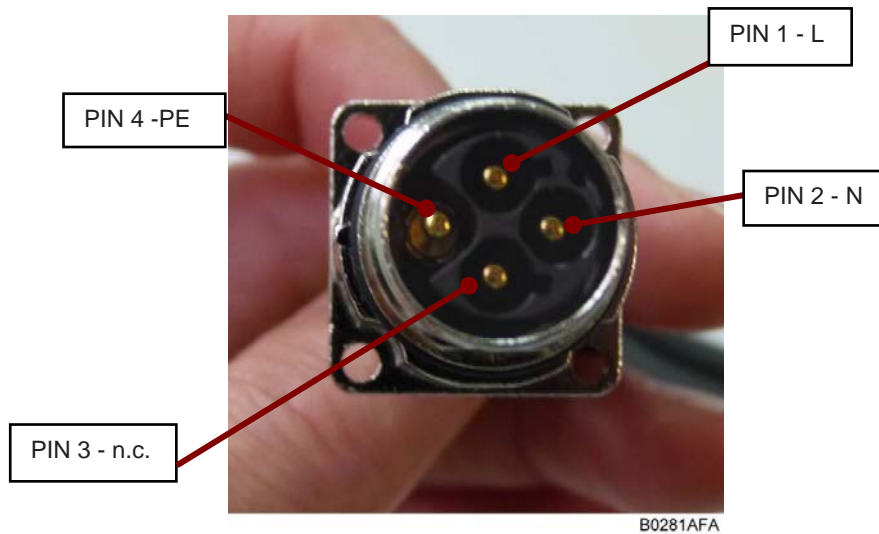

figure 3-7 AC mains plug, front view

PIN 1 = Phase 1 – L (brown cable)
PIN 2 = Neutral – N (blue cable)
PIN 3 = not connected (n.c.)
PIN 4 = PE (green/ yellow cable)



For the AC power supply connection, a minimum cross section of 1.5 mm² is required. Each wire must observe the applicable national regulations regarding loop impedance, voltage drop, and methods of installation. Make sure to connect the correct voltage to the unit.

Note: Do not connect or disconnect the power cord at the mains connector while power is on. Turn off mains power* before connecting the power cord at the remote unit, then, engage mains again.

* Mains power must be interruptible with an external mains breaker. For the mains breaker, observe the following recommendation:

120 Volt / 20 Amp max. or 240 Volt / 16 Amp, single-phase, 50 / 60 Hz AC service is needed, i.e. the external AC breaker should be 20 Amps max. for 120-Volt service or 16 Amps for 240-Volt service.

3.2.6. Connection of Optical-Fibre-Cable - Rules

Optical signals are transmitted by use of optical fibres. When connecting these fibres observe the following instructions.

 **Note:** Care should be taken when connecting and disconnecting fibre-optic cables. Scratches and dust significantly affect system performance and may permanently damage the connector. Always use protective caps on fibre-optic connectors not in use.

In general, optical fibres do not need special protective measures. However, protection against environmental influences e.g. rodents and humidity must be considered.

The optical fibre is a single mode fibre. Type is E9/125 µm with the following minimum requirements:

Attenuation: <0.36 dB / km @ 1310 nm / <0.26 dB / km @ 1550 nm
Dispersion: <3.5 ps / nm km @ 1310 nm / <18.0 ps / nm km @ 1550 nm

The specified bending radius of the optical fibres must not be exceeded. The pigtails for the connection between Master Unit and Remote Unit must have a sufficient length. A protection for the feeding into units must be given. The system attenuation of the optical fibres, including the connectors, must not exceed 10 dB.

System attenuation and attenuation of optical components must be determined. This can be achieved by measuring attenuation and reflection with an appropriate measuring instrument. For pigtails, a total value of < 0.4 dB (measured to a reference plug) can be assumed due to the dead zone of the reflectometer. These measurements must be made with a sufficient length of optical fibre, at the input and output of the device which has to be measured.

Fibre-cable connectors have to be of the same type (E2000APC8°) as the connectors used for the unit. The fibre-optic cables are connected to the optical transceiver.



Angled connectors are not compatible with straight optical connectors; non-compatibility of connectors will result in permanent damage to both connectors.

Before connecting the fibre cables, follow the procedure below to ensure optimized performance. It is important for these procedures to be carried out with care:

- Remove fibre-optic protective caps.
- Do not bend the fibre-optic cable in a tight radius (< 4 cm) as this may cause cable damage and interrupt transmission.
- Using high-grade alcohol and lint-free cotton cleaning swabs, clean the end of the fibre-optic cable that will be inserted in the optical connectors on the donor interface box.
- Blow out the laser receptacle with clean and dry compressed air to remove any particulate matter.
- Connect the fibre-optic cables by inserting the cable end into the laser receptacle and aligning the key (on the cable end) with the keyed slot.
- Do not use any index-matching gels or fluids of any kind in these connectors. Gels are intended for laboratory use and attract dirt in the field.

3.2.7. Protective Plug

Connection:

A protective plug is provided for the connection of the fibre-optic cables.

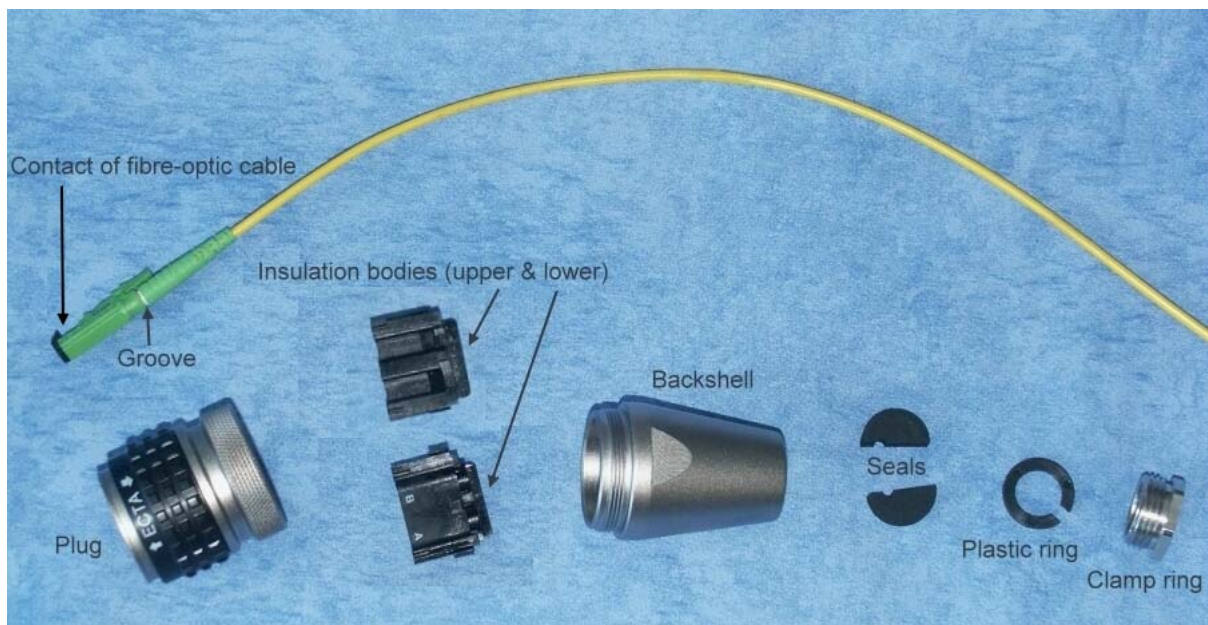

B0122AMA

figure 3-8 Protective-plug assembly

Note: Only high-quality connectors must be used for this type of plug. Qualified brands are Diamond or Huber & Suhner.

For plug assembly, observe the following instruction:

1. Pass one or two contacts through the backshell and the clamp ring.



B0122A1A

2. Place the contact(s) on the lower insulation body by pushing the groove of the contact into the cavity. If there is only one contact, cavity A **must** be used. *
3. Then, mount the upper insulation body on the lower insulation body. **

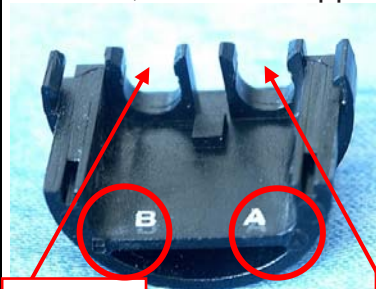

Cavity B

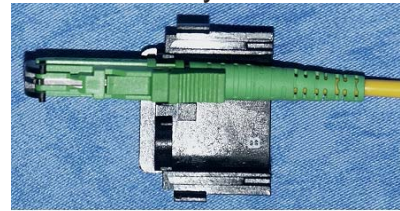

B0122ALA

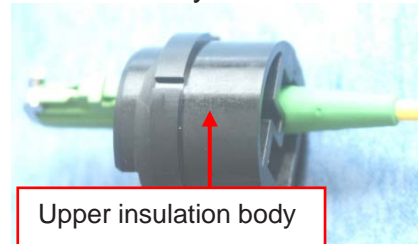

Upper insulation body

B0122A4A

4. Bring the insulator into the plug. The narrow groove of the insulator must be fitted into the stamp of the plug.

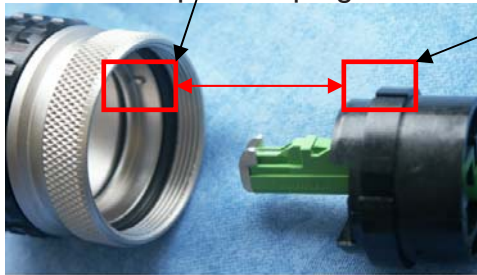

B0122AEA

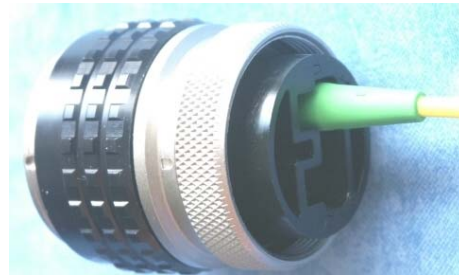

B0122A6A

- * To release the contact for disassembling, push the inner snap to the side and pull the contact out.
- ** To release upper and lower insulation bodies for disassembling, use a small screwdriver and carefully open the snap-connections at the left and the right side of the insulator without damaging them.

5. Fasten the insulator by screwing the backshell tight onto it. Use a spanner with opening 32 to screw the backshell tight (no gap).

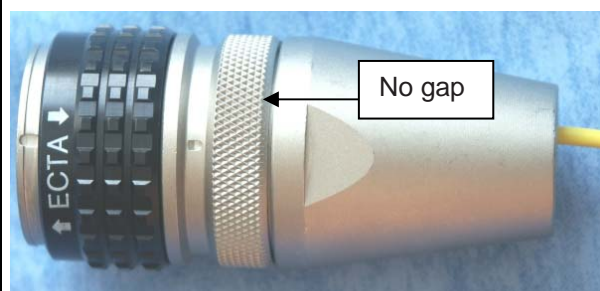

B0122A7A

6. Place the appropriate seal parts (with one groove for one contact or two grooves for two contacts) over the cable(s) and push them into the backshell.

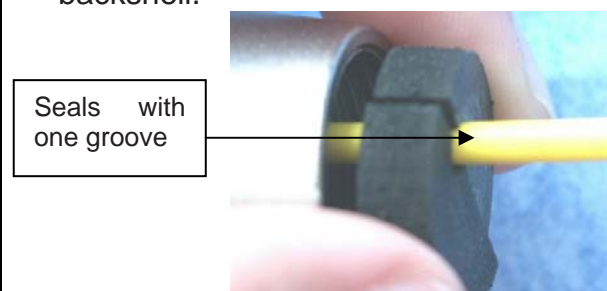

B0122A8A

7. Bring the plastic ring over the cable(s), push it into the backshell and compress the seals and plastic ring by screwing the clamp ring tight (no gap) using a spanner with opening 20. ***



B0122A9A

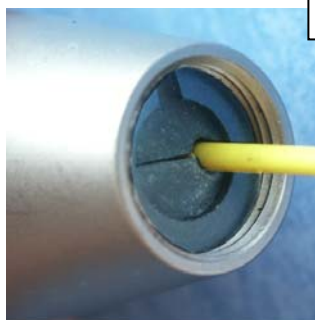

B0122AAA

Screw tight until gap is closed

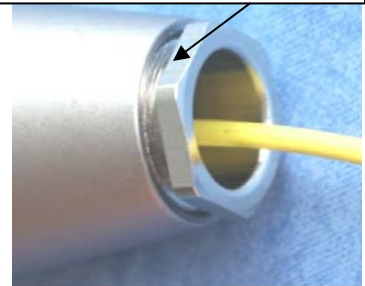

B0122ABA

8. Connect the plug to the optical-fibre connector of the remote unit, again by fitting a stamp on the plug into the groove of the connector.

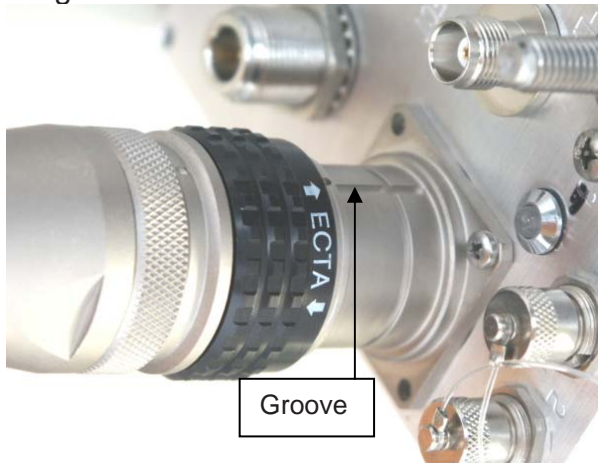

B0122ACA

9. To lock the connector, push the black locking ring forward.****



B0122ADA

Push forward to lock, pull back to free connection

*** For disassembling, release the clamping ring and remove the seals and the plastic ring first.

**** Locking mechanism: The system of locking the plug is based on a “push-pull” mechanism. The locking ring has to be pushed forward to lock the connector and pulled back to free the connection.

3.2.8. Protective-Tube Kit

As additional protection for the optical fibers, this connector type can be supplemented by a special tube kit. To fasten the tube correctly, first unscrew the clamp ring (if already installed) of the original plug kit.

Then, proceed according to the following instruction:

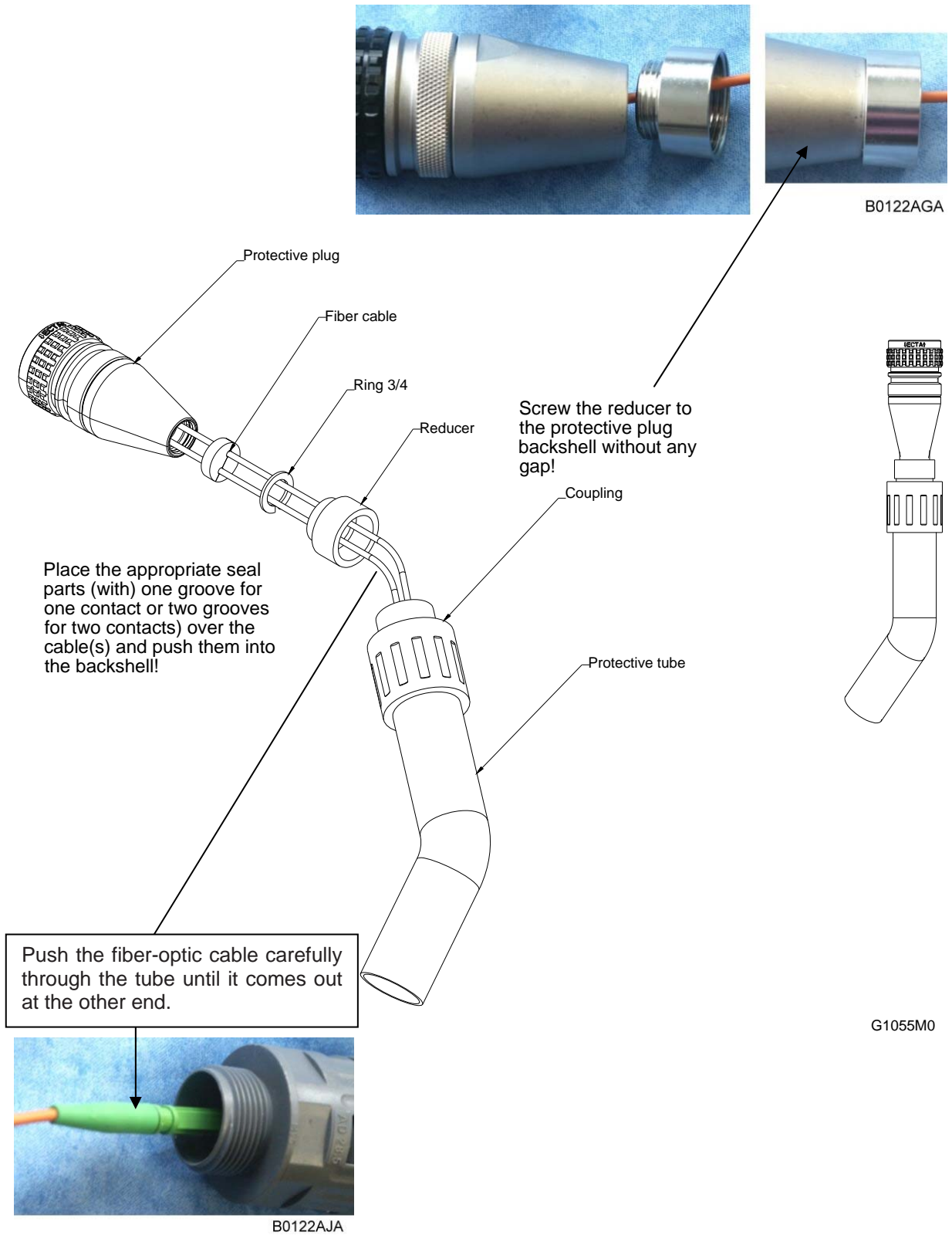
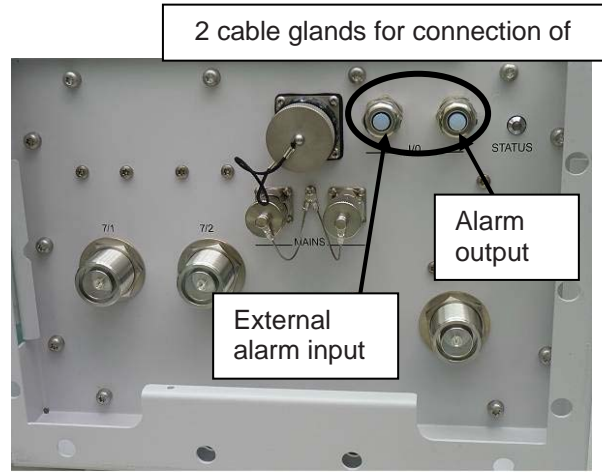

figure 3-9 Tube-kit installation

3.2.9. Connection of External-Alarms Cable

To connect the external alarms cable inside the RU to the inputs and/ or outputs of the external alarm connector, proceed as follows:

1. Loosen the sleeve nut provided for the external alarm inputs/ outputs connector from the cable gland on the connector flange with the help of an open-end wrench (of size 20 mm).



B0281AEA

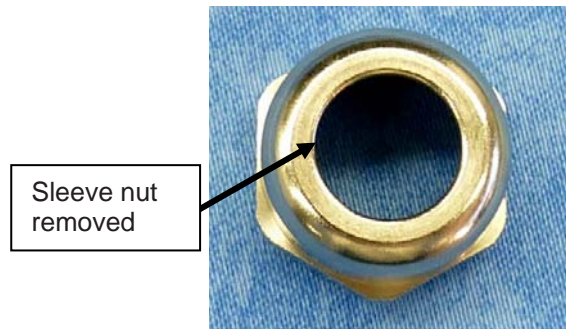

B0249ADA

2. Remove the seal insert (black) and plastic rod cut (white) from the clamp seal (grey).

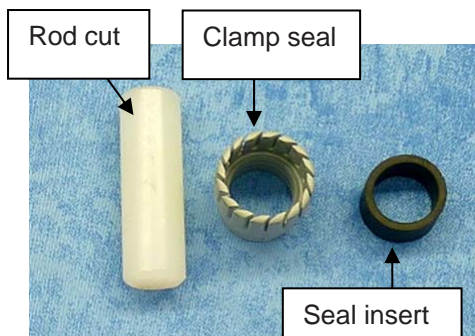

B0249AFA



B0255A8A

3. *Outside the RU* first fit the sleeve nut and second the clamp seal of the cable gland onto the external alarms cable.

4. Insert the external alarms cable together with the corresponding seal insert into the cable-gland feedthrough.

5. Fasten the sleeve nut on top of the cable gland again with the help of the open-end wrench (of size 20). **Note: Ensure tightness of the screw!**

6. Connect the mains cable to the clamps (part of the delivery) provided at the external alarm input/ output connector block located at the application board in the **interior** of the RU.

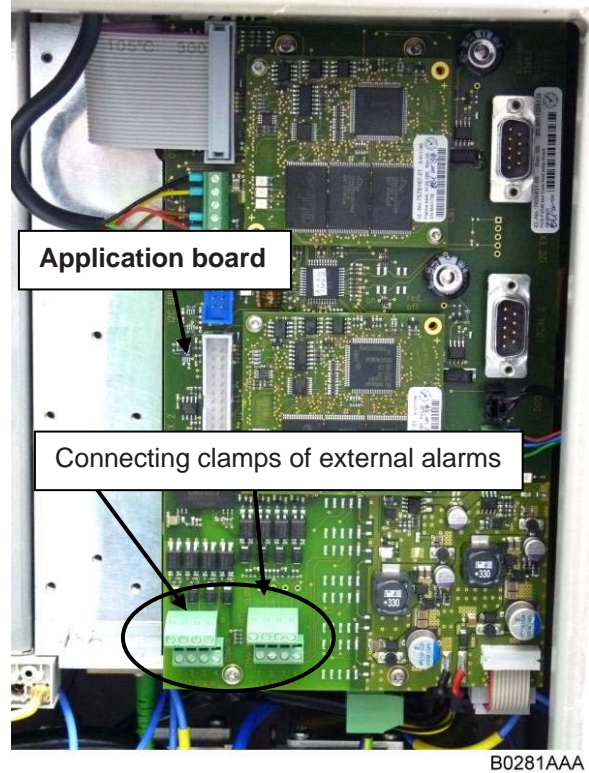

For more detailed information on the external alarm inputs and outputs please refer to chapters *4.5.1 External-Alarm Inputs and Outputs* and *4.5.2 Layout and Connector Description*.

3.3. COMMISSIONING

Read the health and safety warnings in chapter *1.2 Health and Safety Warnings* as well as the description carefully to avoid mistakes and proceed step by step as described!

- Do not operate the Remote Unit without terminating the antenna connectors. The antenna connectors may be terminated by connecting them to their respective antennas or to a dummy load.
- Only qualified personnel should carry out the electrical, mechanical, commissioning and maintenance activities that require the unit to be powered on when open.
- When opening the Remote Unit do not damage the warranty labels on the internal devices. The warranty is void if the seals are broken.
- Ensure that all connections have been performed according to chapter *3.2.2 Connections*.

Commissioning an ION-M Remote Unit

Manual for Remote Unit

Philips screwdriver

Mounting kit
Spanner, size 13 mm
Drilling machine
Dowels
Screw driver

Screw driver
Spanner, size 13 mm

Grounding cable
Spanner 13 mm

Alarm kit (M-cabinet)



E2000 APC8° connector
Spanner with opening 32

Mains cable
Connecting kit

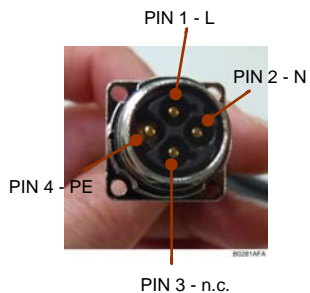
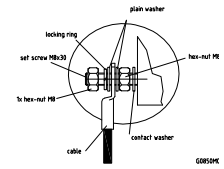
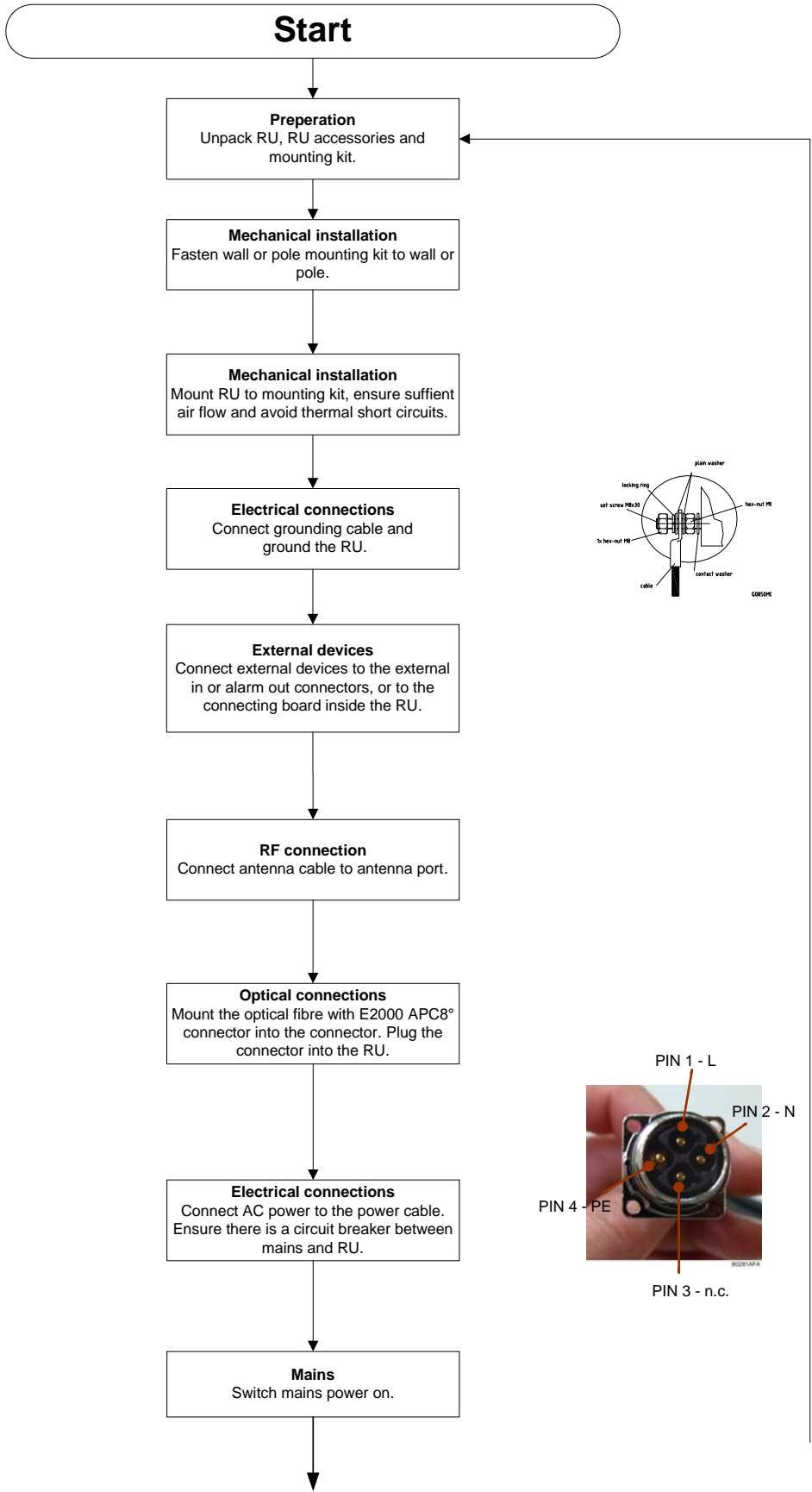

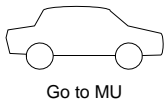
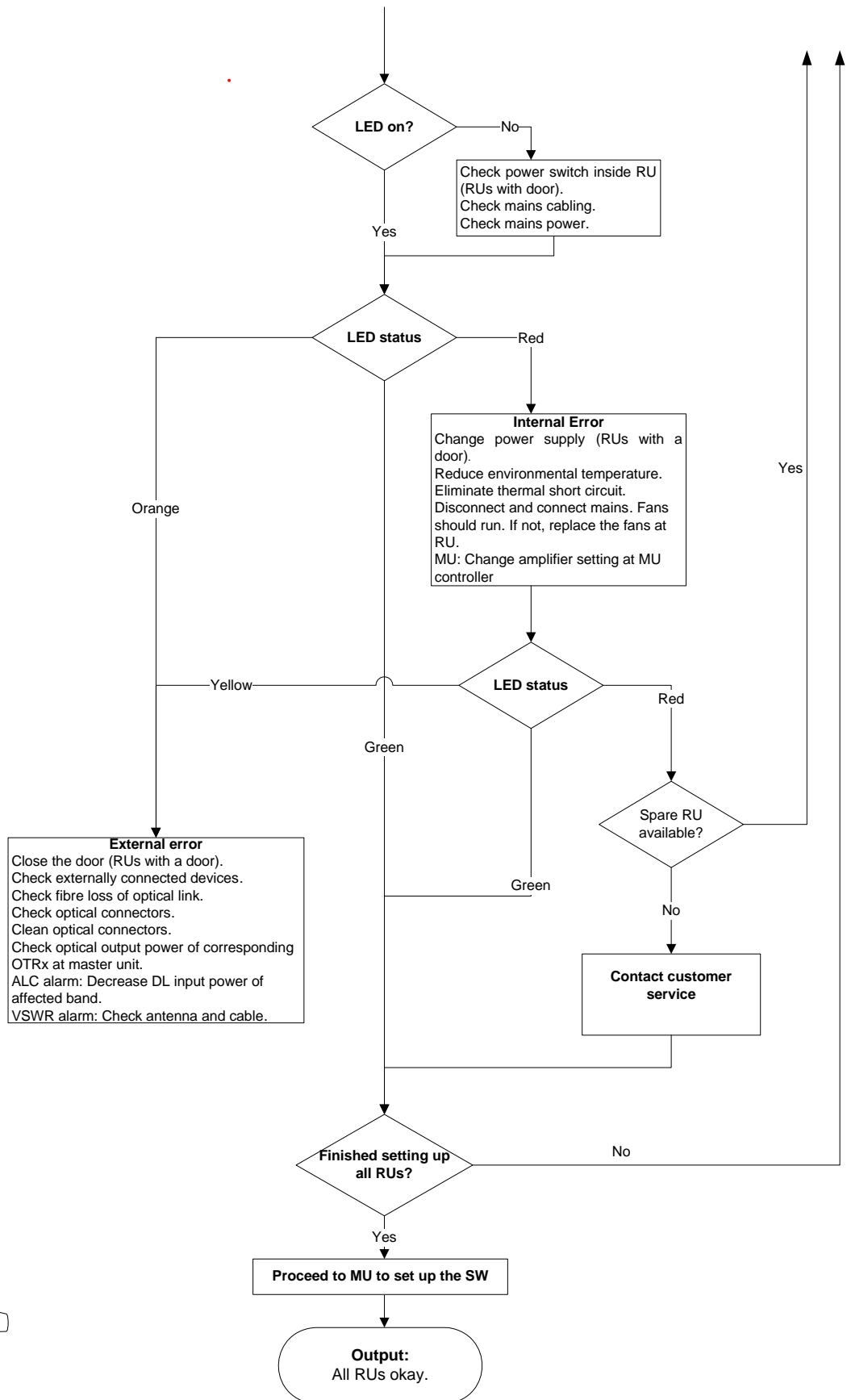

For your notes:

4. ALARMS

4.1. BITE AND ALARMS

The Built-In Test concept comprises the monitoring of the power supplies, the power amplifiers and the optical interface.

All occurring alarms can be checked via software at the Master Unit.

4.2. HANDLING OF ALARMS

As soon as the software acknowledges a valid alarm, a message is transmitted to the Master Unit.

If the reason for the alarm has been cleared or if the alarm should continue, a new alarm message will not be repeated. If there was an interruption of at least five seconds after acknowledgement, a new alarm message will be generated.

4.3. ALARM STATUS

For details refer to the corresponding software documentation of the Master Unit.

4.4. STATUS LED ALARMS

For local supervision, a status LED on the connector flange of the Remote Unit gives an indication of possible reasons for alarms. This table shows possible on-site measures that could be checked before referring to the Master Unit alarm list.

Status LED Indication	Alarms	Possible on-site measures
Green	No alarm → Status ok	
Orange	Door alarm	Close the door (RUs with door).
	<i>Alarms not directly related to RU:</i>	
	External alarms	Check externally connected devices.
	Optical alarm Rx	Check fibre loss of optical link. Check optical connectors. Clean optical connectors. <i>(MU: Check optical output power of corresponding OTRx at Master Unit).</i>
	ALC alarm	<i>(MU: Decrease DL input power of affected band).</i>
Red	<i>Alarms directly related to RU:</i>	
	Power 28 V	Change power supply (RUs with door). Replace the affected Remote Unit.
	Temperature	Reduce environmental temperature. Eliminate thermal short circuit.
	Fan	Disconnect and connect mains. Fans should run. If not, replace the fans at RU.
	I ² C	Disconnect and connect mains.
	Optical alarm Tx	-
	Amplifier “Power Down”	<i>(MU: Change amplifier setting at MU controller).</i>
Status LED off	Mains	Check power switch inside of RU (RUs with door). Check mains cabling. Check mains power.

table 4-1 Status LED alarms

For the position of the status LED see chapter 3.2.2 *Connections*.

Explicit troubleshooting is available in the MU software, (software manual or WEB Interface).

4.5. APPLICATION BOARD

4.5.1. External-Alarm Inputs and Outputs

There are four alarm inputs and four alarm outputs. The alarm outputs are potential-free relay contacts. They can be used to monitor alarms with an external-alarm indicator. Each alarm output can be set individually to any alarm at the Remote Unit. For details please refer to the according chapter in the software manual of the master unit.

 **Note:** **The manufacturer / supplier of this system accepts no liability for damage caused by equipment connected to external outputs or by effects from such equipment.**

With the external-alarm inputs, it is possible to monitor the status of connected devices, e.g. a UPS, via software. All alarm inputs are normally high (5 V) without connection.

The device to be monitored must be connected so that the alarm contacts will be closed in case of an alarm (0-5 V, max. 7 mA each input)

The location of the external-alarm inputs and outputs is illustrated in the following chapter *4.5.2 Layout and Connector Description*. Settings have to be done via the ION-M Master Controller and are described in the according software documentation.

Please note that at the Remote Unit (RU), the external-alarm inputs (outputs-optocoupler version) are optically decoupled.

Designation of External-Alarm Connectors for the ION-M7P/7P/19P/19HP (in the W-cabinet):

X13 & X19 => alarm inputs and outputs with optocoupler

X13 & X14 => alarm inputs with optocoupler, alarm outputs with relays

Standard version: Optocoupler outputs => relays not equipped

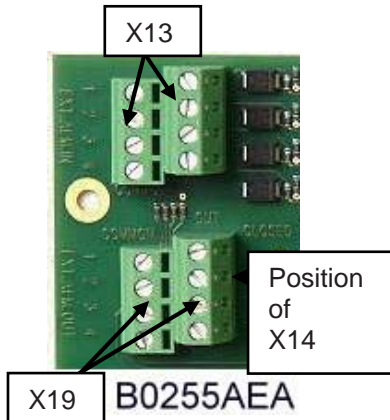

The connecting clamps for the external alarm inputs and alarm outputs are located at the lower left-hand side (when standing in front of the opened RU base) of the application board. For the layout of the application board please refer to the illustration in chapter 4.5.2 *Layout and Connector Description* and/ or to that in chapter 3.2.9 *Connection of External-Alarms Cable*, bullet point 7) For the exact designation of the connectors, please see picture to the left-hand side.

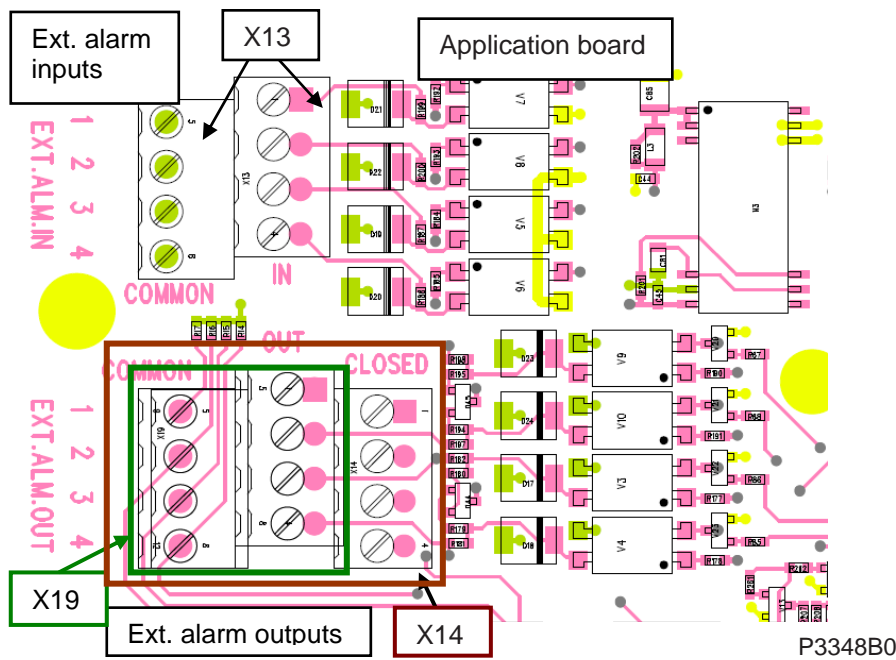
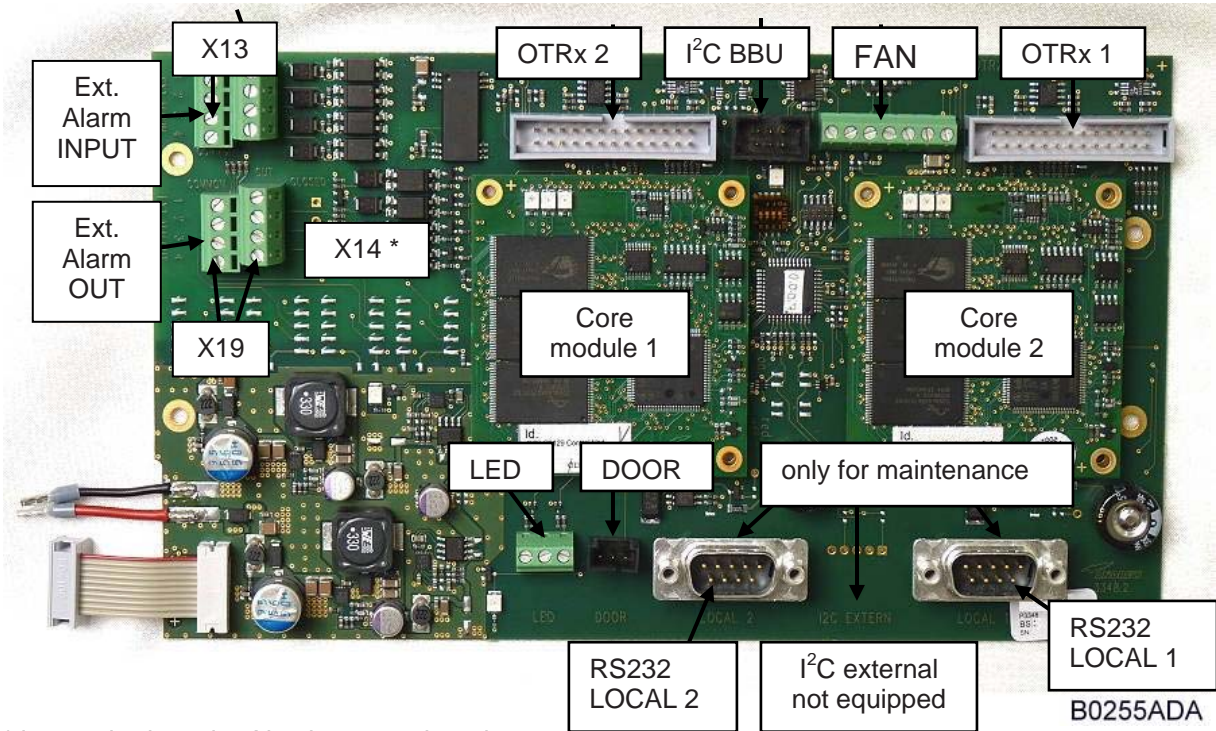

figure 4-1 External-alarm inputs and outputs, location

4.5.2. Layout and Connector Description



* in standard version X14 is not equipped

G3194X006

figure 4-2 Application board, connectors

External-Alarm Inputs with Optocouplers		
Connector	Pin	Description
X13¹⁾ = INPUTS	1	IN1_EXTERNAL
	2	IN2_EXTERNAL
	3	IN3_EXTERNAL
	4	IN4_EXTERNAL
	5	GND_ISOLATED
	6	
	7	
	8	

¹⁾ Voltage: 0 - 5 V;
Current: max. 7 mA (on each input)

Variant A) External-Alarm Outputs with Optocouplers		
Connector	Pin	Description
X19²⁾ = OUTPUTS	1	OUT1_EXTERNAL
	2	OUT2_EXTERNAL
	3	OUT3_EXTERNAL
	4	OUT4_EXTERNAL
	5	GND_ISOLATED
	6	
	7	
	8	

²⁾ Pull up tied to +5 V (on each output)
Voltage: 0 V or +5 V; I_{sink max.} = 2 mA;
Alarm active high

Variant B: External-Alarm Outputs with Relays		
Connector	Pin	Description
X14³⁾ = OUTPUTS	1	OUT1_NC
	2	OUT2_NC
	3	OUT3_NC
	4	OUT4_NC
	5	OUT1_NO
	6	OUT2_NO
	7	OUT3_NO
	8	OUT4_NO
	9	OUT1_CO
	10	OUT2_CO
	11	OUT3_CO
	12	OUT4_CO

³⁾ Voltage: +28 V, current: max. 0.4 A

table 5 3 External-alarm inputs and outputs, PIN assignment

Relay Contacts on the External-Alarm Output

In non-energized position /
alarm condition

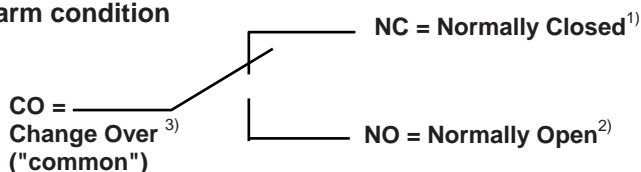

External-Alarm Output

Output voltage: 28 Vdc
Output current: 0.5 A

figure 4-3 External-alarm outputs, relay contacts in alarm condition

- ¹⁾ **NC** = abbrev. of "**N**ormally **C**losed (contact)" (a.k.a. **break contact**)
In non-energized position of the relay, this contact is closed and opens after coil energization
- ²⁾ **NO** = abbrev. of "**N**ormally **O**pen contact (a.k.a. **make contact**),
In non-energized position of the relay, this contact is open, and will be closed after coil energization.
- ³⁾ **CO** = abbrev. of "**C**hange **O**ver (contact (a.k.a. **double throw**)
This contact is the common contact configuration comprising both NC and NO contacts electrically connected. With switching, the CO contact changes between NC and NO.

28 V DC Connector

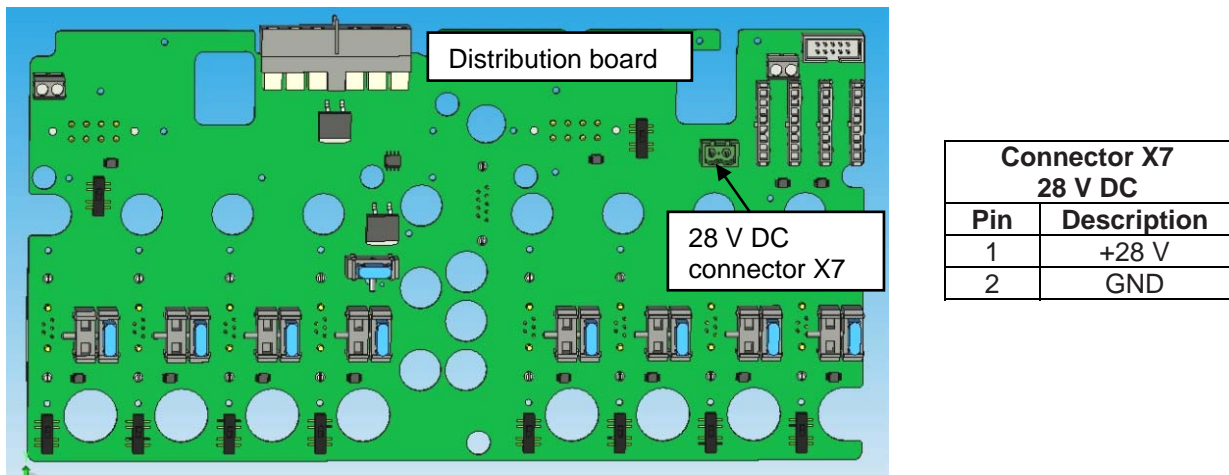

figure 4-4 28 V DC connector, location on distribution board

The 28 V DC connector denominated connector "X7" is located on top of the distribution board.

The 28V DC connector serves for connection of external devices (e.g. VSWR module).

4.6. TROUBLESHOOTING

The status of the Remote Unit can be checked via the Master Unit (for details please refer to the software manual of the Master Controller). Locally, the status can be checked at the LED, see chapter *4.4 Status LED Alarms*.

5. MAINTENANCE

5.1. GENERAL

Read the health and safety warnings in chapter *1.2 Health and Safety Warnings*.

- ☞ **Note:** The Remote Unit does not require preventative maintenance measures.
- ☞ **Note:** To prevent malfunctions of the cooling system due to dirt or pollution, it is recommended to clean the heat sink at regular intervals. These cleaning intervals depend mainly on the location of the Remote Unit and the corresponding degree of pollution.

Maintenance of the ION-M7P/7P/19P/19HP should be performed by replacing only components that are contained in this chapter. In order to maintain warranty, take care not to damage unintentionally the seals on the modules.

The spare parts list, consequently, contains only units which can be replaced without tuning or soldering work.

- ☞ **Note:** When sending back the unit, use an appropriate packaging, see chapter *6.2.2 Mechanical Specifications*. We strongly recommend using the original packaging!
- ☞ **Note:** Defect parts should only be replaced by original parts from the supplier. All interventions inside the housing are at one's own risk.
- ☞ **Note:** During maintenance ensure the Remote Unit has been disconnected from mains.
- ☞ **Note:** Before disconnecting any cables, label any unlabelled cables to ensure correct connection.

For most maintenance procedures appropriate tools are required to ensure correct handling. All these tools can be ordered from the supplier. For screwing procedures observe that all our screws have a right-hand thread, i.e. for fastening the screws turn the tool clockwise and for unscrewing them turn it counter-clockwise.

Due to the design of the Remote Unit the only component recommended to be replaced is the fan unit. For replacing any other component, please contact the supplier.

5.2. REPLACING THE FAN UNIT

Replacement of the fan unit is not required as a preventative measure. Only if an alarm indicates a malfunctioning of a fan must the unit be exchanged.

Note: Please observe that the fan unit can only be replaced as a whole. Do not remove the fans separately.

Read the health and safety warnings in chapter 1.2 *Health and Safety Warnings* as well as the instructions in chapter 5.1 *General* before starting with the replacement.

1. **Switch off the Remote Unit. Make sure mains power is disconnected for the following replacement procedure.** Then, proceed as follows:
2. Take the protective cover off the cabinet by pulling it strongly to the front (see also chapter 3.1.2).
3. Loosen the four tallow-drop screws M4x8 of the fan guard by which the fan plate is screwed to the cabinet. Remove the four screws and the corresponding washers.

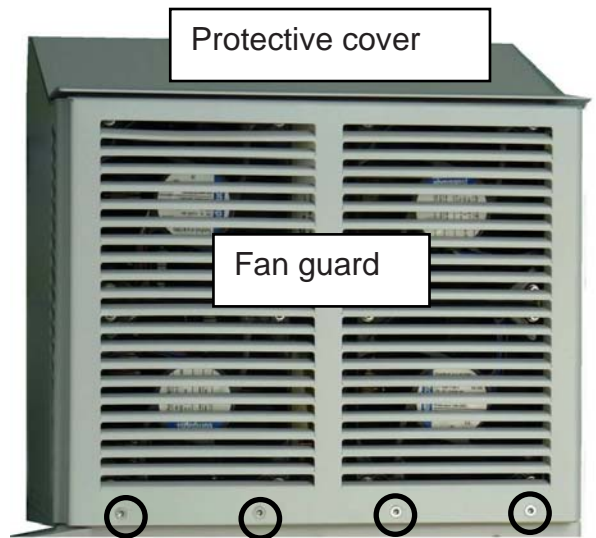

B0281A5A

Take out the entire fan plate together with all four fans.

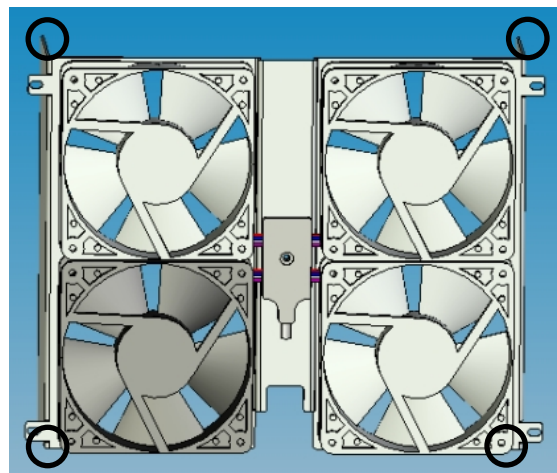

L_G3194X010

4. Remove the fan unit – by putting slight pressure on the fan plate cover – to a position that allows access to the fan connector and the earth-bonding cable.
5. Unscrew the fan connector and then disconnect the earth-bonding cable.

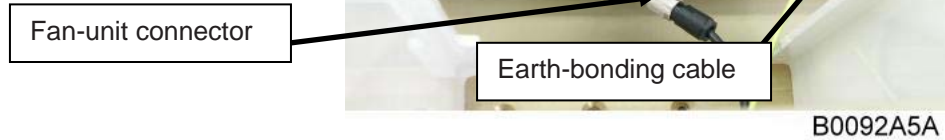

Note: To observe the specified torque of 650 Ncm for an M5 thread, use an appropriate tool for the following screwing procedures.

6. To mount the new fan unit, re-connect the earth-bonding cable and the fan connector (see *step 5*). Then, place the fan unit back into its original position and fix it tight.
7. Screw the whole fan unit to the cabinet with the four tallow-drop screws M4x8 (see *step 2*). In order not to exceed the specified torque of 330 Ncm, use an appropriate tool.
8. Put the protective cover back on the top of the cabinet (see *step 2*).

5.3. CLEANING THE HEAT SINK

👉 **Note:** Read the health and safety warnings in chapter 1.2 *Health and Safety Warnings* as well as the instructions in chapter 5.1 *General* before starting with the replacement procedure. Then, proceed as follows:

1. Switch off the Remote Unit. For the following procedure ensure to have mains disconnected before!
2. Remove the protective cover and the fan plate with the fan unit from the Remote Unit as described in chapter 5.2 *Replacing the Fan Unit*, steps 1 and 2:
3. Use compressed air (max. 5 bar) to blow out the heat sink from back to front as illustrated in the figure below:

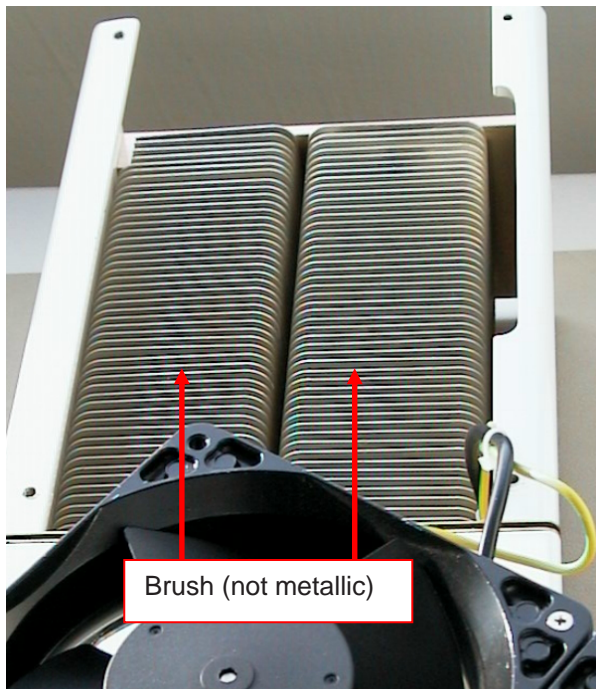

B0112A5A

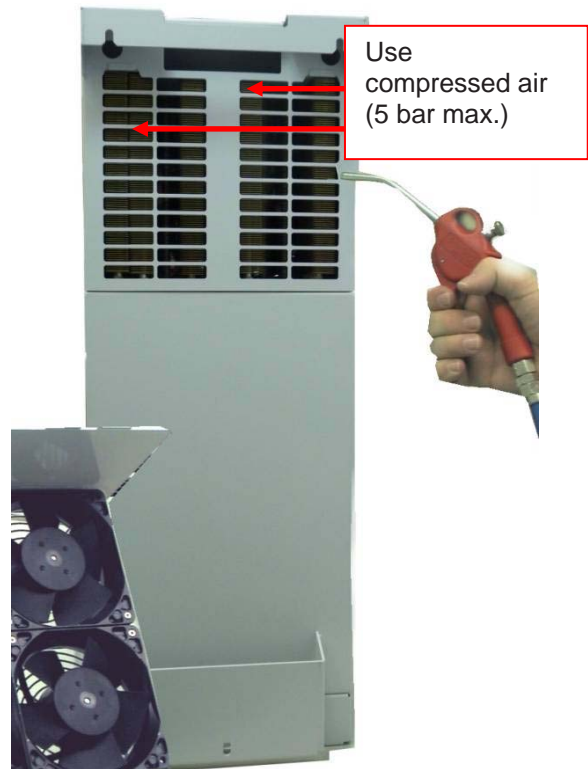

B0281AHA

4. In case the dirt cannot be blown out completely and parts of it stick to the ribs of the heat sink, clean the parts concerned carefully from the front using e.g. a brush. Take care that the material is not scratched or damaged.
5. After cleaning the heat sink, mount the fan unit and protective cover again according to chapter 5.2 *Replacing the Fan Unit*, steps 7 and 8. Then, switch the Remote Unit back on.

6. APPENDIX

6.1. ILLUSTRATIONS

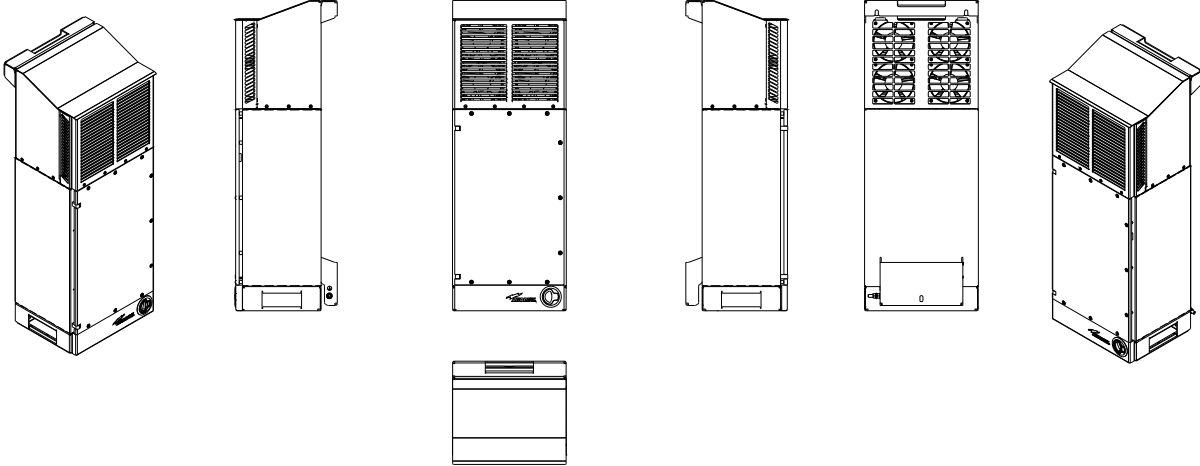

figure 6-1 Cabinet drawing

6.2. SPECIFICATIONS

6.2.1. Electrical Specifications

Electrical		
Power supply	Mains power	115 Vac or 230 Vac
Optical		
Optical link	Connectors	E2000/APC 8°
	Optical return loss	45 dB
	Fibre type	Single mode E9/125 µm
	Optical link budget	0 dB to 10 dB
Input power range	700 MHz (Main)	-15 dBm to +14 dBm
	700 MHz (MIMO)	-15 dBm to +14 dBm
	1900 MHz (P)	-15 dBm to +11 dBm
	1900 MHz (HP)	-12 dBm to +14 dBm

All data is subject to change without notice.

6.2.2. Mechanical Specifications

Height, width, depth *	900 x 330 x 300 mm (35.4 x 13.0 x 11.8 in)
Weight	55 kg (121 lb)

* A spacing of 40 mm (1.58 in) around the unit is required.

All data is subject to change without notice.

6.2.3. Environmental and Safety Specifications

 **Note:** For detailed information, please refer to the **Environmental and Safety Specifications leaflet of the supplier, related to ETS 300 019 (European Telecommunication Standard).**

Environmental

Operating temperature range	-33 to +50°C	
Ingress protection	RF part	IP66
	Fan part	IP55

All data is subject to change without notice.

6.3. SPARE PARTS

The following list contains all parts available for the Remote Unit. The configuration of the delivered unit meets the requirements of the customer and can differ depending on the state of the delivery.

Maintenance of the ION-M7P/7P/19P/19HP should be performed on an FRU (Field Replaceable Unit) basis only. Do not damage the warranty labels on the components, as this voids the warranty.

If any FRU not contained in the following list needs to be replaced, please contact customer service for additional instructions.

Spare Parts List of the Remote Unit ION-M7P/7P/19P/19HP

Designation	ID No
ION-M7P/7P/19P/19HP	7633573
Fan Unit W-Cabinet	7619978
Wall Mounting Kit	7635354
Manual for ION-M7P/7P/19P/19HP	7635569-00

The manufacturer reserves the right to replace the spare parts listed above by equivalent substitutes.

Note: Only the spare parts listed above are FRUs (= Field Replaceable Units) and can be replaced by the user. For replacement of any other parts, please send the entire Remote Unit back to the manufacturer.

7. INDEX

A		F	
Abbreviations Used	5	Fibre-Sealing Kit	27
Address of Andrew Wireless Systems GmbH.....	11	G	
Alarms		Grounding.....	19
Alarm Status	32	H	
Bite and Alarms	32	Health and Safety Warnings.....	7
External.....	34	I	
External Inputs.....	34	Illustrations	43
Handling of Alarms	32	Installation	
List	38	Electrical	17
Outputs	34	Mechanical	14
RU	38	M	
Status LED.....	33	Maintenance	39
Andrew Solutions.....	9	Mounting	
Application Board	34, 36	Wall.....	16
Alarm Input Connectors	36	O	
Alarm Inputs & Outputs.....	36	Optical-Fibre Connection.....	27
Alarm-Output Connectors	37	Protective Plug	23
External-Alarm Inputs and Outputs.....	34	Protective-Tube Kit	25
Relays.....	34	R	
C		Relay Contacts - External-Alarm Output.....	37
Cleaning the Heat Sink.....	42	Replacement of Fan Unit.....	40
Commissioning		S	
General	28	Spare Parts	45
Components		Specifications	
CPD Option.....	13	Electrical	44
Connection		Environmental and Safety.....	44
External-Alarms Cable	27	Mechanical	44
Connection Rules		T	
Optical-Fibre Cables	22	Troubleshooting.....	38
Connections			
Antenna	19		
Connector Flange	18		
Mains Power AC	20		
Optical-Fibre Cable.....	22		
Power	20		
Contact Addresses	10		
Customer Support Addresses.....	10		
D			
Distribution Board			
28 V DC Connector.....	38		
E			
External-Alarms Cable.....	27		