

# COMMSCOPE<sup>®</sup>

## ION<sup>®</sup>-M7HP/85HP EU Extension Unit



**(ML-Cabinet)**

Manual  
**MF0145ASA**

POWERED BY



**DISCLAIMER:**

This document has been developed by CommScope, and is intended for the use of its customers and customer support personnel. The information in this document is subject to change without notice. While every effort has been made to eliminate errors, CommScope disclaims liability for any difficulties arising from the interpretation of the information contained herein. The information contained herein does not claim to cover all details or variations in equipment, nor to provide for every possible incident to be met in connection with installation, operation, or maintenance. This document describes the performance of the product under the defined operational conditions and does not cover the performance under adverse or disturbed conditions. Should further information be desired, or should particular problems arise which are not covered sufficiently for the purchaser's purposes, contact CommScope.

CommScope reserves the right to change all hardware and software characteristics without notice.

**COPYRIGHT:**

© Copyright 2014 CommScope Inc. All Rights Reserved.

This document is protected by copyright. No part of this document may be reproduced, stored in a retrieval system, or transmitted, in any form or by any means, electronic, mechanical photocopying, recording, or otherwise without the prior written permission of CommScope.

**TRADEMARKS**

All trademarks identified by ® or ™ are registered trademarks or trademarks, respectively, of CommScope. Names of products mentioned herein are used for identification purposes only and may be trademarks and / or registered trademarks of their respective companies.

Andrew Wireless Systems GmbH, 04-June-2014

**TABLE OF CONTENTS**

<b>1. GENERAL</b>	<b>6</b>
1.1. ABBREVIATIONS	6
1.2. HEALTH AND SAFETY	7
1.3. PROPERTY DAMAGE WARNINGS	7
1.4. COMPLIANCE	8
1.5. ABOUT COMMSCOPE	10
1.6. INTERNATIONAL CONTACT ADDRESSES FOR CUSTOMER SUPPORT	11
<b>2. INTRODUCTION</b>	<b>13</b>
2.1. PURPOSE	13
2.2. THE ION-M7HP/85HP EU	13
<b>3. COMMISSIONING</b>	<b>15</b>
<b>3.1. MECHANICAL INSTALLATION</b>	<b>15</b>
3.1.1. Health and Safety for Mechanical Installation	15
3.1.2. Property Damage Warnings for Mechanical Installation	15
3.1.3. Mounting Distance between RU and EU	17
3.1.4. Wall-Mounting Procedure	18
3.1.5. Pole Mounting	19
3.1.6. Mounting of DC Box	21
<b>3.2. ELECTRICAL INSTALLATION</b>	<b>22</b>
3.2.1. Health and Safety for Electrical Installation	22
3.2.2. Property Damage Warnings for Electrical Installation	22
3.2.3. Connections	23
3.2.4. Grounding (Earthing)	24
3.2.5. Connection of the Antenna Cables	24
3.2.6. Cleaning Procedure for RF Cable Connectors	25
3.2.7. Antenna Cable Connector Assembly	28
3.2.8. Power Connection	29
3.2.8.1. AC Power Connection	29
3.2.8.2. DC Power Connection	30
3.2.9. Connection Extension Unit to the Main Unit	31
3.2.10. Flowchart	32
<b>4. ALARMS AND TROUBLESHOOTING</b>	<b>34</b>
<b>5. MAINTENANCE</b>	<b>35</b>
5.1. GENERAL	35
5.2. REPLACING THE FAN UNIT	36

<b>5.3.</b>	<b>CLEANING THE HEAT SINK</b>	<b>37</b>
<b>6.</b>	<b>APPENDIX</b>	<b>38</b>
<b>6.1.</b>	<b>ILLUSTRATIONS</b>	<b>38</b>
<b>6.2.</b>	<b>SPECIFICATIONS</b>	<b>40</b>
6.2.1.	Electrical Specifications	40
6.2.2.	Mechanical Specifications	40
6.2.3.	Environmental and Safety Specifications	40
<b>6.3.</b>	<b>SPARE PARTS</b>	<b>41</b>
<b>7.</b>	<b>INDEX</b>	<b>42</b>

**FIGURES AND TABLES**

figure 3-1 Maximum distance between RU and EU ..... 17

figure 3-2 Mounting bracket installation..... 18

figure 3-3 RU wall mounting ..... 18

figure 3-4 Pole-mounting kit..... 19

figure 3-5 Pole-mounting, ML-cabinet, assembly drawing ..... 20

figure 3-6 Pole mounting of RU, finished..... 20

figure 3-7 Mounting of DC Box ..... 21

figure 3-8 Mounting of DC Box, finished..... 21

figure 3-9 Connector flange of ION-M7HP/85HP without DC Box ..... 23

figure 3-10 Grounding bolt..... 24

figure 3-11 Grounding bolt, schematic view ..... 24

figure 3-12 Mains connector ..... 29

figure 3-13 Power supply plug to RU Mains connector ..... 30

figure 5-1 Fan unit and heat sink ..... 36

figure 6-1 Cabinet drawing (without DC Box)..... 38

figure 6-2 Cabinet drawing (with DC Box)..... 39

table 3-1 Specified torques..... 16





table 4-1 Status LED alarms..... 34

# 1. General

## 1.1. Abbreviations

3GPP	3 <sup>rd</sup> Generation Partnership Project
AC/DC	Alternating current / Direct Current
ALC	Automatic Level Control
BITE	Built-In Test Equipment
BTS	Base Transceiver Station
CE	"Conformité Européenne" ("European Conformity")
CD	Compact Disk
DL	Downlink
EDGE	Enhanced Data Rates for GSM Evolution
EN	European Norm
EP	Extension Port
ESD	Electrostatic Discharge
ETS	European Telecommunication Standard
EU	Extension Unit
GSM	Global System for Mobile Communication
GND	Ground
GUI	Graphical User Interface
ICP3	Intercept Point 3rd order
ID No	Identification Number
ION	Intelligent Optical Network
IP	Ingress Protection
ISO	International Organization for Standardization
LED	Light Emitting Diode
LTE	Long Term Evolution
MS	Mobile Station
MU	Main Unit
NF	Noise Figure
OTRx	Optical Transceiver = SRMU (Subrack Master Unit)
PG	Packing Gland
PIM	Passive Intermodulation
RF	Radio Frequency
RU	Remote Unit
RX	Receiver
SNMP	Simple Network Management Protocol
TS	Technical Specification
TX	Transmitter
UL	Uplink
UMTS	Universal Mobile Telecommunication System
UPS	Uninterruptible Power Supply
VSWR	Voltage Standing Wave Ratio
WCDMA	Wideband Code Division Multiple Access
WDM	Wavelength Division Multiplex

## 1.2. Health and Safety

-  1. **Danger:** Electrical hazard. Danger of death or fatal injury from electrical current. Obey all general and regional installation and safety regulations relating to work on high voltage installations, as well as regulations covering correct use of tools and personal protective equipment.
-  2. **Danger:** Electrical hazard. Danger of death or fatal injury from electrical current inside the unit in operation. Before opening the unit, disconnect mains power.
-  3. **Caution:** High frequency radiation in operation. Risk of health hazards associated with radiation from the unit's inner conductor of the antenna port(s). Disconnect mains before connecting or replacing antenna cables.
-  4. **Caution:** High frequency radiation in operation. Risk of health hazards associated with radiation from the antenna(s) connected to the unit. Implement prevention measures to avoid the possibility of close proximity to the antenna(s) while in operation.

## 1.3. Property Damage Warnings

1. **Attention:** Due to power dissipation, the unit may reach a very high temperature. Do not operate this equipment on or close to flammable materials. Use caution when servicing the unit.
2. **Notice:** Although the unit is internally protected against overvoltage, it is strongly recommended to ground (earth) the antenna cables close to the repeater's antenna connectors for protection against atmospheric discharge.
-  3. **Notice:** ESD precautions must be observed. Before commencing maintenance work, use the available grounding (earthing) system to connect ESD protection measures.
4. **Notice:** Only suitably qualified personnel are allowed to work on this unit and only after becoming familiar with all safety notices, installation, operation and maintenance procedures contained in this manual.
5. **Notice:** Keep operating instructions within easy reach and make them available to all users.
6. **Attention:** Only authorized and trained personnel are allowed to open the unit and get access to the inside.

7. **Notice:** Read and obey all the warning labels attached to the unit. Make sure that all warning labels are kept in a legible condition. Replace any missing or damaged labels.
8. **Notice:** Only license holders for the respective frequency range are allowed to operate this unit.
9. **Notice:** Make sure the repeater settings are correct for the intended use (refer to the manufacturer product information) and regulatory requirements are met. Do not carry out any modifications or fit any spare parts, which are not sold or recommended by the manufacturer.

## 1.4. Compliance

1. **Notice:** For installations, which have to comply with FCC RF exposure requirements, the antenna selection and installation must be completed in a way to ensure compliance with those FCC requirements. Depending on the RF frequency, rated output power, antenna gain, and the loss between the repeater and antenna, the minimum distance D to be maintained between the antenna location and human beings is calculated according to this formula:

$$D_{[cm]} = \sqrt{\frac{P_{[mW]}}{4 * \pi * PD_{[mW/cm^2]}}}$$

where

- P (mW) is the radiated power at the antenna, i.e. the max. rated repeater output power in addition to the antenna gain minus the loss between the repeater and the antenna.
- PD (mW/cm<sup>2</sup>) is the allowed Power Density limit acc. to 47 CFR 1.1310 (B) for general population / uncontrolled exposures which is
  - F (MHz) / 1500 for frequencies from 300MHz to 1500MHz
  - 1 for frequencies from 1500MHz to 100,000MHz

RF exposure compliance may need to be addressed at the time of licensing, as required by the responsible FCC Bureau(s), including antenna co-location requirements of 1.1307(b)(3).

2. **Notice:** For installations which have to comply with European EN50385 exposure compliance requirements, the following Power Density limits/guidelines (mW/cm<sup>2</sup>) according to ICNIRP are valid:
  - 0.2 for frequencies from 10 MHz to 400 MHz
  - F (MHz) / 2000 for frequencies from 400 MHz to 2 GHz
  - 1 for frequencies from 2 GHz to 300 GHz



- 3. Notice:** Installation of this equipment is in full responsibility of the installer, who has also the responsibility, that cables and couplers are calculated into the maximum gain of the antennas, so that this value, which is filed in the FCC Grant and can be requested from the FCC data base, is not exceeded. The industrial boosters are shipped only as a naked booster without any installation devices or antennas as it needs for professional installation.
- 4. Notice:** Corresponding local particularities and regulations must be observed. For national deviations, please refer to the respective documents included in the manual CD that is delivered with the unit.
- 5. Note:** This unit complies with European standard EN60950.

### **Equipment Symbols Used / Compliance**

Please observe the meanings of the following symbols used in our equipment and the compliance warnings:

Symbol	Compliance	Meaning / Warning
---	FCC	WARNING: This is NOT a CONSUMER device. It is designed for installation by FCC LICENSEES and QUALIFIED INSTALLERS. You MUST have an FCC LICENSE or express consent of an FCC Licensee to operate this device. You MUST register Class B signal boosters (as defined in 47 CFR 90.219) online at <a href="http://www.fcc.gov/signal-boosters/registration">www.fcc.gov/signal-boosters/registration</a> . Unauthorized use may result in significant forfeiture penalties, including penalties in excess of \$100,000 for each continuing violation.
	CE	Alert sign to R&TTE To be sold exclusively to mobile operators or authorized installers – no harmonized frequency bands, operation requires license. Intended use: EU and EFTA countries
CE 0700		Indicates conformity with the R&TTE directive 1999/5/EC certified by the notified body no. 0700.

## 1.5. About CommScope

*CommScope* is the foremost supplier of one-stop, end-to-end radio frequency (RF) solutions. Part of the *CommScope* portfolio are complete solutions for wireless infrastructure from top-of-the-tower base station antennas to cable systems and cabinets, RF site solutions, signal distribution, and network optimization. For patents see [www.cs-pat.com](http://www.cs-pat.com).

*CommScope* has global engineering and manufacturing facilities. In addition, it maintains field engineering offices throughout the world.

*Andrew Wireless Systems GmbH* based in Buchdorf/Germany, which is part of *CommScope*, is a leading manufacturer of coverage equipment for mobile radio networks, specializing in high performance, RF and optical repeaters. Our optical distributed networks and RF repeater systems provide coverage and capacity solution for wireless networks in both indoor installations and outdoor environments, e.g. tunnels, subways, in-trains, airport buildings, stadiums, skyscrapers, shopping malls, hotels and conference rooms.

*Andrew Wireless Systems GmbH* operates a quality management system in compliance with the requirements of ISO 9001 and TL 9000. All equipment is manufactured using highly reliable material. To maintain highest quality of the products, comprehensive quality monitoring is conducted at all fabrication stages. Finished products leave the factory only after a thorough final acceptance test, accompanied by a test certificate guaranteeing optimal operation.

This product meets the requirements of the R&TTE directive and the Declaration of Conformity (DoC) itself. A current version of the CE DoC is included in this manual CD delivered \*. Any updated version of the DoC is available upon request from the local sales offices or directly from *CommScope* via the local Customer Support at one of the addresses listed in the following chapter.

**According to the DoC, our "CE"-marked equipment can be used in all member states of the European Union.**

☞ **Note:** Exceptions of and national deviations from this intended use may be possible. To observe corresponding local particularities and regulations, please refer to the respective documents (also in national language) which are included in the manual CD delivered.

\* In case the Declaration of Conformity (DoC) for the product was not included in the manual CD delivered, it is available upon request from the local sales offices or directly from *CommScope* at one of the addresses listed in the following chapter.

To make the most of this product, we recommend you carefully read the instructions in this manual and commission the system only according to these instructions.

For technical assistance and support, please also contact the local office or *CommScope* directly at one of the addresses listed in the following chapter.

## 1.6. International Contact Addresses for Customer Support

<b>Canada</b>		<b>United States</b>	
<b>CommScope Canada</b> Mail 505 Consumers Road, Suite 803 Toronto M2J 4V8, Canada Phone +1-905-878-3457 (Office) +1-416-721-5058 (Cell) Fax +1-905-878-3297 E-mail wisupport@commscope.com		<b>Andrew LLC, A CommScope Company</b> Mail 620 North Greenfield Parkway Garner, NC 27529, U.S.A. Phone +1-888-297-6433 Fax +1-919-329-8950 E-mail wisupport@commscope.com	
<b>Caribbean &amp; South American Region</b>		<b>Caribbean &amp; Central American Region</b>	
<b>CommScope Cabos do Brasil Ltda.</b> CALA Tech Support for <i>Distributed Coverage &amp; Capacity Solutions (DCCS) products:</i> Mail Rua Guaporanga, 49 Praça Seca – Rio de Janeiro – RJ ZIP: 21320-180, Brazil Phone +1-815-546-7154 (Cell) +55-15-9104-7722 (Office) Fax + 55-15-2102-4001 E-mail wisupport@commscope.com		<b>CommScope Mexico S.A. de C.V.</b> CALA Tech Support for <i>Distributed Coverage &amp; Capacity Solutions (DCCS) products:</i> Mail Av. Insurgentes Sur 688, Piso 6 Col. Del Valle, CP: 03100 Mexico City, Mexico Phone +52-55-1346-1900 (Office) Fax +52-55-1346-1901 E-mail wisupport@commscope.com	
<b>China, India and Rest of Asia</b>		<b>Australia &amp; New Zealand</b>	
<b>Andrew International Corporation</b> Mail Room 915, 9/F Chevalier Commercial Centre 8 Wang Hoi Rd Kowloon Bay, Hong Kong Phone +852-3106-6100 Fax +852-2751-7800 E-mail wisupport.China@commscope.com		<b>Andrew Corporation (Australia) Pty Ltd.</b> Mail Unit 1 153 Barry Road Campbellfield VIC 3061, Australia Phone +613-9300-7969 Fax +613-9357-9110 E-mail wisupport.Australia@commscope.com	
<b>Middle East &amp; North Africa</b>		<b>South Africa</b>	
<b>CommScope Solutions International Inc. (Branch)</b> Mail PO Box 48 78 22 Unit 3206, Floor 32, Jumeirah Business Center 5, Jumeirah Lakes Towers, Dubai, United Arab Emirates Phone +971 4 390 09 80 Fax +971 4 390 86 23 E-mail wisupport@commscope.com		<b>Andrew Wireless Solutions Africa (PTY) LTD</b> Mail 11 Commerce Crescent West Eastgate, Sandton PO Box 786117 Sandton 2146 South Africa Phone + 27 11-719-6000 Fax + 27 11-444-5393 E-mail wisupport@commscope.com	

**A  
M  
E  
R  
I  
C  
A  
S**

**A  
P  
I  
A  
C**

**Africa  
&  
Middle  
East**

<b>United Kingdom</b>		<b>Scandinavia</b>
<p><b>Andrew Wireless Systems UK Ltd</b></p> <p>Unit 15, Ilex Building Mulberry Business Park Mail Fishponds Road Wokingham Berkshire RG41 2GY, England</p> <p>Phone +44-1189-366-792 Fax +44-1189-366-773 E-mail wisupport.uk@commscope.com</p>		<p><b>Andrew Norway (AMNW)</b></p> <p>P.O. Box 3066 Osloveien 10 Mail Hoenefoss 3501 Norway</p> <p>Phone + 47 32-12-3530 Fax + 47 32-12-3531 E-mail wisupport@commscope.com</p>
<b>Germany</b>		<b>France</b>
<p><b>Andrew Wireless Systems GmbH</b></p> <p>Industriering 10 Mail 86675 Buchdorf Germany</p> <p>Phone +49-9099-69-0 Fax +49-9099-69-930 E-mail wisupport@commscope.com</p>	<b>EUROPE</b>	<p><b>CommScope France</b></p> <p>Immeuble Le Lavoisier Mail 4, Place des Vosges 92052 Courbevoie, France</p> <p>Phone +33-1 82 97 04 00 Fax +33-1 47 89 45 25 E-mail wisupport@commscope.com</p>
<b>Austria</b>		<b>Switzerland</b>
<p><b>Andrew Wireless Systems (Austria) GmbH</b></p> <p>Weglgasse 10 Mail 2320 Wien-Schwechat Austria</p> <p>Phone +43-1706-39-99-10 Fax +43-1706-39-99-9 E-mail wisupport.austria@commscope.com</p>		<p><b>CommScope Wireless Systems AG</b></p> <p>Tiergartenweg 1 Mail CH-4710 Balsthal Switzerland</p> <p>Phone +41-62-386-1260 Fax +41-62-386-1261 E-mail wisupport.ch@commscope.com</p>
<b>Italy</b>		<b>Iberia Region - Spain &amp; Portugal</b>
<p><b>CommScope Italy S.r.l., Faenza, Italy</b></p> <p>Via Mengolina, 20 Mail 48018 Faenza (RA) Italy</p> <p>Phone +39-0546-697111 Fax +39-0546-682768 E-mail wisupport.italia@commscope.com</p>		<p><b>Andrew España S.A. A CommScope Company</b></p> <p>Avda. de Europa, 4 - 2ª pta. Mail Parque Empresarial de la Moraleja Alcobendas, Madrid 28108, Spain</p> <p>Phone +34-91-745-20 40 Fax +34-91-661-87 02 E-mail wisupport.iberia@commscope.com</p>
<b>Czech Republic</b>		
<p><b>CommScope Solutions Czech Republic C-Com, spol. s r.o</b></p> <p>U Moruší 888 Mail 53006 Pardubice, Czech Republic</p> <p>Phone +49 871 9659171 (Office) +49 171 4001166 (Mobile) Fax +49 871 9659172 E-mail wisupport@commscope.com</p>		

## 2. Introduction

### 2.1. Purpose

Cellular telephone systems transmit signals in two directions between a base transceiver station (BTS) and mobile stations (MS) within the signal coverage area.

If weak signal transmissions occur within the coverage area because of indoor applications, topological conditions or distance from the transmitter, extension of the transmission range can be achieved by means of an optical distribution system.

Such a system contains an optical Master Unit and several Remote Units. The number of the Remote Units depends on the hardware and software configuration. The Remote Units are connected to the Master Unit with optical links. The optical loss must be less than 10 dB inclusive optical couplers or splitters.

The Master Unit is the connection to the base transceiver stations. The configuration of a Master Unit depends on the number of the Remote Units and the frequency range.

WDM (Wave Division Multiplex) filters are integrated in the optical modules. For the UL, a wavelength within 1546 nm - 1550 nm is used. For the DL, a wavelength of  $1310 \pm 10$  nm is used. The maximum output power for the UL and DL is 6.7 mW.

### 2.2. The ION-M7HP/85HP EU

The ION-M7HP/85HP EU is an LTE CDMA/WCDMA multi-operator, multi-band Extension Unit. It is used in conjunction with the main unit ION-M17HP/19HP. This extension system transports multiple LTE700 channels and 850 MHz wide-band signals simultaneously, providing a cost-effective solution for distribution capacity from one or more base stations.

The ION-M7HP/85HP EU transports signals on the RF layer in a very inexpensive manner. This means that multiple operators and multiple technologies are moved simultaneously from a cluster of base stations to a remote location over the same fiber.

The ION optical distribution system is a cost-effective coverage solution for dense urban areas, tunnels, subway, airports, convention centers, high-rise buildings and other locations where physical structures increase path loss. It has been specifically designed to reduce zoning problems and to provide homogeneous coverage. The compact, mechanical design is specifically architected to mount alongside structures in such a way that it has a minimal visual impact. The ION-M7HP/85HP EU supports 700 MHz and 850 MHz. It has been specifically tested and optimized for LTE, OFDM, CDMA, and WCDMA signals.

The ION is easily set-up and supervised via a graphical user interface (GUI). Remote units can be commissioned through the use of built-in test equipment. An auto-leveling function compensates for the optical link loss making installation easy and quick. The entire system may be monitored remotely via an Andrew OMC. This platform uses SNMP protocol and is compliant to X.733 standard.

Should a sophisticated interface not be required, the Master Unit can be directly connected to the alarm interface of a base station via its contact relay.

- Multi-channel, multi-operator support
- Reduced visual impact form factor
- Efficient, high power amplifier
- Single fiber for multiple bands and multiple remotes
- Comprehensive operations and management system for configuration and alarming
- OMC with SNMP according to X.733 standard
- With reference to 3GPP TS25.143/TS25.106/ TS36.143/TS36.106 and 3GPP2C.S0051-0
- Easy installation and commissioning

## 3. Commissioning

Read and observe the health, safety, and property damage warnings as well as the description carefully to avoid mistakes and proceed step-by-step as described.

- **Attention:** Do not operate the unit without terminating the antenna connectors. The antenna connectors may be terminated by connecting them to their respective antennas or to a dummy load.
- **Notice:** Only qualified personnel should carry out the electrical, mechanical, commissioning, and maintenance activities that require the unit to be powered on when open.
- When opening the unit do not damage the warranty labels on the internal devices. The warranty is void if the seals are broken.

### 3.1. Mechanical Installation

The wall and pole mounting illustrations in the following all show units without DC Box. The installation of the DC Box is explained separately.

#### 3.1.1. Health and Safety for Mechanical Installation



1. **Caution:** Risk of injury by the considerable weight of the unit falling. Ensure there is adequate manpower to handle the weight of the system.



2. **Caution:** Risk of serious personal injury by equipment falling due to improper installation. The installer must verify that the supporting surface will safely support the combined load of the electronic equipment and all attached hardware and components. The screws and dowels (wall anchors) used should also be appropriate for the structure of the supporting wall.

#### 3.1.2. Property Damage Warnings for Mechanical Installation

1. **Attention:** Do not install the unit in a way or at a place where the specifications outlined in the Environmental and Safety Specifications leaflet of the supplier are not met.
2. **Attention:** Due to power dissipation, the unit may reach a very high temperature. Ensure sufficient airflow for ventilation.
3. **Notice:** Exceeding the specified load limits may cause the loss of warranty.
4. **Notice:** When connecting and mounting the cables (RF, optical, mains, ...) ensure that no water can penetrate into the unit through these cables.
5. **Notice:** Also observe all additional rules or restrictions regarding mounting that depend on the type of unit. For details refer to section 7.2.2 *Mechanical Specification*. Install the unit vertically with the fan unit at the top. A maximum tilt angle of 25° from a vertical position must be kept, as in the following illustrations:



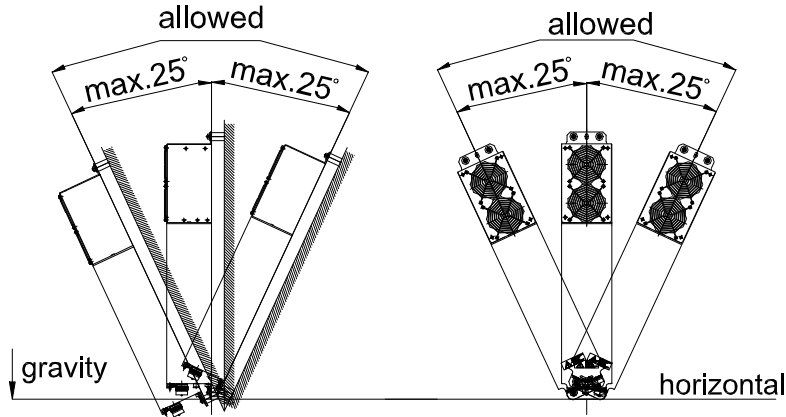

G1038M4

6. **Notice:** A spacing of 40 mm (1.58 inch) around the unit is required.
7. **Notice:** To ensure sufficient airflow when mounting the unit in enclosed spaces, two lid openings (one for the air inlet and the other for the air outlet) must be provided. Do not block these air inlets and outlets when mounting the unit. The size of each opening must equal at least 18 x 18 cm (>300 cm<sup>2</sup>). Make sure, too, there is no thermal short circuit between the air inlet and air outlet.
8. **Notice:** Depending on the installation type (wall or pole), the corresponding mounting kits must be ordered from the manufacturer. If any different or additional mounting material is used, ensure that the mounting remains as safe as the mounting designed by the manufacturer. The specifications for stationary use of the unit must not be exceeded. Ensure that the static and dynamic strengths are adequate for the environmental conditions of the site. The mounting itself must not vibrate, swing or move in any way that might cause damage to the unit.
9. **Notice:** To avoid damage when mounting the unit, always make sure that the M8 washers (DIN9021 or DIN125 depending on the mounting kit) are placed behind and in front of the mounting drillings of the unit.

Specified torques have to be observed for certain mounting procedures according to the following table:

Type	Lens head screws	Hex nuts	Spacing bolts		PG (plastic)	PG (aluminum)
Thread	M 4	M 8	M 4	M 8	PG 13.5	PG 29
Specified torques	3.3 N-m	27 N-m	2.3 N-m	27 N-m	3.75 N-m	10 N-m

table 3-1 Specified torques

**Note:** To avoid damage when mounting the unit, always make sure that the M8 washers (DIN9021 or DIN125 depending on the mounting kit) are placed behind and in front of the mounting drillings of the unit.

The mounting procedures for a stand-alone unit without optional accessories are described and illustrated in the following sections. For further information regarding special mounting procedures including mounting of accessory equipment, please see separate manual.



### 3.1.3. Mounting Distance between RU and EU

The Extension Unit has to be connected to the Remote Unit via the cable bridge that has to be ordered separately from the supplier. The length of the cable bridge determines the maximum mounting distance between the Remote Unit and the Extension Unit:

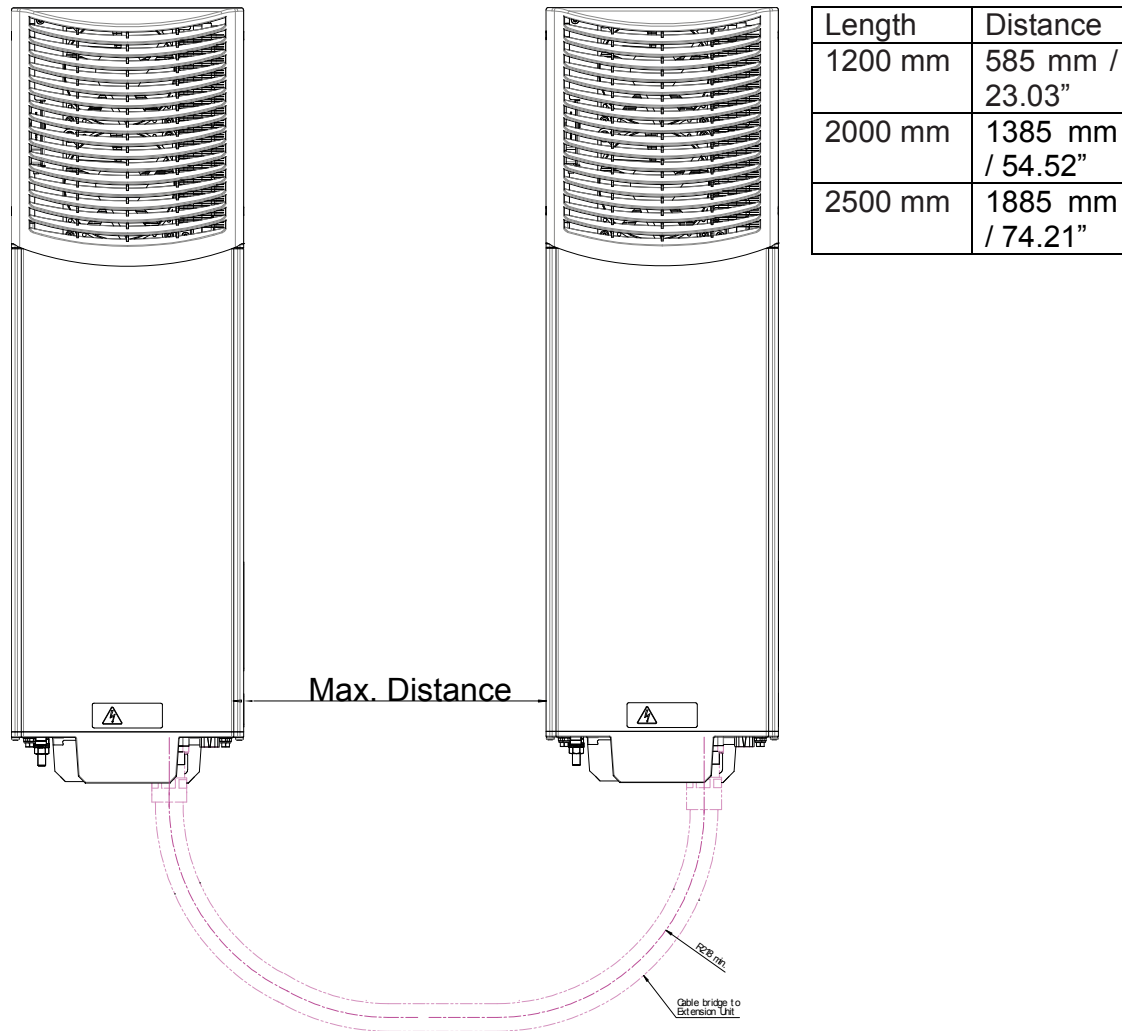

figure 3-1 Maximum distance between RU and EU

### 3.1.4. Wall-Mounting Procedure

- Check the suitability of the wall-mounting kit and the wall.
- Mark the position of the drilling holes (for measurements and a more detailed description refer to the wall mounting plan that is part of the delivery).
- Drill four holes at the marked positions and insert dowels\*.
- Screw the mounting brackets to the wall / dowels using the four dowel screws as illustrated in *figure 3-2 Mounting bracket installation*.
- For each bracket, first screw in the 2 washers, then the 2 spring washers, then the 2 M8x80 screws (see also *figure 3-2 Mounting bracket installation*).
- Hang the Remote Unit into the upper mounting bracket at a slight angle and let it move smoothly towards the wall so that it engages firmly into the brackets (see *figure 3-3 RU wall mounting*). Then, screw the unit to the lower mounting bracket using 2 of the M8x25 screws that are part of the delivery (4 are provided).
- Ensure that there is free access to the electrical connections as well as to the cabinet. The approved bending radius of the connected cables must not be exceeded.

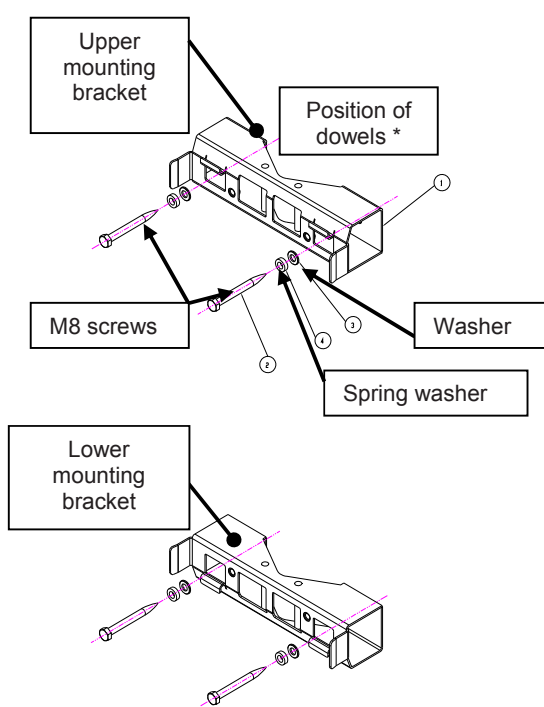

figure 3-2 Mounting bracket installation

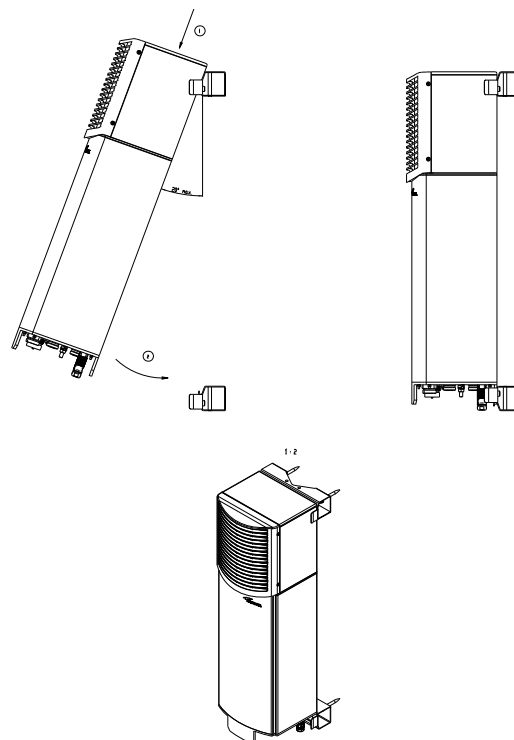

figure 3-3 RU wall mounting

\* The dowels are not part of the delivery since the suitable type depends on the on-site conditions (material of wall). Therefore, use dowels that are appropriate for the mounting surface.

### 3.1.5. Pole Mounting

The following mounting hardware is required for pole mounting:

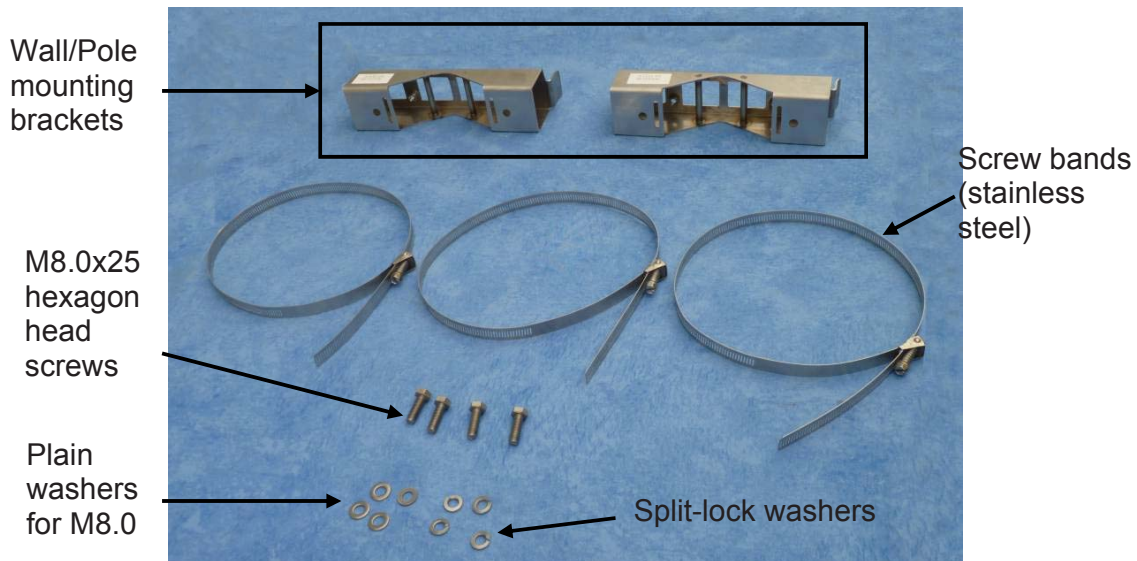

figure 3-4 Pole-mounting kit

**Note:** The screw bands illustrated above are equipped with quick-release snaplock clamps which must be disengaged to be applied. The swivel-action locking of screw to band makes installation and removal fast and easy.

- Use the 3 screw bands with clamps to fasten the two mounting brackets to the pole. Use 2 screw bands fitting next to each other on the upper side and 1 screw band on the lower side.

**Note:** When fastening the mounting brackets make sure that they are installed congruently and not at an angle to each other. To determine the distance between the beams, refer to the wall/ pole mounting plan that is part of the delivery.

- Hang the unit into the hooks of the upper mounting bracket and screw the unit to the lower mounting bracket.

Ensure that there is free access to the electrical connections as well as to the cabinet. The approved bending radius of the connected cables must not be exceeded.

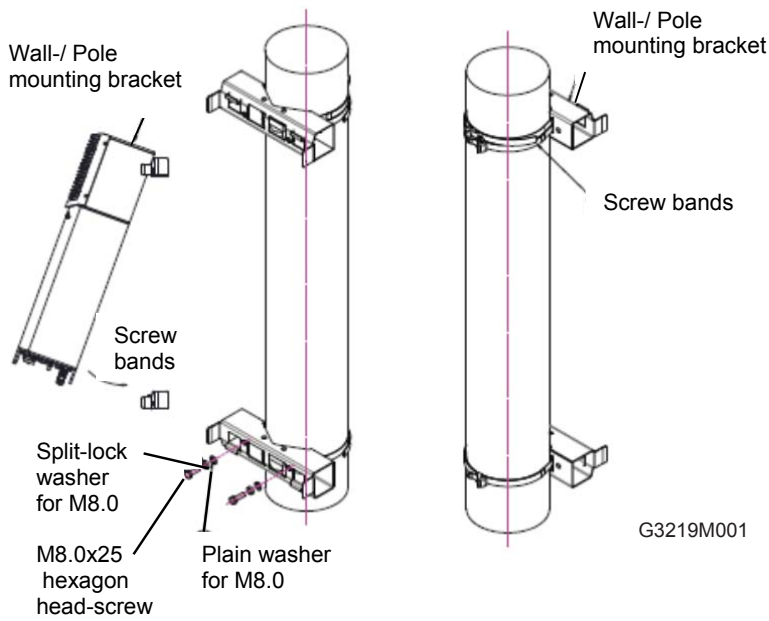
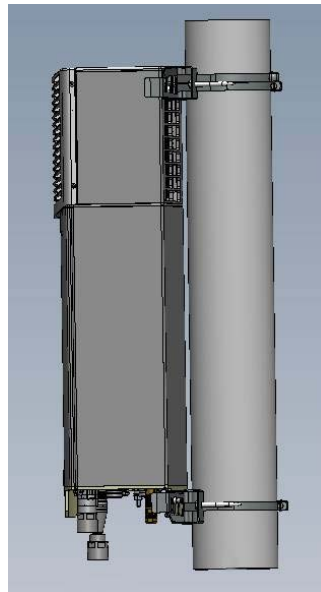

figure 3-5 Pole-mounting, ML-cabinet, assembly drawing

Pole mounting finished  
(RU mounted to pole)



L\_G3219X000

figure 3-6 Pole mounting of RU, finished

### 3.1.6. Mounting of DC Box

The DC Box is pre-mounted on a mounting plate which has to be fastened to the lower mounting bracket of the RU after it has been mounted to a wall or pole as explained in the previous chapters.

Fasten the mounting plate of the DC Box to the lower mounting bracket of the RU using the four pan head screws M4.0x8mm (observe torque of 3.0 N-m) that are part of the delivery:

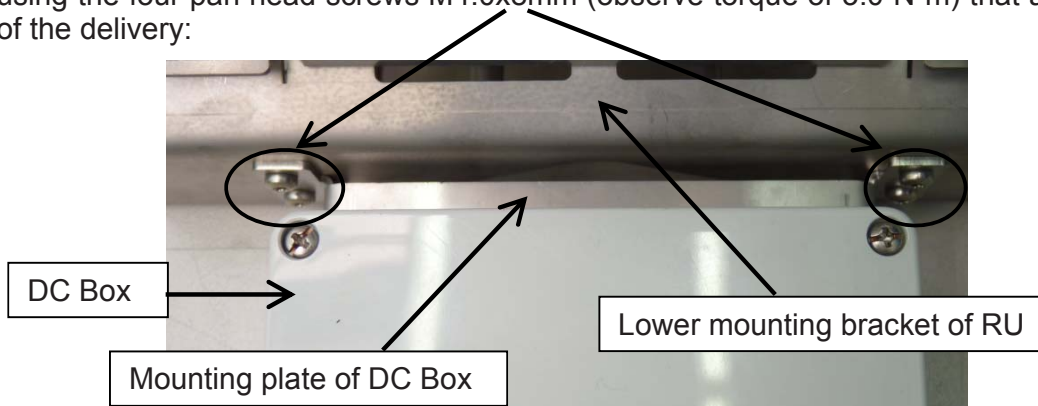

figure 3-7 Mounting of DC Box



figure 3-8 Mounting of DC Box, finished

## 3.2. Electrical Installation

### 3.2.1. Health and Safety for Electrical Installation

Read and observe observe chapter 1.2 *Health and Safety*.



1. **Danger: Electrical hazard. Danger of death or fatal injury from electrical current. Obey all general and regional installation and safety regulations relating to work on high voltage installations, as well as regulations covering correct use of tools and personal protective equipment.**

### 3.2.2. Property Damage Warnings for Electrical Installation

1. **Attention:** It is compulsory to ground (earth) the unit before connecting the power supply. Grounding bolts are provided on the cabinet to connect the ground-bonding cable.
2. **Attention:** If the mains connector of the unit is not easily accessible, a disconnect device in the mains power circuit must be provided within easy reach.
3. **Attention:** A connection of the mains supply to a power socket requires the power socket to be nearby the unit.
4. **Attention:** Before connecting or disconnecting the mains connector at the unit, ensure that mains power supply is disconnected.
5. **Attention:** Make sure that an appropriate circuit breaker acting as a disconnect device (as required by IEC/EN60950-1) and an overcurrent limiting device are connected between mains power and the unit.
6. **Attention:** Incorrectly wired connections can destroy electrical and electronic components.
7. **Notice:** Although the unit is internally protected against overvoltage, it is strongly recommended to ground (earth) the antenna cables close to the antenna connectors of the unit for protection against atmospheric discharge. In areas with strong lightning, it is strongly recommended to install additional lightning protection.
8. **Notice:** To avoid corrosion at the connectors caused by electrochemical processes, the material of the cable connectors must not cause a higher potential difference than 0.6 V (see electrochemical contact series).
9. **Notice:** Use an appropriate torque wrench for the coupling torques:
  - for N-type connectors (2 N-m / 20 in lb) with 13/16 in opening, e. g. item no. 244379 available from the CommScope e-catalog
  - for 7/16 DIN-type (25 N-m / 19 ft lb) with 1 ¼ in opening, e. g. item no. 244377 available from the CommScope e-catalogDo NOT use your hands or any other tool (e.g. a pair of pliers)! This might cause damage to the connector and lead to a malfunction of the unit.



10. **Notice:** For unstabilized electric networks, which frequently generate spikes, the use of a voltage limiting device is advised.
11. **Notice:** The unit complies with Overvoltage Category II. It also complies with the surge requirement according to EN 61000-4-5 (fine protection); however, installation of an additional medium (via local supply connection) and/or coarse protection (external surge protection) is recommended depending on the individual application in order to avoid damage caused by overcurrent.
- For Canada and US, components used to reduce the Overvoltage Category shall comply with the requirements of IEC 61643-series. As an alternative, components used to reduce the Overvoltage Category may comply with ANSI/IEEE C62.11, CSA Certification Notice No. 516, CSA C22.2 No. 1, or UL 1449. Suitability of the component for the application shall be determined for the intended installation.
12. **Notice:** Observe the labels on the front panels before connecting or disconnecting any cables.

### 3.2.3. Connections

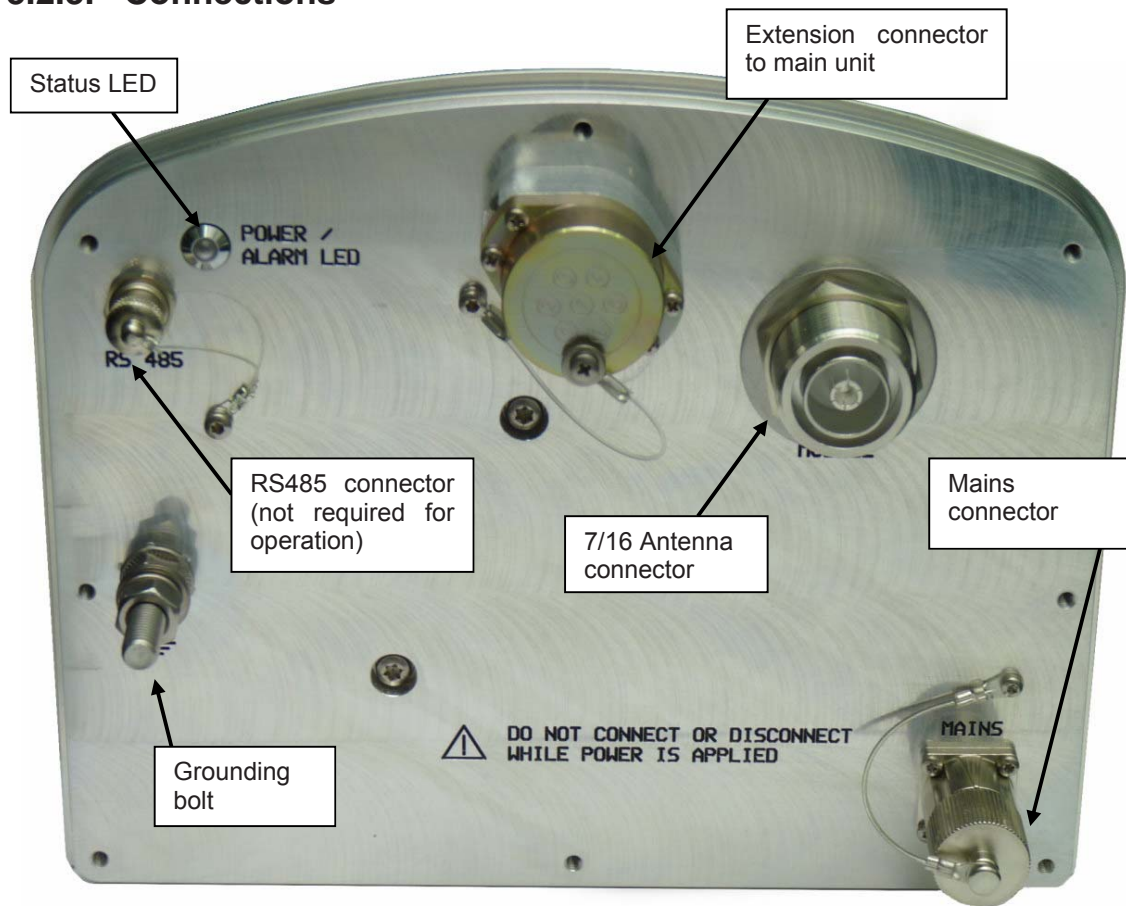

figure 3-9 Connector flange of ION-M7HP/85HP without DC Box

### 3.2.4. Grounding (Earthing)

Grounding must be carried out. Connect an earth-bonding cable to the grounding connection provided at the outside of the unit (see chapter 3.2.3 *Connections*). Do not use the grounding connection to connect external devices.



figure 3-10 Grounding bolt

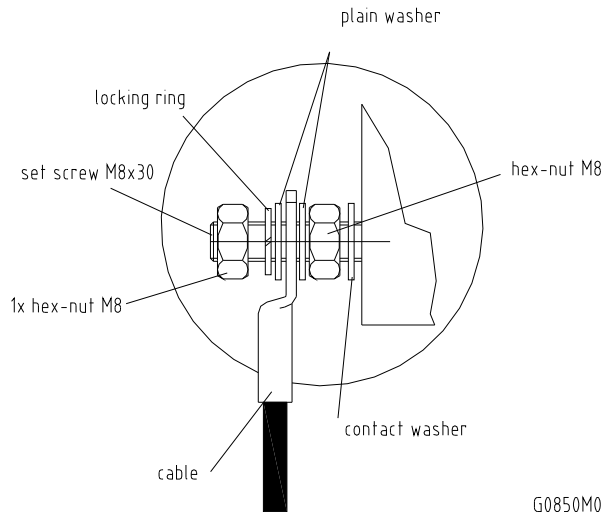

figure 3-11 Grounding bolt, schematic view

After loosening the hex nut, connect the earth-bonding cable between the two washers as illustrated in the figures above. Then, fasten all parts again with the hex nut.

### 3.2.5. Connection of the Antenna Cables

The unit has N-type antenna connectors. Please refer to chapter 3.2.3 *Connections* for its location. Refer to the corresponding documentation of the connector manufacturer for mounting the cable connectors.

The bending radius of the antenna cables must remain within the given specifications.

Choose the type of cable best suited for the antenna. Consider that a cable with higher loss is less expensive but impairs performance.

- Notice:** Use an appropriate torque wrench for the coupling torques:
- for N-type connectors (2 N-m / 20 in lb) with 13/16 in opening, e. g. item no. 244379 available from the *CommScope e-catalog*
  - for 7/16 DIN-type (25 N-m / 19 ft lb) with 1 ¼ in opening, e. g. item no. 244377 available from the *CommScope e-catalog*
- Do NOT use your hands or any other tool (e.g. a pair of pliers)! This might cause damage to the connector and lead to a malfunction of the RU.





**Attention:** To minimize passive inter-modulation (PIM) distortion, attention has to be paid to the physical condition of the connector junctions:

- Do not use connectors that show signs of corrosion on the metal surface.
- Prevent the ingress of water or dirt into the connector.
- Use protective caps for the connectors when not mounted.
- Before mounting clean the connectors with dry compressed air.
- Before mounting clean the mating surfaces of the connector with a lint-free alcohol-drenched cloth on a wooden or non-metallic item.
- Attach and torque the connectors properly.
- Avoid metallic abrasion when mounting the connectors by only screwing the connecting nut, but not turning the whole connector.
- Use a torque wrench to fasten the connector, see above.
- Clean the protective caps before mounting for antenna cable replacement.

### 3.2.6. Cleaning Procedure for RF Cable Connectors

1. What is needed for the cleaning?

- a. Isopropyl alcohol
- b. Compressed air
- c. Lint-free wipe
- d. Cotton buds



2. Remove protective cap from the RF connector.

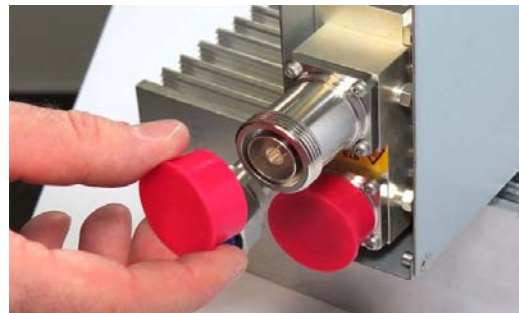

3. Remove metal chips and small particles from the mating and inner surfaces of the connector using compressed air.

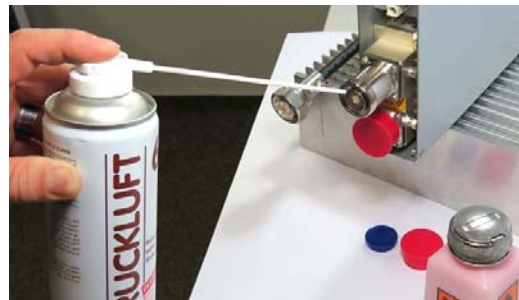

4. Clean the connector winding with lint-free wipe drenched with isopropyl alcohol.



5. Clean the lip of the inner ring with lint-free wipe drenched with isopropyl alcohol.



6. Clean the inside surface of the inner ring with lint-free wipe drenched with isopropyl alcohol.

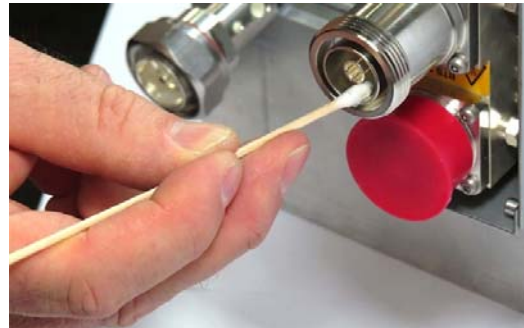

7. Clean the inside of the center conductor spring tines with a cotton bud drenched with isopropyl alcohol.

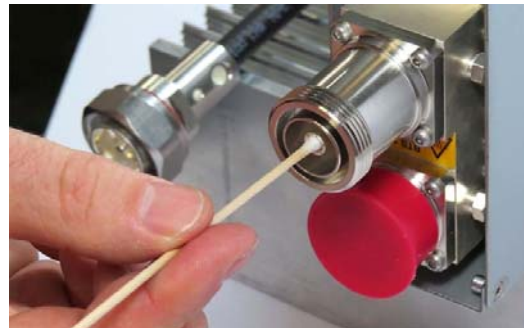

8. Clean in the similar way the connector of the connected cable. Remove protective caps from the unit connector first.



9. Remove metal chips and small particles from the mating and inner surfaces of the connector using compressed air.



10. Continue with the winding area using lint-free wipe drenched with isopropyl alcohol.



11. Continue with the inside mating surface of the inner ring.



12. Clean the outside surface of the center pin.



### 3.2.7. Antenna Cable Connector Assembly

The figures in this chapter illustrate the cleaning procedure and do not show the actual RU.

1. What is needed for the connector assembly?
  - a. Torque wrench.
  - b. (Adjustable) counter wrench



2. Join the connectors and turn the coupling nut until the thread grips.



3. Push in the connector until it clicks.



4. Fasten the coupling nut hand-tight. Do not turn the connector but the coupling nut only.





5. Retain the cable connector with the counter wrench and fasten the coupling nut with the torque wrench until the torque is applied (torque wrench clicks).

For angled antenna connectors use your hand to retain the cable connector and fasten the coupling nut with the torque wrench. Make sure only the coupling nut is turned, not the cable connector.

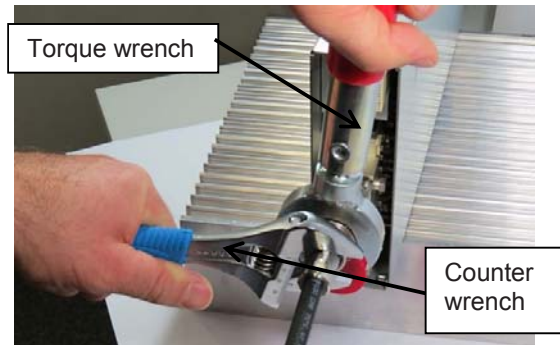

### 3.2.8. Power Connection

Before connecting electrical power to the RU, the system must be grounded as described in the previous section.

Depending on the RU version (AC or DC type) proceed accordingly:

#### 3.2.8.1. AC Power Connection

Mains power must be connected at the mains connector of the unit (see *figure 3-9*).

The power supply plug is part of the delivery. The correct wiring of the power supply plug is as follows:

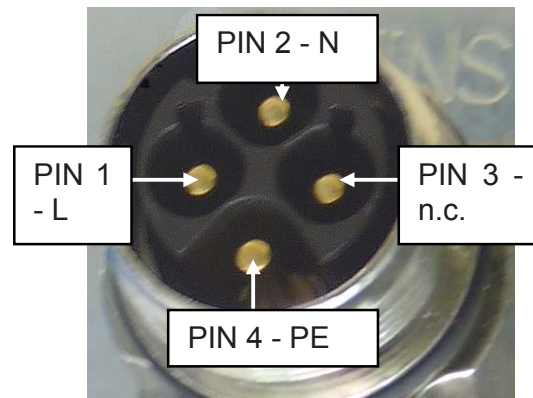

*figure 3-12 Mains connector*

☞ **Note:** For the AC power supply connection, a minimum cross section of 1.5 mm<sup>2</sup> is required. Each wire must observe the applicable national regulations regarding loop impedance, voltage drop, and methods of installation. Make sure to connect the correct voltage to the unit.

☞ **Note:** Do not connect or disconnect the power cord at the mains connector while power is on. Turn off mains power \* before connecting the power cord at the unit, then, engage mains again.

\* Mains power must be interruptible with an external mains breaker. For the mains breaker, observe the following recommendation:

120 Volt / 20 Amp max. or 240 Volt / 16 Amp, single-phase, 50 / 60 Hz AC service is needed, i.e. the external AC breaker should be 20 Amps max. for 120-Volt service or 13 to 16 Amps for 240-Volt service. Always make sure that your local requirements are kept.

With the mains power turned off, the power supply plug must be connected to the unit's Mains connector. The Mains connector's arrow tip and the power supply plug's arrow tip must point to each other as shown in the figure below.

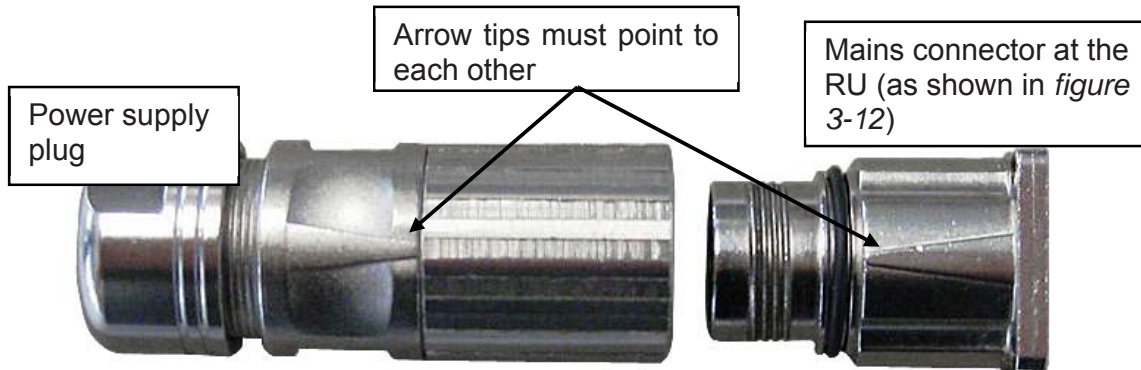

figure 3-13 Power supply plug to RU Mains connector

### 3.2.8.2. DC Power Connection

The DC Box and the RU are already connected. For DC connection, connect your local supply to the DC Box.

- ☞ **Note:** For DC power supply connection, a minimum cross section of 6.6 mm<sup>2</sup> ( $\geq$  AWG 9) per potential is required. To ensure watertightness of the cable gland, a minimum cross section of 9 mm<sup>2</sup> is necessary for the local supply cable. Each wire must observe the applicable national regulations regarding loop impedance, voltage drop, and methods of installation. Make sure to connect the correct voltage to the unit.
- ☞ **Note:** Do not connect or disconnect the local supply cable at the DC Box while power is on. Turn off mains power before connecting the local supply cable, then, engage mains again.
- ☞ **Note:** Mains power must be interruptible with an external mains breaker. For the mains breaker, observe the local regulations of the DC service provider.

First, remove the cover of the box by unscrewing the four screws:

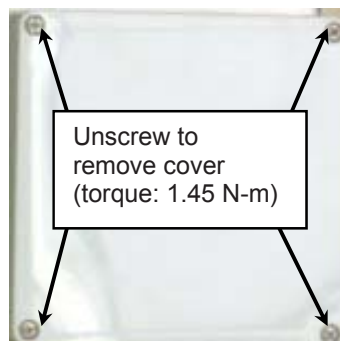

Then, connect your local supply cable by feeding it through a cable gland that should at least provide IP55:

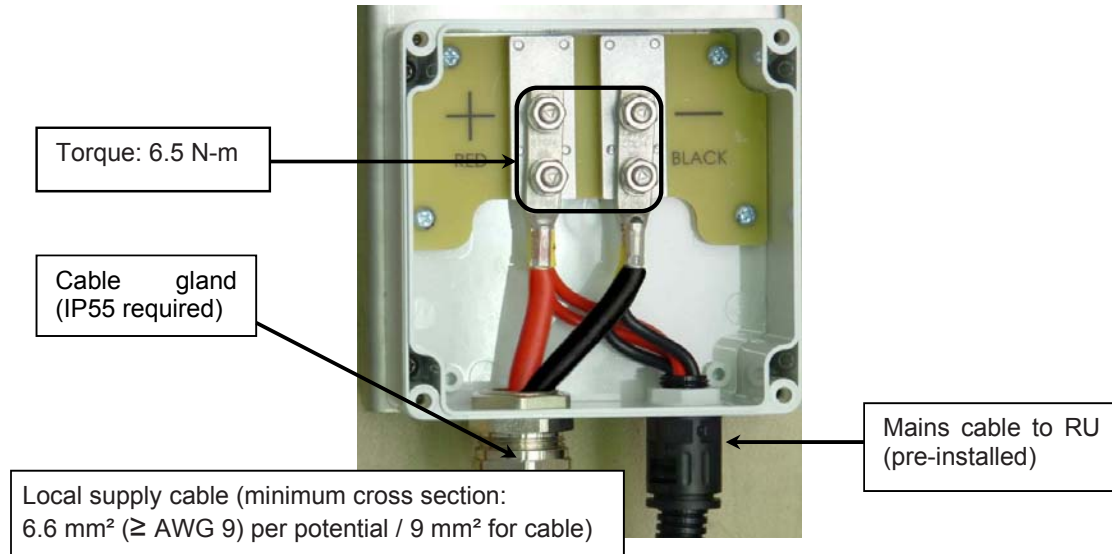

Then, close the cover again (torque: 1.45 N-m).

### 3.2.9. Connection Extension Unit to the Main Unit

In order to connect the Extension Unit (EU) with the Remote Unit (RU), use the cable bridge that has been ordered separately from the supplier (requirements see chapter 3.1.3 *Mounting Distance between RU and EU*). Connect this cable bridge at the extension connector of the RU with the corresponding connector at the EU (illustrated in *figure 3-9*).

**Attention:** To prevent damaging the connectors of the extension port, align the plug end of the connector properly before inserting. Do not twist the connector. When the connector is in place, tighten the screws in a clockwise direction. Particular attention must be paid plugging this connector to maintain the ingress protection class of the Remote Unit.

3.2.10. Flowchart

**Commissioning an ION-M Extension Unit**

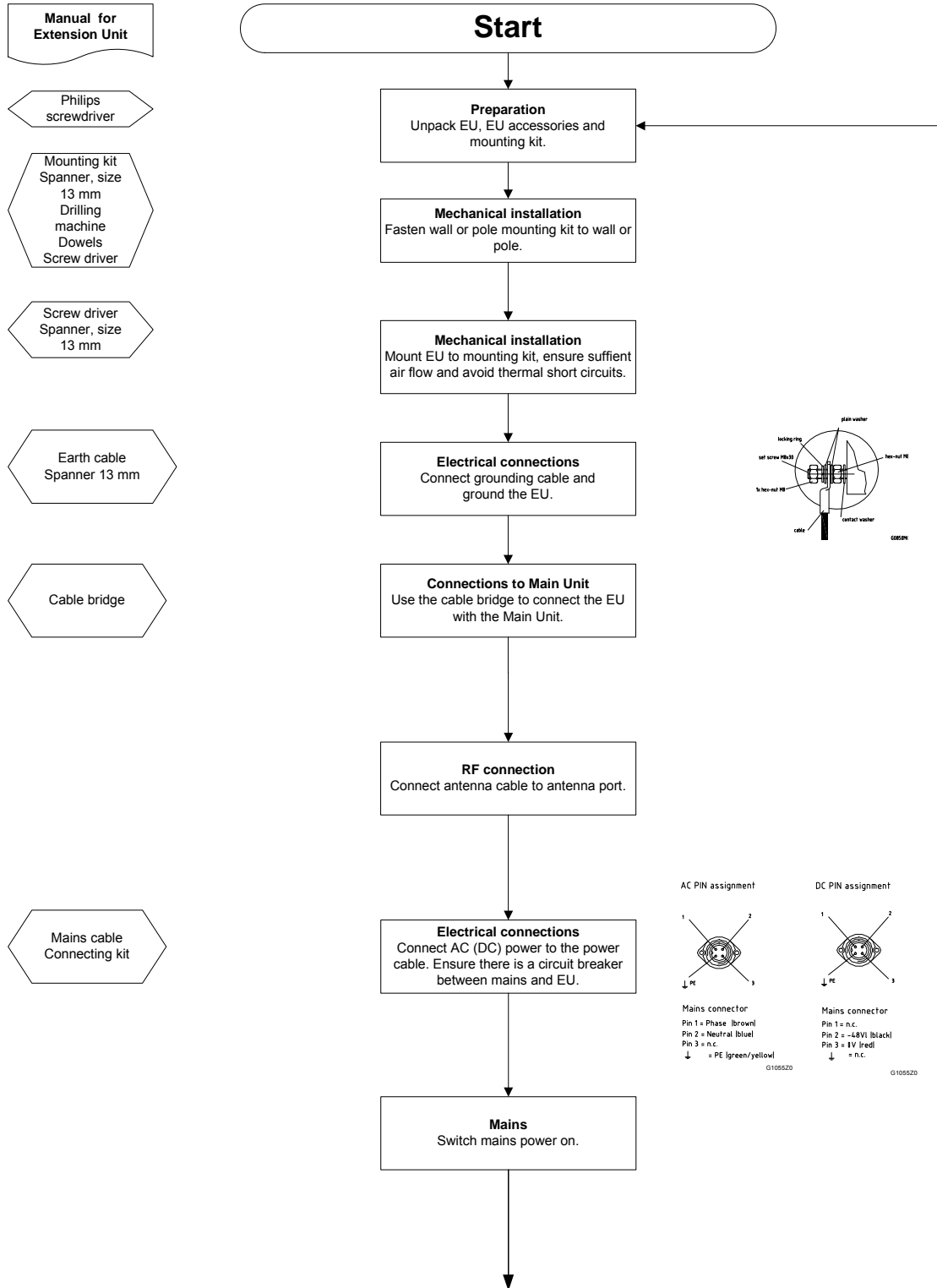



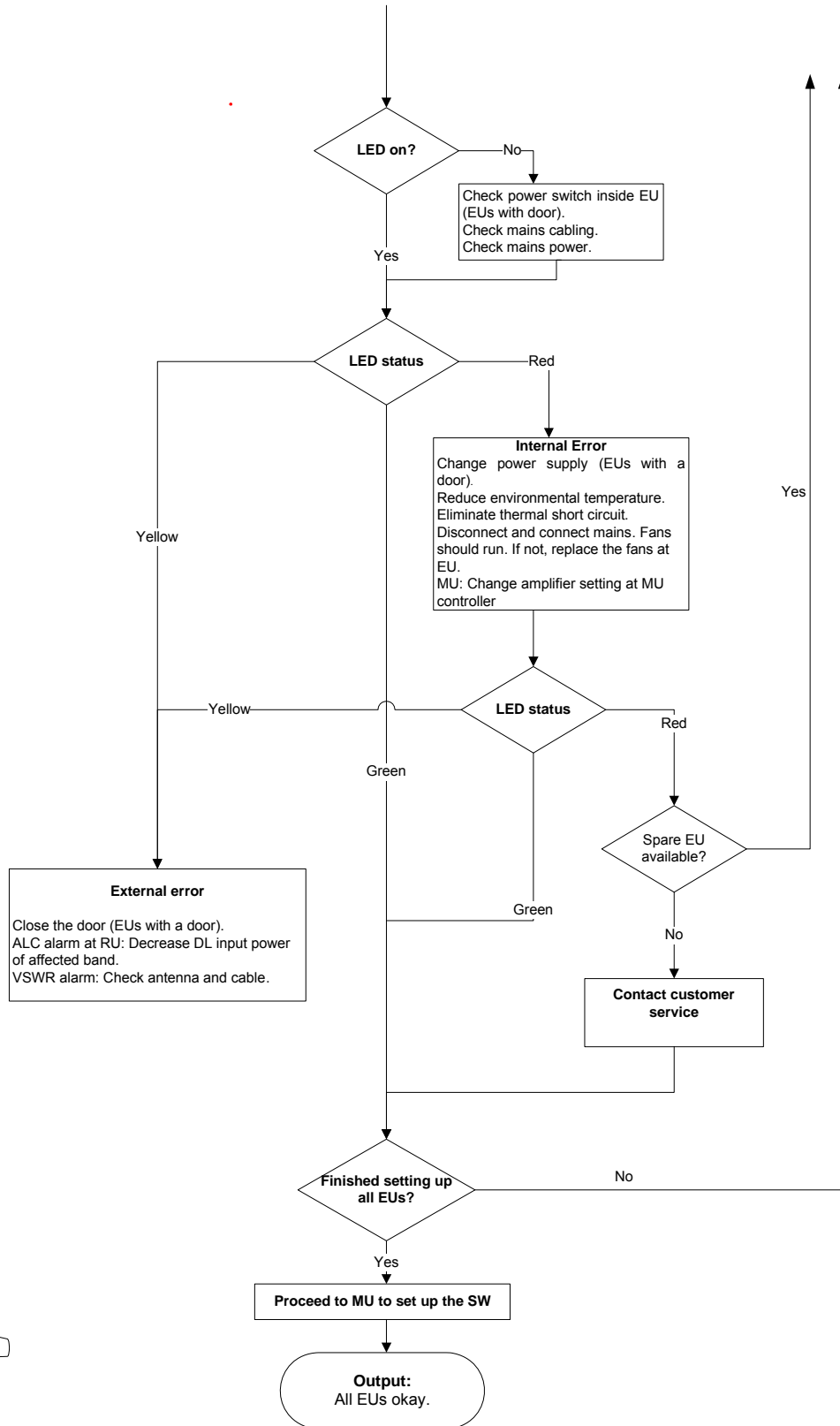

## 4. Alarms and Troubleshooting

All alarms occurring can be checked via software at the Master Unit to where a message is transmitted when the software acknowledges a valid alarm.

A new alarm message will not be repeated if the reason for the alarm is cleared or if the alarm continues.

A new alarm message will be generated if the alarm is interrupted for at least five seconds after acknowledgement.

Refer to the corresponding software documentation of the Master Unit for details.

For local supervision, a status LED on the connector flange of the unit (position see section 3.2.3 *Connections*) gives an indication of possible reasons for alarms. This table shows possible on-site measures that could be checked before referring to the Master Unit alarm list.

<b>Status LED Indication</b>	<b>Alarms</b>	<b>Possible on-site measures</b>
Green	No alarm → Status ok	
Orange	<i>Alarms not directly related to RU:</i>	
	ALC alarm	<i>(MU: Decrease DL input power of affected band).</i>
Red	<i>Alarms directly related to EU:</i>	
	Power 28 V	Replace the affected unit.
	Temperature	Reduce environmental temperature. Eliminate thermal short circuit.
	Fan	Disconnect and connect mains. Fans should run. If not, replace the fans at RU.
	I <sup>2</sup> C	Disconnect and connect mains.
	Amplifier “Power Down”	<i>(MU: Change amplifier setting at MU controller).</i>
Status LED off	Mains	Check mains cabling. Check mains power.

*table 4-1 Status LED alarms*

The status of the Extension Unit can be checked via the Master Unit (for details please refer to the software manual of the Master Controller).

Explicit troubleshooting is also available in the MU software (software manual or WEB Interface).

## 5. Maintenance

### 5.1. General

Read and observe chapter *1.2 Health and Safety*.









**Caution:** Rotating fans. Risk of injury in operation. Wear tight-fitting clothes and disconnect mains before connecting or replacing or cleaning the fan unit.



**Caution:** The unit reaches high temperature in operation. Risk of burns by hot surface. Do not touch the unit before it has sufficiently cooled down.

Due to the design of the Extension Unit the only component recommended to be replaced is the fan unit. The spare parts list, consequently, contains only units which can be replaced without tuning or soldering work. For replacing any other component, please contact the supplier.

Take care not to unintentionally damage any seals to maintain warranty. Please keep these guidelines in mind during maintenance:

-  **Note:** The Extension Unit does not require preventative maintenance measures.
-  **Note:** We recommend checking the cleanliness of the unit and in particular of the heat sink / fan(s) at appropriate intervals depending on the degree of dust and dirt at the installation site. If necessary, any dusty or dirty areas / parts should be cleaned at regular intervals, which also depend on the degree of dust and dirt at the installation site.
-  **Note:** Ensure the Extension Unit has been disconnected from mains power during maintenance.
-  **Note:** When sending back the unit, use appropriate packaging (see also section *6.2.2 Mechanical Specifications* for details). Use of the original packaging for shipping the unit is strongly recommended.
-  **Note:** Defective parts should only be replaced by original parts from the supplier. All service work performed inside the housing is performed at the users own risk.
-  **Note:** Label any unlabelled cables before disconnecting them to ensure correct reconnection.

For most maintenance procedures, appropriate tools are required to ensure correct handling. All of these tools can be ordered from the supplier.

-  **Note:** All Extension Unit screws have a right-hand thread, and are tightened by turning the screws clockwise and loosened by turning them counter-clockwise with an appropriate tool.

## 5.2. Replacing the Fan Unit

Replacement of the fan unit is not required as a preventative measure. Only if an alarm indicates a malfunctioning of a fan, must the unit be exchanged.

- ☞ **Note:** Please observe that the fan unit can only be replaced as a whole. Do not remove the fans separately.
- ☞ **Note:** NEVER blow out the fan unit with compressed air. This would cause permanent damage to the unit.

Read and observe chapter 1.2 *Health and Safety* as well as the instructions in section 5.1 *General* before starting with the replacement.

1. **Switch off the Extension Unit. Make sure the power supply connector is disconnected for the following replacement procedure.** Then, proceed as follows:
2. Remove the fan guard by unscrewing (Torx 20) the four countersunk-head screws (two at each side) by which it is fastened:<sup>1)</sup>



3. Loosen the four fillister-head screws M4x8 by which the fan unit is screwed to the cabinet (circle-marked in the figure to the right).<sup>2)</sup>
4. Disconnect the fan-unit connector and take out the fan unit.
5. To mount the new fan unit, re-connect the fan unit connector and place the fan unit back into its original position.
6. Screw the whole fan unit to the cabinet with the four fillister-head screws M4x8.<sup>2)</sup>
7. Finally mount the fan guard and fasten it with the four countersunk head screws.<sup>1)</sup>
8. Then, mains power can be reconnected and the unit can be powered up.

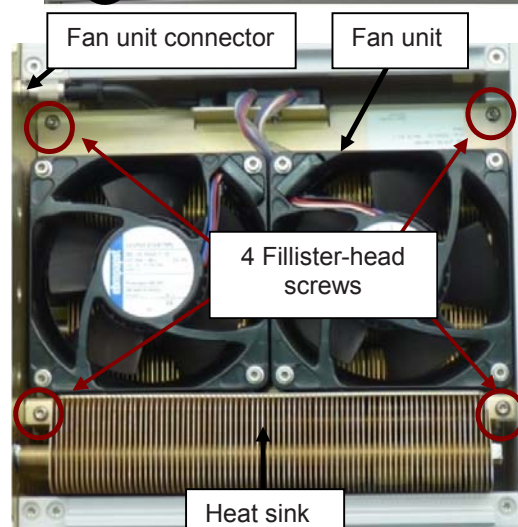

figure 5-1 Fan unit and heat sink

<sup>1)</sup> In order not to exceed the specified torque of 0.82 N-m, use an appropriate tool.

<sup>2)</sup> In order not to exceed the specified torque of 3.3 N-m, use an appropriate tool.

### 5.3. Cleaning the Heat Sink

To avoid a malfunctioning of the Extension Unit, the heat sink should be cleaned in case of pollution. In order to prevent any damage, proceed as explained in the following.

☞ **Note:** Read and observe chapter 1.2 *Health and Safety* as well as the instructions in section 5.1 *General* before starting with the replacement procedure. Then, proceed as follows:

1. Switch off the Extension Unit. For the following procedure ensure that power supply connector has been disconnected before and that the fans have stopped rotating.
2. Before any cleaning action, **remove** the fan guard **and the fan unit** from the Extension Unit as described in the previous section 5.2 *Replacing the Fan Unit*.
3. Clean the ribs of the heat sink (see *figure 5-1 Fan unit and heat sink*) very carefully with a **soft** brush (not metallic!). **Take care that the material is not scratched or damaged.**
4. If necessary, **use compressed air** (max. 5 bar) **to blow out the heat sink** from front to rear side.
5. In case the dirt cannot be blown out completely from the heat sink and parts of it, still stick to the ribs, clean the parts concerned carefully from the front with the **soft** brush. **Take care that the material is not scratched or damaged.**
6. After cleaning the heat sink, mount the fan unit and the fan guard again according to section 5.2 *Replacing the Fan Unit*. Then, reconnect mains power and power up the unit.

## 6. Appendix

### 6.1. Illustrations

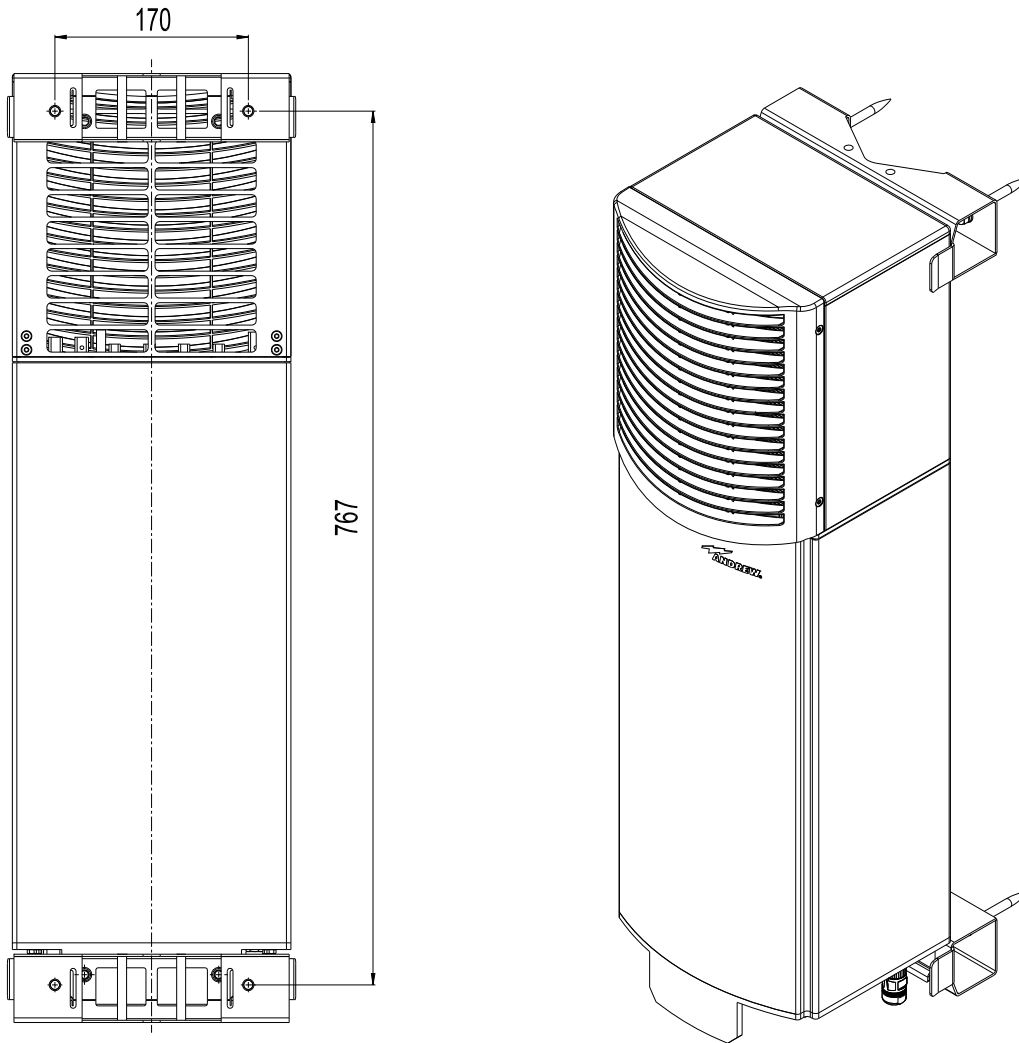

G3219M0

figure 6-1 Cabinet drawing (without DC Box)

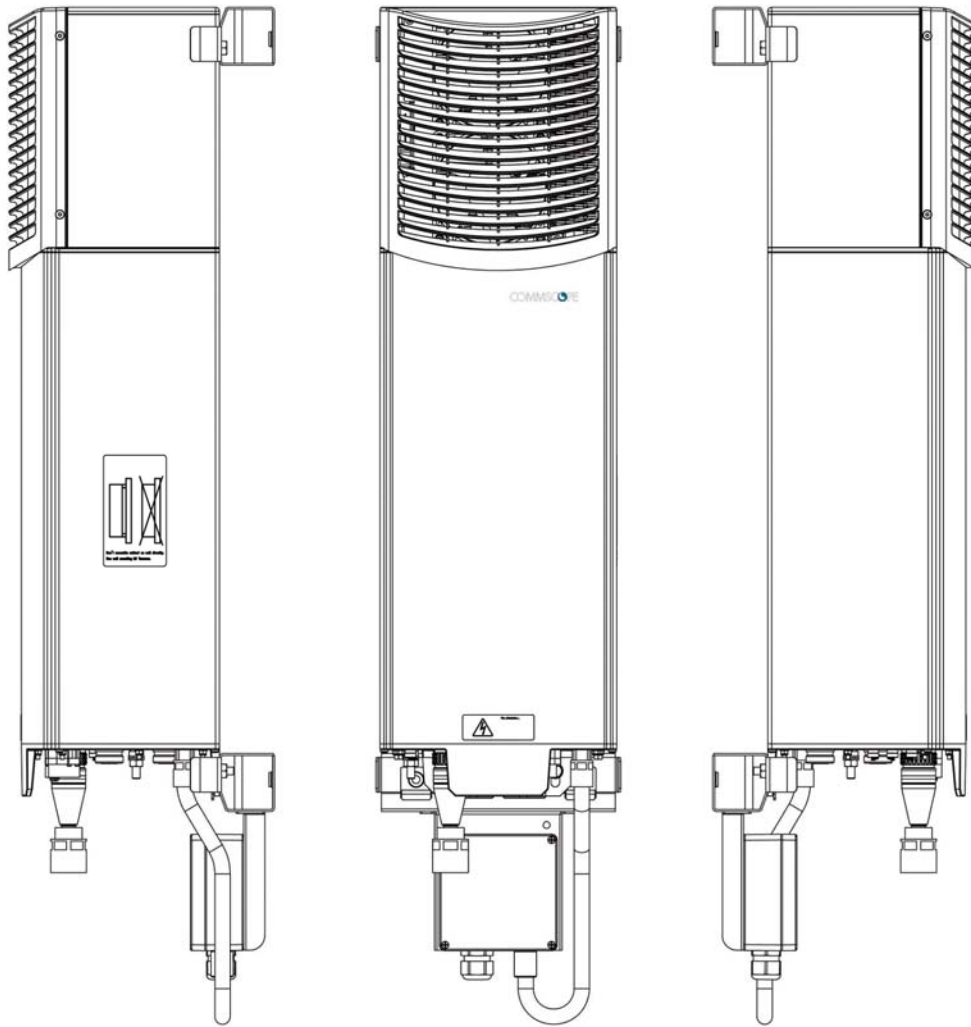

figure 6-2 Cabinet drawing (with DC Box)

## 6.2. Specifications

### 6.2.1. Electrical Specifications

ION-M7HP/85HP EU			
Electrical			
Power supply	Mains power, AC	nominal	100 Vac to 240 Vac
		operating	85 Vac to 264 Vac
	Mains power, DC	nominal	48 Vdc to 60 Vdc
		operating	36 Vdc to 72 Vdc
	Power consumption	max. temp., fully loaded	900 W
		room temp., idle	380 W
Optical			
Connectors (main unit)		E2000/APC 8°	
Optical return loss		45 dB	
Fiber type		Single mode E9/125 mm	
Optical link budget		0 dB to 10 dB	

### 6.2.2. Mechanical Specifications

Height, width, depth *	AC Version	817 x 245 x 218 mm (32.2 x 9.6 x 8.6 in)
	DC Version	1053 x 245 x 218 mm (41.5 x 9.6 x 8.6 in)
Weight	RU	40 kg (88.2 lb)
	DC Box	1 kg (2.2 lb)

\* Spacing required: 40 mm (1.58 in) around unit (with or without DC Box)

**All data is subject to change without notice.**

### 6.2.3. Environmental and Safety Specifications

**Note:** For detailed information, please refer to the Environmental and Safety Specifications leaflet of the supplier, related to ETS 300 019 (European Telecommunication Standard).

Operating temperature range		-33° C to +50° C
Ingress protection	RF part	IP67
	Fan part	IP55
	RF and fan part	UL50 R3
	DC Box	IP55

**All data is subject to change without notice.**



### 6.3. Spare Parts

The following list contains all parts available for the Extension Unit. The configuration of the delivered unit meets the requirements of the customer and can differ depending on the state of the delivery.

Maintenance of the RU should be performed on an FRU (Field Replaceable Unit) basis only. Do not damage the warranty labels on the components, as this voids the warranty.

If any FRU not contained in the following list needs to be replaced, please contact customer service for additional instructions.

#### Spare Parts List of the Extension Unit ION-M7HP/85HP

Designations:	ID No:
<i><b>ION-M7HP/85HP</b></i>	<b>7693966</b>
Fan Unit ML-Cabinet	7632532-00
Manuals for ION-M7HP/85HP	7694409-00
Protective Plug E2000	7160013
Protective Cap E 2000	7158914

<b>Accessories</b>	
Alarm Kit	7157396
Cable Bridge RF/DC 7/7 PIN 1200mm	7604870-xx
Cable Bridge RF/DC 7/7 PIN 2000mm	7652177-xx
Cable Bridge RF/DC 7/7 PIN 2500mm	7691956-xx
Pole Mounting Kit ML-Cabinet	7636344
Pole Mounting Kit DC-Box ML-Cabinet	7690786
Wall Mounting Kit ML-Cabinet	7632566
Wall Mounting Kit DC-Box ML-Cabinet	7690785

The manufacturer reserves the right to replace the spare parts listed above by equivalent substitutes.

☛ **Note:** Only the spare parts listed above are FRUs (= Field Replaceable Units) and can be replaced by the user. For replacement of any other parts, please send the entire Extension Unit back to the manufacturer.

## 7. Index

<b>A</b>	
Alarms .....	34
List .....	34
<b>C</b>	
CE Declaration of Conformity (DoC).....	10
Cleaning the Heat Sink .....	37
Commissioning	
General .....	15
CommScope.....	10
Compliance .....	8
Connections	
Antenna .....	24
Connector Flange.....	23
EU with Main Unit.....	31
Power .....	29
Contact Addresses, Customer Support .....	11, 12
<b>D</b>	
Declaration of Conformity (DoC).....	10
<b>G</b>	
Grounding (Earthing).....	24
<b>H</b>	
Health and Safety.....	7
<b>I</b>	
Illustrations .....	38
<b>M</b>	
Installation	
Distance between Units.....	17
Electrical .....	22
Mechanical.....	15
<b>M</b>	
Maintenance .....	35
Mounting	
Pole .....	19
Wall .....	18
<b>P</b>	
Property Damage Warnings .....	7
<b>R</b>	
Replacement of Fan Unit.....	36
<b>S</b>	
Spare Parts .....	41
Specifications	
Environmental and Safety .....	40
Mechanical.....	40
Status LED.....	34
<b>T</b>	
Troubleshooting .....	34

COMMSCOPE®

POWERED BY

