

Optical Remote Unit ION[®]-M7P/17HP & Sub-Assemblies



(M-cabinet)

**User's Manual
MF0145AQA**

© Copyright 2013 CommScope, Inc.

All rights reserved.

All information contained in this manual has been revised thoroughly. Yet CommScope accepts no liability for any omissions or faults.

CommScope reserves the right to change all hardware and software characteristics without notice.

Names of products mentioned herein are used for identification purposes only and may be trademarks and / or registered trademarks of their respective companies.

No parts of this publication may be reproduced, stored in a retrieval system, transmitted in any form or by any means, electronic, mechanical photocopying, recording or otherwise, without prior written permission of the publisher.

Andrew Wireless Systems GmbH, 28-August-2013

TABLE OF CONTENTS

1. GENERAL	7
1.1. USED ABBREVIATIONS	7
1.2. HEALTH AND SAFETY WARNINGS	8
1.3. ABOUT COMMSCOPE	11
1.4. INTERNATIONAL CONTACT ADDRESSES FOR CUSTOMER SUPPORT	12
2. INTRODUCTION	15
2.1. PURPOSE	15
2.2. THE ION-M7P/17HP	15
3. FUNCTIONAL DESCRIPTION	17
3.1.1. Fan-Protection Kit	17
3.1.2. Accessories	17
4. COMMISSIONING	19
4.1. MECHANICAL INSTALLATION	19
4.1.1. General	19
4.1.2. Wall-Mounting Procedure	21
4.1.3. Pole-Mounting Procedure	22
4.1.4. Mounting of Fan Protection	24
4.2. ELECTRICAL INSTALLATION	25
4.2.1. General	25
4.2.2. Connections	26
4.2.3. Grounding	27
4.2.4. Power Connection	27
4.3. CONNECTION OF THE ANTENNA CABLES	28
4.4. OPTICAL FIBER CABLE CONNECTION RULES	29
4.4.1. Protective Plug	31
4.4.2. Protective-Tube Kit	33
4.5. COMMISSIONING	35
5. ALARMS	38
5.1. BITE AND ALARMS	38
5.2. HANDLING OF ALARMS	38
5.3. ALARM STATUS	38

5.4.	STATUS LED ALARMS	38
5.5.	EXTERNAL ALARM INPUTS AND OUTPUTS	39
5.6.	TROUBLESHOOTING	41
6.	MAINTENANCE	42
6.1.	GENERAL	42
6.2.	REPLACING THE FAN UNIT	43
6.3.	CLEANING THE HEAT SINK	45
7.	APPENDIX	46
7.1.	ILLUSTRATIONS	46
7.2.	SPECIFICATIONS	47
7.2.1.	Electrical Specifications	47
7.2.2.	Mechanical Specifications	47
7.2.3.	Environmental and Safety Specifications	47
7.3.	SPARE PARTS	48
8.	INDEX	49

FIGURES AND TABLES

figure 4-1 Wall mounting, (metric dimensions) 21
figure 4-2 Pole-mounting kit..... 22
figure 4-3 Pole mounting (metric dimensions)..... 23
figure 4-4 Mounting procedure for fan protection, (metric dimensions) 24
figure 4-5 Connector flange of ION-M7P/17HP 26
figure 4-6 Grounding bolt with loosened hex nut..... 27
figure 4-7 Grounding bolt, schematic view 27
figure 4-8 AC mains plug 28
figure 4-9 Protective-plug assembly 31
figure 4-10 Tube-kit installation 34
figure 5-1 Flange connector, 5 poles..... 39
figure 5-2 Flange connector, 7 poles..... 39
figure 5-3 Alarm inputs and outputs, standard 40
figure 7-1 Installation drawing..... 46

table 1-1 List of international contact addresses 14
table 4-1 Specified torques 20
table 5-1 Status LED alarms..... 39

For your notes:

1. GENERAL

1.1. USED ABBREVIATIONS

3GPP	3 rd Generation Partnership Project
AC/DC	Alternating current / Direct Current
AIMOS	Andrew Integrated Management and Operating System
ALC	Automatic Level Control
BITE	Built-In Test Equipment
BTS	Base Transceiver Station
CE	"Conformité Européenne" ("European Conformity")
CD	Compact Disk
CFR	Code of Federal Regulations
CPD	Channel Power Detection
DL	Downlink
DoC	Declaration of Conformity
EDGE	Enhanced Data Rates for GSM Evolution
EN	European Norm
EP	Extension Port
ESD	Electrostatic Discharge
ETS	European Telecommunication Standard
EU	Extension Unit
GSM	Global System for Mobile Communication
GND	Ground
GUI	Graphical User Interface
ICP3	Intercept Point 3 rd order
ID No	Identification Number
ION	Intelligent Optical Network
IP	Ingress Protection
ISO	International Organization for Standardization
LED	Light Emitting Diode
LMT	Local Maintenance Terminal
LTE	Long Term Evolution
MIMO	Multiple Input Multiple Output
MS	Mobile Station
MU	Main Unit
NF	Noise Figure
OTRx	Optical Transceiver = SRMU (Subrack Master Unit)
PDU	Power Distribution Unit
PG	Packing Gland
PIM	Passive Intermodulation
R&TTE	Radio & Telecommunications Terminal Equipment
Rev	Revision
RF	Radio Frequency
RU	Remote Unit
RX	Receiver
SNMP	Simple Network Management Protocol
TS	Technical Specification
TX	Transmitter
UL	Uplink
UMTS	Universal Mobile Telecommunication System
UPS	Uninterruptible Power Supply
VSWR	Voltage Standing Wave Ratio
WCDMA	Wideband Code Division Multiple Access
WDM	Wavelength Division Multiplex

1.2. HEALTH AND SAFETY WARNINGS



1. **Danger:** Obey all general and regional installation and safety regulations relating to work on high voltage installations, as well as regulations covering correct use of tools and personal protective equipment.

2. **Danger:** Before opening the unit, disconnect mains power.



3. **Danger:** Laser radiation! Do not stare into the beam; do not view it directly or with optical instruments.

4. **Danger:** Due to power dissipation, the remote unit may reach a very high temperature. Do not operate this equipment on or close to flammable materials. Use caution when servicing the unit.

5. **Warning:** Read and obey all the warning labels attached to the unit. Make sure that all warning labels are kept in a legible condition. Replace any missing or damaged labels.

6. **Warning:** It is the responsibility of the network provider to implement prevention measures to avoid health hazards associated with radiation from the antenna(s) connected to the unit.

7. **Warning:** Make sure, access is restricted to qualified personnel.

8. **Warning:** Only license holders for the respective frequency range are allowed to operate this unit.

9. **Warning:** Make sure the repeater settings are correct for the intended use (refer to the manufacturer product information) and regulatory requirements are met.

10. **Warning:** Use this equipment only for the purpose specified by the manufacturer. Do not carry out any modifications or fit any spare parts, which are not sold or recommended by the manufacturer. This could cause fires, electric shock, or other injuries.

11. **Warning:** For installations which have to comply with European EN50385 exposure compliance requirements, the following Power Density limits/guidelines (mW/cm²) according to ICNIRP are valid:

- 0.2 for frequencies from 10 MHz to 400 MHz
- F (MHz) / 2000 for frequencies from 400 MHz to 2 GHz
- 1 for frequencies from 2 GHz to 300 GHz

12. **Warning:** For installations, which have to comply with FCC RF exposure requirements, the antenna selection and installation must be completed in a way to ensure compliance with those FCC requirements. Depending on the RF frequency, rated output power, antenna gain, and the loss between the repeater and antenna, the minimum distance D to be maintained between the antenna location and human beings is calculated according to this formula:

$$D_{[cm]} = \sqrt{\frac{P_{[mW]}}{4 * \pi * PD_{[mW/cm^2]}}}$$

where

- P (mW) is the radiated power at the antenna, i.e. the max. rated repeater output power in addition to the antenna gain minus the loss between the repeater and the antenna.
- PD (mW/cm²) is the allowed Power Density limit acc. to 47 CFR 1.1310 (B) for general population / uncontrolled exposures which is
 - F (MHz) / 1500 for frequencies from 300MHz to 1500MHz
 - 1 for frequencies from 1500MHz to 100.000MHz

RF exposure compliance may need to be addressed at the time of licensing, as required by the responsible FCC Bureau(s), including antenna co-location requirements of 1.1307(b)(3).

13. **Caution:** Installation of this equipment is in full responsibility of the installer, who has also the responsibility, that cables and couplers are calculated into the maximum gain of the antennas, so that this value, which is filed in the FCC Grant and can be requested from the FCC data base, is not exceeded. The industrial boosters are shipped only as a naked booster without any installation devices or antennas as it needs for professional installation.
14. **Caution:** Only suitably qualified personnel are allowed to work on this unit and only after becoming familiar with all safety notices, installation, operation and maintenance procedures contained in this manual.
15. **Caution:** Keep operating instructions within easy reach and make them available to all users.
16. **Caution:** Corresponding local particularities and regulations must be observed. For national deviations, please refer to the respective documents included in the manual CD that is delivered with the unit.
17. **Caution:** Although the remote unit is internally protected against overvoltage, it is strongly recommended to ground (earth) the antenna cables close to the repeater's antenna connectors for protection against atmospheric discharge.
18. **Caution:** ESD precautions must be observed! Before commencing maintenance work, use the available grounding (earthing) system to connect ESD protection measures.



19. **Note:** For a Class A digital device or peripheral:

This equipment has been tested and found to comply with the limits for a Class A digital device, pursuant to part 15 of the FCC Rules. These limits are designed to provide reasonable protection against harmful interference when the equipment is operated in a commercial environment. This equipment generates, uses, and can radiate radio frequency energy and, if not installed and used in accordance with the instruction manual, may cause harmful interference to radio communications. Operation of this equipment in a residential area is likely to cause harmful interference in which case the user will be required to correct the interference at his own expense.

20. **Note:** This unit complies with European standard EN60950.

Equipment Symbols Used / Compliance

Please observe the meanings of the following symbols used in our equipment and the compliance warnings:

Symbol	Compliance	Meaning / Warning
---	FCC	WARNING. This is NOT a CONSUMER device. It is designed for installation by FCC LICENSEES and QUALIFIED INSTALLERS. You MUST have an FCC LICENSE or express consent of an FCC Licensee to operate this device. Unauthorized use may result in significant forfeiture penalties, including penalties in excess of \$100,000 for each continuing violation.
	CE	Alert sign to R&TTE To be sold exclusively to mobile operators or authorized installers – no harmonized frequency bands, operation requires license. Intended use: EU and EFTA countries
CE 0700		Indicates conformity with the R&TTE directive 1999/5/EC certified by the notified body no. 0700.

1.3. ABOUT COMMSCOPE

CommScope is the foremost supplier of one-stop, end-to-end radio frequency (RF) solutions. Part of the *CommScope* portfolio are complete solutions for wireless infrastructure from top-of-the-tower base station antennas to cable systems and cabinets, RF site solutions, signal distribution, and network optimization.

CommScope has global engineering and manufacturing facilities. In addition, it maintains field engineering offices throughout the world.

Andrew Wireless Systems GmbH based in Buchdorf/ Germany, which is part of *CommScope*, is a leading manufacturer of coverage equipment for mobile radio networks, specializing in high performance, RF and optical repeaters. Our optical distributed networks and RF repeater systems provide coverage and capacity solution for wireless networks in both indoor installations and outdoor environments, e.g. tunnels, subways, in-trains, airport buildings, stadiums, skyscrapers, shopping malls, hotels and conference rooms.

Andrew Wireless Systems GmbH operates a quality management system in compliance with the requirements of ISO 9001 and TL 9000. All equipment is manufactured using highly reliable material. To maintain highest quality of the products, comprehensive quality monitoring is conducted at all fabrication stages. Finished products leave the factory only after a thorough final acceptance test, accompanied by a test certificate guaranteeing optimal operation.

This product meets the requirements of the R&TTE directive and the Declaration of Conformity (DoC) itself. A current version of the CE DoC is included in this manual CD delivered *. Any updated version of the DoC is available upon request from the local sales offices or directly from *CommScope* via the local Customer Support at one of the addresses listed in the following chapter.

According to the DoC, our "CE"-marked equipment can be used in all member states of the European Union.

☞ **Note:** **Exceptions of and national deviations from this intended use may be possible. To observe corresponding local particularities and regulations, please refer to the respective documents (also in national language) which are included in the manual CD delivered.**

* In case the Declaration of Conformity (DoC) for the product was not included in the manual CD delivered, it is available upon request from the local sales offices or directly from *CommScope* at one of the addresses listed in the following chapter.

To make the most of this product, we recommend you carefully read the instructions in this manual and commission the system only according to these instructions.

For technical assistance and support, please also contact the local office or *CommScope* directly at one of the addresses listed in the following chapter.

1.4. INTERNATIONAL CONTACT ADDRESSES FOR CUSTOMER SUPPORT

Americas:

Canada	
CommScope Canada	
Mail	505 Consumers Road, Suite 803 Toronto M2J 4V8 Canada
Phone	+1-905-878-3457 (Office) +1-416-721-5058 (Cell)
Fax	+1-905-878-3297
E-mail	Peter.Masih@commscope.com, wisupport@commscope.com

United States	
Andrew LLC, A CommScope Company	
Mail	620 North Greenfield Parkway Garner, NC 27529 U.S.A.
Phone	+1-888-297-6433
Fax	+1-919-329-8950
E-mail	wisupport@commscope.com

Caribbean & South American Region (CALA)	
CommScope Cabos do Brasil Ltda.	
<i>CALA Tech Support for Distributed Coverage & Capacity Solutions (DCCS) products:</i>	
Mail	Rua Guaporanga, 49 Praça Seca – Rio de Janeiro – RJ ZIP: 21320-180 Brazil
Phone	+1-815-546-7154 (Cell) +55-15-9104-7722 (Office)
Fax	+ 55-15-2102-4001
E-mail	wisupport@commscope.com

Caribbean (CALA) & Central American Region	
CommScope Mexico S.A. de C.V.	
<i>CALA Tech Support for Distributed Coverage & Capacity Solutions (DCCS) products:</i>	
Mail	Av. Insurgentes Sur 688, Piso 6 Col. Del Valle, CP: 03100 Mexico City Mexico
Phone	+52-1-55-5419-5260 (Cell) +52-55-1346-1900 (Office)
Fax	+52-55-1346-1901
E-mail	wisupport@commscope.com

APAC Countries:

China, India and Rest of Asia	
Andrew International Corporation	
Mail	Room 915, 9/F Chevalier Commercial Centre 8 Wang Hoi Rd Kowloon Bay Hong Kong
Phone	+852-3106-6100
Fax	+852-2751-7800
E-mail	wisupport.China@commscope.com

Australia & New Zealand	
Andrew Corporation (Australia) Pty Ltd.	
Mail	Unit 1 153 Barry Road Campbellfield VIC 3061 Australia
Phone	+613-9300-7969
Fax	+613-9357-9110
E-mail	wisupport.Australia@commscope.com

Europe:

<i>United Kingdom</i>	
Andrew Wireless Systems UK Ltd	
Mail	Unit 15, Ilex Building Mulberry Business Park Fishponds Road Wokingham Berkshire RG41 2GY England
Phone	+44-1189-366-792
Fax	+44-1189-366-773
E-mail	wisupport.uk@commscope.com

<i>Scandinavia</i>	
Andrew Norway (AMNW)	
Mail	P.O. Box 3066 Osloveien 10 Hoenefoss 3501 Norway
Phone	+ 47 32-12-3530
Fax	+ 47 32-12-3531
E-mail	wisupport@commscope.com

<i>Germany</i>	
Andrew Wireless Systems GmbH	
Mail	Industriering 10 86675 Buchdorf Germany
Phone	+49-9099-69-0
Fax	+49-9099-69-930
E-mail	wisupport@commscope.com

<i>France</i>	
CommScope France	
Mail	Immeuble Le Lavoisier 4, Place des Vosges 92052 Courbevoie France
Phone	+33-1 82 97 04 00
Fax	+33-1 47 89 45 25
E-mail	wisupport@commscope.com

<i>Austria</i>	
Andrew Wireless Systems (Austria) GmbH	
Mail	Weglgasse 10 2320 Wien-Schwechat Austria
Phone	+43-1706-39-99-10
Fax	+43-1706-39-99-9
E-mail	wisupport.austria@commscope.com

<i>Switzerland</i>	
CommScope Wireless Systems AG	
Mail	Tiergartenweg 1 CH-4710 Balsthal Switzerland
Phone	+41-62-386-1260
Fax	+41-62-386-1261
E-mail	wisupport.ch@commscope.com

<i>Italy</i>	
CommScope Italy S.r.l., Faenza, Italy	
Mail	Via Mengolina, 20 48018 Faenza (RA) Italy
Phone	+39-0546-697111
Fax	+39-0546-682768
E-mail	wisupport.italia@commscope.com

<i>Iberia Region - Spain & Portugal</i>	
Andrew España S.A. A CommScope Company	
Mail	Avda. de Europa, 4 - 2ª pta. Parque Empresarial de la Moraleja Alcobendas, Madrid 28108 Spain
Phone	+34-91-745-20 40
Fax	+34-91-661-87 02
E-mail	wisupport.iberia@commscope.com

Czech Republic	
CommScope Solutions Czech Republic C-Com, spol. s r.o	
Mail	U Moruší 888 53006 Pardubice Czech Republic
Phone	+49 871 9659171 (Office) +49 171 4001166 (Mobile)
Fax	+49 871 9659172
E-mail	wisupport@commscope.com

Africa & Middle East:

Middle East & North Africa	
CommScope Solutions International Inc. (Branch)	
Mail	PO Box 48 78 22 Unit 3206, Floor 32, Jumeirah Business Center 5, Jumeirah Lakes Towers, Dubai United Arab Emirates
Phone	+971 4 390 09 80
Fax	+971 4 390 86 23
E-mail	wisupport@commscope.com

South Africa	
Andrew Wireless Solutions Africa (PTY) LTD	
Mail	11 Commerce Crescent West Eastgate, Sandton PO Box 786117 Sandton 2146 South Africa
Phone	+ 27 11-719-6000
Fax	+ 27 11-444-5393
E-mail	wisupport@commscope.com

table 1-1 List of international contact addresses

2. INTRODUCTION

2.1. PURPOSE

Cellular telephone systems transmit signals in two directions between base transceiver station (BTS) and mobile stations (MS) within the signal coverage area.

If weak signal transmissions occur within the coverage area because of indoor applications, topological conditions or distance from the transmitter, extension of the transmission range can be achieved by means of an optical distribution system.

Such a system contains an optical Master Unit and several Remote Units. The number of the Remote Units depends on the hardware and software configuration. The Remote Units are connected to the Master Unit with optical links. The optical loss must be less than 10 dB inclusive optical couplers or splitters.

The Master Unit is the connection to the base transceiver stations. The configuration of a Master Unit depends on the number of the Remote Units and the frequency range.

WDM (Wave Division Multiplex) filters are integrated in the optical modules. For the UL, a wavelength within 1546 nm – 1550 nm is used. For the DL, a wavelength of 1310 ± 10 nm is used. The maximum output power for the UL and DL is 6.7 mW.

2.2. THE ION-M7P/17HP

The ION-M7P/17HP is a multi-band, multi-operator remote unit configuration used in conjunction with a master unit in the ION optical distribution system.

This system transports up to two frequency bands simultaneously (700 MHz and 1700/2100 MHz), providing a cost-effective solution for distributing capacity from one or more base stations.

The ION system transports signals on the RF layer in a very cost-effective manner enabling multiple operators to use multiple technologies and move their signals simultaneously from a cluster of base station to a number of remote locations over the same fiber.

The ION-M optical distribution system is a cost-effective coverage solution for dense urban areas, tunnels, subways, airports, convention centers, high-rise buildings and other locations where physical structures increase path loss.

The combination of these units gives maximum flexibility while providing a scalable solution. The system is optimized for CDMA, WCDMA, HSPA+ and OFDM modulation in the 700 MHz and 1700/2100 MHz bands. Furthermore it is provisioned for future modulation and frequency bands.

The ION can be easily set-up and supervised from a graphical user interface (GUI). Remote units are commissioned through the use of built-in test equipment. An auto levelling function compensates for the optical link loss making installation easy and quick.

The entire system can be monitored remotely by the Andrew OMC. This platform uses SNMP protocol and is compliant to X.733 standard. Should a sophisticated interface not be required, the master unit can be directly connected to the alarm interface of a base station via its contact relay.

Features at a glance

- Reduced visual impact form factor
- Optimized power consumption
- Efficient, high power amplifier
- Multi-operator support
- Complete operations and management system for configuration and alarming
- OMC with SNMP according to X.733 standard
- 3GPP TS25.143/TS25.106/36.143/TS36.106 and 3GPP2C.S0051-0 compliant
- Single fiber for multiple bands and multiple remotes
- Easy installation and commissioning

3. FUNCTIONAL DESCRIPTION

3.1.1. Fan-Protection Kit

In order to protect the fan unit (e.g. against rain), a protective cover to be mounted over the air inlet is delivered with the unit. For more details see section *4.1.4 Mounting of Fan Protection*.

Mounting of the fan-protection kit is only mandatory for outdoor applications, however, not mandatory for indoor applications.

3.1.2. Accessories

For the accessories available for the Remote Unit, e.g. overcoat housing, connecting box or iso-trafo kit, a separate manual is available.

For your notes:

4. COMMISSIONING

4.1. MECHANICAL INSTALLATION

4.1.1. General

Read the health and safety warnings in section *1.2 Health and Safety Warnings*. It is the responsibility of the installer to verify that the supporting surface will safely support the combined load of the electronic equipment and all attached hardware and components and to ensure that the unit is safely and securely mounted.

WARNING: IMPROPER INSTALLATION CAN LEAD TO EQUIPMENT FALLING CAUSING SERIOUS PERSONAL INJURY OR DAMAGE TO EQUIPMENT. The installer must verify that the supporting surface will safely support the combined load of the electronic equipment and all attached hardware and components. The screws and dowels (wall anchors) used should also be appropriate for the structure of the supporting wall.

1. Do not install the unit in a way or at a place where the specifications outlined in the Environmental and Safety Specifications leaflet of the supplier are not met.
2. It is recommended to use the mounting hardware delivered by the supplier only. If different mounting hardware is used, the specifications for stationary use of the Remote Unit must not be exceeded.

 **Note:** Exceeding the specified load limits may cause the loss of warranty!



3. The unit is considerably heavy. Make sure that a suitable mounting surface is used. Ensure there is adequate manpower to handle the weight of the system.
4. Due to power dissipation, the Remote Unit may reach a very high temperature. Ensure sufficient airflow for ventilation.
5. When connecting and mounting the cables (RF, optical, mains, ...) ensure that no water can penetrate into the unit through these cables.
6. Also observe all additional rules or restrictions regarding mounting that depend on the type of Remote Unit. For details refer to section *7.2.2 Mechanical Specification*. Install the unit vertically with the fan unit at the top. A maximum tilt angle of 25° from a vertical position must be kept, as in the following illustrations:

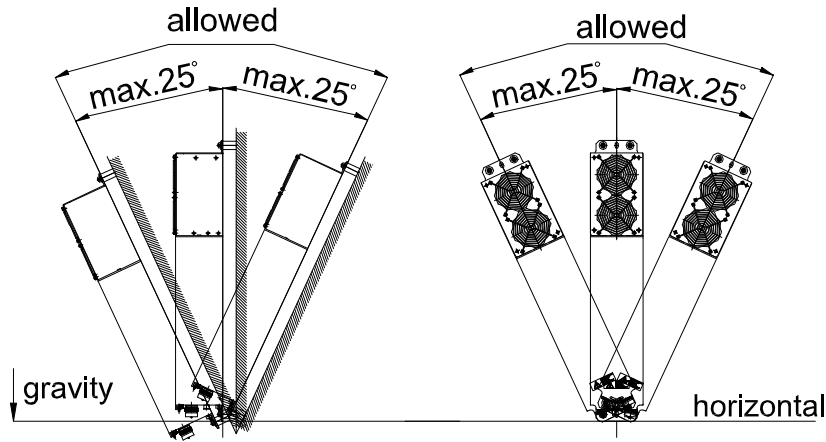

G1038M4

- 7. A spacing of 40 mm (1.58 inch) around the unit is required.
- 8. To ensure sufficient airflow when mounting the unit in enclosed spaces, two lid openings (one for the air inlet and the other for the air outlet) have to be provided. Do not block these air inlets and outlets when mounting the Remote Unit. The size of each opening must equal at least 12 x 12 cm (144 cm²). Make sure, too, there is no thermal short circuit between the air inlet and air outlet.

If any different or additional mounting material is used, ensure that the mounting remains as safe as the mounting designed by the manufacturer. Ensure that the static and dynamic strengths are adequate for the environmental conditions of the site. The mounting itself must not vibrate, swing or move in any way that might cause damage to the Remote Unit.

Specified torques have to be observed for certain mounting procedures according to the following table:

Type	Tallow-drop screws	Hex nuts	Spacing bolts		PG (plastic)	PG (aluminium)
Thread	M 4	M 8	M 4	M 8	PG 13.5	PG 29
Specified torques	3.3 Nm	27 Nm	2.3 Nm	27 Nm	3.75 Nm	10 Nm

table 4-1 Specified torques

Note: To avoid damage when mounting the unit, always make sure that the M8 washers (DIN9021 or DIN125 depending on the mounting kit) are placed behind and in front of the mounting drillings of the unit.

The mounting procedures for a stand-alone Remote Unit without optional accessories are described and illustrated in the following sections. For further information regarding special mounting procedures including mounting of accessory equipment, please see separate manual.

4.1.2. Wall-Mounting Procedure

- Check the suitability of the wall-mounting kit and the wall.
- Mark the position of the drilling holes (for measurements refer to *figure 4-1 Wall mounting*). Drill four holes at the marked positions and insert dowels *.
- Use a cap nut or lock nut to screw the four dowel screws into the dowels and put the distance tubes over the screws.
- Hang the mounting brackets of the Remote Unit into the screws, and fasten them immediately using the washers and nuts.
- Ensure that there is free access to the electrical connections as well as to the cabinet. The approved bending radius of the connected cables must not be exceeded.

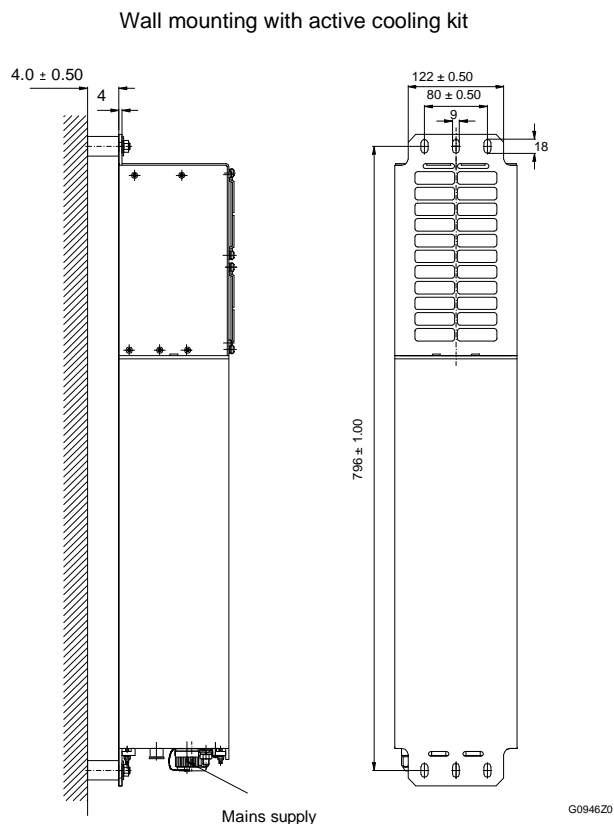
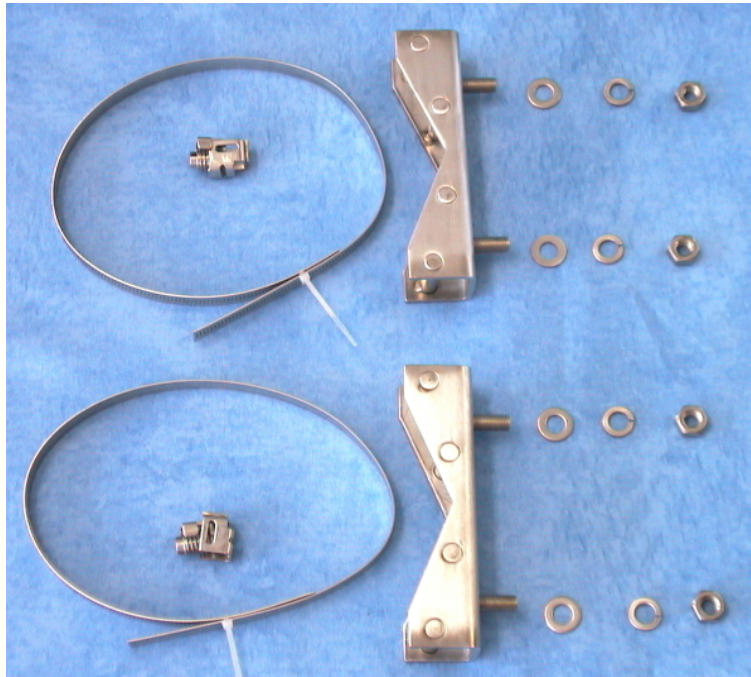

figure 4-1 Wall mounting, (metric dimensions)

* The dowels are not part of the delivery since the suitable type depends on the on-site conditions (material of wall). Therefore, use dowels that are appropriate for the mounting surface.

4.1.3. Pole-Mounting Procedure

Standard mounting hardware cannot be used to mount the Remote Unit to a pole, a column or other similar structures. Additional hardware must be used for this type of installation. Such a pole-mounting kit could include two threaded rods M8, two U-beams and mounting material like bolts and nuts.



B0113AUA

figure 4-2 Pole-mounting kit

- Use the screw bands to fasten the two U-beams to the pole as illustrated in *figure 4-3 Pole mounting*.

☞ **Note:** When fastening the U-beams make sure that they are installed congruently and not at an angle to each other. To determine the distance between the beams refer to **4.1.2 Wall-Mounting Procedure** for measurements.

- Hang the mounting brackets of the Remote Unit into the threaded bolts of the U-beam, and fasten them immediately using the washers and nuts.

Ensure that there is free access to the electrical connections as well as to the cabinet. The approved bending radius of the connected cables must not be exceeded.

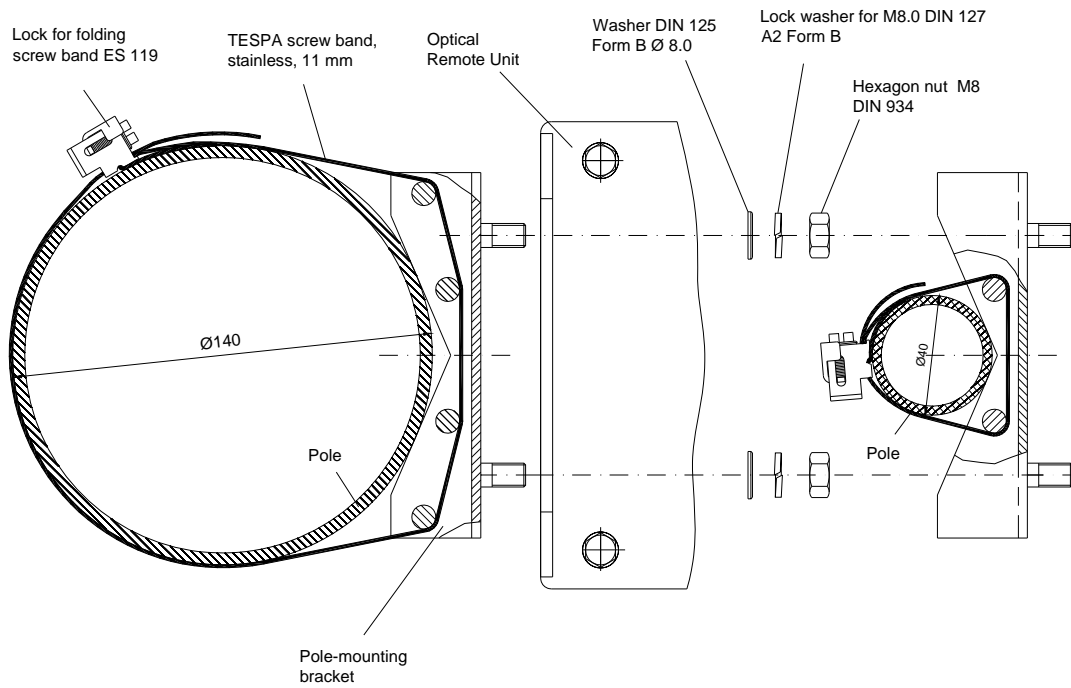

G0764M6

figure 4-3 Pole mounting (metric dimensions)

4.1.4. Mounting of Fan Protection

Since the fan protection is required for the outdoor usage of a stand-alone Remote Unit, the mounting of this optional equipment is also described in this manual.

- To install the protective cover of the fan protection kit, first unscrew the four screws with the respective lock washers from the cover of the air inlet of the Remote Unit, and instead, screw in the four spacing bolts M4.0x30 with the four lock washers M4.0 DIN125 that are part of the fan protection kit.
- Place the protective cover into the right position by fitting its four bore holes over the spacing bolts and fasten it using the original lock washers and screws of the Remote Unit. (These lock washers and screws are also part of the fan protection kit and can be used as spare parts in case of loss.)

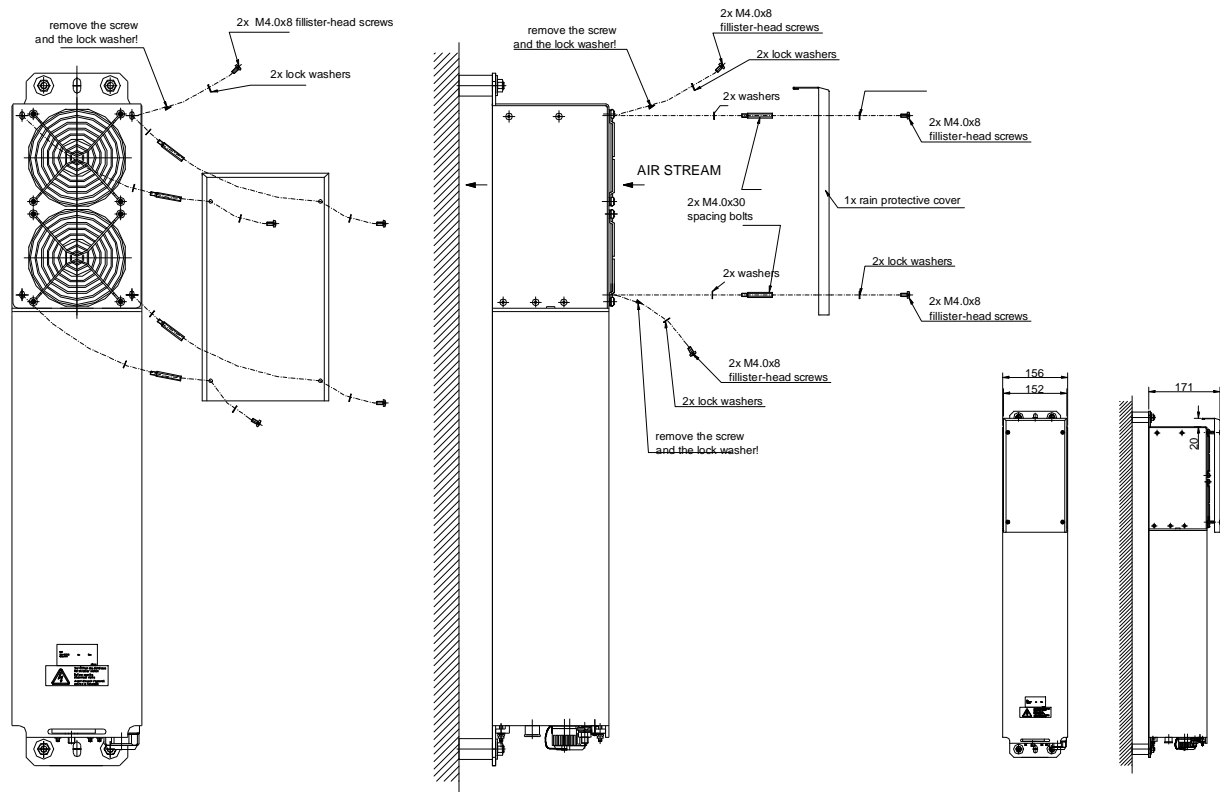

G0496MF

figure 4-4 Mounting procedure for fan protection, (metric dimensions)

4.2. ELECTRICAL INSTALLATION

4.2.1. General

Read the health and safety warnings in section 1.2 *Health and Safety Warnings*.



1. This unit contains dangerous voltages. Loss of life, severe personal injury or property damage can be the result if the instructions contained in this manual are not followed.
2. Ground the unit before connecting power supply. A grounding bolt is provided on the cabinet to connect the ground-bonding cable.
3. Although the Remote Unit is internally protected against over-voltage, it is strongly recommended to earth the antenna cables close to the antenna connectors of the Remote Unit for protection against atmospheric discharge. In areas with strong lightning it is highly recommended to insert additional lightning protection.
4. If the mains connector of the Remote Unit is not easily accessible, a disconnect device in the mains circuit must be provided within easy reach.
5. Before connecting or disconnecting the mains connector at the Remote Unit, ensure that mains supply is disconnected.
6. Make sure that an appropriate circuit breaker and an over-current limiting device are connected between mains and Remote Unit.
7. A connection of mains supply to a power socket requires the power socket to be nearby the Remote Unit.
8. Incorrectly wired connections can destroy electrical and electronic components.
9. To avoid corrosion at the connectors caused by electrochemical processes, the material of the cable connectors must not cause a higher potential difference than 0.6 V (see electrochemical contact series).
10. Use an appropriate torque wrench for the coupling torque of N-type connectors (2 N-m / 20 in lb), with 13/16 inch opening to tighten the N-type antenna connectors. For example, use torque wrench of item no. 244379 available from the *Andrew e-catalog*. Do NOT use your hands or any other tool (e.g. a pair of pliers)! This might cause damage to the connector and lead to a malfunction of the Remote Unit.
11. Use a voltage limiting device for unstabilized electric networks that frequently generate spikes.

12. The unit complies with the surge requirement according to EN 61000-4-5 (fine protection); however, it is recommended to install an additional medium (via local supply connection) and/or coarse protection (external surge protection), depending on the individual application, in order to avoid damage caused by overcurrent.
13. Observe the labels on the front panels before connecting or disconnecting any cables.

4.2.2. Connections

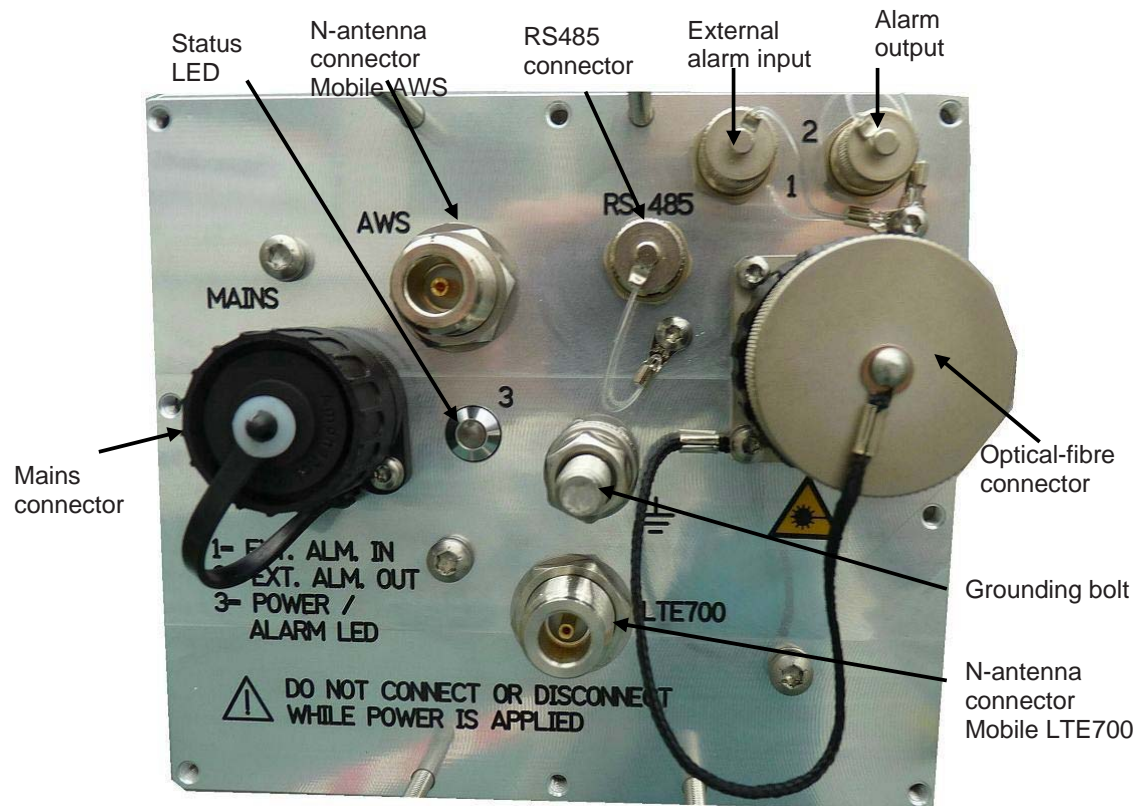

B0299A2A

figure 4-5 Connector flange of ION-M7P/17HP

4.2.3. Grounding

Grounding must be carried out. Connect an earth-bonding cable to the grounding connection provided at the outside of the Remote Unit (see section 4.2.2 *Connections*). Do not use the grounding connection to connect external devices.



B0092ATA

figure 4-6 Grounding bolt with loosened hex nut

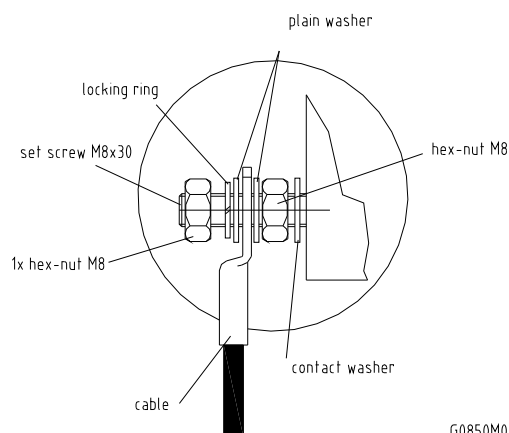

G0850M0

figure 4-7 Grounding bolt, schematic view

After loosening the hex nut, connect the earth-bonding cable between the two washers as illustrated in the figures above. Then, fasten all parts again with the hex nut.

4.2.4. Power Connection

Before connecting electrical power to the RU, the system must be grounded as described in the previous section.

Mains power must be connected at the mains connector of the unit (see section 4.2.2 *Connections*).

The power supply plug is part of the delivery. The correct wiring of the power supply plug is as follows:

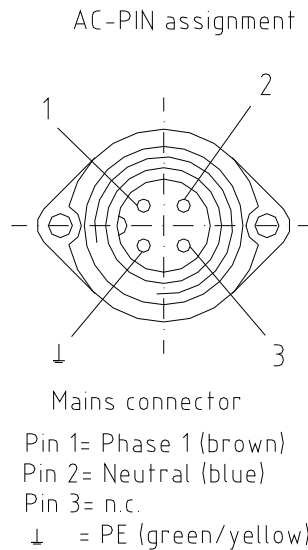

G1038Z0

figure 4-8 AC mains plug

For the AC power supply connection, a minimum cross section of 1.5 mm² is required. Each wire must observe the applicable national regulations regarding loop impedance, voltage drop, and methods of installation. Make sure to connect the correct voltage to the unit.

Note: Do not connect or disconnect the power cord at the mains connector while power is on. Turn off mains power * before connecting the power cord at the Remote Unit, then, engage mains again.

* Mains power must be interruptible with an external mains breaker. For the mains breaker, observe the following recommendation:

120 Volt / 20 Amp max. or 240 Volt / 16 Amp, single-phase, 50 / 60 Hz AC service is needed, i.e. the external AC breaker should be 20 Amps max. for 120-Volt service or 16 Amps for 240-Volt service.

4.3. CONNECTION OF THE ANTENNA CABLES

The Remote Unit has N-type antenna connectors. Please refer to section 4.2.2 *Connections* for its location. Refer to the corresponding documentation of the connector manufacturer for mounting the cable connectors.

The bending radius of the antenna cables must remain within the given specifications.

Consider the type of cable best suited for the antenna. Remember that a cable with higher loss is less expensive but impairs performance.



Use an appropriate torque wrench for the coupling torque of N-type connectors (2 N-m / 20 in lb), with 13/16 in opening to tighten the N-type antenna connectors. For example, use torque wrench of item no. 244379 available from the *Andrew e-catalog*. Do NOT use your hands or any other tool (e.g. a pair of pliers)! This might cause damage to the connector and lead to a malfunction of the Remote Unit.

- ☞ **Note:** Directly connect the base station signal to the Master Unit using a coaxial cable to avoid coupling another signal into the system in the DL direction than the single wanted signal transmitted by the base station.

4.4. OPTICAL FIBER CABLE CONNECTION RULES

Main optical system parameters:

Fiber:

- Single mode fiber, type is E9/125 μ m
- Attenuation: <0.36 dB / km @ 1310 nm / <0.26 dB / km @ 1550 nm
- Dispersion: <3.5 ps / nm km @ 1310 nm / <18.0 ps / nm km @ 1550 nm
- Fibre-cable connectors E2000 APC 8°

ION-M system:

- The pigtails for the connection between Master Unit and Remote Unit must have a sufficient length. Protection for the optical fibers must be provided where the fibers feed into the units.
- The system attenuation of the optical fibers, including the connectors, must not exceed 10 dB.

System attenuation and attenuation of optical components must be determined. This can be achieved by measuring attenuation and reflection with an appropriate measuring instrument. For pigtails, a total value of <0.4 dB (measured to a reference plug) can be assumed due to the dead zone of the reflectometer. These measurements must be made with a sufficient length of optical fiber, at the input and output of the device which has to be measured.

Fiber-System Installation:

Fiber-cable connectors have to be of the same type (E2000 APC 8°) as the connectors used for the unit. The fiber-optic cables are connected to the optical transceiver.



Angled connectors are not compatible with straight optical connectors; non-compatibility of connectors will result in permanent damage to both connectors.

Before connecting the fiber cables, follow the procedure below to ensure optimized performance. It is important for these procedures to be carried out with care:

- Remove fiber-optic protective caps.
- Do not bend the fiber-optic cable in a tight radius (<4 cm) as this may cause cable damage and interrupt transmission.
- Using high-grade alcohol and lint-free cotton cleaning swabs, clean the end of the fiber-optic cable that will be inserted in the optical connectors on the donor interface box. Use a fiber end-face inspection tool to scan both, the class fiber and its surrounding area.
- Check for dirt on the cladding, chips/pits, dirt on the ferrule, and scratches.
- Connect the fiber-optic cables by inserting the cable end into the laser receptacle and aligning the key (on the cable end) with the keyed slot.
- Do not use any index-matching gels or fluids of any kind in these connectors. Gels are intended for laboratory use and attract dirt in the field.

 **Note:** Care should be taken when connecting and disconnecting fiber-optic cables - use the connector housing to plug or unplug a fiber. Scratches and dust significantly affect system performance and may permanently damage the connector. Always use protective caps on fiber-optic connectors not in use.

Cleaning Procedure for Fiber-Optical Components:

Any contamination in the fiber connection results in additional optical transmission loss which could cause whole system failure. It is thus recommended that every fiber connector be inspected and cleaned prior to mating.

The goal is to eliminate any dust or contamination and to provide a clean environment for the fiber-optic connection.

When you clean fiber components, always complete the following steps carefully:

1. Turn off the ION system (laser sources) before you inspect fiber connectors.



Never look into a fiber while the system lasers are on!

2. Check the connectors or adapters with a fiberscope before cleaning.
3. If the connector is dirty, clean it with a lint-free wipe (dry cleaning).
4. Inspect the connector.
5. If the connector is still dirty, repeat the dry cleaning technique.
6. Inspect the connector.

7. If the connector is still dirty, clean it with 99% isopropyl alcohol (wet cleaning) followed immediately with a dry clean in order to ensure no residue is left on the endface.
8. Repeat steps 5 through 7 until endface is clean.

Note: For a more detailed description, please refer to:

http://www.cisco.com/en/US/tech/tk482/tk876/technologies_white_paper09186_a0080254eba.shtml

4.4.1. Protective Plug

Connection:

A protective plug is provided for the connection of the fibre-optic cables.

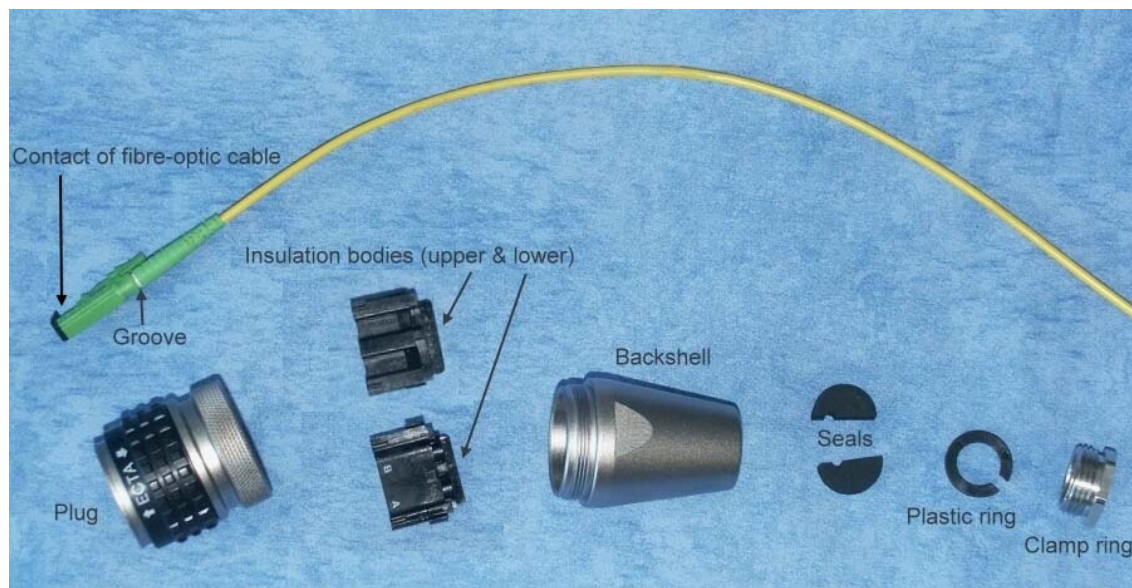

B0122AMA

figure 4-9 Protective-plug assembly

Note: Only high-quality connectors must be used for this type of plug. Qualified brands are Diamond or Huber & Suhner.

For plug assembly, observe the following instruction:

1. Pass one or two contacts through the backshell and the clamp ring.



B0122A1A

2. Place the contact(s) on the lower insulation body by pushing the groove of the contact into the cavity. If there is only one contact, cavity A **must** be used. *
3. Then, mount the upper insulation body on the lower insulation body. **

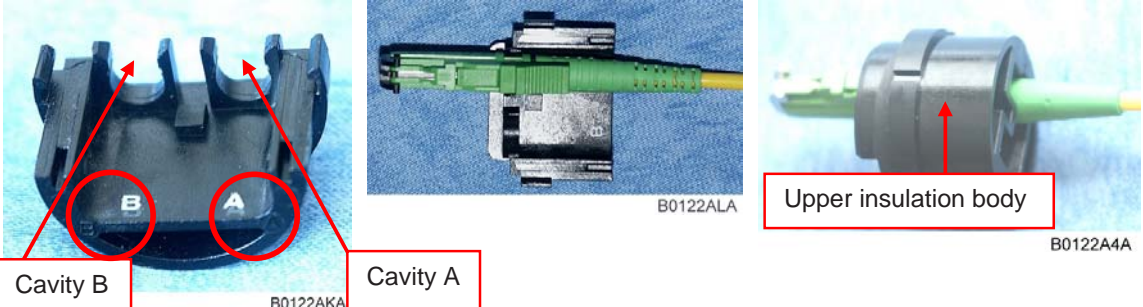

Cavity B

Cavity A

Upper insulation body

B0122AKA

B0122ALA

B0122A4A

4. Bring the insulator into the plug. The narrow groove of the insulator must be fitted into the stamp of the plug.

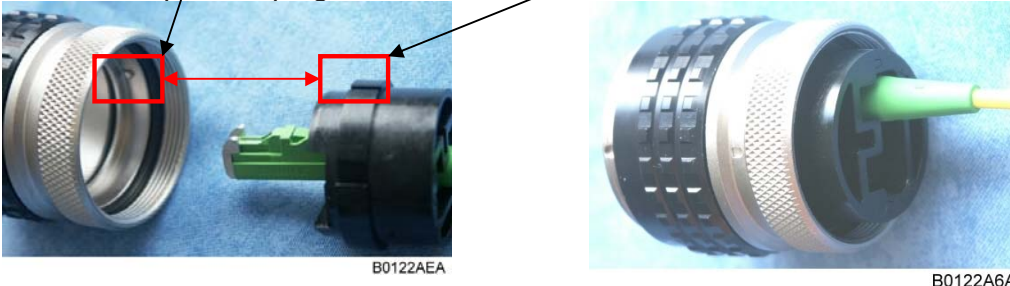

B0122AEA

B0122A6A

- * To release the contact for disassembling, push the inner snap to the side and pull the contact out.
- ** To release upper and lower insulation bodies for disassembling, use a small screwdriver and carefully open the snap-connections at the left and the right side of the insulator without damaging them.

5. Fasten the insulator by screwing the backshell tight onto it. Use a spanner with opening 32 to screw the backshell tight (no gap).
6. Place the appropriate seal parts (with one groove for one contact or two grooves for two contacts) over the cable(s) and push them into the backshell.

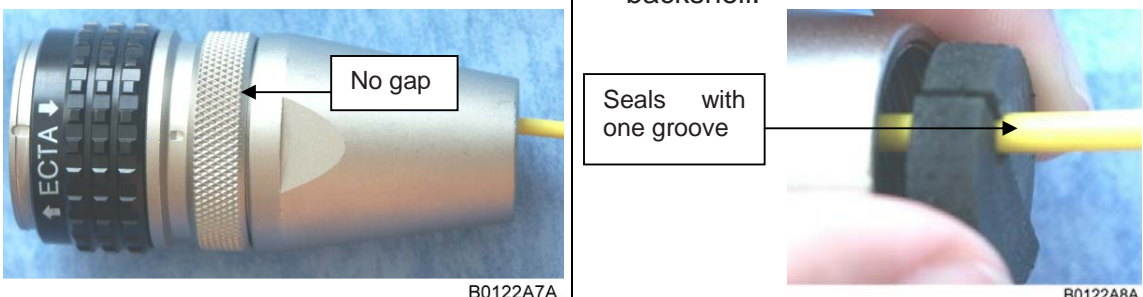

No gap

Seals with one groove

B0122A7A

B0122A8A

7. Bring the plastic ring over the cable(s), push it into the backshell and compress the seals and plastic ring by screwing the clamp ring tight (no gap) using a spanner with opening 20. ***

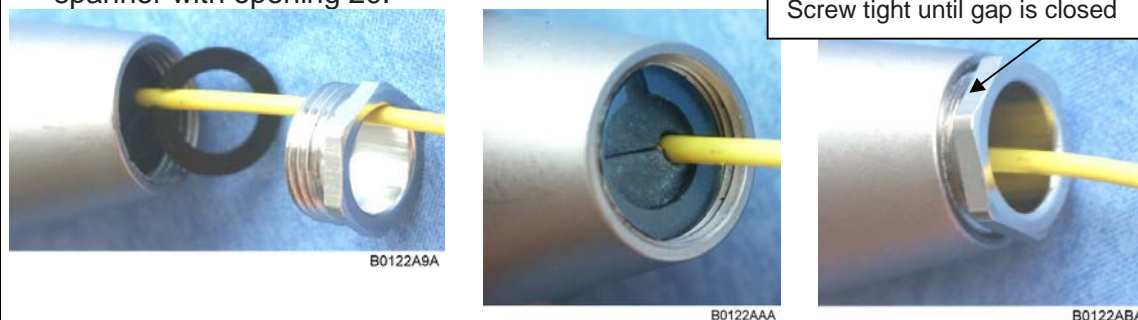

8. Connect the plug to the optical-fibre connector of the Remote Unit, again by fitting a stamp on the plug into the groove of the connector.

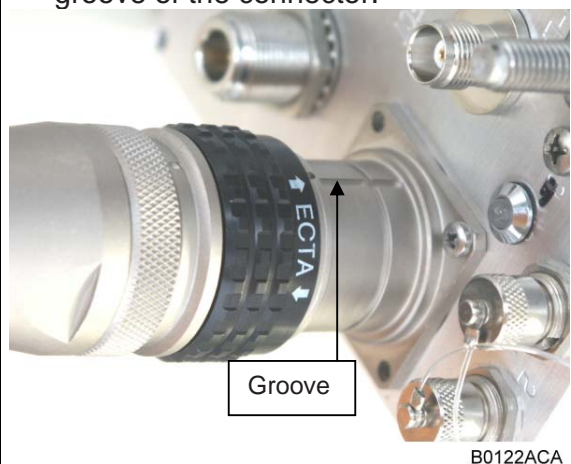

9. To lock the connector, push the black locking ring forward.****

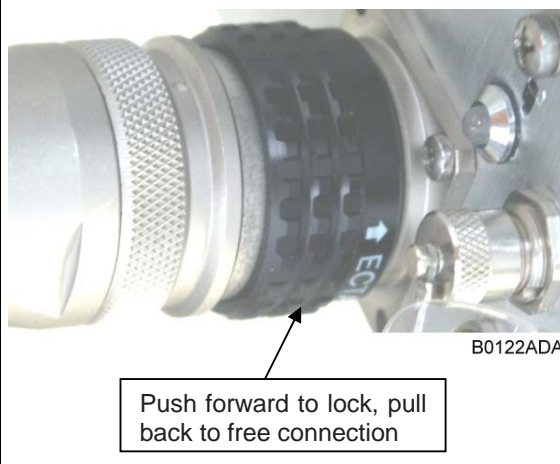

*** For disassembling, release the clamping ring and remove the seals and the plastic ring first.

**** Locking mechanism: The system of locking the plug is based on a “push-pull” mechanism. The locking ring has to be pushed forward to lock the connector and pulled back to free the connection.

4.4.2. Protective-Tube Kit

As additional protection for the optical fibres, this connector type can be supplemented by a special tube kit. To fasten the tube correctly, first unscrew the clamp ring (if already installed) of the original plug kit.

Then, proceed according to the following instruction:

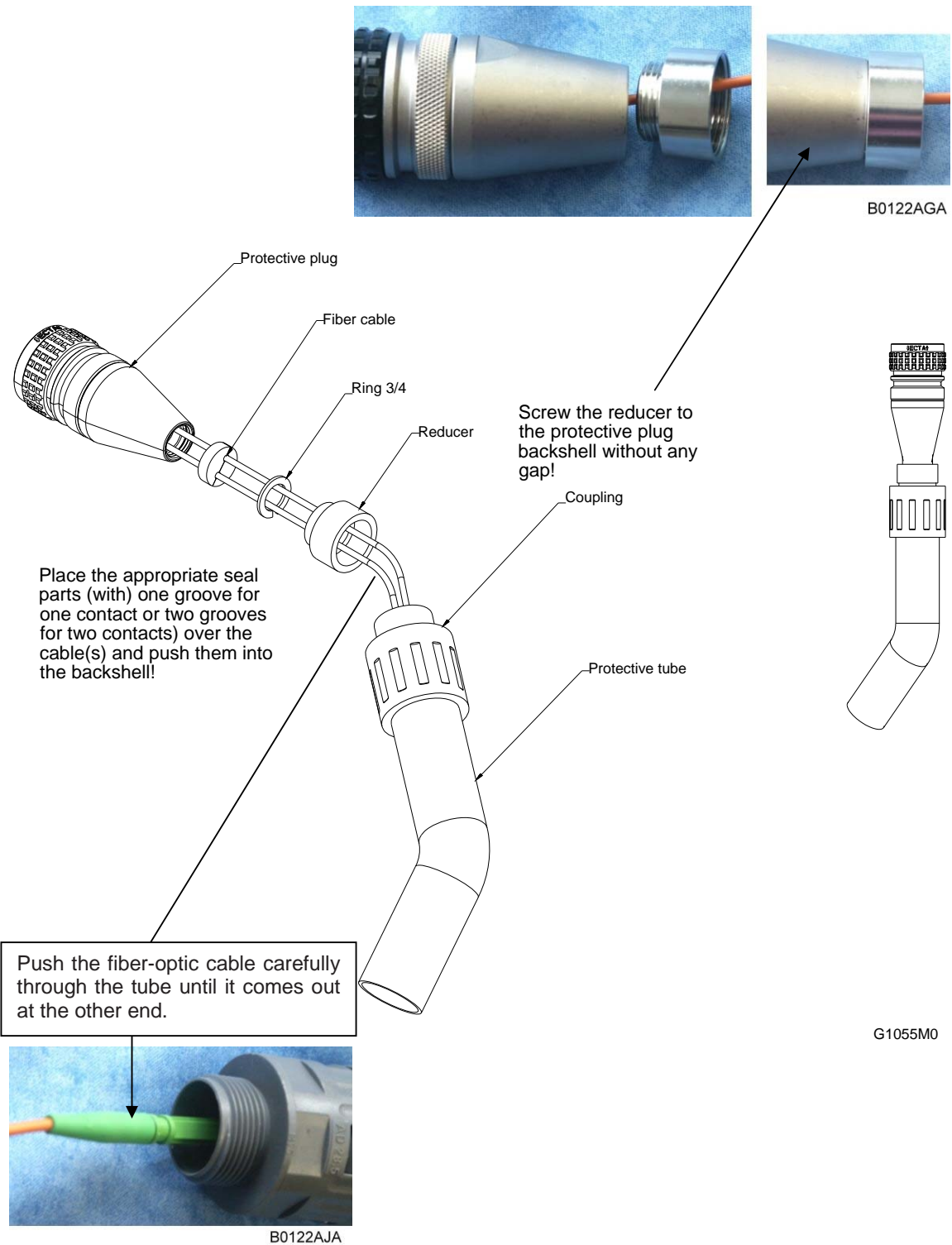

figure 4-10 Tube-kit installation

4.5. COMMISSIONING

Read the health and safety warnings in section *1.2 Health and Safety Warnings*. Keep these guidelines in mind before continuing to the instructions for commissioning:

- Do not operate the Remote Unit without terminating the antenna connectors. The antenna connectors may be terminated by connecting them to their respective antennas or to a dummy load.
- Only qualified personnel should carry out the electrical, mechanical, commissioning, and maintenance activities that require the unit to be powered on when open.
- Do not damage the warranty labels on the devices. The warranty is void if the seals are broken.
- Ensure that all connections have been performed according to section *4.2.2 Connections*.

Commissioning an ION-M Remote Unit

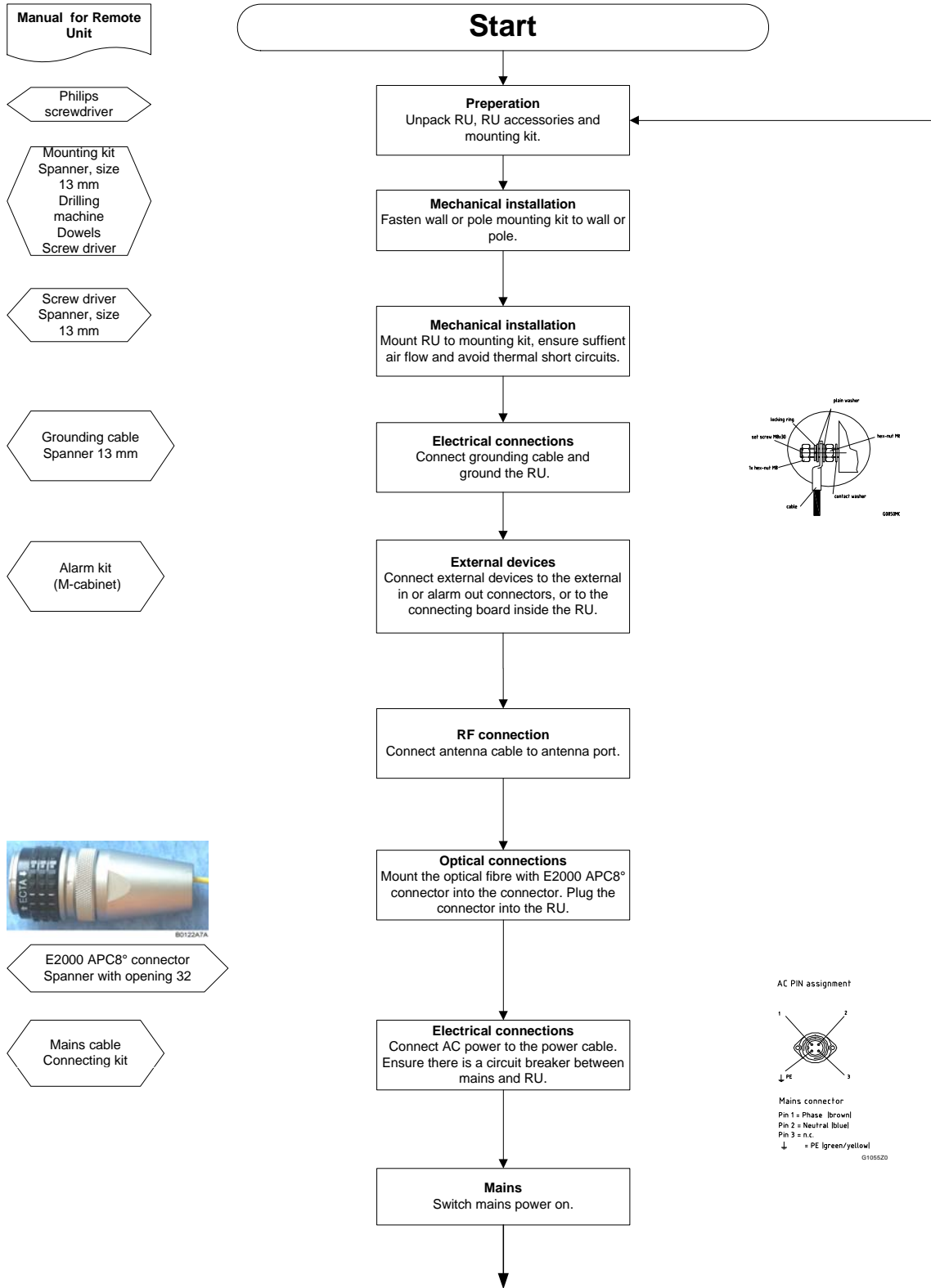

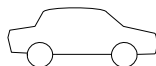
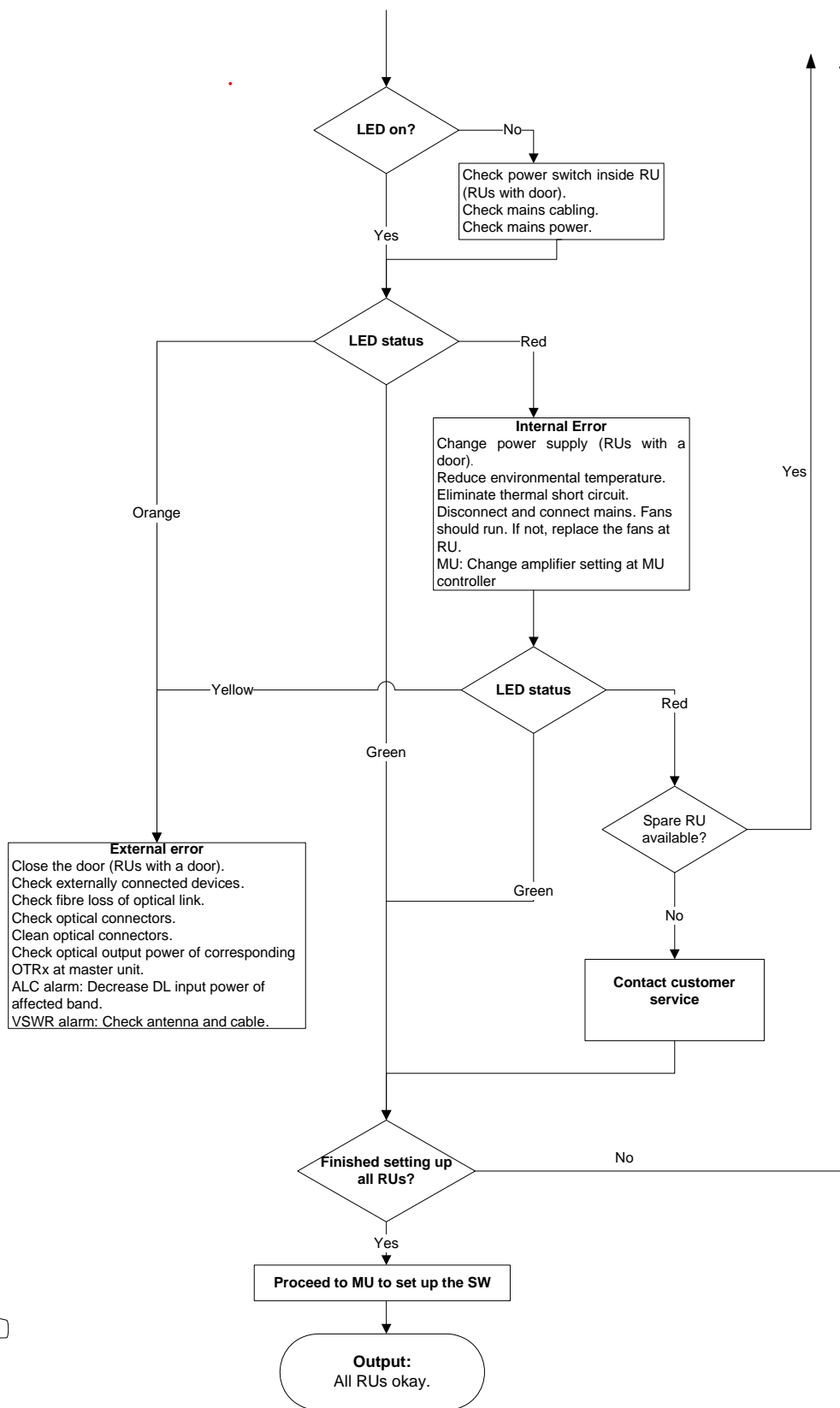

Go to MU

5. ALARMS

5.1. BITE AND ALARMS

The Built-In Test (BITE) concept comprises the monitoring of the power supplies, the power amplifiers and the optical interface.

All alarms occurring can be checked via software at the Master Unit.

5.2. HANDLING OF ALARMS

A message is transmitted to the Master Unit when the software acknowledges a valid alarm.

A new alarm message will not be repeated if the reason for the alarm is cleared or if the alarm continues.

A new alarm message will be generated if the alarm is interrupted for at least five seconds after acknowledgement.

5.3. ALARM STATUS

Refer to the corresponding software documentation of the Master Unit for details.

5.4. STATUS LED ALARMS

For local supervision, a status LED on the connector flange of the Remote Unit gives an indication of possible reasons for alarms. This table shows possible on-site measures that could be checked before referring to the Master Unit alarm list.

Status LED Indication	Alarms	Possible on-site measures
Green	No alarm → Status ok	
Orange	Door alarm	Close the door (RUs with door).
	<i>Alarms not directly related to RU:</i>	
	External alarms	Check externally connected devices.
	Optical alarm Rx	Check fibre loss of optical link. Check optical connectors. Clean optical connectors. <i>(MU: Check optical output power of corresponding OTRx at Master Unit).</i>
	ALC alarm	<i>(MU: Decrease DL input power of affected band).</i>

Red	<i>Alarms directly related to RU:</i>	
	Power 28 V	Change power supply (RUs with door). Replace the affected Remote Unit.
	Temperature	Reduce environmental temperature. Eliminate thermal short circuit.
	Fan	Disconnect and connect mains. Fans should run. If not, replace the fans at RU.
	I ² C	Disconnect and connect mains.
	Optical alarm Tx	Exchange RU.
	Amplifier "Power Down"	<i>(MU: Change amplifier setting at MU controller).</i>
Status LED off	Mains	Check power switch inside of RU (RUs with door). Check mains cabling. Check mains power.

table 5-1 Status LED alarms

For the position of the status LED see section 4.2.2 Connections.

Explicit troubleshooting is available in the MU software (software manual or WEB Interface).

5.5. EXTERNAL ALARM INPUTS AND OUTPUTS

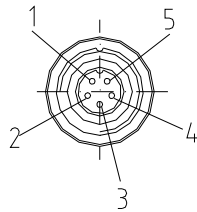

Flange connector
5 poles

- Pin 1= Alarm IN1
- Pin 2= Alarm IN2
- Pin 3= Alarm IN3
- Pin 4= Alarm IN4
- Pin 5= Alarm GND

G1038Z0

figure 5-1 Flange connector, 5 poles

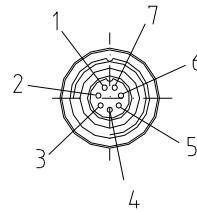

Flange connector
7 poles

- Pin 1= OUT1
- Pin 2= OUT2
- Pin 3= OUT3
- Pin 4= OUT4
- Pin 5= Alarm GND
- Pin 6= GND
- Pin 7= +28 V

G1038Z0

figure 5-2 Flange connector, 7 poles

The alarm outputs (open collector output 5 V / 1 mA) are normally low. In case of an alarm they are high active (5 V). They can be used to monitor alarms with an external alarm indicator.

The +28 V pin (for its location see *figure 5-2 Flange connector, 7 poles*) is protected by a 500 mA thermoswitch. In case of exceeding this current between pin 7 and GND and/or in case of a failure of the VSWR module, the thermoswitch turns into a high-resistive status. In this case no fuse needs to be replaced. Just wait a few minutes until the thermoswitch reaches the normal operating temperature again.

Note: The manufacturer / supplier of this system accepts no liability for damage caused by equipment connected to external outputs or by effects from such equipment.

As accessory equipment the alarm kit is available to connect external devices to the external alarm inputs and outputs. For the exact ID No., please refer to section 7.3 *Spare Parts*.

With the external alarm inputs it is possible to monitor the status of connected devices, e.g. a UPS, via software. All alarm inputs are normally high (5 V) without connection. The polarity (high/ low) can be set via the software at the Master Unit (for details please see according software manual).

The device to be monitored must be connected so that the alarm contacts will be closed in case of an alarm (I max = 8 mA). The alarm inputs are potential-free with common ground.

Subminiature circular connectors series 712 with five and seven contacts, which are contained in the alarm kit, can be ordered directly from the Binder Connector Group, the manufacturer, or indirectly from CommScope Solutions. For the ID No. of the alarm kit see section 7.3 *Spare Parts*.

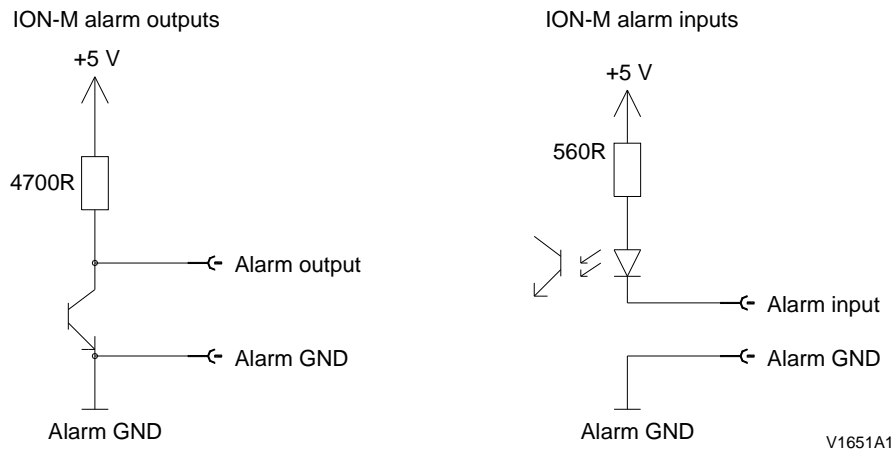

figure 5-3 Alarm inputs and outputs, standard

5.6. TROUBLESHOOTING

The status of the Remote Unit can be checked via the Master Unit (for details please refer to the software manual of the Master Controller). Locally, the status can be checked at the LED, see section *5.4 Status LED Alarms*.

6. MAINTENANCE

6.1. GENERAL

Read the health and safety warnings in section 1.2.

Note: The Remote Unit does not require preventative maintenance measures.

Note: To prevent malfunctions of the cooling system due to dirt or pollution, it is recommended to clean the heat sink at regular intervals. These cleaning intervals depend mainly on the location of the Remote Unit and the corresponding degree of pollution.

Maintenance of the ION-M7P/17HP should be performed by replacing only components that are contained in this section. Take care not to unintentionally damage the seals on the modules to maintain warranty. Please keep these guidelines in mind during maintenance:

The spare parts list, consequently, contains only units which can be replaced without tuning or soldering work.

Note: Use an appropriate packaging when sending back the unit (see section 7.2.2 *Mechanical Specifications* for details). We strongly recommend using the original packaging.

Note: Defective parts should only be replaced by original parts from the supplier. All interventions inside the housing are at one's own risk.

Note: Ensure the Remote Unit has been disconnected from mains during maintenance.

Note: Label any unlabelled cables before disconnecting them to ensure correct re-connection.

Maintenance procedures require appropriate tools to ensure correct handling. All these tools can be ordered from the supplier.

Note: All our screws have a right-hand thread and are fastened by turning the tool clockwise and are unscrewed by turning the tool counter-clockwise.

Due to the design of the Remote Unit the only component recommended to be replaced is the fan unit. For replacing any other component, please contact the supplier.

6.2. REPLACING THE FAN UNIT

Replacement of the fan unit is not required as a preventative measure. Only if an alarm indicates a malfunctioning of a fan must the unit be exchanged.

Note: Please observe that the fan unit can only be replaced as a whole. Do not remove the fans separately.

Read the health and safety warnings in section 1.2 as well as the instructions in section 6.1 *General* before starting with the replacement.

1. **Switch off the Remote Unit. Make sure mains is disconnected for the following replacement procedure.** Then, proceed as follows:

2. Loosen the four tallow-drop screws M4x8 by which the fan plate is screwed to the cabinet. Remove the four screws and the corresponding washers.



3. Remove the fan unit – by putting slight pressure on the fan plate cover – to a position that allows access to the fan connector and the earth-bonding cable.

4. Unscrew the fan connector and then disconnect the earth-bonding cable.



5. To mount the new fan unit, re-connect the earth-bonding cable and the fan connector (see *step 4*). Then, place the fan unit back into its original position and fasten it tight as shown below:



B0092AJA



B0097AKA

6. Screw the whole fan unit to the cabinet with the four tallow-drop screws M4x8 (see *step 2*). In order not to exceed the specified torque of 3.3 N-m, use an appropriate tool.

6.3. CLEANING THE HEAT SINK

☞ **Note:** Read the health and safety warnings in section 1.2 *Health and Safety Warnings* as well as the instructions in section 6.1 *General* before starting with the replacement procedure. Then, proceed as follows:

1. Switch off the Remote Unit. For the following procedure ensure that mains has been disconnected before!
2. Remove the fan plate with the fan unit from the Remote Unit as described in section 6.2 *Replacing the Fan Unit*, steps 1 and 2:
3. Use compressed air (max. 5 bar) to blow out the heat sink from back to front:

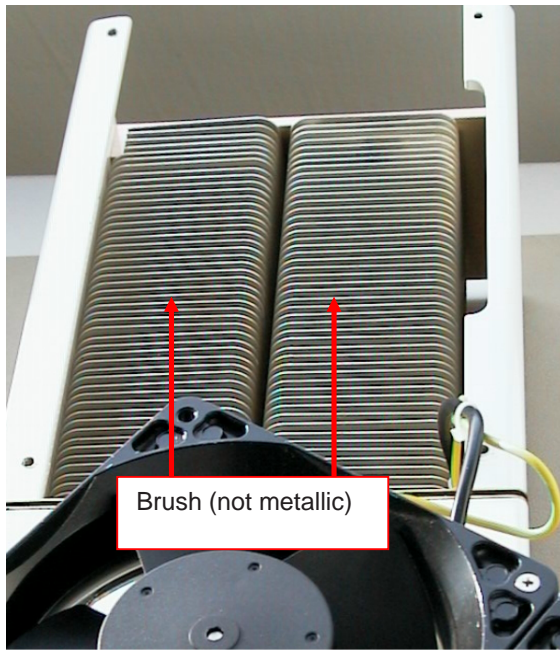

B0112A5A

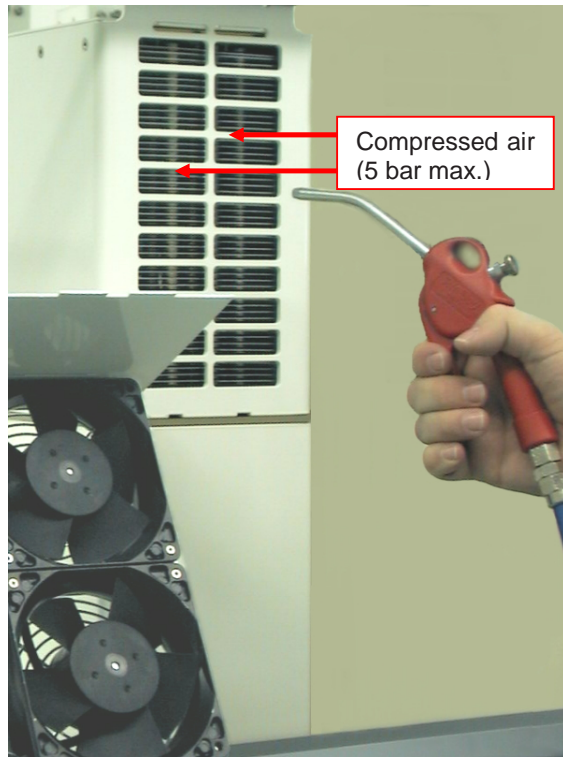

B0112A6A

4. In case the dirt cannot be blown out completely and parts of it stick to the ribs of the heat sink, clean the parts concerned carefully from the front using e.g. a brush. Take care that the material is not scratched or damaged.
5. After cleaning the heat sink, mount the fan unit again according to section 6.2 *Replacing the Fan Unit*, step 6. Then, switch the Remote Unit back on.

7. APPENDIX

7.1. ILLUSTRATIONS

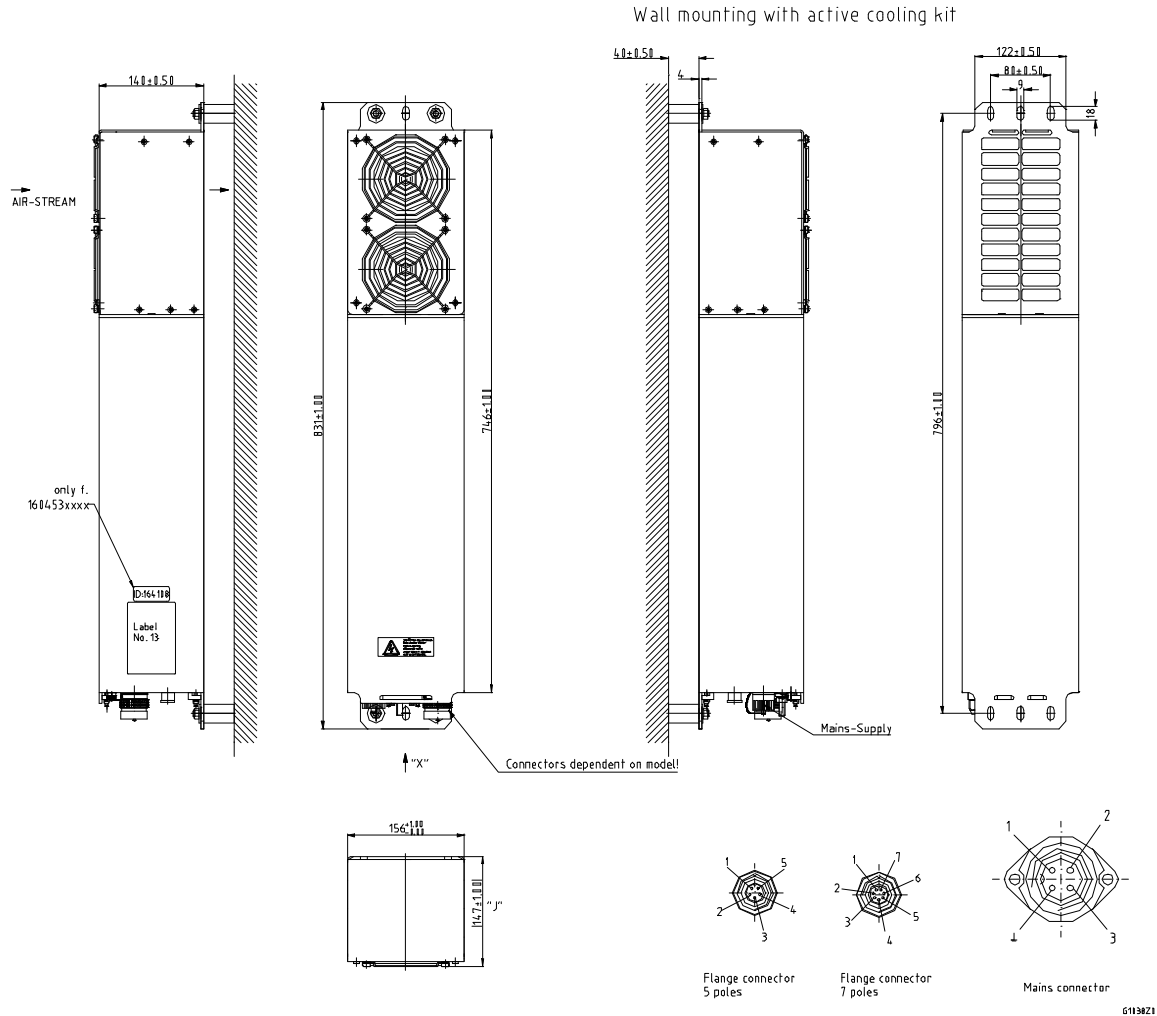

figure 7-1 Installation drawing

7.2. SPECIFICATIONS

7.2.1. Electrical Specifications

Electrical			
Power supply	Mains power	85 Vac to 264 Vac	
		110 Vac or 240 Vac	
	Power consumption	max. temp., fully loaded	770 watts
		room temp., idle	400 watts
Optical Link			
Optical link connectors		E2000/APC 8°	
Optical return loss		45 dB	
Fibre type		Single mode E9/125 µm	
Optical link budget		0 dB to 10 dB	

7.2.2. Mechanical Specifications

Height, width, depth *	831 x 156 x 147 mm (32.7 x 6.1 x 5.8 in)
Weight,	22 kg (48 lb)

* Spacing required 40 mm (1.58 in) around unit

All data is subject to change without notice.

7.2.3. Environmental and Safety Specifications

 **Note:** For detailed information, please refer to the Environmental and Safety Specifications leaflet of the supplier, related to ETS 300 019 (European Telecommunication Standard).

Operating temperature range		-33° C to +50° C
Ingress protection	RF part	IP67
	Fan part	IP55

All data is subject to change without notice.

7.3. SPARE PARTS

The following list contains all parts available for the Remote Unit. The configuration of the delivered unit meets the requirements of the customer and can differ depending on the state of the delivery.

Maintenance of the ION-M7P/17HP should be performed on an FRU (Field Replaceable Unit) basis only. Do not damage the warranty labels on the components, as this voids the warranty.

If any FRU not contained in the following list needs to be replaced, please contact customer service for additional instructions.

Spare Parts List of the Remote Unit ION-M7P/17HP

Designation:	ID No:
<i>ION-M7P/17HP</i>	7679145
Protective Plug E2000	7160013
Protective Cap E 2000	7158914
Fan Protection Kit	7159097
Fan Tray 28 VDC 2 Fan, 119 x 119 mm	7157622
Protective Tube Kit	7162182
Manuals für ION-M7P/17HP & subass (M-cab)	7679238-00

Accessories	
Alarm Kit	7157396
<i>Wall Mounting</i>	
Wall-Mounting Kit	7158078
ISO Trafo Kit 115 V Wall Mounting	7159340
ISO Trafo Kit 230 V Wall Mounting	7158322
Connecting Box Kit Wall Mounting	7159613
Overcoat Housing Kit Wall Mounting	7159625
<i>Pole Mounting</i>	
Pole-Mounting Kit	7157782
ISO Trafo Kit 115 V Pole Mounting	7159623
ISO Trafo Kit 230 V Pole Mounting	7159621
Connecting Box Kit Pole Mounting	7159612
Overcoat Housing Kit Pole Mounting	7159624

The manufacturer reserves the right to replace the spare parts listed above by equivalent substitutes!

☞ **Note:** Only the spare parts listed above are FRUs (= Field Replaceable Units) and can be replaced by the user. For replacement of any other parts, please send the entire Remote Unit back to the manufacturer.

8. INDEX

A		H	
Abbreviations Used	7	Health and Safety Warnings	8
Alarms		I	
Alarm Status	38	Illustrations	46
Bite and Alarms	38	Installation	
External Inputs	39, 40	Electrical	25
Handling of Alarms	38	Mechanical	19
List	41	M	
Outputs	39, 40	Maintenance	42
RU	41	Mounting	
Status LED	38	Fan Protection	24
C		Pole (Outside)	22
CE Declaration of Conformity (DoC)	11	Wall	21
Cleaning the Heat Sink	45	O	
Commissioning		Optical-Fiber Connection	
General	35	Protective-Tube Kit	33
CommScope	11	Optical-Fibre Connection	
Components		Protective Plug	31
Accessories	17	P	
Fan-Protection Kit	17	Pin Assignment	
Connection Rules		External Alarms	40
Optical-Fiber Cables	29	R	
Connections		Replacement of Fan Unit	43
Antenna	28	S	
Connector Flange	26	Spare Parts	48
Power	27	Specifications	
Contact Addresses		Electrical	47
Customer Support	12, 13, 14	Environmental and Safety	47
Customer Support Addresses	12, 13, 14	Mechanical	47
D		T	
Declaration of Conformity (DoC)	11	Troubleshooting	41
F			
Fiber-Optical Components			
Cleaning Procedure	30		
System Installation	29		
Flange Connector			
5 poles	39		
7 poles	39		
G			
Grounding	27		