



InCell™ Fiber Optic Distributed Antenna System

Installation and Users Guide

Copyright Andrew Corporation
Version 1.1
October 2000

Proprietary Information

This document is the property of Andrew Corporation. The information contained herein is proprietary to Andrew, and no part of this document may be reproduced or transmitted in any form or by any means, electronic or mechanical, for any purpose, without the express written permission of Andrew.

Disclaimer

Andrew reserves the right to make changes, without notice, to the specifications and materials contained herein. While we have worked diligently to insure every element presented is correct, we shall not be responsible for errors. For the latest product information and technical specifications, please see the contact information below.

© Copyright Andrew Corporation, October 2000, Printed in USA, All rights reserved.

FCC Notice

This equipment complies with Part 24 of the FCC rules. Any changes or modifications not expressly approved by the manufacturer could void the user's authority to operate the equipment.

Warning

In order to comply with FCC rules for rf exposure, the following must be observed:

1. The antenna for this device must have a gain of no more than 21 dBi.
2. The antenna must be installed such that a minimum separation distance of 20 cm. is maintained between the antenna and any persons.

Trademarks

InCell™ is a trademark of Andrew Corporation. All other trademarks belong to their respective owner.

Contact Information

For more information about Andrew's capabilities to extend RF signals coverage into structures, including office buildings, shopping complexes, warehouses, tunnels, and mines, please contact us using the information below:

Andrew Corporation
2601 Telecom Parkway
Richardson, Texas 75082

Attention: Mr. Matt Melester
E-mail: matt.melester@andrew.com
Fax: (972) 952-0018
Voice: (972)

952-9745

Table of Contents

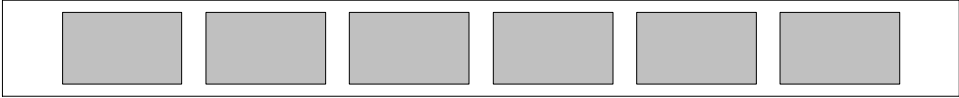
<u>Andrew Corporation</u>	1
<u>Andrew In-Building Wireless Experience</u>	1
<u>InCell™ Fiber Optic Distributed Antenna System Description</u>	1
<u>Central Distribution Unit (CDU)</u>	1
	
CDU FRONT PANEL	
.....	1
<u>Remote Antenna Unit (RAU)</u>	2
<u>CDU to RAU Interface Cables</u>	4
<u>Composite Fiber Optic & Power Cables</u>	4
<u>Standard Duplex Fiber Optic Cables</u>	4
<u>Indoor Antennas</u>	5
<u>In-Building Implementations Using the Andrew InCell™ System</u>	7
<u>Scalable System Architecture</u>	7
<u>The Signal Distribution Unit</u>	8
<u>The Interconnecting Cable</u>	11
<u>The Installation Parameters</u>	13
<u>Sample Implementation</u>	16
<u>InCell™ Specifications</u>	17
<u>Technical Performance</u>	17
<u>Interface Specifications</u>	18
<u>Electrical Specifications</u>	19
<u>Environmental and Mechanical Specifications</u>	20
<u>MTBF</u>	20
<u>MTTR</u>	20

<u>InCell™ Network Monitoring System</u>	21
<u>Pilot Tone Generation</u>	21
<u>RAU Indicators</u>	21
<u>CDU Front Panel Indicators</u>	21
<u>Alarm Functions</u>	22
<u>Remote Monitoring Functions</u>	22
<u>InCell™ Operation, Maintenance and Support</u>	24
<u>Operation</u>	24
<u>Regular Maintenance</u>	24
<u>Fault Repair</u>	24
<u>Support</u>	24
<u>Spare Policy</u>	24

List of Tables

Table 1. InCell™ Performance Specification.....	17
Table 2. BTS Interface Specifications	18
Table 3. Antenna Interface Specifications	19
Table 4. Electrical Specifications	19
Table 5. InCell™ Environmental and Mechanical Specification.....	20

List of Figures

Figure 1. InCell™	1
Figure 2. InCell™ Form Factors	1
Figure 3. Andrew Dual Band Patch Antenna	5
Figure 4. Andrew Dual Band Omni Antenna	5
Figure 5. Simplified InCell™ Block Diagram	7
Figure 6. InCell™ Central Distribution Unit	1
Figure 8. Remote Antenna Unit	8
Figure 9. System expandability to 48 RAUs	9
Figure 10. System Expandability to more than 48 RAUs	10
Figure 11. Cross Section of Andrew Composite Fiber/Copper Cable	11
Figure 12. Remote and Local Power Connections on the RAU	12
Figure 13. Typical System Configuration Using Off-Air Interface	16
Figure 15. Remote Alarm Capability	23
Figure 16. Daisy Chaining CDU's for Remote Monitoring	23

Andrew Corporation

Andrew Corporation is a global designer, manufacturer, and supplier of communications equipment, services, and systems. Andrew products and expertise are found in communications systems throughout the world, including wireless and distributed communications, land mobile radio, cellular and personal communications, broadcast, radar, and navigation. The Andrew "Flash" trademark seen on the cover can also be seen in every corner of the world on broadcast towers and microwave antennas, HELIAX® and RADIAX® cables, communications and computer networking equipment. The mark of Andrew for more than 60 years, it is the benchmark of quality wherever it appears. It is a symbol of commitment to customer satisfaction from the 4,500-plus employees of Andrew Corporation. We are listed on the NASDAQ stock exchange under symbol "ANDW." To learn more about us, please visit our web site at www.andrew.com.

Andrew In-Building Wireless Experience

The Andrew Corporation Distributed Communications Systems (DCS) group has over 15 years experience designing, installing, and managing large complex RF distribution systems for metropolitan railways, building owners, and public mobile radio and telephone operators throughout the world. For clients who do not need turnkey solutions, we offer product sales or product sales with engineering support services.

Andrew offers a range of products to meet requirements of the in-building market. In the early 1980's Andrew developed leaky cables as an adjunct to our coaxial cable business. This product quickly led us to pursuing and executing wireless RF coverage in confined spaces such as metros, road tunnels, and buildings. Through these projects, our Distributed Communications Systems division acquired critical experience in project management and RF engineering of these systems.

InCell™ Fiber Optic Distributed Antenna System Description

The subsystem consists of one or more Central Distribution Units (CDU) feeding multiple Remote Antenna Units (RAU).

Figure 1. InCell™

This unit can drive up to 6 RAU's. Additional CDU's can be driven using one or more of our Signal Distribution Units (SDU). The required signal distribution is built into the back-plane of the chassis minimizing the need for interconnecting cables. Our design is intrinsically optimized for new technologies operating at higher bandwidths.

Unlike other competing products, this product is designed for multi-operator, multi-service capabilities with higher output levels and lower system sensitivities. This equates to greater coverage range per antenna unit and hence lower implementation costs. When complete, this product will be available in both single-band units, i.e., US Cellular, GSM 900, US PCS-1900, and DCS-1800, and dual band units in which both low and high band services are supported within the same unit using the same fiber pair.

Figure 2. InCell™ Form Factors

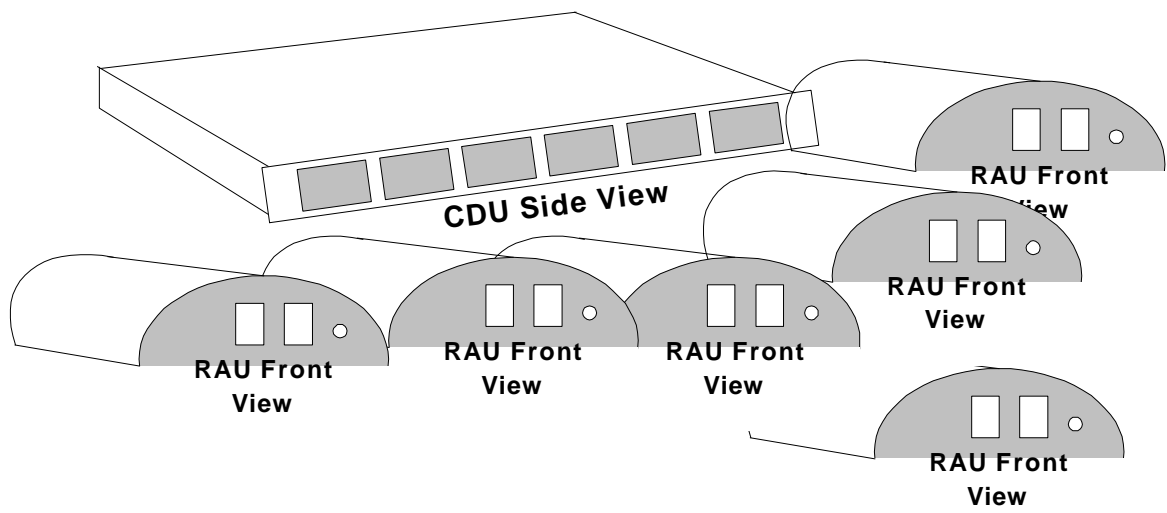

Central Distribution Unit (CDU)

The Central Distribution Unit (CDU) is the core module that can drive up to six Remote Antenna Units (RAU). The CDU separates the down and uplink RF signals and converts these to optics for transmission over a 2-core single-mode fiber cable to one of six RAU's.

The CDU (shown at Figure 3) is housed in a standard 1U, 19-inch rack mount unit and provides 6 sets of duplex optical fiber links to the remote antenna units.

Figure 3. InCell™ Central Distribution Unit

The figure below provides a detailed view of the CDU front panel, showing the six remote antenna interface ports. Each of the six ports is identical and provides DC power for the remote antenna as well as a downlink interface and an uplink interface with the remote antenna unit.

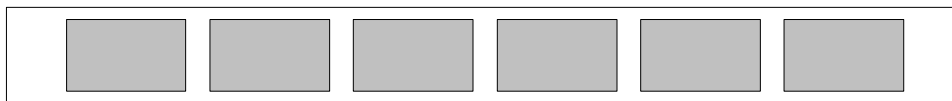

CDU FRONT PANEL

The rear view of the CDU shows the RF input/output connector as well as the power connection and the on/off switch. The RF connections are Type N.



CDU REAR PANEL

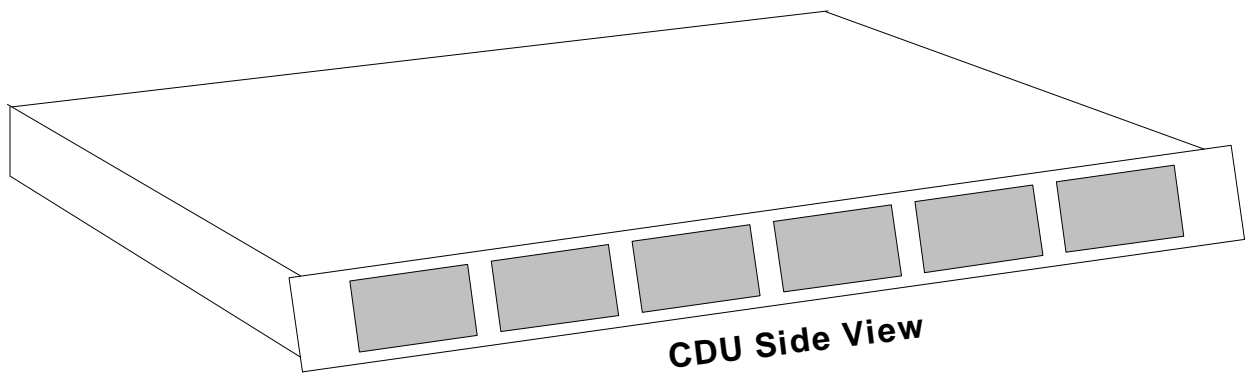

Remote Antenna Unit (RAU)

The RAU converts the signal back to RF and provides a single duplex downlink and uplink output port; and the dual band unit combines the two services to a single RF connector. The third order intercept point is high (33dBm typical), and the output can go directly to a multi-band antenna or be split to drive multiple antennas.

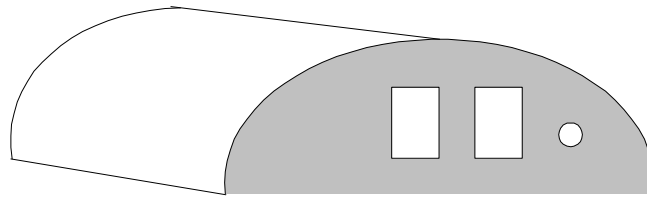

RAU Front View

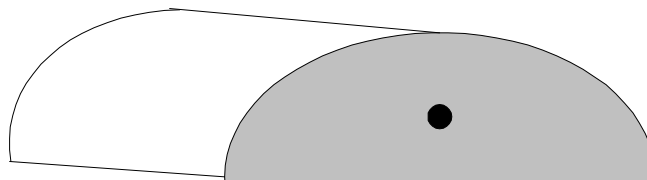

RAU Rear View

CDU Status Indicators

RAU Status Indicators

Alarm Output

Remote Monitoring Option

CDU to RAU Interface Cables

Composite Fiber Optic & Power Cables

Standard Duplex Fiber Optic Cables

Indoor Antennas

Andrew is developing several new low profile in-building antennas like the examples in Figure 4 and Figure 5. These dual band antennas are based on a product originally designed by our automotive accessory division. We anticipate releasing other antenna products in the next calendar year.

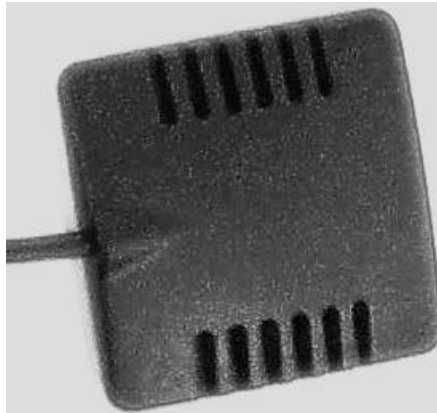

Figure 4. Andrew Dual Band Patch Antenna

Figure 5. Andrew Dual Band Omni Antenna

Outdoor Donor Antennas

Lightning Arrestors

Bi-Directional Amplifiers

Coaxial Cables and Jumpers

Distributed Antenna System Planning

InCell Distributed Antenna System Bill of Material

In-Building Implementations Using the Andrew InCell™ System

Scalable System Architecture

The InCell™ distributed antenna system is a scalable system that can be configured to support up to 384 antenna locations using three building block modules.

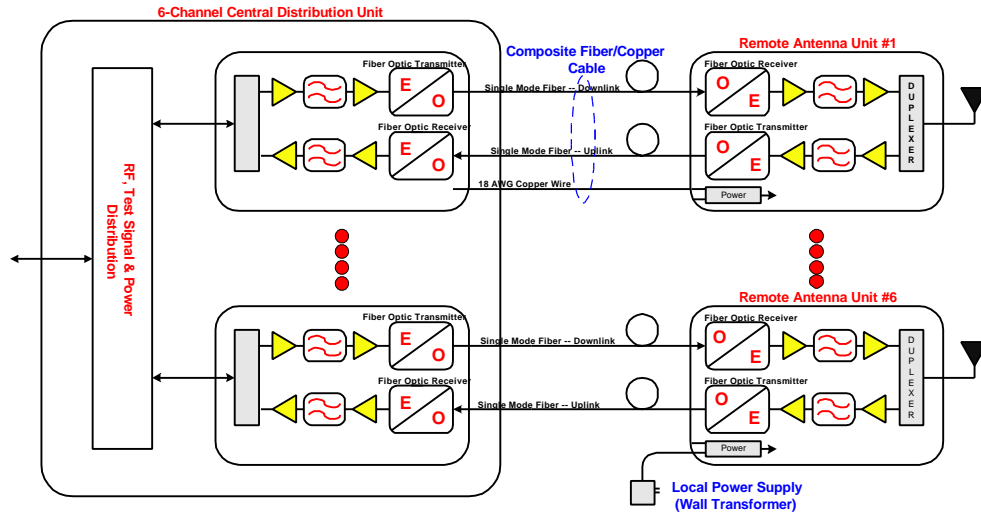

Figure 6. Simplified InCell™ Block Diagram

The RAU is (shown at Figure 7) weighs only 0.6 pounds and is 38 mm (length) x 127 mm (width) x 165 mm (height). This compact size makes it suitable for close mounting to the antenna.

Figure 7. Remote Antenna Unit

The Signal Distribution Unit

The third building block module is the Signal Distribution Unit (SDU). This is a 1U rack mount unit housing a standard 8-way power divider that is placed in front of the CDU to drive eight CDU's from one service input. Using an architecture of one SDU and eight CDU's, 48 antenna locations can be served (see Figure 8). Using an architecture of nine SDU's dividing the service signal to 64 CDU's, 384 antenna locations can be served (see Figure 9). These approaches are best housed coherently in 19-inch equipment racks as depicted in Figures 25 and 26.

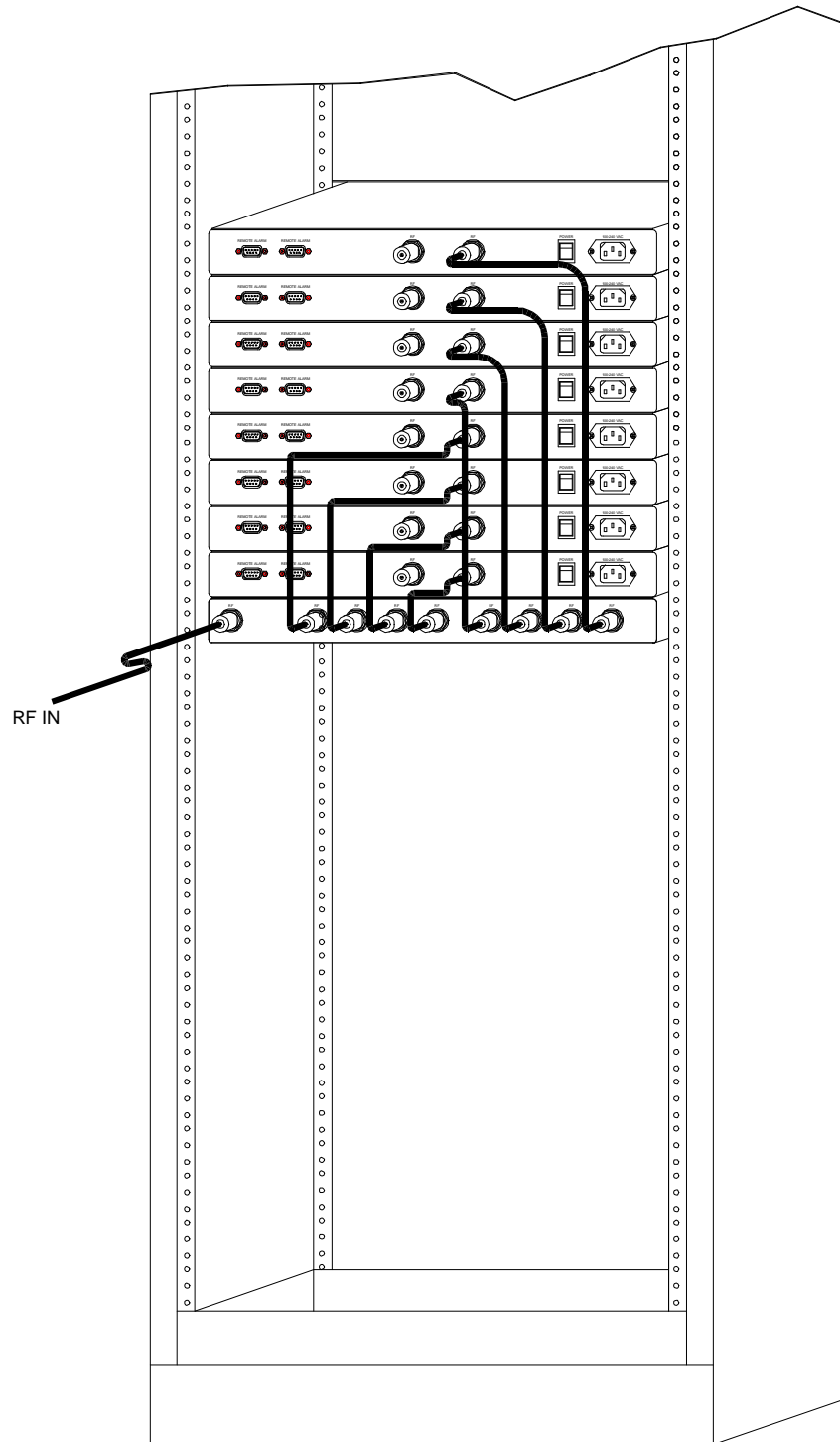

Figure 8. System expandability to 48 RAUs

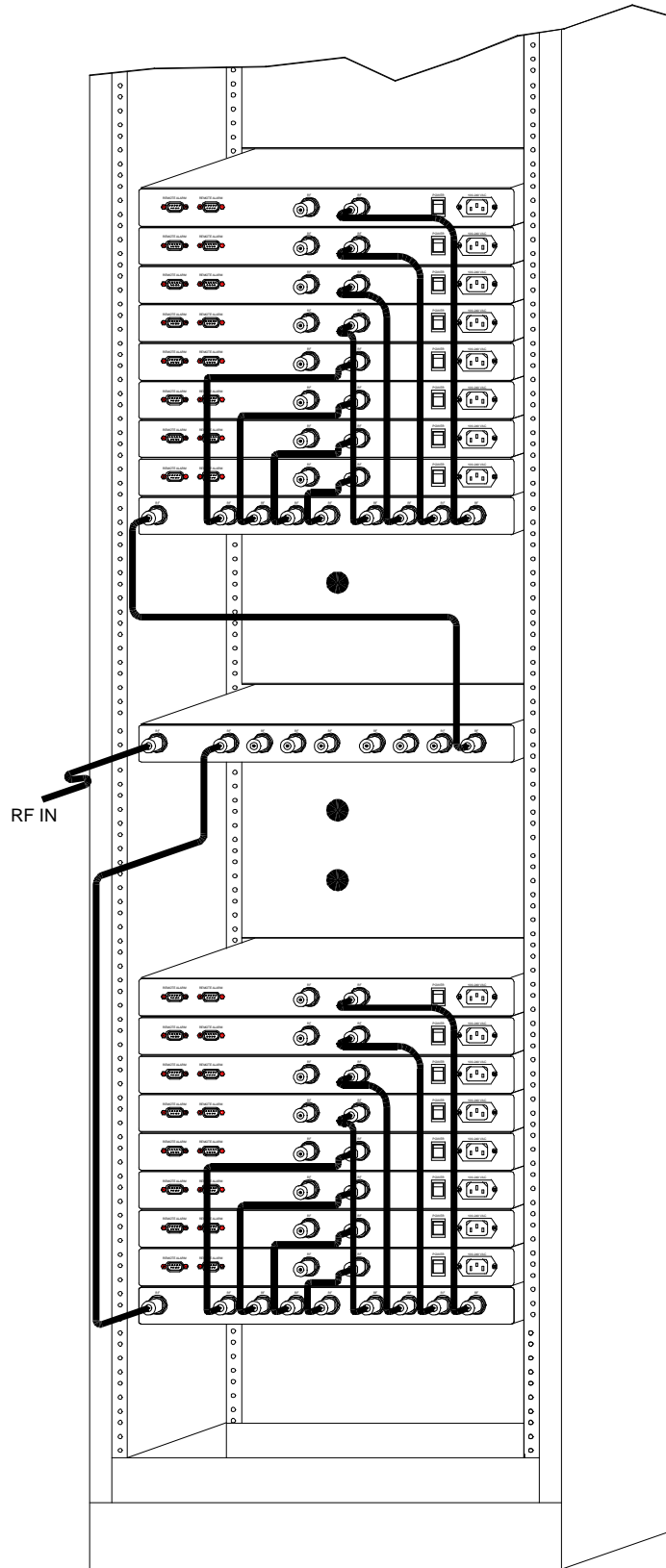
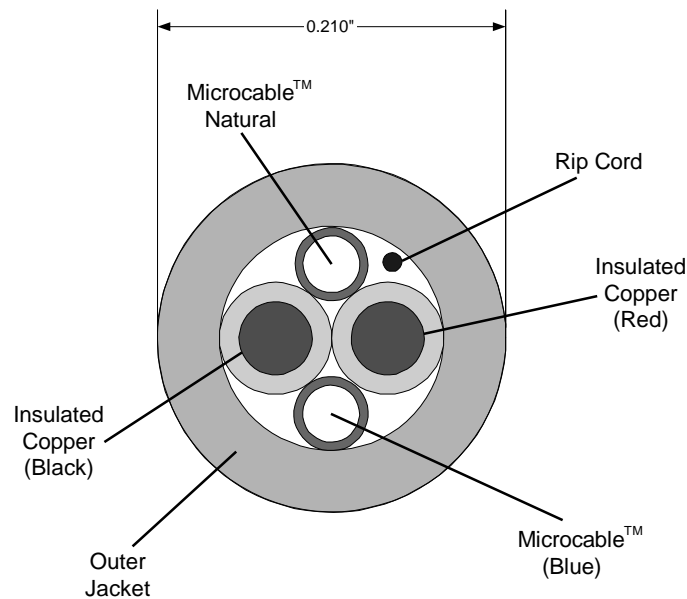

Figure 9. System Expandability to more than 48 RAUs

The Interconnecting Cable

Any single mode 2-core fiber cable can be used to drive the RAU a distance of 20Km from the CDU. In this configuration, power to the RAU is supplied from an external 12-28VDC source or an Andrew supplied universal (110/240VAC, 50/60Hz) wall transformer (wall wart). An Andrew manufactured composite cable is also available. This cable (shown at Figure 10) combines 2-core fiber and 2-conductor copper elements in a single jacket. Using this cable, power to the RAU is supplied by the CDU over the copper conductors eliminating the need for a separate RAU power supply. Although the composite cable greatly simplifies the installation process, the CDU-RAU separation is limited to 1.5Km. The limitation is the DC voltage drop from the CDU to the RAU over the copper conductors.



D00-37

Figure 10. Cross Section of Andrew Composite Fiber/Copper Cable

The Andrew composite cable is rugged, flexible and has an outside diameter of 0.21", making it easy to install. One optical fiber provides the downlink signal between the CDU and the RAU; the second optical fiber provides the uplink signal between the RAU and the CDU. These cables use industry standard SC type connectors to interface with the RAU and CDU. The two copper lines are used to provide DC power and ground signals to the RAU so that no additional power planning is required. System installers are not required to install AC power, conduit and transformers at each remote antenna location. With the CDU in the center of a system, remote antennas could be spaced as far as 3 km apart using the composite cable.

Andrew provides plenum rated and riser rated composite cables for in-building installation as fully tested cable assemblies and as bulk cable. The cables meet demanding building codes for safety. Tested cable assemblies are available in lengths of 50, 100, 150 and 200 meters, with optical and power connectors installed. Bulk composite cable is also available on spools and

requires system installers to add crimp-on connectors for the copper lines and add SC type connectors to the fiber cables. Refer to Andrew Catalog 38, pages 642-645, for full specifications of the plenum and riser rated cables. Andrew cable assemblies also come with a pulling hook and harness to make the cables easier to install.

If the in-building location for each of the remote antenna units is pre-planned and the distances are all known, then composite cables with connectorized ends and installation-ready wraps can be ordered to specific lengths. The other option is to buy reels of composite cable and then connectorize them in field. The connectors for the copper wires are fairly easy to crimp on, but the SC-connectors take a few minutes and require the use of a non-fusion based splicing device and well trained technicians to insure that reliable, low loss splices are made.

Single mode fiber optic cable is used in the InCell™ products because of its wide bandwidth and loss attenuation characteristics. Single mode fiber optic cable has the lowest attenuation of all fiber optic cable types and is typically lower in cost than multimode fiber cable. Single mode fiber is used in communications systems where high data rates and wide bandwidths are required. Wideband fiber optic line provides for unlimited future growth. Typical single mode cable loss is 0.4 dB per km. The loss of two SC connectors is typically 0.5 dB.

The SC type connector is the most popular connector type for the fiber-optic cables. The SC connector is the recommended connector in the EIA/TIA-568A building wiring standard. It provides a very reliable, low loss connection at a reasonable cost. The SC type connector is easy to install and provides positive feedback when correctly seated. SC connectors have good lock, pull and wiggle characteristics, ensuring that they will stay in place when installed and that they are immune to tension or lateral pressure on the fiber cable.

Figure 11 shows the RAU fiber and power connections.

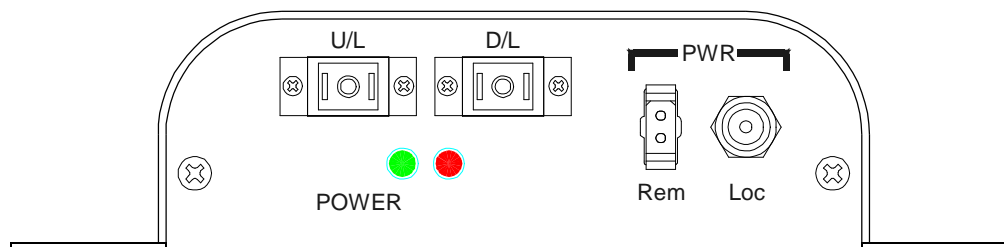

D00-44

Figure 11. Remote and Local Power Connections on the RAU

The Installation Parameters

Installation times will depend on the size of each installation; however, Andrew can provide rough guidelines for installing the CDU and RAU that may be used to determine the total system installation time once the number of equipment parts is determined.

The CDU may be mounted in a standard 19” equipment rack or on a wall. Allow 30 minutes for unpacking the CDU, installing the unit into the rack or wall and connecting the RF, fiber and power cables. Upon application of system power, front panel indicators will give the installer a visual indication of power and link status. Mounting hardware is provided for rack or wall mounting.

RAUs are typically mounted on walls or ceilings throughout the building. The units are small and lightweight and installers may carry multiple RAUs at one time to speed installation. Mounting the RAU to a wall or ceiling and connecting the fiber and power cables and the antenna takes only minutes. Upon application of system power, indicators on the RAU give the installer a visual indication of RAU power and link status. Mounting hardware is provided for the RAU.

To minimize system wiring times, Andrew composite cable is recommended to allow the fiber optic links and the power to be routed to each RAU in one small, easy to pull cable. The composite cables eliminate the need for conduit to each remote antenna location, improving wiring installation time.

Disruption to business is minimal as the CDU is typically installed in a electronic equipment room and the remote antennas and wiring may be installed after work hours. The cables are small and lightweight making them easy to pull through risers, above roofs and through tubes.

Site survey testing before and after installation may be done during business hours using small, portable RF measurement tools.



CDU REAR PANEL

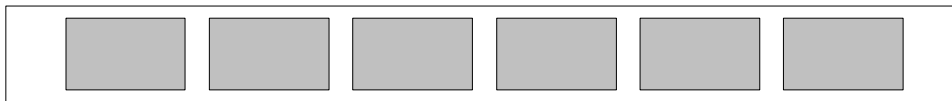

CDU FRONT PANEL

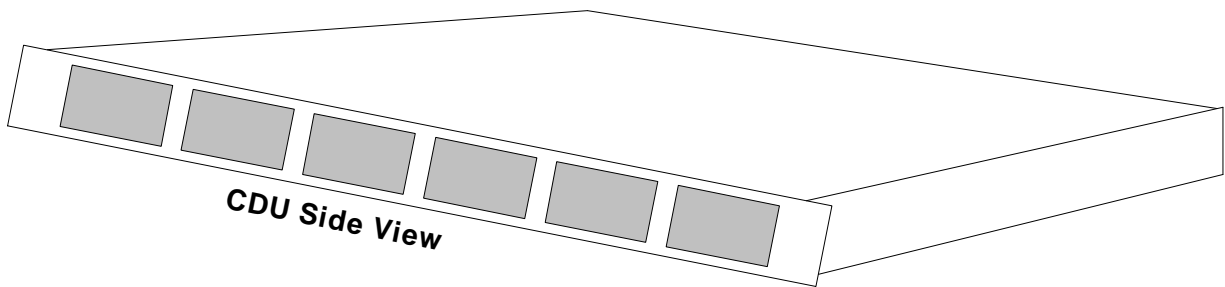

CDU Side View

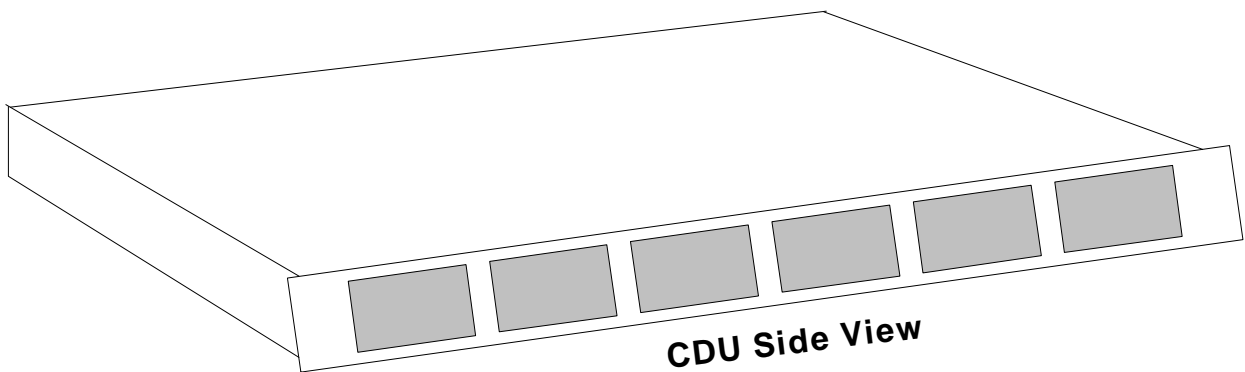

CDU Side View

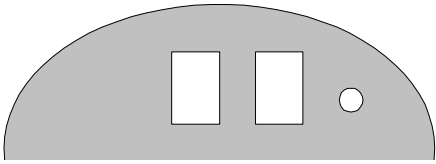

RAU Front View

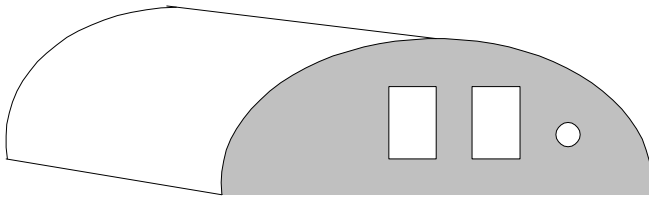

RAU Front View

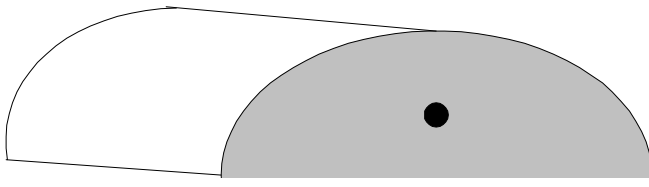

RAU Rear View

Sample Implementation

Figure 12 illustrates a small off-air implementation using an Andrew GridPACK donor antenna, an Andrew Cellular Extender (ACE), and a single InCell™ Central Distribution Unit driving up to six Remote Antenna Units. The donor antenna and extender can be replaced with other RF inputs, such as another off-air interface, a base station, or distribution unit depending on the application.

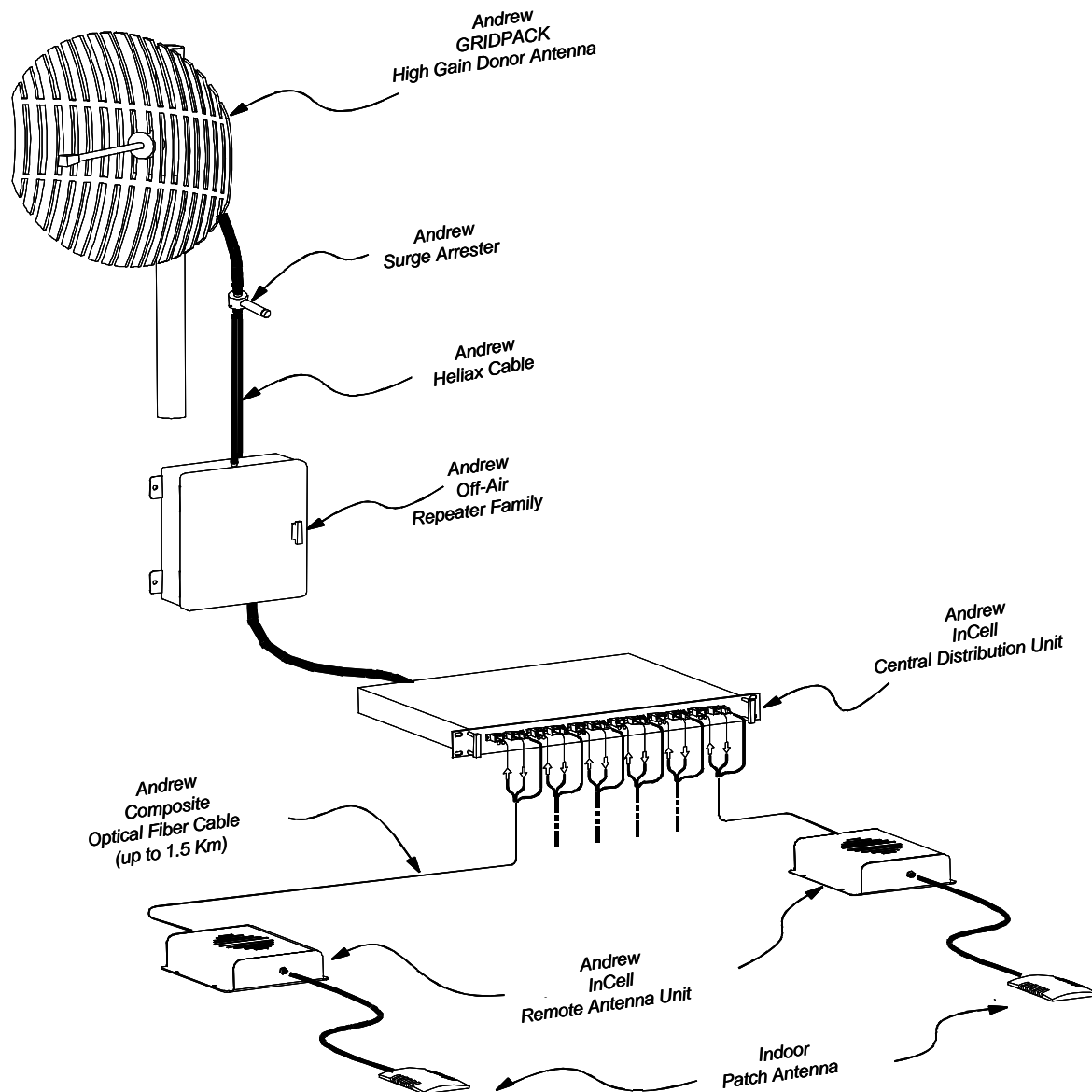

Figure 12. Typical System Configuration Using Off-Air Interface

InCell™ Specifications

Technical Performance

The technical specifications are summarized in Table 1.

Table 1. InCell™ Performance Specification

Wireless Service Standard	InCell Part Number	Downlink Passband (MHz)	Uplink Passband (MHz)
US Cellular (AMPS/TDMA/CDMA)	2000-1000-000	869-894	824-849
GSM-900	2000-2000-000	935-960	890-915
DCS-1800	2000-3000-000	1805-1880	1710-1785
PCS-1900	2000-4000-000	1930-1990	1850-1910
2.4 GHz ISM WLAN	2000-5000-000	2400-2500	2400-2500
US Cellular/PCS-1900	2000-6000-000	869-894/1930-1990	824-849/1850-1910
GSM-900/GSM-1800	2000-7000-000	935-960/1805-1880	890-915/1710-1785

InCell™ Uplink Performance	
Uplink Frequency Range	
2000-1000-000 (US Cellular)	824-849 MHz
2000-2000-000 (GSM-900)	890-915 MHz
2000-3000-000 (DCS-1800)	1710-1785 MHz
2000-4000-000 (PCS)	1850-1910 MHz
2000-5000-000 (WLAN)	2400-2500 MHz
2000-6000-000 (Dual Band)	824-849/1850-1910 MHz
2000-7000-000 (Dual Band)	890-915/1710-1785 MHz
End-to-End RF Gain (dB)	15 dB
Gain Flatness Over Frequency	+/- 2.5 dB
Maximum Input Power	Limiter threshold at -40 dBm
Noise Figure*	11 dB

InCell™ Downlink Performance					
Downlink Frequency Range					
2000-1000-000 (US Cellular)	869-894 MHz				
2000-2000-000 (GSM 900)	935-960 MHz				
2000-3000-000 (DCS-1800)	1805-1880 MHz				
2000-4000-00 (PCS)	1930-1990 MHz				
2000-5000-000 (WLAN)	2400-2500 MHz				
2000-6000-000 (Dual Band)	869-894/1930-1990 MHz				
2000-7000-000 (Dual Band)	935-960/1805-1880 MHz				
End-to-End RF Gain (dB)	15 dB				
Gain Flatness Over Frequency	+/-2.5 dB				
Maximum Input Power	20 dBm				
Return Loss	>17 dB				
Spurious/Intermodulation	-13 dBm for non-European Systems -36 dBm from 9 kHz to 1 GHz -30 dBm from 1 GHz to 12.75 GHz				
1 dB Compression Point	20 dBm				
Output Intercept Point	20 dBm				
Wideband Noise	-121.5 dBm/Hz				
CDMA Spectral Regrowth	-45 dBc				
Output Power	Analog	TDMA	CDMA	GSM-900	DCS-1800
	15 dBm, 2 carriers	15 dBm, 2 carriers	10 dBm, 1 carrier	10 dBm, 2 carriers	12 dBm, 2 carriers
	12 dBm, 4 carriers	12 dBm, 4 carriers	4 dBm, 2 carriers	7 dBm, 4 carriers	9 dBm, 4 carriers
	9 dBm, 8 carriers	9 dBm, 8 carriers		4 dBm, 8 carriers	6 dBm, 8 carriers

Interface Specifications

The BTS interface specifications are shown in Table 2 and the antenna interface specifications are in Table 3.

Table 2. BTS Interface Specifications

Requirement	Performance Specification	
Operational Bandwidth	Uplink	Downlink
GSM-900	890-915 MHz	935-960 MHz
DCS-1800	1710-1785 MHz	1805-1880 MHz
Dual Band 900/1800	890-915 MHz	935-960 MHz
	1710-1785 MHz	1805-1880 MHz
Connector Types- CDU	Type N	
RF	Type SC Single Mode Fiber	
Optical Fiber	Standard 3-pin "D" type	
AC Power (CDU only)	Molex 2-pin	
DC Power		
Connector Locations	RF and AC connectors on rear of CDU	
	Fiber and DC power on front of CDU	
Interface Type	Duplex (bi-directional port)	
RF	Single mode fiber: 1 uplink, 1 downlink	
Optical Fiber		
RF Impedance/VSWR	50 ohms, typical 10 dB return loss	
1 dB Compression Point		
Downlink	20 dBm	
Third Order Output Intercept Point	N/A	
Downlink		
Uplink		
Spurious Response	-36 dBm from 9 kHz to 1 GHz	
	-30 dBm from 1 GHz to 12.75 GHz	
Gain/Gain Linearity		
Downlink	15 db ± 2.5	
Uplink	15 db ± 2.5	
Group Delay	<1.0 usec (CDU, fiber and RAU)	

Table 3. Antenna Interface Specifications

Requirement	Performance Specification	
Operational Bandwidth GSM-900 DCS-1800 Dual Band 900/1800	Uplink 890-915 MHz 1710-1785 MHz 890-915 MHz 1710-1785 MHz	Downlink 935-960 MHz 1805-1880 MHz 935-960 MHz 1805-1880 MHz
Connector Types- RAU RF Optical Fiber AC Power (CDU only) DC Power	SMA Type SC Single Mode Fiber N/A Molex 2-pin	
Connector Locations	RF connector on rear of RAU Fiber and DC power on front of RAU	
Interface Type RF Optical Fiber	Duplex (bi-directional port) Single mode fiber: 1 uplink, 1 downlink	
RF Impedance/VSWR	50 ohms, typical 10 dB return loss	
1 dB Compression Point Downlink Uplink	20 dBm N/A	
Third Order Output Intercept Point Downlink Uplink	36 dBm -6 dBm	
Spurious Response	-36 dBm from 9 kHz to 1 GHz -30 dBm from 1 GHz to 12.75 GHz	
Gain/Gain Linearity Downlink Uplink	15 db ± 2.5 15 db ± 2.5	
Group Delay	<1.0 usec (CDU, fiber and RAU)	

Electrical Specifications

The power requirements for the first and second generation Central Distribution Units (CDU) are summarized in Table 4. The RAU is generally remotely powered from the CDU.

Table 4. Electrical Specifications

	Slim Line	Smart Rack 3U
Line Voltage	100 – 240 VAC, 47 – 63 Hz	100 – 240 VAC, 47 – 63 Hz
Power Consumption	40 Watts (CDU w/6 RAU's)	140 Watts (CDU w/20 RAU's)
Power Supply Redundancy	None	Hot Standby
Backup Power Supply	External	External

Environmental and Mechanical Specifications

The environmental and mechanical specifications are summarized in Table 5. We have not completed shock and vibration testing at this time.

Table 5. InCell™ Environmental and Mechanical Specification

Parameters	CDU	RAU
Enclosure Dimensions	1.75" H x 16.75" W x 12" D 1U, 19" rack-mountable	1.5" H x 5" W x 6.5" D
Enclosure Weight	4 pounds	0.6 pounds
RF Connector	N-female, bi-directional	SMA-female, bi-directional
Fiber Connector	6 pairs (12), SC Type	1 pair (2), SC Type
Remote Alarm from CDU	9-pin D-Sub with summary power and system link status	N/A
Local Alarm	One power and one link status LED per antenna port	One power and one link status LED
AC Power	100-240 VAC, 47-63 Hz	N/A
DC Power	24 VDC output to each RAU	+28 to +12 VDC input
Maximum DC Power Draw	CDU: 10 Watts System: 40 Watts with 6 RAUs	5 Watts
MTBF	> 27,000 hours	> 180,000 hours
Storage Temperature	-10 to +70° C	
Operating Temperature	0 to +50° C	
Humidity	0 to 95 % RH, non-condensing	

MTBF

A system MTBF using one CDU and six RAU's is calculated to be 26,954 hours for the slim line unit and 9,851 hours for a fully populated 3U 20 unit chassis. Each RAU has a MTBF of 181,265 hours. These MTBF values were calculated using the Bellcore part count method.

MTTR

Low MTTR values are achieved due to the extensive internally monitoring capability. The MTTR of the Slim Line unit is estimated at 15 minutes using a board replacement maintenance concept. The MTTR for the 3U chassis is less than 5 minutes as modules can be easily replaced while the unit is operating. The RAU MTTR is 5 to 30 minutes depending upon the complexity and ease of access to the installed device. The proposed maintenance concept for the RAU is a direct replacement of the unit.

InCell™ Network Monitoring System

The InCell™ family is designed to minimize maintenance and monitoring costs. Provisions are made for both local and remote monitoring of small and large systems. The InCell™ system continuously monitors and reports status of the system hardware, by a combination of indicators available at the central hub and at each remote antenna and alarms for remote monitoring that aid in system fault detection and fault isolation down to a circuit board or cable.

The wideband, single mode fiber cable allows a low frequency RF test signal to be continuously passed over the downlink and uplink signal paths with multiple RF wireless signals. In a dual band system, the 67 MHz pilot test signal, the 800 MHz service, and the 1900 MHz service signals simultaneously pass through the downlink and uplink paths.

Pilot Tone Generation

The CDU generates a continuous pilot tone for system level fault detection and isolation and distributes the signal to each RAU port. This low frequency RF tone is combined with the downlink RF signal and transmitted over the fiber optic cable to the RAU where it is received and filtered from the downlink RF signal. In the RAU, the pilot tone is filtered, amplified and combined with the RF uplink signal to be sent over the optical uplink path back to the CDU. Within the RAU, the pilot tone is detected by a threshold detector to indicate the presence of the pilot tone at a minimum signal level. The pilot threshold detector drives an LED on the RAU that indicates that the downlink optical signal path to the RAU is connected.

The return path pilot tone from the RAU is also filtered, amplified and detected. The detected pilot signal is passed to a threshold detector to indicate the tone presence at a minimum signal level. The pilot threshold detector in turn drives an LED at each port of the CDU indicating that both the downlink to the RAU and the uplink back to the CDU are connected and that power is properly functioning at the RAU.

RAU Indicators

The Power indicator on the RAU shows that DC power from the composite cable is present at the RAU. If the indicator is green, DC power is present in the RAU.

The LINK indicator on the RAU shows that the pilot tone from the CDU is present over the downlink. When the LINK indicator is off on the RAU, the downlink optical path between the CDU and the RAU is installed correctly and DC power is present in the RAU. If the LINK indicator is red, there may be a problem with the downlink optical path between the CDU and RAU or a problem with the RAU power. The RAU indicators allow system installers and maintainers to easily determine the RAU functional status, the power supply status, and the downlink optical path status.

CDU Front Panel Indicators

The Power indicator for each port of the CDU indicates that the DC power is present at that port. If the CDU Power indicator is green, power is good at that CDU port, also indicating that the internal AC power supply is good. If the Power indicator for one CDU port is off, there is

problem with that CDU port interface. If the Power indicators for all CDU ports are off, the AC power supply may be bad, AC power may be switched off or there may be another problem with the AC power.

The LINK indicator at each CDU port shows that the CDU generated pilot tone was sent over the downlink from the CDU to the RAU then received and transmitted over the uplink path from the RAU back to the CDU. When the CDU LINK indicator is off, the downlink and uplink optical paths are installed correctly and DC power is present in the RAU. If the LINK indicator is red, there may be a problem with the fiber optic signals between the CDU and RAU; a problem with the RAU power; or a problem with the RAU itself. The CDU indicators allow system installers and maintainers to easily determine each RAU functional status, power distribution to each RAU, and the correct connection of the fiber optic cables.

Alarm Functions

The CDU has two alarm outputs on the rear panel to indicate the overall health of the power supply and the uplink and downlink to each remote antenna units. The link alarm output is a summary alarm of all of system uplinks and downlinks and remote antenna power. The alarm outputs are through a DB-9 connector located on the CDU chassis rear panel.

Remote Monitoring Functions

As an option that will be available in February 2001, InCell™ Systems will support remote system health monitoring using standard protocols that will allow customers to monitor full system status. This feature uses an embedded processor (see **Error! Reference source not found.**) to monitor and report system health for the CDU and all RAUs, including power supplies, uplink and downlink paths and cables.

With this option, the InCell™ System hardware can be remotely monitored in three ways:

- ❖ Locally using a RS-232 connection to a terminal or PC (see Figure 13)
- ❖ Remotely using an SNMP Agent chassis connected to a telephone, LAN/WAN or other communications medium
- ❖ Remotely using dry-contact terminals connected to a third party SCADA

In the first method, the RS-232C interface option does not require a separate chassis. An RS-485 bus daisy chains the system status and alarms together as illustrated in Figure 13 and Figure 14. Communications between CDU's is accomplished over an RS-485 link, and the user can connect to the master bus using a standard computer or RS-232C terminal.

In the second method, a separate 1U chassis is required to act as the SNMP agent. The SNMP agent allows a network management system to monitor InCell™ device(s) by telephone or network connection using industry standard interfaces. The SNMP agent performs network management operations such as setting configuration parameters, alarm notification and current operation statistics. A database of the InCell™ network management information, called the management information base (MIB), is maintained by the Agent.

In the third method, dry contact alarm terminals can be connected to a third party SCADA system over copper wires.

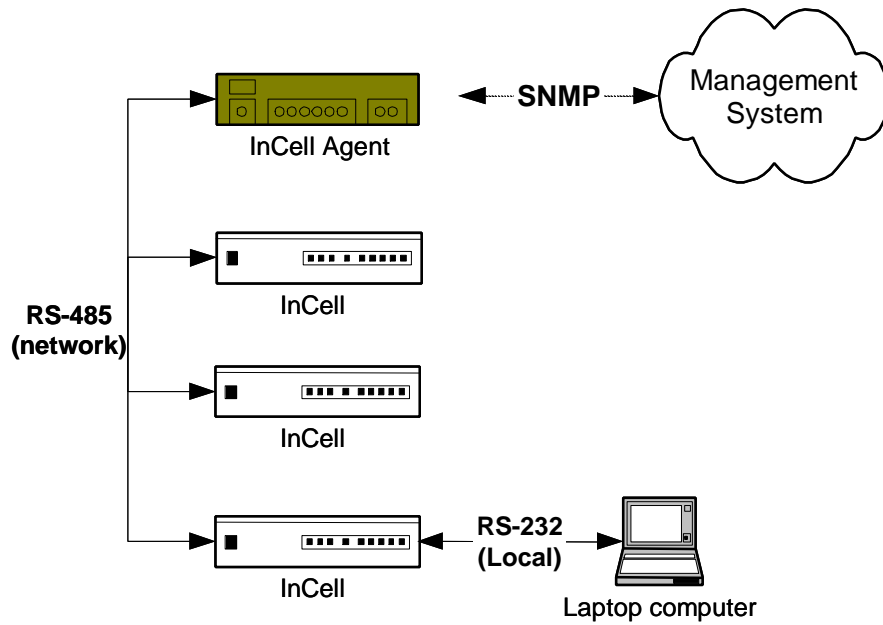

Figure 13. Remote Alarm Capability

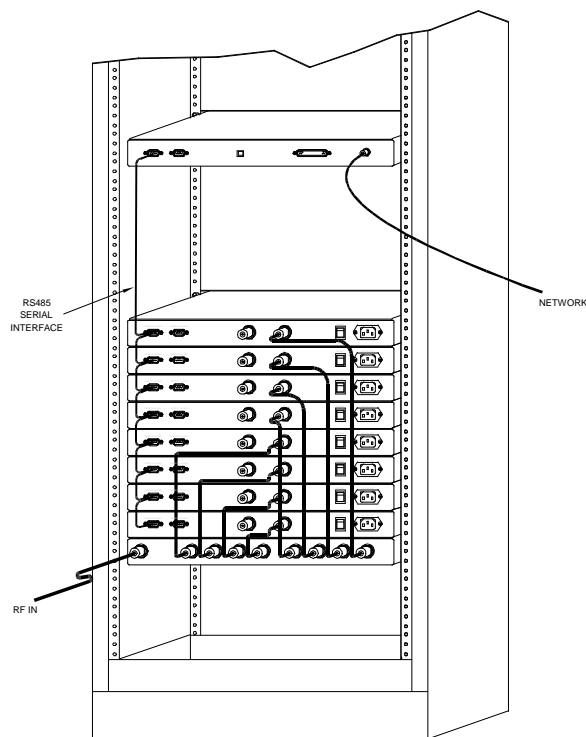

Figure 14. Daisy Chaining CDU's for Remote Monitoring

InCell™ Operation, Maintenance and Support

Operation

InCell™ system operation is continuous. Andrew recommends using an uninterruptible power supply (UPS) to provide power to the CDU. If the system uses composite cable to provide power to the remote antenna units located throughout the building, the UPS can keep the CDU and all RAUs powered and operational during brownouts and power outages.

Unlike some hybrid fiber distributed antenna systems that use frequency translation in the wireless distribution process, the InCell™ uses no frequency synthesizers or synchronizing circuitry that may be affected by power failures. The InCell™ operates immediately after power is applied and is not susceptible to power failures.

Regular Maintenance

Minimal maintenance is required to support installed InCell™ systems. System maintainers should ensure that all RF, power and fiber connectors are tight and that the CDU is mounted with adequate room to allow air to flow into the chassis. Indicator LEDs show system status while relay and optional remote alarm interfaces allow small or large system status to be monitored. Andrew does recommend using a commercially available fiber optic cleaning kit to maintain clean fiber optic connections. Typically, after system installation, no removal or cleaning of the fiber connectors will be required.

Fault Repair

If a fault is detected in the system, maintainers can determine the problem cause problem by reviewing reports from remote monitoring systems or by observing the front panel LED indicators on the CDU chassis. Because the different CDU ports correspond to different remote antenna locations, maintainers can determine where the problem exists in the building. Maintainers can replace RAUs in the building without having to power down the system. If a CDU fails, spare CDU boards can be installed.

Support

Andrew engineers and technicians familiar with the operation of the InCell™ system are available Monday through Friday, 8am to 5pm CST. These personnel are familiar with distributed in-building antenna systems, with fiber optic cable installation and with troubleshooting and in-building coverage solutions.

In special cases, Andrew has provided local support of indoor wireless distributed antenna systems. Please contact Andrew DCS if this type of maintenance support is required.

Spare Policy

For the Slim Line CDU assembly, we recommend sparing at the board level. This unit is comprised of 2 unique board types and a power supply module. There is a single printed circuit board that provides the necessary RF power, DC and alarm distribution and 6 identical printed

circuit boards that perform the gain and optical conversion (see **Error! Reference source not found.**). If the remote monitoring option is selected, there is a third 2-teir printed circuit board.