

EXHIBIT D
INSTRUCTION BOOK

A. INSTRUCTION BOOK:

The User's Guide for this product has been included as Exhibit
D.

6 October 1997

**USER'S GUIDE
for the
SELECTAMP 1800
CDMA CHANNELIZED AMPLIFIER SERIES**

**MANUAL NO. AE02B-A0274
REVISION --**

The information set forth in this document and all rights in and to inventions disclosed herein, and patents which might be granted thereon disclosing, employing or covering the materials, methods, techniques or apparatus described herein are the exclusive property of Andrew Corporation.

This document is an operation and maintenance manual. No disclosure or reproduction of the information or drawings shall be made of any other purpose without the prior written consent of Andrew. Use of the information contained herein to fabricate or assemble any item in whole or in part is expressly prohibited.

These goods are subject to U.S. Department of State, International Traffic in Arms Regulations, 22 CFR 120-130.



**2425 N. Central Expressway, Suite 800, Richardson, Texas 75080
TEL (972) 235-7300 FAX (972) 234-6014**

LIST OF EFFECTIVE PAGES

Dates of issue for original and changed pages are:

Original O 1 July 1997

**TOTAL NUMBER OF PAGES IN THIS PUBLICATION IS 42
CONSISTING OF THE FOLLOWING:**

Page	Change No. (O = Original Page)
Title Page	O
List of Effective Pages (i)	O
Safety Summary (ii)	O
Table of Contents (iii - iv)	O
Chapter 1 (1-1 thru 1-5)	O
Chapter 2 (2-1)	O
Chapter 3 (3-1 thru 3-4)	O
Chapter 4 (4-1 thru 4-5)	O
Appendix A (A-1 thru A-5)	O
Appendix B (B-1 thru B-15)	O
Appendix C (C-1 thru C-2)	O

SAFETY SUMMARY

High voltage is used in the operation of this equipment. Death on contact may result if personnel fail to observe the following safety precautions:

- Do not be misled by the term "Low Voltage." Potentials as low as 50 volts may cause death under adverse conditions.
- Do not crush, puncture, disassemble, or otherwise mutilate batteries. Leaking batteries can cause serious damage to equipment and injury to personnel.
- Do not remove covers or access plates on the equipment unless you are authorized to do so.
- Do not work on electronic equipment unless there is another person nearby who is familiar with the operation of the equipment and is trained in administering first aid.
- Whenever possible, disconnect the equipment from the power source before beginning maintenance.
- To prevent electrical shock or damage to the equipment, do not operate it until you thoroughly understand the operation and function of all controls, indicators, and connectors.
- Turn off all power to the equipment before replacing any fuses.

FIRST AID

In case of electrical shock:

- Do not try to pull or grab the individual.
- If possible, turn off the electrical power.
- If you cannot turn off the electrical power, pull, push, or lift the person to safety using a dry wooden pole, a dry rope, or some other insulating material.
- Send for help as soon as possible.
- After the injured person is no longer in contact with the source of electrical shock, move the person a short distance away and immediately administer first aid and artificial resuscitation as required.

TABLE OF CONTENTS

CHAPTER 1 DESCRIPTION	1-1
1.1 OVERVIEW	1-1
1.2 ELECTRICAL SPECIFICATIONS	1-1
1.3 MECHANICAL SPECIFICATIONS	1-2
1.4 ENVIRONMENTAL SPECIFICATIONS	1-2
1.5 TECHNICAL ASSISTANCE	1-2
CHAPTER 2 OPERATIONAL OVERVIEW	2-1
2.1 OVERVIEW	2-1
2.2 RF DISTRIBUTION	2-1
2.3 POWER DISTRIBUTION	2-1
2.4 CONTROL DISTRIBUTION	2-1
CHAPTER 3 FUNCTIONAL DESCRIPTION	3-1
3.1 OVERVIEW	3-1
3.2 FUNCTIONAL DESCRIPTION	3-1
3.2.1 Diplexer	3-1
3.2.2 LNA/Attenuator	3-1
3.2.3 Channelizer	3-1
3.2.3.1 Downconverter	3-1
3.2.3.2 Upconverter	3-3
3.2.3.3 Synthesizer	3-3
3.2.4 Power Supply	3-3
3.2.5 Interconnect Board	3-3
3.2.6 Power Amplifier Module	3-3
3.2.7 Status and Control Module	3-3
3.2.8 Battery Back Up Option	3-4
3.2.9 Mounting Kit Options	3-4
3.3 PROGRAMMING	3-4
CHAPTER 4 MAINTENANCE	4-1
4.1 MAINTENANCE PROCEDURES	4-1
APPENDIX A AMPLIFIER INSTALLATION	A-1
APPENDIX B SOFTWARE INSTALLATION	B-1
APPENDIX C APPLICATION NOTES	C-1

LIST OF FIGURES

Figure 1-1 SelectAmp 1800 Outline Drawing	1-3
Figure 1-2 SelectAmp Internal View	1-4
Figure 1-1 SelectAmp 1800 Outline Drawing	1-5
Figure 3-1 SelectAmp Exploded View	3-2

LIST OF TABLES

Table 1-1 Electrical Specifications	1-1
Table 1-2 Mechanical Specifications	1-2
Table 1-3 Environmental Specifications	1-2

CHAPTER 1

DESCRIPTION

1.1 OVERVIEW

The SelectAmp 1800 bi-directional channelized amplifier provides selective frequency amplification of user specified frequencies in the 1850 -1910 MHz Uplink and 1930 -1990 MHz Downlink PCS bands. This unit will selectively filter for one 1.25 MHz CDMA channel in the Uplink and Downlink band as determined by the operator. Frequency selection, gain adjustment and fault monitoring is accomplished with monitor and control circuitry and firmware.

Within this manual, "Uplink" refers to the RF signal path from the mobile unit to the base station (Donor Cell) and the "Downlink" refers to the RF signal path from the base station to the mobile unit.

1.2 ELECTRICAL SPECIFICATIONS

Table 1-1 below contains the electrical specifications for the Band Selective Amplifier.

Table 1-1 Electrical Specifications	
Parameters	Specification
Frequency Range	Uplink = 1850 - 1910 MHz. Downlink = 1930 - 1960 MHz.
Power	Three wire, 90 to 260 VAC @ 240 watts.
3 dB Bandwidth	1.5 MHz.
Filter Roll Off	40 dB @ 6 MHz BW tot. 50 dB @ 15 MHz BW tot.
Noise Figure	8 dB maximum.
RF Port Impedance	50 ohms nominal.
Maximum Input Signal Without damage	+10 dBm with no attenuation.
CDMA Power Output	2 watts.
Spurious Emissions (Meets J-STD-008 @ 2 watt channel power)	(Measured from filter center frequency). -45 dBc min @ \pm 885 KHz. -13 dBm max @ \pm 1.25 MHz. -45 dBm min @ \pm 1.25 MHz.
In-Band Spurious	-30 dBm or better at 80 dB gain.
Status	Frequency setting, gain setting, and module failure via phone interface.
Power Gain, Each Channel	65 to 95 dB, adjustable in 2 dB steps.
Power Requirements	+22 VDC \pm 10 percent @ 10 amps typical.

1.3 MECHANICAL SPECIFICATIONS

Table 1-2 below contains the mechanical specifications for the Band Selective Amplifier.

Table 1-2 Mechanical Specifications	
Parameters	Specification
Size	Amplifier: Height: 41 cm (16.3 inches). Width: 31 cm (12 inches). Depth: 31 cm (12 inches). (Excluding heatsinks, connectors, handles, and feet.)
Weight	Amplifier: 55 lbs (25 kg).
Mounting	Four holes spaced (295 x 371 mm) (11.6 x 14.62 inches). Hole diameter = 0.453 inches.
Power Connections	+ 24 VDC (seven meter cable supplied with unit).
RF Connections	Type N female.

1.4 ENVIRONMENTAL SPECIFICATIONS

Table 1-3 below contains the environmental specifications for the Band Selective Amplifier.

Table 1-3 Environmental Specifications	
Parameters	Specification
Temperature Range (Operating)	Operating: -40 to +60°C (Vertically mounted with unobstructed airflow.) Storage: -40° to +70°C.
Humidity Range (Operating)	Up to 90 percent non-condensing.
Environmental Protection	NEMA type 4 (IP 66).

1.5 TECHNICAL ASSISTANCE

Technical assistance on this or any other Andrew product is available 24 hours per day through:

Andrew Customer Service
Telephone: 1-800-255-1479
Fax: 1-708-349-5444

AE02B-A0274 Rev --

DESCRIPTION

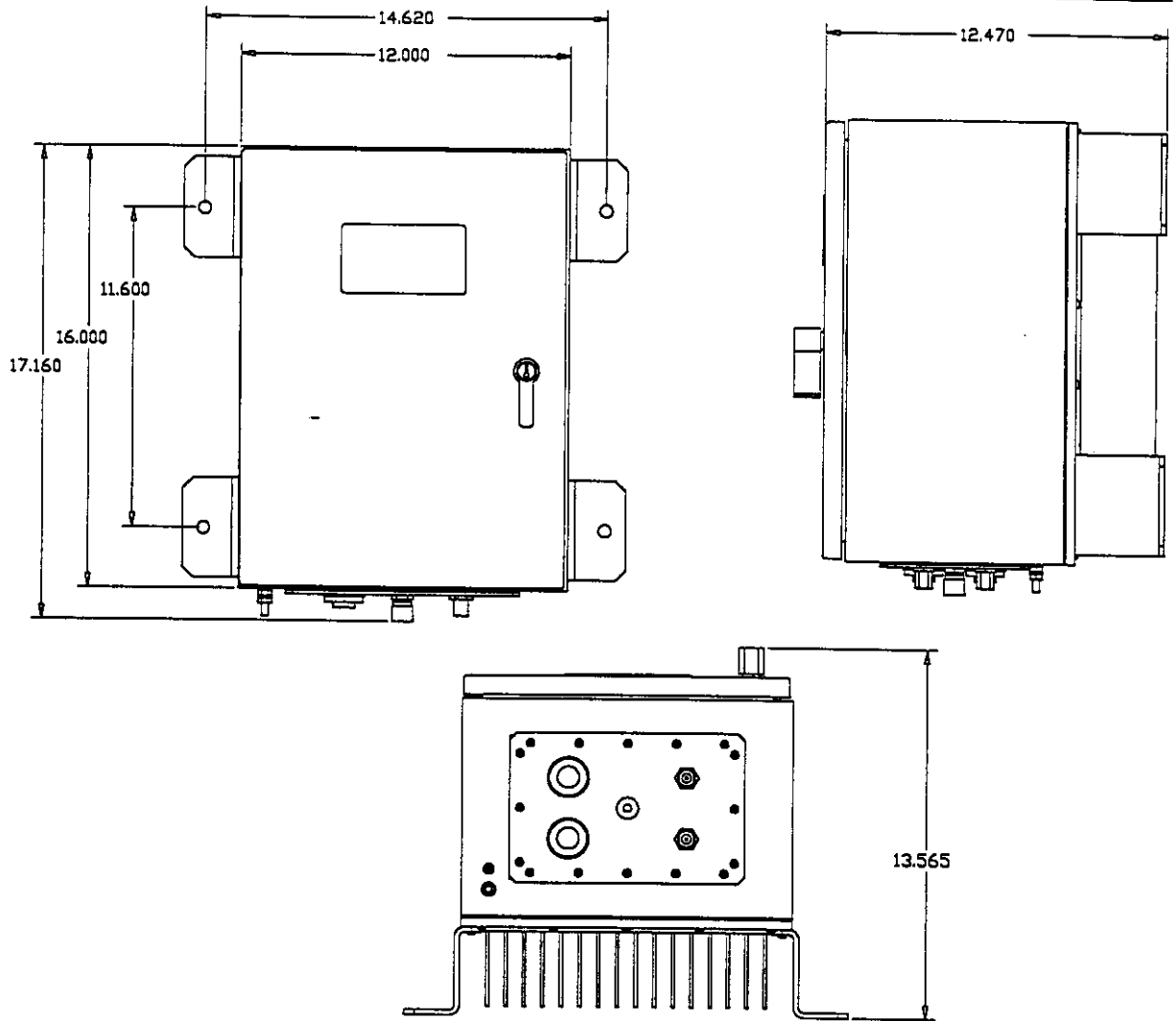

Figure 1-1 SelectAmp 1800 Outline Drawing

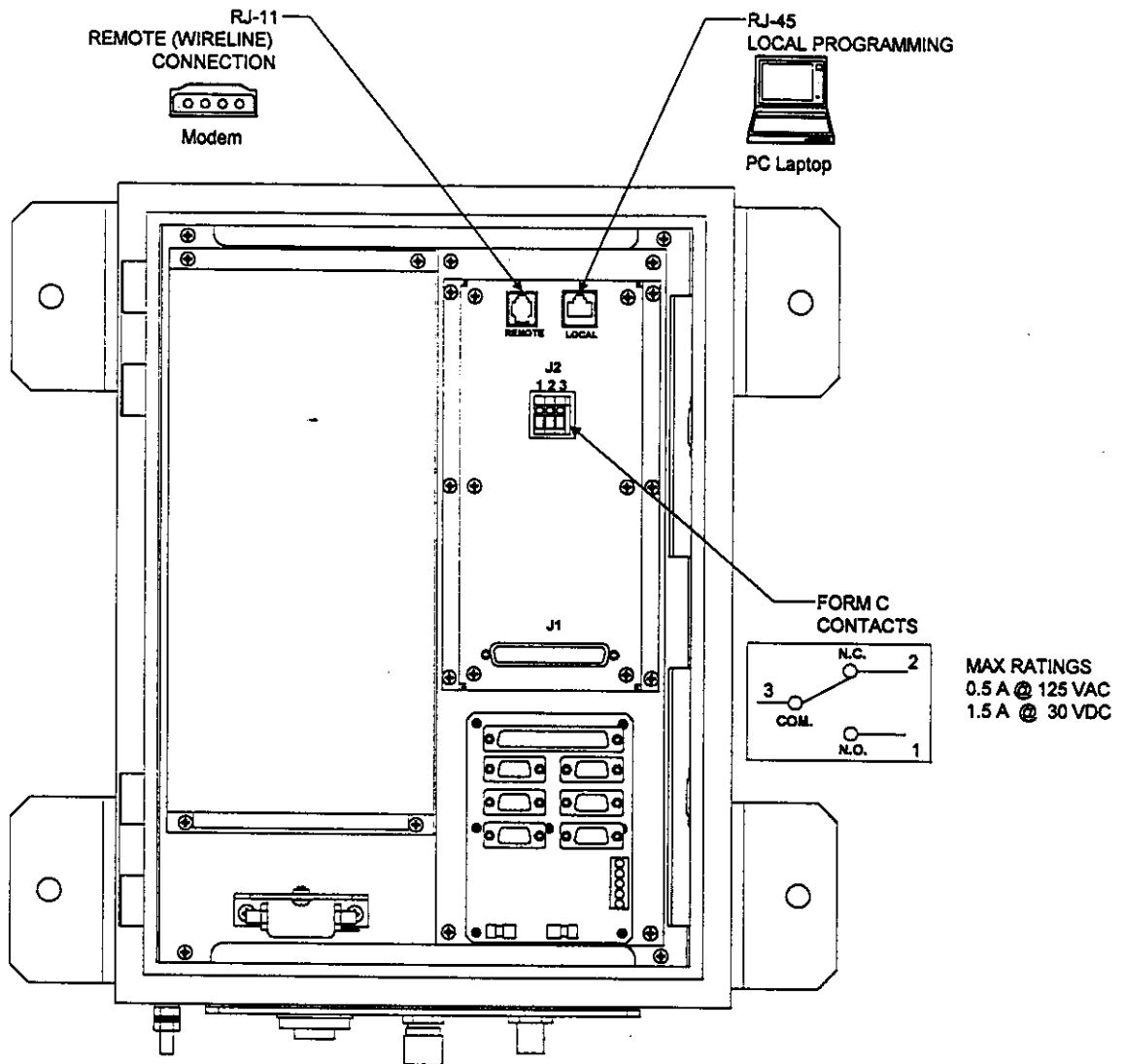

Figure 1-2 SelectAmp Internal View

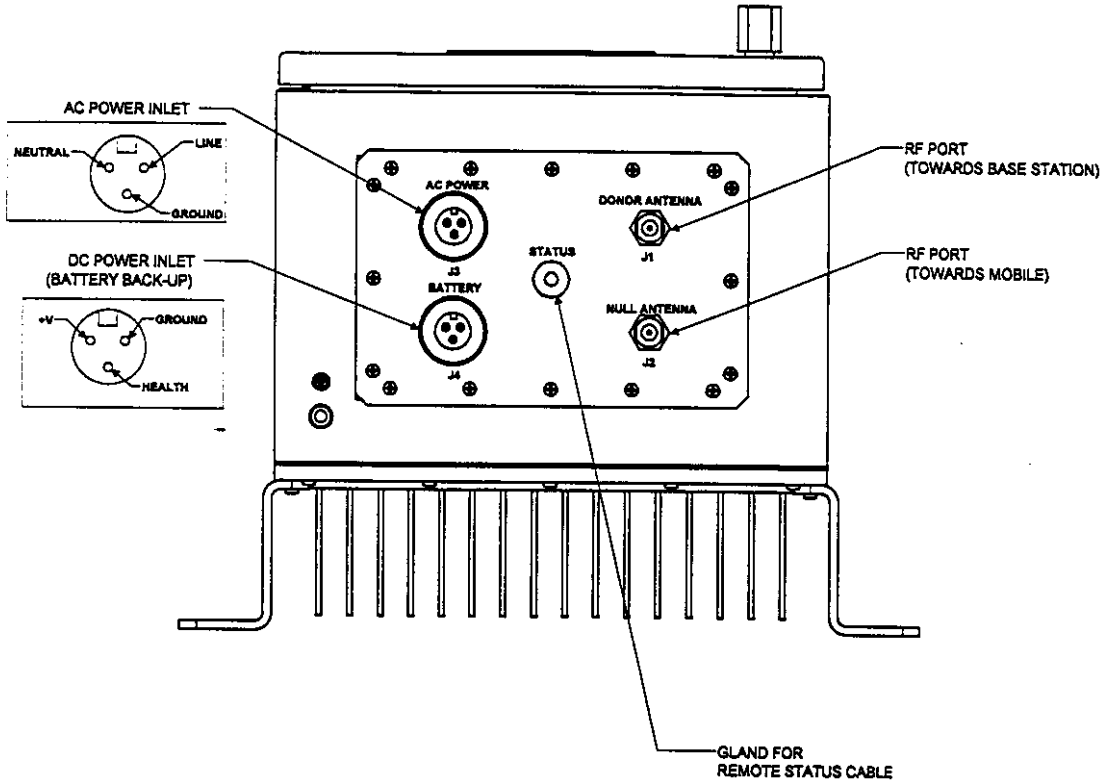

Figure 1-3 SelectAmp Connector Panel

CHAPTER 2 OPERATIONAL OVERVIEW

2.1 OVERVIEW

The SelectAmp channelized amplifier accepts a broadband input in the 1850 - 1910 uplink and 1930 -1990 MHz downlink bands, and selectively passes one CDMA discrete channel in each band while rejecting the others. This is accomplished by downconverting the desired signals to a 140 MHz intermediate frequency and using narrowband SAW filters to provide adjacent channel rejection.

2.2 RF DISTRIBUTION

The amplifier contains two paths; forward for the base station, and reverse for the mobile signal. Each path includes a diplexer, low noise amplifier, channelizer, and power amplifier. The diplexers and channelizers determine the frequencies to be amplified.

2.3 POWER DISTRIBUTION

Main power for the amplifier is provided by a 12 amp power supply operating at +22 VDC. The power supply accepts 90 - 260 VAC inputs. The interconnect board distributes +22 volts, +5 volts, and -5 volts to the various modules.

2.4 CONTROL DISTRIBUTION

The operator has control over the gain and operating frequency of each path. Computer inputs for gain and channel settings are routed to each low noise amplifier and channelizer. The gain setting is a four bit word that sets gain from +2 to +32 dB. The channel setting is a three wire serial input to a synthesizer in each channelizer. Each module outputs a status message to indicate the overall condition of the active devices. If an active device fails, the module reports a fault.

CHAPTER 3

FUNCTIONAL DESCRIPTION

3.1 OVERVIEW

The SelectAmp Channelized Amplifier accepts a broadband input in the 1850-1910 uplink and 1930-1990 MHz downlink bands, and selectively passes one CDMA discrete channel in each band while rejecting the others. This is accomplished by downconverting the desired signals to a 140 MHz IF and using narrowband SAW filters to provide adjacent channel rejection.

3.2 FUNCTIONAL DESCRIPTION

Refer to Figure 3-1. Each path in the SelectAmp consists of four major modules: diplexers, LNA/attenuator, channelizer, and power amplifier. These four modules are powered by, interconnected by, and monitored by the power supply, interconnect board, and the status and control module respectively. Diplexing of the uplink and downlink signals is accomplished by diplexer filters tuned to the required PCS band (A, B, C, D, E, or F).

These modules perform the function of selecting one 1.25 MHz channel out of a predetermined PCS band for amplification.

3.2.1 Diplexer

The diplexer module consists of dual filters with a common port on one end and two separate ports on the other. One side of the diplexer is tuned for the uplink band, the other side for the downlink band. Insertion loss of each filter is 2 dB maximum and 65 dB minimum rejection to the opposite band.

3.2.2 LNA/Attenuator

The LNA/attenuator module contains three gain stages and a digitally controlled attenuator. The overall gain of each path can be adjusted between 65 and 95 dB.

3.2.3 Channelizer

The channelizer module contains three boards shielded by aluminum dividers. These three boards, which are described below, provide the channel selectivity for the SelectAmp. Channelizer module gain is 24 dB minimum.

3.2.3.1 Downconverter

The downconverter board consists of a mixer driven by a synthesizer, a SAW filter centered at 140 MHz with a 1.5 MHz, 3 dB bandwidth, and two gain stages. The DC current draw of each gain stage is monitored by a window comparator for status. The window comparator will indicate a fault, if the gain stage has an open or short failure. The output of the down converter is fed to the upconverter board.

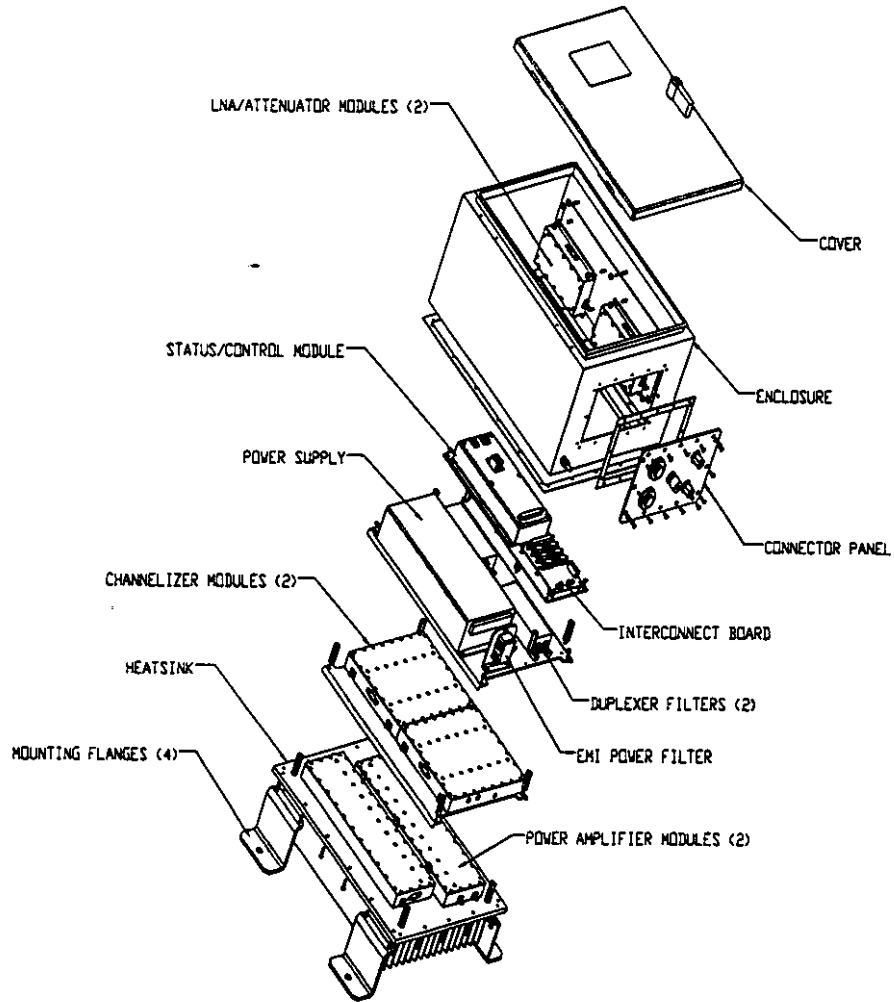

Figure 3-1 SelectAmp Exploded View

3.2.3.2 Upconverter

The upconverter board mixes the filtered 140 MHz IF with a signal from the synthesizer and outputs the same frequency that was input to the downconverter. Like the downconverter, each upconverter path consists of a mixer and two gain stages. The DC current draw of each gain stage is monitored by a window comparator. The window comparator indicates a fault, if the gain stage has an open or short condition.

3.2.3.3 Synthesizer

The synthesizer board consists of a synthesizer circuit that is driven by a reference oscillator and distribution amplifiers. The synthesizer operating frequency is programmed from the status and control module. The uplink and downlink frequencies are set with a computer that has Andrew designed frequency control software installed on it. This software is a Microsoft Windows application that allows the operator to input the desired RF frequency and gain setting. The frequency of the synthesizer is determined as follows:

$$\begin{aligned} \text{Uplink} &= 1710 \text{ MHz} + (50 \text{ KHz} \times N) \\ \text{Downlink} &= 1790 \text{ MHz} + (50 \text{ KHz} \times N) \\ \text{Where } N &= \text{Channel Number (0-1199)} \end{aligned}$$

The status and control module converts the operator's input to the appropriate frequency command for the synthesizer. The output of the synthesizer is divided into a downconverter path and an upconverter path.

3.2.4 Power Supply

The power supply assembly consists of an in-line EMI filter, switching power supply, and interface cable. The power supply accepts a 90 to 264 VAC input and outputs +24 VDC for use by the rest of the amplifier. Power is distributed to the active modules through the interconnect board.

3.2.5 Interconnect Board

The interconnect board serves to distribute power to the other modules, and interfaces with the status and control module for control and monitor of the modules. The interconnect board consists of nine pin, D-subminiature connectors, and voltage regulators.

3.2.6 Power Amplifier Module

The power amplifier module provides the final gain and power stages for the amplifier. Four cascaded stages provide a minimum of 45 dB gain. The DC current draw of each gain stage is monitored by a window comparator. The window comparator will indicate a fault if the gain stage goes into a hard failure (open or short) mode. Additionally, a temperature circuit monitors the module for an over temperature condition.

3.2.7 Status and Control Module

The status and control module provides status information and control capabilities at the local and remote connections. Control functions include synthesizer channel selection and individual channel attenuation settings. Status information includes module summary status for the LNA/attenuator, channelizer, power

amplifier and battery backup. In addition to power amplifier status, power amplifier temperature status is also provided.

3.2.8 Battery Back Up Option

The battery back up (BBU) provides emergency operating power in case of AC power loss. Under normal conditions, the BBU is charged by an internal charger. If AC power loss occurs, the BBU automatically comes on-line and this condition is reported to the status and control module. The BBU will power the SelectAmp 1800 for approximately two hours. The unit has been sized for back up capability over the full -40° to +60°C temperature range.

3.2.9 Mounting Kit Options

A mounting kit (EENCL-90004) is available for ease of installation on walls or poles. Refer to Appendix A for installation instructions.

3.3 PROGRAMMING

The amplifier and channel number are set by connecting a laptop computer with the supplied cable and adapter to the RJ-45 (see Figure 1-2) port. Remote access is available by wireline connection to the RJ-11 port. To set a specific channel number or gain refer to Appendix B.

CHAPTER 4 MAINTENANCE

4.1 MAINTENANCE PROCEDURES

The SelectAmp contains no user-serviceable parts. To verify operation check the amplifier against the electrical specifications provided in Chapter 1. If the amplifier does not meet these specifications, return the defective unit to the address below for repair:

Technical Services
Andrew Corporation
2908 National Drive
Garland, Texas 75041
Telephone 972-864-6228
Fax 972-278-9379

To ensure the rapid repair and return of defective items, certain information must accompany any return. Please call the Andrew SciComm Technical Support Hot Line and request the Customer Return Instructions. The hot line is available, 8:00 a.m. to 5:00 p.m. CST, Monday through Friday, by calling (972) 864-6228.

APPENDIX A AMPLIFIER INSTALLATION

1. List of Material

- Qty 1 - SELECTAMP 1800 Amplifier
- Qty 1 - User Manual (AE02B-A0274)
- Qty 1 - Programming Cable (ECATL-80700)
- Qty 1 - Adapter, RJ45 to DB9 (AE02M-D0149-001)
- Qty 1 - Adapter, RJ45 to DB25 (AE02M-D0149-002)
- Qty 1 - Power Cable, 12 ft. (AE02C-D3300-001)
- Qty 1 - Diskette containing SMART software for Amplifier Control (385615-9001-001)

2. Tools Required

- Qty 1 - 3/8 in. Electric Drill
- Qty 1 - 3/8 in. Diameter Drill Bit
- Qty 1 - 3/8 in. Diameter Masonry Drill Bit
- Qty 1 - No. 2 Phillips Screw Driver
- Qty 1 - No. 2 Flat Head Screw Driver
- Qty 1 - 9/16" Wrench
- Qty 1 - Pair of Medium Wire Cutters
- Qty 1 - Laptop Computer
- Qty 1 - Amplifier Mounting Kit (EENCL-90004)

3. Determine Location for Amplifier

1. Determine if the amplifier will be mounted on a wall or a pole.
2. If amplifier is going to be mounted on a wall, is it concrete or wallboard?
3. If amplifier is going to be mounted on a pole, what is the diameter of the pole? The amplifier mounting kit will support a pole up to 24 inches in diameter.
4. Locate the amplifier within 12 feet of a 110-250 VAC @ 50/60 Hz Electrical Outlet

4. Amplifier Wall Installation, Figure 1.

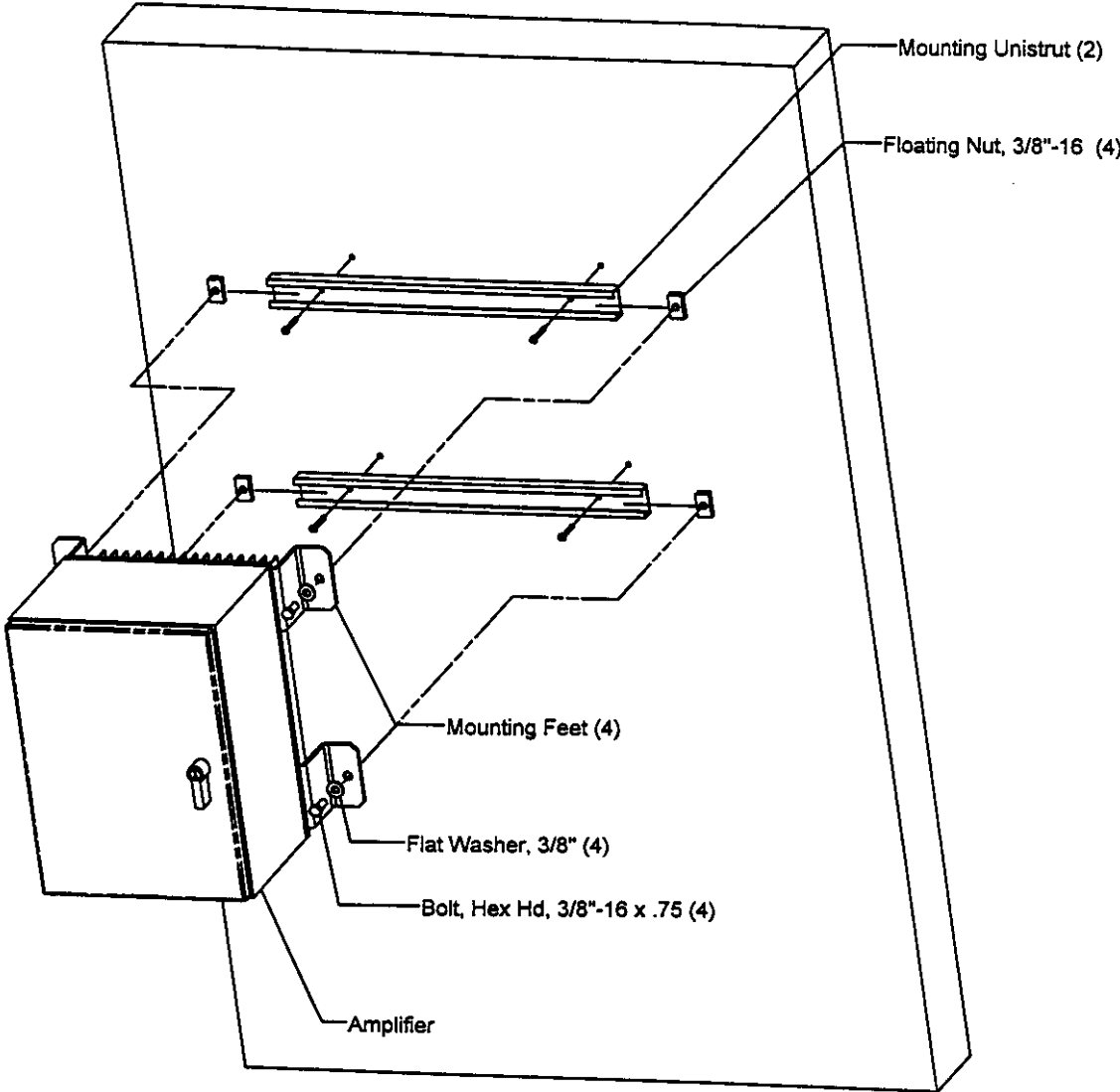

Figure 1 Wall Mounting

1. Location found
2. Install the amplifier to the wall using mounting kit
3. Material used from mounting kit
 - Channel (Qty - 2ea)
 - Clamp Nut (Qty - 4ea)
 - X .75 Hex Head Screw (Qty - 4ea)

- Washer, Sealing (Qty - 4ea)
4. Materials needed that are not included in the mounting kit
 - Anchors (EAHRS-00002) (Qty - 4ea)
 - Screw, Pan Head, #10-32 X 1.50 (Qty - 4ea)
 - Washer, #10 (Qty - 4ea)
 5. Prepare Channels
 - a. Drill two holes (0.219 inches in diameter) in each mounting unistrut.
 - b. The holes should be located between the slots and spaced approximately 12 inches apart, centered in the unistrut.
 - c. Prepare Holes in wall.
 - d. Mark hole locations from modified mounting unistrut
 - e. Channels should be spaced 11.60 inches apart (center to center)
 - f. Wallboard Installation
 - For Wallboard 5/8" to 3/4" thick
 - Drill 3/8" Diameter hole
 - Depress wing tabs so that anchor will fit into hole
 - Push in until flush with wallboard
 - g. Concrete Installation
 - Drill 3/8" diameter hole approximately 1 3/4" deep
 - Depress wing tabs so that anchor will fit into hole
 - Push in until flush with outside surface of concrete
 - h. Mount Channels to the Wall
 - Line mounting unistruts up with the holes drilled in the wall
 - Use #10 hardware to install
 - i. Mounting Amplifier to Channels
 - Install the clamp nuts from the mounting kit into the mounting unistrut .
 - Use the 3/8" hardware supplied with the mounting kit to install the amplifier to the mounting unistrut.

5. Amplifier Pole Installation, Figure 2.

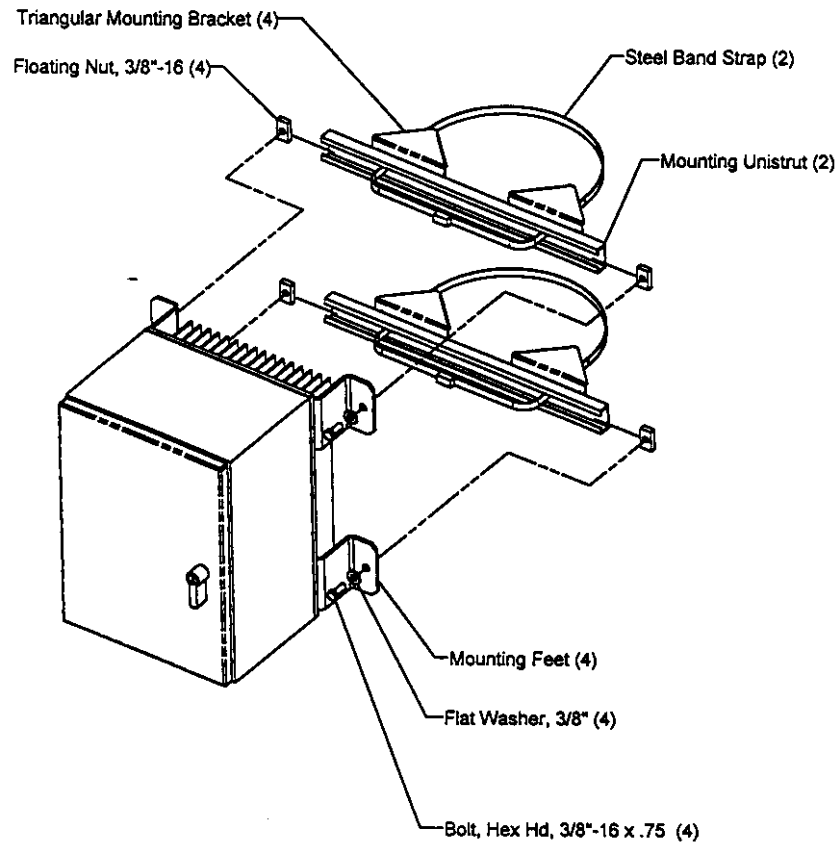

Figure 2 Pole Mounting

1. Location found
2. Install the amplifier to a pole using mounting kit
3. Material used from mounting kit.
 - a. Channel (Qty - 2ea)
 - b. Clamp Nut (Qty - 4ea)
 - c. Clamp (Qty - 2ea)
 - d. Strap (Qty - 2ea)
 - e. Mounting Bracket (Qty - 4ea)
 - f. X .75 Hex Head Screw (Qty - 4ea)
 - g. Washer, 3/8" (Qty - 4ea)
4. Mounting Amplifier to Channels
5. Install the clamp nuts from the mounting kit into the mounting unistrut.
6. Use the 3/8" hardware supplied with the mounting kit to install the amplifier to the mounting unistrut

6. Power Up**1. Power Connection**

- a. Use the power cable (AE02C-D3300-001) to connect the amplifier to a power source.
- b. The amplifier will accept from 90 - 260 VAC @ 240 Watts.
- c. If the connector on the cable is not compatible with that of the power source, you may either:
- d. Find an appropriate adapter.
- e. Locate the correct connector and splice the cable. The wiring follows North American Standards
 - Black Wire - Line
 - White Wire - Neutral
 - Green or Green/Yellow Wire - Ground or Earth

APPENDIX B

SOFTWARE INSTALLATION

1. Tools required

One personal computer (PC) with Windows 3.1 or greater, Windows 95, or Windows NT.

2. SMARTpc Software Installation and Configuration

2.1 Overview

2.1.1 The SMARTpc software provides a means to control and monitor the SA1800 (and other Smart-equipped Andrew products) locally or from a remote site.

2.1.2 The application software runs on a PC under Windows and communicates with firmware inside the SA1800.

2.1.3 Local connections require a programming cable which is provided with the SA1800.

2.1.4 Remote connections require a PC accessible modem.

2.2 Installation/Configuration Instructions

2.2.1 Install the Software on the PC.

2.2.1.1 Insert the installation disk into floppy drive.

2.2.1.2 Run the setup.exe executable located on the installation disk.

2.2.1.3 The default installation directory is c:\smartpc, but the setup program prompts you in order to allow a different installation directory.

2.2.1.4 After setup is completed, there should be a new program group called SMARTpc, which consists of applications: SMARTpc Administration, SMARTpc Configuration, and SMARTpc Operation (corresponding to three executable programs in the installed directory: admin.exe, config.exe, and opration.exe, respectively).

2.2.2 SMARTpc Administration

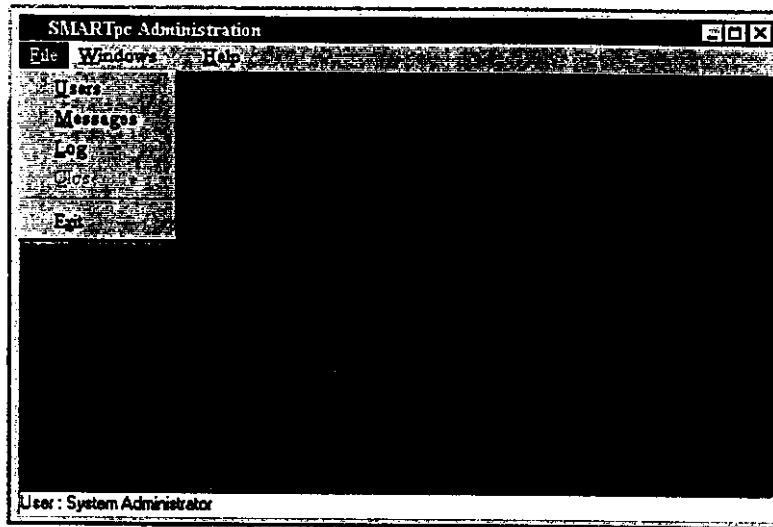

Figure 1 SMARTpc Administration Screen

2.2.2.1 Start the SMARTpc Administration program

2.2.2.2 The following message "Could not open SMARTpc database. Would you like to create a new one?" will appear. Click **Yes** to create a new database.

2.2.2.3 At the SMARTpc Login screen, enter a User ID and a Password of admin. This is the default user ID/password entered in the database. Click **OK**.

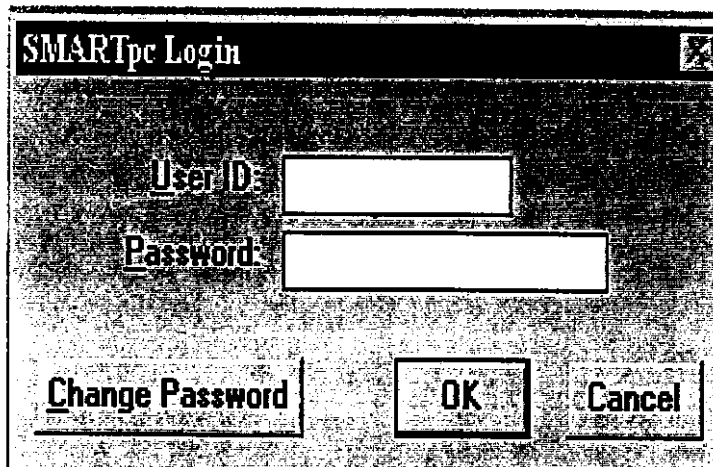

Figure 2 SMARTpc Login Screen

2.2.2.4 (Optional). To create a new user ID/password, select Users from the File pulldown menu. A user maintenance screen will appear from which you can add, edit, or delete user records from the database.

2.2.2.5 Select Exit from the File pulldown menu.

2.2.3 SMARTpc Configuration

2.2.3.1 Start the SMARTpc Configuration Program

2.2.3.2 Enter a valid User ID/password (such as admin/admin) and click OK.

2.2.3.3 Select **Open SMARTsentry** from the File pulldown menu.

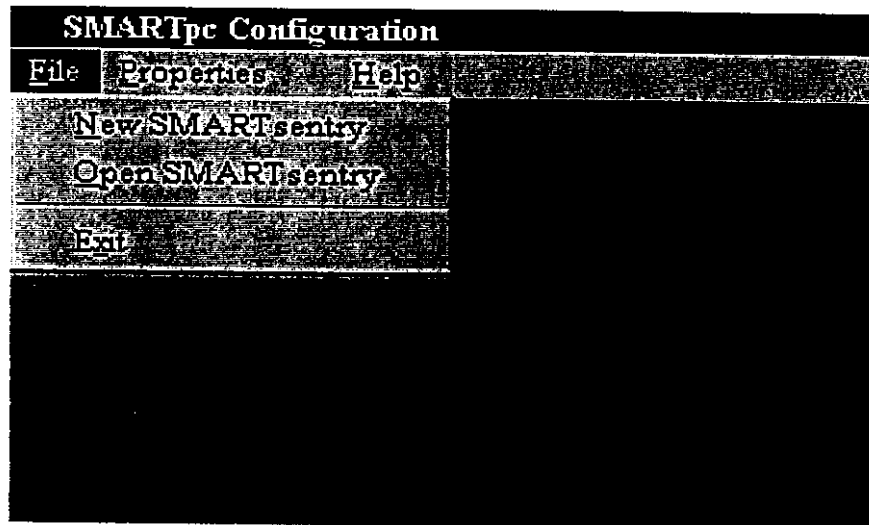

Figure 3 SMARTpc Configuration Screen

2.2.3.4 In the Open dialog box shown in Figure 4, select **default.ssy**, which is the default SA1800 configuration

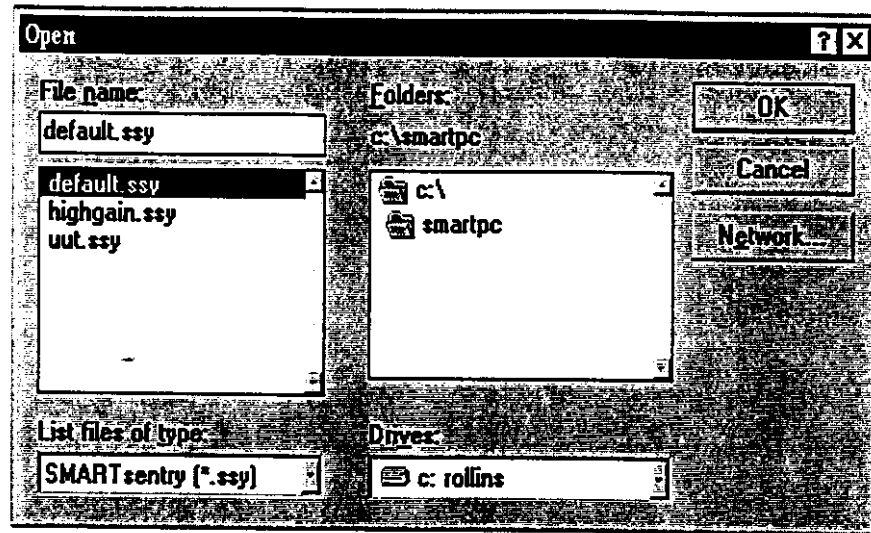

Figure 4 Open Dialog Box Screen

2.2.3.5 Select **SMART sentry ...** from the Properties pulldown menu

2.2.3.6 Adjust the parameters for the SMART sentry to meet your requirements. A brief description of the parameters under each tab setting is provided below.

General Properties

Name - Text ID of sentry, used for display purposes

PC Phone Number 1 - Primary # for sentry fault reporting

PC Phone Number 2 - Secondary # for sentry fault reporting

SMART sentry Phone Number - # used by PC to retrieve sentry status

SMART sentry ID - Unique identifier used internally

I/O Ports

- Mapping from internal port monitor points to text ID

- In general, should not be changed by the operator

Alarm Delay

Digital Delay - digital I/O guardband time from fault detection to reporting

Analog Delay - analog I/O guardband time from fault detection to reporting

NOTE: delays can be used to reduce fault reporting on transient events.

2.2.3.7 Click OK after making any changes

2.2.3.8 Select **Save SMART sentry** from the File pulldown menu, and save the new data to a file. Use a naming convention that will allow you to keep track of what sentry info is contained in each file.

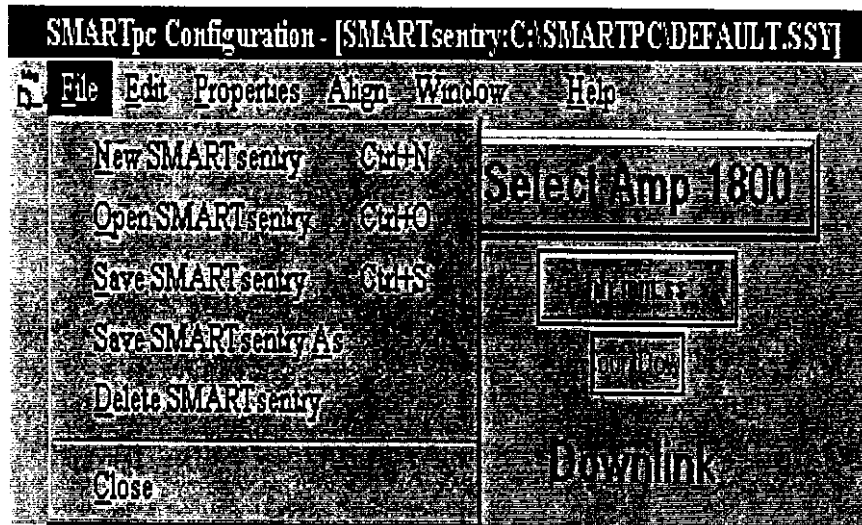
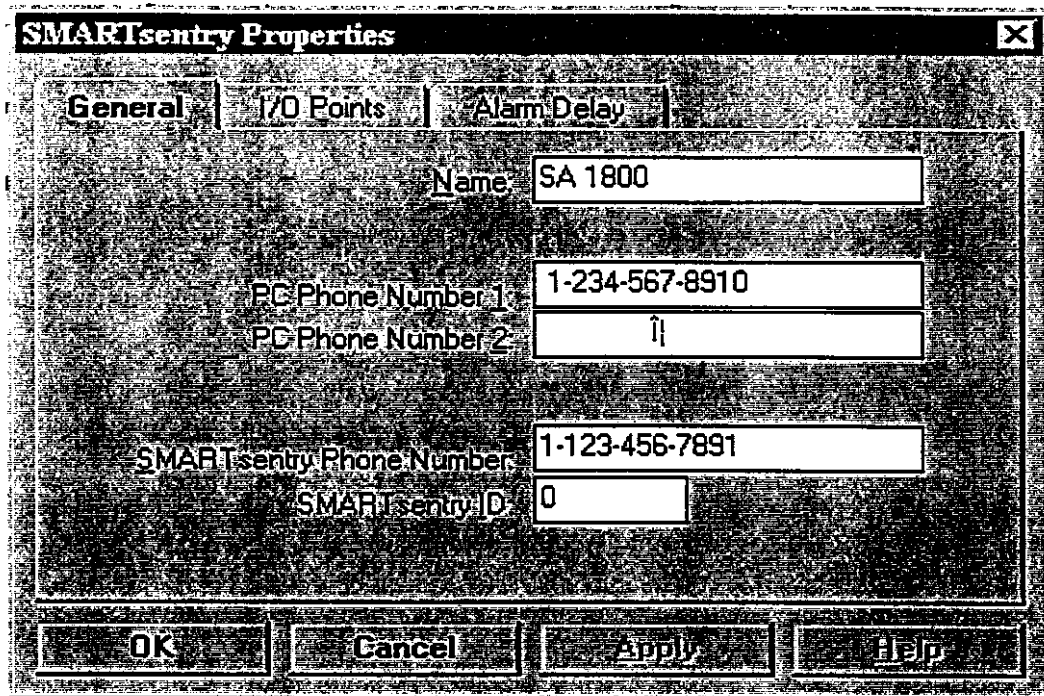

Figure 5 SMARTpc Configuration Screen

2.2.3.9 If you have multiple sentries to monitor, create a file for each one. In general, the only difference between sentries will be the *Name*, *SMART sentry Phone Number*, and *SMART sentry ID* under the General Properties heading. Thus, after setting up the first sentry as described in the steps above, you can then select SMART sentry... from the Properties pulldown menu, modify these three General Properties, click OK, and then select Save SMART sentry As from the File pulldown menu to create any remaining sentries you wish to define.



1.

Figure 6 SMART sentry Properties Screen

2.2.3.10 Select **Close** from the File pulldown menu.

2.2.3.11 Select **System...** from the Properties pulldown menu.

2.2.3.12 Under the SMART sentries tab group, use Add and Remove to setup the list of sentries to be monitored to match your requirements.

2.2.3.12.1 FOR LOCAL/DIRECT CONNECTIONS:

2.2.3.12.1.1 In the Connection tab group select Direct.

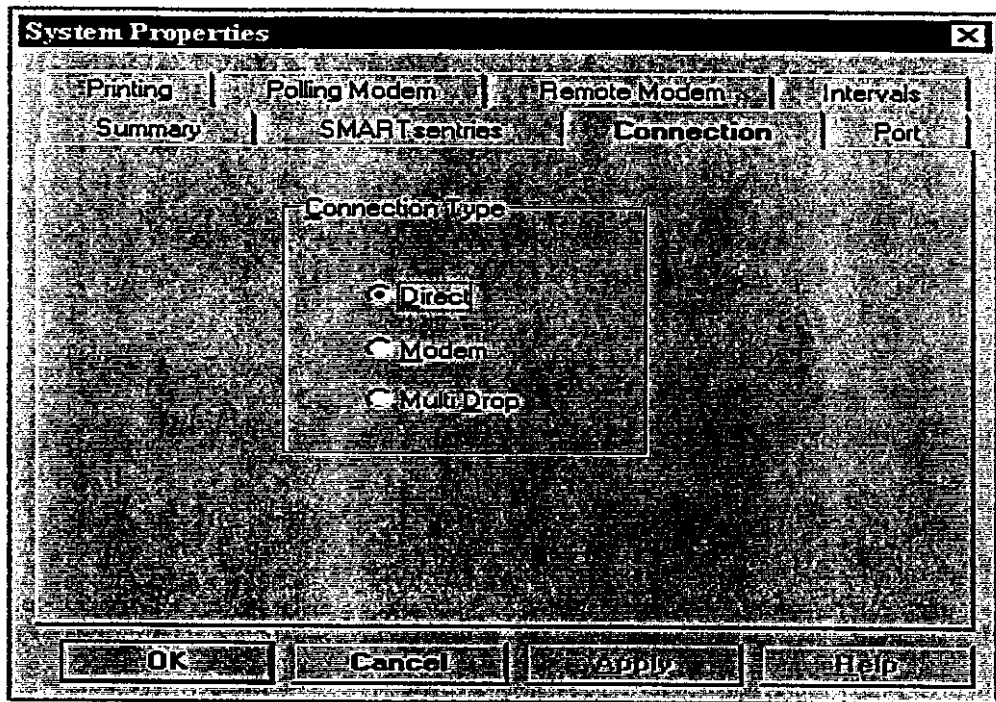

Figure 7 System Properties (Connection Tab Group)

2.2.3.12.1.2 In the *Port* tab group, set up communication parameters from your PC to your modem (such as COM2, 9600 baud, No parity, 8 data bits, 1 stop bit).

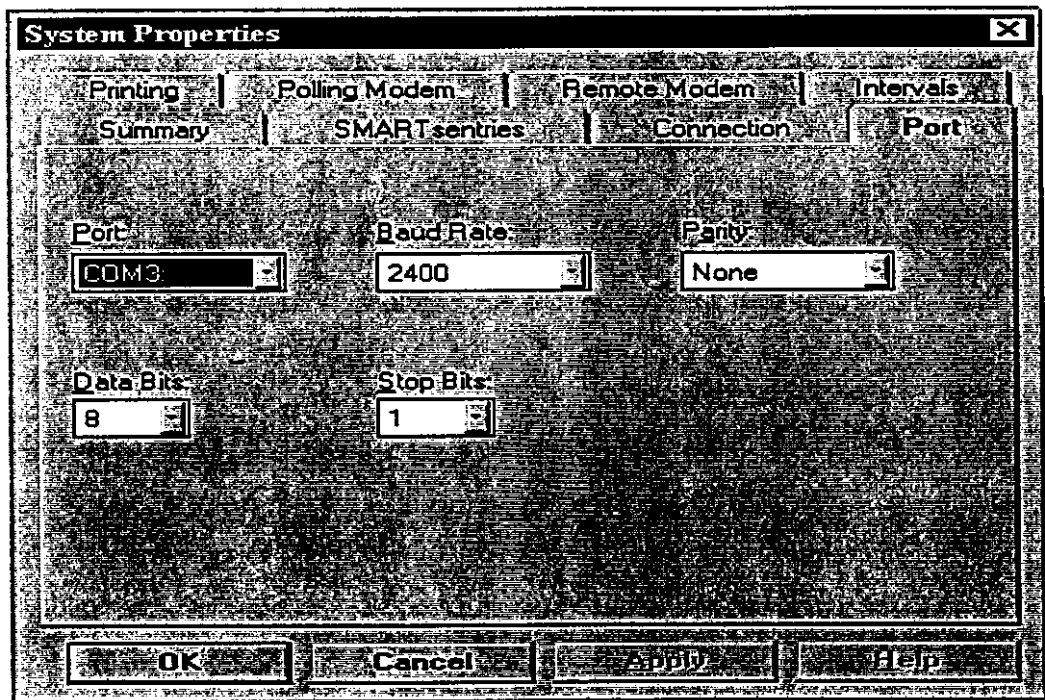

Figure 8 System Properties (Port Tab Group)

2.2.3.12.1.3 In the **Intervals** tab group, change the Detail Screen Timeout to 900.

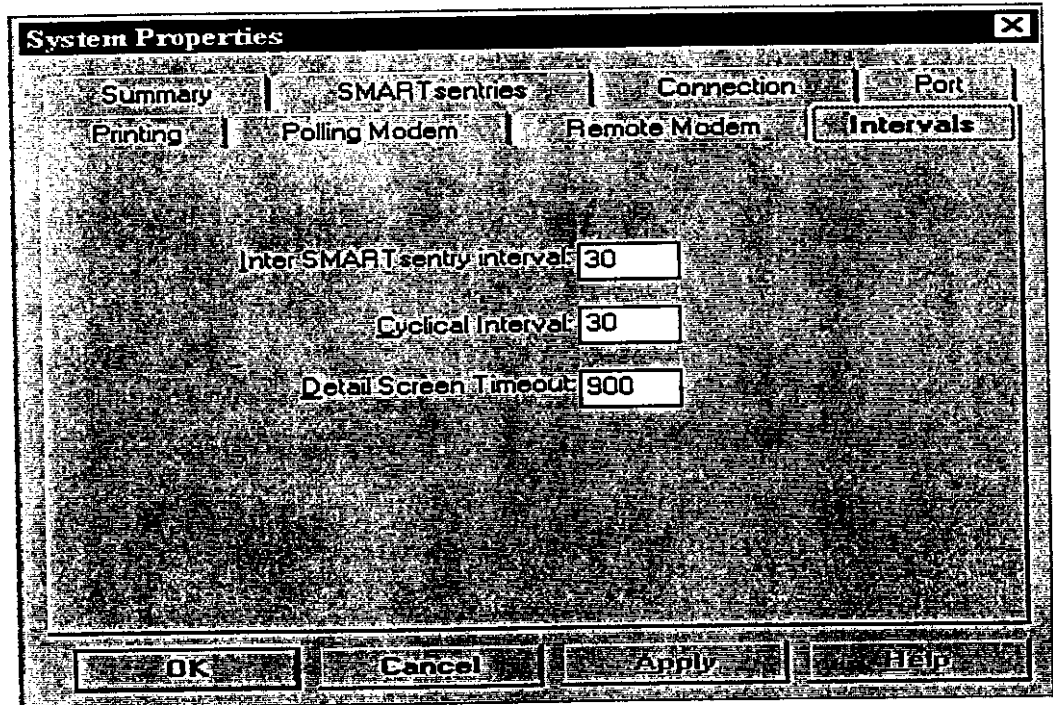

Figure 9 System Properties (Interval Tab Group)

2.2.3.12.2 FOR REMOTE/MODEM CONNECTIONS:

2.2.3.12.2.1 In the **Connection** tab group select Modem (see Figure 7).

2.2.3.12.2.2 In the **Port** tab group, select the COM port you are using to connect from you PC to the sentry, and select 2400 baud, No parity, 8 data bits, and 1 stop bit (see Figure 8).

2.2.3.12.2.3 In the **Polling Modem** tab group change the Command Timeout to 40. Note the other parameters are setup to work with a Hayes compatible modem and should only be changed, if you are having connection problems.

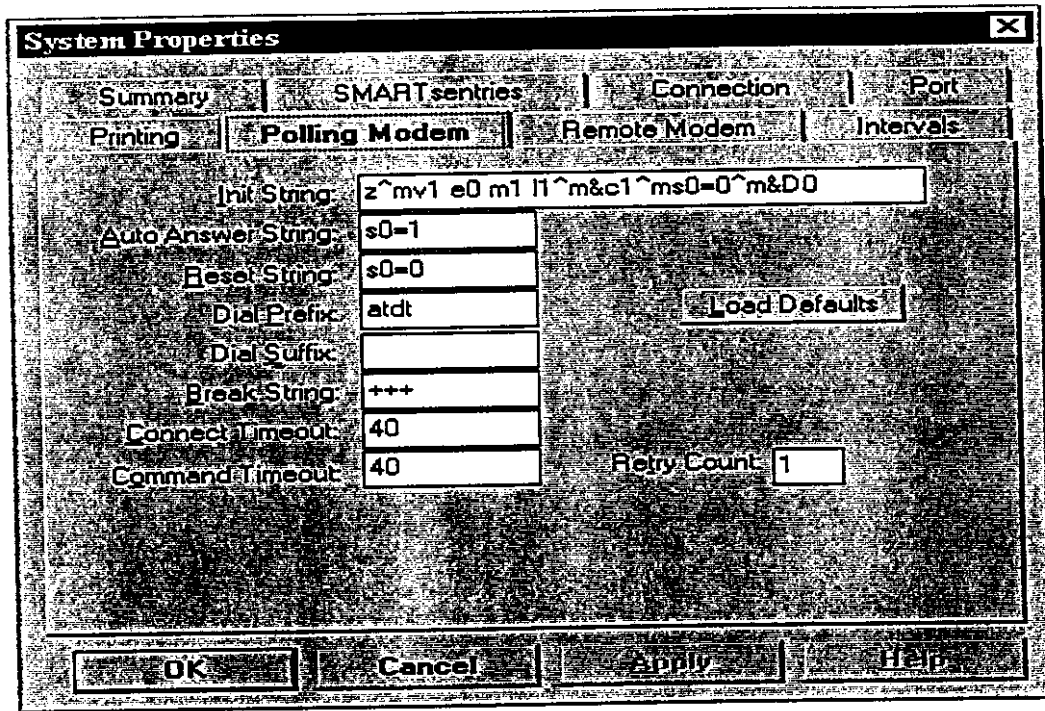

Figure 10 System Properties (Polling Modem Tab Group)

2.2.3.12.2.4 In the Remote Modem tab group change the Answer Wait to 30 (the Baud Rate should be 2400).

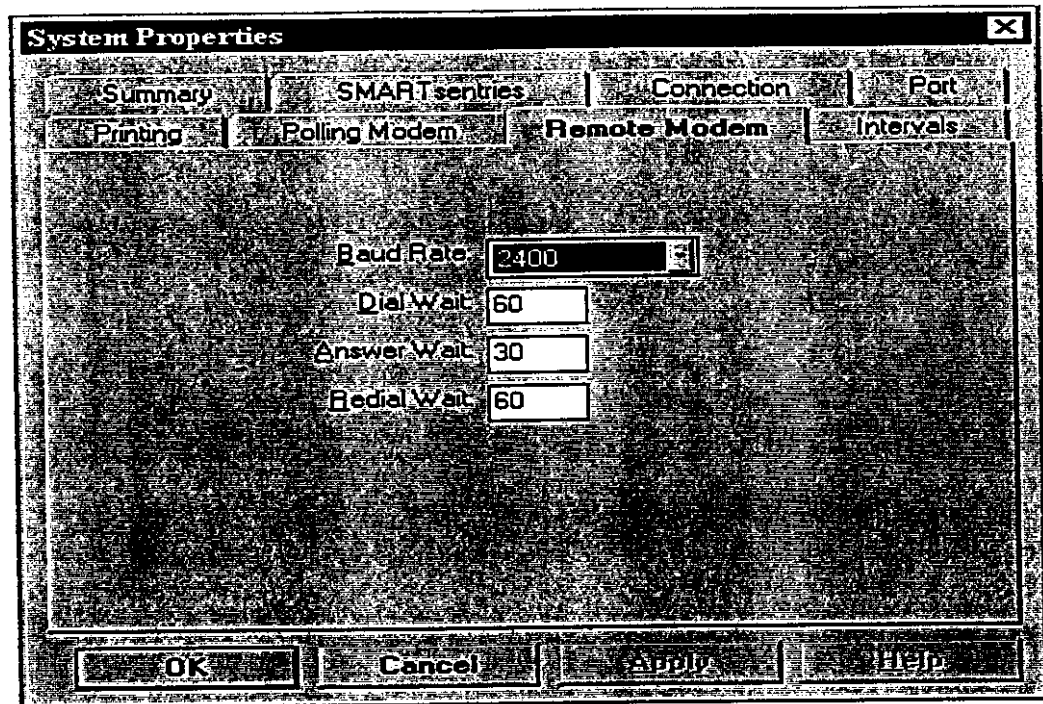

Figure 11 System Properties (Remote Modem Tab Group)

2.2.3.12.2.5 In the **Intervals** tab group, set the Detail Screen Timeout to 900, and set up the Inter SMART sentry interval and Cyclical Interval to control the automatic polling behavior (typical parameters would be an Inter SMART sentry interval of 30 seconds and a Cyclical Interval of 30 seconds).

2.2.3.12.2.5.1 The *Cyclical Interval* provides a delay between polling cycles (a delay from completing the poll for the last sentry in the configuration to restarting polling with the first sentry in the configuration). This delay can be used to provide dial in access from the sentries to the PC for automatic fault reporting, and it can be used to provide adjust how often each sentry is polled.

2.2.3.12.2.5.2 The *Inter SMART sentry interval* allows a tradeoff between the number of sentries which can be polled in a given time interval and the ability to receive automatic fault reports from the sentries. If this parameter is set to 0, this will minimize the polling time for any given configuration, but the sentries will not be able to dial in during the active polling time (the line will be busy with outbound calls).

2.2.3.12.2.5.3 Examples: Polling of a single sentry takes approximately 30 seconds. With two sentries to poll, and a inter sentry interval of 0, it will take approximately one minute to poll

both nodes. If the user wants to poll each node every 15 minutes (900 seconds), the cyclical interval should be set to 840 seconds. In order to poll 30 nodes every 15 minutes, then the inter sentry interval and the cyclical interval should both be set to 0. In this case, the phone will be in constant use, so any automatic fault reports from the sentry will not be able to be received. Adjusting both intervals to 30 will result in a 30 minute poll cycle, but will allow the incoming line to be used 50% of the time.

2.2.3.12.2.6 Click **OK** to save the new settings

2.2.3.12.2.7 Select **Exit** from the **File** pulldown menu

2.2.4 Start the SMARTpc operation program.

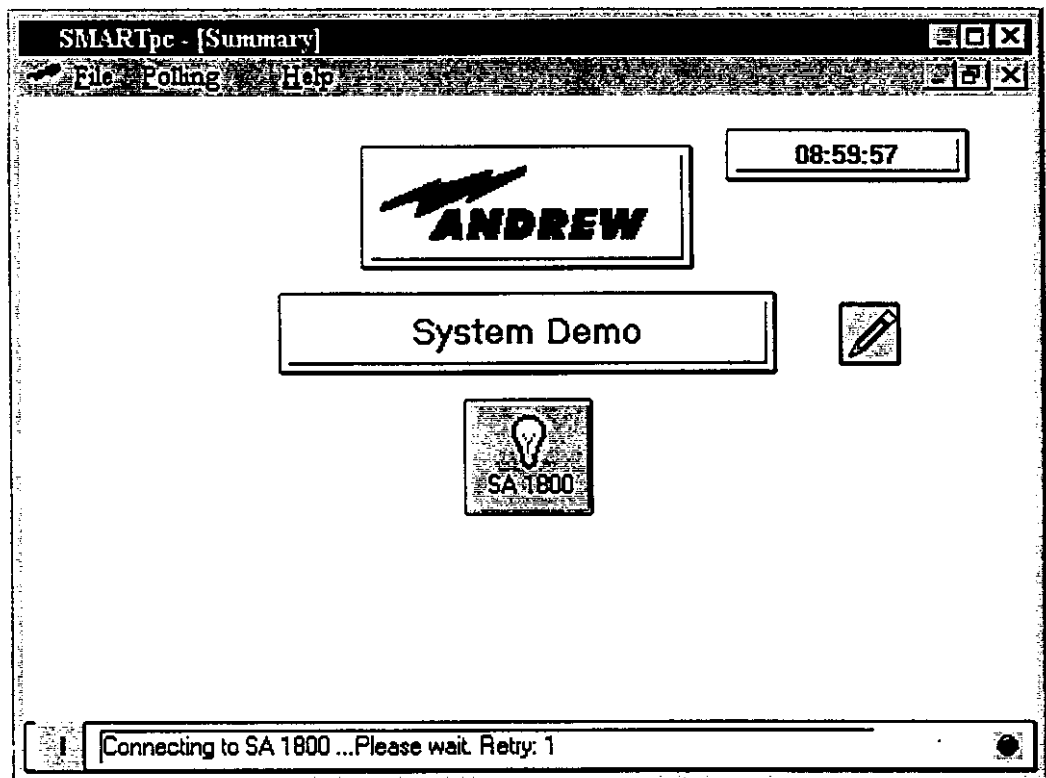

Figure 12 Main SMARTpc Operations Screen

2.2.4.1 If everything is set up correctly, you should be able to click on any sentry icon to connect to a sentry for control/monitoring purposes. Any changes which have been made to the sentry's configuration on the PC will be detected after a connection to the sentry is established. At this point the operator will be notified of conflicts between the configurations,

and generally, the operator should select the option to download the PC configuration info to the SMART sentry.

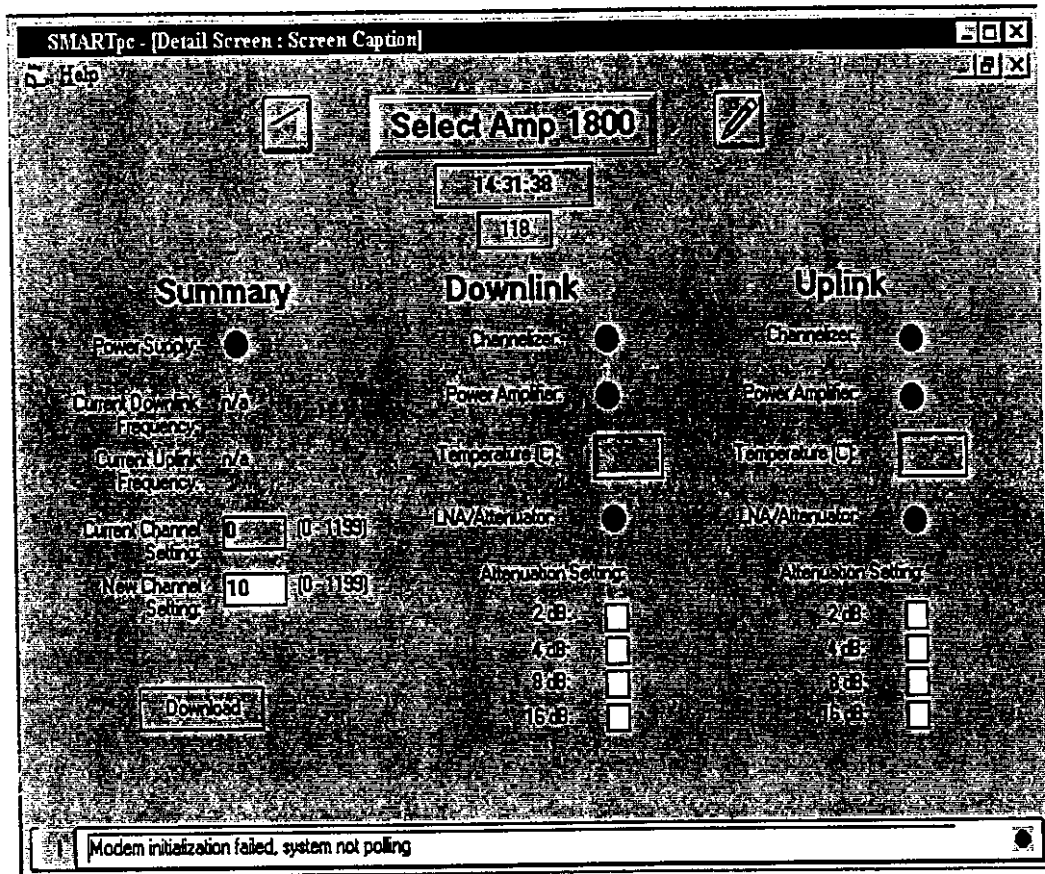

Figure 13 SMARTpc Detailed Sentry Screen

2.2.4.2 If problems are encountered, examine the log file for further info. To open the log file, click on the button with the pencil icon.

2.2.4.3 If the system timed out waiting for a modem response, check to see that the modem is on and is connected to the port selected during the configuration, under the System Properties Port tab group (in order to examine or change the system's settings, exit the Operation program, restart the Configuration program, view/change the system properties, exit the Configuration program, and restart the Operation program.

2.2.4.4 If the modem seems to initialize correctly, but cannot connect to the sentry, check the sentry's configured phone number against the true phone number. If this is not a problem,

from a telephone dial in to the sentry and see if it answers. If this is not a problem, change the sentry's configured phone number to a nearby telephone number, then click on the sentry's icon in the Operation main screen, and see if your phone rings.

3. Channel Programming and Gain Setting

3.1 Communication Interfaces - Local Control

3.1.1 There is a RJ-45 (six wire) jack provided on the Status/Control Module (see Figure 1-2) for connection to the local control port.

3.1.2 Connect this port to any IBM compatible PC capable of running Microsoft Windows (Version 3.1 or later) in enhanced mode.

3.1.3 Use control cable (ECATL-80700) to connect between the two.

3.1.4 Connect the cable to the PC using port adapter (AE02M-D0419-001) for 9 pin applications or use port adapter (AE02M-D0420-001) for 25 pin applications whichever your PC utilizes.

3.1.5 This provides access to the SMARTpc Windows application and enables the user to configure the analog and digital I/O ports, monitor the attached amplifier, and control it.

3.2 Communication Interfaces - Remote Control

3.2.1 Channel Number Set Up

The SelectAmp 1800 channel is set by clicking on the channel box located under the Summary Group and entering the appropriate channel number (0-1199). Figure 14 shows channel 10 to be set.

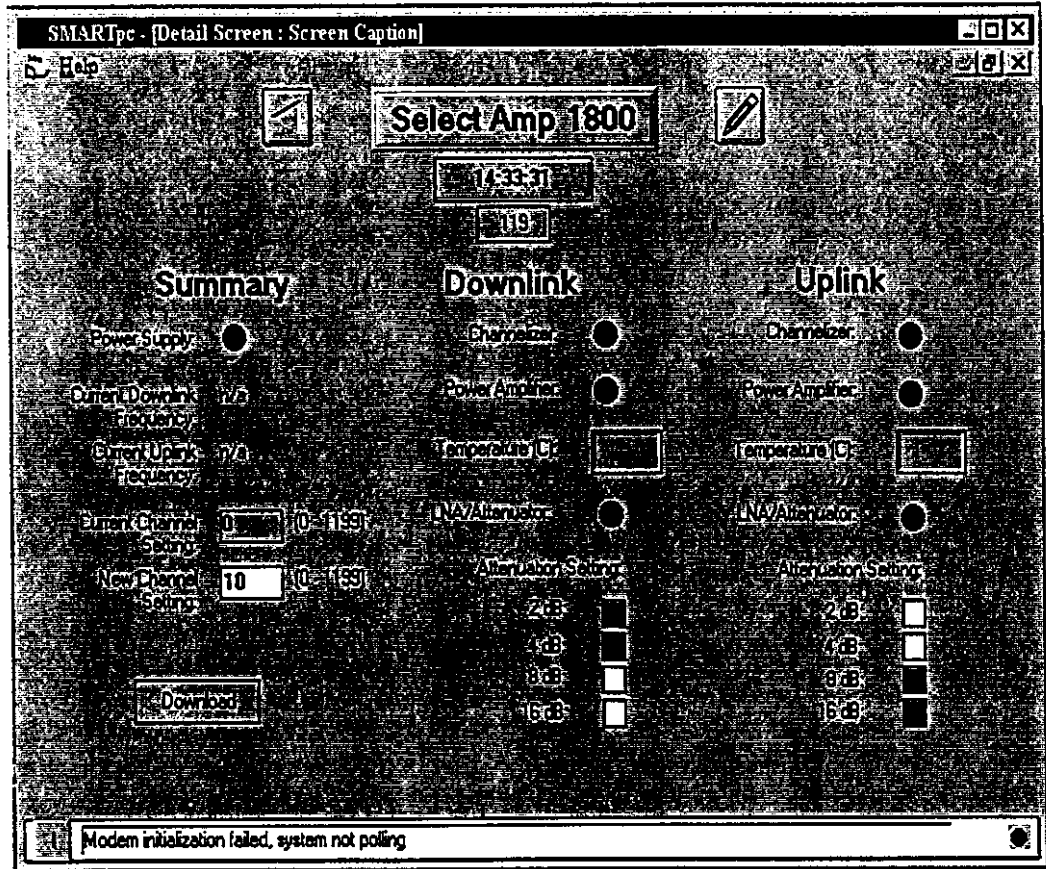

Figure 14 SMARTpc Detailed Sentry Screen with Attenuation

3.2.2 RF Level Set Up

The uplink and down link gain of the SelectAmp 1800 is set by entering desired attenuation values in each path. Each path has several options of attenuation values (2, 4, 8, and 16 dB) which may be combined to provide from 2 to 30 dB of attenuation in the either path. In figure 14, there is 6 dB of attenuation set in the downlink path and 24 dB of attenuation set in the uplink path. The actual attenuation values needed for any specific location are dependant on the base station signal level (donor and null), antenna gains , and size of the coverage area.

CAUTION

This unit is FCC compliant at output power levels of 2 watts or below. Exceeding 2 watts may create interfering signals.

APPENDIX C APPLICATION NOTES

The Andrew SelectAmp 1800 is a two-way on-band repeater with two RF ports. One port is for connection to an antenna directed towards the service providers base station (this would usually be a Yagi or some other directional antenna). The other port is connected to an antenna or suitable leaky feeder cable directed over the area in which the mobile units are to be found (this would usually be an omni-directional or similar antenna).

Typical applications for the amplifier are as follows:

1. Extending coverage to within tunnels. This is achieved by the use of a leaky feeder cable running the length of the tunnel attached to the mobile port of the amplifier. A directional antenna would be connected to the base port of the amplifier directed towards the base station. In this way uninterrupted coverage can be extended to within the tunnel. In some cases a Yagi or omni-directional antenna can be used.
2. Extending coverage to within buildings. Many modern buildings incorporate large amounts of reinforced concrete and other metal in their construction and, therefore, act as effective screens to penetration by RF signals. By using localized antenna or leaky feeders within these buildings connected to the mobile port, and a Yagi on the top of the building connected to the base port, coverage can be extended to within these buildings.
3. Local topology, e.g., hills, embankments, etc., can cause propagation blank spots. By using a suitable antenna to cover the area and a Yagi mounted high enough to "escape" the blank spot, coverage can be extended to these areas.
4. Temporary requirements for radio coverage can arise from such events as conferences,, exhibitions, sporting events, etc. These short term events would not justify the expense of a permanent base station. Therefore, an amplifier can be employed to "borrow" channels from a less busy site some distance away that would otherwise be out of range of mobiles units at the event.
5. If a site becomes heavily congested with radio traffic and a neighboring site is under-utilized, an amplifier can be utilized to "borrow" channels from the quiet site for use in the coverage area of the busy site.
6. In areas of low user density, a base station can be under-used. However, it is often impossible to increase coverage from a central point which experiences limits on power levels, mast heights etc. In these instances an amplifier placed some distance away from the base station can be used to extend the coverage in a desired direction.

When siting the two antennas for an amplifier, the most important requirement is to maintain the RF isolation between the antennas to substantially greater than the gain of the amplifier (otherwise, feedback and oscillation will occur). The isolation can be achieved in many ways including:

1. Physical separation using long feeders to keep the two antennas apart.

2. Directional antennas can be used, if the base station and the mobiles are on opposite sides of the amplifier.
3. Vertical separation can be used by mounting the base station antenna high up a mast and the mobile antenna as low as possible angled downwards to separate the two field patterns.

It is also necessary when siting the antennas to ensure that the maximum input signals to the amplifier do not exceed the limits for the particular unit being used. If excessive signals do occur, overloading of the amplifier can result in poor intermodulation and signal to noise performance.