

Welcome Guide

PowerWave 7.5 Car Mount

Important Safety Instructions

- Avoid dropping.
- Do not disassemble.
- Do not expose to liquids.
- For the safest and fastest charge, use original or certified cables.
- The maximum ambient temperature during use of this product must not exceed 40°C.
- Open flame sources, such as candles, must not be placed on this product.
- Only use a dry cloth or brush to clean this product.
- Do not install while driving.

At a Glance

Wireless Charging Car Mount



1. Telescopic arms
2. Bottom foot
3. Foot knob
4. Cradle
5. Release Button
6. Three-level adjustable claw
7. Swivel knob
8. Micro USB Port
9. LED indicator



Alternative three-sided handles
Lever

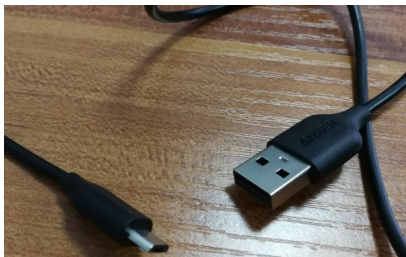

USB charging cable







Status LED

The LED indicator displays the status of the car mount charger.

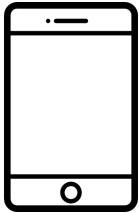
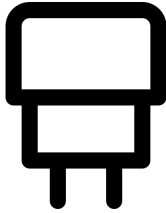
Status	LED Indicator
Connected to power	Solid blue for three seconds, then off
Charging mobile device / Fully charged	Solid blue
- Metal or other foreign objects detected - Using an incompatible car charger or cable	Flashing blue
Overheating problem detected	Flashing red

Compatibility

Before using this product, make sure your smartphone is compatible with Qi wireless charging technology.

 Smartphone		 Car Charger [换个 car charger]	 Power Output [换车载无线充上面一个手机的图]	
Qi-Compatible Phones	+	5V  2A	=	5W
iPhone 8, iPhone 8 Plus, iPhone X, etc	+	9V  2A 12V  1.5A Quick Charge 3.0	=	7.5W
Samsung Galaxy S9+, S9, Note 8, S8+, S8, S7 edge, S7, etc	+	9V  2A 12V  1.5A Quick Charge 3.0	=	10W
LG G7, V35, V30, V30+, etc				

Mounting Your Smartphone

1. Loosen the foot knob on the back to adjust the height of the foot. The degree scale printed on the bottom foot helps you best fit the dimensions of your smartphone.

【图：旋转后面 foot knob，参考刻度调节 foot 的高度】

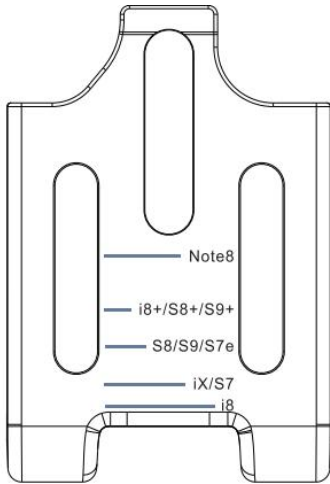

Degree Scale	Ideal for
Note8	Samsung Note 8
i8+/S8+/S9+	iPhone 8+/Samsung S8+/Samsung S9+
S8/S9/S7 e	Samsung S8/S9/S7 edge
IX/S7	iPhone X/Samsung S7
i8	iPhone 8

2. Insert the three-level adjustable claw into your car's air vent. Make sure the claw is inserted securely in position.

[图：将夹子插入汽车的通风口]

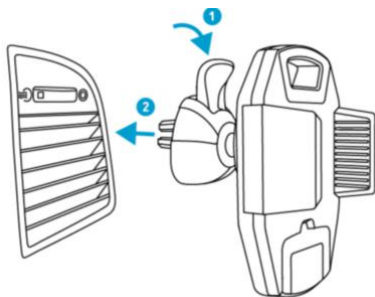

- 3 levels to fit more air vents

[图：a. b.c 三种情况]

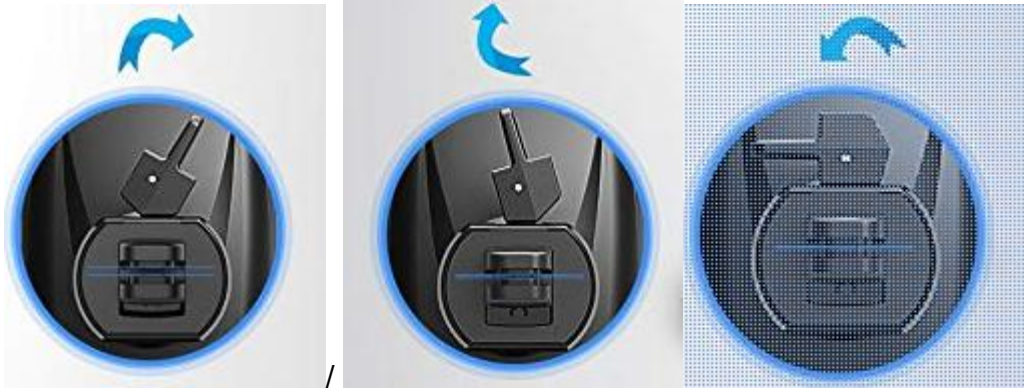

- Loosening the claw



3. Unscrew the swivel knob on the back, adjust the car mount to the optimal viewing angle, then tighten the swivel knob to secure.

【图：松开背后旋钮调节角度，然后拧紧】



- Placing the car mount horizontally or vertically

【图：car mount 横放或者竖着放】



4. Press the release button on the side of the cradle to extend the telescopic arms.

【图：按侧面小按键展开两边双臂】

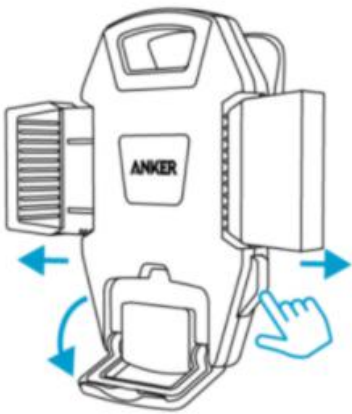

5. Place your smartphone in the mount and squeeze the telescopic arms until the phone is securely in position. Adjust the mount to the perfect angle.

[图：放手机并固定]

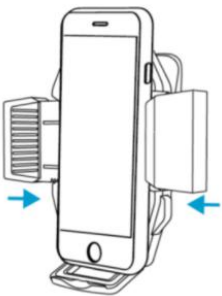

Note  :

- For optimal charging performance, align the smartphone with the Qi coil on the center of the car mount. If there is no grade scale for your smartphone or your phone has a protective cover, you can slightly adjust the bottom foot to align the smartphone with the Qi coil.

[图：指明中心的放置位置，参考竞品说明书图]



- To securely fasten the phone, press the rear-end position of the telescopic arms, as illustrated.

[图：指明正确的按压位置]



- Non-intensive, arc-shaped or retraction-type air vents are not supported.



- Do not place any foreign objects between your smartphone and the surface of the car mount, including metal objects, credit cards, door keys, coins, or NFC cards, as it may cause overheating.

[图：手机背面带铁片、指环，卡套都不适用]



- Using an ultra-thick protective phone case is not recommended as it may affect the wireless charging function.

Using the Alternative Three-Sided Handles

If the three-level adjustable claw does not fit your air vents, use the alternative three-sided handles instead.

1. Unscrew the swivel knob on the back and remove the three-level adjustable claw.

[图：取出旧的夹子]

2. Firmly insert the round head of the three-sided handles into the joint of the car mount, then tighten the swivel knob to secure.

[图：安上新的夹子，并拧紧]



3. Press and hold the lever to firmly insert the claw into your car's air vent. Make sure the claw is inserted securely in position.

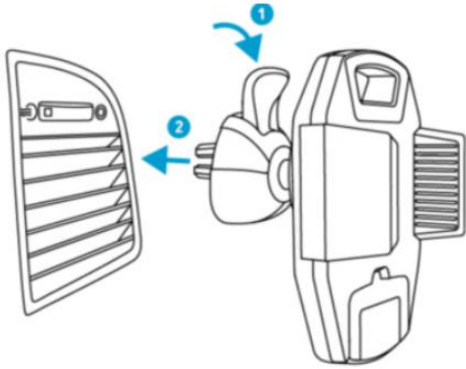

4. Repeat steps 2-5 mentioned in the **“Mounting Your Smartphone”** section to mount your phone.



Charging Your Smartphone Wirelessly

1. Mount your smartphone in your desired location.
2. Use the USB cable to connect the car mount to a car charger.
 - ❖ Your phone will begin to charge wirelessly.

[图：USB 线连接车充电。]

3. After use, press the release button to remove your phone.

[图：按侧边按键展开双臂，取出手机。]



- Wireless charging function is sensitive to temperature. The in-car high temperature may pause charging or slow down the charging speed, so it is

recommended to turn on the air conditioner in your car to avoid overheating. If the LED indicator flashes red, it indicates this product is overheated. Let it cooled down before you resume charging.

- For optimal wireless charging performance, use a Quick Charge™ car charger.

FCC Statement

This device complies with Part 15 of the FCC Rules. Operation is subject to the following two conditions: (1) This device may not cause harmful interference, and (2) this device must accept any interference received, including interference that may cause undesired operation.

Warning: Changes or modifications not expressly approved by the party responsible for compliance could void the user's authority to operate the equipment.

Note: This equipment has been tested and found to comply with the limits for a Class B digital device, pursuant to Part 15 of the FCC Rules. These limits are designed to provide reasonable protection against harmful interference in a residential installation.

This equipment generates, uses, and can radiate radio frequency energy and, if not installed and used in accordance with the instructions, may cause harmful interference to radio communications. However, there is no guarantee that interference will not occur in a particular installation. If this equipment does cause harmful interference to radio or television reception, which can be determined by turning the equipment off and on, the user is encouraged to try to correct the interference by one or more of the following measures: (1) Reorient or relocate the receiving antenna. (2) Increase the separation between the equipment and receiver. (3) Connect the equipment into an outlet on a circuit different from that to which the receiver is connected. (4) Consult the dealer or an experienced radio / TV technician for help.

Radiation Exposure Statement

This equipment complies with FCC radiation exposure limits set forth for an uncontrolled environment. This equipment should be installed and operated with minimum distance of 20 cm between the radiator & your body.

Product Name: PowerWave 7.5 Car Mount
Model: A2551

The following importer is the responsible party.

Company Name: Fantasia Trading LLC

Address: 9155 Archibald Avenue, Suite 202, Rancho Cucamonga, CA, 91730, US

Telephone: +1 (909) 484 1530

- English: "

This device complies with Industry Canada licence-exempt RSS standard(s). Operation is subject to the following two conditions:

- (1) this device may not cause interference, and
- (2) this device must accept any interference, including interference that may cause undesired operation of the device."

- French:"

Le présent appareil est conforme aux CNR d'Industrie Canada applicables aux appareils radio exempts de licence. L'exploitation est autorisée aux deux conditions suivantes :

- (1) l'appareil n' doit pas produire de brouillage, et
- (2) l'utilisateur de l'appareil doit accepter tout brouillage radioélectrique subi, même si le brouillage est susceptible d'en compromettre le fonctionnement."

Declaration of Conformity

Hereby, Anker Innovations Limited declares that the product type A2551 is in compliance with Directive 2014/53/EU. The full text of the EU declaration of conformity is available at the following internet address: <https://www.anker.com/products>

해당무선설비기기는 운용 중 전파혼신가능성이 있으므로 인명안전과 관련된 서비스는 할 수 없습니다

Specifications

Input	5V=2A / 9V=2A / 12V=1.5A
Size (L x W x H)	74.1 x 17.7 x 58.3 mm / 2.9 x 4.6 x 2.3 in
Weight	
- car mount with three-level adjustable claw	134g/4.7oz 21g/0.7oz
- three-sided handles	
- USB cable	40g/1.4oz 18g/0.6oz

Product Number: A2551



The product shall not be disposed together with the normal waste. It must be recycled.

EN: Customer Service
IT: Servizio Clienti

AR: خدمة العملاء

EN: 18-month Limited Warranty
IT: Garanzia valida 18 mesi

AR: ضمانة 18 شهراً محدودة

EN: Lifetime Technical Support
IT: Assistenza post-vendita a vita

AR: الدعم الفني مدى الحياة

(US) +1 (800) 988 7973 Mon-Fri 9:00am - 5:00pm (PT)
(UK) +44 (0) 1604 936200 Mon-Fri 6:00 - 11:00 (GMT)
(DE) +49 (0) 69 9579 7960 Mon-Fri 6:00 - 11:00
(中国) +86 400 0550 036 周一至周五 9:00 - 17:30
(日本) +81 03 4455 7823 月-金 9:00 - 17:00

For FAQs and more information, please visit
<https://www.anker.com/support>

Anker Innovations Limited
Room 1318-19, Hollywood Plaza, 610 Nathan Road, Mongkok, Kowloon, Hong Kong



@Anker
@Anker Japan
@Anker Deutschland



@AnkerOfficial
@Anker_JP



@Anker
