

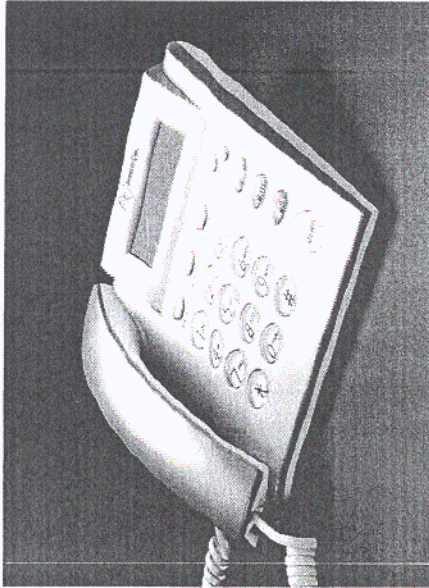

Anyuser IP Phone User Guide



COPYRIGHT NOTICE

AnyuserNet is a registered trademark of AnyuserNet Inc. Other referenced trademarks are trademarks (registered or otherwise) of the respective trademark owners. No part of this document may be reproduced, stored, or transmitted in any form by any means without the prior written permission of AnyuserNet Inc. Information furnished herein by AnyuserNet Inc., is believed to be accurate and reliable. The authors have used their best efforts in preparing this material. These efforts include the development, research, and testing of the theories and programs to determine their effectiveness, however, AnyuserNet assumes no liability for errors in this document, or for liability otherwise arising from the application or use of any such information or for any infringement of patents or other intellectual property rights owned by third parties, which may result from such application or use. The products, their specifications, and the information appearing in this document are subject to change without notice.

Printed AnyuserNet Inc.
© 2000–2001 by AnyuserNet Inc. All rights reserved.

FCC

This device complies with part 15 of the FCC Rules. Operation is subject to the following two conditions: (1)

This device may not cause harmful interference, and (2) this device must accept any

interference received, including interference that may cause undesired operation.

Caution : Any changes or modifications in construction of this device which are not expressly approved by the party responsible for compliance could void the user's authority to operate the equipment

Note : This equipment has been tested and found to comply with the limits for a Class B digital device,

pursuant to part 15 of the FCC Rules. These limits are designed to provide reasonable protection against harmful interference in a residential installation. This equipment generates, uses and can radiate radio

frequency energy and, if not installed and used in accordance with the instructions, may cause harmful

interference to radio communications. However, there is no guarantee that interference will not occur in a particular installation. If this equipment does cause harmful interference to radio or television reception,

which can be determined by turning the equipment off and on, the user is encouraged to try to correct the interference by one or more of the following measures:

- Reorient or relocate the receiving antenna.
- Increase the separation between the equipment and receiver.
- Connect the equipment into an outlet on a circuit different from that to which the receiver is connected.
- Consult the dealer or an experienced radio/TV technician for help.



Table of Contents

Welcome	4
Safety Information.....	5
Package Contents	6
Anyuser IP Phone Overview	7
Anyuser IP Phone Installation.....	8
Setting up the IP address for the network environment.....	9
Setting up the Gatekeeper address and Phone numbers.....	12
Using the MENU Option	
1. Phone Book (Registering)	14
2. Phone Book(Searching).....	16
3. Call History	17
4. System Setting (Voice)	18
5. System Setting (RRQ Interval).....	19
6. System Setting (Password)	20
7. System Setting (PIN Number)	20
8. Information (Network)	21
9. Information (Version)	22
Anyuser IP Phone Operation	
1. IP Phone to IP Phone	23
2. IP Phone to PSTN	23
3. PSTN to PSTN	23
4. Volume Control	24
5. Ringer Volume Control	24
6. Redial the last number dialed	24
Troubleshooting Guide	25

Welcome

Introduction

Anyuser IP Phone is an advanced IP phone system that allows users to achieve perfect voice communication over the IP network. Although the Anyuser IP Phone is an IP phone that supports perfect data and voice communication over the data communication network, it functions independently of a PC. It also supports all the conveniences and functions of digital key systems' phone sets.

The Anyuser IP Phone has perfectly integrated all the merits and features of both the analog and the IP phone features over the data communication system.

As voice signals are automatically compressed using audio CODEC of G.711, G.723.1, G.729, etc., they can be transmitted over a low bandwidth without interfering with other data signals

Furthermore, to provide consistent superior voice quality over varying IP network conditions, it is equipped with such advanced Quality of Service (QoS) technologies as CODEC negotiation, enhanced jittering technology, lost packet reconstruction, echo cancellation, and packet delay recovery.

Therefore, it supports reliable voice communication over congested IP network.



Safety Information

The most careful attention has been devoted to quality standards in the manufacture of your new IP phone. Safety is a major factor in the design of every set. But, safety is your responsibility too.

- Use only the adaptor provided.
(Output: DC 7.5V/ 1.2A, (-)---(0---(+))
- To reduce the risk of electric shock, do not disassemble this product. There are no user serviceable parts. Opening or removing covers may expose you to hazardous voltages. Incorrect reassembly can cause electric shock when this product is subsequently used
- Never push objects of any kind into the equipment through housing slots since they may touch hazardous voltage points or short out parts that could result in a risk of electric shock. Never spill liquid of any kind on the product. If liquid is spilled, however, refer servicing to proper service personnel.
- Use only Unshielded Twisted Pair (UTP) Category 5 Ethernet cable to RJ-45 port of the Anyuser IP Phone.



Package Contents

Make sure the following contents are included in the Anyuser IP Phone package.

- One Anyuser IP Phone
- One Curled wire
- One DC 7.5V 12A Adapter
- One User Guide

Anyuser IP Phone

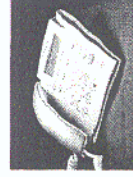

Curled wire



Adapter



User Guide





Anyuser IP Phone

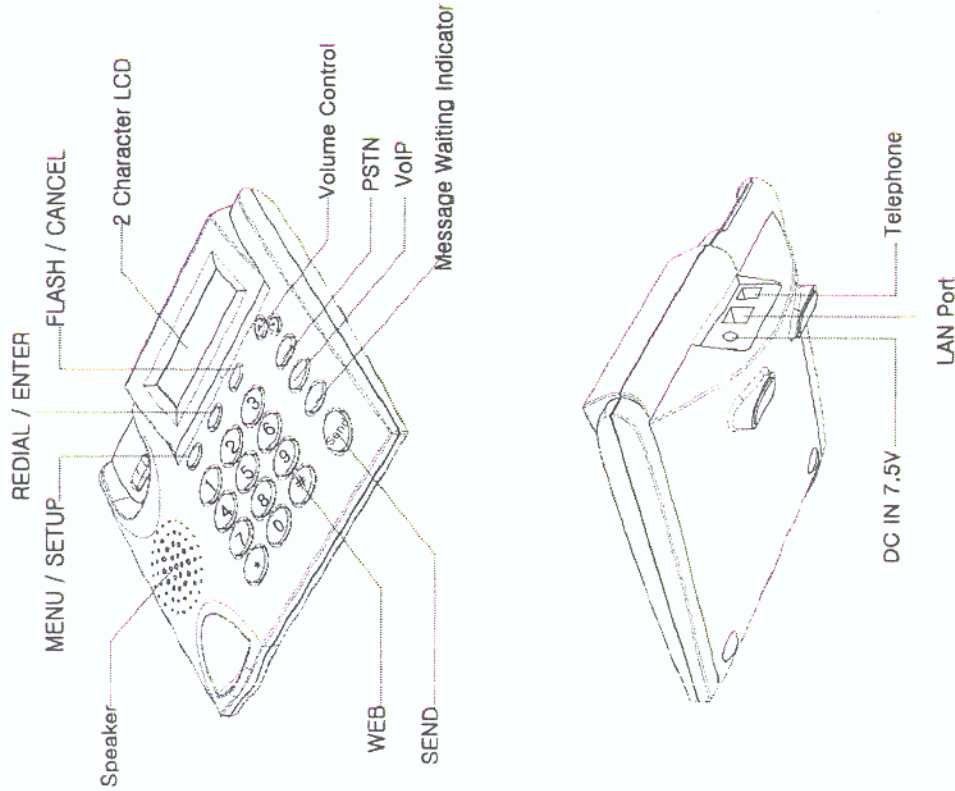

Anyuser IP Phone Installation

Installing the Anyuser IP Phone

1. Unpack all contents of the Anyuser IP Phone package.
2. Connect the activated Local Area Network (LAN) cable to the LAN port at the back of the Anyuser IP Phone as shown in the following figure.

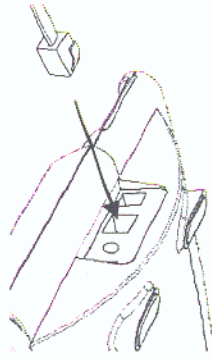

3. Connect the Power Adapter to the AC Outlet and the DC-IN-7.5V at the back of the Anyuser IP Phone.

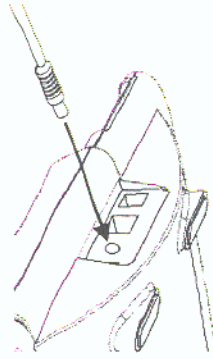

4. Connect the PSTN line to the telephone port at the back of the Anyuser IP Phone.

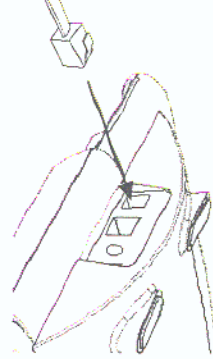



Setting up the IP address for the network environment

Because the Anyuser IP Phone uses an IP address to communicate, an IP address and network setup information such as Subnet mask, Default Gateway and Domain Name Server (DNS) must be assigned

1. Invoking Boot Rom:
Remove and reconnect the adapter jack to the back of the Anyuser IP Phone and immediately press the SETUP button until the Boot Rom Menu comes up.
The Boot Rom Menu appears on the LCD screen

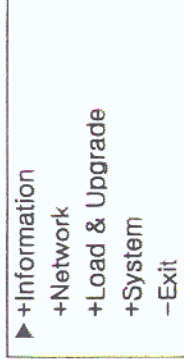

2. Select **Network** from the Menu, then press ENTER

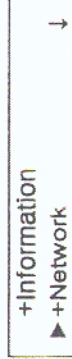

3. Select DHCP.

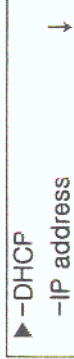

4. Select **ENTER**. (Do this if your network supports DHCP)
If you have no idea about DHCP, ask your network Admin.
Or if your network does not support DHCP, select CANCEL



5. In the DHCP Configuration field, verify it is enabled or disabled and press ENTER.



6. If you selected DHCP Enabled, press CANCEL button to move the upper menu
Or if you selected DHCP Disabled, select **-IP address** to input the proper address

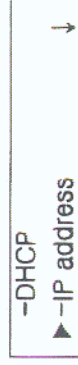

7. Input the IP address manually and then press ENTER

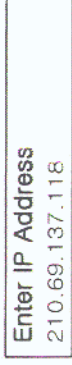

8. Select [CANCEL]



9. Select **-Subnet Mask**, then input the Subnet Mask manually and then press ENTER.



10. Select **-Default Gateway**, then input the Default Gateway manually and then press ENTER





11. Select **+DNS** and select **-1st DNS**, then input the DNS and then press **ENTER**.

Enter DNS 0
164.124.101.2

12. If there are more DNSs, input like above.
13. Press **CANCEL** button to move the main menu and then select **-Exit** to exit Bootrom Menu.

+System
▶ **-EXIT**



Setting up the Gatekeeper address and Phone numbers

1. Press the **MENU** button and scroll down to **[Systems Setting]**, then press **ENTER** button.

[Call History]
▶ **[System Setting]**

2. Select **Address** from the Menu, then press **ENTER**.

▶ **1> Address**
▶ **2> Voice**

3. Select **[1] GK address** from the Menu, then press **ENTER**.

▶ **[1] GK Address**
▶ **[2] VOIP Number**

4. Press **▶** button to indicate the address, then press **ENTER**.

MANUAL
▶ **0.0.0.0**

5. Enter proper GK IP address, then press **ENTER**.

GK IP Address
211.34.117.111

6. Select **[2] VOIP Number**, then press **ENTER**.

[1] GK Address
▶ **[2] VOIP Number**

7. Press **▶** button to indicate the number, then press **ENTER**.

MANUAL
▶ **1234567**



8. Enter proper VoIP Phone number, then press ENTER.

Terminal LINE Number
5170310

9. Select [3] PSTN Number, then press ENTER.

[2] VOIP Number
▶ [3] PSTN Number

10. Press ▼ button to indicate the number, then press ENTER.

MANUAL
▶ 1234567

11. Enter proper PSTN Phone number, then press ENTER.

Terminal LINE Number
5170934

12. Press CANCEL button to move the main menu and then select –Exit to exit.



Using the MENU Option

1. Phone Book (Registering)

1. Press the MENU button and select [Phone Book] then press ENTER button.

▶ [Phone Book]
[Call History]

2. Select Register from the Menu, then press ENTER.

▶ 1> Register
2> Search

3. Select [1] Index(0-99) from the Menu, then press ENTER.

▶ [1] Index(0-99)
[2] Enter Name

4. Enter index number that you want to memory, then press ENTER.

▶ Enter Index
0

5. Select [2] Enter Name from the Menu, then press ENTER.

[1] Index(0-99)
▶ [2] Enter Name

6. Enter Name that you want to memory, then press ENTER.

▶ Enter Name
smith

7. Select [3] Number(VoIP) from the Menu, then press ENTER.

[2] Enter Name
▶ [3] Number(VoIP)